

# 配置幀中繼和對其進行故障排除的綜合指南

## 目錄

[簡介](#)

[開始之前](#)

[慣例](#)

[必要條件](#)

[採用元件](#)

[背景理論](#)

[配置基本幀中繼](#)

[網路圖表](#)

[組態](#)

[debug和show命令](#)

[配置集中星型幀中繼](#)

[網路圖表](#)

[組態](#)

[show命令](#)

[從輻條連線到輻條](#)

[組態](#)

[show命令](#)

[配置幀中繼子介面](#)

[點對點子介面](#)

[show命令](#)

[中心輻射型子介面](#)

[show命令](#)

[為多點子介面配置動態和靜態對映](#)

[網路圖表](#)

[組態](#)

[debug和show命令](#)

[配置IP未編號幀中繼](#)

[網路圖表](#)

[組態](#)

[show命令](#)

[配置幀中繼備份](#)

[使用ISDN的訊框中繼備份](#)

[每個DCLI備份的配置](#)

[使用撥號程式設定檔的中心輻射點](#)

[配置幀中繼交換](#)

[網路圖表](#)

[組態](#)

[show命令](#)

[配置幀中繼DLCI優先順序](#)

[實施注意事項](#)

[網路圖表](#)

[組態](#)

[debug和show命令](#)

[訊框中繼廣播佇列](#)

[流量調節](#)

[流量整形引數](#)

[通用流量調節](#)

[訊框中繼流量調節](#)

[常用的幀中繼命令](#)

[show frame-relay pvc](#)

[show frame-relay map](#)

[訊框中繼和橋接](#)

[訊框中繼和記憶體](#)

[訊框中繼疑難排解](#)

["Serial0關閉，線路協定關閉"](#)

["Serial0為up，線路協定為down"](#)

["Serial0為up，線路協定為up"](#)

[框架轉送特徵](#)

[IP水準分割檢查](#)

[在多點幀中繼上Ping您自己的IP地址](#)

[關鍵字broadcast](#)

[重新配置子介面](#)

[DLCI限制](#)

[IP/IPX/AT地址](#)

[RIP和IGRP](#)

[Keepalive](#)

[串列介面](#)

[OSPF和多點](#)

[來源](#)

[相關資訊](#)

## [簡介](#)

訊框中繼是業界標準的交換資料連結層通訊協定，可在相連裝置之間使用高階資料連結控制 (HDLC) 封裝處理多個虛擬電路。在許多情況下，幀中繼比X.25 (通常被認為是替換協定) 更有效。下圖說明了幀中繼幀(ANSI T1.618)。

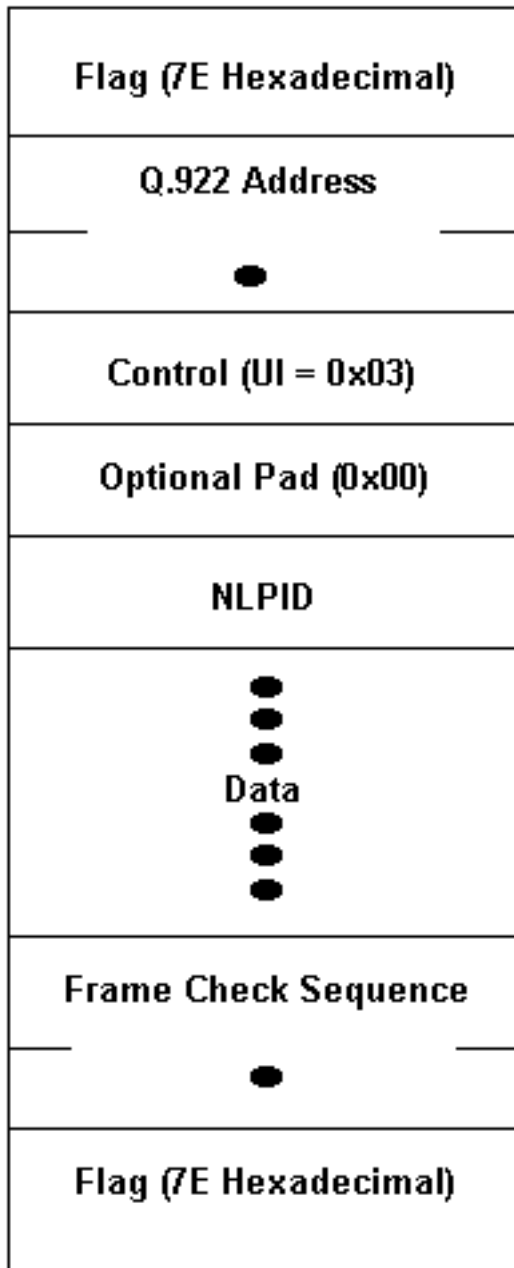
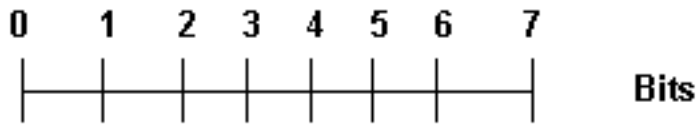

● = Octet

請注意，在上圖中，Q.922地址（如當前定義）是兩個八位組，並包含10位資料鏈路連線識別符號 (DLCI)。在某些網路中，Q.922地址可以選擇增加到三個或四個二進位制八位數。

「標誌」欄位用於分隔幀的開始和結束。前導的「flag」欄位後面是兩個位元組的地址資訊。這兩個位元組中的10位構成了實際電路ID（對於資料鏈路連線識別符號，稱為DLCI）。

10位DLCI值是幀中繼報頭的核心。標識複用到物理通道中的邏輯連線。在基本（即不通過本地管理介面[LMI]擴展）定址模式中，DLCI具有本地意義；也就是說，連線兩端的終端裝置可以使用不同的DLCI來引用同一連線。

# 開始之前

## 慣例

如需文件慣例的詳細資訊，請參閱[思科技術提示慣例](#)。

## 必要條件

有關本文檔中使用的術語的更多資訊和定義，請參閱[幀中繼術語表](#)。

## 採用元件

本文件所述內容不限於特定軟體和硬體版本。

本文中的資訊是根據特定實驗室環境內的裝置所建立。文中使用到的所有裝置皆從已清除（預設）的組態來啟動。如果您在即時網路中工作，請確保在使用任何命令之前瞭解其潛在影響。

## 背景理論

幀中繼最初被設想為通過ISDN介面使用的協定。1984年向國際電信聯盟電信標準化部門(ITU-T)（前國際電報電話諮詢委員會[CCITT]）提交了初步提案。有關幀中繼的工作也由美國ANSI認證的T1S1標準委員會進行。

1990年，Cisco Systems、StrataCom、Northern Telecom和Digital Equipment Corporation組成了一個聯盟，重點發展幀中繼技術，並加速引入可互操作的幀中繼產品。他們開發了一種符合T1S1和ITU-T中討論的基本幀中繼協定的規範，但擴展了該規範，使之具有為複雜的網際網路環境提供額外功能的功能。這些幀中繼擴展統稱為LMI。這是路由器中的「cisco」LMI，而不是「ansi」或「q933a」LMI。

幀中繼提供分組交換資料通訊功能，該功能可在使用者裝置（如路由器、網橋、主機）和網路裝置（如交換節點）之間的介面上使用。使用者裝置通常稱為資料終端裝置(DTE)，而介面到DTE的網路裝置通常稱為資料電路終端裝置(DCE)。提供幀中繼介面的網路可以是運營商提供的公共網路，也可以是服務於單個企業的私有裝置網路。

框架轉送的功能和格式與X.25有很大不同。特別是，幀中繼是一種更簡化的協定，有助於提高效能和效率。

作為使用者和網路裝置之間的介面，幀中繼提供了一種通過單個物理傳輸鏈路統計複用多個邏輯資料會話（稱為虛擬電路）的方法。這與只使用分時多工(TDM)技術來支援多個資料流的系統不同。幀中繼的統計複用提供了更靈活、更高效的可用頻寬使用。可以不使用TDM技術或在TDM系統提供的通道之上使用。

幀中繼的另一個重要特徵是它利用了廣域網(WAN)傳輸技術的最新進展。早期的WAN協定（如X.25）是在模擬傳輸系統和銅介質占主導地位時開發的。這些鏈路的可靠性遠不如目前可用的光纖介質/數位傳輸鏈路。在諸如此類的鏈路上，鏈路層協定可以放棄耗時的糾錯演算法，讓這些演算法留在更高的協定層執行。因此，可以在不犧牲資料完整性的情況下提高效能和效率。設計幀中繼時考慮到了這種方法。它包含用於檢測損壞位元（以便資料可被丟棄）的循環冗餘檢查(CRC)演算法，但它不包括任何用於糾正不良資料的協定機制（例如，通過以這種協定級別重新傳輸資料）。

幀中繼和X.25之間的另一個區別是幀中繼中缺少顯式的、按虛電路的流量控制。現在許多上層協定

正在有效地執行它們自己的流量控制演算法，所以在鏈路層對這種功能的需求減少了。因此，幀中繼不包括與更高層相同的顯式流控制過程。相反，提供非常簡單的擁塞通知機制以允許網路通知使用者裝置網路資源接近擁塞狀態。此通知可以提醒高層協定可能需要流量控制。

## 配置基本幀中繼

永久虛擬電路(PVC)的兩端與本地幀中繼交換機建立可靠連線後，就應該開始規劃幀中繼配置。在此第一個範例中，Spicey上的本地管理介面(LMI)型別預設為「cisco」LMI。預設情況下，介面是「多點」介面，因此frame-relay inverse-arp處於開啟狀態（對於點對點，沒有逆向ARP）。幀中繼封裝預設禁用IP水準分割檢查，因此路由更新傳入和傳出同一介面。路由器通過LMI更新從幀中繼交換機獲取需要使用的資料鏈路連線識別符號(DLCI)。然後，路由器為遠端IP地址建立逆向ARP，並建立本地DLCI及其關聯的遠端IP地址的對映。

## 網路圖表



## 組態

- [斯皮塞](#)
- [普拉西](#)

### 斯皮塞

```
Spicey#show running-config
Building configuration...

Current configuration : 1705 bytes
!
version 12.1
service timestamps debug datetime msec
service timestamps log datetime msec
no service password-encryption
!
hostname Spicey
!
!
!
interface Ethernet0
 ip address 124.124.124.1 255.255.255.0
!
interface Serial0
 ip address 3.1.3.1 255.255.255.0
 encapsulation frame-relay
 frame-relay interface-dlci 140
!
!
router rip
```

```
network 3.0.0.0
network 124.0.0.0
!
line con 0
  exec-timeout 0 0
  transport input none
line aux 0
line vty 0 4
  login
!
end
```

## 普拉西

```
Prasit#show running-config
Building configuration...
Current configuration : 1499 bytes
!
version 12.1
service timestamps debug datetime msec
service timestamps log datetime msec
no service password-encryption
!
hostname Prasit
!
!
!
interface Ethernet0
  ip address 123.123.123.1 255.255.255.0
!
!
interface Serial1
  ip address 3.1.3.2 255.255.255.0
  encapsulation frame-relay
  frame-relay interface-dlci 150
!
!
router rip
  network 3.0.0.0
  network 123.0.0.0
!
!
!
line con 0
  exec-timeout 0 0
  transport input none
line aux 0
line vty 0 4
  login
!
end
```

## [debug和show命令](#)

發出 [debug](#) 指令之前，請先參閱有關 Debug 指令的重要資訊。

- **show frame-relay map**
- **show frame-relay pvc**
- **show frame-relay lmi**
- **ping <device name>**

## • show ip route

### 斯皮塞

```
Spicey#show frame-relay map
```

```
Serial0 (up): ip 3.1.3.2 dlci 140(0x8C,0x20C0), dynamic,  
broadcast,, status defined, active
```

```
Spicey#show frame-relay pvc
```

```
PVC Statistics for interface Serial0 (Frame Relay DTE)
```

	Active	Inactive	Deleted	Static
Local	1	0	0	0
Switched	0	0	0	0
Unused	0	0	0	0

```
DLCI = 140, DLCI USAGE = LOCAL, PVC STATUS = ACTIVE, INTERFACE = Serial0
```

```
input pkts 83          output pkts 87          in bytes 8144  
out bytes 8408        dropped pkts 0          in FECN pkts0  
in BECN pkts 0        out FECN pkts 0        out BECN pkts0  
in DE pkts 0          out DE pkts 0  
out bcast pkts 41     out bcast bytes 3652  
pvc create time 01:31:50, last time pvc status changed 01:28:28
```

```
Spicey#show frame-relay lmi
```

```
LMI Statistics for interface Serial0 (Frame Relay DTE) LMI TYPE = CISCO
```

```
Invalid Unnumbered info 0          Invalid Prot Disc 0  
Invalid dummy Call Ref 0          Invalid Msg Type 0  
Invalid Status Message 0          Invalid Lock Shift 0  
Invalid Information ID 0          Invalid Report IE Len 0  
Invalid Report Request 0          Invalid Keep IE Len 0  
Num Status Enq. Sent 550          Num Status msgs Rcvd 552  
Num Update Status Rcvd 0          Num Status Timeouts 0
```

```
Spicey#ping 123.123.123.1
```

```
Type escape sequence to abort.
```

```
Sending 5, 100-byte ICMP Echos to 123.123.123.1, timeout is 2 seconds:
```

```
!!!!
```

```
Success rate is 100 percent (5/5), round-trip min/avg/max = 36/36/40 ms
```

```
Spicey#show ip route
```

```
Codes: C - connected, S - static, I - IGRP, R - RIP, M - mobile, B - BGP
```

```
D - EIGRP, EX - EIGRP external, O - OSPF, IA - OSPF inter area
```

```
N1 - OSPF NSSA external type 1, N2 - OSPF NSSA external type 2
```

```
E1 - OSPF external type 1, E2 - OSPF external type 2, E - EGP
```

```
i - IS-IS, L1 - IS-IS level-1, L2 - IS-IS level-2, ia - IS-IS
```

```
inter area
```

```
* - candidate default, U - per-user static route, o - ODR
```

```
P - periodic downloaded static route
```

```
Gateway of last resort is not set
```

```
3.0.0.0/24 is subnetted, 1 subnets
```

```
C 3.1.3.0 is directly connected, Serial0
```

```
124.0.0.0/24 is subnetted, 1 subnets
```

```
C 124.124.124.0 is directly connected, Ethernet0
```

```
R 123.0.0.0/8 [120/1] via 3.1.3.2, 00:00:08, Serial0
```

### 普拉西

```
Prasit#show frame-relay map
```

```
Serial1 (up): ip 3.1.3.1 dlci 150(0x96,0x2460), dynamic,  
broadcast,, status defined, active
```

```
Prasit#show frame-relay pvc
```

PVC Statistics for interface Serial1 (Frame Relay DTE)

	Active	Inactive	Deleted	Static
Local	1	0	0	0
Switched	0	0	0	0
Unused	0	0	0	0

DLCI = 150, DLCI USAGE = LOCAL, PVC STATUS = ACTIVE, INTERFACE = Serial1

input pkts 87	output pkts 83	in bytes 8408
out bytes 8144	dropped pkts 0	in FECN pkts 0
in BECN pkts 0	out FECN pkts 0	out BECN pkts 0
in DE pkts 0	out DE pkts 0	
out bcast pkts 38	out bcast bytes 3464	

pvc create time 01:34:29, last time pvc status changed 01:28:05

Prasit#**show frame-relay lmi**

LMI Statistics for interface Serial1 (Frame Relay DTE) LMI TYPE = CISCO

Invalid Unnumbered info 0	Invalid Prot Disc 0
Invalid dummy Call Ref 0	Invalid Msg Type 0
Invalid Status Message 0	Invalid Lock Shift 0
Invalid Information ID 0	Invalid Report IE Len 0
Invalid Report Request 0	Invalid Keep IE Len 0
Num Status Enq. Sent 569	Num Status msgs Rcvd 570
Num Update Status Rcvd 0	Num Status Timeouts 0

Prasit#**ping 124.124.124.1**

Type escape sequence to abort.

Sending 5, 100-byte ICMP Echos to 124.124.124.1, timeout is 2 seconds:

!!!!

Success rate is 100 percent (5/5), round-trip min/avg/max = 36/36/36 ms

Prasit#**show ip route**

Codes: C - connected, S - static, I - IGRP, R - RIP, M - mobile, B - BGP

D - EIGRP, EX - EIGRP external, O - OSPF, IA - OSPF inter area

N1 - OSPF NSSA external type 1, N2 - OSPF NSSA external type 2

E1 - OSPF external type 1, E2 - OSPF external type 2, E - EGP

i - IS-IS, L1 - IS-IS level-1, L2 - IS-IS level-2, ia - IS-IS

inter area

\* - candidate default, U - per-user static route, o - ODR

P - periodic downloaded static route

Gateway of last resort is not set

3.0.0.0/24 is subnetted, 1 subnets

C 3.1.3.0 is directly connected, Serial1

R 124.0.0.0/8 [120/1] via 3.1.3.1, 00:00:19, Serial1

123.0.0.0/24 is subnetted, 1 subnets

C 123.123.123.0 is directly connected, Ethernet0

## [配置集中星型幀中繼](#)

在本示例中，路由器從幀中繼交換機獲知它使用的資料鏈路連線識別符號(DLCI)，並將其分配給主介面。然後路由器將為遠端IP地址逆向ARP。

**注意：**除非在每一端都明確新增幀中繼對映，否則您將無法從Aton對Prasit的串列IP地址執行ping操作。如果路由配置正確，源自LAN的流量應該不會出現問題。如果在擴展ping中使用乙太網IP地址作為源地址，您將能夠ping。

啟用**frame-relay inverse-arp**後，**broadcast** IP流量將預設通過連線傳出。

## [網路圖表](#)



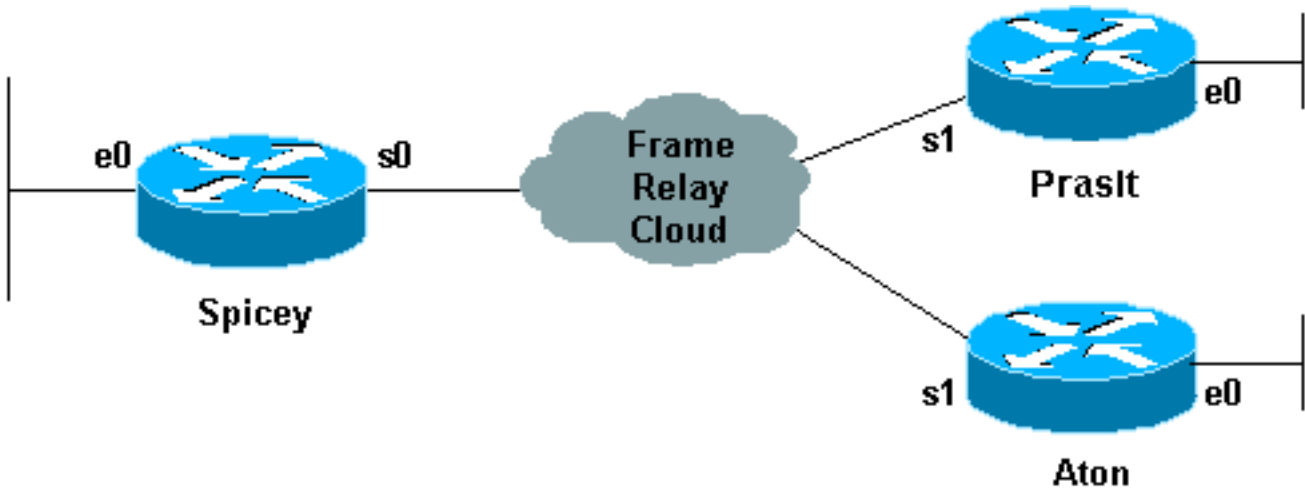

## 組態

- [斯皮塞](#)
- [普拉西](#)
- [阿頓](#)

### 斯皮塞

```

spicey#show running-config
Building configuration...
!
version 12.1
service timestamps debug datetime msec
service timestamps log datetime msec
no service password-encryption
!
hostname spicey
!
!
!
!
interface Ethernet0
 ip address 124.124.124.1 255.255.255.0
!
interface Serial0
 ip address 3.1.3.1 255.255.255.0
 encapsulation frame-relay
 frame-relay interface-dlci 130
 frame-relay interface-dlci 140
!
!
router rip
 network 3.0.0.0
 network 124.0.0.0
!
line con 0
 exec-timeout 0 0
 transport input none
line aux 0
line vty 0 4
 login
!
end

```

## 普拉西

```
prasit#show running-config
Building configuration...

Current configuration : 1499 bytes
!
version 12.1
service timestamps debug datetime msec
service timestamps log datetime msec
no service password-encryption
!
hostname prasit
!
!
!
interface Ethernet0
 ip address 123.123.123.1 255.255.255.0
!
interface Serial1
 ip address 3.1.3.2 255.255.255.0
 encapsulation frame-relay
 frame-relay interface-dlci 150
!
!
router rip
 network 3.0.0.0
 network 123.0.0.0
!
!
line con 0
 exec-timeout 0 0
 transport input none
line aux 0
line vty 0 4
 login
!
end
```

## 阿頓

```
aton#show running-config
Building configuration...
Current configuration:
!
version 12.0
service timestamps debug uptime
service timestamps log uptime
no service password-encryption
!
hostname aton
!
!
!
interface Ethernet0
 ip address 122.122.122.1 255.255.255.0
!
interface Serial1
 ip address 3.1.3.3 255.255.255.0
 encapsulation frame-relay
 frame-relay interface-dlci 160
!
!
router rip
 network 3.0.0.0
```

```

network 122.0.0.0
!
!
line con 0
  exec-timeout 0 0
  transport input none
line aux 0
line vty 0 4
  login
!
end

```

## show命令

- show frame-relay map
- show frame-relay pvc
- ping <device name>

## 斯皮塞

spicey#**show frame-relay map**

```

Serial0 (up): ip 3.1.3.2 dlci 140(0x8C,0x20C0), dynamic,
              broadcast,, status defined, active
Serial0 (up): ip 3.1.3.3 dlci 130(0x82,0x2020), dynamic,
              broadcast,, status defined, active

```

spicey#**show frame-relay pvc**

```

PVC Statistics for interface Serial0 (Frame Relay DTE)

```

	Active	Inactive	Deleted	Static
Local	2	0	0	0
Switched	0	0	0	0
Unused	0	0	0	0

```

DLCI = 130, DLCI USAGE = LOCAL, PVC STATUS = ACTIVE, INTERFACE = Serial0
  input pkts 32          output pkts 40          in bytes 3370
  out bytes 3928        dropped pkts 0          in FECN pkts 0
  in BECN pkts 0        out FECN pkts 0        out BECN pkts 0
  in DE pkts 0          out DE pkts 0
  out bcast pkts 30     out bcast bytes 2888
  pvc create time 00:15:46, last time pvc status changed 00:10:42

```

```

DLCI = 140, DLCI USAGE = LOCAL, PVC STATUS = ACTIVE, INTERFACE = Serial0

  input pkts 282        output pkts 291        in bytes 25070
  out bytes 27876       dropped pkts 0          in FECN pkts 0
  in BECN pkts 0        out FECN pkts 0        out BECN pkts 0
  in DE pkts 0          out DE pkts 0
  out bcast pkts 223    out bcast bytes 20884
  pvc create time 02:28:36, last time pvc status changed 02:25:14

```

spicey#

spicey#**ping 3.1.3.2**

Type escape sequence to abort.

Sending 5, 100-byte ICMP Echos to 3.1.3.2, timeout is 2 seconds:

!!!!!

Success rate is 100 percent (5/5), round-trip min/avg/max = 32/35/36 ms

spicey#**ping 3.1.3.3**

Type escape sequence to abort.

Sending 5, 100-byte ICMP Echos to 3.1.3.3, timeout is 2 seconds:

!!!!!

Success rate is 100 percent (5/5), round-trip min/avg/max = 32/35/36 ms

## 普拉西

prasit#**show frame-relay map**

Serial1 (up): ip 3.1.3.1 dlci 150(0x96,0x2460), dynamic,  
broadcast,, status defined, active

prasit#**show frame-relay pvc**

PVC Statistics for interface Serial1 (Frame Relay DTE)

	Active	Inactive	Deleted	Static
Local	1	0	0	0
Switched	0	0	0	0
Unused	0	0	0	0

DLCI = 150, DLCI USAGE = LOCAL, PVC STATUS = ACTIVE, INTERFACE = Serial1

input pkts 311	output pkts 233	in bytes 28562
out bytes 22648	dropped pkts 0	in FECN pkts 0
in BECN pkts 0	out FECN pkts 0	out BECN pkts 0
in DE pkts 0	out DE pkts 0	
out bcast pkts 162	out bcast bytes 15748	

pvc create time 02:31:39, last time pvc status changed 02:25:14

prasit#**ping 3.1.3.1**

Type escape sequence to abort.

Sending 5, 100-byte ICMP Echos to 3.1.3.1, timeout is 2 seconds:

!!!!

Success rate is 100 percent (5/5), round-trip min/avg/max = 36/36/36 ms

prasit#**ping 3.1.3.3**

Type escape sequence to abort.

Sending 5, 100-byte ICMP Echos to 3.1.3.3, timeout is 2 seconds:

.....

Success rate is 0 percent (0/5)

## 阿頓

aton#**show frame-relay map**

Serial1 (up): ip 3.1.3.1 dlci 160(0xA0,0x2800), dynamic,  
broadcast,, status defined, active

aton#**show frame-relay pvc**

PVC Statistics for interface Serial1 (Frame Relay DTE)

	Active	Inactive	Deleted	Static
Local	1	0	0	0
Switched	0	0	0	0
Unused	0	0	0	0

DLCI = 160, DLCI USAGE = LOCAL, PVC STATUS = ACTIVE, INTERFACE = Serial1

input pkts 35	output pkts 32	in bytes 3758
out bytes 3366	dropped pkts 0	in FECN pkts 0
in BECN pkts 0	out FECN pkts 0	out BECN pkts 0
in DE pkts 0	out DE pkts 0	
out bcast pkts 27	out bcast bytes 2846	

pvc create time 00:10:53, last time pvc status changed 00:10:53

aton#**ping 3.1.3.1**

Type escape sequence to abort.

```
Sending 5, 100-byte ICMP Echos to 3.1.3.1, timeout is 2 seconds:
!!!!
Success rate is 100 percent (5/5), round-trip min/avg/max = 32/35/36 ms
```

```
aton#ping 3.1.3.2
```

```
Type escape sequence to abort.
Sending 5, 100-byte ICMP Echos to 3.1.3.2, timeout is 2 seconds:
.....
Success rate is 0 percent (0/5)
```

## 從輻條連線到輻條

無法使用多點介面在集中星型配置中從一個星型對另一個星型執行ping操作，因為沒有其他星型的IP地址對映。只有集線器的位址會透過反向位址解析通訊協定(IARP)得知。如果使用frame-relay map命令為遠端分支的IP地址配置靜態對映以使用本地資料鏈路連線識別符號(DLCI)，則可以ping其它分支的地址。

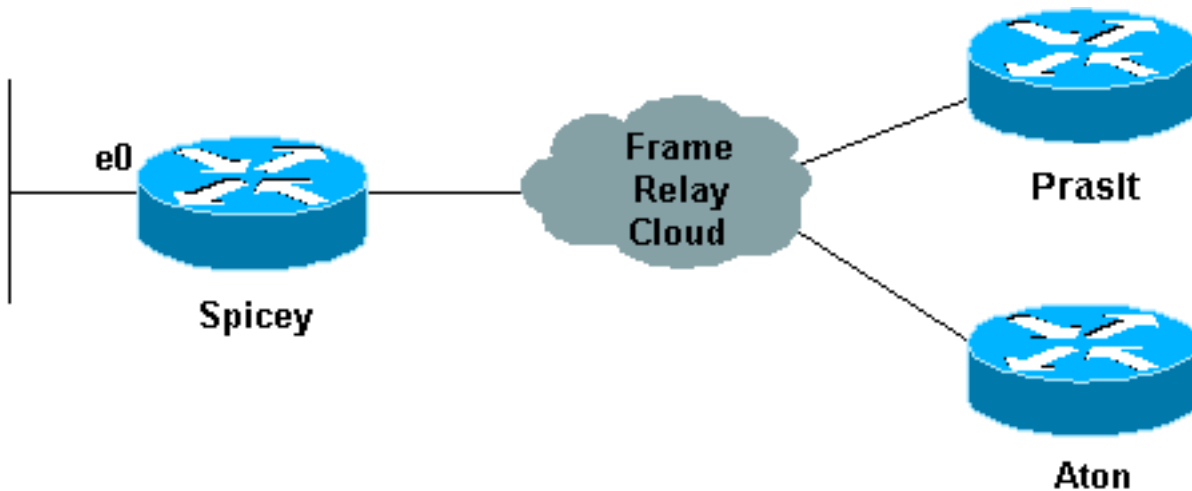

## 組態

### 普拉西

```
prasit#show running-config
interface Ethernet0
 ip address 123.123.123.1 255.255.255.0
!
interface Serial
 ip address 3.1.3.2 255.255.255.0
 encapsulation frame-relay
 frame-relay map ip 3.1.3.3 150
 frame-relay interface-dlci 150
```

## show命令

- show frame-relay map
- ping <device name>
- show running-config

## 普拉西

```
prasit#show frame-relay map
Serial1 (up): ip 3.1.3.1 dlci 150(0x96,0x2460), dynamic,
                broadcast,, status defined, active
Serial1 (up): ip 3.1.3.3 dlci 150(0x96,0x2460), static,
                CISCO, status defined, active

prasit#ping 3.1.3.3
Type escape sequence to abort.
Sending 5, 100-byte ICMP Echos to 3.1.3.3, timeout is 2 seconds:
!!!!
Success rate is 100 percent (5/5), round-trip min/avg/max = 68/70/80 ms

prasit#ping 122.122.122.1
Type escape sequence to abort.
Sending 5, 100-byte ICMP Echos to 122.122.122.1, timeout is 2 seconds:
!!!!
Success rate is 100 percent (5/5), round-trip min/avg/max = 64/67/76 ms
```

## 阿頓

```
aton#show running-config
interface Ethernet0
ip address 122.122.122.1 255.255.255.0
!
interface Serial1
ip address 3.1.3.3 255.255.255.0
no ip directed-broadcast
encapsulation frame-relay
frame-relay map ip 3.1.3.2 160
frame-relay interface-dlci 160

aton#show frame-relay map
Serial1 (up): ip 3.1.3.1 dlci 160(0xA0,0x2800), dynamic,
                broadcast,, status defined, active
Serial1 (up): ip 3.1.3.2 dlci 160(0xA0,0x2800), static,
                CISCO, status defined, active

aton#ping 3.1.3.2
Type escape sequence to abort
Sending 5, 100-byte ICMP Echos to 3.1.3.2, timeout is 2 seconds:
!!!!
Success rate is 100 percent (5/5), round-trip min/avg/max = 68/68/68 ms

aton#ping 123.123.123.1
Type escape sequence to abort.
Sending 5, 100-byte ICMP Echos to 123.123.123.1, timeout is 2 seconds:
!!!!
Success rate is 100 percent (5/5), round-trip min/avg/max = 64/67/80 ms
```

## 配置幀中繼子介面

幀中繼子介面提供了一種支援部分網狀幀中繼網路的機制。大多數協定假定邏輯網路上的可傳遞性；也就是說，如果站點A能夠與站點B通話，而站點B能夠與站點C通話，則站點A應該能夠與站點C直接通話。在LAN上為傳遞性，但在幀中繼網路上為傳遞性，除非A直接連線到C。

此外，某些協定（如AppleTalk和透明橋接）在部分網狀網路中無法得到支援，因為它們需要「水準分割」，在這種分割中，一個介面上接收的資料包不能從同一介面傳送出去，即使資料包是在不同的虛電路上接收和傳送的。

配置幀中繼子介面可確保將單個物理介面視為多個虛擬介面。此功能使我們能夠克服水準分割規則。現在，一個虛擬介面上收到的資料包可以從另一個虛擬介面轉發出去，即使這些資料包是在同一個物理介面上配置的。

子介面通過將部分網狀幀中繼網路細分為多個較小的全網狀（或點對點）子網，解決了幀中繼網路的侷限性。每個子網都分配有自己的網路號，對協定而言，它就像通過單獨的介面可到達一樣。（請注意，點對點子介面可以不進行編號以用於IP，從而減少可能產生的編址負擔）。

## 點對點子介面

### 網路圖表



### 組態

- [斯皮塞](#)
- [普拉西](#)

#### 斯皮塞

```
Spicey#show running-config
Building configuration...

Current configuration : 1338 bytes
!
version 12.1
service timestamps debug datetime msec
service timestamps log datetime msec
no service password-encryption
!
hostname Spicey
!
enable password ww
!
!
!
!
interface Ethernet0
 ip address 124.124.124.1 255.255.255.0
!
interface Serial0
 no ip address
 encapsulation frame-relay
!
interface Serial0.1 point-to-point
 ip address 3.1.3.1 255.255.255.0
 frame-relay interface-dlci 140
!
```

```
!  
router igrp 2  
  network 3.0.0.0  
  network 124.0.0.0  
!  
!  
line con 0  
  exec-timeout 0 0  
  transport input none  
line aux 0  
line vty 0 4  
  login  
!  
end
```

## 普拉西

```
Prasit#show running-config  
Building configuration...  
  
Current configuration : 1234 bytes  
!  
version 12.1  
service timestamps debug datetime msec  
service timestamps log datetime msec  
no service password-encryption  
!  
hostname Prasit  
!  
!  
!  
interface Ethernet0  
  ip address 123.123.123.1 255.255.255.0  
!  
  interface Serial1  
  no ip address  
  encapsulation frame-relay  
!  
  interface Serial1.1 point-to-point  
  ip address 3.1.3.2 255.255.255.0  
  frame-relay interface-dlci 150  
!  
router igrp 2  
  network 3.0.0.0  
  network 123.0.0.0  
!  
line con 0  
  exec-timeout 0 0  
  transport input none  
line aux 0  
line vty 0 4  
  login  
!  
end
```

## [show命令](#)

- show frame-relay map
- show frame-relay pvc

## [斯皮塞](#)



Spicey#**show frame-relay map**

Serial0.1 (up): point-to-point dlci, dlci 140(0x8C,0x20C0), broadcast  
status defined, active

Spicey#**show frame-relay pvc**

PVC Statistics for interface Serial0 (Frame Relay DTE)

	Active	Inactive	Deleted	Static
Local	1	0	0	0
Switched	0	0	0	0
Unused	0	0	0	0

DLCI = 140, DLCI USAGE = LOCAL, PVC STATUS = ACTIVE, INTERFACE = Serial0.1

```
input pkts 193          output pkts 175          in bytes 20450
out bytes 16340         dropped pkts 0          in FECN pkts 0
in BECN pkts 0         out FECN pkts 0        out BECN pkts 0
in DE pkts 0           out DE pkts 0
out bcast pkts 50      out bcast bytes 3786
pvc create time 01:11:27, last time pvc status changed 00:42:32
```

Spicey#**ping 123.123.123.1**

Type escape sequence to abort.

Sending 5, 100-byte ICMP Echos to 123.123.123.1, timeout is 2 seconds:

!!!!!

Success rate is 100 percent (5/5), round-trip min/avg/max = 36/36/36 ms

[普拉西](#)

Prasit#**show frame-relay map**

Serial1.1 (up): point-to-point dlci, dlci 150(0x96,0x2460), broadcast  
status defined, active

Prasit#**show frame-relay pvc**

PVC Statistics for interface Serial1 (Frame Relay DTE)

	Active	Inactive	Deleted	Static
Local	1	0	0	0
Switched	0	0	0	0
Unused	0	0	0	0

DLCI = 150, DLCI USAGE = LOCAL, PVC STATUS = ACTIVE, INTERFACE =  
Serial1.1

```
input pkts 74          output pkts 89          in bytes 7210
out bytes 10963        dropped pkts 0          in FECN pkts 0
in BECN pkts 0         out FECN pkts 0        out BECN pkts 0
in DE pkts 0           out DE pkts 0
out bcast pkts 24      out bcast bytes 4203
pvc create time 00:12:25, last time pvc status changed 00:12:25
```

Prasit#**ping 124.124.124.1**

Type escape sequence to abort.

Sending 5, 100-byte ICMP Echos to 124.124.124.1, timeout is 2 seconds:

!!!!!

Success rate is 100 percent (5/5), round-trip min/avg/max = 36/36/36 ms

[中心輻射型子介面](#)

以下集中星型示例配置顯示了兩個點對點子介面，並在一個遠端站點上使用動態地址解析。每個子介面都有一個單獨的協定地址和子網掩碼，**interface-dlci**命令將子介面與指定的資料鏈路連線識別

符號(DLCI)相關聯。每個點對點子介面的遠端目標地址不會解析，因為它們是點對點的，必須將流量傳送到另一端的對等裝置。遠端端(Aton)使用逆向ARP進行對映，主集線器相應地使用子介面的IP地址進行響應。之所以會出現這種情況，是因為多點介面的幀中繼逆向ARP預設處於開啟狀態。

## 網路圖表

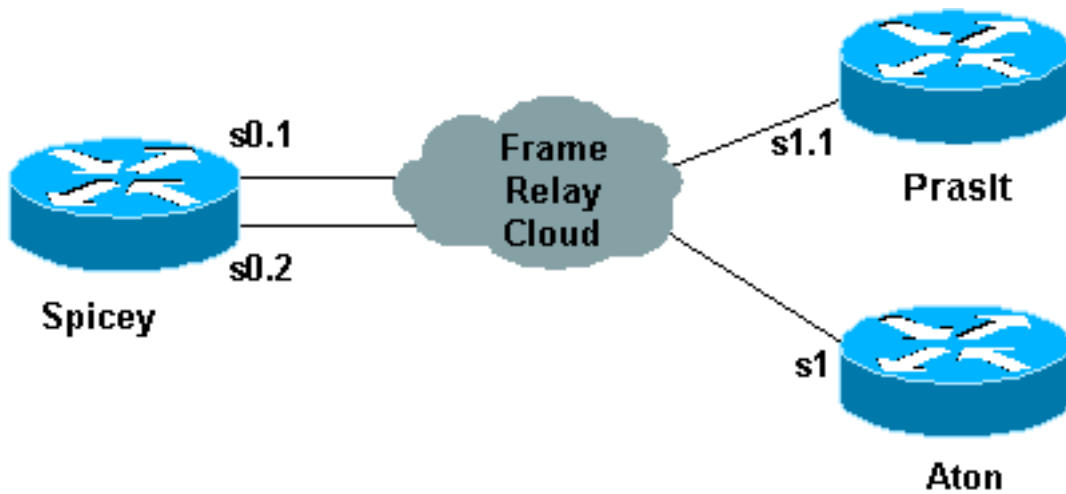

## 組態

- [斯皮塞](#)
- [普拉西](#)
- [阿頓](#)

### 斯皮塞

```
Spicey#show running-config
Building configuration...
!
version 12.1
service timestamps debug datetime msec
service timestamps log datetime msec
no service password-encryption
!
hostname Spicey
!
!
!
!
interface Ethernet0
 ip address 124.124.124.1 255.255.255.0
!
interface Serial0
 no ip address
 encapsulation frame-relay
!
interface Serial0.1 point-to-point
 ip address 4.0.1.1 255.255.255.0
 frame-relay interface-dlci 140
!
interface Serial0.2 point-to-point
 ip address 3.1.3.1 255.255.255.0
 frame-relay interface-dlci 130
```

```
!  
router igrp 2  
  network 3.0.0.0  
  network 4.0.0.0  
  network 124.0.0.0  
!  
line con 0  
  exec-timeout 0 0  
  transport input none  
line aux 0  
line vty 0 4  
  login  
!  
end
```

## 普拉西

```
Prasit#show running-config  
Building configuration...  
  
version 12.1  
service timestamps debug datetime msec  
service timestamps log datetime msec  
no service password-encryption  
!  
hostname Prasit  
!  
interface Ethernet0  
  ip address 123.123.123.1 255.255.255.0  
!  
interface Serial1  
  no ip address  
  encapsulation frame-relay  
!  
interface Serial1.1 point-to-point  
  ip address 4.0.1.2 255.255.255.0  
  frame-relay interface-dlci 150  
!  
router igrp 2  
  network 4.0.0.0  
  network 123.0.0.0  
!  
!  
line con 0  
  exec-timeout 0 0  
  transport input none  
line aux 0  
line vty 0 4  
  login  
!  
end
```

## 阿頓

```
Aton#show running-config  
Building configuration...  
  
Current configuration:  
!  
version 12.0  
service timestamps debug uptime  
service timestamps log uptime  
!  
end
```

```

hostname Aton
!
!
!
interface Ethernet0
 ip address 122.122.122.1 255.255.255.0
!
interface Serial1
 ip address 3.1.3.3 255.255.255.0
 encapsulation frame-relay
 frame-relay interface-dlci 160
!
router igrp 2
 network 3.0.0.0
 network 122.0.0.0
!
line con 0
 exec-timeout 0 0
 transport input none
line aux 0
line vty 0 4
 login
!
end

```

## show命令

- show frame-relay map
- show frame-relay pvc

## 斯皮塞

Spicey#**show frame-relay map**

```

Serial0.2 (up): point-to-point dlci, dlci 130(0x82,0x2020), broadcast
 status defined, active
Serial0.1 (up): point-to-point dlci, dlci 140(0x8C,0x20C0), broadcast
 status defined, active

```

Spicey#**show frame-relay pvc**

PVC Statistics for interface Serial0 (Frame Relay DTE)

	Active	Inactive	Deleted	Static
Local	2	0	0	0
Switched	0	0	0	0
Unused	0	0	0	0

DLCI = 130, DLCI USAGE = LOCAL, PVC STATUS = ACTIVE, INTERFACE = Serial0.2

```

input pkts 11          output pkts 22          in bytes 1080
out bytes 5128         dropped pkts 0          in FECN pkts 0
in BECN pkts 0        out FECN pkts 0        out BECN pkts 0
in DE pkts 0          out DE pkts 0
out bcast pkts 17     out bcast bytes 4608
pvc create time 00:06:36, last time pvc status changed 00:06:36

```

DLCI = 140, DLCI USAGE = LOCAL, PVC STATUS = ACTIVE, INTERFACE = Serial0.1

```

input pkts 33          output pkts 28          in bytes 3967
out bytes 5445         dropped pkts 0          in FECN pkts 0

```

```
in BECN pkts 0          out FECN pkts 0          out BECN pkts 0
in DE pkts 0            out DE pkts 0
out bcast pkts 17       out bcast bytes 4608
pvc create time 00:06:38, last time pvc status changed 00:06:38
```

Spicey#**ping 122.122.122.1**

Type escape sequence to abort.

Sending 5, 100-byte ICMP Echos to 122.122.122.1, timeout is 2 seconds:  
!!!!!

Success rate is 100 percent (5/5), round-trip min/avg/max = 32/35/36 ms

Spicey#**ping 123.123.123.1**

Type escape sequence to abort.

Sending 5, 100-byte ICMP Echos to 123.123.123.1, timeout is 2 seconds:  
!!!!!

Success rate is 100 percent (5/5), round-trip min/avg/max = 36/36/36 ms

[普拉西](#)

Prasit#**show frame-relay map**

Serial1.1 (up): point-to-point dlci, dlci 150(0x96,0x2460), broadcast  
status defined, active

Prasit#**show frame-relay pvc**

PVC Statistics for interface Serial1 (Frame Relay DTE)

	Active	Inactive	Deleted	Static
Local	1	0	0	0
Switched	0	0	0	0
Unused	0	0	0	0

DLCI = 150, DLCI USAGE = LOCAL, PVC STATUS = ACTIVE, INTERFACE =  
Serial1.1

```
input pkts 45          output pkts 48          in bytes 8632
out bytes 6661         dropped pkts 0          in FECN pkts 0
in BECN pkts 0        out FECN pkts 0        out BECN pkts 0
in DE pkts 0          out DE pkts 0
out bcast pkts 31     out bcast bytes 5573
pvc create time 00:12:16, last time pvc status changed 00:06:23
```

Prasit#**ping 124.124.124.1**

Type escape sequence to abort.

Sending 5, 100-byte ICMP Echos to 124.124.124.1, timeout is 2 seconds:  
!!!!!

Success rate is 100 percent (5/5), round-trip min/avg/max = 36/36/36 ms

[阿頓](#)

Aton#**show frame-relay map**

Serial1 (up): ip 3.1.3.1 dlci 160(0xA0,0x2800), dynamic,  
broadcast,, status defined, active

Aton#**show frame-relay pvc**

PVC Statistics for interface Serial1 (Frame Relay DTE)

	Active	Inactive	Deleted	Static
Local	1	0	0	0
Switched	0	0	0	0
Unused	0	0	0	0

DLCI = 160, DLCI USAGE = LOCAL, PVC STATUS = ACTIVE, INTERFACE = Serial1

```
input pkts 699          output pkts 634          in bytes 81290
out bytes 67008        dropped pkts 0          in FECN pkts 0
in BECN pkts 0        out FECN pkts 0        out BECN pkts 0
in DE pkts 0          out DE pkts 0
out bcast pkts 528    out bcast bytes 56074
pvc create time 05:46:14, last time pvc status changed 00:05:57
```

Aton#ping 124.124.124.1

Type escape sequence to abort.

Sending 5, 100-byte ICMP Echos to 124.124.124.1, timeout is 2 seconds:

!!!!!

Success rate is 100 percent (5/5), round-trip min/avg/max = 36/36/36 ms

## 為多點子介面配置動態和靜態對映

動態地址對映使用幀中繼逆向ARP來請求特定連線的下一跳協定地址(給定資料鏈路連線識別符號(DLCI))。對逆向ARP請求的響應在路由器或接入伺服器上的地址到DLCI對映表中輸入；然後使用表為傳出流量提供下一跳協定地址或DLCI。

由於物理介面現在配置為多個子介面，因此您必須提供將子介面與物理介面區分開來的資訊，並將特定子介面與特定DLCI相關聯。

它支援的所有協定預設啟用逆向ARP，但是對於特定的協定 — DLCI對可以禁用逆向ARP。因此，您可以在同一DLCI上為某些協定使用動態對映，為其它協定使用靜態對映。如果知道連線的另一端不支援協定 — DLCI對，則可以顯式禁用該對的反向ARP。由於它支援的所有協定預設啟用逆向ARP，因此無需其他命令即可配置子介面上的動態地址對映。靜態對映將指定的下一跳協定地址連結到指定的DLCI。靜態對映消除了逆向ARP請求的需要；提供靜態對映時，在指定的DLCI上，將自動禁用指定協定的逆向ARP。如果另一端的路由器根本不支援逆向ARP，或者不支援要在幀中繼上使用的特定協定的逆向ARP，則必須使用靜態對映。

## 網路圖表

我們已經瞭解如何配置Cisco路由器執行逆向ARP。以下示例展示如何在多點介面或子介面需要靜態對映的情況下配置靜態對映：

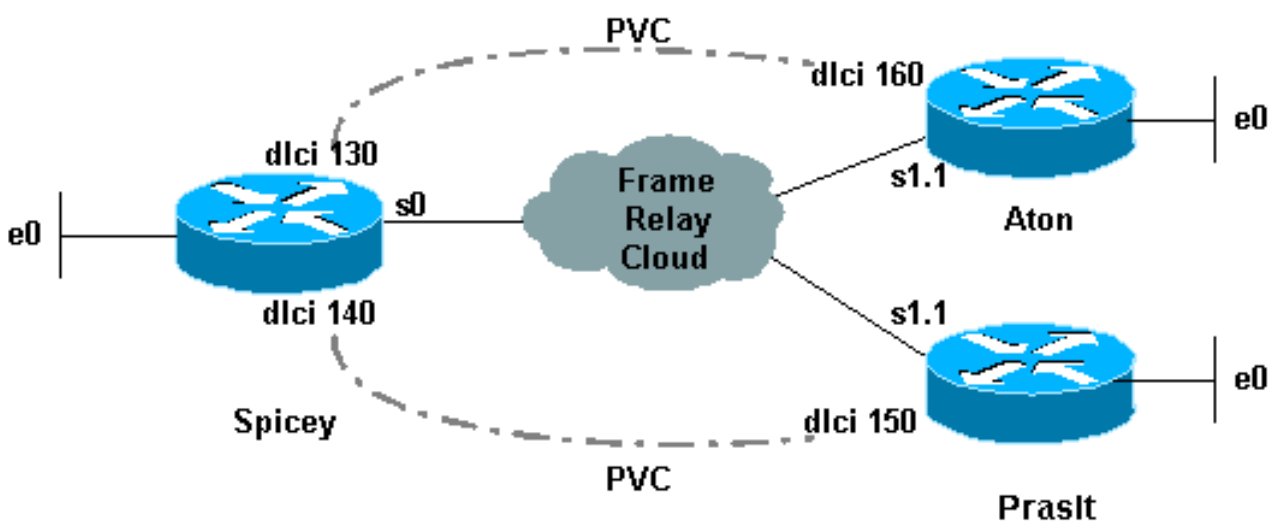

## 組態

- [阿頓](#)

- [斯皮塞](#)
- [普拉西](#)

## 阿頓

```
Aton#show running-config
Building configuration...
Current configuration:
!
version 12.0
service timestamps debug uptime
service timestamps log uptime
no service password-encryption
!
hostname Aton
!
!
interface Ethernet0
 ip address 122.122.122.1 255.255.255.0
!
interface Serial1
 no ip address
 encapsulation frame-relay
!
interface Serial1.1 multipoint
 ip address 4.0.1.3 255.255.255.0
 frame-relay map ip 4.0.1.1 160 broadcast
!
router igrp 2
 network 4.0.0.0
 network 122.0.0.0
!
line con 0
 exec-timeout 0 0
 transport input none
line aux 0
line vty 0 4
 login
!
end
```

## 斯皮塞

```
Spicey#show running-config
Building configuration...Current configuration : 1652
bytes!
version 12.1
service timestamps debug datetime msec
service timestamps log datetime msec
no service password-encryption
!
hostname Spicey
!
!
interface Ethernet0
 ip address 124.124.124.1 255.255.255.0
!
interface Serial0
 ip address 4.0.1.1 255.255.255.0
 encapsulation frame-relay
 frame-relay map ip 4.0.1.2 140 broadcast
 frame-relay map ip 4.0.1.3 130 broadcast
```

```
!  
router igrp 2  
network 4.0.0.0  
network 124.0.0.0  
!  
!  
line con 0  
exec-timeout 0 0  
transport input none  
line aux 0  
line vty 0 4  
login  
!  
end
```

## 普拉西

```
Prasit#show running-config  
Building configuration...  
Current configuration : 1162 bytes  
!  
version 12.1  
service timestamps debug datetime msec  
service timestamps log datetime msec  
no service password-encryption  
!  
hostname Prasit  
!  
!  
!  
interface Ethernet0  
 ip address 123.123.123.1 255.255.255.0  
!  
interface Serial1  
 no ip address  
 encapsulation frame-relay  
!  
interface Serial1.1 multipoint  
 ip address 4.0.1.2 255.255.255.0  
 frame-relay map ip 4.0.1.1 150 broadcast  
!  
router igrp 2  
 network 4.0.0.0  
 network 123.0.0.0  
!  
line con 0  
 exec-timeout 0 0  
 transport input none  
line aux 0  
line vty 0 4  
 login  
!  
end
```

## [debug和show命令](#)

- show frame-relay map
- show frame-relay pvc

## [阿頓](#)



Aton#**show frame-relay map**

Serial1.1 (up): ip 4.0.1.1 dlci 160(0xA0,0x2800), static, broadcast, CISCO, status defined, active

Aton#**show frame-relay pvc**

PVC Statistics for interface Serial1 (Frame Relay DTE)

	Active	Inactive	Deleted	Static
Local	1	0	0	0
Switched	0	0	0	0
Unused	0	0	0	0

DLCI = 160, DLCI USAGE = LOCAL, PVC STATUS = ACTIVE, INTERFACE = Serial1.1

input pkts 16	output pkts 9	in bytes 3342
out bytes 450	dropped pkts 0	in FECN pkts 0
in BECN pkts 0	out FECN pkts 0	out BECN pkts 0
in DE pkts 0	out DE pkts 0	
out bcast pkts 9	out bcast bytes 450	

pvc create time 00:10:02, last time pvc status changed 00:10:02

Aton#**ping 124.124.124.1**

Type escape sequence to abort.

Sending 5, 100-byte ICMP Echos to 124.124.124.1, timeout is 2 seconds:

!!!!

Success rate is 100 percent (5/5), round-trip min/avg/max = 32/35/36 ms

[斯皮塞](#)

Spicey#**show frame-relay map**

Serial0 (up): ip 4.0.1.2 dlci 140(0x8C,0x20C0), static, broadcast, CISCO, status defined, active

Serial0 (up): ip 4.0.1.3 dlci 130(0x82,0x2020), static, broadcast, CISCO, status defined, active

Spicey#**show frame-relay pvc**

PVC Statistics for interface Serial0 (Frame Relay DTE)

	Active	Inactive	Deleted	Static
Local	2	0	0	0
Switched	0	0	0	0
Unused	0	0	0	0

DLCI = 130, DLCI USAGE = LOCAL, PVC STATUS = ACTIVE, INTERFACE = Serial0

input pkts 9	output pkts 48	in bytes 434
out bytes 11045	dropped pkts 0	in FECN pkts 0
in BECN pkts 0	out FECN pkts 0	out BECN pkts 0
in DE pkts 0	out DE pkts 0	
out bcast pkts 48	out bcast bytes 11045	

pvc create time 00:36:25, last time pvc status changed 00:36:15

DLCI = 140, DLCI USAGE = LOCAL, PVC STATUS = ACTIVE, INTERFACE = Serial0

input pkts 17	output pkts 26	in bytes 1390
out bytes 4195	dropped pkts 0	in FECN pkts 0
in BECN pkts 0	out FECN pkts 0	out BECN pkts 0
in DE pkts 0	out DE pkts 0	
out bcast pkts 16	out bcast bytes 3155	

pvc create time 00:08:39, last time pvc status changed 00:08:39

```
Spicey#ping 122.122.122.1
Type escape sequence to abort.
Sending 5, 100-byte ICMP Echos to 122.122.122.1, timeout is 2 seconds:
!!!!
Success rate is 100 percent (5/5), round-trip min/avg/max = 36/36/40 ms
```

```
Spicey#ping 123.123.123.1
Type escape sequence to abort.
Sending 5, 100-byte ICMP Echos to 123.123.123.1, timeout is 2 seconds:
!!!!
Success rate is 100 percent (5/5), round-trip min/avg/max = 32/35/36
```

## [普拉西](#)

```
Prasit#show frame-relay map
Serial1.1 (up): ip 4.0.1.1 dlci 150(0x96,0x2460), static,
                broadcast,
                CISCO, status defined, active
```

```
Prasit#show frame-relay pvc
PVC Statistics for interface Serial1 (Frame Relay DTE)

```

	Active	Inactive	Deleted	Static
Local	1	0	0	0
Switched	0	0	0	0
Unused	0	0	0	0

```
DLCI = 150, DLCI USAGE = LOCAL, PVC STATUS = ACTIVE, INTERFACE = Serial1.1
input pkts 28          output pkts 19          in bytes 4753
out bytes 1490        dropped pkts 0          in FECN pkts 0
in BECN pkts 0        out FECN pkts 0        out BECN pkts 0
in DE pkts 0          out DE pkts 0
out bcast pkts 9      out bcast bytes 450
pvc create time 00:11:00, last time pvc status changed 00:11:00
```

```
Prasit#ping 124.124.124.1
Type escape sequence to abort.
Sending 5, 100-byte ICMP Echos to 124.124.124.1, timeout is 2 seconds:
!!!!
Success rate is 100 percent (5/5), round-trip min/avg/max = 36/36/36 ms
```

有關這些命令的詳細資訊，請參閱[幀中繼命令](#)。

## [配置IP未編號幀中繼](#)

如果您沒有IP地址空間來使用多個子介面，則可以在每個子介面上使用未編號的IP。如果是這種情況，您需要使用靜態路由或動態路由，以便您的流量能夠照常路由，並且必須使用點對點子介面。

### [網路圖表](#)

以下範例說明此情況：



### [組態](#)

- [斯皮塞](#)
- [普拉西](#)

## 斯皮塞

```
Spicey#show running-config
Building configuration...
Current configuration : 1674 bytes
!
version 12.1
service timestamps debug datetime msec
service timestamps log datetime msec
no service password-encryption
!
hostname Spicey
!
!
!
interface Ethernet0
 ip address 124.124.124.1 255.255.255.0
!
interface Serial0
 no ip address
 encapsulation frame-relay
!
interface Serial0.1 point-to-point
 ip unnumbered Ethernet0
 frame-relay interface-dlci 140
!
router igrp 2
 network 124.0.0.0
!
line con 0
 exec-timeout 0 0
 transport input none
line aux 0
line vty 0 4
 login
!
end
```

## 普拉西

```
Prasit#show running-config
Building configuration...

Current configuration : 1188 bytes
!
version 12.1
service timestamps debug datetime msec
service timestamps log datetime msec
no service password-encryption
!
hostname Prasit
!
!
interface Ethernet0
 ip address 123.123.123.1 255.255.255.0
!
interface Serial1
 no ip address
 encapsulation frame-relay
```

```

!
interface Serial1.1 point-to-point
 ip unnumbered Ethernet0
 frame-relay interface-dlci 150
!
router igrp 2
 network 123.0.0.0
!
line con 0
 exec-timeout 0 0
 transport input none
line aux 0
line vty 0 4
 login
!
end

```

## show命令

- show frame-relay map
- show frame-relay pvc

## 斯皮塞

Spicey#**show frame-relay map**

Serial0.1 (up): point-to-point dlci, dlci 140(0x8C,0x20C0), broadcast  
status defined, active

Spicey#**show frame-relay pvc**

PVC Statistics for interface Serial0 (Frame Relay DTE)

	Active	Inactive	Deleted	Static
Local	1	0	0	0
Switched	0	0	0	0
Unused	0	0	0	0

DLCI = 140, DLCI USAGE = LOCAL, PVC STATUS = ACTIVE, INTERFACE =  
Serial0.1

```

input pkts 23          output pkts 24          in bytes 3391
out bytes 4952        dropped pkts 0          in FECN pkts 0
in BECN pkts 0        out FECN pkts 0        out BECN pkts 0
in DE pkts 0          out DE pkts 0
out bcast pkts 14     out bcast bytes 3912
pvc create time 00:04:47, last time pvc status changed 00:04:47

```

Spicey#**show ip route**

Codes: C - connected, S - static, I - IGRP, R - RIP, M - mobile, B - BGP  
D - EIGRP, EX - EIGRP external, O - OSPF, IA - OSPF inter area  
N1 - OSPF NSSA external type 1, N2 - OSPF NSSA external type 2  
E1 - OSPF external type 1, E2 - OSPF external type 2, E - EGP  
i - IS-IS, L1 - IS-IS level-1, L2 - IS-IS level-2, ia - IS-IS  
inter area  
\* - candidate default, U - per-user static route, o - ODR  
P - periodic downloaded static route

Gateway of last resort is not set  
124.0.0.0/24 is subnetted, 1 subnets

```
C      124.124.124.0 is directly connected, Ethernet0
      123.0.0.0/8 is variably subnetted, 2 subnets, 2 masks
I      123.0.0.0/8 [100/8576] via 123.123.123.1, 00:01:11, Serial0.1
I      123.123.123.0/32 [100/8576] via 123.123.123.1, 00:01:11,
Serial0.1
```

Spicey#**ping 123.123.123.1**

Type escape sequence to abort.

Sending 5, 100-byte ICMP Echos to 123.123.123.1, timeout is 2 seconds:

!!!!!

Success rate is 100 percent (5/5), round-trip min/avg/max = 36/36/36 ms

[普拉西](#)

Prasit#**show frame-relay map**

```
Serial1.1 (up): point-to-point dlci, dlci 150(0x96,0x2460), broadcast
      status defined, active
```

Prasit#**show frame-relay pvc**

PVC Statistics for interface Serial1 (Frame Relay DTE)

	Active	Inactive	Deleted	Static
Local	1	0	0	0
Switched	0	0	0	0
Unused	0	0	0	0

DLCI = 150, DLCI USAGE = LOCAL, PVC STATUS = ACTIVE, INTERFACE = Serial1.1

```
input pkts 24          output pkts 52          in bytes 4952
out bytes 10892        dropped pkts 0          in FECN pkts 0
in BECN pkts 0        out FECN pkts 0        out BECN pkts 0
in DE pkts 0          out DE pkts 0
out bcast pkts 41     out bcast bytes 9788
pvc create time 00:10:54, last time pvc status changed 00:03:51
```

Prasit#**show ip route**

```
Codes: C - connected, S - static, I - IGRP, R - RIP, M - mobile, B - BGP
       D - EIGRP, EX - EIGRP external, O - OSPF, IA - OSPF inter area
       N1 - OSPF NSSA external type 1, N2 - OSPF NSSA external type 2
       E1 - OSPF external type 1, E2 - OSPF external type 2, E - EGP
       i - IS-IS, L1 - IS-IS level-1, L2 - IS-IS level-2, ia - IS-IS
inter area
       * - candidate default, U - per-user static route, o - ODR
       P - periodic downloaded static route
```

Gateway of last resort is not set

```
      124.0.0.0/8 is variably subnetted, 2 subnets, 2 masks
I      124.0.0.0/8 [100/8576] via 124.124.124.1, 00:00:18, Serial1.1
I      124.124.124.0/32 [100/8576] via 124.124.124.1, 00:00:18,
Serial1.1
      123.0.0.0/24 is subnetted, 1 subnets
C      123.123.123.0 is directly connected, Ethernet0
```

Prasit#**ping 124.124.124.1**

Type escape sequence to abort.

Sending 5, 100-byte ICMP Echos to 124.124.124.1, timeout is 2 seconds:

!!!!!

Success rate is 100 percent (5/5), round-trip min/avg/max = 36/120/436 ms

[配置幀中繼備份](#)

## 使用ISDN的訊框中繼備份

您可能需要使用ISDN備份幀中繼電路。有幾種方法可以做到這一點。第一種方法（可能是最佳方法）是使用浮動靜態路由，將流量路由到基本速率介面(BRI)IP地址並使用適當的路由度量。也可以在主介面上或每個資料鏈路連線識別符號(DLCI)上使用備份介面。備份主介面可能沒有多大幫助，因為如果主介面不關閉，永久虛擬電路(PVC)可能會丟失。請記住，協定是與本地幀中繼交換機（而不是遠端路由器）交換的。

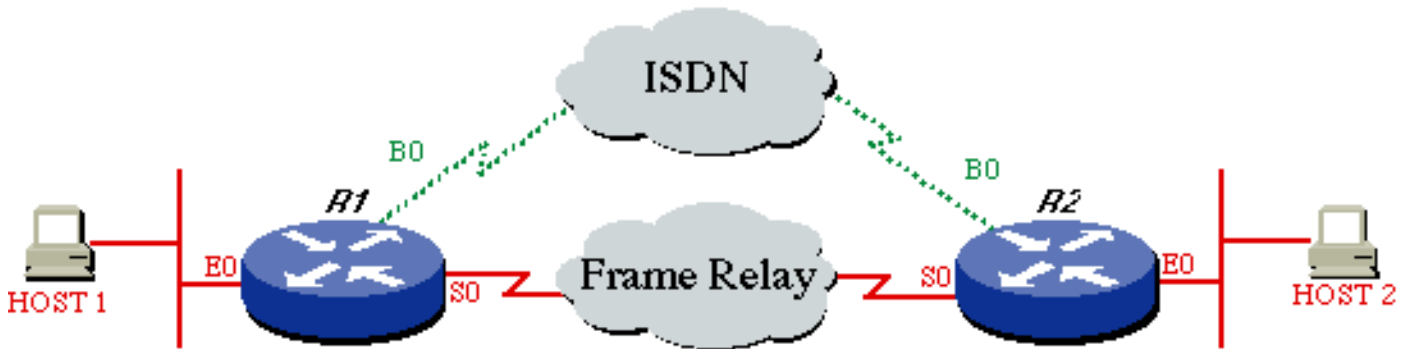

### 組態

- [路由器1](#)
- [路由器2](#)

#### 路由器1

```
ROUTER1#
!
hostname ROUTER1
!
username ROUTER2 password same
 isdn switch-type basic-dms100
!
interface Ethernet 0
 ip address 172.16.15.1 255.255.255.248
!
interface serial 0
 ip address 172.16.24.129 255.255.255.128
 encapsulation FRAME-RELAY
!
interface BRI0
 description Backup ISDN for frame-relay
 ip address 172.16.12.1 255.255.255.128
 encapsulation PPP
 dialer idle-timeout 240
 dialer wait-for-carrier-time 60
 dialer map IP 172.16.12.2 name ROUTER2 broadcast
7086639706
 ppp authentication chap
 dialer-group 1
 isdn spid1 0127280320 2728032
 isdn spid2 0127295120 2729512
!
router igrp 1
 network 172.16.0.0
!
ip route 172.16.15.16 255.255.255.248 172.16.12.2 150
```

```
!--- Floating static route. ! access-list 101 deny igmp
0.0.0.0 255.255.255.255 0.0.0.0 255.255.255.255 access-
list 101 permit ip 0.0.0.0 255.255.255.255 0.0.0.0
255.255.255.255 dialer-list 1 LIST 101 !
```

## 路由器2

```
ROUTER2#
!
hostname ROUTER2
!
username ROUTER1 password same
 isdn switch-type basic-dms100
!
interface Ethernet 0
 ip address 172.16.15.17 255.255.255.248
!
interface Serial 0
 ip address 172.16.24.130 255.255.255.128
 encapsulation FRAME-RELAY
!
interface BRI0
 description ISDN backup interface for frame-relay
 ip address 172.16.12.2 255.255.255.128
 encapsulation PPP
 dialer idle-timeout 240
 dialer map IP 172.16.12.1 name ROUTER1 broadcast
 ppp authentication chap
 pulse-time 1
 dialer-group 1
 isdn spid1 0191933333 4445555
 isdn spid2 0191933334 4445556
!
router igrp 1
 network 172.16.0.0
!
ip route 172.16.15.0 255.255.255.248 172.16.12.1 150
!--- Floating static route. ! access-list 101 deny igmp
0.0.0.0 255.255.255.255 0.0.0.0 255.255.255.255 access-
list 101 permit ip 0.0.0.0 255.255.255.255 162.27.9.0
0.0.0.255 dialer-list 1 LIST 101 !
```

## show命令

要驗證ISDN是否正常工作，請使用以下debug命令。發出 [debug](#) 指令之前，請先參閱有關 **Debug 指令的重要資訊**。

- debug isdn q931
- debug ppp neg
- debug ppp auth

嘗試在不使用備份命令的情況下，從呼叫側到中心側進行ISDN呼叫。如果成功，請向呼叫方新增 backup命令。

註：要測試備份，請不要在串列介面上使用shutdown命令，而是從串列線路上拔出電纜來模擬實際的串列線路問題。

## 每個DCLI備份的配置

現在，讓我們假設Spicey是中心側，Prasit是連線中心側的一側(Spicey)。請注意，您只將備份命令新增到呼叫中心端的一端。

**附註：** 子介面不支援備份載入。由於我們不跟蹤子介面上的流量級別，因此不會計算負載。

### 網路圖表

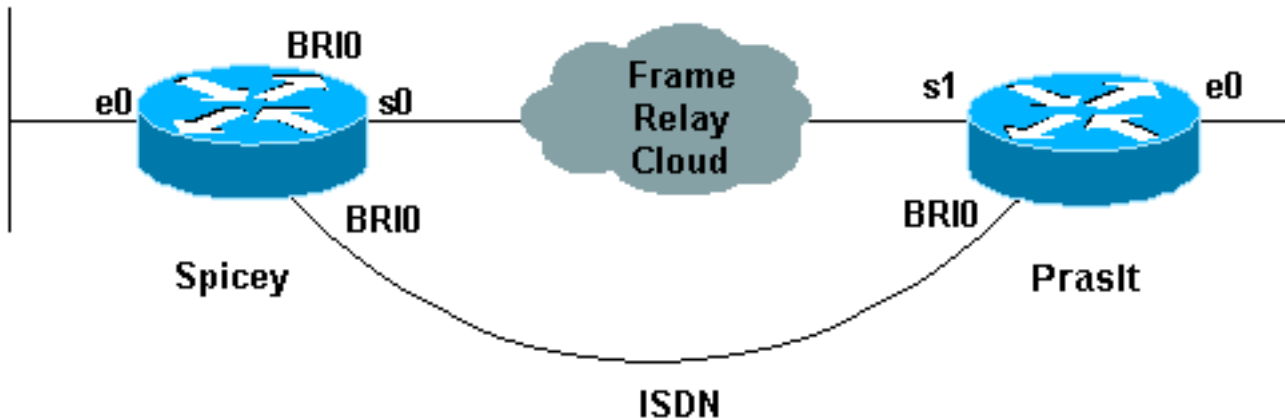

### 組態

- [斯皮塞](#)
- [普拉西](#)

#### 斯皮塞

```
Spicey#show running-config
Building configuration...

Current configuration : 1438 bytes
!
version 12.1
service timestamps debug datetime msec
service timestamps log datetime msec
no service password-encryption
!
hostname Spicey
!
!
username Prasit password 0 cisco
!
!
isdn switch-type basic-net3
!
!
!
interface Ethernet0
 ip address 124.124.124.1 255.255.255.0
!
interface Serial0
 no ip address
 encapsulation frame-relay
!
interface Serial0.1 point-to-point
 ip address 4.0.1.1 255.255.255.0
```



```
frame-relay interface-dlci 140
!
interface BRI0
 ip address 3.1.6.1 255.255.255.0
 encapsulation ppp
 dialer map ip 3.1.6.2 name Prasit broadcast
 dialer-group 1
 isdn switch-type basic-net3
 no peer default ip address
 no cdp enable
 ppp authentication chap
!
router igrp 2
 network 3.0.0.0
 network 4.0.0.0
 network 124.0.0.0
!
ip classless
 ip route 123.123.123.0 255.255.255.0 3.1.6.2 250
!
access-list 101 deny igrp any any
 access-list 101 permit ip any any
 dialer-list 1 protocol ip list 101
!
line con 0
 exec-timeout 0 0
 transport input none
line aux 0
line vty 0 4
 login
!
end
```

## 普拉西

```
Prasit#show running-config
Building configuration...

Current configuration : 1245 bytes
!
version 12.1
service timestamps debug datetime msec
service timestamps log datetime msec
no service password-encryption
!
hostname Prasit
!
username Spicey password 0 cisco
!
!
isdn switch-type basic-net3
!
!
!
interface Ethernet0
 ip address 123.123.123.1 255.255.255.0
!
interface Serial1
 no ip address
 encapsulation frame-relay
!
interface Serial1.1 point-to-point
 backup delay 5 10
```

```

backup interface BRI0
ip address 4.0.1.2 255.255.255.0
frame-relay interface-dlci 150
!
interface BRI0
ip address 3.1.6.2 255.255.255.0
encapsulation ppp
dialer map ip 3.1.6.1 name Spicely broadcast 6106
dialer-group 1
isdn switch-type basic-net3
ppp authentication chap
!
router igrp 2
network 3.0.0.0
network 4.0.0.0
network 123.0.0.0
!
ip route 124.124.124.0 255.255.255.0 3.1.6.1 250
!
access-list 101 deny igrp any any
access-list 101 permit ip any any
dialer-list 1 protocol ip list 101
!
line con 0
exec-timeout 0 0
transport input none
line aux 0
line vty 0 4
login
!
end

```

## show命令

- show frame-relay map
- show ip route
- show isdn history
- show isdn status
- show interface bri 0
- show isdn active

## 斯皮塞

Spicely#**show frame-relay map**

Serial0.2 (up): point-to-point dlci, dlci 130(0x82,0x2020), broadcast  
status defined, active

Serial0.1 (up): point-to-point dlci, dlci 140(0x8C,0x20C0), broadcast  
status defined, active

Spicely#**show ip route**

Codes: C - connected, S - static, I - IGRP, R - RIP, M - mobile, B - BGP

D - EIGRP, EX - EIGRP external, O - OSPF, IA - OSPF inter area

N1 - OSPF NSSA external type 1, N2 - OSPF NSSA external type 2

E1 - OSPF external type 1, E2 - OSPF external type 2, E - EGP

i - IS-IS, L1 - IS-IS level-1, L2 - IS-IS level-2, ia - IS-IS

inter area

\* - candidate default, U - per-user static route, o - ODR

P - periodic downloaded static route

Gateway of last resort is not set

3.0.0.0/24 is subnetted, 2 subnets C  
3.1.3.0 is directly connected, Serial0.2 C  
3.1.6.0 is directly connected, BRI0  
4.0.0.0/24 is subnetted, 1 subnets C  
4.0.1.0 is directly connected, Serial0.1  
124.0.0.0/24 is subnetted, 1 subnets C  
124.124.124.0 is directly connected, Ethernet0  
123.0.0.0/8 is variably subnetted, 2 subnets, 2 masks I  
123.0.0.0/8 [100/8576] via 4.0.1.2, 00:00:00, Serial0.1 S  
123.123.123.0/24 [250/0] via 3.1.6.2 I  
122.0.0.0/8 [100/8576] via 3.1.3.3, 00:00:37, Serial0.2

Spicey#

\*Mar 1 00:59:12.527: %LINK-3-UPDOWN: Interface BRI0:1, changed state to up  
\*Mar 1 00:59:13.983: %LINEPROTO-5-UPDOWN: Line protocol on Interface  
BRI0:1, changed state to up  
\*Mar 1 00:59:18.547: %ISDN-6-CONNECT: Interface BRI0:1 is now connected to 6105 Prasit

Spicey#**show isdn history**

-----  
ISDN CALL HISTORY  
-----  
Call History contains all active calls, and a maximum of 100 inactive calls.  
Inactive call data will be retained for a maximum of 15 minutes.  
-----  
Call      Calling      Called      Remote      Seconds      Seconds      Seconds  
Charges      Number      Number      Name      Used      Left      Idle      Units/Currency  
-----  
In            6105            6106      Prasit            31      90      29  
-----

Spicey#

\*Mar 1 01:01:14.547: %ISDN-6-DISCONNECT: Interface BRI0:1 disconnected  
from 6105 Prasit, call lasted 122 seconds  
\*Mar 1 01:01:14.663: %LINK-3-UPDOWN: Interface BRI0:1, changed state to down  
\*Mar 1 01:01:15.663: %LINEPROTO-5-UPDOWN: Line protocol on Interface  
BRI0:1, changed state to down

[普拉西](#)

Prasit#**show frame-relay map**

Serial1.1 (up): point-to-point dlci, dlci 150(0x96,0x2460), broadcast  
status defined, active

Prasit#**ping 124.124.124.1**

Type escape sequence to abort.  
Sending 5, 100-byte ICMP Echos to 124.124.124.1, timeout is 2 seconds:  
!!!!  
Success rate is 100 percent (5/5), round-trip min/avg/max = 36/36/40 ms

Prasit#**show ip route**

Codes: C - connected, S - static, I - IGRP, R - RIP, M - mobile, B - BGP  
D - EIGRP, EX - EIGRP external, O - OSPF, IA - OSPF inter area  
N1 - OSPF NSSA external type 1, N2 - OSPF NSSA external type 2  
E1 - OSPF external type 1, E2 - OSPF external type 2, E - EGP  
i - IS-IS, L1 - IS-IS level-1, L2 - IS-IS level-2, ia - IS-IS  
inter area  
\* - candidate default, U - per-user static route, o - ODR

P - periodic downloaded static route

Gateway of last resort is not set

```
I 3.0.0.0/8 [100/10476] via 4.0.1.1, 00:00:55, Serial1.1
  4.0.0.0/24 is subnetted, 1 subnets
C 4.0.1.0 is directly connected, Serial1.1
  124.0.0.0/8 is variably subnetted, 2 subnets, 2 masks
S 124.124.124.0/24 [250/0] via 3.1.6.1
I 124.0.0.0/8 [100/8576] via 4.0.1.1, 00:00:55, Serial1.1
  123.0.0.0/24 is subnetted, 1 subnets
C 123.123.123.0 is directly connected, Ethernet0
I 122.0.0.0/8 [100/10576] via 4.0.1.1, 00:00:55, Serial1.1
```

串列線路中斷。

Prasit#

```
*Mar 1 01:23:50.531: %LINK-3-UPDOWN: Interface Serial1, changed state to down
*Mar 1 01:23:51.531: %LINEPROTO-5-UPDOWN: Line protocol on Interface
Serial1, changed state to down
*Mar 1 01:23:53.775: %LINK-3-UPDOWN: Interface BRI0:1, changed state to down
*Mar 1 01:23:53.791: %LINK-3-UPDOWN: Interface BRI0:2, changed state to down
*Mar 1 01:23:53.827: %LINK-3-UPDOWN: Interface BRI0, changed state to up
*Mar 1 01:23:57.931: %ISDN-6-LAYER2UP: Layer 2 for Interface BR0, TEI 64 changed to up
```

Prasit#**show ip route**

```
Codes: C - connected, S - static, I - IGRP, R - RIP, M - mobile, B - BGP
       D - EIGRP, EX - EIGRP external, O - OSPF, IA - OSPF inter area
       N1 - OSPF NSSA external type 1, N2 - OSPF NSSA external type 2
       E1 - OSPF external type 1, E2 - OSPF external type 2, E - EGP
       i - IS-IS, L1 - IS-IS level-1, L2 - IS-IS level-2, ia - IS-IS
inter area
       * - candidate default, U - per-user static route, o - ODR
       P - periodic downloaded static route
```

Gateway of last resort is not set

```
3.0.0.0/24 is subnetted, 1 subnets
C 3.1.6.0 is directly connected, BRI0
  124.0.0.0/24 is subnetted, 1 subnets
S 124.124.124.0 [250/0] via 3.1.6.1
  123.0.0.0/24 is subnetted, 1 subnets
C 123.123.123.0 is directly connected, Ethernet0
```

Prasit#**show isdn status**

```
Global ISDN Switchtype = basic-net3
ISDN BRI0 interface
  dsl 0, interface ISDN Switchtype = basic-net3
Layer 1 Status:
  ACTIVE
Layer 2 Status:
  TEI = 64, Ces = 1, SAPI = 0, State = MULTIPLE_FRAME_ESTABLISHED
Layer 3 Status:
  0 Active Layer 3 Call(s)
Active dsl 0 CCBs = 0
The Free Channel Mask: 0x80000003
Total Allocated ISDN CCBs = 0
```

Prasit#**ping 124.124.124.1**

Type escape sequence to abort.

Sending 5, 100-byte ICMP Echos to 124.124.124.1, timeout is 2 seconds:

!

```

*Mar 1 01:25:47.383: %LINK-3-UPDOWN: Interface BRI0:1, changed state to up!!!
Success rate is 80 percent (4/5), round-trip min/avg/max = 36/36/36 ms
Prasit#
*Mar 1 01:25:48.475: %LINEPROTO-5-UPDOWN: Line protocol on Interface
BRI0:1, changed state to up

Prasit#
*Mar 1 01:25:53.407: %ISDN-6-CONNECT: Interface BRI0:1 is now connected
to 6106 Spicey

```

```

Prasit#show isdn status
Global ISDN Switchtype = basic-net3
ISDN BRI0 interface
    dsl 0, interface ISDN Switchtype = basic-net3
Layer 1 Status:
    ACTIVE
Layer 2 Status:
    TEI = 64, Ces = 1, SAPI = 0, State = MULTIPLE_FRAME_ESTABLISHED
Layer 3 Status:
    1 Active Layer 3 Call(s)
    CCB:callid=8003, sapi=0, ces=1, B-chan=1, calltype=DATA
Active dsl 0 CCBs = 1
The Free Channel Mask: 0x80000002
Total Allocated ISDN CCBs = 1

```

```

Prasit#show isdn active

```

```

-----
                                ISDN ACTIVE CALLS
-----

```

Call Type	Calling Number	Called Number	Remote Name	Seconds Used	Seconds Left	Seconds Idle	Charges Units/Currency
Out		6106	Spicey	21	100	19	0

```

-----

```

```

Prasit#
*Mar 1 01:27:49.027: %ISDN-6-DISCONNECT: Interface BRI0:1 disconnected
from 6106 Spicey, call lasted 121 seconds
*Mar 1 01:27:49.131: %LINK-3-UPDOWN: Interface BRI0:1, changed state to down
*Mar 1 01:27:50.131: %LINEPROTO-5-UPDOWN: Line protocol on Interface
BRI0:1, changed state to down
*Mar 1 01:28:09.215: %LINK-3-UPDOWN: Interface Serial1, changed state to up
*Mar 1 01:28:10.215: %LINEPROTO-5-UPDOWN: Line protocol on Interface
Serial1, changed state to up
*Mar 1 01:28:30.043: %ISDN-6-LAYER2DOWN: Layer 2 for Interface BRI0,
TEI 64 changed to down
*Mar 1 01:28:30.047: %ISDN-6-LAYER2DOWN: Layer 2 for Interface BR0, TEI
64 changed to down
*Mar 1 01:28:30.371: %LINK-5-CHANGED: Interface BRI0, changed state to standby mode
*Mar 1 01:28:30.387: %LINK-3-UPDOWN: Interface BRI0:1, changed state to down
*Mar 1 01:28:30.403: %LINK-3-UPDOWN: Interface BRI0:2, changed state to down
Prasit#

```

串列連線再次恢復。

```

Prasit#show isdn status
Global ISDN Switchtype = basic-net3
ISDN BRI0 interface
    dsl 0, interface ISDN Switchtype = basic-net3
Layer 1 Status:
    DEACTIVATED
Layer 2 Status:
    Layer 2 NOT Activated

```

```
Layer 3 Status:
  0 Active Layer    3 Call(s)
Active dsl 0 CCBs = 0
The Free Channel Mask: 0x80000003
Total Allocated ISDN CCBs = 0
```

Prasit#**show interface bri 0**

```
BRI0 is standby mode, line protocol is down
Hardware is BRI
Internet address is 3.1.6.2/24
MTU 1500 bytes, BW 64 Kbit, DLY 20000 usec,
  reliability 255/255, txload 1/255, rxload 1/255
Encapsulation PPP, loopback not set
Last input 00:01:00, output 00:01:00, output hang never
Last clearing of "show interface" counters 01:28:16
Input queue: 0/75/0/0 (size/max/drops/flushes); Total output drops: 0
Queueing strategy: weighted fair
Output queue: 0/1000/64/0 (size/max total/threshold/drops)
  Conversations 0/1/16 (active/max active/max total)
  Reserved Conversations 0/0 (allocated/max allocated)
5 minute input rate 0 bits/sec, 0 packets/sec
5 minute output rate 0 bits/sec, 0 packets/sec
  128 packets input, 601 bytes, 0 no buffer
  Received 0 broadcasts, 0 runts, 0 giants, 0 throttles
  0 input errors, 0 CRC, 0 frame, 0 overrun, 0 ignored, 0 abort
  132 packets output, 687 bytes, 0 underruns
  0 output errors, 0 collisions, 10 interface resets
  0 output buffer failures, 0 output buffers swapped out
  14 carrier transitions
```

Prasit#**ping 124.124.124.1**

```
Type escape sequence to abort.
Sending 5, 100-byte ICMP Echos to 124.124.124.1, timeout is 2 seconds:
!!!!
Success rate is 100 percent (5/5), round-trip min/avg/max = 36/36/36 ms
```

## [使用撥號程式設定檔的中心輻射點](#)

以下是每個DLCI備份配置的集中器和分支的示例。分支路由器正在呼叫中心路由器。您可以看到，通過在中心端的撥號器池上使用max-link選項，我們每端只允許一個B通道。

**注意：**子介面不支援備份載入。由於我們不跟蹤子介面上的流量級別，因此不會計算負載。

## [網路圖表](#)

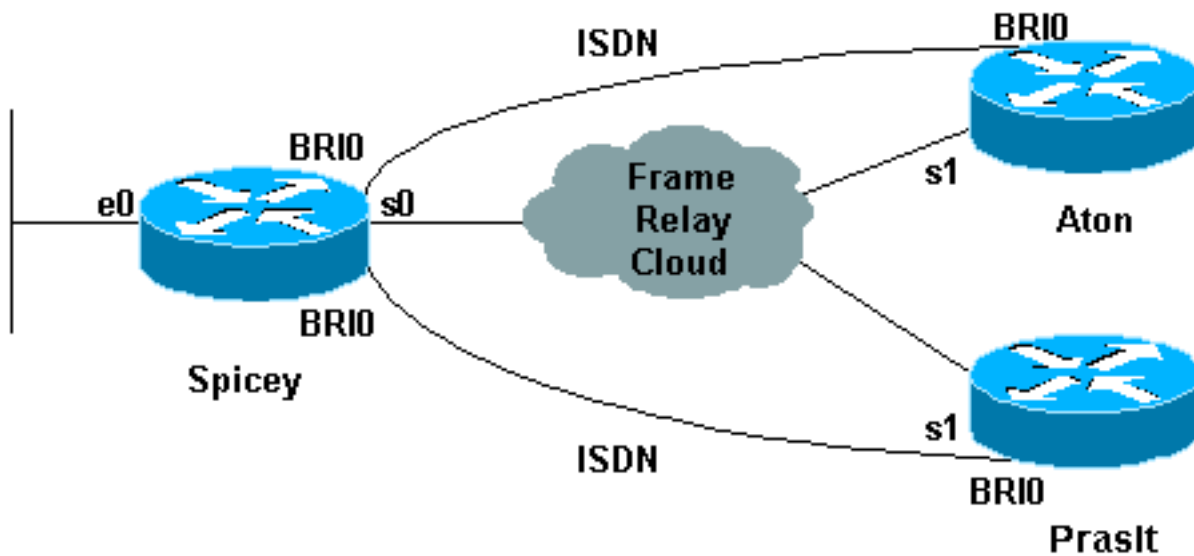

## 組態

- [阿頓](#)
- [斯皮塞](#)
- [普拉西](#)

### 阿頓

```
Aton#show running-config
Building configuration...

Current configuration:
!
version 12.0
service timestamps debug uptime
service timestamps log uptime
no service password-encryption
!
hostname Aton
!
!
username Spicey password 0 cisco
!
isdn switch-type basic-net3
!
!
!
interface Ethernet0
 ip address 122.122.122.1 255.255.255.0
!
!
interface Serial1
 no ip address
 encapsulation frame-relay
!
interface Serial1.1 point-to-point
 ip address 3.1.3.3 255.255.255.0
 backup delay 5 10
 backup interface BRI0
 frame-relay interface-dlci 160
```

```
!  
interface BRI0  
  ip address 155.155.155.3 255.255.255.0  
  encapsulation ppp  
  no ip route-cache  
  no ip mroute-cache  
  dialer map ip 155.155.155.2 name Spicely broadcast 6106  
  dialer-group 1  
  isdn switch-type basic-net3  
  ppp authentication chap  
!  
router igrp 2  
  network 3.0.0.0  
  network 122.0.0.0  
  network 155.155.0.0  
!  
ip route 124.124.124.0 255.255.255.0 155.155.155.2 250  
!  
access-list 101 deny igrp any any  
access-list 101 permit ip any any  
dialer-list 1 protocol ip list 101  
!  
line con 0  
  exec-timeout 0 0  
  transport input none  
line aux 0  
line vty 0 4  
  login  
!  
end
```

## 斯皮塞

```
Spicely#show running-config  
Building configuration...  
Current configuration : 1887 bytes  
!  
version 12.1  
service timestamps debug datetime msec  
service timestamps log datetime msec  
no service password-encryption  
!  
hostname Spicely  
!  
username Prasit password 0 cisco  
username Aton password 0 cisco  
!  
isdn switch-type basic-net3  
!  
!  
!  
interface Ethernet0  
  ip address 124.124.124.1 255.255.255.0  
!  
interface Serial0  
  no ip address  
  encapsulation frame-relay  
!  
interface Serial0.1 point-to-point  
  ip address 4.0.1.1 255.255.255.0  
  frame-relay interface-dlci 140  
!  
interface Serial0.2 point-to-point
```



```
ip address 3.1.3.1 255.255.255.0
frame-relay interface-dlci 130
!
interface BRI0
no ip address
encapsulation ppp
no ip route-cache
no ip mroute-cache
dialer pool-member 2 max-link 1
dialer pool-member 1 max-link 1
isdn switch-type basic-net3
no peer default ip address
no cdp enable
ppp authentication chap
!
interface Dialer1
ip address 160.160.160.1 255.255.255.0
encapsulation ppp
no ip route-cache
no ip mroute-cache
dialer pool 1
dialer remote-name Prasit
dialer-group 1
ppp authentication chap
!
interface Dialer2
ip address 155.155.155.2 255.255.255.0
encapsulation ppp
no ip route-cache
no ip mroute-cache
dialer pool 2
dialer remote-name Aton
dialer-group 1
ppp authentication chap
!
router igrp 2
network 3.0.0.0
network 4.0.0.0
network 124.0.0.0
network 155.155.0.0
network 160.160.0.0
!
access-list 101 deny igrp any any
access-list 101 permit ip any any
dialer-list 1 protocol ip list 101
!
line con 0
exec-timeout 0 0
transport input none
line aux 0
line vty 0 4
login
!
end
```

## 普拉西

```
Prasit#show running-config
Building configuration...

Current configuration : 1267 bytes
!
version 12.1
```

```

service timestamps debug datetime msec
service timestamps log datetime msec
no service password-encryption
!
hostname Prasit
!
username Spicey password 0 cisco
!
isdn switch-type basic-net3
!
!
!
interface Ethernet0
 ip address 123.123.123.1 255.255.255.0
!
interface Serial1
 no ip address
 encapsulation frame-relay
!
interface Serial1.1 point-to-point
 backup delay 5 10
 backup interface BRI0
 ip address 4.0.1.2 255.255.255.0
 frame-relay interface-dlci 150
!
interface BRI0
 ip address 160.160.160.2 255.255.255.0
 encapsulation ppp
 dialer map ip 160.160.160.1 name Spicey broadcast 6106
 dialer-group 1
 isdn switch-type basic-net3
 ppp authentication chap
!
router igrp 2
 network 4.0.0.0
 network 123.0.0.0
 network 160.160.0.0
!
ip route 124.124.124.0 255.255.255.0 160.160.160.1 250
!
access-list 101 deny igrp any any
access-list 101 permit ip any any
dialer-list 1 protocol ip list 101
!
line con 0
 exec-timeout 0 0
 transport input none
line aux 0
line vty 0 4
 login
!
end

```

## show命令

- show frame-relay map
- show ip route
- 顯示幀對映
- show frame-relay pvc

## 阿頓

Aton#**show frame-relay map**

```
Serial1.1 (up): point-to-point dlci, dlci 160 (0xA0,0x2800), broadcast
status defined, active
```

Aton#**ping 124.124.124.1**

Type escape sequence to abort.

Sending 5, 100-byte ICMP Echos to 124.124.124.1, timeout is 2 seconds:

!!!!

Success rate is 100 percent (5/5), round-trip min/avg/max = 36/36/36 ms

Aton#**show ip route**

```
Codes: C - connected, S - static, I - IGRP, R - RIP, M - mobile, B - BGP
       D - EIGRP, EX - EIGRP external, O - OSPF, IA - OSPF inter area
       N1 - OSPF NSSA external type 1, N2 - OSPF NSSA external type 2
       E1 - OSPF external type 1, E2 - OSPF external type 2, E - EGP
       i - IS-IS, L1 - IS-IS level-1, L2 - IS-IS level-2, * - candidate default
       U - per-user static route, o - ODR, P - periodic downloaded static route
       T - traffic engineered route
```

Gateway of last resort is not set

```
I 155.155.0.0/16 [100/182571] via 3.1.3.1, Serial1.1
  3.0.0.0/24 is subnetted, 1 subnets
C 3.1.3.0 is directly connected, Serial1.1
I 4.0.0.0/8 [100/10476] via 3.1.3.1, Serial1.1
I 160.160.0.0/16 [100/182571] via 3.1.3.1, Serial1.1
  124.0.0.0/8 is variably subnetted, 2 subnets, 2 masks
S 124.124.124.0/24 [250/0] via 155.155.155.2
I 124.0.0.0/8 [100/8576] via 3.1.3.1, Serial1.1
I 123.0.0.0/8 [100/10576] via 3.1.3.1, Serial1.1
  122.0.0.0/24 is subnetted, 1 subnets
C 122.122.122.0 is directly connected, Ethernet0
```

Aton#

串列介面1正在關閉。

Aton#

```
01:16:33: %LINK-3-UPDOWN: Interface Serial1, changed state to down
01:16:34: %LINEPROTO-5-UPDOWN: Line protocol on Interface Serial1,
changed state to down
01:16:37: %LINK-3-UPDOWN: Interface BRI0:1, changed state to down
01:16:37: %LINK-3-UPDOWN: Interface BRI0:2, changed state to down
01:16:37: %LINK-3-UPDOWN: Interface BRI0, changed state to up
01:16:41: %ISDN-6-LAYER2UP: Layer 2 for Interface BR0, TEI 64 changed to up
```

Aton#**show ip route**

```
Codes: C - connected, S - static, I - IGRP, R - RIP, M - mobile, B - BGP
       D - EIGRP, EX - EIGRP external, O - OSPF, IA - OSPF inter area
       N1 - OSPF NSSA external type 1, N2 - OSPF NSSA external type 2
       E1 - OSPF external type 1, E2 - OSPF external type 2, E - EGP
       i - IS-IS, L1 - IS-IS level-1, L2 - IS-IS level-2, * - candidate default
       U - per-user static route, o - ODR, P - periodic downloaded static route
       T - traffic engineered route
```

Gateway of last resort is not set

```
155.155.0.0/24 is subnetted, 1 subnets
C 155.155.155.0 is directly connected, BRI0
  124.0.0.0/24 is subnetted, 1 subnets
S 124.124.124.0 [250/0] via 155.155.155.2
```

```
122.0.0.0/24 is subnetted, 1 subnets
C 122.122.122.0 is directly connected, Ethernet0
```

```
Aton#ping 124.124.124.1
```

```
Type escape sequence to abort.
```

```
Sending 5, 100-byte ICMP Echos to 124.124.124.1, timeout is 2 seconds:
```

```
01:21:33: %LINK-3-UPDOWN: Interface BRI0:1, changed state to up!!!!
Success rate is 80 percent (4/5), round-trip min/avg/max = 36/36/36 ms
Aton#
```

```
01:21:34: %LINEPROTO-5-UPDOWN: Line protocol on Interface BRI0:1,
changed state to up
```

```
01:21:39: %ISDN-6-CONNECT: Interface BRI0:1 is now connected to 6106
Spicey
```

```
Aton#ping 124.124.124.1
```

```
Type escape sequence to abort.
```

```
Sending 5, 100-byte ICMP Echos to 124.124.124.1, timeout is 2 seconds:
```

```
!!!!!
```

```
Success rate is 100 percent (5/5), round-trip min/avg/max = 32/123/296 ms
```

```
Aton#
```

## 串列1再次變為活動狀態

```
Aton#
```

```
01:24:02: %ISDN-6-DISCONNECT: Interface BRI0:1 disconnected from 6106
Spicey, call lasted 149 seconds
```

```
01:24:02: %LINK-3-UPDOWN: Interface BRI0:1, changed state to down
```

```
01:24:03: %LINEPROTO-5-UPDOWN: Line protocol on Interface BRI0:1,
changed state to down
```

```
Aton#show frame map
```

```
Serial1.1 (down): point-to-point dlci, dlci 160(0xA0,0x2800), broadcast
status deleted
```

```
Aton#
```

```
01:26:35: %LINK-3-UPDOWN: Interface Serial1, changed state to up
```

```
01:26:36: %LINEPROTO-5-UPDOWN: Line protocol on Interface Serial1,
changed state to up
```

```
01:26:56: %ISDN-6-LAYER2DOWN: Layer 2 for Interface BRI0, TEI 64 changed
to down
```

```
01:26:56: %ISDN-6-LAYER2DOWN: Layer 2 for Interface BR0, TEI 64 changed
to down
```

```
01:26:56: %LINK-5-CHANGED: Interface BRI0, changed state to standby mode
```

```
01:26:56: %LINK-3-UPDOWN: Interface BRI0:1, changed state to down
```

```
01:26:56: %LINK-3-UPDOWN: Interface BRI0:2, changed state to down
```

```
Aton#show frame map
```

```
Serial1.1 (up): point-to-point dlci, dlci 160(0xA0,0x2800), broadcast
status defined, active
```

```
Aton#ping 124.124.124.1
```

```
Type escape sequence to abort.
```

```
Sending 5, 100-byte ICMP Echos to 124.124.124.1, timeout is 2 seconds:
```

```
!!!!!
```

```
Success rate is 100 percent (5/5), round-trip min/avg/max = 36/36/36 ms
```

```
Aton#ping 124.124.124.1
```

```
Aton#show frame-relay pvc
```

```
PVC Statistics for interface Serial1 (Frame Relay DTE)
```

	Active	Inactive	Deleted	Static
Local	1	0	0	0

```
Switched      0          0          0          0
Unused        0          0          0          0
```

```
DLCI = 160, DLCI USAGE = LOCAL, PVC STATUS = ACTIVE, INTERFACE =
Serial1.1
  input pkts 60          output pkts 69          in    bytes 9694
  out bytes 10811       dropped pkts 0          in    FECN pkts 0
  in BECN pkts 0       out FECN pkts 0        out BECN pkts 0
  in DE pkts 0         out DE pkts 0
  out bcast pkts 44    out    bcast bytes 7565
  pvc create time 01:28:35, last time pvc status changed 00:02:19
```

## 斯皮塞

### Spicey#show frame-relay map

```
Serial0.1 (up): point-to-point dlci, dlci 140(0x8C,0x20C0), broadcast
  status defined, active
Serial0.2 (up): point-to-point dlci, dlci 130(0x82,0x2020), broadcast
  status defined, active
```

### Spicey#ping 122.122.122.1

```
Type escape sequence to abort.
Sending 5, 100-byte ICMP Echos to 122.122.122.1, timeout is 2 seconds:
!!!!
Success rate is 100 percent (5/5), round-trip min/avg/max = 32/35/36 ms
```

### Spicey#ping 123.123.123.1

```
Type escape sequence to abort.
Sending 5, 100-byte ICMP Echos to 123.123.123.1, timeout is 2 seconds:
!!!!
Success rate is 100 percent (5/5), round-trip min/avg/max = 36/36/36 ms
```

### Spicey#show ip route

```
Codes: C - connected, S - static, I - IGRP, R - RIP, M - mobile, B - BGP
       D - EIGRP, EX - EIGRP external, O - OSPF, IA - OSPF inter area
       N1 - OSPF NSSA external type 1, N2 - OSPF NSSA external type 2
       E1 - OSPF external type 1, E2 - OSPF external type 2, E - EGP
       i - IS-IS, L1 - IS-IS level-1, L2 - IS-IS level-2, ia - IS-IS
inter area
       * - candidate default, U - per-user static route, o - ODR
       P - periodic downloaded static route
Gateway of last resort is not set
 155.155.0.0/24 is subnetted, 1 subnets
C    155.155.155.0 is directly connected, Dialer2
 3.0.0.0/24 is subnetted, 1 subnets
C    3.1.3.0 is directly connected, Serial0.2
 4.0.0.0/24 is subnetted, 1 subnets
C    4.0.1.0 is directly connected, Serial0.1
 160.160.0.0/24 is subnetted, 1 subnets
C    160.160.160.0 is directly connected, Dialer1
 124.0.0.0/24 is subnetted, 1 subnets
C    124.124.124.0 is directly connected, Ethernet0
I    123.0.0.0/8 [100/8576] via 4.0.1.2, 00:00:55, Serial0.1
I    122.0.0.0/8 [100/8576] via 3.1.3.3, 00:00:35, Serial0.2
```

呼叫端的兩條串列線路都發生故障。

### Spicey#

```
*Mar 1 01:21:30.171: %LINK-3-UPDOWN: Interface BRI0:1, changed state toup
*Mar 1 01:21:30.627: %DIALER-6-BIND: Interface BR0:1 bound to profile Di2
*Mar 1 01:21:31.647: %LINEPROTO-5-UPDOWN: Line protocol on Interface
```

```

BRI0:1, changed state to up
*Mar 1 01:21:36.191: %ISDN-6-CONNECT: Interface BRI0:1 is now connected
to 6104 Aton
*Mar 1 01:21:40.923: %LINK-3-UPDOWN: Interface BRI0:2, changed state to up
*Mar 1 01:21:41.359: %DIALER-6-BIND: Interface BR0:2 bound to profile Di1
*Mar 1 01:21:42.383: %LINEPROTO-5-UPDOWN: Line protocol on Interface
BRI0:2, changed state to up
*Mar 1 01:21:46.943: %ISDN-6-CONNECT: Interface BRI0:2 is now connected
to 6105 Prasit
*Mar 1 01:23:59.819: %DIALER-6-UNBIND: Interface BR0:1 unbound from
profile Di2
*Mar 1 01:23:59.831: %ISDN-6-DISCONNECT: Interface BRI0:1 disconnected
from 6104 Aton, call lasted 149 seconds
*Mar 1 01:23:59.927: %LINK-3-UPDOWN: Interface BRI0:1, changed state to down
*Mar 1 01:24:00.923: %LINEPROTO-5-UPDOWN: Line protocol on Interface
BRI0:1, changed state to down
*Mar 1 01:24:03.015: %DIALER-6-UNBIND: Interface BR0:2 unbound from
profile Di1
*Mar 1 01:24:03.023: %ISDN-6-DISCONNECT: Interface BRI0:2 disconnected
from 6105 Prasit, call lasted 142 seconds
*Mar 1 01:24:03.107: %LINK-3-UPDOWN: Interface BRI0:2, changed state to down
*Mar 1 01:24:04.107: %LINEPROTO-5-UPDOWN: Line protocol on Interface
BRI0:2, changed state to down

```

Spicey#**show frame map**

```

Serial0.1 (down): point-to-point dlci, dlci 140(0x8C,0x20C0), broadcast
status defined, inactive
Serial0.2 (down): point-to-point dlci, dlci 130(0x82,0x2020), broadcast
status defined, inactive

```

Spicey#

兩條串列線路都再次可用。

Spicey#**show frame pvc**

PVC Statistics for interface Serial0 (Frame Relay DTE)

	Active	Inactive	Deleted	Static
Local	2	0	0	0
Switched	0	0	0	0
Unused	0	0	0	0

DLCI = 130, DLCI USAGE = LOCAL, PVC STATUS = ACTIVE, INTERFACE = Serial0.2

```

input pkts 54          output pkts 61          in   bytes 7014
out bytes 9975         dropped pkts 3          in   FECN pkts 0
in BECN pkts 0        out FECN pkts 0        out BECN  pkts 0
in DE pkts 0          out DE pkts 0
out bcast pkts 40     out   bcast bytes 7803
pvc create time 01:28:14, last time pvc status changed 00:02:38

```

DLCI = 140, DLCI USAGE = LOCAL, PVC STATUS = ACTIVE, INTERFACE = Serial0.1

```

input pkts 56          output pkts 60          in   bytes 7604
out bytes 10114        dropped pkts 2          in   FECN pkts 0
in BECN pkts 0        out FECN pkts 0        out BECN  pkts 0
in DE pkts 0          out DE pkts 0
out bcast pkts 39     out   bcast bytes 7928
pvc create time 01:28:15, last time pvc status changed 00:02:29

```

[普拉西](#)

Prasit#**show frame-relay map**

Serial1.1 (up): point-to-point dlci, dlci 150(0x96,0x2460), broadcast  
status defined, active

Prasit#**ping 124.124.124.1**

Type escape sequence to abort.

Sending 5, 100-byte ICMP Echos to 124.124.124.1, timeout is 2 seconds:

!!!!

Success rate is 100 percent (5/5), round-trip min/avg/max = 36/36/40 ms

Prasit#**show ip route**

Codes: C - connected, S - static, I - IGRP, R - RIP, M - mobile, B - BGP  
D - EIGRP, EX - EIGRP external, O - OSPF, IA - OSPF inter area  
N1 - OSPF NSSA external type 1, N2 - OSPF NSSA external type 2  
E1 - OSPF external type 1, E2 - OSPF external type 2, E - EGP  
i - IS-IS, L1 - IS-IS level-1, L2 - IS-IS level-2, ia - IS-IS  
inter area  
\* - candidate default, U - per-user static route, o - ODR  
P - periodic downloaded static route

Gateway of last resort is not set

I 155.155.0.0/16 [100/182571] via 4.0.1.1, 00:00:41, Serial1.1  
I 3.0.0.0/8 [100/10476] via 4.0.1.1, 00:00:41, Serial1.1  
4.0.0.0/24 is subnetted, 1 subnets  
C 4.0.1.0 is directly connected, Serial1.1  
I 160.160.0.0/16 [100/182571] via 4.0.1.1, 00:00:41, Serial1.1  
124.0.0.0/8 is variably subnetted, 2 subnets, 2 masks  
S 124.124.124.0/24 [250/0] via 160.160.160.1  
I 124.0.0.0/8 [100/8576] via 4.0.1.1, 00:00:41, Serial1.1  
123.0.0.0/24 is subnetted, 1 subnets  
C 123.123.123.0 is directly connected, Ethernet0  
I 122.0.0.0/8 [100/10576] via 4.0.1.1, 00:00:42, Serial1.1

Prasit#

**序列1關閉。**

Prasit#

\*Mar 1 01:16:08.287: %LINK-3-UPDOWN: Interface Serial1, changed state to down  
\*Mar 1 01:16:09.287: %LINEPROTO-5-UPDOWN: Line protocol on Interface  
Serial1, changed state to down  
\*Mar 1 01:16:11.803: %LINK-3-UPDOWN: Interface BRI0:1, changed state to down  
\*Mar 1 01:16:11.819: %LINK-3-UPDOWN: Interface BRI0:2, changed state to down  
\*Mar 1 01:16:11.855: %LINK-3-UPDOWN: Interface BRI0, changed state to up  
\*Mar 1 01:16:15.967: %ISDN-6-LAYER2UP: Layer 2 for Interface BR0, TEI  
64 changed to up

Prasit#**show ip route**

Codes: C - connected, S - static, I - IGRP, R - RIP, M - mobile, B - BGP  
D - EIGRP, EX - EIGRP external, O - OSPF, IA - OSPF inter area  
N1 - OSPF NSSA external type 1, N2 - OSPF NSSA external type 2  
E1 - OSPF external type 1, E2 - OSPF external type 2, E - EGP  
i - IS-IS, L1 - IS-IS level-1, L2 - IS-IS level-2, ia - IS-IS  
inter area  
\* - candidate default, U - per-user static route, o - ODR  
P - periodic downloaded static route

Gateway of last resort is not set

160.160.0.0/24 is subnetted, 1 subnets  
C 160.160.160.0 is directly connected, BRI0  
124.0.0.0/24 is subnetted, 1 subnets  
S 124.124.124.0 [250/0] via 160.160.160.1

```
123.0.0.0/24 is subnetted, 1 subnets
C 123.123.123.0 is directly connected, Ethernet0
```

```
Prasit#ping 124.124.124.1
```

```
Type escape sequence to abort.
```

```
Sending 5, 100-byte ICMP Echos to 124.124.124.1, timeout is 2 seconds:
```

```
*Mar 1 01:21:38.967: %LINK-3-UPDOWN: Interface BRI0:1, changed state to up!!!!
```

```
Success rate is 80 percent (4/5), round-trip min/avg/max = 36/36/36 ms
```

```
Prasit#
```

```
*Mar 1 01:21:40.063: %LINEPROTO-5-UPDOWN: Line protocol on Interface BRI0:1, changed state to up
```

```
*Mar 1 01:21:44.991: %ISDN-6-CONNECT: Interface BRI0:1 is now connected to 6106 Spicey
```

```
Prasit#ping 124.124.124.1
```

```
Type escape sequence to abort.
```

```
Sending 5, 100-byte ICMP Echos to 124.124.124.1, timeout is 2 seconds:
```

```
!!!!!
```

```
Success rate is 100 percent (5/5), round-trip min/avg/max = 36/36/36 ms
```

```
Prasit#
```

序列1再次變為活動狀態。

```
Prasit#
```

```
*Mar 1 01:26:40.579: %LINK-3-UPDOWN: Interface Serial1, changed state to up
```

```
*Mar 1 01:26:41.579: %LINEPROTO-5-UPDOWN: Line protocol on Interface Serial1, changed state to up
```

```
*Mar 1 01:27:01.051: %ISDN-6-LAYER2DOWN: Layer 2 for Interface BRI0, TEI 64 changed to down
```

```
*Mar 1 01:27:01.055: %ISDN-6-LAYER2DOWN: Layer 2 for Interface BR0, TEI 64 changed to down
```

```
*Mar 1 01:27:01.363: %LINK-5-CHANGED: Interface BRI0, changed state to standby mode
```

```
*Mar 1 01:27:01.379: %LINK-3-UPDOWN: Interface BRI0:1, changed state to down
```

```
*Mar 1 01:27:01.395: %LINK-3-UPDOWN: Interface BRI0:2, changed state to down
```

```
Prasit#show frame map
```

```
Serial1.1 (up): point-to-point dlci, dlci 150(0x96,0x2460), broadcast status defined, active
```

```
Prasit#ping 124.124.124.1
```

```
Type escape sequence to abort.
```

```
Sending 5, 100-byte ICMP Echos to 124.124.124.1, timeout is 2 seconds:
```

```
!!!!!
```

```
Success rate is 100 percent (5/5), round-trip min/avg/max = 36/116/432 ms
```

```
Prasit#show frame-relay pvc
```

```
PVC Statistics for interface Serial1 (Frame Relay DTE)
```

	Active	Inactive	Deleted	Static
Local	1	0	0	0
Switched	0	0	0	0
Unused	0	0	0	0

```
DLCI = 150, DLCI USAGE = LOCAL, PVC STATUS = ACTIVE, INTERFACE = Serial1.1
```

input pkts 58	output pkts 66	in bytes 9727
out bytes 10022	dropped pkts 0	in FECN pkts 0



```
in BECN pkts 0          out FECN pkts 0          out BECN   pkts 0
in DE pkts 0           out DE pkts 0
out bcast pkts 46      out   bcast bytes 7942
pvc create time 01:27:37, last time pvc status changed 00:01:59
```

## 配置幀中繼交換

訊框中繼交換是根據資料連結連線識別碼(DLCI)來交換封包的一種方式。我們可以將其視為介質訪問控制(MAC)地址的幀中繼等價地址。通過將思科路由器或接入伺服器配置為幀中繼網路來執行交換。幀中繼網路包含兩個部分：

- 幀中繼資料終端裝置(DTE) — 路由器或接入伺服器。
- 訊框中繼資料電路終端裝置(DCE)交換器。

**附註：** 在Cisco IOS軟體版本12.1(2)T和更新版本中，**frame route**命令已替換為**connect**命令。

我們來看一個配置示例。在下面的配置中，我們將路由器America用作幀中繼交換機。我們使用Spicey作為中心路由器，Prasit和Aton作為分支路由器。我們將它們連線起來如下：

- Priset serial 1(s1)DTE連線到America serial 1/4(s1/4)DCE。
- Spicey serial 0(s0)DTE連線到America serial 1/5(s1/5)DCE。
- Aton serial 1(s1)DTE連線到America serial 3/4(s3/4)DCE。

## 網路圖表

本檔案根據以下組態：

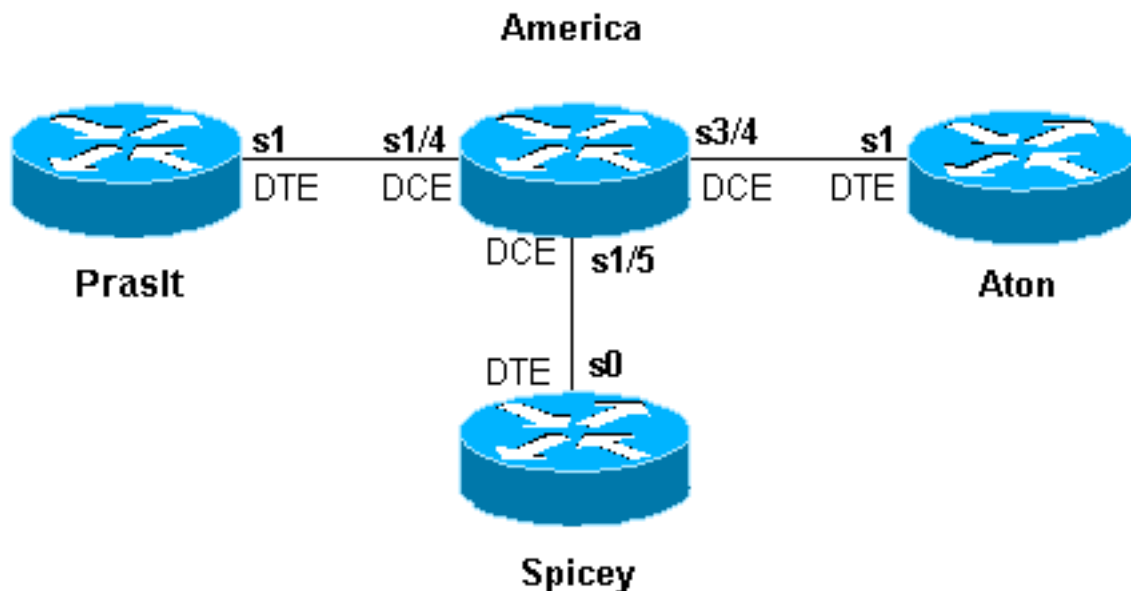

## 組態

- [斯皮塞](#)
- [普拉西](#)
- [阿頓](#)
- [美洲](#)

## 斯皮塞

```
Spicey#show running-config
Building configuration...

!
version 12.1
service timestamps debug datetime msec
service timestamps log datetime msec
no service password-encryption
!
hostname Spicey
!
!
!
interface Ethernet0
 ip address 124.124.124.1 255.255.255.0
!
interface Serial0
 ip address 3.1.3.1 255.255.255.0
 encapsulation frame-relay
 frame-relay interface-dlci 130
 frame-relay interface-dlci 140
!
!
router rip
 network 3.0.0.0
 network 124.0.0.0
!
line con 0
!
exec-timeout 0 0
 transport input none
 line aux 0
 line vty 0 4
 login
!
end
```

## 普拉西

```
Prasit#show running-config
Building configuration...
Current configuration : 1499 bytes
!
 version 12.1
service timestamps debug datetime msec
service timestamps log datetime msec
no service password-encryption
!
hostname Prasit
!
!
!
interface Ethernet0
 ip address 123.123.123.1 255.255.255.0
!
interface Serial1
 ip address 3.1.3.2 255.255.255.0
 encapsulation frame-relay
 frame-relay interface-dlci 150
!
!
```

```
router rip
 network 3.0.0.0
 network 123.0.0.0
!
!
line con 0
 exec-timeout 0 0
 transport input none
line aux 0
line vty 0 4
 login
!
end
```

## 阿頓

```
Aton#show running-config
Building configuration...
Current configuration:
!
version 12.0
service timestamps debug uptime
service timestamps log uptime
no service password-encryption
!
hostname Aton
!
!
!
interface Ethernet0
 ip address 122.122.122.1 255.255.255.0
!
interface Serial1
 ip address 3.1.3.3 255.255.255.0
 encapsulation frame-relay
 frame-relay interface-dlci 160
!
router rip
 network 3.0.0.0
 network 122.0.0.0
!
!
line con 0
 exec-timeout 0 0
 transport input none
line aux 0
line vty 0 4
 login
!
end
```

## 美洲

```
america#show running-config
Building configuration...
Current configuration:
!
!
service timestamps debug datetime msec
service timestamps log datetime msec
no service password-encryption
!
hostname america
```

```

!
frame-relay switching
!
!
interface Serial1/4
  description *** static DCE connection to s1 Prasit
  no ip address
  encapsulation frame-relay
  clockrate 2000000
  frame-relay intf-type dce
  frame-relay route 150 interface Serial1/5 140
!
interface Serial1/5
  description *** static DCE connection to s0 spicy
  no ip address
  encapsulation frame-relay
  bandwidth 1000000
  tx-queue-limit 100
  frame-relay intf-type dce
  frame-relay route 130 interface Serial3/4 160
  frame-relay route 140 interface Serial1/4 150
  transmitter-delay 10
!
interface Serial3/4
  description *** static DCE connection to s1 Aton
  encapsulation frame-relay
  no ip mroute-cache
  clockrate 2000000
  frame-relay intf-type dce
  frame-relay route 160 interface Serial1/5 130
!

```

## show命令

使用以下show命令測試網路是否正常運行：

- **show frame-relay map**
- **show frame-relay pvc**

以下輸出是在此示例配置中使用的裝置上輸入這些命令的結果。

## 斯皮塞

Spicey#**show frame-relay map**

```

Serial0 (up): ip 3.1.3.2 dlci 140(0x8C,0x20C0), dynamic,
              broadcast,, status defined, active
Serial0 (up): ip 3.1.3.3 dlci 130(0x82,0x2020), dynamic,
              broadcast,, status defined, active

```

Spicey#**show frame-relay pvc**

PVC Statistics for interface Serial0 (Frame Relay DTE)

	Active	Inactive	Deleted	Static
Local	2	0	0	0
Switched	0	0	0	0
Unused	0	0	0	0

DLCI = 130, DLCI USAGE = LOCAL, PVC STATUS = ACTIVE, INTERFACE = Serial0

```
input pkts 32          output pkts 40          in bytes 3370
out bytes 3928        dropped pkts 0          in FECN pkts 0
in BECN pkts 0       out FECN pkts 0        out BECN pkts 0
in DE pkts 0         out DE pkts 0
out bcast pkts 30    out bcast bytes 2888
pvc create time 00:15:46, last time pvc status changed 00:10:42
```

DLCI = 140, DLCI USAGE = LOCAL, PVC STATUS = ACTIVE, INTERFACE = Serial0

```
input pkts 282        output pkts 291        in bytes 25070
out bytes 27876      dropped pkts 0          in FECN pkts 0
in BECN pkts 0       out FECN pkts 0        out BECN pkts 0
in DE pkts 0         out DE pkts 0
out bcast pkts 223   out bcast bytes 20884
pvc create time 02:28:36, last time pvc status changed 02:25:14
```

## 普拉西

Prasit#**show frame-relay map**

```
Serial1 (up): ip 3.1.3.1 dlci 150(0x96,0x2460), dynamic,
                broadcast,, status defined, active
```

Prasit#show frame-relay pvc

PVC Statistics for interface Serial1 (Frame Relay DTE)

	Active	Inactive	Deleted	Static
Local	1	0	0	0
Switched	0	0	0	0
Unused	0	0	0	0

DLCI = 150, DLCI USAGE = LOCAL, PVC STATUS = ACTIVE, INTERFACE = Serial1

```
input pkts 311        output pkts 233        in bytes 28562
out bytes 22648      dropped pkts 0          in FECN pkts 0
in BECN pkts 0       out FECN pkts 0        out BECN pkts 0
in DE pkts 0         out DE pkts 0
out bcast pkts 162   out bcast bytes 15748
pvc create time 02:31:39, last time pvc status changed 02:25:14
```

## 阿頓

Aton#**show frame-relay map**

```
Serial1 (up): ip 3.1.3.1 dlci 160(0xA0,0x2800), dynamic, broadcast, status defined, active
```

Aton#**show frame-relay pvc**

PVC Statistics for interface Serial1 (Frame Relay DTE)

	Active	Inactive	Deleted	Static
Local	1	0	0	0
Switched	0	0	0	0
Unused	0	0	0	0

DLCI = 160, DLCI USAGE = LOCAL, PVC STATUS = ACTIVE, INTERFACE = Serial

```
input pkts 35          output pkts 32          in bytes 3758
out bytes 3366        dropped pkts 0          in FECN pkt 0
in BECN pkts 0       out FECN pkts 0        out BECN pkts 0
in DE pkts 0         out DE pkts 0
out bcast pkts 27 out bcast bytes 2846
pvc create time 00:10:53, last time pvc status changed 00:10:53
```

## 配置幀中繼DLCI優先順序

資料鏈路連線識別符號(DLCI)優先順序是一個過程，通過此過程，不同的流量型別被置於不同的 DLCI 上，以便幀中繼網路可以為每種流量型別提供不同的承諾資訊速率。它可以與自定義隊列或優

先順序隊列結合使用，提供對幀中繼網路的接入鏈路的頻寬管理控制。此外，一些幀中繼服務提供商和幀中繼交換機（如Stratacom網際網路資料包交換[IPX]、IGX和BPX或AXIS交換機）實際上根據此優先順序設定在幀中繼雲中提供優先順序。

## 實施注意事項

實施DLCI優先順序時，請注意以下幾點：

- 如果輔助DLCI關閉，則只會丟失發往該隊列的流量。
- 如果丟失主DLCI，則子介面會關閉，並且會丟失所有流量。

## 網路圖表

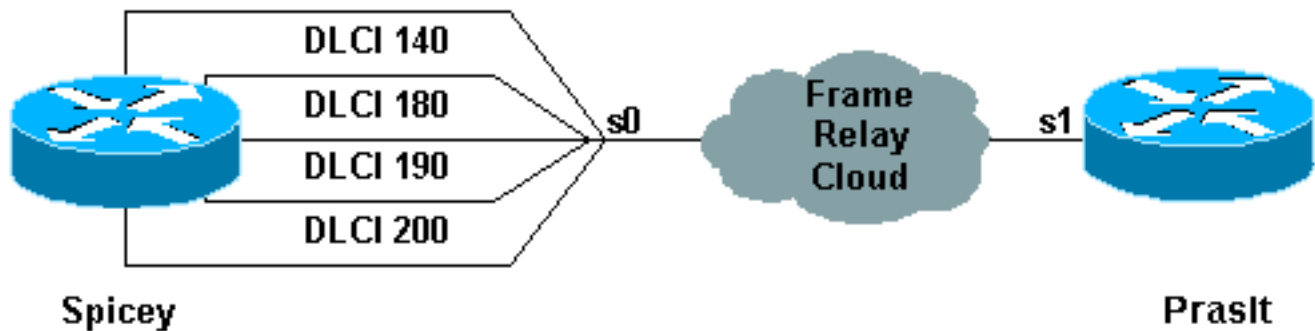

要使用此設定，您需要為使用DLCI優先順序的端提供四個DLCI。在本例中，我們將Spicey配置為優先順序隊列，如下所示：

- Ping在高優先順序隊列中。
- Telnet位於中等優先順序隊列中。
- 檔案傳輸通訊協定(FTP)位於正常優先順序佇列中。
- 所有其他IP流量都在低優先順序隊列中。

**注意：**請確保將DLCI配置為與優先順序清單對應，否則系統將不會使用正確的隊列。

## 組態

- [斯皮塞](#)
- [普拉西](#)

### 斯皮塞

```
Spicey#show running-config
Building configuration...

Current configuration : 1955 bytes
!
version 12.1
service timestamps debug datetime msec
service timestamps log datetime msec
!
hostname Spicey
!
!
interface Ethernet0
```

```
ip address 124.124.124.1 255.255.255.0
!
interface Serial0
no ip address
encapsulation frame-relay
priority-group 1
!
interface Serial0.1 point-to-point
ip address 4.0.1.1 255.255.255.0
frame-relay priority-dlci-group 1 140 180 190 200
frame-relay interface-dlci 140
!
router igrp 2
network 4.0.0.0
network 124.0.0.0
!
access-list 102 permit icmp any any
priority-list 1 protocol ip high list 102
priority-list 1 protocol ip medium tcp telnet
priority-list 1 protocol ip normal tcp ftp
priority-list 1 protocol ip low
!
line con 0
exec-timeout 0 0
transport input none
line aux 0
line vty 0 4
login
!
end
```

## 普拉西

```
Prasit#show running-config
Building configuration...

!
version 12.1
service timestamps debug datetime msec
service timestamps log datetime msec
!
hostname Prasit
!
!
!
interface Ethernet0
ip address 123.123.123.1 255.255.255.0
!
interface Serial1
ip address 4.0.1.2 255.255.255.0
encapsulation frame-relay
!
router igrp 2
network 4.0.0.0
network 123.0.0.0
!
line con 0
exec-timeout 0 0
transport input none
line aux 0
line vty 0 4
login
!
```

```
end
```

## debug和show命令

使用以下**show**和**debug**命令測試網路是否正常運行。發出 [debug](#) 指令之前，請先參閱有關 **Debug** 指令的重要資訊。

- **show frame-relay pvc**
- **show frame-relay map**
- 顯示佇列優先順序
- **debug priority**

以下輸出是在此示例配置中使用的裝置上輸入這些命令的結果。

## 斯皮塞

```
Spicey#show frame-relay pvc
```

```
PVC Statistics for interface Serial0 (Frame Relay DTE)
```

	Active	Inactive	Deleted	Static
Local	4	0	0	0
Switched	0	0	0	0
Unused	0	0	0	0

```
DLCI = 140, DLCI USAGE = LOCAL, PVC STATUS = ACTIVE, INTERFACE = Serial0.1
```

```
input pkts 106          output pkts 15          in bytes 6801
out bytes 1560          dropped pkts 0          in FECN pkts 0
in BECN pkts 0         out FECN pkts 0        out BECN pkts 0
in DE pkts 0           out DE pkts 0
out bcast pkts 0       out bcast bytes 0
pvc create time 00:29:22, last time pvc status changed 00:20:37
Priority DLCI Group 1, DLCI 140 (HIGH), DLCI 180 (MEDIUM)
DLCI 190 (NORMAL), DLCI 200 (LOW)
```

```
DLCI = 180, DLCI USAGE = LOCAL, PVC STATUS = ACTIVE, INTERFACE = Serial0.1
```

```
input pkts 0           output pkts 51          in bytes 0
out bytes 2434          dropped pkts 0          in FECN pkts 0
in BECN pkts 0         out FECN pkts 0        out BECN pkts 0
in DE pkts 0           out DE pkts 0
out bcast pkts 0       out bcast bytes 0
pvc create time 00:29:23, last time pvc status changed 00:14:48
```

```
DLCI = 190, DLCI USAGE = LOCAL, PVC STATUS = ACTIVE, INTERFACE = Serial0.1
```

```
input pkts 0           output pkts 13          in bytes 0
out bytes 3653          dropped pkts 0          in FECN pkts 0
in BECN pkts 0         out FECN pkts 0        out BECN pkts 0
in DE pkts 0           out DE pkts 0
out bcast pkts 13      out bcast bytes 3653
pvc create time 00:29:23, last time pvc status changed 00:14:28
```

```
DLCI = 200, DLCI USAGE = LOCAL, PVC STATUS = ACTIVE, INTERFACE = Serial0.1
```

```
input pkts 0           output pkts 42          in bytes 0
out bytes 2554          dropped pkts 0          in FECN pkts 0
in BECN pkts 0         out FECN pkts 0        out BECN pkts 0
in DE pkts 0           out DE pkts 0
```



```
out bcast pkts 10          out bcast bytes 500
pvc create time 00:29:24, last time pvc status changed 00:14:09
```

Spicey#**show frame-relay map**

```
Serial0.1 (up): point-to-point dlci, dlci 140(0x8C,0x20C0), broadcast
status defined, active
Priority DLCI Group 1, DLCI 140 (HIGH), DLCI 180 (MEDIUM)
DLCI 190 (NORMAL), DLCI 200 (LOW)
```

Spicey#**show queueing priority**

Current priority queue configuration:

```
List  Queue  Args
1     high   protocol ip          list 102
1     medium protocol ip          tcp port telnet
1     normal protocol ip          tcp port ftp
1     low    protocol ip
```

要驗證優先順序隊列，請使用**debug priority**命令。

Spicey#**debug priority**

Priority output queueing debugging is on

Spicey#**ping 123.123.123.1**

Type escape sequence to abort.

Sending 5, 100-byte ICMP Echos to 123.123.123.1, timeout is 2 seconds:

!!!!

Success rate is 100 percent (5/5), round-trip min/avg/max = 44/45/48 ms

Spicey#

```
*Mar 1 00:32:30.391: PQ: Serial0: ip (s=4.0.1.1, d=123.123.123.1) ->high
*Mar 1 00:32:30.395: PQ: Serial0: ip (s=4.0.1.1, d=123.123.123.1) ->high
*Mar 1 00:32:30.399: PQ: Serial0 output (Pk size/Q 104/0)
*Mar 1 00:32:30.439: PQ: Serial0: ip (s=4.0.1.1, d=123.123.123.1) ->high
*Mar 1 00:32:30.443: PQ: Serial0: ip (s=4.0.1.1, d=123.123.123.1) ->high
*Mar 1 00:32:30.447: PQ: Serial0 output (Pk size/Q 104/0)
*Mar 1 00:32:30.487: PQ: Serial0: ip (s=4.0.1.1, d=123.123.123.1) ->high
*Mar 1 00:32:30.491: PQ: Serial0: ip (s=4.0.1.1, d=123.123.123.1) ->high
*Mar 1 00:32:30.495: PQ: Serial0 output (Pk size/Q 104/0)
*Mar 1 00:32:30.535: PQ: Serial0: ip (s=4.0.1.1, d=123.123.123.1) ->high
*Mar 1 00:32:30.539: PQ: Serial0: ip (s=4.0.1.1, d=123.123.123.1) ->high
*Mar 1 00:32:30.543: PQ: Serial0 output (Pk size/Q 104/0)
*Mar 1 00:32:30.583: PQ: Serial0: ip (s=4.0.1.1, d=123.123.123.1) ->high
*Mar 1 00:32:30.587: PQ: Serial0: ip (s=4.0.1.1, d=123.123.123.1) ->high
*Mar 1 00:32:30.587: PQ: Serial0 output (Pk size/Q 104/0)Spicey#
```

Spicey#**telnet 123.123.123.1**

Trying 123.123.123.1 ... Open

User Access Verification

Password:

```
*Mar 1 00:32:59.447: PQ: Serial0: ip (tcp 23) -> medium
*Mar 1 00:32:59.451: PQ: Serial0: ip (tcp 23) -> medium
*Mar 1 00:32:59.451: PQ: Serial0 output (Pk size/Q 48/1)
*Mar 1 00:32:59.475: PQ: Serial0: ip (tcp 23) -> medium
*Mar 1 00:32:59.479: PQ: Serial0: ip (tcp 23) -> medium
*Mar 1 00:32:59.483: PQ: Serial0 output (Pk size/Q 44/1)
*Mar 1 00:32:59.487: PQ: Serial0: ip (tcp 23) -> medium
*Mar 1 00:32:59.487: PQ: Serial0: ip (tcp 23) -> medium
*Mar 1 00:32:59.491: PQ: Serial0 output (Pk size/Q 53/1)
*Mar 1 00:32:59.495: PQ: Serial0: ip (tcp 23) -> medium
*Mar 1 00:32:59.499: PQ: Serial0: ip (tcp 23) -> medium
```

```
*Mar 1 00:32:59.499: PQ: Serial0 output (Pk size/Q 44/1)
*Mar 1 00:32:59.511: PQ: Serial0: ip (tcp 23) -> medium
*Mar 1 00:32:59.511: PQ: Serial0: ip (tcp 23) -> medium
*Mar 1 00:32:59.515: PQ: Serial0 output (Pk size/Q 47/1)
*Mar 1 00:32:59.519: PQ: Serial0: ip (tcp 23) -> medium
*Mar 1 00:32:59.519: PQ: Serial0: ip (tcp 23) -> medium
*Mar 1 00:32:59.523: PQ: Serial0 output (Pk size/Q 47/1)
*Mar 1 00:32:59.527: PQ: Serial0: ip (tcp 23) -> medium
*Mar 1 00:32:59.527: PQ: Serial0: ip (tcp 23) -> medium
*Mar 1 00:32:59.531: PQ: Serial0 output (Pk size/Q 53/1)
*Mar 1 00:32:59.539: PQ: Serial0: ip (tcp 23) -> medium
*Mar 1 00:32:59.543: PQ: Serial0: ip (tcp 23) -> medium
*Mar 1 00:32:59.547: PQ: Serial0 output (Pk size/Q 47/1)
*Mar 1 00:32:59.751: PQ: Serial0: ip (tcp 23) -> medium
*Mar 1 00:32:59.755: PQ: Serial0: ip (tcp 23) -> medium
*Mar 1 00:32:59.755: PQ: Serial0 output (Pk size/Q 44/1)
```

Password:

其他IP流量通過低隊列。

Spicey#

```
*Mar 1 00:53:57.079: PQ: Serial0 output (Pk size/Q 13/0)
*Mar 1 00:53:58.851: PQ: Serial0: ip -> low
*Mar 1 00:53:58.907: PQ: Serial0: ip -> low
*Mar 1 00:53:58.907: PQ: Serial0 output (Pk size/Q 36/3)
*Mar 1 00:53:59.459: PQ: Serial0: ip -> low
*Mar 1 00:53:59.463: PQ: Serial0: ip -> low
*Mar 1 00:53:59.463: PQ: Serial0 output (Pk size/Q 50/3)
```

Spicey#

[普拉西](#)

Prasit#**show frame-relay pvc**

PVC Statistics for interface Serial1 (Frame Relay DTE)

	Active	Inactive	Deleted	Static
Local	1	0	0	0
Switched	0	0	0	0
Unused	0	0	0	0

DLCI = 150, DLCI USAGE = LOCAL, PVC STATUS = ACTIVE, INTERFACE = Serial1

```
input pkts 134          output pkts 119          in bytes 12029
out bytes 7801          dropped pkts 0           in FECN pkts 0
in BECN pkts 0         out FECN pkts 0         out BECN pkts 0
in DE pkts 0           out DE pkts 0
out bcast pkts 18      out bcast bytes 1260
pvc create time 00:21:15, last time pvc status changed 00:21:15
```

Prasit#**show frame-relay map**

```
Serial1 (up): ip 4.0.1.1 dlci 150(0x96,0x2460), dynamic,
              broadcast, status defined, active
```

Prasit#**ping 124.124.124.1**

Type escape sequence to abort.

Sending 5, 100-byte ICMP Echos to 124.124.124.1, timeout is 2 seconds:

!!!!

Success rate is 100 percent (5/5), round-trip min/avg/max = 44/45/48

Here is the debug output shown on Spicey when you use the command above to **ping** to Spicey from Prasit.

```
Spicey#
*Mar 1 00:33:26.755: PQ: Serial0 output (Pk size/Q 13/0)
*Mar 1 00:33:28.535: PQ: Serial0: ip (s=124.124.124.1, d=4.0.1.2) ->high
*Mar 1 00:33:28.539: PQ: Serial0: ip (s=124.124.124.1, d=4.0.1.2) ->high
*Mar 1 00:33:28.543: PQ: Serial0 output (Pk size/Q 104/0)
*Mar 1 00:33:28.583: PQ: Serial0: ip (s=124.124.124.1, d=4.0.1.2) ->high
*Mar 1 00:33:28.587: PQ: Serial0: ip (s=124.124.124.1, d=4.0.1.2) ->high
*Mar 1 00:33:28.587: PQ: Serial0 output (Pk size/Q 104/0)
*Mar 1 00:33:28.631: PQ: Serial0: ip (s=124.124.124.1, d=4.0.1.2) ->high
*Mar 1 00:33:28.635: PQ: Serial0: ip (s=124.124.124.1, d=4.0.1.2) ->high
*Mar 1 00:33:28.635: PQ: Serial0 output (Pk size/Q 104/0)
*Mar 1 00:33:28.679: PQ: Serial0: ip (s=124.124.124.1, d=4.0.1.2) ->high
*Mar 1 00:33:28.683: PQ: Serial0: ip (s=124.124.124.1, d=4.0.1.2) ->high
*Mar 1 00:33:28.683: PQ: Serial0 output (Pk size/Q 104/0)
*Mar 1 00:33:28.723: PQ: Serial0: ip (s=124.124.124.1, d=4.0.1.2) ->high
*Mar 1 00:33:28.727: PQ: Serial0: ip (s=124.124.124.1, d=4.0.1.2) ->high
*Mar 1 00:33:28.731: PQ: Serial0 output (Pk size/Q 104/0)
```

```
Prasit#telnet 124.124.124.1
Trying 124.124.124.1 ... Open
```

```
User Access Verification
Password:
Spicey>exit
```

```
[Connection to 124.124.124.1 closed by foreign host]
Prasit#
```

以下是當您使用上面的命令從Prasit遠端登入到Spicey時，在Spicey上顯示的調試輸出。

```
Spicey#
*Mar 1 00:33:54.499: PQ: Serial0: ip (tcp 23) -> medium
*Mar 1 00:33:54.499: PQ: Serial0: ip (tcp 23) -> medium
*Mar 1 00:33:54.503: PQ: Serial0 output (Pk size/Q 48/1)
*Mar 1 00:33:54.527: PQ: Serial0: ip (tcp 23) -> medium
*Mar 1 00:33:54.531: PQ: Serial0: ip (tcp 23) -> medium
*Mar 1 00:33:54.531: PQ: Serial0 output (Pk size/Q 56/1)
*Mar 1 00:33:54.547: PQ: Serial0: ip (tcp 23) -> medium
*Mar 1 00:33:54.551: PQ: Serial0: ip (tcp 23) -> medium
*Mar 1 00:33:54.555: PQ: Serial0 output (Pk size/Q 86/1)
*Mar 1 00:33:54.559: PQ: Serial0: ip (tcp 23) -> medium
*Mar 1 00:33:54.563: PQ: Serial0: ip (tcp 23) -> medium
*Mar 1 00:33:54.563: PQ: Serial0 output (Pk size/Q 47/1)
*Mar 1 00:33:54.571: PQ: Serial0: ip (tcp 23) -> medium
*Mar 1 00:33:54.575: PQ: Serial0: ip (tcp 23) -> medium
*Mar 1 00:33:54.575: PQ: Serial0 output (Pk size/Q 47/1)
*Mar 1 00:33:54.779: PQ: Serial0: ip (tcp 23) -> medium
*Mar 1 00:33:54.783: PQ: Serial0: ip (tcp 23) -> medium
*Mar 1 00:33:54.783: PQ: Serial0 output (Pk size/Q 44/1)
*Mar 1 00:33:56.755: PQ: Serial0 output (Pk size/Q 13/0)
*Mar 1 00:33:57.143: PQ: Serial0: ip (tcp 23) -> medium
*Mar 1 00:33:57.143: PQ: Serial0: ip (tcp 23) -> medium
*Mar 1 00:33:57.147: PQ: Serial0 output (Pk size/Q 44/1)
*Mar 1 00:33:57.447: PQ: Serial0: ip (tcp 23) -> medium
*Mar 1 00:33:57.447: PQ: Serial0: ip (tcp 23) -> medium
*Mar 1 00:33:57.451: PQ: Serial0 output (Pk size/Q 44/1)
*Mar 1 00:33:57.899: PQ: Serial0: ip (tcp 23) -> medium
*Mar 1 00:33:57.899: PQ: Serial0: ip (tcp 23) -> medium
*Mar 1 00:33:57.903: PQ: Serial0 output (Pk size/Q 53/1)
*Mar 1 00:33:59.491: PQ: Serial0: ip (tcp 23) -> medium
*Mar 1 00:33:59.495: PQ: Serial0: ip (tcp 23) -> medium
*Mar 1 00:33:59.495: PQ: Serial0 output (Pk size/Q 45/1)
```

```
*Mar 1 00:33:59.711: PQ: Serial0: ip (tcp 23) -> medium
*Mar 1 00:33:59.715: PQ: Serial0: ip (tcp 23) -> medium
*Mar 1 00:33:59.715: PQ: Serial0 output (Pk size/Q 45/1)
*Mar 1 00:33:59.951: PQ: Serial0: ip (tcp 23) -> medium
*Mar 1 00:33:59.951: PQ: Serial0: ip (tcp 23) -> medium
*Mar 1 00:33:59.955: PQ: Serial0 output (Pk size/Q 45/1)
*Mar 1 00:34:00.123: PQ: Serial0: ip (tcp 23) -> medium
*Mar 1 00:34:00.123: PQ: Serial0: ip (tcp 23) -> medium
*Mar 1 00:34:00.127: PQ: Serial0 output (Pk size/Q 45/1)
*Mar 1 00:34:00.327: PQ: Serial0: ip (tcp 23) -> medium
*Mar 1 00:34:00.327: PQ: Serial0: ip (tcp 23) -> medium
*Mar 1 00:34:00.331: PQ: Serial0 output (Pk size/Q 46/1)
*Mar 1 00:34:00.495: PQ: Serial0: ip (tcp 23) -> medium
*Mar 1 00:34:00.499: PQ: Serial0: ip (tcp 23) -> medium
*Mar 1 00:34:00.499: PQ: Serial0 output (Pk size/Q 44/1)
*Mar 1 00:34:00.543: PQ: Serial0: ip (tcp 23) -> medium
*Mar 1 00:34:00.543: PQ: Serial0: ip (tcp 23) -> medium
*Mar 1 00:34:00.547: PQ: Serial0 output (Pk size/Q 44/1)
```

## 訊框中繼廣播佇列

廣播佇列是大中型的IP或IPX網路中使用的一項主要功能，在這些網路中，路由和服務接入點(SAP)廣播必須流經中繼網路。廣播佇列獨立於普通介面佇列進行管理，具有自己的緩衝區，並具有可配置的大小和服務速率。由於時間敏感性，此廣播佇列不用於橋接跨距樹狀目錄更新(BPDU)。這些資料包將通過正常佇列。用於啟用廣播佇列的介面命令如下：

### frame-relay broadcast-queue size byte-rate packet-rate

為廣播佇列提供最大傳輸速率（吞吐量）限制，以每秒位元組數和每秒資料包數度量。對佇列進行服務以確保僅提供此最大值。廣播佇列在低於配置的最大速率傳輸時具有優先順序，因此具有保證的最小頻寬分配。兩個傳輸速率限制旨在避免廣播泛洪介面。任何秒的實際限制是達到的第一個速率限制。給定傳輸速率限制，需要額外的緩衝來儲存廣播資料包。廣播佇列可配置為儲存大量廣播資料包。應設定佇列大小以避免丟失廣播路由更新資料包。確切大小取決於使用的協定以及每次更新所需的資料包數。為了安全起見，應設定佇列大小，以便可以儲存每個協定和每個資料鏈路連線識別符號(DLCI)的完整路由更新。通常，從每個DLCI的20個資料包開始。位元組速率應小於以下兩者：

- N/4倍於最小遠端訪問速率（以每秒位元組數度量），其中N是廣播必須複製到的DLCI數
- 1/4本地訪問速率（以每秒位元組數度量）

如果以保守方式設定位元組速率，則資料包速率並不關鍵。一般情況下，應假設250位元組的封包來設定封包速率。串列介面的預設值為64佇列大小、256,000位元組/秒(2,048,000 bps)和36 pps。高速串列介面(HSSI)的預設值是256佇列大小、1,024,000位元組/秒(8,192,000 bps)和144 pps。

## 流量調節

流量整形使用稱為令牌桶過濾器的速率控制機制。此令牌桶過濾器設定如下：

### 超額突發和承諾突發量(Bc + Be)=虛擬電路的最大速度(VC)

在流量整形佇列中緩衝超過最大速度的流量，該流量整形佇列等於加權公平佇列(WFQ)的大小。令牌桶過濾器不過濾流量，但控制出站介面上傳送流量的速率。有關令牌桶過濾器的詳細資訊，請參閱[策略和整形概述](#)。

本檔案將概述通用流量整形和訊框中繼流量整形。

## 流量整形引數

我們可以使用以下流量整形引數：

- CIR = 承諾資訊速率 ( =平均時間 )
- EIR = 超額資訊速率
- TB = 令牌桶 (= Bc + Be)
- Bc = 承諾突發大小 ( =持續突發大小 )
- Be = 超額突發大小
- DE = 放棄資格
- Tc = 測量間隔
- AR = 與物理介面速率對應的訪問速率 ( 因此，如果使用T1，則AR大約為1.5 Mbps )。

讓我們更詳細地瞭解一下其中一些引數：

### 存取速率(AR)

終端站每秒可傳輸到網路的最大位數受使用者網路介面的訪問速率限制。使用者網路連線的線路速度限制了接入速率。您可以在對服務提供商的訂購中建立此功能。

### 承諾突發大小(Bc)

您可以向網路提供的最大承諾資料量定義為Bc。Bc是衡量網路在正常情況下保證報文傳送的資料量的指標。它在承諾速率Tc期間測量。

### 超額突發大小(Be)

幀中繼交換機仍接受但標籤為符合丟棄(DE)條件的非承諾位數 ( CIR之外 )。

令牌桶是「虛擬」緩衝區。它包含多個令牌，使您能夠按時間間隔傳送有限數量的資料。令牌桶中每Tc填充Bc位。桶的最大大小為Bc + Be。如果Be非常大，並且在T0時桶中充滿了Bc + Be令牌，則您可以按訪問速率傳送Bc + Be位。這不受Tc限制，而是受傳送Be所需的時間限制。這是存取速率的函式。

### 承諾資訊速率(CIR)

CIR是網路在正常情況下承諾傳輸的允許資料量。該速率是在時間Tc的增量上取平均值。CIR也稱為最小可接受吞吐量。Bc和Be以位表示，Tc以秒表示，訪問速率和CIR以位每秒表示。

Bc、Be、Tc和CIR按照資料鏈路連線識別符號(DLCI)定義。因此，令牌桶過濾器控制每個DLCI的速率。訪問速率對使用者網路介面有效。對於Bc，可以區分Be和CIR傳入和傳出值。如果連線是對稱的，則兩個方向的值相同。對於永久虛擬電路，我們定義在訂閱時間傳入和傳出Bc、Be和CIR。

- 峰值 = DLCI的最大速度。該特定DLCI的頻寬。
- $Tc = Bc / CIR$
- 峰值 =  $CIR + Be / Tc = CIR(1 + Be / Bc)$

如果Tc為一秒，則：

- 峰值 =  $CIR + Be = Bc + Be$
- $EIR = Be$

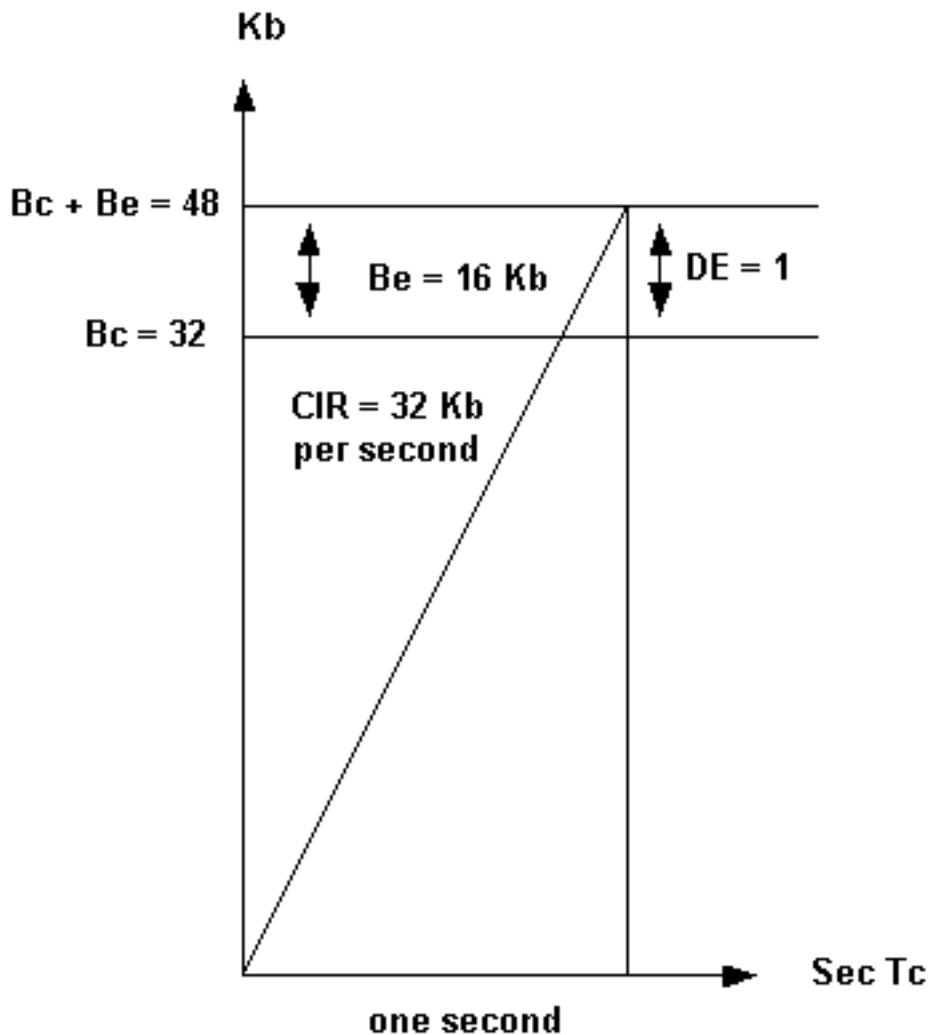

此處使用的範例中，路由器會根據網路中的擁塞情況，傳送48 Kbps和32 Kbps之間的流量。網路可能使用DE標籤Bc以上的幀，但具有足夠的備用容量來傳輸該幀。相反的情況也有可能發生：它們可以具有有限的容量，但會立即丟棄過多幀。網路可能使用DE標籤Bc + Be以上的幀，並可能傳輸它，或者按照國際電信聯盟電信標準化部門規範ITU-T I.370的建議丟棄幀。流量整形根據來自交換機網路的後向顯式擁塞通知(BECN)標籤的資料包來限制流量。如果您收到50%的BECN，路由器會將流量減少該特定DLCI當前傳輸頻寬的八分之一。

### 範例

傳輸速度為42 Kb。路由器將速度降低到42減42除以8(42 - 42/8)，即36.75 Kb。如果擁塞在變化之後減少，路由器會進一步減少流量，降低到當前傳輸頻寬的八分之一。流量會減少，直到達到設定的CIR值。但是，當我們仍然可以看到BECN時，速度可能會降低到CIR以下。您可以指定一個底限，例如CIR/2。當從網路接收的所有幀在給定的時間間隔內不再具有BECN位時，網路不再擁塞。200 ms是此間隔的預設值。

### 通用流量調節

通用流量整形功能是一種獨立於媒體和封裝的流量整形工具，當雲內、鏈路上或接收終端路由器上出現擁塞時，該工具可幫助減少出站流量。我們可以在路由器的介面或子介面上設定它。

通用流量整形在以下情況下非常有用：

- 如果您的網路拓撲由中心站點上的高速 ( T1線速 ) 連線和分支或遠端辦公站點上的低速 ( 小於 56 kbps ) 連線組成。由於速度不匹配，當中心站點以遠端站點可以接收的更快速率傳送資料時，分支或遠端站點上的流量通常存在瓶頸。這會導致遠端點路由器之前的最後一台交換機出現瓶頸。
- 如果您是提供子速率服務的服務提供商，此功能使您能夠使用路由器將T1或T3鏈路劃分成較小的通道。您可以使用與客戶訂購的服務相匹配的令牌篩選器桶配置每個子介面。

在幀中繼連線上，您可能希望路由器限制流量，而不是將其傳送到網路。限制流量將限制服務提供商雲中的資料包丟失。此功能提供的基於BECN的限制功能允許您讓路由器根據從網路接收的BECN標籤資料包動態限制流量。此限制將資料包儲存在路由器的緩衝區中，以減少從路由器到幀中繼網路的資料流。路由器會基於子介面限制流量，而且當收到的BECN標籤的封包較少時，速率也會增加。

## 通用流量整形命令

要定義速率控制，請使用以下命令：

```
traffic-shape rate bit-rate [burst-size [excess-burst-size]] [group access-list]
```

要限制幀中繼介面上的BECN，請使用以下命令：

```
traffic-shape adaptive [bit-rate]
```

要配置幀中繼子介面以估計接收BECN時的可用頻寬，請使用**traffic-shape adaptive**命令。

**注意：**必須先使用**traffic-shape rate**命令在介面上啟用流量調節，然後才能使用**traffic-shape adaptive**命令。

為**traffic-shape rate**命令指定的位元率是上限，為**traffic-shape adaptive**命令指定的位元率是介面接收BECN時對流量進行整形的下限 ( 通常是CIR值 )。實際使用的匯率通常介於這兩個匯率之間。您應該在鏈路兩端配置**traffic-shape adaptive**命令，因為它還在流端配置裝置將前向顯式擁塞通知 (FECN)訊號反映為BECN。這使得高速端路由器能夠檢測並適應擁塞，即使流量主要以一個方向流動也是如此。

## 範例

以下示例將介面0.1上的流量整形配置為上限 ( 通常為Bc + Be ) 為128 kbps，下限為64 kbps。這允許鏈路從64 kbps運行到128 kbps，具體取決於擁塞級別。如果中心側有一個256 kbps的上限，您應該使用最低的上限值。

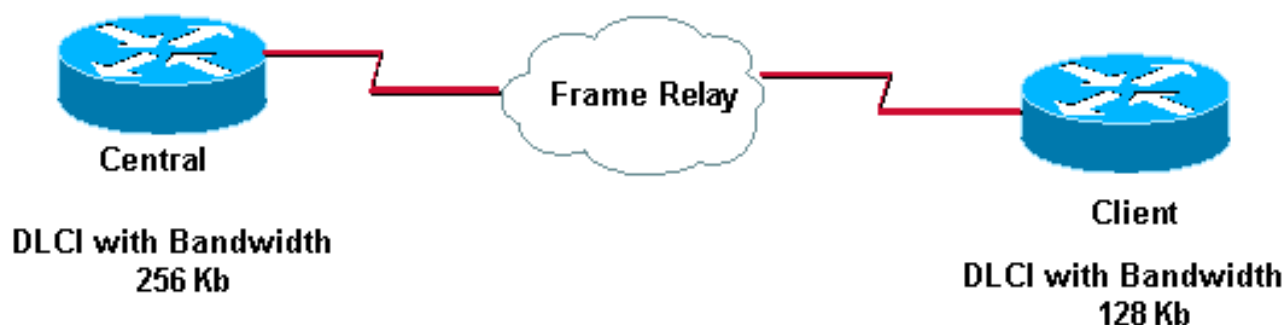

以下是我們在這些路由器上配置的內容：

```
Central#
interface serial 0
  encapsulation frame-relay
interface serial 0.1
  traffic-shape rate 128000
  traffic-shape adaptive 64000
```

```
Client#
interface serial 0
  encapsulation frame-relay
interface serial 0.1
  traffic-shape rate 128000
  traffic-shape adaptive 64000
```

## 訊框中繼流量調節

使用通用流量調節，每個物理介面只能指定一個峰值速率（上限）和每個子介面一個CIR（下限）值。使用幀中繼流量整形時，您可以為每個虛電路啟動令牌桶過濾器。

使用訊框中繼的流量調節功能提供以下功能：

- 基於每個VC的速率實施：您可以配置峰值速率，將出站流量限制為CIR或其他定義的值，例如超額資訊速率(EIR)。
- 每個VC上的廣義BECN支援：路由器可以監控BECN並根據幀中繼網路的BECN標籤資料包反饋來限制流量。
- VC級別的優先順序隊列(PQ)、自定義隊列(CQ)或WFQ支援。這樣可以更精確地確定流量的優先順序和排隊，讓您能夠更好地控制單個VC上的流量。透過訊框中繼傳輸的流量整形功能適用於訊框中繼永久虛擬電路(PVC)和交換虛擬電路(SVC)。

## 範例

```
Interface Serial 0
no ip address
encapsulation frame-relay
frame-relay traffic-shaping
!
interface Serial0.100
ip address 1.1.1.1 255.255.255.252
frame-relay interface-dlci 100
frame-relay class fast
!
interface Serial0.200
ip address 1.1.1.5 255.255.255.252
frame-relay interface-dlci 200
frame-relay class slow
!
map-class frame-relay slow
frame-relay traffic-rate 64000 128000
!
map-class
frame-relay fast
frame-relay traffic-rate 16000 64000
!
```



在本範例中，路由器新增兩個權杖桶。

- 一個在64000(CIR)和128000(Bc + Be)之間運行。
- 另一個在16000(CIR)和64000(Bc + Be)之間運行。

如果來自乙太網的傳入流量大於令牌桶過濾器，則該流量將在幀中繼流量隊列中緩衝。

要在實施幀中繼流量整形時檢視顯示資料包流的流程圖，請參閱[幀中繼流量整形流程圖](#)。要特別使用令牌桶過濾器檢視流程圖，請參閱[幀中繼流量調節 — 令牌桶流程圖](#)。

## 常用的幀中繼命令

本節介紹兩個Cisco IOS®命令，它們在配置幀中繼時特別有用。

### [show frame-relay pvc](#)

此命令顯示永久虛擬電路(PVC)的狀態、封包傳入和傳出、如果線路上發生擁塞，則通過正向明確擁塞通知(FECN)和反向明確擁塞通知(BECN)來捨棄封包，以此類推。有關[show frame-relay pvc](#)命令所使用的欄位的詳細說明，請按一下此處。

如果您的Cisco裝置輸出了[show frame-relay pvc](#)命令，則可以使用[Output Interpreter](#)(僅限[註冊](#)客戶)來顯示潛在問題和修正程式。

### [Output Interpreter註冊](#)

輸出示例如下所示：

```
RouterA#show frame-relay pvc
PVC Statistics for interface Serial0 (Frame Relay DTE)
DLCI = 666, DLCI USAGE = UNUSED, PVC STATUS = DELETED, INTERFACE = Serial0
  input pkts 0          output pkts 0          in bytes 0
  out bytes 0          dropped pkts 0         in FECN pkts 0
  in BECN pkts 0      out FECN pkts 0       out BECN pkts 0
  in DE pkts 0        out DE pkts 0
  pvc create time 0:03:18 last time pvc status changed 0:02:27
  Num Pkts Switched 0
DLCI = 980, DLCI USAGE = LOCAL, PVC STATUS = ACTIVE, INTERFACE = Serial0
  input pkts 19        output pkts 87         in bytes 2787
  out bytes 21005     dropped pkts 0         in FECN pkts 0
  in BECN pkts 0      out FECN pkts 0       out BECN pkts 0
  in DE pkts 0        out DE pkts 0
  pvc create time 1:17:47 last time pvc status changed 0:58:27
```

DLCI USAGE欄位包含以下條目之一：

- 交換 — 路由器或訪問伺服器用作交換機。
- 本地 — 路由器或訪問伺服器用作資料終端裝置(DTE)。
- 未使用 — 使用者輸入的路由器配置命令未引用資料鏈路連線識別符號(DLCI)。

PVC可以有四種可能的狀態。PVC STATUS欄位顯示如下：

- 活動 — PVC啟動並正常運行。
- INACTIVE - PVC不是端到端的。這可能是因為幀中繼雲中沒有本地DLCI的對映 (或不正確的對映)，或者PVC的遠端被刪除。

- 已刪除 — 路由器和本地交換機之間未交換本地管理介面(LMI)，或者交換機未在本地交換機上配置DLCI。
- STATIC — 在路由器的幀中繼介面上未配置keepalive。

## [show frame-relay map](#)

使用此命令可以確定**frame-relay inverse-arp**是否已將遠端IP地址解析為本地DLCI。對於點對點子介面，未啟用此命令。它僅適用於多點介面和子介面。輸出示例如下所示：

```
RouterA#show frame-relay map
Serial0 (up): ip 157.147.3.65 dlci 980(0x3D4,0xF440), dynamic,
             broadcast,, status defined, active
```

有關**show frame-relay map**命令所使用的欄位的詳細說明，請參閱[有關frame relay命令的文件](#)。

如果您的Cisco裝置輸出了**show frame-relay map**命令，則可以使用[Output Interpreter](#)(僅限註冊客戶)來顯示潛在問題和修正方案。

## [Output Interpreter註冊](#)

## [訊框中繼和橋接](#)

網橋協定資料單元(BPDU)配置消息用於思科網橋和路由器支援的生成樹協定。這些流量在橋樑之間以規則間隔流動，由於頻繁發生，它們構成了大量的流量。在透明橋接中有兩種型別的生成樹協定。該演算法首先由數位設備公司(DEC)引入，隨後由IEEE 802委員會進行修改，並發佈在IEEE 802.1d規範中。DEC生成樹協定以一秒的間隔發出BPDU，而IEEE以兩秒的間隔發出BPDU。每個資料包為41個位元組，其中包括35位元組的配置BPDU消息、2位元組的幀中繼報頭、2位元組的Ethertype和2位元組的FCS。

## [訊框中繼和記憶體](#)

幀中繼資源的記憶體消耗發生在四個區域：

1. 每個資料鏈路連線識別符號(DLCI):216 位元組
2. 每個map語句：96位元組 (或動態建立映像)
3. 每個IDB (硬體介面+封裝幀中繼)：5040 + 8346 = 13,386位元組
4. 每個IDB (軟體子介面)：2260 位元組

例如，Cisco 2501使用兩個幀中繼介面 (每個介面有四個子介面，總共八個DLCI) 和相關對映需要以下資訊：

- 2介面硬體IDB x 13,386 = 26,772
- 8個子介面IDB x 2260 = 18,080個子介面
- 8 DLCI x 216 = 1728 DLCI
- 8 map語句x 96 = 768 map語句或dynamics

總數量等於使用的RAM的47,348位元組。

**注意：**此處使用的值對Cisco IOS版本11.1、12.0和12.1軟體有效。

## [訊框中繼疑難排解](#)

本節包含疑難排解時可能會遇到的show interface指令輸出部分。文中還提供了輸出說明。

## "Serial0關閉，線路協定關閉"

此輸出表示電纜、通道服務單元/資料服務單元(CSU/DSU)或串列線路有問題。您需要使用環回測試排除故障。要執行環回測試，請執行以下步驟：

1. 將串列線路封裝設定為HDLC並將keepalive設定為10秒。為此，請在串列介面下發出encapsulation hdlc和keepalive 10命令。
2. 將CSU/DSU或數據機置於本地環路模式。如果CSU、DSU或數據機處於本地環回模式(由「line protocol is up(looped)」消息指示)時線路協定啟動，則表明問題發生在本地CSU/DSU之外。如果狀態線不更改狀態，則路由器、連線電纜、CSU/DSU或數據機可能出現問題。大多數情況下，問題出在CSU/DSU或數據機。
3. 在CSU/DSU或數據機環路的情況下ping您自己的IP地址。不應有任何遺漏。0x0000的擴展ping有助於解決線路問題，因為T1或E1從資料派生時鐘，並且每8位需要一次轉換。B8ZS可確保這一點。過大的零資料模式有助於確定是否在中繼上適當地強制轉換。在路徑中存在一對資料反相器的情況下，使用重一模式來適當地模擬高零負載。交替模式(0x555)表示「典型」資料模式。如果ping失敗或收到循環冗餘檢查(CRC)錯誤，則需要使用電信公司提供的具有適當分析器的位元錯誤率測試儀(BERT)。
4. 測試完成後，請確保將封裝返回到幀中繼。

## "Serial0為up，線路協定為down"

輸出中的這條線表示路由器正在從CSU/DSU或數據機獲取載波訊號。檢查以確保幀中繼提供商已啟用其埠，並且您的本地管理介面(LMI)設定匹配。通常，幀中繼交換機忽略資料終端裝置(DTE)，除非它看到正確的LMI(使用Cisco的預設設定為「cisco」LMI)。檢查以確保Cisco路由器正在傳輸資料。您很可能需要在從本地CSU開始的各位置使用環路測試檢查線路完整性，並在到達提供商的幀中繼交換機之前逐步退出。有關如何執行環回測試的資訊，請參見上一節。

## "Serial0為up，線路協定為up"

如果沒有關閉keepalive，此輸出行表示路由器正在與幀中繼提供商的交換機通訊。您應該會看到串列介面上的雙向流量交換成功，並且沒有CRC錯誤。Keepalive在訊框中繼中是必需的，因為它們是路由器用來瞭解提供者已布建哪些資料連結連線識別碼(DLCI)的機制。要觀察交換，幾乎在所有情況下都可以安全地使用debug frame-relay lmi。debug frame-relay lmi命令生成的消息非常少，可以回答以下問題：

1. Cisco路由器是否與本地幀中繼交換機通訊？
2. 路由器是否從幀中繼提供商獲取已訂閱永久虛擬電路(PVC)的完整LMI狀態消息？
3. DLCI是否正確？

以下是成功連線的debug frame-relay lmi輸出示例：

```
*Mar 1 01:17:58.763: Serial0(out): StEnq, myseq 92, yourseen 64, DTE up
*Mar 1 01:17:58.763: datagramstart = 0x20007C, datagramsize = 14
*Mar 1 01:17:58.763: FR encap = 0x0001030800 75 95 01 01 01 03 02 5C 40
*Mar 1 01:17:58.767:
*Mar 1 01:17:58.815: Serial0(in): Status, myseq 92
*Mar 1 01:17:58.815: RT IE 1, length 1, type 1
*Mar 1 01:17:58.815: KA IE 3, length 2, yourseq 65, myseq 92
*Mar 1 01:18:08.763: Serial0(out): StEnq, myseq 93, yourseen 65, DTE up
```

```

*Mar 1 01:18:08.763: datagramstart = 0x20007C, datagramsize = 14
*Mar 1 01:18:08.763: FR encap = 0x0001030800 75 95 01 01 03 02 5D 41
*Mar 1 01:18:08.767:
*Mar 1 01:18:08.815: Serial0(in): Status, myseq 93
*Mar 1 01:18:08.815: RT IE 1, length 1, type 1
*Mar 1 01:18:08.815: KA IE 3, length 2, yourseq 66, myseq 93
*Mar 1 01:18:18.763: Serial0(out): StEnq, myseq 94, yourseen 66, DTE up
*Mar 1 01:18:18.763: datagramstart = 0x20007C, datagramsize = 14
*Mar 1 01:18:18.763: FR encap = 0x0001030800 75 95 01 01 00 03 02 5E 42
*Mar 1 01:18:18.767:
*Mar 1 01:18:18.815: Serial0(in): Status, myseq 94
*Mar 1 01:18:18.815: RT IE 1, length 1, type 0
*Mar 1 01:18:18.819: KA IE 3, length 2, yourseq 67, myseq 94
*Mar 1 01:18:18.819: PVC IE 0x7 , length 0x3 , dlci 980, status 0x2

```

注意上述輸出中的「DLCI 980」狀態。狀態欄位的可能值說明如下：

1. **0x0-Added/inactive**表示交換機已設定此DLCI，但由於某種原因（例如此PVC的另一端關閉）而不能使用。
2. **0x2-Added/active**表示幀中繼交換機具有DLCI，並且一切正常。您可以開始在報頭中使用此DLCI傳送流量。
3. **0x3-0x3**是活動狀態(0x2)和已設定(0x1)的RNR（或r位）的組合。這表示此PVC的交換機（或交換機上的特定隊列）已備份，並且一旦幀溢位，您將停止傳輸。
4. **0x4-Deleted**表示幀中繼交換機沒有為路由器設定此DLCI。但在過去的某個時刻就設定了這樣的程式。這也可能是由路由器上的DLCI被反向引起的，或者是由幀中繼網雲中的電信公司刪除的PVC導致的。配置DLCI（交換機沒有）將顯示為0x4。
5. **0x8** -新增/非活動
6. **0x0a**-新建/活動

## 框架轉送特徵

本節介紹幾個您應該瞭解的幀中繼特性。

### IP水準分割檢查

幀中繼封裝預設禁用IP水準分割檢查，因此路由更新將傳入和傳出同一介面。路由器通過本地管理介面(LMI)更新從幀中繼交換機瞭解需要使用的資料鏈路連線識別符號(DLCI)。然後，路由器對遠端IP地址使用逆向ARP，並建立本地DLCI及其關聯的遠端IP地址的對映。此外，某些協定（例如AppleTalk、透明橋接和IPX）在部分網狀網路中無法支援，因為它們需要「水準分割」，即介面上接收的包不能從同一介面傳輸，即使該包在不同的虛擬電路上接收和傳輸。配置幀中繼子介面可確保將單個物理介面視為多個虛擬介面。此功能使我們能夠克服水準分割規則。現在，一個虛擬介面上收到的資料包可以從另一個虛擬介面轉發出去，即使這些資料包是在同一個物理介面上配置的。

### 在多點幀中繼上Ping您自己的IP地址

在多點幀中繼介面上，您無法ping通自己的IP地址。這是因為幀中繼多點（子）介面是非廣播介面（與乙太網和點對點介面高級資料鏈路控制[HDLC]不同）和幀中繼點對點子介面。

此外，您無法在集中星型配置中從一個星型對另一個星型執行ping。這是因為不存在您自己的IP地址的對應關係（且沒有通過逆向ARP得知該對應關係）。但是，如果您將靜態對映(使用frame-relay map命令)配置為使用本地DLCI，則可以ping您的裝置。

```

aton#ping 3.1.3.3
Type escape sequence to abort.
Sending 5, 100-byte ICMP Echos to 3.1.3.3, timeout is 2 seconds:
.....
Success rate is 0 percent (0/5)

aton#configure terminal
Enter configuration commands, one per line. End with CNTL/Z.
aton(config)#interface serial 1
aton(config-if)#frame-relay map ip 3.1.3.3 160
aton(config-if)#

aton#show frame-relay map
Serial1 (up): ip 3.1.3.1 dlci 160(0xA0,0x2800), dynamic,
                broadcast,, status defined, active
Serial1 (up): ip 3.1.3.2 dlci 160(0xA0,0x2800), static,
                CISCO, status defined, active
Serial1 (up): ip 3.1.3.3 dlci 160(0xA0,0x2800), static,
                CISCO, status defined, active
aton#ping 3.1.3.3

Type escape sequence to abort.
Sending 5, 100-byte ICMP Echos to 3.1.3.3, timeout is 2 seconds:
!!!!
Success rate is 100 percent (5/5), round-trip min/avg/max = 64/68/76 ms
aton#
aton#show running-config
!
interface Serial1
ip address 3.1.3.3 255.255.255.0
no ip directed-broadcast
encapsulation frame-relay
frame-relay map ip 3.1.3.2 160
frame-relay map ip 3.1.3.3 160
frame-relay interface-dlci 160
!

```

## 關鍵字broadcast

**broadcast**關鍵字提供兩個功能：它在組播未啟用時轉發廣播，並且簡化了使用幀中繼的非廣播網路的開放最短路徑優先(OSPF)配置。

某些依賴於定期路由表更新的路由協定（例如AppleTalk）可能也需要**broadcast**關鍵字，尤其是當位於遠端端的路由器在新增路由之前等待路由更新資料包到達時。

通過要求選擇指定路由器，OSPF對待非廣播多路訪問網路（如幀中繼）的方式與對待廣播網路的方式非常相似。在以前的版本中，這需要使用**neighbor interface router**命令在OSPF配置中進行手動分配。如果配置中包含**frame-relay map**命令（帶有**broadcast**關鍵字），並且配置了**ip ospf network**命令（帶有**broadcast**關鍵字），則無需手動配置任何鄰居。OSPF現在作為廣播網路在幀中繼網路上自動運行。（有關詳細資訊，請參閱**ip ospf network interface**命令。）

**注意：**OSPF廣播機製假設IP D類地址從未用於幀中繼上的常規流量。

## 範例

以下示例將目標IP地址172.16.123.1對映到DLCI 100:

```
interface serial 0
 frame-relay map IP 172.16.123.1 100 broadcast
```

OSPF使用DLCI 100廣播更新。

## 重新配置子介面

建立特定型別的子介面後，如果沒有重新載入，將無法對其進行更改。例如，您不能建立多點子介面serial0.2，然後將其更改為點對點。要更改它，需要重新載入路由器或建立另一個子介面。這就是幀中繼代碼在Cisco IOS®軟體中的工作方式。

## DLCI限制

### DLCI地址空間

給定10位地址，可以在一條物理鏈路上配置大約1000個DLCI。由於某些DLCI是保留的（取決於供應商實施），因此最大值大約為1000。Cisco LMI的範圍是16-1007。ANSI/ITU的指定範圍為16-992。這些是傳送使用者資料的DLCI。

但是，當在子介面上配置幀中繼VC時，您需要考慮一種稱為IDB限制的實際限制。每個系統的介面和子介面的總數受您的Cisco IOS版本支援的介面描述符塊(IDB)數量的限制。IDB是記憶體的一部分，儲存有關介面的資訊，如計數器、介面狀態等。IOS為平台上的每個介面維護一個IDB，並為每個子介面維護一個IDB。較高速的介面需要比較低速度介面更多的記憶體。每個平台包含的最大IDB數量不同，這些限制可能隨每個Cisco IOS版本而變化。

如需詳細資訊，請參閱[Cisco IOS軟體平台的最大介面和子介面數量：IDB限制](#)。

## LMI狀態更新

LMI協定要求所有永久虛擬電路(PVC)狀態報告都適合單個資料包，並且根據最大傳輸單元(MTU)大小，通常將DLCI的數量限制為小於800。

$$\begin{aligned}
 \text{Max DLCIs} &\cong \frac{\text{MTU bytes} - 20 \text{ bytes}}{5 \frac{\text{bytes}}{\text{DLCI}}} \\
 \text{MTU} = 4000 \text{ bytes} & \\
 & \\
 & \frac{4000 - 20}{5} \cong 796
 \end{aligned}$$

**DLCIs, where 20 = Frame Relay and LMI Header**

串列介面的預設MTU為1500位元組，每個介面最多產生296個DLCI。您可以增加MTU以支援幀中繼交換機發出的較大完整狀態更新消息。如果完整狀態更新消息大於介面MTU，則丟棄資料包，並增加介面巨量計數器。更改MTU時，請確保在遠端路由器上配置相同的值並插入網路裝置。

請注意，這些數字略有不同，取決於LMI型別。根據在Cisco 7000路由器平台上建立的經驗資料推算得出的每個路由器（非介面）平台的最大DLCI准則如下：

- Cisco 2500:每個介面1 X T1/E1鏈路，60 DLCI =共60
- Cisco 4000:1 X T1/E1鏈路，每個介面120個DLCI =共120個
- Cisco 4500:每個介面3個T1/E1鏈路，120個DLCI =共360
- Cisco 4700:每個介面4個T1/E1鏈路，120個DLCI =共480
- Cisco 7000:4條T1/E1/T3/E3鏈路，每個介面120個DLCI =共480個
- Cisco 7200:每個介面5個T1/E1/T3/E3鏈路，120個DLCI =共600
- Cisco 7500:6條T1/E1/T3/E3鏈路，每個介面120個DLCI =共720個

注意：這些數字只是指導原則，並假設所有流量都是快速交換的。

## 其他注意事項

實際的DLCI限制還取決於VC運行的是動態路由協定還是靜態路由協定。動態路由協定和其他協定（如IPX SAP）交換資料庫表、傳送hello和轉發必須由CPU檢視和處理的資訊消息。通常，使用靜態路由可以在單個幀中繼介面上配置更多虛電路。

## IP/IPX/AT地址

如果使用子介面，請勿在主介面上放置IP、IPX或AT地址。在啟用主介面之前將DLCI分配給其子介面，以確保frame-relay inverse-arp正常工作。如果發生故障，請執行以下步驟：

1. 使用no frame-relay inverse-arp ip 16和clear frame-relay-inarp命令，關閉該DLCI的反向地址解析協定(ARP)。
2. 修復配置。
3. 再次啟用frame-relay inverse-arp命令。

## RIP和IGRP

路由資訊協定(RIP)每30秒更新一次。每個RIP資料包最多可以包含25個路由條目，共計536位元組；其中36個位元組是報頭資訊，每個路由條目為20個位元組。因此，如果通過為50個DLCI配置的幀中繼鏈路通告1000條路由，則結果為每30秒消耗1 MB的路由更新資料，或消耗285 kbps的頻寬。在T1鏈路上，此頻寬代表頻寬的18.7%，每個更新持續時間為5.6秒。這種開銷量相當大，並且是邊界可接受的，但承諾資訊速率(CIR)必須在訪問速度範圍內。顯然，任何低於T1的流量都會產生過多的開銷。例如：

- $1000/25 = 40$  packets X 36 = 1440 header bytes
- $1000 \times 20$  位元組 = 20,000位元組的路由條目
- 總計21,440位元組 X 50 DLCI =每30秒1072 MB的RIP更新
- $1,072,000$ 位元組/30秒 X 8位 = 285 kbps

內部網道路由通訊協定(IGRP)每90秒更新一次流量（此間隔可設定）。每個IGRP資料包可以包含104個路由條目，總共有1492位元組，其中38個是報頭資訊，每個路由條目為14位元組。如果您在配置了50個DLCI的幀中繼鏈路上通告1000條路由，則請求大約每90秒消耗720 KB的路由更新資料，或消耗64 kbps的頻寬。在T1鏈路上，此頻寬將代表頻寬的4.2%，每個更新持續時間為3.7秒。此間接費用是可以接受的金額：

- $1000/104 = 9$  packets X 38 = 342 header bytes
- $1000 \times 14 = 14,000$ 位元組的路由專案

- 總計= 14,342位元組X 50 DLCI =每90秒717 KB的IGRP更新
- 717,000位元組/ 90 X 8位= 63.7 kbps

路由表維護協定(RTMP)路由更新每10秒發生一次 (此間隔是可配置的)。每個RTMP資料包最多可以包含94個擴展路由條目，總計564位元組，23位元組的報頭資訊，每個路由條目為6位元組。如果通過為50個DLCI配置的幀中繼鏈路通告1000個AppleTalk網路，則結果為每10秒大約313 KB的RTMP更新或消耗了250 kbps的頻寬。要保持在可接受的開銷水準 (15%或更低)，需要T1速率。例如：

- $1000/94 = 11$ 個資料包X 23位元組= 253報頭位元組
- $1000 \times 6 = 6000$ 位元組的路由條目
- 總計=  $6253 \times 50$  DLCI =每10秒更新313 KB
- $313,000 / 10$ 秒X 8位= 250 kbps

IPX RIP資料包每60秒更新一次 (此間隔是可配置的)。每個IPX RIP資料包最多可以包含50個路由條目，共計536位元組，38位元組報頭資訊，每個路由條目為8位元組。如果通過為50個DLCI配置的幀中繼鏈路通告1000個IPX路由，則結果為每60秒536 KB的IPX更新或消耗的頻寬為58.4 kbps。要保持在可接受的開銷級別 (15%或更低)，需要512 kbps的速率。例如：

- $1000/50 = 20$ 個資料包X 38個位元組= 760位元組報頭
- $1000 \times 8 = 8000$ 位元組的路由專案
- 總計=  $8760 \times 50$  DLCI =每60秒438,000位元組IPX更新
- $438,000 / 60$ 秒X 8位= 58.4 kbps

IPX服務存取點(SAP)封包更新每60秒執行一次 (此間隔可設定)。每個IPX SAP資料包最多可以包含7個通告條目，總計536位元組，38位元組報頭資訊，每個通告條目為64位元組。如果通過為50個DLCI配置的幀中繼鏈路廣播1000個IPX通告，則每60秒將有536 KB的IPX更新或消耗了58.4 kbps的頻寬。要保持在可接受的開銷級別 (15%或更低)，速率必須大於2 Mbps。顯然，在此案例中需要SAP過濾。與本節中提到的所有其他協定相比，IPX SAP更新需要最多的頻寬：

- $1000/7 = 143$ 資料包X 38位元組= 5434位元組報頭
- $1000 \times 64 = 64,000$ 位元組路由條目
- 總計=  $69,434 \times 50$  DLCI =每60秒3,471,700位元組IPX服務通告
- $3,471,700 / 60$ 秒X 8位= 462 kbps

## Keepalive

在某些情況下，Cisco裝置上的keepalive需要設定得比交換器上的keepalive略短 (約8秒)。如果介面不斷開啟和關閉，您會發現對此的需求。

## 串列介面

串列介面 (預設為多點) 是非廣播介質，而點對點子介面是廣播介面。如果使用靜態路由，可以指向下一跳或串列子介面。對於多點，您需要指向下一跳。在通過幀中繼執行OSPF時，此概念非常重要。路由器需要知道這是一個廣播介面，OSPF才能正常工作。

## OSPF和多點

OSPF和多點非常麻煩。OSPF需要指定路由器(DR)。如果您開始丟失PVC，一些路由器可能會失去連線並嘗試成為DR，即使其他路由器仍能看到舊的DR。這會導致OSPF進程出現故障。

與OSPF相關的開銷不像傳統的距離向量路由協定那樣明顯且可預測。不可預測性來自OSPF網路鏈



路是否穩定。如果與幀中繼路由器的所有鄰接關係都是穩定的，則只有鄰居hello資料包(keepalive)才會流動，這相對比距離向量協定(如RIP和IGRP)產生的開銷要小得多。但是，如果路由(鄰接)不穩定，則會發生鏈路狀態泛洪，並且頻寬可以快速消耗。運行Dijkstra演算法(用於計算路由)時，OSPF對處理器來說也非常密集。

在Cisco IOS軟體的早期版本中，在通過多路訪問非廣播介質(如幀中繼、X.25和ATM)配置OSPF時必須特別小心。OSPF協定將這些介質視為任何其它廣播介質(如乙太網)。非廣播多路訪問(NBMA)雲通常構建在中心輻射型拓撲中。PVC或交換虛擬電路(SVC)在部分網狀結構中部署，並且物理拓撲不提供OSPF認為存在的多路訪問。對於點對點串列介面，OSPF始終在鄰居之間形成鄰接關係。OSPF鄰接關係交換資料庫資訊。為了儘量減少在特定網段上交換的資訊量，OSPF在每個多路訪問網段上選擇一個路由器作為DR，並且選擇一個路由器作為備用指定路由器(BDR)。BDR被選舉為備用DR發生故障時的備份機制。

這種設定背後的理念是路由器具有交換資訊的中心聯絡點。DR的選擇成為一個問題，因為DR和BDR需要與雲上的所有路由器具有完全的物理連線。此外，由於缺乏廣播功能，DR和BDR需要有一個連線到雲的所有其他路由器的靜態清單。使用neighbor命令可以實現此設定：

**neighbor ip-address [priority number] [poll-interval seconds]**

在更高版本的Cisco IOS軟體中，可以使用不同的方法來避免配置靜態鄰居和使特定路由器成為非廣播雲上的DR或BDR的複雜情況。使用哪種方法取決於網路是新的還是需要修改的現有設計。

子介面是定義介面的邏輯方式。同一物理介面可以拆分為多個邏輯介面，每個子介面都定義為點對點。此場景最初是為了更好地處理由NBMA水準分割和基於向量的路由協定引起的問題。

點對點子介面具有任何物理點對點介面的屬性。就OSPF而言，鄰接始終在點對點子介面上形成，不進行DR或BDR選舉。OSPF將雲視為一組點對點鏈路，而不是一個多路訪問網路。點對點的唯一缺點是每個網段都屬於不同的子網。此情況可能無法接受，因為某些管理員已經為整個雲分配了一個IP子網。另一種解決方法是使用雲上的IP未編號介面。對於一些管理基於串列線路IP地址的WAN的管理員來說，此方案也可能會出現問題。

## 來源

1. 國際電報和電話協商委員會，「用於幀模式承載服務的ISDN資料鏈路層規範」，CCITT建議Q.922,1991年4月19日。
2. 美國國家電信標準 — 整合服務數位網路 — 用於幀中繼承載服務的幀協定的核心方面，ANSI T1.618-1991,1991年6月18日。
3. 資訊科技 — 系統之間的電信和資訊交換 — 網路層協定識別，ISO/IEC TR 9577:1990(E)1990-10-15。
4. 國際標準，資訊處理系統 — 區域網 — 邏輯鏈路控制，ISO 8802-2:1989(E)、IEEE Std 802.2-1989、1989-12-31。
5. Internetworking Technology Overview，1994年10月，Cisco Systems
6. Finlayson，R.，Mann，R.，Mogul，J.和M. Theimer，「反向地址解析協定」，STD 38，RFC 903，斯坦福大學，1984年6月。
7. Postel，J.和Reynolds，J.，「Standard for Transmission of IP Datagrams over IEEE 802 Networks」，RFC 1042,USC/資訊科學研究所，1988年2月。
8. [RFC 1490 — 多重通訊協定封裝](#)
9. [RFC 1315 — 訊框中繼MIB](#)
10. [RFC 1293 — 訊框中繼反向ARP](#)
11. [RFC 1144-TCP/IP標頭壓縮](#)

12. 框架轉送論壇(FRF)1.1 — 使用者 — 網路介面(UNI)
13. FRF 2.1訊框中繼網路對網路介面(NNI)
14. FRF 3.1 — 多重通訊協定封裝
15. FRF 4-SVC
16. FRF 6訊框中繼服務客戶網路管理(MIB)
17. 四人幫
18. Q.922附件A
19. ANSI T1.617 Annex D
20. ANSI T1.618、T1.606
21. ITU-T Q.933、Q.922
22. [OSPF 設計指南](#)
23. [增強型IGRP實施配置說明](#)

## **相關資訊**

- [有關幀中繼命令的更多資訊](#)
- [有關配置幀中繼的詳細資訊](#)
- [有關Dial-Backup命令的更多資訊](#)
- [有關ISDN Debug命令的更多資訊](#)
- [有關PPP Debug命令的更多資訊](#)
- [有關ISDN交換機型別、代碼和值的詳細資訊](#)
- [技術支援與文件 - Cisco Systems](#)