

DHCP configureren en controleren in een VxLAN-fabric voor Nexus 9000 met NX-OS en Windows Server 2022

Inhoud

[Inleiding](#)

[Voorwaarden](#)

[Vereisten](#)

[Gebruikte componenten](#)

[Achtergrondinformatie](#)

[Configuratie van onderlay en overlay voor VxLAN in laboratorium](#)

[RUGGENGRAAT](#)

[BLAD-1](#)

[LEAF-1-vPC-software](#)

[LEAF-2-vPC-software](#)

[N9K-ACCESS](#)

[DHCP-configuratie op Nexus-switches](#)

[BLAD-1](#)

[LEAF-1-vPC DHCP](#)

[LEAF-2-vPC DHCP](#)

[DHCP-serverconfiguratie op Windows Server 2022](#)

[IP-adresseringstoepassingsconfiguratie voor hosts.](#)

[Het instellen van de scope voor unieke IP-adressen van loopbacks in SVI als DHCP relay agent.](#)

[Superscope voor VxLAN-fabric configureren.](#)

[Configureer optie 82 in hostscopen.](#)

[DHCP-pakketwandeling van begin tot eind in VxLAN Fabric.](#)

[Detectie verzenden via HOST-1](#)

[Detectie op LEAF-1](#)

[Detectie op RUGGENGRAAT](#)

[Detectie op LEAF-1-vPC](#)

[Detectie ontvangen op DHCP-server](#)

[DHCP-aanbieding verzenden via DHCP Server](#)

[DHCP-aanbieding op LEAF-2-vPC](#)

[DHCP-aanbieding vPC SPINE](#)

[DHCP-aanbieding op LEAF-1](#)

[DHCP-aanbieding ontvangen op HOST-1](#)

[Verzoek verzenden door HOST-1](#)

[Verzoek op LEAF-1](#)

[Verzoek op SPINE](#)

[Verzoek op LEAF-2-vPC](#)

[Aanvraag ontvangen op DHCP-server](#)

[ACK verzenden via DHCP Server](#)

[ACK op LEAF-2-vPC](#)

[ACK op RUGGENGRAAT](#)

[ACK op LEAF-1](#)

[ACK op HOST-1](#)

[Gerelateerde informatie](#)

Inleiding

Dit document beschrijft hoe u DHCP kunt configureren en oplossen in een VLAN-fabric met Nexus 9000 switches.

Voorwaarden

Vereisten

Cisco raadt kennis van de volgende onderwerpen aan:

- Nexus NX-OS-software.
- Virtual-poortkanaal (vPC).
- VxLAN BGP L2VPN-VPN VPN
- BGP-adresfamilie voor IPv4
- OSPF
- Multicast PIM (sparse-mode)
- DHCP

Gebruikte componenten

De informatie in dit document is gebaseerd op de volgende software- en hardware-versies:

- Cisco Nexus 9000 met Cisco NX-OS.
 - N9K-C93180YC-EX
 - N9K-C93180YC-FX switch
 - NX-OS 10.3(4a)
- Windows Server 2022-datacenter

De informatie in dit document is gebaseerd op de apparaten in een specifieke laboratoriumomgeving. Alle apparaten die in dit document worden beschreven, hadden een opgeschoonde (standaard)configuratie. Als uw netwerk live is, moet u zorgen dat u de potentiële impact van elke opdracht begrijpt.

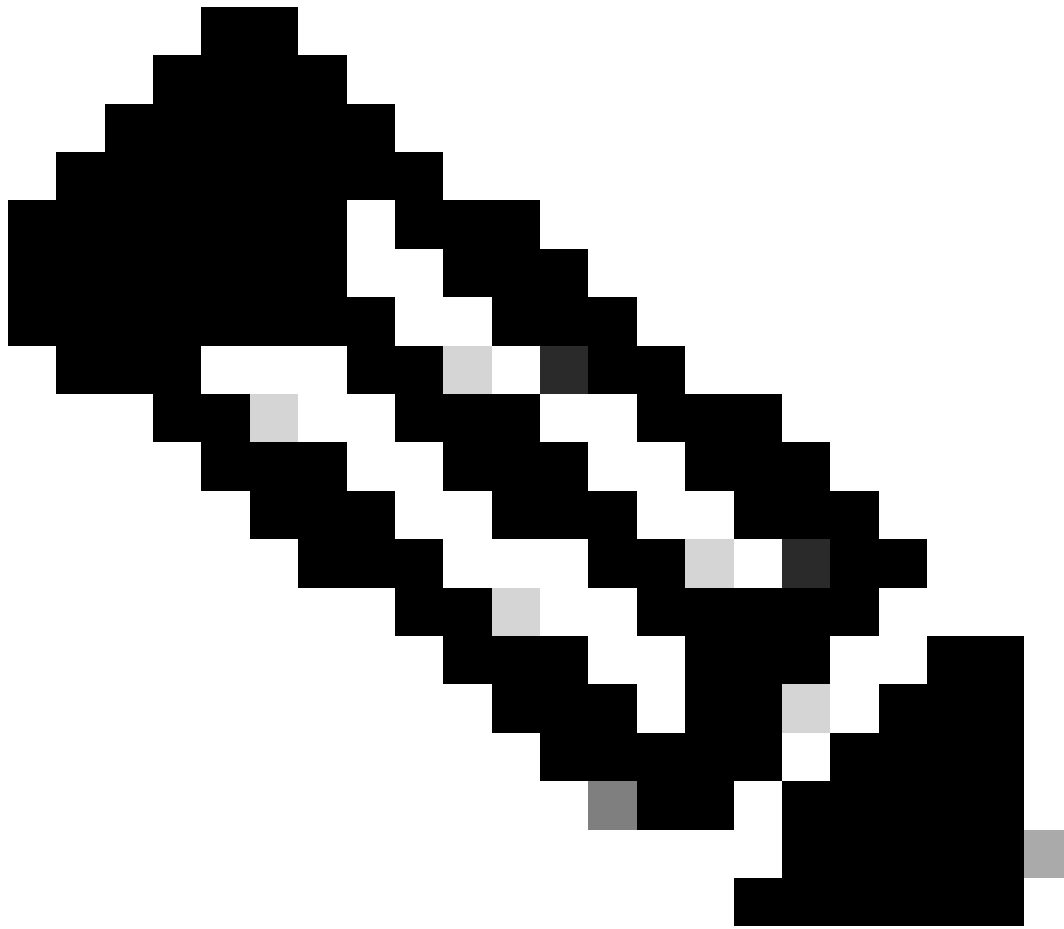

N.B.: Vragen over de configuratie en integriteit van software of hardware van derden vallen buiten de ondersteuning van Cisco. Het gebruik van tools van derden is de beste poging om uw configuratie en werking met Cisco-apparatuur aan de klant aan te tonen.

Achtergrondinformatie

Configuratie van onderlay en overlay voor VxLAN in laboratorium

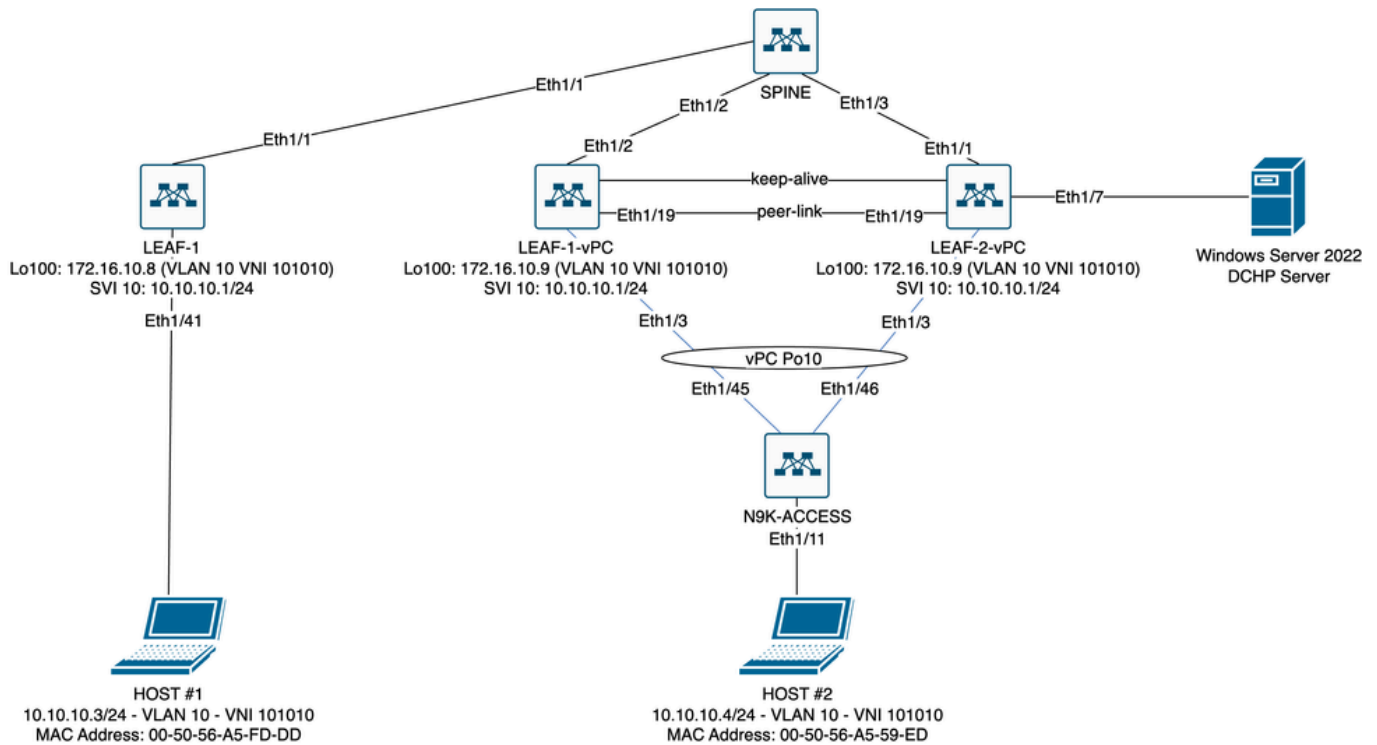

VXLAN Fabric Diagram in laboratorium

- RUGGENGRAAT:

- Deze Nexus switch verstuurt DHCP-pakketten (Discover, Offer, Verzoek, Ack) zonder dat deze in dit scenario worden gedecapsuleerd. Alleen de kop buiten wordt gebruikt.
- Handelt als centrale routeringspunten in de netwerkstof.
- Verantwoordelijk voor het onderling verbinden van alle LEAF-switches en het faciliteren van de gegevensstroom tussen hen.
- Neemt deel aan BGP om EVPN-routes naar de LEAF-switches te distribueren.
- Voert IP-routing uit en kan verkeer tussen verschillende subnetten of VxLAN-segmenten routeren door naar de buitenste IP-headers te kijken.
- Scheidt het overlay-netwerk (VxLAN) van het fysieke netwerk onder de afdekking.
- Beheert de onderlaag met traditionele IP-routingprotocollen, terwijl de overlay wordt beheerd door VxLAN met BGP EVPN, waardoor een schaalbare en flexibele netwerkarchitectuur wordt geboden.

- BLADZIJDE 1:

- LEAF-switches bieden fysieke connectiviteit voor endpoints zoals servers, opslagapparaten en andere netwerkapparaten.
- LEAF-switches fungeren als VTEP's, wat betekent dat ze de VxLAN-pakketten inkapselen en deencapsuleren.
- In dit scenario doet HOST#1 het IP-adresverzoek.
- LEAF-1 is verantwoordelijk voor het inkapselen van de DHCP-pakketten binnen VxLAN-header.
- HOST#1 ontvangt DHCP-pakketten transparant als klassieke Ethernet.

- LEAF-1-vPC en LEAF-2-vPC:

- LEAF-switches nemen deel aan het EVPN-besturingsplane door BGP te runnen en routegegevens uit te wisselen. Dit maakt de distributie van MAC- en IP-adresinformatie

mogelijk, waardoor verkeer efficiënt over de VxLAN-structuur kan worden gerouteerd.

- In dit scenario wordt de DHCP-server geassocieerd met VLAN 10 met VNI 101010 zoals HOST#1 is. Dit betekent dat het alleen VxLAN-overbrugging is.
 - Als de DHCP-server was gekoppeld aan een VNI anders dan HOST#1, dan zou een L3VNI strikt noodzakelijk zijn voor routing. Het bron- en doelbestand VNI moet worden gemaakt.
 - DHCP-server ontvangt DHCP-pakketten transparant als klassieke Ethernet.
 - Het BUM-verkeer wordt door beide Nexus-switches in vPC ontvangen, maar alleen de operationeel primaire Nexus-switch in vPC stuurt het verkeer. De tweede Nexus switch laat het verkeer vallen. In dit scenario is LEAF-1-vPC operationeel primair.
 - Het gebruik van infra-vlans is verplicht omdat als de interface op LEAF-2-vPC naar SPINE daalt, DHCP-pakketten niet kunnen worden verzonden. Om VxLAN-ingesloten verkeer naar LEAF-1-vPC te verzenden, is deze back-up van VLAN vereist. Op deze manier kan LEAF-1-vPC DHCP-pakketten naar de ruggengraat sturen.
- N9K-ACCESS:
 - Deze Nexus switch biedt alleen connectiviteit met beide blades met behulp van een vPC-poortkanaal voor redundantiedoelinden naar HOST#2

RUGGENGRAAT

```
nv overlay evpn
feature ospf
feature bgp
feature pim
feature netconf
feature nv overlay
```

```
ip pim rp-address 192.168.11.11 group-list 224.10.10.0/24
ip pim ssm range 232.0.0.0/8
ip pim anycast-rp 192.168.11.11 192.168.0.11
```

```
ip prefix-list direct_routes seq 5 permit 10.104.11.0/30 le 32
route-map redistribution permit 10
  match ip address prefix-list direct_routes
```

```
interface Ethernet1/1
  speed 1000
  ip address 10.104.11.1/30
  ip ospf network point-to-point
  ip router ospf 1 area 0.0.0.0
  ip pim sparse-mode
  no shutdown
```

```
interface Ethernet1/2
  ip address 10.102.11.1/30
  ip ospf network point-to-point
  ip router ospf 1 area 0.0.0.0
  ip pim sparse-mode
  no shutdown
```

```
interface Ethernet1/3
  speed 1000
```

```
ip address 10.103.11.1/30
ip ospf network point-to-point
ip router ospf 1 area 0.0.0.0
ip pim sparse-mode
no shutdown

interface loopback0
description ANYCAST-RP
ip address 192.168.0.11/32
ip router ospf 1 area 0.0.0.0
ip pim sparse-mode

interface loopback1
description ANYCAST-RP-CANDIDATE
ip address 192.168.11.11/32
ip router ospf 1 area 0.0.0.0
ip pim sparse-mode

router ospf 1

router bgp 65000
neighbor 192.168.3.3
remote-as 65000
update-source loopback0
address-family 12vpn evpn
send-community
send-community extended
route-reflector-client
neighbor 192.168.4.4
remote-as 65000
update-source loopback0
address-family 12vpn evpn
send-community
send-community extended
route-reflector-client
neighbor 192.168.5.5
remote-as 65000
update-source loopback0
address-family 12vpn evpn
send-community
send-community extended
route-reflector-client
```

BLAD-1

```
nv overlay evpn
feature ospf
feature bgp
feature pim
feature interface-vlan
feature vn-segment-vlan-based
feature dhcp
feature nv overlay

fabric forwarding anycast-gateway-mac 0000.0a0a.0a0a

ip pim rp-address 192.168.11.11 group-list 224.10.10.0/24
```

```
ip pim ssm range 232.0.0.0/8

vlan 1,10,20,300
vlan 10
    vn-segment 101010
vlan 20
    vn-segment 202020
vlan 300
    vn-segment 303030

spanning-tree vlan 10 priority 4096

ip prefix-list host_subnets seq 5 permit 10.10.10.0/24 le 32
ip prefix-list host_subnets seq 10 permit 192.168.20.0/24 le 32
ip prefix-list host_subnets seq 15 permit 172.16.10.8/32
route-map direct_routes_tenant-a permit 10
    match ip address prefix-list host_subnets

vrf context tenant-a
    vni 303030
    rd auto
    address-family ipv4 unicast
        route-target both auto
        route-target both auto evpn

interface Vlan10
    no shutdown
    vrf member tenant-a
    no ip redirects
    ip address 10.10.10.1/24
    no ipv6 redirects
    fabric forwarding mode anycast-gateway
    ip dhcp relay address 10.10.10.150
    ip dhcp relay source-interface loopback100

interface Vlan20
    no shutdown
    vrf member tenant-a
    no ip redirects
    ip address 192.168.20.1/24
    no ipv6 redirects
    fabric forwarding mode anycast-gateway

interface Vlan300
    no shutdown
    vrf member tenant-a
    no ip redirects
    ip forward
    no ipv6 redirects

interface nve1
    no shutdown
    host-reachability protocol bgp
    source-interface loopback0
    member vni 101010
        suppress-arp
        mcast-group 224.10.10.10
    member vni 202020
        suppress-arp
        mcast-group 224.10.10.10
    member vni 303030 associate-vrf
```

```

interface Ethernet1/1
  ip address 10.104.11.2/30
  ip ospf network point-to-point
  ip router ospf 1 area 0.0.0.0
  ip pim sparse-mode
  no shutdown

interface loopback0
  description UNDERLAY-VERIFICATION
  ip address 192.168.5.5/32
  ip router ospf 1 area 0.0.0.0
  ip pim sparse-mode

interface loopback100
  vrf member tenant-a
  ip address 172.16.10.8/32

router ospf 1

router bgp 65000
  address-family ipv4 unicast
  neighbor 192.168.0.11
  remote-as 65000
  update-source loopback0
  address-family l2vpn evpn
  send-community
  send-community extended
  vrf tenant-a
  address-family ipv4 unicast
  redistribute direct route-map direct_routes_tenant-a
evpn
  vni 101010 12
  rd auto
  route-target import auto
  route-target export auto
  vni 202020 12
  rd auto
  route-target import auto
  route-target export auto

```

LEAF-1-vPC-software

```

nv overlay evpn
feature ospf
feature bgp
feature pim
feature interface-vlan
feature vn-segment-vlan-based
feature lacp
feature dhcp
feature vpc
feature nv overlay

fabric forwarding anycast-gateway-mac 0000.0a0a.0a0a

ip pim rp-address 192.168.11.11 group-list 224.10.10.0/24
ip pim ssm range 232.0.0.0/8

```

```
vlan 1,10,300,777
vlan 10
  vn-segment 101010
vlan 300
  vn-segment 303030
vlan 777
  name BACKUP_VLAN_ROUTING_NVE_INFRA
spanning-tree vlan 1,10,300 hello-time 4

ip prefix-list host_subnets seq 5 permit 10.10.10.0/24 le 32
ip prefix-list host_subnets seq 15 permit 172.16.10.9/32
route-map direct_routes_tenant-a permit 10
  match ip address prefix-list host_subnets

vrf context tenant-a
  vni 303030
  rd auto
  address-family ipv4 unicast
    route-target both auto
    route-target both auto evpn
system nve infra-vlans 777

vpc domain 1
  peer-switch
  peer-keepalive destination 10.88.238.195
  peer-gateway
  layer3 peer-router
  ip arp synchronize

interface Ethernet1/3
  switchport
  switchport mode trunk
  switchport trunk allowed vlan 1,10,20
  channel-group 10 mode active
  no shutdown

interface Ethernet1/19
  switchport
  switchport mode trunk
  channel-group 1 mode active
  no shutdown

interface port-channel1
  switchport
  switchport mode trunk
  spanning-tree port type network
  vpc peer-link

interface port-channel10
  switchport
  switchport mode trunk
  switchport trunk allowed vlan 1,10
  vpc 10

interface mgmt0
  vrf member management
  ip address 10.88.238.194/29

interface loopback0
  description UNDERLAY-VERIFICATION
  ip address 192.168.3.3/32
```

```
ip router ospf 1 area 0.0.0.0
ip pim sparse-mode

interface loopback1
description OVERLAY-NVE
ip address 192.168.13.1/32
ip address 192.168.13.254/32 secondary
ip router ospf 1 area 0.0.0.0
ip pim sparse-mode

interface loopback10
vrf member tenant-a
ip address 172.16.10.1/32

interface loopback100
vrf member tenant-a
ip address 172.16.10.9/32

interface Vlan10
no shutdown
vrf member tenant-a
no ip redirects
ip address 10.10.10.1/24
no ipv6 redirects
fabric forwarding mode anycast-gateway
ip dhcp relay address 10.10.10.150
ip dhcp relay source-interface loopback100

interface Vlan300
no shutdown
vrf member tenant-a
no ip redirects
ip forward
no ipv6 redirects

interface Vlan777
description BACKUP_UNDERLAY_INFRA-VLAN
no shutdown
no ip redirects
ip address 10.255.77.1/30
no ipv6 redirects
ip ospf network point-to-point
ip router ospf 1 area 0.0.0.0
ip pim sparse-mode

interface Ethernet1/2
ip address 10.102.11.2/30
ip ospf network point-to-point
ip router ospf 1 area 0.0.0.0
ip pim sparse-mode
no shutdown

interface nve1
no shutdown
host-reachability protocol bgp
advertise virtual-rmac
source-interface loopback1
member vni 101010
suppress-arp
mcast-group 224.10.10.10
member vni 303030 associate-vrf
```

```

router ospf 1

router bgp 65000
  address-family ipv4 unicast
  address-family l2vpn evpn
  advertise-pip
  neighbor 192.168.0.11
    remote-as 65000
    update-source loopback0
  address-family l2vpn evpn
    send-community
    send-community extended
  neighbor 192.168.88.2
    remote-as 65000
    description OVERLAY_BACKUP
    update-source Vlan888
  address-family l2vpn evpn
    send-community
    send-community extended
  vrf tenant-a
    address-family ipv4 unicast
    redistribute direct route-map direct_routes_tenant-a
evpn
  vni 101010 12
    rd auto
    route-target import auto
    route-target export auto
  vni 202020 12
    rd auto
    route-target import auto
    route-target export auto

```

LEAF-2-vPC-software

```

nv overlay evpn
feature ospf
feature bgp
feature pim
feature interface-vlan
feature vn-segment-vlan-based
feature lacp
feature dhcp
feature vpc
feature nv overlay

fabric forwarding anycast-gateway-mac 0000.0a0a.0a0a

ip pim rp-address 192.168.11.11 group-list 224.10.10.0/24
ip pim ssm range 232.0.0.0/8

vlan 1,10,20,300,777
vlan 10
  vn-segment 101010
vlan 20
  vn-segment 202020
vlan 300
  vn-segment 303030

```

```
vlan 777
  name BACKUP_VLAN_ROUTING_NVE_INFRA

spanning-tree vlan 1,10,20,300 hello-time 4

ip prefix-list host_subnets seq 5 permit 10.10.10.0/24 le 32
ip prefix-list host_subnets seq 10 permit 192.168.20.0/24 le 32
ip prefix-list host_subnets seq 15 permit 172.16.10.10/32
route-map direct_routes_tenant-a permit 10
  match ip address prefix-list host_subnets

vrf context tenant-a
  vni 303030
  rd auto
  address-family ipv4 unicast
    route-target both auto
    route-target both auto evpn

system nve infra-vlans 777

vpc domain 1
  peer-switch
  peer-keepalive destination 10.88.238.194
  peer-gateway
  layer3 peer-router
  ip arp synchronize

interface Ethernet1/1
  ip address 10.103.11.2/30
  ip ospf network point-to-point
  ip router ospf 1 area 0.0.0.0
  ip pim sparse-mode
  no shutdown

interface Ethernet1/19
  switchport
  switchport mode trunk
  channel-group 1 mode active
  no shutdown
interface port-channel1
  switchport
  switchport mode trunk
  spanning-tree port type network
  vpc peer-link

interface port-channel10
  switchport
  switchport mode trunk
  switchport trunk allowed vlan 1,10,20
  vpc 10

interface mgmt0
  vrf member management
  ip address 10.88.238.195/29

interface loopback0
  description UNDERLAY-VERIFICATION
  ip address 192.168.4.4/32
  ip router ospf 1 area 0.0.0.0
  ip pim sparse-mode

interface loopback1
```



```
description OVERLAY-NVE
ip address 192.168.13.2/32
ip address 192.168.13.254/32 secondary
ip router ospf 1 area 0.0.0.0
ip pim sparse-mode

interface loopback10
vrf member tenant-a
ip address 172.16.10.2/32

interface loopback100
vrf member tenant-a
ip address 172.16.10.10/32

interface Vlan10
no shutdown
vrf member tenant-a
no ip redirects
ip address 10.10.10.1/24
no ipv6 redirects
fabric forwarding mode anycast-gateway
ip dhcp relay address 10.10.10.150
ip dhcp relay source-interface loopback100

interface Vlan20
no shutdown
vrf member tenant-a
no ip redirects
ip address 192.168.20.1/24
no ipv6 redirects
fabric forwarding mode anycast-gateway

interface Vlan300
no shutdown
vrf member tenant-a
no ip redirects
ip forward
no ipv6 redirects

interface Vlan777
description BACKUP_UNDERLAY_INFRA-VLAN
no shutdown
no ip redirects
ip address 10.255.77.2/30
no ipv6 redirects
ip ospf network point-to-point
ip router ospf 1 area 0.0.0.0
ip pim sparse-mode

interface nve1
no shutdown
host-reachability protocol bgp
advertise virtual-rmac
source-interface loopback1
member vni 101010
suppress-arp
mcast-group 224.10.10.10
member vni 202020
suppress-arp
mcast-group 224.10.10.10
member vni 303030 associate-vrf
```

```

router ospf 1

router bgp 65000
  address-family ipv4 unicast
  address-family l2vpn evpn
  advertise-pip
  neighbor 192.168.0.11
    remote-as 65000
    update-source loopback0
  address-family l2vpn evpn
    send-community
    send-community extended
  neighbor 192.168.88.1
    remote-as 65000
    description OVERLAY_BACKUP
    update-source Vlan888
  address-family l2vpn evpn
    send-community
    send-community extended
  vrf tenant-a
    address-family ipv4 unicast
    redistribute direct route-map direct_routes_tenant-a
evpn
  vni 101010 12
    rd auto
    route-target import auto
    route-target export auto
  vni 202020 12
    rd auto
    route-target import auto
    route-target export auto

```

N9K-ACCESS

```

feature lACP

vlan 1,10

interface port-channel10
  switchport
  switchport mode trunk

interface Ethernet1/11
  switchport
  switchport access vlan 10
  no shutdown

interface Ethernet1/45
  switchport
  switchport mode trunk
  channel-group 10 mode active
  no shutdown

interface Ethernet1/46
  switchport
  switchport mode trunk
  channel-group 10 mode active

```

no shutdown

DHCP-configuratie op Nexus-switches

BLAD-1

Stap 1. Schakel de functie DHCP in.

```
LEAF-1(config)# feature dhcp
```

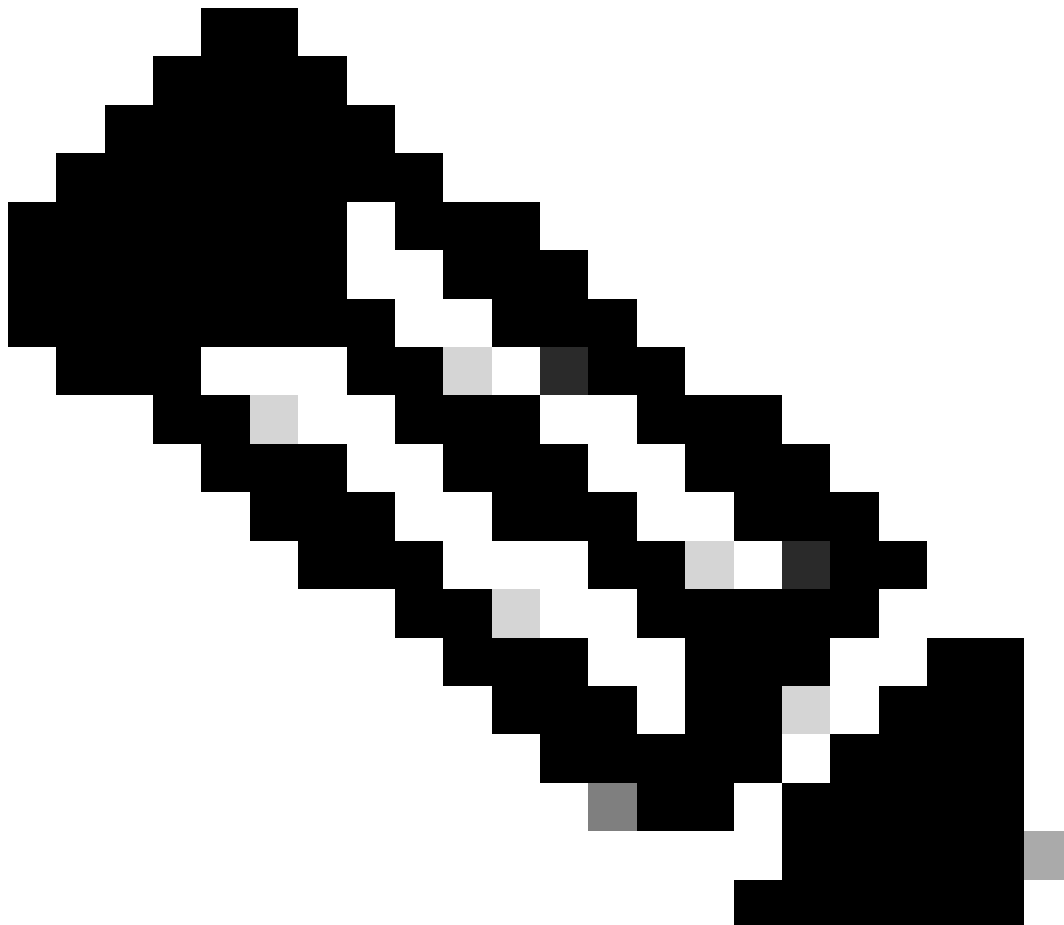

Opmerking: de DHCP-server en de Relay Agent Command Service DHCP, ip DHCP Relay en ipv6 DHCP Relay zijn standaard ingeschakeld sinds NX-OS 7.x.

Stap 2. Pas de optie van de bevelip DHCP relay informatie toe.

```
LEAF-1(config)# ip dhcp relay information option
```

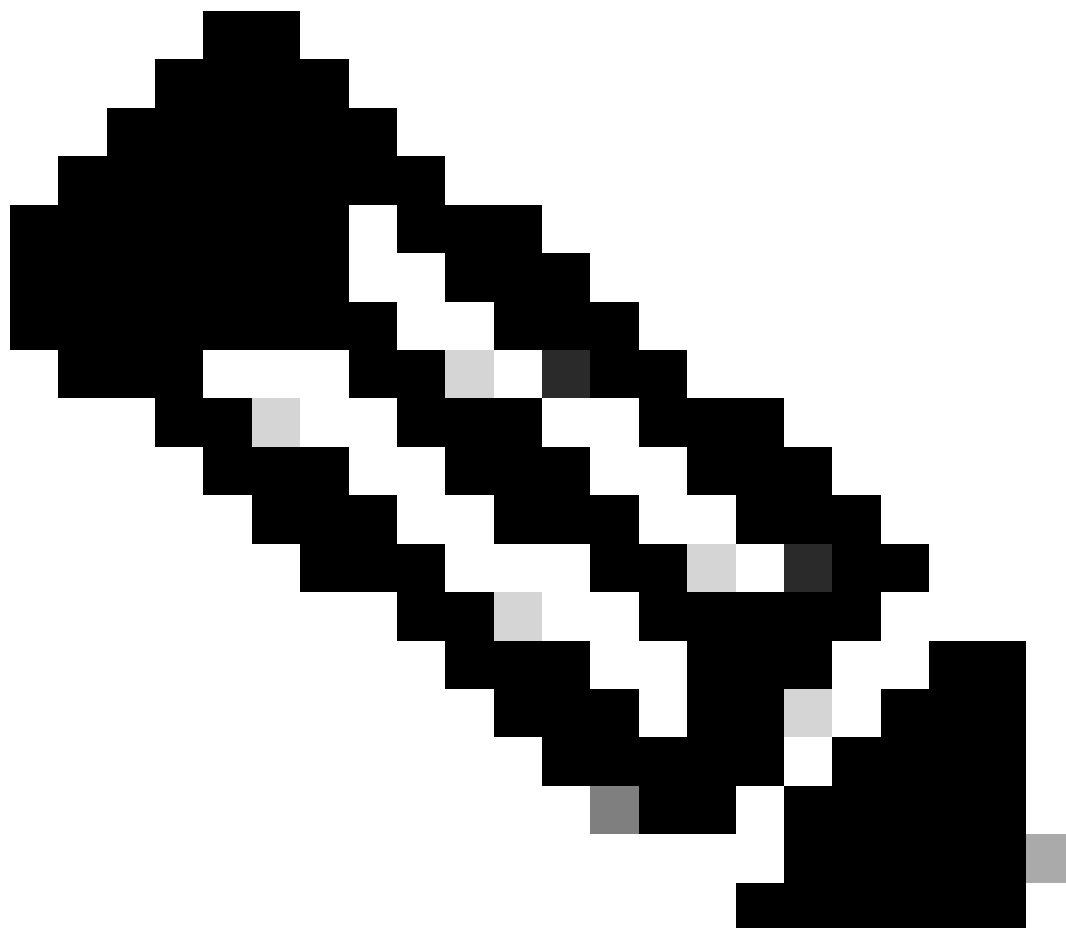

Opmerking: met deze opdracht kan de DHCP Relay-agent optie 82-informatie invoegen en verwijderen over de pakketten die worden doorgestuurd.

Stap 3. Pas de optieoptie VPN toe op opdracht DHCP Relay.

```
LEAF-1(config)# ip dhcp relay information option vpn
```



Opmerking: deze opdracht maakt de DHCP Relay-verzoeken mogelijk die worden ontvangen op verschillende VRF-locaties waar de DHCP-server thuishoort.

Stap 4. Pas het commando "ip dhcp relay address [ip adres van DHCP server]" toe.



Opmerking: in dit voorbeeld is het IP-adres voor DHCP-server 10.10.10.150.

```
LEAF-1(config)# interface v1an 10  
LEAF-1(config-if)# ip dhcp relay address 10.10.10.150
```

Stap 5. Pas de opdracht "ip DHCP Relay bron-interface [unieke loopback]"toe.



Opmerking: met deze opdracht wordt het IP-bronadres van de DHCP Relay-agent geconfigureerd voor de verwerking van Discover, offer, request en ACK voor unicastcommunicatie, die de DHCP Relay-agent het IP-adres van SVI gebruikt als IP-bronadres voor DHCP Relay-agent. Dit is niet gewenst omdat dit IP-adres wordt gedeeld door meerdere VTEP's en zwart-vasthouden van DHCP-pakketten kan gebeuren. Om dit te voorkomen, is een uniek IP-adres (met behulp van een loopback-interface) nodig om elke VTEP te onderscheiden.

```
LEAF-1(config)# interface vlan 10
LEAF-1(config-if)# ip dhcp relay source-interface loopback100
```

Stap 6. In de VRF corresponderende huurder binnen BGP, directe routeherdistributie met een prefix-lijst en route-kaart die het IP-adres van de loopback-interface omvat.

Opmerking: deze loopback interface behoort tot de huurder van SVI.

```
LEAF-1(config)# show running-config interface loopback 100
interface loopback100
  vrf member tenant-a
  ip address 172.16.10.8/32

LEAF-1(config)# ip prefix-list host_subnets seq 15 permit 172.16.10.8/32
LEAF-1(config)# route-map direct_routes_tenant-a permit 10
LEAF-1(config-route-map)# match ip address prefix-list host_subnets
LEAF-1(config-route-map)# router bgp 65000
LEAF-1(config-router)# vrf tenant-a
LEAF-1(config-router-vrf)# address-family ipv4 unicast
LEAF-1(config-router-vrf-af)# redistribute direct route-map direct_routes_tenant-a
```

Stap 7. Controleer dat het IP-adres van de loopback-interface in BGP L2VPN EVPN naar de Spines wordt geadverteerd met de opdracht: `toon bgp l2vpn evpn [loopback IP] vrf [tenant vrf]`.

```
LEAF-1(config)# show bgp l2vpn evpn 172.16.10.8 vrf tenant-a
BGP routing table information for VRF default, address family L2VPN EVPN
Route Distinguisher: 192.168.5.5:4 (L3VNI 303030)
BGP routing table entry for [5]:[0]:[0]:[32]:[172.16.10.8]/224, version 421
Paths: (1 available, best #1)
Flags: (0x000002) (high32 00000000) on xmit-list, is not in l2rib/evpn
```

```
Advertised path-id 1
Path type: local, path is valid, is best path, no labeled nexthop
Gateway IP: 0.0.0.0
AS-Path: NONE, path locally originated
 192.168.5.5 (metric 0) from 0.0.0.0 (192.168.5.5)
  Origin incomplete, MED 0, localpref 100, weight 32768
  Received label 303030
  Extcommunity: RT:65000:303030 ENCAP:8 Router MAC:707d.b9b8.4daf
```

```
Path-id 1 advertised to peers:
 192.168.0.11 <<<< Spine
```

Stap 8. Controleer dat het IP-adres van de loopback-interface is ingespoten in BGP L2VPN EVPN waar DHCP-server is gevestigd.

Opmerking: Als er Nexus-switches in vPC zijn, controleer dan of zij beiden het IP-adres van de loopback-interface in BGP L2VPN EVPN leren.

```
LEAF-1# show bgp l2vpn evpn 172.16.10.8
BGP routing table information for VRF default, address family L2VPN EVPN
Route Distinguisher: 192.168.5.5:4
BGP routing table entry for [5]:[0]:[0]:[32]:[172.16.10.8]/224, version 754
Paths: (1 available, best #1)
Flags: (0x000002) (high32 00000000) on xmit-list, is not in l2rib/evpn, is not in HW

  Advertised path-id 1
  Path type: internal, path is valid, is best path, no labeled nexthop
    Imported to 2 destination(s)
    Imported paths list: tenant-a L3-303030
  Gateway IP: 0.0.0.0
  AS-Path: NONE, path sourced internal to AS
    192.168.5.5 (metric 45) from 192.168.0.11 (192.168.0.11)
      Origin incomplete, MED 0, localpref 100, weight 0
      Received label 303030
      Extcommunity: RT:65000:303030 ENCAP:8 Router MAC:707d.b9b8.4daf
      Originator: 192.168.5.5 Cluster list: 192.168.0.11
```

Path-id 1 not advertised to any peer

Route Distinguisher: 192.168.3.3:4 (L3VNI 303030)
BGP routing table entry for [5]:[0]:[0]:[32]:[172.16.10.8]/224, version 761
Paths: (1 available, best #1)
Flags: (0x000002) (high32 00000000) on xmit-list, is not in l2rib/evpn, is not in HW

Advertised path-id 1

Path type: internal, path is valid, is best path, no labeled nexthop
Imported from 192.168.5.5:4:[5]:[0]:[0]:[32]:[172.16.10.8]/224

Gateway IP: 0.0.0.0

AS-Path: NONE, path sourced internal to AS

192.168.5.5 (metric 45) from 192.168.0.11 (192.168.0.11)

Origin incomplete, MED 0, localpref 100, weight 0

Received label 303030

Extcommunity: RT:65000:303030 ENCAP:8 Router MAC:707d.b9b8.4daf

Originator: 192.168.5.5 Cluster list: 192.168.0.11

Path-id 1 not advertised to any peer

Stap 9. Controleer dat er een route is voor de DHCP-server op de bronhuurder met de opdracht toon ip route [DHCP server IP] vrf [tenant vrf].

Opmerking: de route die moet worden gebruikt, moet van VxLAN tot standaard VRF lopen. Als er geen route beschikbaar is, controleer dan of de VTEP het IP-adres van de DHCP-server lokaal kent.

```
LEAF-1# show running-config interface vlan 10
interface Vlan10
  no shutdown
  vrf member tenant-a <<<< source tenant
  no ip redirects
  ip address 10.10.10.1/24
  no ipv6 redirects
  fabric forwarding mode anycast-gateway
  ip dhcp relay address 10.10.10.150 <<<< DHCP server
  ip dhcp relay source-interface loopback100
```

```
LEAF-1# show ip route 10.10.10.150 vrf tenant-a
10.10.10.150/32, ubest/mbest: 1/0
  *via 192.168.13.254%default, [200/0], 2w0d, bgp-65000, internal, tag 65000, segid: 303030 tunnelid:
```

Stap 10. Controleer dat de DHCP server IP bereikbaar is met de loopback-interface en de corresponderende VRF als een VRF-bron met de opdracht ping [DHCP server IP] bron-interface loopback [x] vrf [tenant vrf].

```
LEAF-1# ping 10.10.10.150 source-interface loopback 100 vrf tenant-a
PING 10.10.10.150 (10.10.10.150): 56 data bytes
64 bytes from 10.10.10.150: icmp_seq=0 ttl=126 time=1.262 ms
64 bytes from 10.10.10.150: icmp_seq=1 ttl=126 time=0.833 ms
64 bytes from 10.10.10.150: icmp_seq=2 ttl=126 time=0.808 ms
64 bytes from 10.10.10.150: icmp_seq=3 ttl=126 time=0.795 ms
64 bytes from 10.10.10.150: icmp_seq=4 ttl=126 time=0.78 ms

--- 10.10.10.150 ping statistics ---
5 packets transmitted, 5 packets received, 0.00% packet loss
```

Stap 11. Controleer de status van de DHCP-relay-agent.

```
LEAF-1# show ip dhcp status
Current CLI Operation: show ip dhcp status
Last CLI Operation: DME: ip dhcp relay information option enable
Last CLI Operation Status: SUCCESS
```

Stap 12. Controleer optie 82, zoals de VPN-optie en het juiste IP-adres van de relay onder de relay-agent.

```
LEAF-1# show ip dhcp relay
DHCP relay service is enabled <<<<<<
Insertion of option 82 is enabled <<<<<<
Insertion of option 82 customize circuitid is disabled
TLV format in CircuitId and RemoteId suboptions is enabled
Insertion of VPN suboptions is enabled <<<<<<<
Insertion of cisco suboptions is disabled
Global smart-relay is disabled
Relay Trusted functionality is disabled
Relay Trusted Port is Globally disabled
V4 Relay Source Address HSRP is Globally disabled
Server-ID-override-disable is disabled
```

Smart-relay is enabled on the following interfaces:

Subnet-broadcast is enabled on the following interfaces:

Relay Trusted Port is enabled on the following interfaces:

Relay Source Address HSRP is enabled on the following interfaces:

Helper addresses are configured on the following interfaces:

Interface	Relay Address	VRF Name
Vlan10	10.10.10.150	<<<<<<<<<

Stap 13. Controleer de statistieken van de verwerkte en verzonden pakketten.

```
LEAF-1# show ip dhcp global statistics
Packets processed 1297177
Packets received through cfsoe 0
Packets forwarded 1297175
Packets forwarded on cfsoe 0
Total packets dropped 0
Packets dropped from untrusted ports 0
Packets dropped due to MAC address check failure 0
Packets dropped due to Option 82 insertion failure 0
Packets dropped due to o/p intf unknown 0
Packets dropped which were unknown 0
Packets dropped due to no trusted ports 0
Packets dropped due to dhcp relay not enabled 0
Packets dropped due to no binding entry 0
Packets dropped due to interface error/no interface 0
Packets dropped due to max hops exceeded 0
Packets dropped due to Queue full 0
```

Stap 14. Controleer de statistieken van relay-pakketten.

```
LEAF-1# show ip dhcp relay statistics
```

```
-----
Message Type           Rx           Tx           Drops
-----
Discover                260521       260520        0
Offer                   289330       289330        0
Request(*)              267162       267161        0
Ack                      8322         8322          0
Release(*)              181121       181121        0
Decline                  1            1             0
Inform(*)                0            0             0
Nack                     289280       289280        0
-----
Total                   1295737     1295735        0
-----
```

DHCP L3 FWD:

```
Total Packets Received      :      0
Total Packets Forwarded     :      0
Total Packets Dropped       :      0
Non DHCP:
Total Packets Received      :      0
Total Packets Forwarded     :      0
```

```
Total Packets Dropped          :          0
DROP:
DHCP Relay not enabled         :          0
Invalid DHCP message type      :          0
Interface error                 :          0
Tx failure towards server      :          0
Tx failure towards client      :          0
Unknown output interface       :          0
Unknown vrf or interface for server :          0
Max hops exceeded              :          0
Option 82 validation failed    :          0
Packet Malformed               :          0
DHCP Request dropped on MCT    :          0
Relay Trusted port not configured :          0
* - These counters will show correct value when switch
receives DHCP request packet with destination ip as broadcast
address. If request is unicast it will be HW switched
```

LEAF-1-vPC DHCP

Stap 1. Schakel de functie DHCP in.

```
LEAF-1-VPC(config)#feature dhcp
```



Opmerking: de DHCP-server en de Relay Agent Command Service DHCP, ip DHCP Relay en ipv6 DHCP Relay zijn standaard ingeschakeld sinds NX-OS 7.x.

Stap 2. Pas de optie van de bevelip DHCP relay informatie toe.

```
LEAF-1-VPC(config)#ip dhcp relay information option
```



Opmerking: met deze opdracht kan de DHCP Relay-agent optie 82-informatie invoegen en verwijderen over de pakketten die worden doorgestuurd.

Stap 3. Pas de opdracht "ip DHCP Relay information option vpn" toe.

```
LEAF-1-VPC(config)# ip dhcp relay information option vpn
```



Opmerking: deze opdracht maakt de DHCP Relay-verzoeken mogelijk die worden ontvangen op verschillende VRF-locaties waar de DHCP-server thuishoort.

Stap 4. Pas het commando `ip dhcp relay adres [ip adres van DHCP server]`.



Opmerking: in dit voorbeeld is het IP-adres voor DHCP-server 10.10.10.150.

```
LEAF-1-VPC(config)#interface vlan 10  
LEAF-1-VPC(config-if)#ip dhcp relay address 10.10.10.150
```

Stap 5. Pas de opdracht "ip DHCP Relay bron-interface [unieke loopback]"toe.



Opmerking: met deze opdracht wordt het IP-adres van de DHCP Relay-agent geconfigureerd voor de verwerking van Discover, offer, request en ACK voor unicastcommunicatie, die de DHCP Relay-agent het IP-adres van SVI gebruikt als IP-adres voor DHCP Relay-agent. Dit is niet gewenst omdat dit IP-adres wordt gedeeld door meerdere VTEP's en zwart-vasthouden van DHCP-pakketten kan gebeuren. Om dit te voorkomen, is een uniek IP-adres (met behulp van een loopback-interface) nodig om elke VTEP te onderscheiden.

```
LEAF-1-VPC(config)#interface vlan 10
LEAF-1-VPC(config-if)# ip dhcp relay source-interface loopback100
```

Stap 6. In de VRF corresponderende huurder binnen BGP, directe routeherdistributie met een prefix-lijst en route-kaart die het IP-adres van de loopback-interface omvat.

Opmerking: deze loopback interface behoort tot de huurder van SVI.

```
LEAF-1-VPC(config)# show running-config interface loopback 100
interface loopback100
  vrf member tenant-a
  ip address 172.16.10.9/32

LEAF-1-VPC(config)# ip prefix-list host_subnets seq 15 permit 172.16.10.9/32
LEAF-1-VPC(config)# route-map direct_routes_tenant-a permit 10
LEAF-1-VPC(config-route-map)# match ip address prefix-list host_subnets
LEAF-1-VPC(config-route-map)# router bgp 65000
LEAF-1-VPC(config-router)# vrf tenant-a
LEAF-1-VPC(config-router-vrf)# address-family ipv4 unicast
LEAF-1-VPC(config-router-vrf-af)# redistribute direct route-map direct_routes_tenant-a
```

Stap 7. Controleer dat het IP-adres van de loopback-interface in BGP L2VPN EVPN naar de Spines wordt geadverteerd met de opdracht: `toon bgp l2vpn evpn [loopback IP] vrf [tenant vrf]`.

```
LEAF-1-VPC# show bgp l2vpn evpn 172.16.10.9 vrf tenant-a
BGP routing table information for VRF default, address family L2VPN EVPN
Route Distinguisher: 192.168.3.3:4 (L3VNI 303030)
BGP routing table entry for [5]:[0]:[0]:[32]:[172.16.10.9]/224, version 637
Paths: (1 available, best #1)
Flags: (0x000002) (high32 00000000) on xmit-list, is not in l2rib/evpn
```

```
Advertised path-id 1
Path type: local, path is valid, is best path, no labeled nexthop
Gateway IP: 0.0.0.0
AS-Path: NONE, path locally originated
 192.168.13.1 (metric 0) from 0.0.0.0 (192.168.3.3)
  Origin incomplete, MED 0, localpref 100, weight 32768
  Received label 303030
  Extcommunity: RT:65000:303030 ENCAP:8 Router MAC:6026.aa85.9887
```

```
Path-id 1 advertised to peers:
 192.168.0.11
```

Stap 8. Controleer dat het IP-adres van de loopback-interface is ingespoten in BGP L2VPN EVPN waar DHCP-server is gevestigd.

Opmerking: Als er Nexus-switches in vPC zijn, controleer dan of zij beiden het IP-adres van de loopback-interface in BGP L2VPN EVPN leren.

```
LEAF-1-VPC# show bgp l2vpn evpn 172.16.10.9
BGP routing table information for VRF default, address family L2VPN EVPN
Route Distinguisher: 192.168.3.3:4 (L3VNI 303030)
BGP routing table entry for [5]:[0]:[0]:[32]:[172.16.10.9]/224, version 637
Paths: (1 available, best #1)
Flags: (0x000002) (high32 00000000) on xmit-list, is not in l2rib/evpn
```

```
Advertised path-id 1
Path type: local, path is valid, is best path, no labeled nexthop
Gateway IP: 0.0.0.0
AS-Path: NONE, path locally originated
 192.168.13.1 (metric 0) from 0.0.0.0 (192.168.3.3)
  Origin incomplete, MED 0, localpref 100, weight 32768
  Received label 303030
  Extcommunity: RT:65000:303030 ENCAP:8 Router MAC:6026.aa85.9887
```

```
Path-id 1 advertised to peers:
 192.168.0.11
```

Stap 9. Controleer dat er een route is voor de DHCP-server op de bronhuurder met de opdracht
toon ip route [DHCP server IP] vrf[tenant vrf].

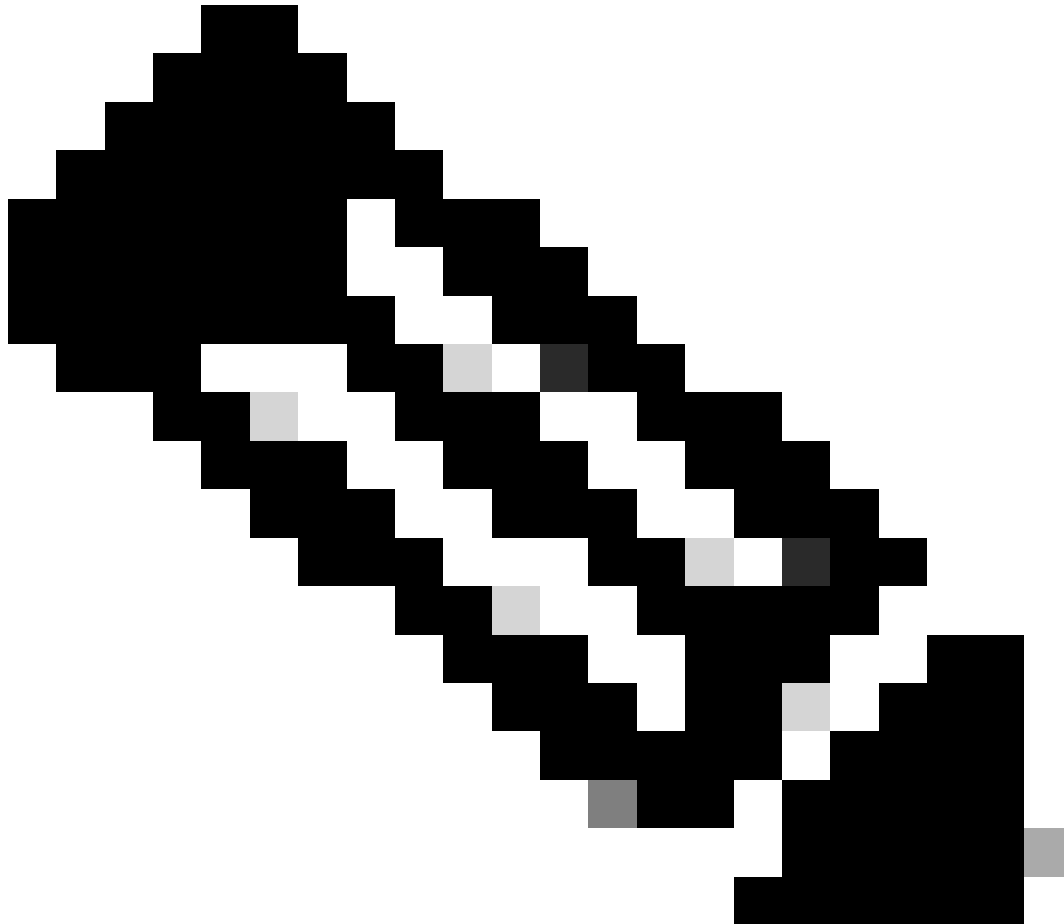

Opmerking: de route die moet worden gebruikt, moet van VxLAN tot standaard VRF lopen. Als er geen route beschikbaar is, controleer dan of de VTEP het IP-adres van de DHCP-server lokaal kent.

```
LEAF-1-VPC# show running-config interface vlan 10
interface Vlan10
  no shutdown
  vrf member tenant-a <<<< source tenant
  no ip redirects
  ip address 10.10.10.1/24
  no ipv6 redirects
  fabric forwarding mode anycast-gateway
  ip dhcp relay address 10.10.10.150
  ip dhcp relay source-interface loopback100
```



```
LEAF-1-VPC# show ip route 10.10.10.150 vrf tenant-a
10.10.10.150/32, ubest/mbest: 1/0, attached
    *via 10.10.10.150, Vlan10, [190/0], 6d07h, hmm
```

Step 10. Controleer of de DHCP server IP bereikbaar is met de loopback-interface en de corresponderende VRF als een VRF-bron met de opdracht ping [DHCP server IP] bron-interface loopback [x] vrf [tenvrf].

```
LEAF-1-VPC# ping 10.10.10.150 source-interface loopback 100 vrf tenant-a
PING 10.10.10.150 (10.10.10.150): 56 data bytes
64 bytes from 10.10.10.150: icmp_seq=0 ttl=126 time=0.965 ms
64 bytes from 10.10.10.150: icmp_seq=1 ttl=126 time=0.57 ms
64 bytes from 10.10.10.150: icmp_seq=2 ttl=126 time=0.488 ms
64 bytes from 10.10.10.150: icmp_seq=3 ttl=126 time=0.524 ms
64 bytes from 10.10.10.150: icmp_seq=4 ttl=126 time=0.502 ms

--- 10.10.10.150 ping statistics ---
```

Step 11. Controleer de status van de DHCP-relay-agent.

```
LEAF-1-VPC# show ip dhcp status
Current CLI Operation: show ip dhcp status
Last CLI Operation: DME: ip dhcp relay information option vpn enable
Last CLI Operation Status: SUCCESS
```

Step 12. Controleer optie 82, zoals de VPN-optie en het juiste IP-adres van de relay onder de relay-agent.

```
LEAF-1-VPC# show ip dhcp relay
DHCP relay service is enabled <<<<<<
Insertion of option 82 is enabled <<<<<<<
Insertion of option 82 customize circuitid is disabled
TLV format in CircuitId and RemoteId suboptions is enabled
Insertion of VPN suboptions is enabled <<<<<<<
Insertion of cisco suboptions is disabled
Global smart-relay is disabled
Relay Trusted functionality is disabled
Relay Trusted Port is Globally disabled
V4 Relay Source Address HSRP is Globally disabled
Server-ID-override-disable is disabled
```

Smart-relay is enabled on the following interfaces:

Subnet-broadcast is enabled on the following interfaces:

Relay Trusted Port is enabled on the following interfaces:

Relay Source Address HSRP is enabled on the following interfaces:

Helper addresses are configured on the following interfaces:

Interface	Relay Address	VRF Name
-----	-----	-----
Vlan10	10.10.10.150	<<<<<<<<<

Stap 13. Controleer de statistieken van verwerkte en verzonden pakketten.

```
LEAF-1-VPC# show ip dhcp global statistics
Packets processed 263162
Packets received through cfsoe 0
Packets forwarded 263161
Packets forwarded on cfsoe 0
Total packets dropped 0
Packets dropped from untrusted ports 0
Packets dropped due to MAC address check failure 0
Packets dropped due to Option 82 insertion failure 0
Packets dropped due to o/p intf unknown 0
Packets dropped which were unknown 0
Packets dropped due to no trusted ports 0
Packets dropped due to dhcp relay not enabled 0
Packets dropped due to no binding entry 0
Packets dropped due to interface error/no interface 0
Packets dropped due to max hops exceeded 0
Packets dropped due to Queue full 0
```

Stap 14. Controleer de statistieken van relay-pakketten.

```
LEAF-1-VPC# show ip dhcp relay statistics
```

Message Type	Rx	Tx	Drops
Discover	8	7	0
Offer	29304	29304	0
Request(*)	5029	5029	0
Ack	6535	6535	0
Release(*)	191482	191482	0
Decline	0	0	0
Inform(*)	3	3	0
Nack	29281	29281	0
Total	261642	261641	0

```
DHCP L3 FWD:
Total Packets Received : 0
```

```
Total Packets Forwarded      :      0
Total Packets Dropped        :      0
Non DHCP:
Total Packets Received       :      0
Total Packets Forwarded     :      0
Total Packets Dropped        :      0
DROP:
DHCP Relay not enabled      :      0
Invalid DHCP message type   :      0
Interface error             :      0
Tx failure towards server   :      0
Tx failure towards client   :      0
Unknown output interface    :      0
Unknown vrf or interface for server :      0
Max hops exceeded           :      0
Option 82 validation failed :      0
Packet Malformed            :      0
DHCP Request dropped on MCT :      0
Relay Trusted port not configured :      0
* - These counters will show correct value when switch
receives DHCP request packet with destination ip as broadcast
address. If request is unicast it will be HW switched
```

LEAF-2-vPC DHCP

Stap 1. Schakel de functie DHCP in.

```
LEAF-2-VPC(config)# feature dhcp
```



Opmerking: de DHCP-server en de Relay Agent Command service DHCP, ip DHCP Relay en ipv6 DHCP Relay zijn standaard ingeschakeld sinds NX-OS 7.x.

Stap 2. Pas de opdracht "ip DHCP Relay Information Option" toe.

```
LEAF-2-VPC(config)# ip dhcp relay information option
```



Opmerking: met deze opdracht kan de DHCP Relay-agent optie 82-informatie invoegen en verwijderen over de pakketten die worden doorgestuurd.

Stap 3. Pas de opdracht "ip DHCP Relay information option vpn" toe.

```
LEAF-2-VPC(config)# ip dhcp relay information option vpn
```



Opmerking: deze opdracht maakt de DHCP Relay-verzoeken mogelijk die worden ontvangen op verschillende VRF-locaties waar de DHCP-server thuishoort.

Stap 4. Pas het commando "ip dhcp relay address [ip adres van DHCP server]" toe.

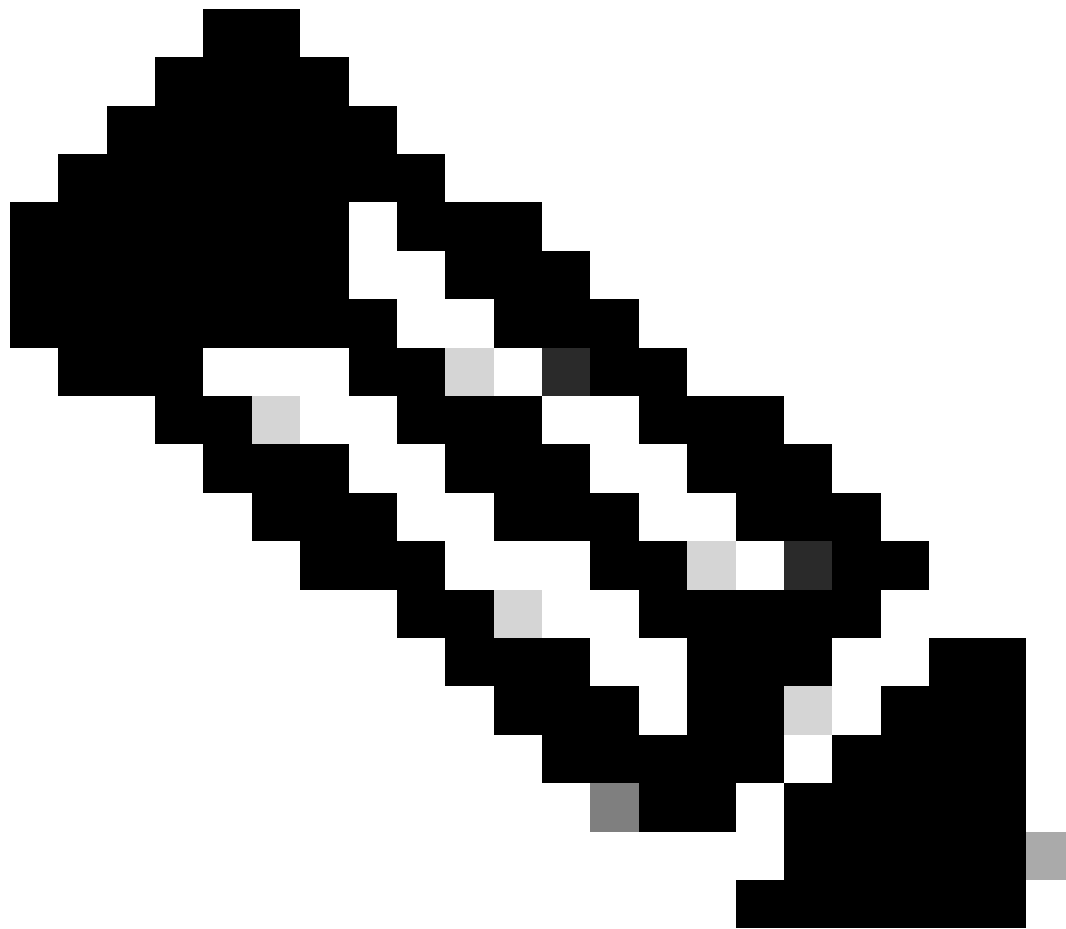

Opmerking: in dit voorbeeld is het IP-adres voor DHCP-server 10.10.10.150.

```
LEAF-2-VPC(config)# interface vlan 10  
LEAF-2-VPC(config-if)# ip dhcp relay address 10.10.10.150
```

Stap 5. Pas de opdracht "ip DHCP Relay bron-interface [unieke loopback]"toe.



Opmerking: met deze opdracht wordt het IP-bronadres van de DHCP Relay-agent geconfigureerd voor de verwerking van Discover, offer, request en ACK voor unicastcommunicatie, die de DHCP Relay-agent het IP-adres van SVI gebruikt als IP-bronadres voor DHCP Relay-agent. Dit is niet gewenst omdat dit IP-adres wordt gedeeld door meerdere VTEP's en zwart-vasthouden van DHCP-pakketten kan gebeuren. Om dit te voorkomen, is een uniek IP-adres (met behulp van een loopback-interface) nodig om elke VTEP te onderscheiden.

```
LEAF-2-VPC(config)# interface vlan 10
LEAF-2-VPC(config-if)# ip dhcp relay source-interface loopback 100
```

Stap 6. In de VRF corresponderende huurder binnen BGP, directe routeherdistributie met een prefix-lijst en route-kaart die het IP-adres van de loopback-interface omvat.

Opmerking: deze loopback interface behoort tot de huurder van SVI.

```
LEAF-2-VPC(config-if)# show running-config interface loopback 100
interface loopback100
  vrf member tenant-a
  ip address 172.16.10.10/32

LEAF-2-VPC(config)# ip prefix-list host_subnets seq 15 permit 172.16.10.10/32
LEAF-2-VPC(config)# route-map direct_routes_tenant-a permit 10
LEAF-2-VPC(config-route-map)# match ip address prefix-list host_subnets
LEAF-2-VPC(config-route-map)# router bgp 65000
LEAF-2-VPC(config-router)# vrf tenant-a
LEAF-2-VPC(config-router-vrf)# address-family ipv4 unicast
LEAF-2-VPC(config-router-vrf-af)# redistribute direct route-map direct_routes_tenant-a
```

Stap 7. Controleer dat het IP-adres van de loopback-interface in BGP L2VPN EVPN naar de Spines wordt geadverteerd met de opdracht: `toon bgp l2vpn evpn [loopback IP] vrf [tenant vrf]`.

```
LEAF-2-VPC(config-if)# show bgp l2vpn evpn 172.16.10.10 vrf tenant-a
BGP routing table information for VRF default, address family L2VPN EVPN
Route Distinguisher: 192.168.4.4:4 (L3VNI 303030)
BGP routing table entry for [5]:[0]:[0]:[32]:[172.16.10.10]/224, version 49
5
Paths: (1 available, best #1)
Flags: (0x000002) (high32 00000000) on xmit-list, is not in l2rib/evpn

Advertised path-id 1
Path type: local, path is valid, is best path, no labeled nexthop
Gateway IP: 0.0.0.0
AS-Path: NONE, path locally originated
  192.168.13.2 (metric 0) from 0.0.0.0 (192.168.4.4)
    Origin incomplete, MED 0, localpref 100, weight 32768
    Received label 303030
    Extcommunity: RT:65000:303030 ENCAP:8 Router MAC:6026.aa85.9587

Path-id 1 advertised to peers:
  192.168.0.11 <<<<< Spine
```

Stap 8. Controleer dat het IP-adres van de loopback-interface is ingespoten in BGP L2VPN EVPN waar DHCP-server is gevestigd.

Opmerking: Als er Nexus-switches in vPC zijn, controleer dan of zij beiden het IP-adres van de loopback-interface in BGP L2VPN EVPN leren.

```
LEAF-2-VPC(config-if)# show bgp l2vpn evpn 172.16.10.10
BGP routing table information for VRF default, address family L2VPN EVPN
Route Distinguisher: 192.168.4.4:4 (L3VNI 303030)
BGP routing table entry for [5]:[0]:[0]:[32]:[172.16.10.10]/224, version 49
5
Paths: (1 available, best #1)
Flags: (0x000002) (high32 00000000) on xmit-list, is not in l2rib/evpn

Advertised path-id 1
Path type: local, path is valid, is best path, no labeled nexthop
Gateway IP: 0.0.0.0
AS-Path: NONE, path locally originated
 192.168.13.2 (metric 0) from 0.0.0.0 (192.168.4.4)
  Origin incomplete, MED 0, localpref 100, weight 32768
  Received label 303030
  Extcommunity: RT:65000:303030 ENCAP:8 Router MAC:6026.aa85.9587

Path-id 1 advertised to peers:
```

192.168.0.11

Stap 9. Controleer dat er een route is voor de DHCP-server op de bronhuurder met de opdracht `toon ip route [DHCP server IP] vrf[tenvrf]`.

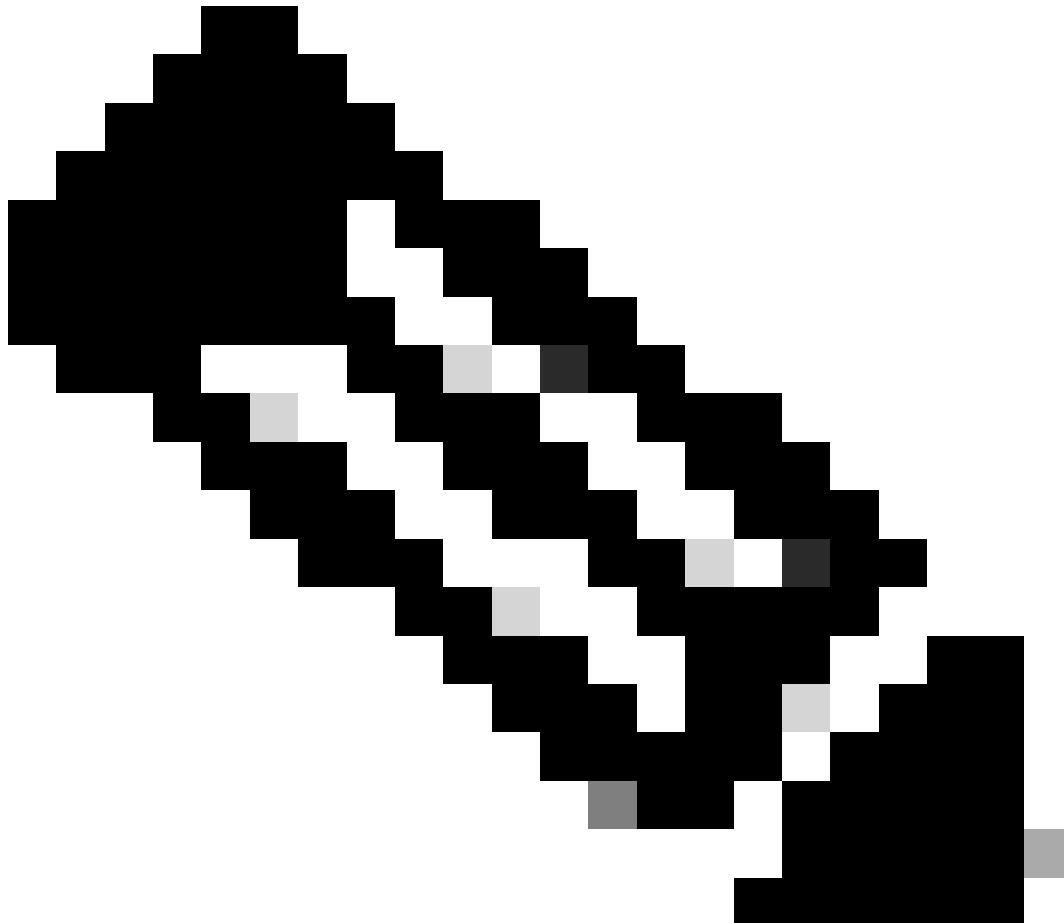

Opmerking: de route die moet worden gebruikt, moet van VxLAN tot standaard VRF lopen. Als er geen route beschikbaar is, controleer dan of de VTEP het IP-adres van de DHCP-server lokaal kent.

```
LEAF-2-VPC(config-if)# show running-config interface vlan 10
interface Vlan10
  no shutdown
  vrf member tenant-a
  no ip redirects
  ip address 10.10.10.1/24
  no ipv6 redirects
  fabric forwarding mode anycast-gateway
  ip dhcp relay address 10.10.10.150
```

```
ip dhcp relay source-interface loopback100
```

```
LEAF-2-VPC(config-if)# show ip route 10.10.10.150 vrf tenant-a  
10.10.10.150/32, ubest/mbest: 1/0, attached  
*via 10.10.10.150, Vlan10, [190/0], 01:01:28, hmm
```

Step 10. Controleer dat de DHCP server IP bereikbaar is met de loopback-interface en de corresponderende VRF als een VRF-bron met de opdracht ping [DHCP server IP] bron-interface loopback [x] vrf [tenant vrf].

```
LEAF-2-VPC(config-if)# ping 10.10.10.150 source-interface loopback 100 vrf tenant-a  
PING 10.10.10.150 (10.10.10.150): 56 data bytes  
64 bytes from 10.10.10.150: icmp_seq=0 ttl=127 time=0.928 ms  
64 bytes from 10.10.10.150: icmp_seq=1 ttl=127 time=0.475 ms  
64 bytes from 10.10.10.150: icmp_seq=2 ttl=127 time=0.455 ms  
64 bytes from 10.10.10.150: icmp_seq=3 ttl=127 time=0.409 ms  
64 bytes from 10.10.10.150: icmp_seq=4 ttl=127 time=0.465 ms  
  
--- 10.10.10.150 ping statistics ---
```

Step 11. Controleer de status van de DHCP-relay-agent.

```
LEAF-2-VPC(config)# show ip dhcp status  
Current CLI Operation: show ip dhcp status  
Last CLI Operation: DME: ip dhcp relay information option vpn enable  
Last CLI Operation Status: SUCCESS
```

Step 12. Controleer optie 82, zoals de VPN-optie en het juiste IP-adres van de relay onder de relay-agent.

```
LEAF-2-VPC(config)# show ip dhcp relay  
DHCP relay service is enabled <<<<<<<<  
Insertion of option 82 is enabled <<<<<<<<<<<<  
Insertion of option 82 customize circuitid is disabled  
TLV format in CircuitId and RemoteId suboptions is enabled  
Insertion of VPN suboptions is enabled <<<<<<<<  
Insertion of cisco suboptions is disabled  
Global smart-relay is disabled  
Relay Trusted functionality is disabled  
Relay Trusted Port is Globally disabled  
V4 Relay Source Address HSRP is Globally disabled  
Server-ID-override-disable is disabled
```

```
Smart-relay is enabled on the following interfaces:  
-----
```

```
Subnet-broadcast is enabled on the following interfaces:
```

Relay Trusted Port is enabled on the following interfaces:

Relay Source Address HSRP is enabled on the following interfaces:

Helper addresses are configured on the following interfaces:

Interface	Relay Address	VRF Name
Vlan10	10.10.10.150	<<<<

Stap 13. Controleer de statistieken van verwerkte en verzonden pakketten.

```
LEAF-2-VPC(config)# show ip dhcp global statistics
Packets processed 103030
Packets received through cfsoe 0
Packets forwarded 103030
Packets forwarded on cfsoe 0
Total packets dropped 0
Packets dropped from untrusted ports 0
Packets dropped due to MAC address check failure 0
Packets dropped due to Option 82 insertion failure 0
Packets dropped due to o/p intf unknown 0
Packets dropped which were unknown 0
Packets dropped due to no trusted ports 0
Packets dropped due to dhcp relay not enabled 0
Packets dropped due to no binding entry 0
Packets dropped due to interface error/no interface 0
Packets dropped due to max hops exceeded 0
Packets dropped due to Queue full 0
```

Stap 14. Controleer de statistieken van relay-pakketten.

```
LEAF-2-VPC# show ip dhcp relay statistics
```

Message Type	Rx	Tx	Drops
Discover	29312	29311	0
Offer	300001	300001	0
Request(*)	29324	29324	0
Ack	1574	1574	0
Release(*)	191493	191493	0
Decline	0	0	0
Inform(*)	1540	1540	0
Nack	472890	472890	0
Total	1026134	1026133	0

```

DHCP L3 FWD:
Total Packets Received      :      0
Total Packets Forwarded    :      0
Total Packets Dropped      :      0
Non DHCP:
Total Packets Received      :      0
Total Packets Forwarded    :      0
Total Packets Dropped      :      0
DROP:
DHCP Relay not enabled     :      0
Invalid DHCP message type  :      0
Interface error            :      0
Tx failure towards server  :      0
Tx failure towards client  :      0
Unknown output interface   :      0
Unknown vrf or interface for server :      0
Max hops exceeded          :      0
Option 82 validation failed :      0
Packet Malformed           :      0
DHCP Request dropped on MCT :      0
Relay Trusted port not configured :      0
* - These counters will show correct value when switch
receives DHCP request packet with destination ip as broadcast
address. If request is unicast it will be HW switched

```

DHCP-serverconfiguratie op Windows Server 2022

IP-adresseringstoepassingsconfiguratie voor hosts.

Stap 1. Open Server Manager en bevestig dat er geen alarmen op DCHP Server in het Dashboard zijn.

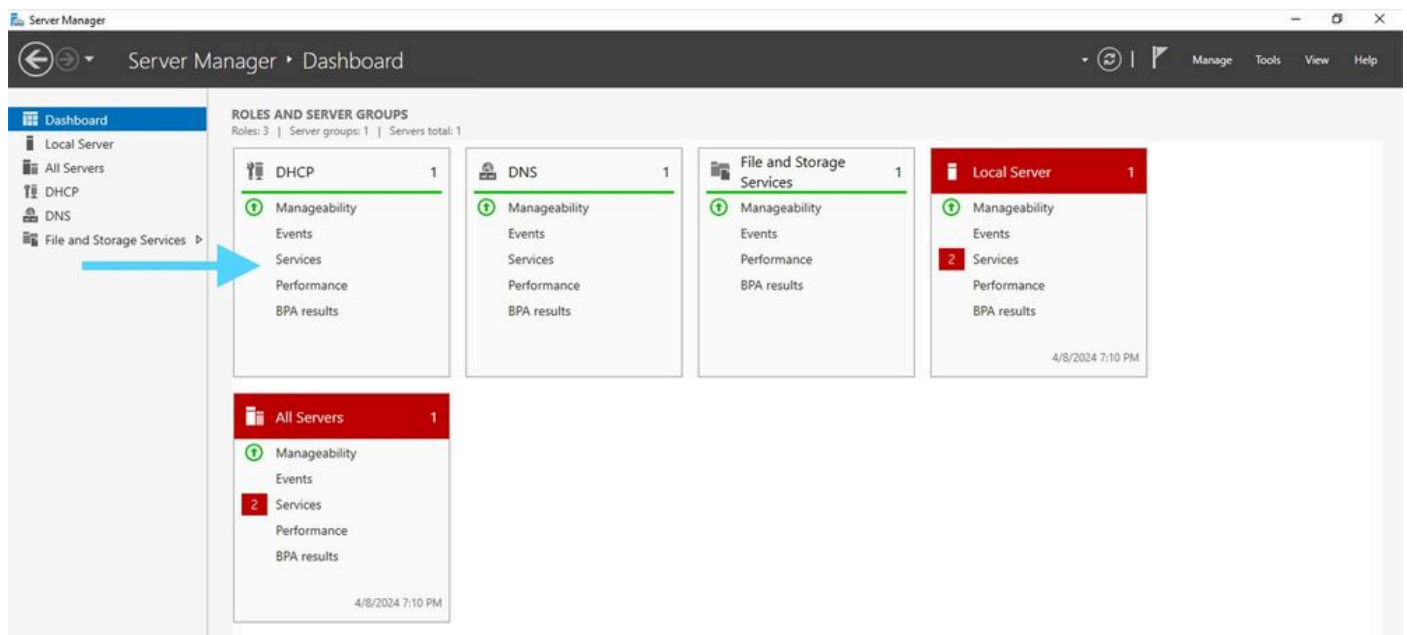

Dashboard van Server Manager op Windows Server 2022

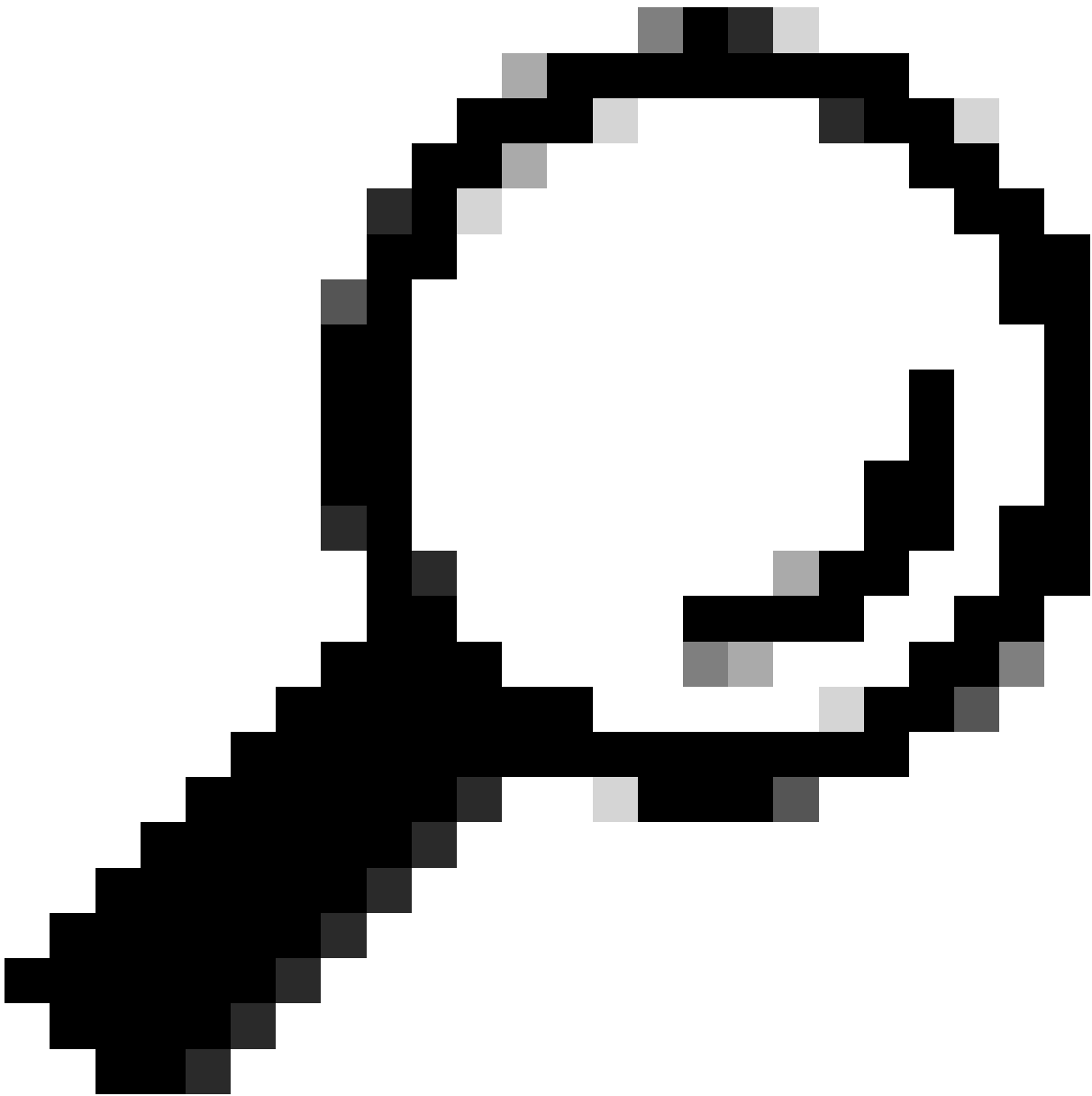

Tip: het beeld wordt vergroot door te dubbelklikken.

Stap 2. Open DHCP-servertoepassing.



DHCP-server op Windows Server 2022

Stap 3. Klik met de rechtermuisknop op IPv4 en klik op Nieuw bereik.

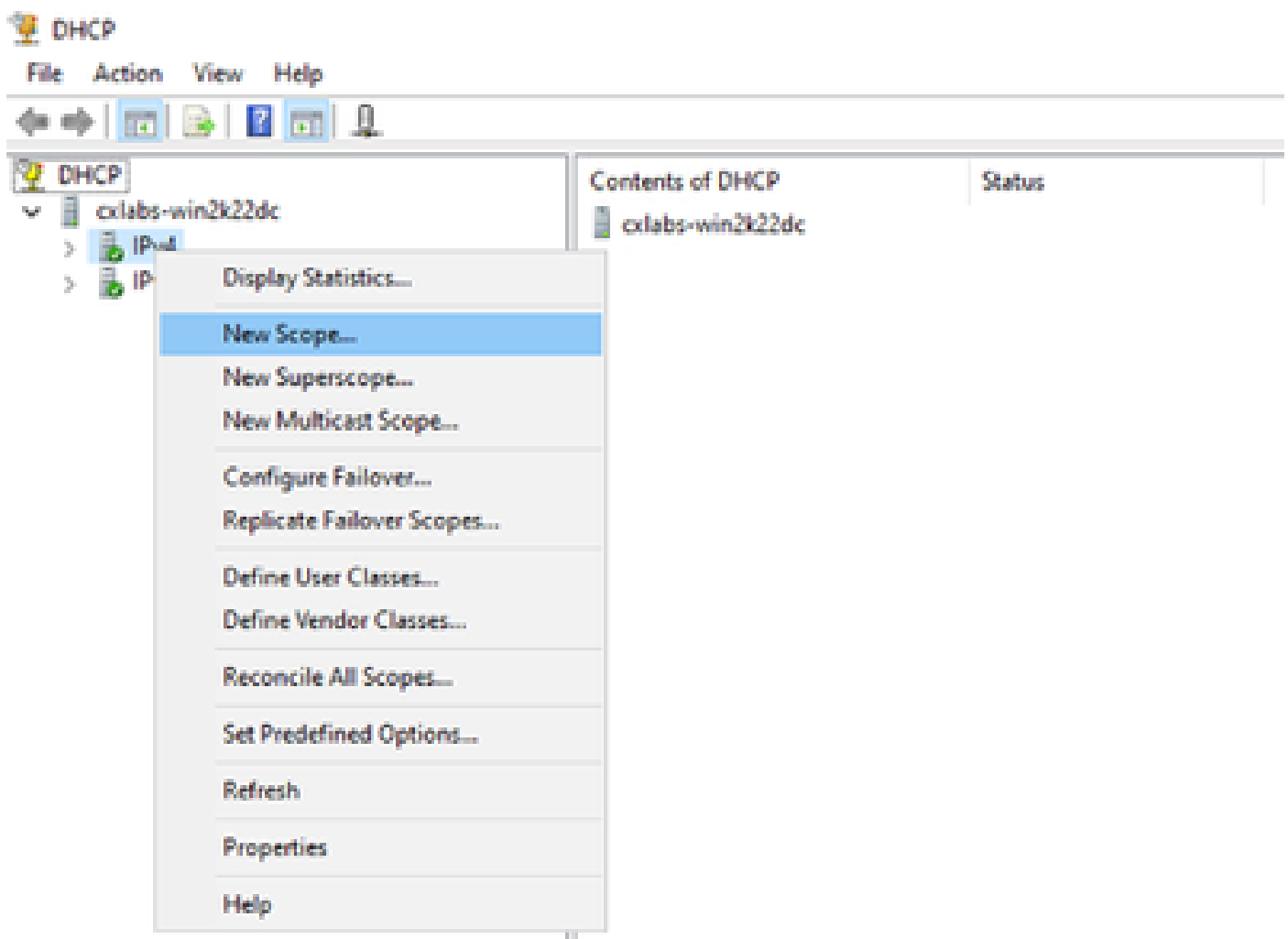

Stap 4. Klik op Next (Volgende).

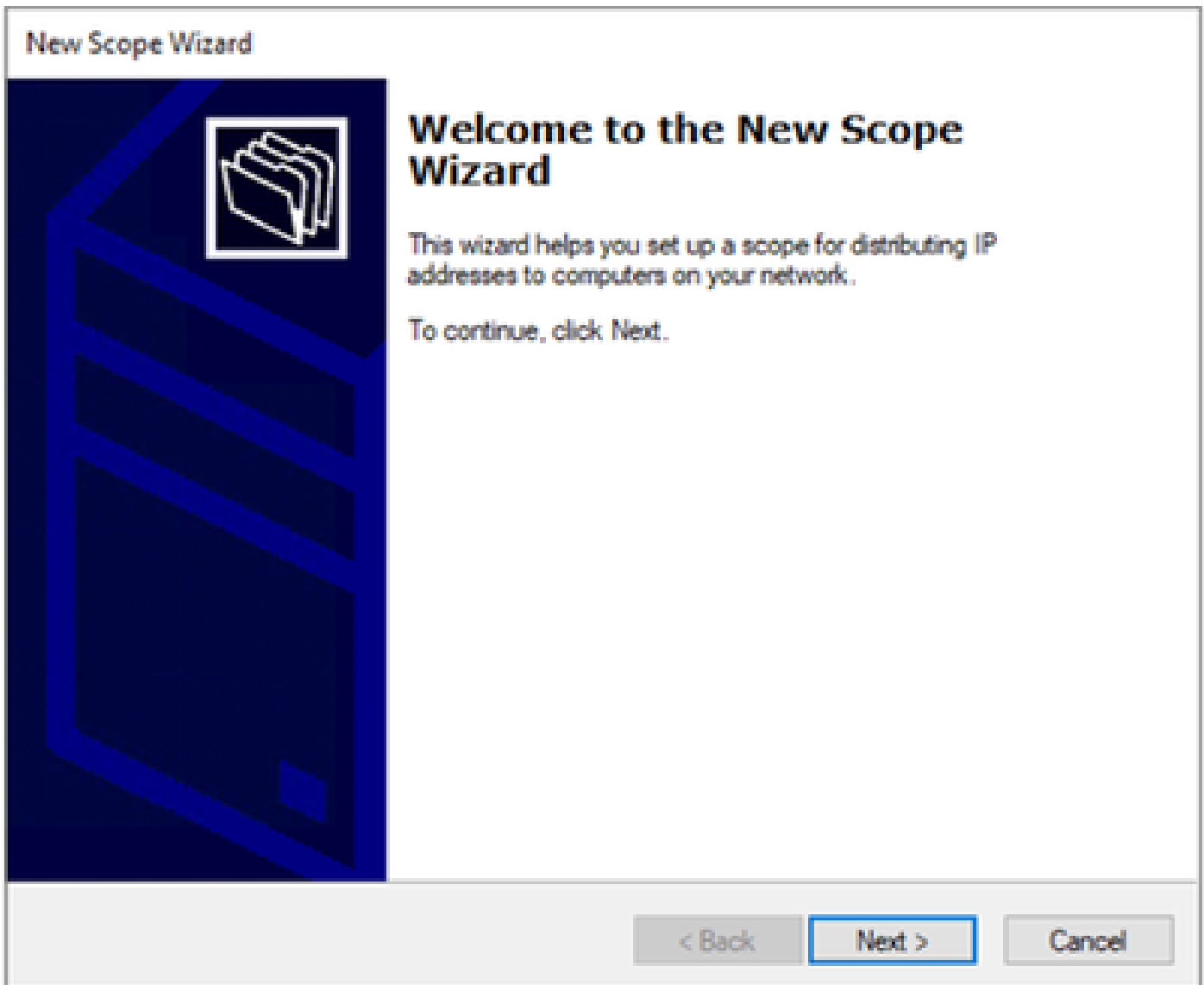

Stap 5. Schrijf een naam en een beschrijving. In dit voorbeeld is de naam het subnet dat tot VLAN 10 behoort en de beschrijving is L2VNI als L2VNI vermeld aan VLAN 10.

New Scope Wizard

Scope Name

You have to provide an identifying scope name. You also have the option of providing a description.



Type a name and description for this scope. This information helps you quickly identify how the scope is to be used on your network.

Name:

Description:

Stap 6. Configureer het IP-adresbereik. Dit is het zwembad voor gastheren.

New Scope Wizard

IP Address Range

You define the scope address range by identifying a set of consecutive IP addresses.



Configuration settings for DHCP Server

Enter the range of addresses that the scope distributes.

Start IP address:

End IP address:

Configuration settings that propagate to DHCP Client

Length:

Subnet mask:

< Back

Next >

Cancel

Stap 6. Sluit het gedeelde IP-adres uit van de SVI-configuratie in de VTEP's. In dit voorbeeld heeft interface VLAN 10 adres IP.10.10.1/24.



Waarschuwing: het niet uitsluiten van het IP-adres van de SVI (of de standaardgateway) kan leiden tot duplicatie van IP-adressen en de levering van verkeersgegevens beïnvloeden.

```
LEAF-1# show running-config interface vlan 10
<snip>
interface Vlan10
  no shutdown
  vrf member tenant-a
  no ip redirects
  ip address 10.10.10.1/24
  no ipv6 redirects
  fabric forwarding mode anycast-gateway
  ip dhcp relay address 10.10.10.150
  ip dhcp relay source-interface loopback100
```

New Scope Wizard

Add Exclusions and Delay

Exclusions are addresses or a range of addresses that are not distributed by the server. A delay is the time duration by which the server will delay the transmission of a DHCP OFFER message.



Type the IP address range that you want to exclude. If you want to exclude a single address, type an address in Start IP address only.

Start IP address:

End IP address:

Add

Excluded address range:

Address 10.10.10.1

Remove

Subnet delay in milli second:

< Back

Next >

Cancel

Stap 7. Configureer de leaseduur van IP-adres. Dit verwijst naar de hoeveelheid tijd die een host kan gebruiken het toegewezen IP-adres voordat het wordt verlengd.

New Scope Wizard

Lease Duration

The lease duration specifies how long a client can use an IP address from this scope.



Lease durations should typically be equal to the average time the computer is connected to the same physical network. For mobile networks that consist mainly of portable computers or dial-up clients, shorter lease durations can be useful. Likewise, for a stable network that consists mainly of desktop computers at fixed locations, longer lease durations are more appropriate.

Set the duration for scope leases when distributed by this server.

Limited to:

Days:

Hours:

Minutes:

< Back

Next >

Cancel

Stap 8. Selecteer Ja, ik wil deze opties nu configureren.

New Scope Wizard

Configure DHCP Options

You have to configure the most common DHCP options before clients can use the scope.



When clients obtain an address, they are given DHCP options such as the IP addresses of routers (default gateways), DNS servers, and WINS settings for that scope.

The settings you select here are for this scope and override settings configured in the Server Options folder for this server.

Do you want to configure the DHCP options for this scope now?

- Yes, I want to configure these options now
- No, I will configure these options later

< Back

Next >

Cancel

Stap 9. Configureer het standaard-gateway IP-adres.

New Scope Wizard

Router (Default Gateway)

You can specify the routers, or default gateways, to be distributed by this scope.



To add an IP address for a router used by clients, enter the address below.

IP address:

Add

Remove

Up

Down

< Back

Next >

Cancel

Stap 10. Domeinnaam en DNS-server configureren.

New Scope Wizard

Domain Name and DNS Servers

The Domain Name System (DNS) maps and translates domain names used by clients on your network.



You can specify the parent domain you want the client computers on your network to use for DNS name resolution.

Parent domain:

To configure scope clients to use DNS servers on your network, enter the IP addresses for those servers.

Server name:

IP address:

Stap 11. Configureer de WINS-server indien van toepassing. Dit kan worden overgeslagen als de informatie niet bekend is.

New Scope Wizard

WINS Servers

Computers running Windows can use WINS servers to convert NetBIOS computer names to IP addresses.



Entering server IP addresses here enables Windows clients to query WINS before they use broadcasts to register and resolve NetBIOS names.

Server name:

Resolve

IP address:

Add

Remove

Up

Down

To change this behavior for Windows DHCP clients modify option 046, WINS/NBT Node Type, in Scope Options.

< Back

Next >

Cancel

Stap 12. Selecteer Ja, ik wil deze scope nu activeren.

New Scope Wizard

Activate Scope

Clients can obtain address leases only if a scope is activated.



Do you want to activate this scope now?

- Yes, I want to activate this scope now
- No, I will activate this scope later

< Back

Next >

Cancel

Het instellen van de scope voor unieke IP-adressen van loopbacks in SVI als DHCP relay agent.

Stap 1. Klik met de rechtermuisknop op IPv4 en selecteer IPv4Scope.

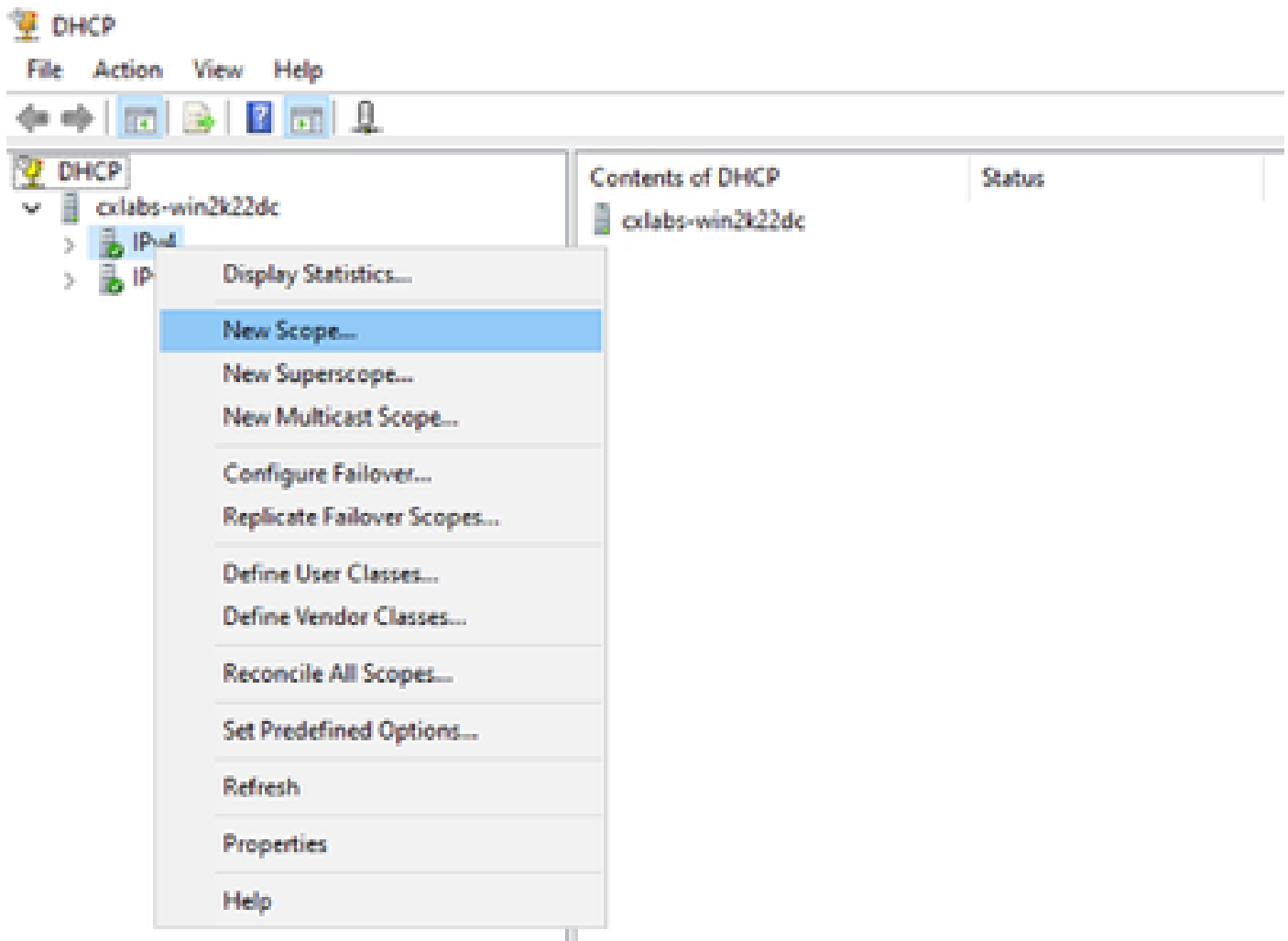

Nieuw toepassingsgebied in DCHP

Stap 2. Schrijf een naam en een beschrijving. In dit voorbeeld, is de naam het subnetnet dat voor Subnet met loopbackadres wordt gebruikt.



IPte: Een loopback wordt gebruikt loopbackunique IP-adres in de VxLAN-structuur voor VxLAN-huurder. Dit moet worden geadverteerd in BGP L2VPN EVPN-routeherverdeling in BGP binnen de VRF van de bijbehorende huurder in de IPv4-adresfax IPv4

```
LEAF-1# show running-config interface loopback 100
<snip>
interface loopback100
  vrf member tenant-a
  ip address 172.16.10.8/32
```

New Scope Wizard

Scope Name

You have to provide an identifying scope name. You also have the option of providing a description.



Type a name and description for this scope. This information helps you quickly identify how the scope is to be used on your network.

Name:

Description:

< Back

Next >

Cancel

Stap 3. Configureer het IP-adresbereikIP. Dit is het zwembad voor loopbacks.

New Scope Wizard

IP Address Range

You define the scope address range by identifying a set of consecutive IP addresses.



Configuration settings for DHCP Server

Enter the range of addresses that the scope distributes.

Start IP address:

End IP address:

Configuration settings that propagate to DHCP Client

Length:

Subnet mask:

< Back

Next >

Cancel

Stap 4. Configureer uitsluitingen (optioneel omdat de DHCP-server IP-adressen die tot dit subnetnummer behoren, niet lease).

New Scope Wizard

Add Exclusions and Delay

Exclusions are addresses or a range of addresses that are not distributed by the server. A delay is the time duration by which the server will delay the transmission of a DHCP OFFER message.



Type the IP address range that you want to exclude. If you want to exclude a single address, type an address in Start IP address only.

Start IP address:

End IP address:

Add

Excluded address range:

Remove

Subnet delay in milli second:

< Back

Next >

Cancel

Stap 5. Sla de leasduur over en klik op Volgende.

New Scope Wizard

Lease Duration

The lease duration specifies how long a client can use an IP address from this scope.



Lease durations should typically be equal to the average time the computer is connected to the same physical network. For mobile networks that consist mainly of portable computers or dial-up clients, shorter lease durations can be useful. Likewise, for a stable network that consists mainly of desktop computers at fixed locations, longer lease durations are more appropriate.

Set the duration for scope leases when distributed by this server.

Limited to:

Days:

Hours:

Minutes:

< Back

Next >

Cancel

Stap 6. Selecteer Nee, ik configureer deze opties later.

New Scope Wizard

Configure DHCP Options

You have to configure the most common DHCP options before clients can use the scope.



When clients obtain an address, they are given DHCP options such as the IP addresses of routers (default gateways), DNS servers, and WINS settings for that scope.

The settings you select here are for this scope and override settings configured in the Server Options folder for this server.

Do you want to configure the DHCP options for this scope now?

- Yes, I want to configure these options now
- No, I will configure these options later

< Back

Next >

Cancel

Stap 7. Klik op Finish (Voltooien).

New Scope Wizard



Completing the New Scope Wizard

You have successfully completed the *New Scope* wizard.

Before clients can receive addresses you need to do the following:

1. Add any scope specific options (optional).
2. Activate the scope.

To provide high availability for this scope, configure failover for the newly added scope by right clicking on the scope and clicking on *configure failover*.

To close this wizard, click *Finish*.

< Back

Finish

Cancel

Stap 8. Klik met de rechtermuisknop op de gedefinieerde scope en selecteer Activeren.

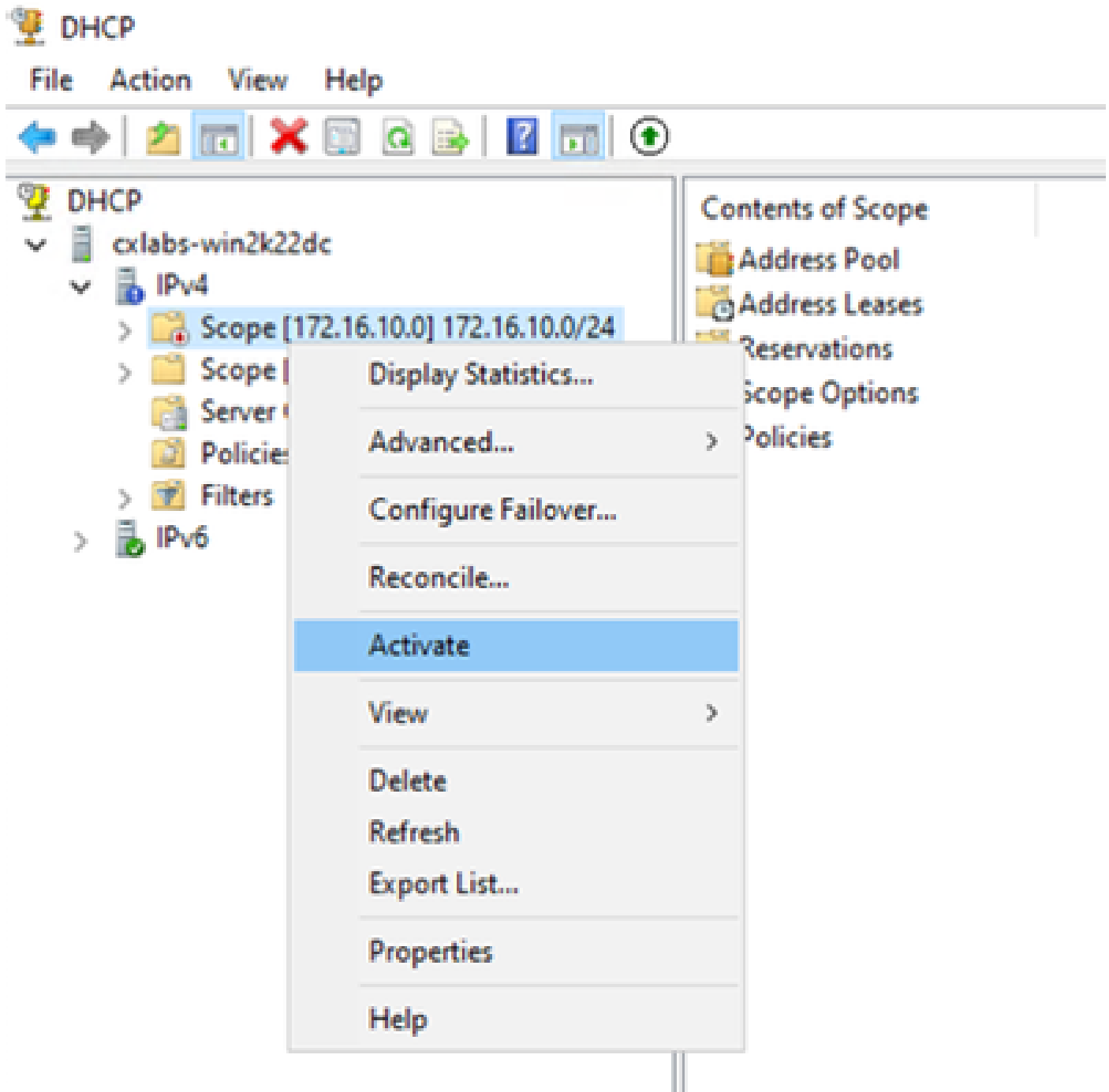

Superscope voor VxLAN-fabric configureren.

Stap 1. Klik met de rechtermuisknop in IPv4 en selecteer Nieuwe superscope.

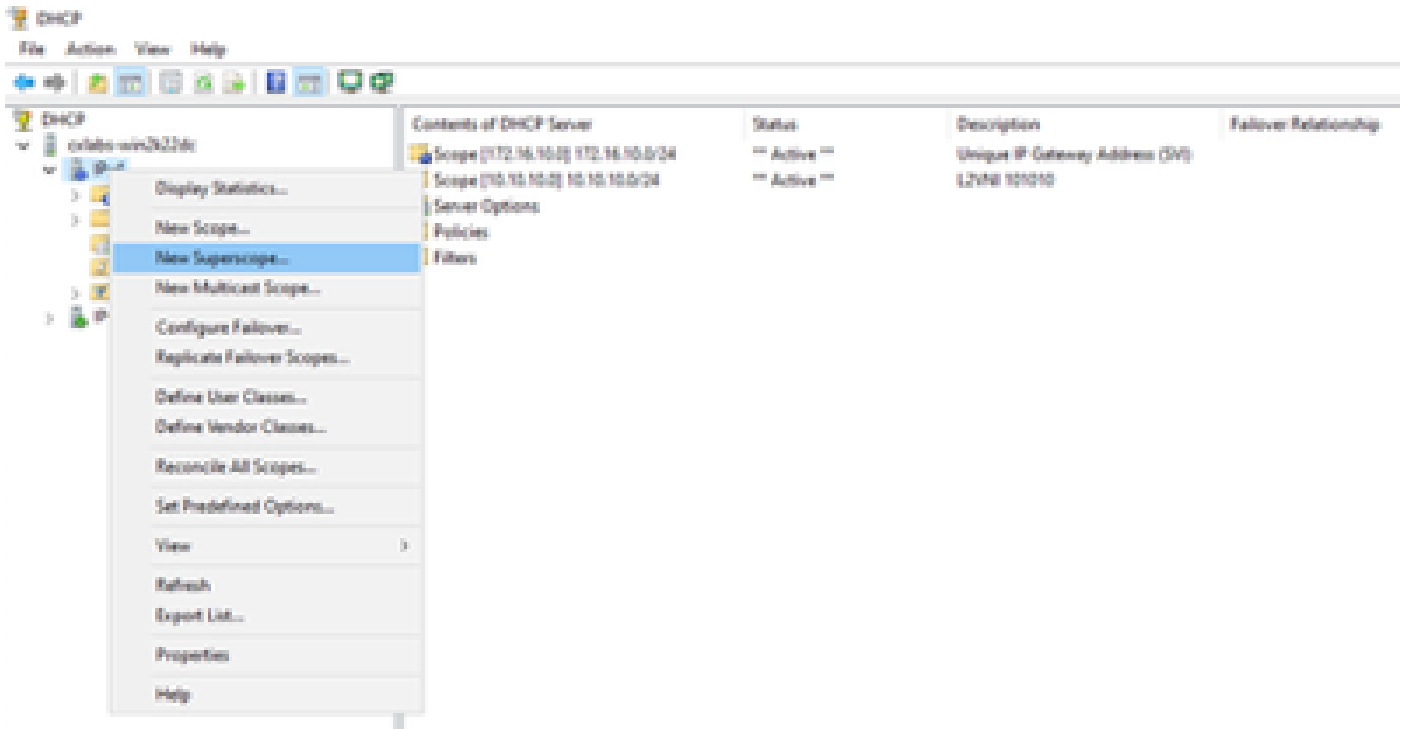

Stap 2. Klik op Next (Volgende).

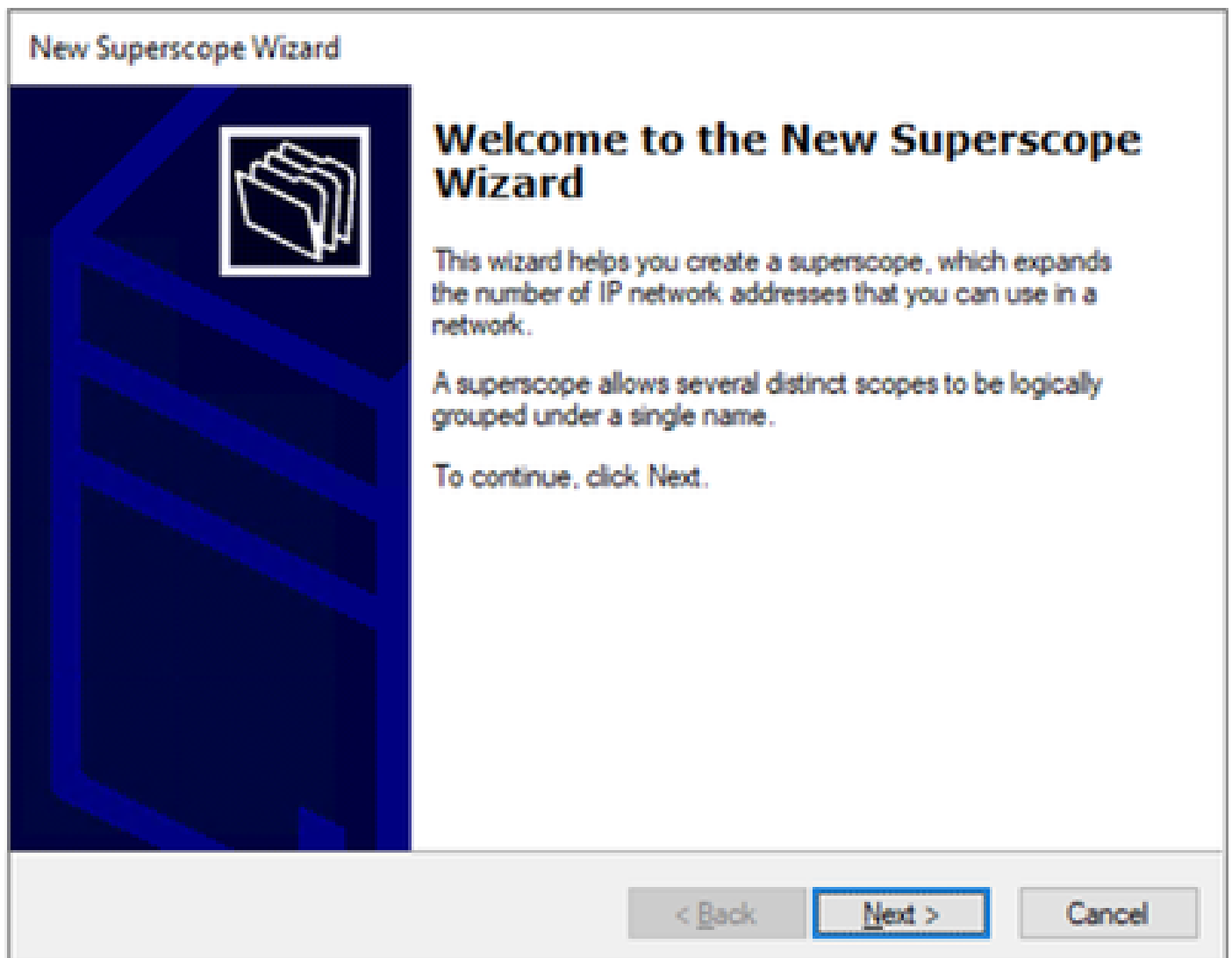

Stap 3. Schrijf de superscope naam.

New Superscope Wizard

Superscope Name
You have to provide an identifying superscope name.

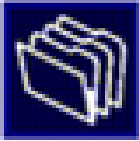

Name:

< Back **Next >** Cancel

Stap 4. Selecteer alle scènes die bij VxLAN Fabric horen.

New Superscope Wizard

Select Scopes

You create a superscope by building a collection of scopes.



Select one or more scopes from the list to add to the superscope.

Available scopes:

[10.10.10.0] 10.10.10.0/24
[172.16.10.0] 172.16.10.0/24

< Back

Next >

Cancel

Stap 5. Selecteer alle scènes die bij VxLAN Fabric horen.

New Superscope Wizard

Select Scopes

You create a superscope by building a collection of scopes.



Select one or more scopes from the list to add to the superscope.

Available scopes:

[10.10.10.0] 10.10.10.0/24
[172.16.10.0] 172.16.10.0/24

< Back

Next >

Cancel

Stap 6. Controleer of alle VxLAN-fabric superscope aanwezig is en klik op Voltoeien.

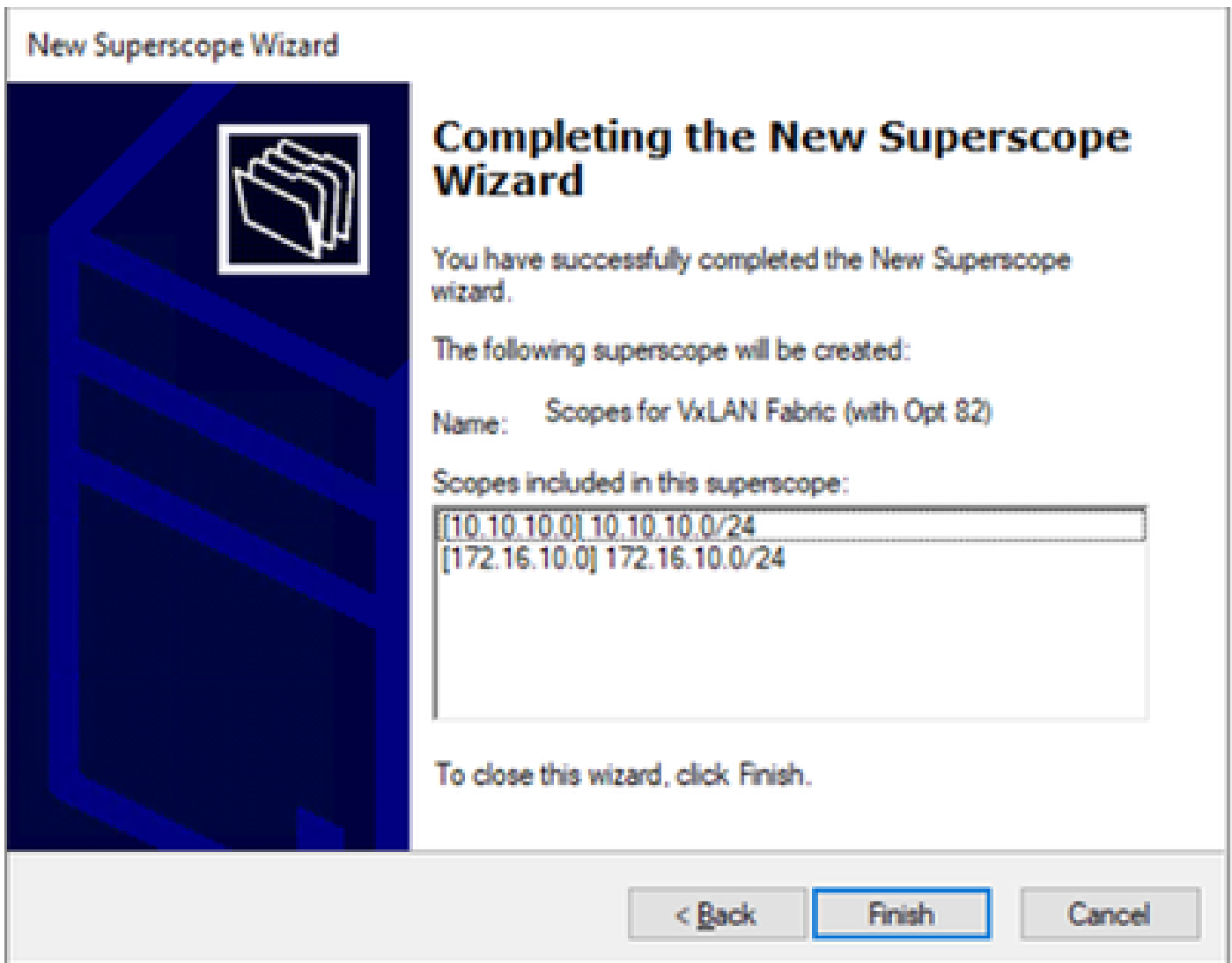

Configureer optie 82 in hostscoopen.

Stap 1. Klik met de rechtermuisknop op Beleid (laatste optie) binnen het bereik voor host en klik op Nieuw beleid.

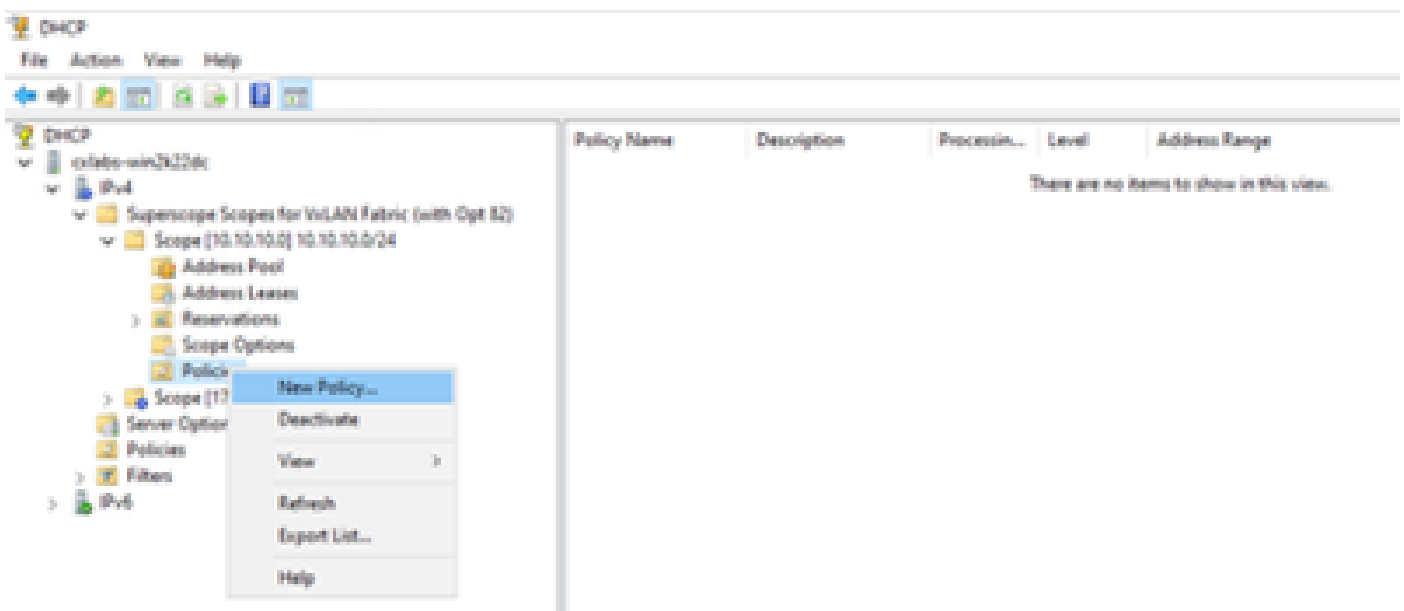

Stap 2. Schrijf een naam en een beschrijving en klik op Volgende.

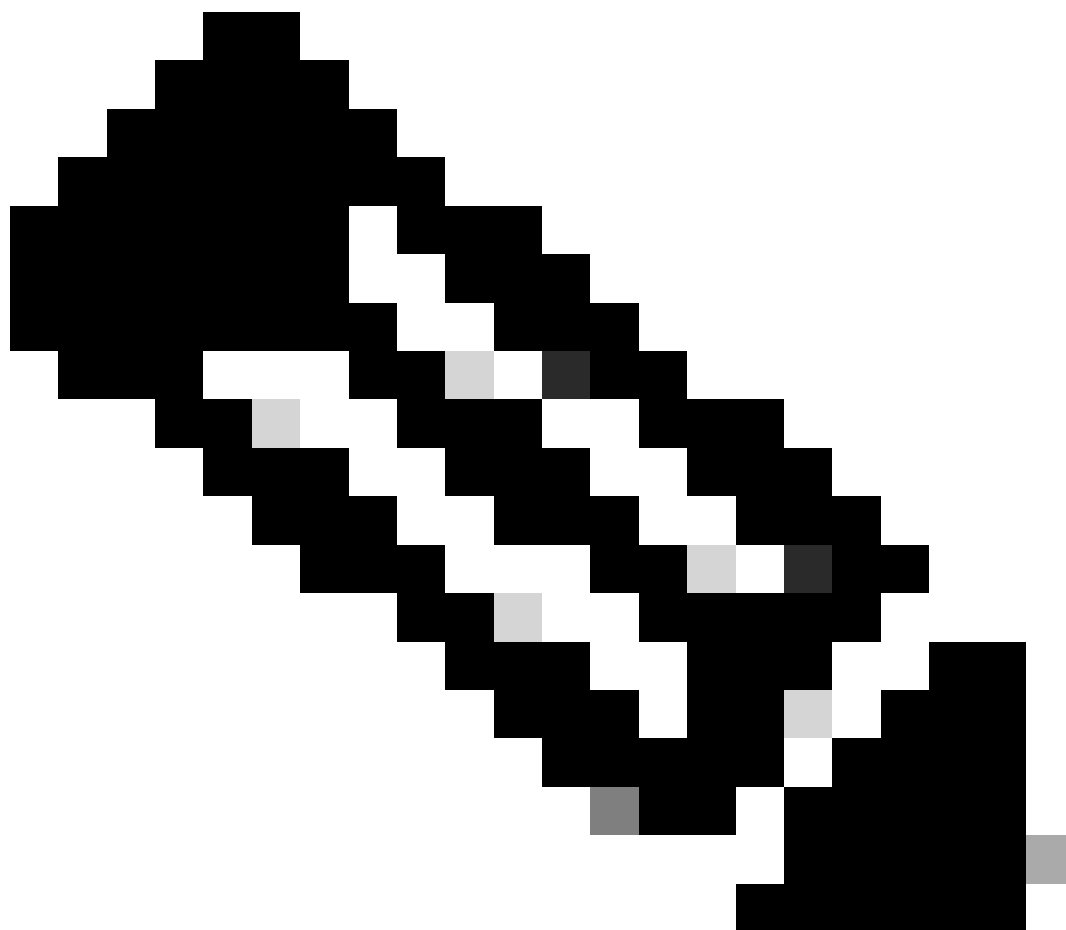

Opmerking: in dit voorbeeld wordt het beleid gemaakt om IP-adressering per IPiculary te selecteren voor hosts in Leaf-1 voor VNI 101010-gebaseerdeVNI Remote-ID (parameter van optie 82).

DHCP Policy Configuration Wizard

Policy based IP Address and Option Assignment



This feature allows you to distribute configurable settings (IP address, DHCP options) to clients based on certain conditions (e.g. vendor class, user class, MAC address, etc.).

This wizard will guide you setting up a new policy. Provide a name (e.g. VoIP Phone Configuration Policy) and description (e.g. NTP Server option for VoIP Phones) for your policy.

Policy Name:

Description:

< Back

Next >

Cancel

Stap 3. Klik op Add (Toevoegen). Selecteer in Criteria de optie Relay Agent Information. Selecteer in Operator de optie Gelijken. Selecteer vervolgens Agent Remote ID en typ de waarde. Klik op OK en vervolgens op Volgende.

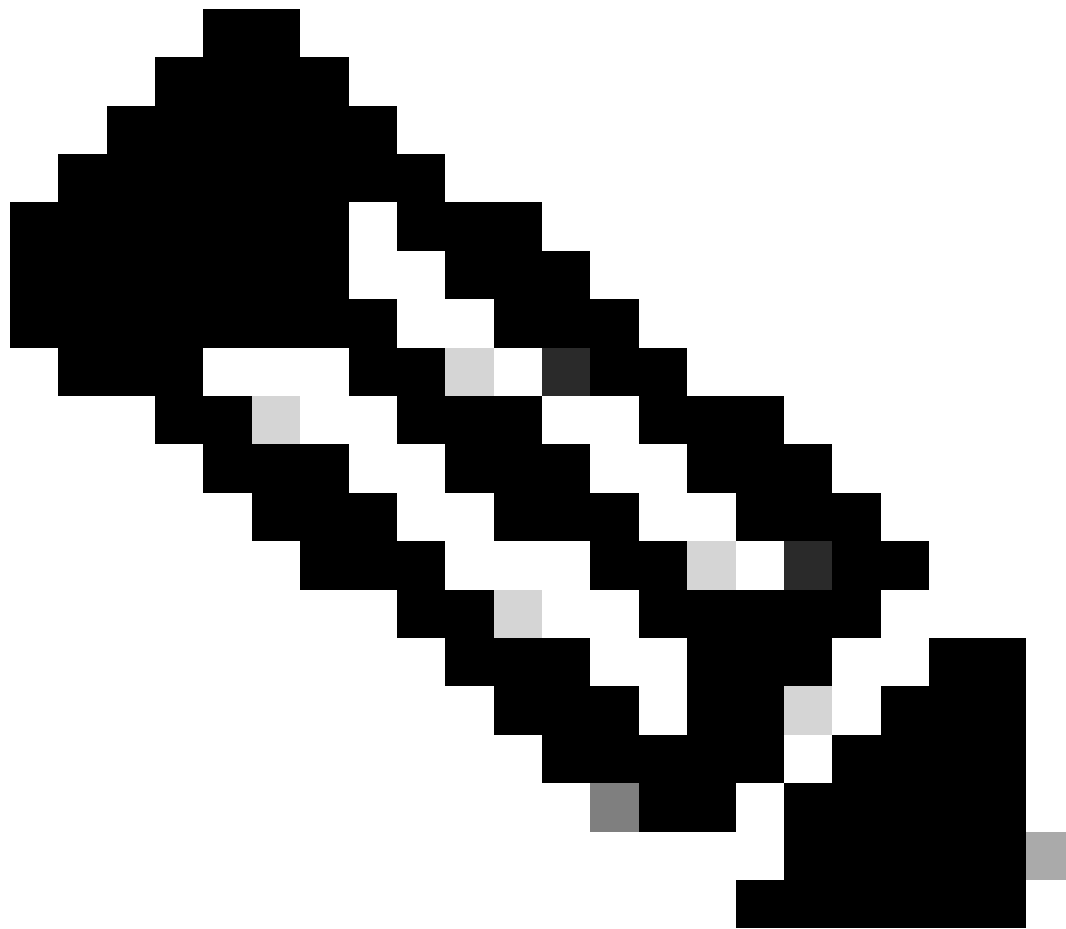

Opmerking: De Remote ID wordt verkregen van het MAC-adres van de SVI waaraan de SVII is gekoppeld.

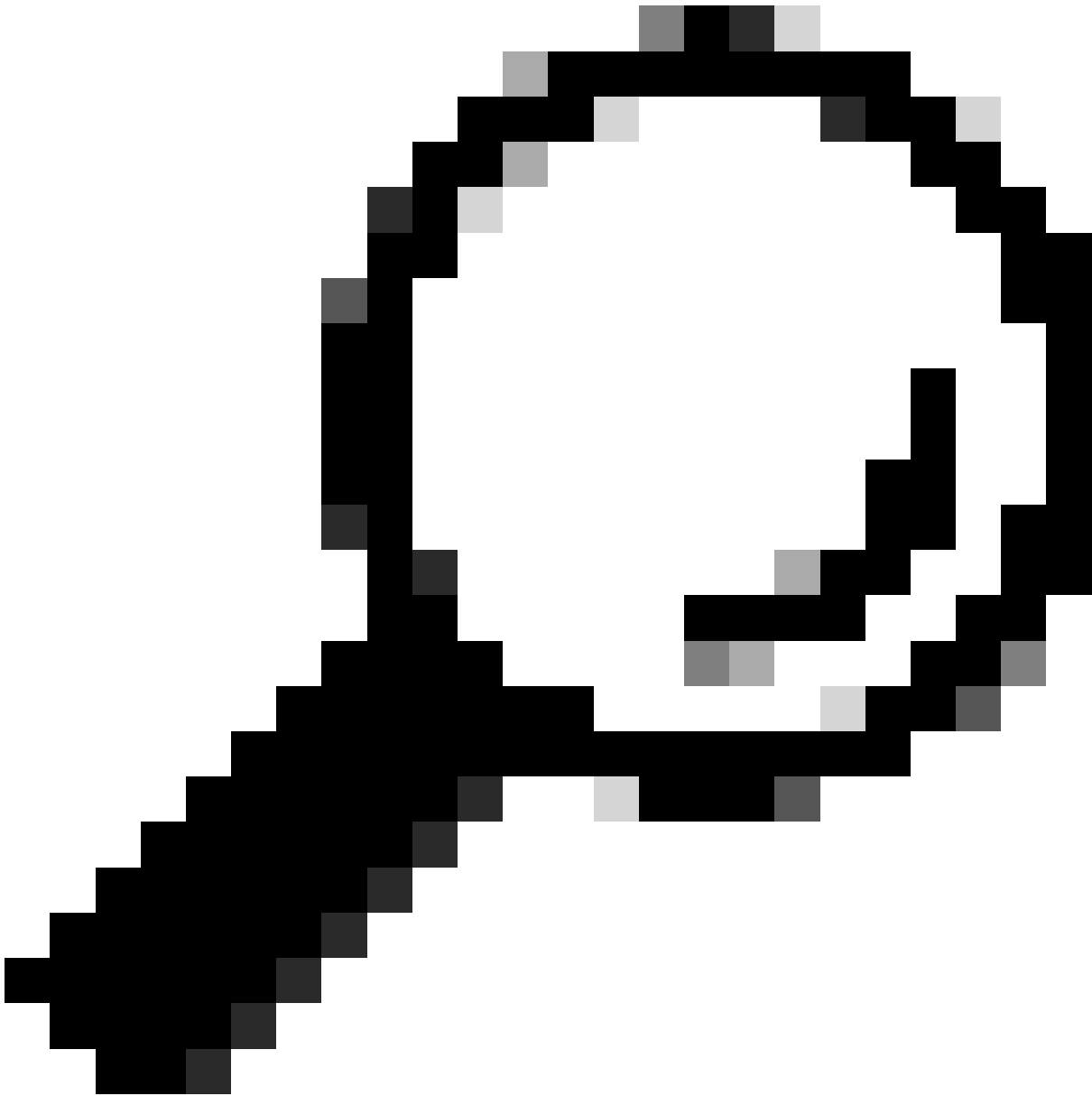

Tip: Een beleid kan worden toegepast op meerdere Remote-ID's (of VTEP's) door meer voorwaarden toe te voegen en OF te selecteren in plaats van EN.

```
LEAF-1# show interface vlan 10
Vlan10 is up, line protocol is up, autostate enabled
  Hardware is EtherSVI, address is 707d.b9b8.4daf <<<<
  Internet Address is 10.10.10.1/24
<snip>
```

DHCP Policy Configuration Wizard

Add/Edit Condition

Specify a condition for the policy being configured. Select a criteria, operator and values for the condition.

Criteria: Relay Agent Information

Operator: Equals

Value (in hex)

Relay Agent Information:

Agent Circuit ID:

Agent Remote ID: 707db9b84daf

Subscriber ID:

Prefix wildcard(*)

Append wildcard(*)

Ok

Cancel

< Back

Next >

Cancel

Stap 4. Configureer de IP-adressering die bestaande IP kan gebruiken op de VPN's die door de ID zijn geselecteerd en klik vervolgens op Volgende.

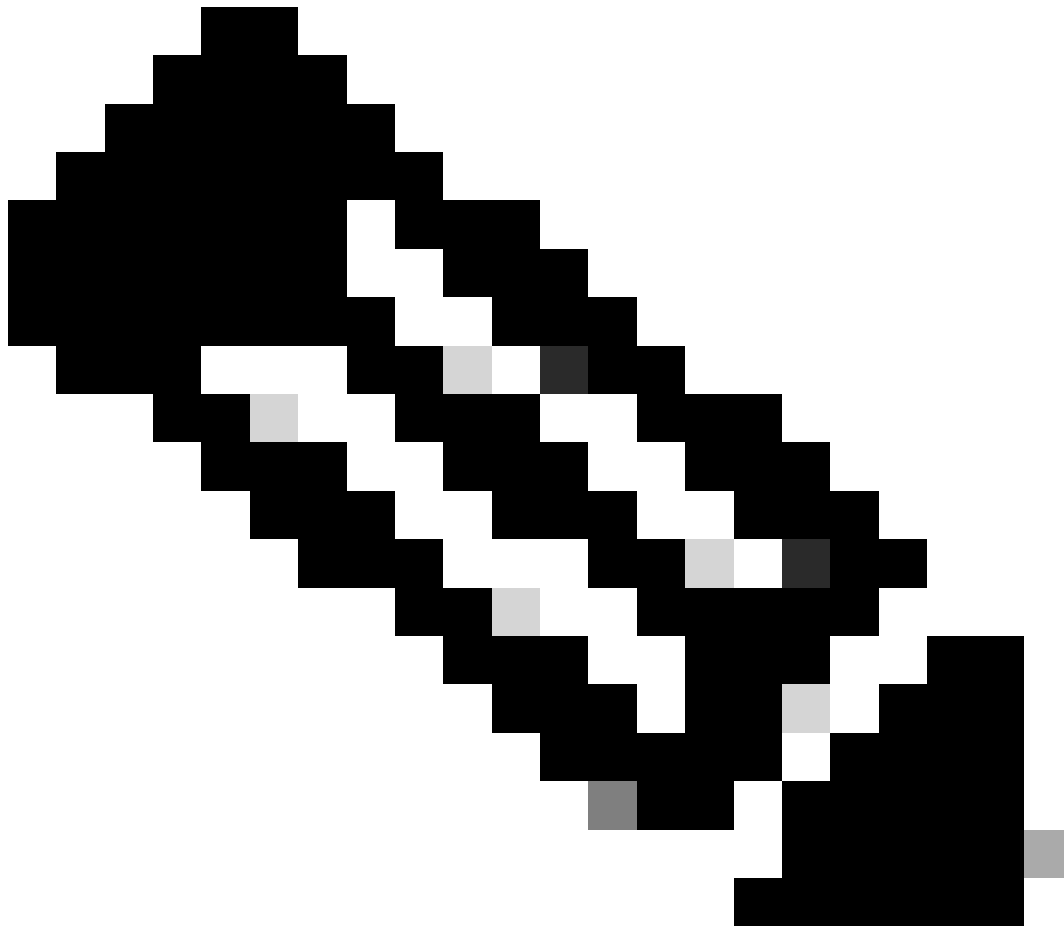

Opmerking: in dit voorbeeld is er slechts één virtuele machine aangesloten op Leaf-1, dus slechts één IP-adres is IPd nodig. Hier wordt een tweede IP-adres toegevoegdIPn geval een andere host verbinding maakt.

DHCP Policy Configuration Wizard

Configure settings for the policy

If the conditions specified in the policy match a client request, the settings will be applied.



A scope can be subdivided into multiple IP address ranges. Clients that match the conditions defined in a policy will be issued an IP Address from the specified range.

Configure the start and end IP address for the range. The start and end IP addresses for the range must be within the start and end IP addresses of the scope.

The current scope IP address range is 10.10.10.1 - 10.10.10.254

If an IP address range is not configured for the policy, policy clients will be issued an IP address from the scope range.

Do you want to configure an IP address range for the policy: Yes No

Start IP address:

End IP address:

Percentage of IP address range: 0.8

< Back

Next >

Cancel

Stap 5. Selecteer het vakje links van 003 router onder DHCP Standard Option. Schrijf vervolgens het IP-adres van de standaardgateway voor de hosts die tot dit beleid behoren en druk op Add. Klik op Next (Volgende).

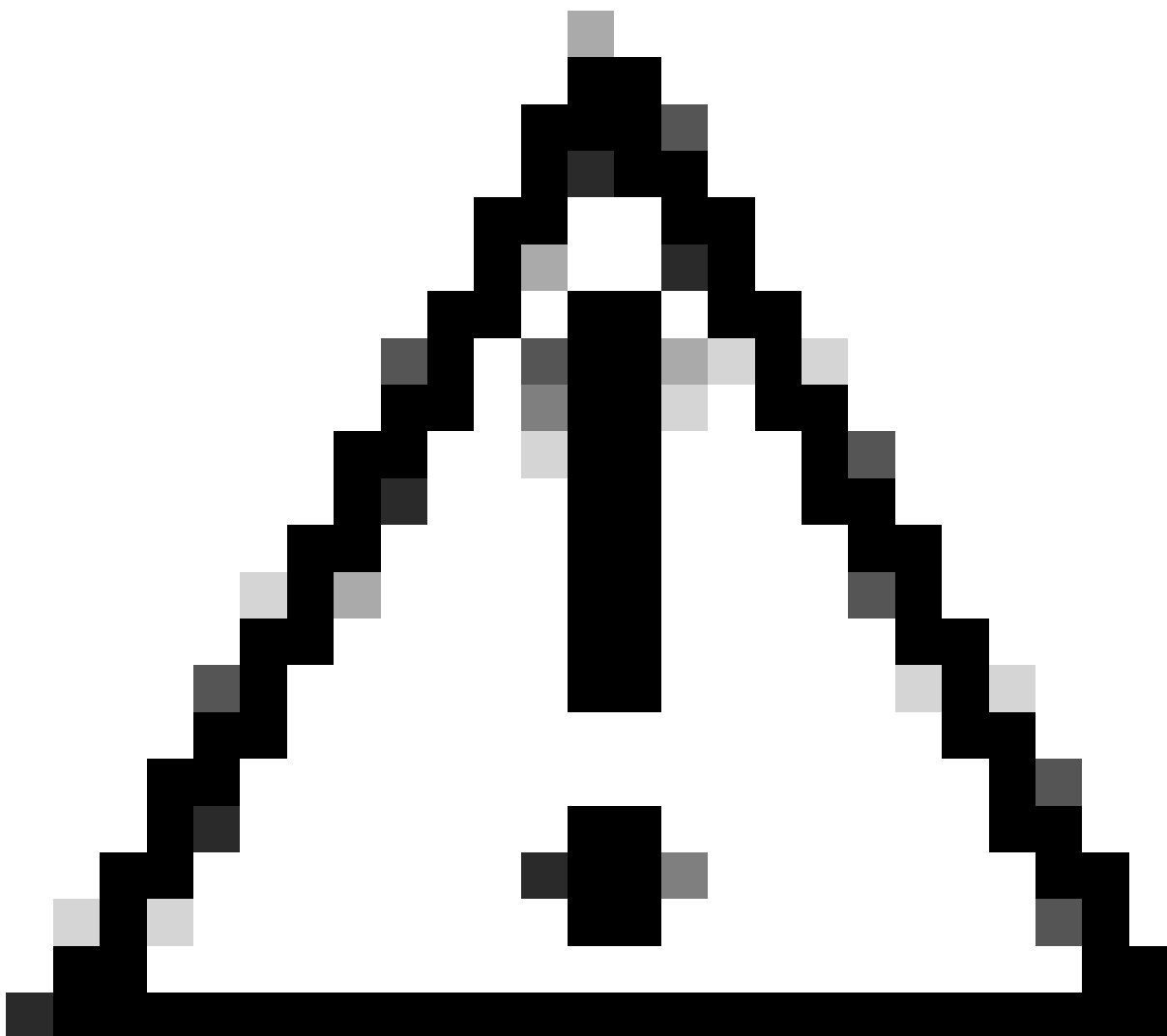

Waarschuwing: u kunt meerdere opties selecteren, maar als u niet zeker weet welke waarde u moet invoeren, doet u dit niet. Een inconsistente of onjuiste configuratie kan onverwacht gedrag veroorzaken.

DHCP Policy Configuration Wizard

Configure settings for the policy

If the conditions specified in the policy match a client request, the settings will be applied.

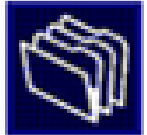

Vendor class: DHCP Standard Options

Available Options	Description
<input type="checkbox"/> 002 Time Offset	UTC offset in seconds
<input checked="" type="checkbox"/> 003 Router	Array of router addresses order
<input type="checkbox"/> 004 Time Server	Array of time server addresses.

Data entry

Server name:

Resolve

IP address:

Add

10.10.10.1

Remove

Up

Down

< Back

Next >

Cancel

Stap 6. Controleer de beleidsvoorwaarden en klik op Vervolgens.

Policy Name	Description	Processin...	Level	Address Range	State	Actions
VNI 101010	Policy to select scope for Leaf-1 using Remote-ID	1	Scope	10.10.10.2 - 10.10.10.3	Enabled	More Actions

DCHP-pakketwandeling van begin tot eind in VxLAN Fabric.

Detectie verzenden via HOST-1

```
> Ethernet II, Src: 00:50:56:a5:fd:dd, Dst: ff:ff:ff:ff:ff:ff
> Internet Protocol Version 4, Src: 0.0.0.0, Dst: 255.255.255.255
> User Datagram Protocol, Src Port: 68, Dst Port: 67
v Dynamic Host Configuration Protocol (Discover)
  Message type: Boot Request (1)
  Hardware type: Ethernet (0x01)
  Hardware address length: 6
  Hops: 0
  Transaction ID: 0xe9e35087
  Seconds elapsed: 0
v Bootp flags: 0x8000, Broadcast flag (Broadcast)
  1... .... .... .... = Broadcast flag: Broadcast
  .000 0000 0000 0000 = Reserved flags: 0x0000
  Client IP address: 0.0.0.0
  Your (client) IP address: 0.0.0.0
  Next server IP address: 0.0.0.0
  Relay agent IP address: 0.0.0.0
  Client MAC address: 00:50:56:a5:fd:dd
  Client hardware address padding: 00000000000000000000
  Server host name not given
  Boot file name not given
  Magic cookie: DHCP
v Option: (53) DHCP Message Type (Discover)
  Length: 1
  <Value: 01>
  DHCP: Discover (1)
v Option: (61) Client identifier
  Length: 7
  <Value: 01005056a5fddd>
  Hardware type: Ethernet (0x01)
  Client MAC address: 00:50:56:a5:fd:dd
v Option: (12) Host Name
  Length: 10
  <Value: 43584c6162732d573130>
  Host Name: CXLabs-W10
v Option: (60) Vendor class identifier
  Length: 8
  <Value: 4d53465420352e30>
  Vendor class identifier: MSFT 5.0
v Option: (55) Parameter Request List
  Length: 14
  <Value: 0103060f1f212b2c2e2f7779f9fc>
  Parameter Request List Item: (1) Subnet Mask
  Parameter Request List Item: (3) Router
  Parameter Request List Item: (6) Domain Name Server
  Parameter Request List Item: (15) Domain Name
  Parameter Request List Item: (31) Perform Router Discover
  Parameter Request List Item: (33) Static Route
  Parameter Request List Item: (43) Vendor-Specific Information
  Parameter Request List Item: (44) NetBIOS over TCP/IP Name Server
  Parameter Request List Item: (46) NetBIOS over TCP/IP Node Type
  Parameter Request List Item: (47) NetBIOS over TCP/IP Scope
  Parameter Request List Item: (119) Domain Search
  Parameter Request List Item: (121) Classless Static Route
  Parameter Request List Item: (249) Private/Classless Static Route (Microsoft)
  Parameter Request List Item: (252) Private/Proxy autodiscovery
v Option: (255) End
  Option End: 255
  Padding: 00000000000000000000
```

Detectie op LEAF-1

Ontvangen ontdekking op LEAF-1	Detectie verzenden via LEAF-1
<pre> > Ethernet II, Src: 00:50:56:a5:fd:dd, Dst: ff:ff:ff:ff:ff:ff > Internet Protocol Version 4, Src: 0.0.0.0, Dst: 255.255.255.255 > User Datagram Protocol, Src Port: 68, Dst Port: 67 > Dynamic Host Configuration Protocol (Discover) Message type: Boot Request (1) Hardware type: Ethernet (0x01) Hardware address length: 6 Hops: 0 Transaction ID: 0xe9e35087 Seconds elapsed: 0 > Bootp flags: 0x8000, Broadcast flag (Broadcast) 1... = Broadcast flag: Broadcast .000 0000 0000 0000 = Reserved flags: 0x0000 Client IP address: 0.0.0.0 Your (client) IP address: 0.0.0.0 Next server IP address: 0.0.0.0 Relay agent IP address: 0.0.0.0 Client MAC address: 00:50:56:a5:fd:dd Client hardware address padding: 00000000000000000000 Server host name not given Boot file name not given Magic cookie: DHCP > Option: (53) DHCP Message Type (Discover) Length: 1 <Value: 01> DHCP: Discover (1) > Option: (61) Client identifier Length: 7 <Value: 01005056a5fddd> Hardware type: Ethernet (0x01) Client MAC address: 00:50:56:a5:fd:dd > Option: (12) Host Name Length: 10 <Value: 43584c6162732d573130> Host Name: CXLabs-W10 > Option: (60) Vendor class identifier Length: 8 <Value: 4d53465420352e30> Vendor class identifier: MSFT 5.0 > Option: (55) Parameter Request List Length: 14 <Value: 0103060f1f212b2c2e2f779f9fc> Parameter Request List Item: (1) Subnet Mask Parameter Request List Item: (3) Router Parameter Request List Item: (6) Domain Name Server Parameter Request List Item: (15) Domain Name Parameter Request List Item: (31) Perform Router Discover Parameter Request List Item: (33) Static Route Parameter Request List Item: (43) Vendor-Specific Information Parameter Request List Item: (44) NetBIOS over TCP/IP Name Server Parameter Request List Item: (46) NetBIOS over TCP/IP Node Type Parameter Request List Item: (47) NetBIOS over TCP/IP Scope Parameter Request List Item: (119) Domain Search Parameter Request List Item: (121) Classless Static Route Parameter Request List Item: (249) Private/Classless Static Route (Microsoft) Parameter Request List Item: (252) Private/Proxy autodiscovery > Option: (255) End Padding: 0000000000000000 </pre>	<pre> > Ethernet II, Src: 70:7d:b9:b8:4d:af, Dst: 10:b3:d6:a4:85:97 > Internet Protocol Version 4, Src: 5.5.5.5, Dst: 13.13.13.254 > User Datagram Protocol, Src Port: 65233, Dst Port: 4789 > Virtual Extensible Local Area Network > Flags: 0x8000, VXLAN Network ID (VNI) Group Policy ID: 0 VXLAN Network Identifier (VNI): 303030 Reserved: 0 > Ethernet II, Src: 70:7d:b9:b8:4d:af, Dst: 02:00:0d:0d:0d:fe > Internet Protocol Version 4, Src: 172.16.10.8, Dst: 10.10.10.150 > User Datagram Protocol, Src Port: 67, Dst Port: 67 > Dynamic Host Configuration Protocol (Discover) Message type: Boot Request (1) Hardware type: Ethernet (0x01) Hardware address length: 6 Hops: 1 Transaction ID: 0xe9e35087 Seconds elapsed: 0 > Bootp flags: 0x8000, Broadcast flag (Broadcast) Client IP address: 0.0.0.0 Your (client) IP address: 0.0.0.0 Next server IP address: 0.0.0.0 Relay agent IP address: 172.16.10.8 Client MAC address: 00:50:56:a5:fd:dd Client hardware address padding: 00000000000000000000 Server host name not given Boot file name not given Magic cookie: DHCP > Option: (53) DHCP Message Type (Discover) Length: 1 <Value: 01> DHCP: Discover (1) > Option: (61) Client identifier Length: 7 <Value: 01005056a5fddd> Hardware type: Ethernet (0x01) Client MAC address: 00:50:56:a5:fd:dd > Option: (12) Host Name Length: 10 <Value: 43584c6162732d573130> Host Name: CXLabs-W10 > Option: (60) Vendor class identifier Length: 8 <Value: 4d53465420352e30> Vendor class identifier: MSFT 5.0 > Option: (55) Parameter Request List Length: 14 <Value: 0103060f1f212b2c2e2f779f9fc> Parameter Request List Item: (1) Subnet Mask Parameter Request List Item: (3) Router Parameter Request List Item: (6) Domain Name Server Parameter Request List Item: (15) Domain Name Parameter Request List Item: (31) Perform Router Discover Parameter Request List Item: (33) Static Route Parameter Request List Item: (43) Vendor-Specific Information Parameter Request List Item: (44) NetBIOS over TCP/IP Name Server Parameter Request List Item: (46) NetBIOS over TCP/IP Node Type Parameter Request List Item: (47) NetBIOS over TCP/IP Scope Parameter Request List Item: (119) Domain Search Parameter Request List Item: (121) Classless Static Route Parameter Request List Item: (249) Private/Classless Static Route (Microsoft) Parameter Request List Item: (252) Private/Proxy autodiscovery > Option: (82) Agent Information Option Length: 47 <Value: 010e0108000600018a920aa00000000206707db9b84daf97090074656e616e742d610b040a0a0105040a0a0a0> > Option 82 Suboption: (1) Agent Circuit ID Length: 14 <Value: 0180000600018a920aa000000000> Agent Circuit ID: 0180000600018a920aa000000000 > Option 82 Suboption: (2) Agent Remote ID Length: 6 <Value: 707db9b84daf> Agent Remote ID: 707db9b84daf > Option 82 Suboption: (151) VRF name/VPN ID Length: 9 <Value: 0074656e616e742d61> VRF name: [Expert Info (Warning/Undecoded): Trailing stray characters] > Option 82 Suboption: (11) Server ID Override (10.10.10.1) Length: 4 <Value: 0a0a0a01> Server ID Override: 10.10.10.1 > Option 82 Suboption: (5) Link selection (10.10.10.0) Length: 4 <Value: 0a0a0a00> Link selection: 10.10.10.0 > Option: (255) End Padding: 0000000000000000 </pre>

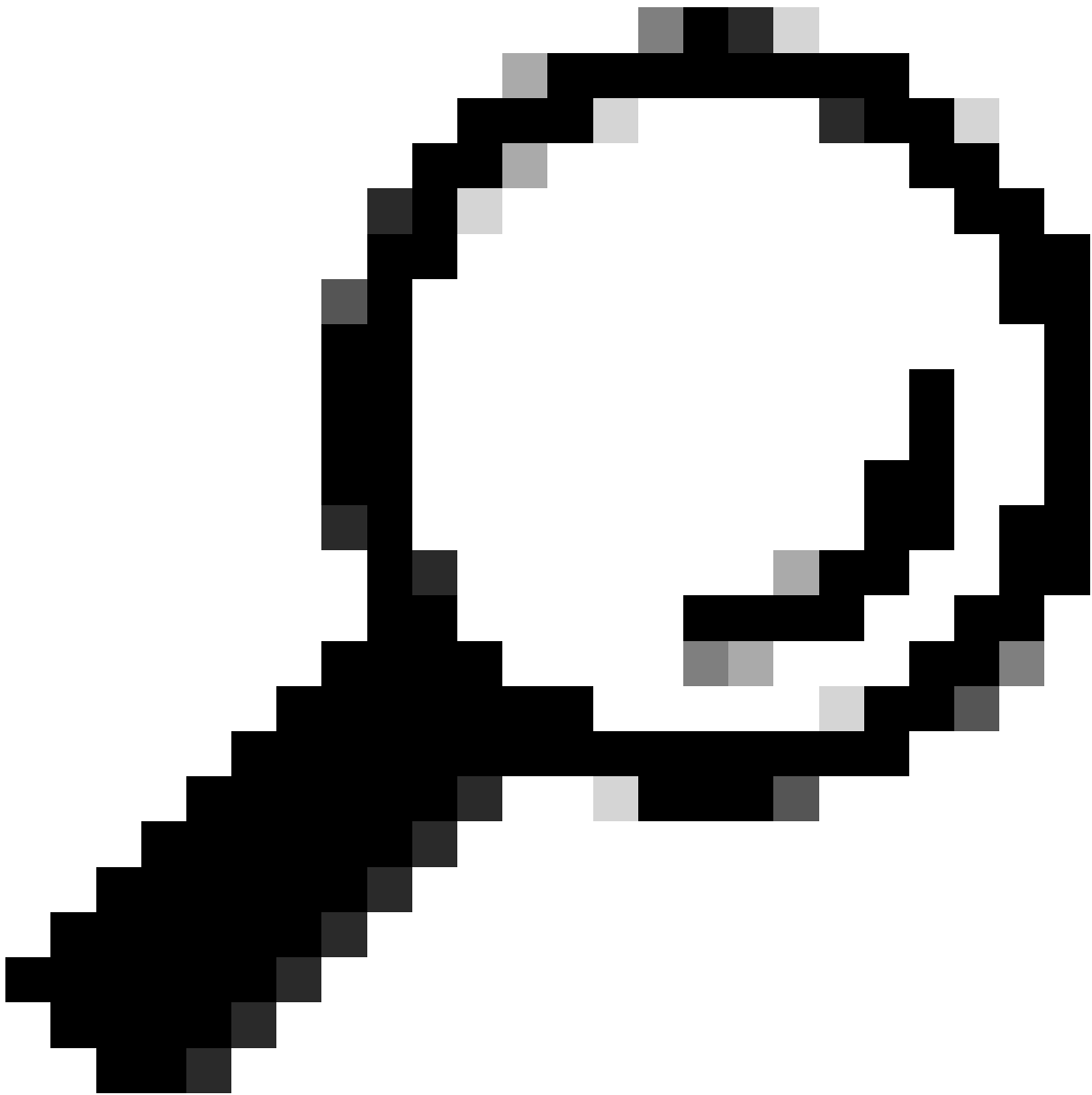

Tip: het beeld wordt vergroot door te dubbelklikken.

Detectie op RUGGENGRAAT

Ontvangen ontdekking op RUGGENGRAAT	Detectie verzenden via SPINE
-------------------------------------	------------------------------

<pre> Ethernet II, Src: 70:7d:b9:b8:4d:af, Dst: 10:b3:d6:a4:85:97 Internet Protocol Version 4, Src: 5.5.5.5, Dst: 13.13.13.254 User Datagram Protocol, Src Port: 65233, Dst Port: 4789 Virtual eXtensible Local Area Network Flags: 0x0000, VXLAN Network ID (VNI) Group Policy ID: 0 VXLAN Network Identifier (VNI): 303030 Reserved: 0 Ethernet II, Src: 70:7d:b9:b8:4d:af, Dst: 02:00:0d:0d:0d:fe Internet Protocol Version 4, Src: 172.16.10.8, Dst: 10.10.10.150 User Datagram Protocol, Src Port: 67, Dst Port: 67 Dynamic Host Configuration Protocol (Discover) Message type: Boot Request (1) Hardware type: Ethernet (0x01) Hardware address length: 6 Hops: 1 Transaction ID: 0xe9e35087 Seconds elapsed: 0 Bootp flags: 0x0000, Broadcast flag (Broadcast) Client IP address: 0.0.0.0 Your (client) IP address: 0.0.0.0 Next server IP address: 0.0.0.0 Relay agent IP address: 172.16.10.8 Client MAC address: 00:50:56:a5:fd:dd Client hardware address padding: 00000000000000000000 Server host name not given Boot file name not given Magic cookie: DHCP Option: (53) DHCP Message Type (Discover) Length: 1 <Value: 01> DHCP: Discover (1) Option: (61) Client identifier Length: 7 <Value: 01005056a5fd> Hardware type: Ethernet (0x01) Client MAC address: 00:50:56:a5:fd:dd Option: (12) Host Name Length: 10 <Value: 43584c6162732d573130> Host Name: CXLabs-W10 Option: (60) Vendor class identifier Length: 8 <Value: 4d53465420352e30> Vendor class identifier: MSFT 5.0 Option: (55) Parameter Request List Length: 14 <Value: 0103060f1f212b2c2e2f779f9fc> Parameter Request List Item: (1) Subnet Mask Parameter Request List Item: (3) Router Parameter Request List Item: (6) Domain Name Server Parameter Request List Item: (15) Domain Name Parameter Request List Item: (31) Perform Router Discover Parameter Request List Item: (33) Static Route Parameter Request List Item: (43) Vendor-Specific Information Parameter Request List Item: (44) NetBIOS over TCP/IP Name Server Parameter Request List Item: (46) NetBIOS over TCP/IP Node Type Parameter Request List Item: (47) NetBIOS over TCP/IP Scope Parameter Request List Item: (119) Domain Search Parameter Request List Item: (121) Classless Static Route Parameter Request List Item: (249) Private/Classless Static Route (Microsoft) Parameter Request List Item: (252) Private/Proxy autodiscovery Option: (82) Agent Information Option Length: 47 <Value: 010e0108000600018a9200a00000000206707db9b84daf97090074656e616e742d610b040a0a0a0105040a0a0a00> Option 82 Suboption: (1) Agent Circuit ID Length: 14 <Value: 0108000600018a9200a000000000> Agent Circuit ID: 0108000600018a9200a000000000 Option 82 Suboption: (2) Agent Remote ID Length: 6 <Value: 707db9b84daf> Agent Remote ID: 707db9b84daf Option 82 Suboption: (151) VRF name/VPN ID Length: 9 <Value: 0074656e616e742d61> VRF name: [Expert Info (Warning/Undecoded): Trailing stray characters] Option 82 Suboption: (11) Server ID Override (10.10.10.1) Length: 4 <Value: 0a0a0a01> Server ID Override: 10.10.10.1 Option 82 Suboption: (5) Link selection (10.10.10.0) Length: 4 <Value: 0a0a0a00> Link selection: 10.10.10.0 Option: (255) End Option End: 255 Padding: 00000000000000000000 </pre>	<pre> Ethernet II, Src: 10:b3:d6:a4:85:97, Dst: 60:26:aa:85:98:87 Internet Protocol Version 4, Src: 5.5.5.5, Dst: 13.13.13.254 User Datagram Protocol, Src Port: 65233, Dst Port: 4789 Virtual eXtensible Local Area Network Flags: 0x0000, VXLAN Network ID (VNI) Group Policy ID: 0 VXLAN Network Identifier (VNI): 303030 Reserved: 0 Ethernet II, Src: 70:7d:b9:b8:4d:af, Dst: 02:00:0d:0d:0d:fe Internet Protocol Version 4, Src: 172.16.10.8, Dst: 10.10.10.150 User Datagram Protocol, Src Port: 67, Dst Port: 67 Dynamic Host Configuration Protocol (Discover) Message type: Boot Request (1) Hardware type: Ethernet (0x01) Hardware address length: 6 Hops: 1 Transaction ID: 0xe9e35087 Seconds elapsed: 0 Bootp flags: 0x0000, Broadcast flag (Broadcast) Client IP address: 0.0.0.0 Your (client) IP address: 0.0.0.0 Next server IP address: 0.0.0.0 Relay agent IP address: 172.16.10.8 Client MAC address: 00:50:56:a5:fd:dd Client hardware address padding: 00000000000000000000 Server host name not given Boot file name not given Magic cookie: DHCP Option: (53) DHCP Message Type (Discover) Length: 1 <Value: 01> DHCP: Discover (1) Option: (61) Client identifier Length: 7 <Value: 01005056a5fd> Hardware type: Ethernet (0x01) Client MAC address: 00:50:56:a5:fd:dd Option: (12) Host Name Length: 10 <Value: 43584c6162732d573130> Host Name: CXLabs-W10 Option: (60) Vendor class identifier Length: 8 <Value: 4d53465420352e30> Vendor class identifier: MSFT 5.0 Option: (55) Parameter Request List Length: 14 <Value: 0103060f1f212b2c2e2f779f9fc> Parameter Request List Item: (1) Subnet Mask Parameter Request List Item: (3) Router Parameter Request List Item: (6) Domain Name Server Parameter Request List Item: (15) Domain Name Parameter Request List Item: (31) Perform Router Discover Parameter Request List Item: (33) Static Route Parameter Request List Item: (43) Vendor-Specific Information Parameter Request List Item: (44) NetBIOS over TCP/IP Name Server Parameter Request List Item: (46) NetBIOS over TCP/IP Node Type Parameter Request List Item: (47) NetBIOS over TCP/IP Scope Parameter Request List Item: (119) Domain Search Parameter Request List Item: (121) Classless Static Route Parameter Request List Item: (249) Private/Classless Static Route (Microsoft) Parameter Request List Item: (252) Private/Proxy autodiscovery Option: (82) Agent Information Option Length: 47 <Value: 010e0108000600018a9200a00000000206707db9b84daf97090074656e616e742d610b040a0a0a0105040a0a0a00> Option 82 Suboption: (1) Agent Circuit ID Length: 14 <Value: 0108000600018a9200a000000000> Agent Circuit ID: 0108000600018a9200a000000000 Option 82 Suboption: (2) Agent Remote ID Length: 6 <Value: 707db9b84daf> Agent Remote ID: 707db9b84daf Option 82 Suboption: (151) VRF name/VPN ID Length: 9 <Value: 0074656e616e742d61> VRF name: [Expert Info (Warning/Undecoded): Trailing stray characters] Option 82 Suboption: (11) Server ID Override (10.10.10.1) Length: 4 <Value: 0a0a0a01> Server ID Override: 10.10.10.1 Option 82 Suboption: (5) Link selection (10.10.10.0) Length: 4 <Value: 0a0a0a00> Link selection: 10.10.10.0 Option: (255) End Option End: 255 Padding: 00000000000000000000 </pre>
--	--

Detectie op LEAF-1-vPC

Detectie ontvangen op LEAF-1-vPC	Detectie verzenden via LEAF-1-vPC
----------------------------------	-----------------------------------

```

Ethernet II, Src: 10:b3:06:a4:85:97, Dst: 60:26:aa:85:98:87
Internet Protocol Version 4, Src: 5.5.5.5, Dst: 13.13.13.254
User Datagram Protocol, Src Port: 65233, Dst Port: 4789
Virtual Extensible Local Area Network
  Flags: 0x0000, VXLAN Network ID (VNI)
  Group Policy ID: 0
  VXLAN Network Identifier (VNI): 303030
  Reserved: 0
Ethernet II, Src: 70:7d:b9:b8:4d:af, Dst: 02:00:0d:0d:0d:fe
Internet Protocol Version 4, Src: 172.16.10.8, Dst: 10.10.10.150
User Datagram Protocol, Src Port: 67, Dst Port: 67
Dynamic Host Configuration Protocol (Discover)
  Message type: Boot Request (1)
  Hardware type: Ethernet (0x01)
  Hardware address length: 6
  Hops: 1
  Transaction ID: 0xe9e35087
  Seconds elapsed: 0
  Bootp flags: 0x8000, Broadcast flag (Broadcast)
  Client IP address: 0.0.0.0
  Your (client) IP address: 0.0.0.0
  Next server IP address: 0.0.0.0
  Relay agent IP address: 172.16.10.8
  Client MAC address: 00:50:56:a5:fd:dd
  Client hardware address padding: 00000000000000000000
  Server host name not given
  Boot file name not given
  Magic cookie: DHCP
  Option: (53) DHCP Message Type (Discover)
  Length: 1
  <Value: 01>
  DHCP: Discover (1)
  Option: (61) Client identifier
  Length: 7
  <Value: 01005056a5fd>
  Hardware type: Ethernet (0x01)
  Client MAC address: 00:50:56:a5:fd:dd
  Option: (12) Host Name
  Length: 10
  <Value: 43584c6162732d573130>
  Host Name: CXLabs-W10
  Option: (60) Vendor class identifier
  Length: 8
  <Value: 4d53465420352e30>
  Vendor class identifier: MSFT 5.0
  Option: (55) Parameter Request List
  Length: 14
  <Value: 0103060f1f212b2c2e2f779f9f>
  Parameter Request List Item: (1) Subnet Mask
  Parameter Request List Item: (3) Router
  Parameter Request List Item: (6) Domain Name Server
  Parameter Request List Item: (15) Domain Name
  Parameter Request List Item: (31) Perform Router Discover
  Parameter Request List Item: (33) Static Route
  Parameter Request List Item: (43) Vendor-Specific Information
  Parameter Request List Item: (44) NetBIOS over TCP/IP Name Server
  Parameter Request List Item: (46) NetBIOS over TCP/IP Node Type
  Parameter Request List Item: (47) NetBIOS over TCP/IP Scope
  Parameter Request List Item: (119) Domain Search
  Parameter Request List Item: (121) Classless Static Route
  Parameter Request List Item: (249) Private/Classless Static Route (Microsoft)
  Parameter Request List Item: (252) Private/Proxy autodiscovery
  Option: (82) Agent Information Option
  Length: 47
  <Value: 010e0108000600018a9200a000000000206707db9b84daf97090074656e16e742d610b040a0a0a0105040a0a00>
  Option 82 Suboption: (1) Agent Circuit ID
  Length: 14
  <Value: 0108000600018a9200a000000000>
  Agent Circuit ID: 0108000600018a9200a000000000
  Option 82 Suboption: (2) Agent Remote ID
  Length: 6
  <Value: 707db9b84daf>
  Agent Remote ID: 707db9b84daf
  Option 82 Suboption: (151) VRF name/VPN ID
  Length: 9
  <Value: 0074656e16e742d61>
  VRF name:
  [Expert Info (Warning/Undecoded): Trailing stray characters]
  [Trailing stray characters]
  <Message: Trailing stray characters>
  [Severity level: Warning]
  [Group: Undecoded]
  Option 82 Suboption: (11) Server ID Override (10.10.10.1)
  Length: 4
  <Value: 0a0a0a01>
  Server ID Override: 10.10.10.1
  Option 82 Suboption: (5) Link selection (10.10.10.0)
  Length: 4
  <Value: 0a0a0a00>
  Link selection: 10.10.10.0
  Option: (255) End
  Padding: 00000000000000000000

Ethernet II, Src: 60:26:aa:85:98:87, Dst: 00:50:56:a5:dc:ca
Internet Protocol Version 4, Src: 172.16.10.8, Dst: 10.10.10.150
User Datagram Protocol, Src Port: 67, Dst Port: 67
Dynamic Host Configuration Protocol (Discover)
  Message type: Boot Request (1)
  Hardware type: Ethernet (0x01)
  Hardware address length: 6
  Hops: 1
  Transaction ID: 0xe9e35087
  Seconds elapsed: 0
  Bootp flags: 0x8000, Broadcast flag (Broadcast)
  1... .. = Broadcast flag: Broadcast
  .000 0000 0000 0000 = Reserved flags: 0x0000
  Client IP address: 0.0.0.0
  Your (client) IP address: 0.0.0.0
  Next server IP address: 0.0.0.0
  Relay agent IP address: 172.16.10.8
  Client MAC address: 00:50:56:a5:fd:dd
  Client hardware address padding: 00000000000000000000
  Server host name not given
  Boot file name not given
  Magic cookie: DHCP
  Option: (53) DHCP Message Type (Discover)
  Length: 1
  <Value: 01>
  DHCP: Discover (1)
  Option: (61) Client identifier
  Length: 7
  <Value: 01005056a5fd>
  Hardware type: Ethernet (0x01)
  Client MAC address: 00:50:56:a5:fd:dd
  Option: (12) Host Name
  Length: 10
  <Value: 43584c6162732d573130>
  Host Name: CXLabs-W10
  Option: (60) Vendor class identifier
  Length: 8
  <Value: 4d53465420352e30>
  Vendor class identifier: MSFT 5.0
  Option: (55) Parameter Request List
  Length: 14
  <Value: 0103060f1f212b2c2e2f779f9f>
  Parameter Request List Item: (1) Subnet Mask
  Parameter Request List Item: (3) Router
  Parameter Request List Item: (6) Domain Name Server
  Parameter Request List Item: (15) Domain Name
  Parameter Request List Item: (31) Perform Router Discover
  Parameter Request List Item: (33) Static Route
  Parameter Request List Item: (43) Vendor-Specific Information
  Parameter Request List Item: (44) NetBIOS over TCP/IP Name Server
  Parameter Request List Item: (46) NetBIOS over TCP/IP Node Type
  Parameter Request List Item: (47) NetBIOS over TCP/IP Scope
  Parameter Request List Item: (119) Domain Search
  Parameter Request List Item: (121) Classless Static Route
  Parameter Request List Item: (249) Private/Classless Static Route (Microsoft)
  Parameter Request List Item: (252) Private/Proxy autodiscovery
  Option: (82) Agent Information Option
  Length: 47
  <Value: 010e0108000600018a9200a000000000206707db9b84daf97090074656e16e742d610b040a0a0a0105040a0a00>
  Option 82 Suboption: (1) Agent Circuit ID
  Length: 14
  <Value: 0108000600018a9200a000000000>
  Agent Circuit ID: 0108000600018a9200a000000000
  Option 82 Suboption: (2) Agent Remote ID
  Length: 6
  <Value: 707db9b84daf>
  Agent Remote ID: 707db9b84daf
  Option 82 Suboption: (151) VRF name/VPN ID
  Length: 9
  <Value: 0074656e16e742d61>
  VRF name:
  [Expert Info (Warning/Undecoded): Trailing stray characters]
  [Trailing stray characters]
  <Message: Trailing stray characters>
  [Severity level: Warning]
  [Group: Undecoded]
  Option 82 Suboption: (11) Server ID Override (10.10.10.1)
  Length: 4
  <Value: 0a0a0a01>
  Server ID Override: 10.10.10.1
  Option 82 Suboption: (5) Link selection (10.10.10.0)
  Length: 4
  <Value: 0a0a0a00>
  Link selection: 10.10.10.0
  Option: (255) End
  Padding: 00000000000000000000

```

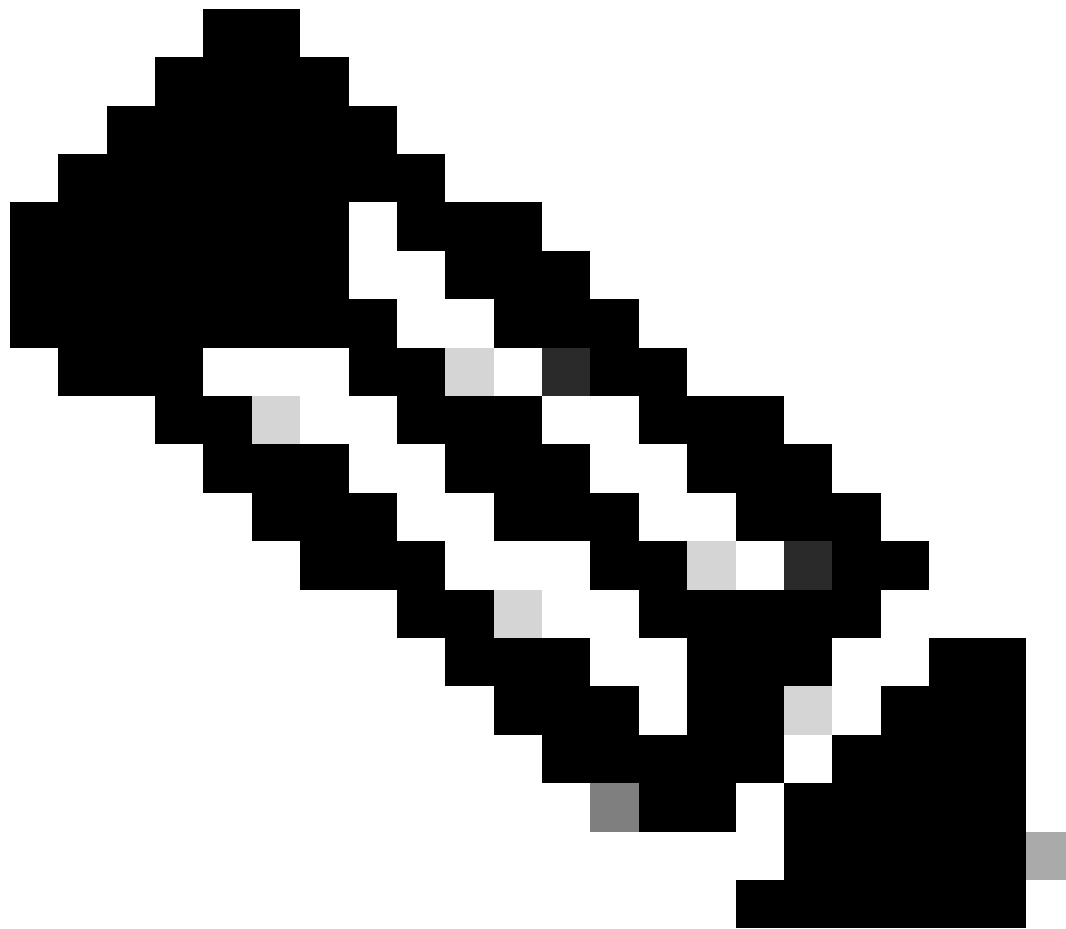

Opmerking: LEAF-2-vPC ontvangt het Discovery-pakket maar dit wordt alleen geschakeld.
Het adres van MAC van de bestemming behoort tot de server van DHCP.

Detectie ontvangen op DHCP-server

```

Ethernet II, Src: 60:26:aa:85:98:87, Dst: 00:50:56:a5:dc:ca
> Internet Protocol Version 4, Src: 172.16.10.8, Dst: 10.10.10.150
> User Datagram Protocol, Src Port: 67, Dst Port: 67
- Dynamic Host Configuration Protocol (Discover)
  Message type: Boot Request (1)
  Hardware type: Ethernet (0x01)
  Hardware address length: 6
  Hops: 1
  Transaction ID: 0xe9e35087
  Seconds elapsed: 0
  - Bootp flags: 0x8000, Broadcast flag (Broadcast)
    1... .... .... .... = Broadcast flag: Broadcast
    .000 0000 0000 0000 = Reserved flags: 0x0000
  Client IP address: 0.0.0.0
  Your (client) IP address: 0.0.0.0
  Next server IP address: 0.0.0.0
  Relay agent IP address: 172.16.10.8
  Client MAC address: 00:50:56:a5:fd:dd
  Client hardware address padding: 00000000000000000000
  Server host name not given
  Boot file name not given
  Magic cookie: DHCP
  - Option: (53) DHCP Message Type (Discover)
    Length: 1
    <Value: 01>
    DHCP: Discover (1)
  - Option: (61) Client identifier
    Length: 7
    <Value: 01005056a5fddd>
    Hardware type: Ethernet (0x01)
    Client MAC address: 00:50:56:a5:fd:dd
  - Option: (12) Host Name
    Length: 10
    <Value: 43584c6162732d573130>
    Host Name: CXLabs-W10
  - Option: (60) Vendor class identifier
    Length: 8
    <Value: 4d53465420352e30>
    Vendor class identifier: MSFT 5.0
  - Option: (55) Parameter Request List
    Length: 14
    <Value: 0103060f1f212b2c2e2f7779f9fc>
    Parameter Request List Item: (1) Subnet Mask
    Parameter Request List Item: (3) Router
    Parameter Request List Item: (6) Domain Name Server
    Parameter Request List Item: (15) Domain Name
    Parameter Request List Item: (31) Perform Router Discover
    Parameter Request List Item: (33) Static Route
    Parameter Request List Item: (43) Vendor-Specific Information
    Parameter Request List Item: (44) NetBIOS over TCP/IP Name Server
    Parameter Request List Item: (46) NetBIOS over TCP/IP Node Type
    Parameter Request List Item: (47) NetBIOS over TCP/IP Scope
    Parameter Request List Item: (119) Domain Search
    Parameter Request List Item: (121) Classless Static Route
    Parameter Request List Item: (249) Private/Classless Static Route (Microsoft)
    Parameter Request List Item: (252) Private/Proxy autodiscovery
  - Option: (82) Agent Information Option
    Length: 47
    <Value: 010e0108000600018a9200a000000000206707db9b84daf97090074656e616e742d610b040a0a0a0105040a0a0a00>
  - Option 82 Suboption: (1) Agent Circuit ID
    Length: 14
    <Value: 0108000600018a9200a000000000>
    Agent Circuit ID: 0108000600018a9200a000000000
  - Option 82 Suboption: (2) Agent Remote ID
    Length: 6
    <Value: 707db9b84daf>
    Agent Remote ID: 707db9b84daf
  - Option 82 Suboption: (151) VRF name/VPN ID
    Length: 9
    <Value: 0074656e616e742d61>
  - VRF name:
    - [Expert Info (Warning/Undecoded): Trailing stray characters]
      [Trailing stray characters]
      <Message: Trailing stray characters>
      [Severity level: Warning]
      [Group: Undecoded]
  - Option 82 Suboption: (11) Server ID Override (10.10.10.1)
    Length: 4
    <Value: 0a0a0a01>
    Server ID Override: 10.10.10.1
  - Option 82 Suboption: (5) Link selection (10.10.10.0)
    Length: 4
    <Value: 0a0a0a00>
    Link selection: 10.10.10.0
  - Option: (255) End
    Option End: 255
    Padding: 00000000000000000000

```

DCHP-aanbieding verzenden via DCHP Server

```

Ethernet II, Src: 60:26:aa:85:98:87, Dst: 00:50:56:a5:dc:ca
Internet Protocol Version 4, Src: 172.16.10.8, Dst: 10.10.10.150
User Datagram Protocol, Src Port: 67, Dst Port: 67
Dynamic Host Configuration Protocol (Discover)
  Message type: Boot Request (1)
  Hardware type: Ethernet (0x01)
  Hardware address length: 6
  Hops: 1
  Transaction ID: 0xe9e35087
  Seconds elapsed: 0
  Bootp flags: 0x8000, Broadcast flag (Broadcast)
    1... .... .... .... = Broadcast flag: Broadcast
    .000 0000 0000 0000 = Reserved flags: 0x0000
  Client IP address: 0.0.0.0
  Your (client) IP address: 0.0.0.0
  Next server IP address: 0.0.0.0
  Relay agent IP address: 172.16.10.8
  Client MAC address: 00:50:56:a5:fd:dd
  Client hardware address padding: 00000000000000000000
  Server host name not given
  Boot file name not given
  Magic cookie: DHCP
  Option: (53) DHCP Message Type (Discover)
    Length: 1
    <Value: 01>
    DHCP: Discover (1)
  Option: (61) Client identifier
    Length: 7
    <Value: 01005056a5fd<dd>
    Hardware type: Ethernet (0x01)
    Client MAC address: 00:50:56:a5:fd:dd
  Option: (12) Host Name
    Length: 10
    <Value: 43584c6162732d573130>
    Host Name: CXLabs-W10
  Option: (60) Vendor class identifier
    Length: 8
    <Value: 4d53465420352e30>
    Vendor class identifier: MSFT 5.0
  Option: (55) Parameter Request List
    Length: 14
    <Value: 0103060f1f212b2c2e2f7779f9fc>
    Parameter Request List Item: (1) Subnet Mask
    Parameter Request List Item: (3) Router
    Parameter Request List Item: (6) Domain Name Server
    Parameter Request List Item: (15) Domain Name
    Parameter Request List Item: (31) Perform Router Discover
    Parameter Request List Item: (33) Static Route
    Parameter Request List Item: (43) Vendor-Specific Information
    Parameter Request List Item: (44) NetBIOS over TCP/IP Name Server
    Parameter Request List Item: (46) NetBIOS over TCP/IP Node Type
    Parameter Request List Item: (47) NetBIOS over TCP/IP Scope
    Parameter Request List Item: (119) Domain Search
    Parameter Request List Item: (121) Classless Static Route
    Parameter Request List Item: (249) Private/Classless Static Route (Microsoft)
    Parameter Request List Item: (252) Private/Proxy autodiscovery
  Option: (82) Agent Information Option
    Length: 47
    <Value: 010e0108000600018a9200a000000000206707db9b84daf97090074656e616e742d610b040a0a0a0105040a0a0a00>
  Option 82 Suboption: (1) Agent Circuit ID
    Length: 14
    <Value: 0108000600018a9200a000000000>
    Agent Circuit ID: 0108000600018a9200a000000000
  Option 82 Suboption: (2) Agent Remote ID
    Length: 6
    <Value: 707db9b84daf>
    Agent Remote ID: 707db9b84daf
  Option 82 Suboption: (151) VRF name/VPN ID
    Length: 9
    <Value: 0074656e616e742d61>
  VRF name:
  [Expert Info (Warning/Undecoded): Trailing stray characters]
  [Trailing stray characters]
  <Message: Trailing stray characters>
  [Severity level: Warning]
  [Group: Undecoded]
  Option 82 Suboption: (11) Server ID Override (10.10.10.1)
    Length: 4
    <Value: 0a0a0a01>
    Server ID Override: 10.10.10.1
  Option 82 Suboption: (5) Link selection (10.10.10.0)
    Length: 4
    <Value: 0a0a0a00>
    Link selection: 10.10.10.0
  Option: (255) End
    Option End: 255
    Padding: 00000000000000000000

```

DCHP-aanbieding op LEAF-2-vPC

Aanbieding ontvangen op LEAF-2-vPC	Aanbieding verzenden via LEAF-2-vPC
<pre> Ethernet II, Src: 00:50:56:a5:dc:ca, Dst: 00:00:0a:0a:0a:0a Internet Protocol Version 4, Src: 10.10.10.150, Dst: 172.16.10.8 User Datagram Protocol, Src Port: 67, Dst Port: 67 Dynamic Host Configuration Protocol (Offer) Message type: Boot Reply (2) Hardware type: Ethernet (0x01) Hardware address length: 6 Hops: 0 Transaction ID: 0xe9e35087 Seconds elapsed: 0 Bootp flags: 0x0000, Broadcast flag (Broadcast) 1... = Broadcast flag: Broadcast .000 0000 0000 0000 = Reserved flags: 0x0000 Client IP address: 0.0.0.0 Your (client) IP address: 10.10.10.3 Next server IP address: 10.10.10.150 Relay agent IP address: 172.16.10.8 Client MAC address: 00:50:56:a5:fd:dd Client hardware address padding: 00000000000000000000 Server host name not given Boot file name not given Magic cookie: DHCP Option: (53) DHCP Message Type (Offer) Length: 1 <Value: 02> DHCP: Offer (2) Option: (1) Subnet Mask (255.255.255.0) Length: 4 <Value: ffffffff> Subnet Mask: 255.255.255.0 Option: (58) Renewal Time Value Length: 4 <Value: 0000a8c0> Renewal Time Value: 12 hours (43200) Option: (59) Rebinding Time Value Length: 4 <Value: 00012750> Rebinding Time Value: 21 hours (75600) Option: (51) IP Address Lease Time Length: 4 <Value: 00015180> IP Address Lease Time: 1 day (86400) Option: (54) DHCP Server Identifier (10.10.10.1) Length: 4 <Value: 0a0a0a01> DHCP Server Identifier: 10.10.10.1 Option: (3) Router Length: 4 <Value: 0a0a0a01> Router: 10.10.10.1 Option: (15) Domain Name Length: 10 <Value: 636973636f2e636f6d00> Domain Name: cisco.com Option: (82) Agent Information Option Length: 47 <Value: 010e0108000600018a9200a00000000206707db9b84daf97090074656e616e742d610b040a0a0a0105040a0a00> Option 82 Suboption: (1) Agent Circuit ID Length: 14 <Value: 0108000600018a9200a000000000> Agent Circuit ID: 0108000600018a9200a000000000 Option 82 Suboption: (2) Agent Remote ID Length: 6 <Value: 707db9b84daf> Agent Remote ID: 707db9b84daf Option 82 Suboption: (151) VRF name/VPN ID Length: 9 <Value: 0074656e616e742d61> VRF name: [Expert Info (Warning/Undecoded): Trailing stray characters] [Trailing stray characters] <Message: Trailing stray characters> [Severity level: Warning] [Group: Undecoded] Option 82 Suboption: (11) Server ID Override (10.10.10.1) Length: 4 <Value: 0a0a0a01> Server ID Override: 10.10.10.1 Option 82 Suboption: (5) Link selection (10.10.10.0) Length: 4 <Value: 0a0a0a00> Link selection: 10.10.10.0 Option: (255) End Option End: 255 </pre>	<pre> Ethernet II, Src: 00:26:aa:85:95:87, Dst: 10:b3:d6:a4:85:97 Internet Protocol Version 4, Src: 13.13.13.254, Dst: 5.5.5.5 User Datagram Protocol, Src Port: 65518, Dst Port: 4789 Virtual Extensible Local Area Network Flags: 0x0000, VXLAN Network ID (VNI) Group Policy ID: 0 VXLAN Network Identifier (VNI): 303030 Reserved: 0 Ethernet II, Src: 02:00:0d:0d:0d:fe, Dst: 70:7d:b9:b8:4d:af Internet Protocol Version 4, Src: 10.10.10.150, Dst: 172.16.10.8 User Datagram Protocol, Src Port: 67, Dst Port: 67 Dynamic Host Configuration Protocol (Offer) Message type: Boot Reply (2) Hardware type: Ethernet (0x01) Hardware address length: 6 Hops: 0 Transaction ID: 0xe9e35087 Seconds elapsed: 0 Bootp flags: 0x0000, Broadcast flag (Broadcast) 1... = Broadcast flag: Broadcast .000 0000 0000 0000 = Reserved flags: 0x0000 Client IP address: 0.0.0.0 Your (client) IP address: 10.10.10.3 Next server IP address: 10.10.10.150 Relay agent IP address: 172.16.10.8 Client MAC address: 00:50:56:a5:fd:dd Client hardware address padding: 00000000000000000000 Server host name not given Boot file name not given Magic cookie: DHCP Option: (53) DHCP Message Type (Offer) Length: 1 <Value: 02> DHCP: Offer (2) Option: (1) Subnet Mask (255.255.255.0) Length: 4 <Value: ffffffff> Subnet Mask: 255.255.255.0 Option: (58) Renewal Time Value Length: 4 <Value: 0000a8c0> Renewal Time Value: 12 hours (43200) Option: (59) Rebinding Time Value Length: 4 <Value: 00012750> Rebinding Time Value: 21 hours (75600) Option: (51) IP Address Lease Time Length: 4 <Value: 00015180> IP Address Lease Time: 1 day (86400) Option: (54) DHCP Server Identifier (10.10.10.1) Length: 4 <Value: 0a0a0a01> DHCP Server Identifier: 10.10.10.1 Option: (3) Router Length: 4 <Value: 0a0a0a01> Router: 10.10.10.1 Option: (15) Domain Name Length: 10 <Value: 636973636f2e636f6d00> Domain Name: cisco.com Option: (82) Agent Information Option Length: 47 <Value: 010e0108000600018a9200a00000000206707db9b84daf97090074656e616e742d610b040a0a0a0105040a0a00> Option 82 Suboption: (1) Agent Circuit ID Length: 14 <Value: 0108000600018a9200a000000000> Agent Circuit ID: 0108000600018a9200a000000000 Option 82 Suboption: (2) Agent Remote ID Length: 6 <Value: 707db9b84daf> Agent Remote ID: 707db9b84daf Option 82 Suboption: (151) VRF name/VPN ID Length: 9 <Value: 0074656e616e742d61> VRF name: [Expert Info (Warning/Undecoded): Trailing stray characters] [Trailing stray characters] <Message: Trailing stray characters> [Severity level: Warning] [Group: Undecoded] Option 82 Suboption: (11) Server ID Override (10.10.10.1) Length: 4 <Value: 0a0a0a01> Server ID Override: 10.10.10.1 Option 82 Suboption: (5) Link selection (10.10.10.0) Length: 4 <Value: 0a0a0a00> Link selection: 10.10.10.0 Option: (255) End Option End: 255 </pre>

DHCP-aanbieding vPC SPINE

Aanbieding ontvangen op SPINE	Aanbieding verzenden via SPINE
-------------------------------	--------------------------------

<pre> Ethernet II, Src: 60:26:aa:85:95:87, Dst: 10:b3:d6:a4:85:97 Internet Protocol Version 4, Src: 13.13.13.254, Dst: 5.5.5.5 User Datagram Protocol, Src Port: 65518, Dst Port: 4789 Virtual eXtensible Local Area Network Flags: 0x0000, VXLAN Network ID (VNI) Group Policy ID: 0 VXLAN Network Identifier (VNI): 303030 Reserved: 0 Ethernet II, Src: 02:00:0d:0d:0d:fe, Dst: 70:7d:b9:b8:4d:af Internet Protocol Version 4, Src: 10.10.10.150, Dst: 172.16.10.8 User Datagram Protocol, Src Port: 67, Dst Port: 67 Dynamic Host Configuration Protocol (Offer) Message type: Boot Reply (2) Hardware type: Ethernet (0x01) Hardware address length: 6 Hops: 0 Transaction ID: 0xe9e35087 Seconds elapsed: 0 Bootp flags: 0x0000, Broadcast flag (Broadcast) 1... = Broadcast flag: Broadcast .000 0000 0000 0000 = Reserved flags: 0x0000 Client IP address: 0.0.0.0 Your (client) IP address: 10.10.10.3 Next server IP address: 10.10.10.150 Relay agent IP address: 172.16.10.8 Client MAC address: 00:50:56:a5:fd:dd Server hardware address padding: 00000000000000000000 Server host name not given Boot file name not given Magic cookie: DHCP Option: (53) DHCP Message Type (Offer) Length: 1 <Value: 02> DHCP: Offer (2) Option: (1) Subnet Mask (255.255.255.0) Length: 4 <Value: ffffffff> Subnet Mask: 255.255.255.0 Option: (58) Renewal Time Value Length: 4 <Value: 0000a8c0> Renewal Time Value: 12 hours (43200) Option: (59) Rebinding Time Value Length: 4 <Value: 00012750> Rebinding Time Value: 21 hours (75600) Option: (51) IP Address Lease Time Length: 4 <Value: 00015180> IP Address Lease Time: 1 day (86400) Option: (54) DHCP Server Identifier (10.10.10.1) Length: 4 <Value: 0a0a0a01> DHCP Server Identifier: 10.10.10.1 Option: (3) Router Length: 4 <Value: 0a0a0a01> Router: 10.10.10.1 Option: (15) Domain Name Length: 10 <Value: 636973636f2e636f6d00> Domain Name: cisco.com Option: (82) Agent Information Option Length: 47 <Value: 010e0108000600018a9200a00000000206707db9b84daf97090074656e616e742d610b040a0a0a0105040a0a0a00> Option 82 Suboption: (1) Agent Circuit ID Length: 14 <Value: 0108000600018a9200a000000000> Agent Circuit ID: 0108000600018a9200a000000000 Option 82 Suboption: (2) Agent Remote ID Length: 6 <Value: 707db9b84daf> Agent Remote ID: 707db9b84daf Option 82 Suboption: (151) VRF name/VPN ID Length: 9 <Value: 0074656e616e742d61> VRF name: [Expert Info (Warning/Undecoded): Trailing stray characters] [Trailing stray characters] <Message: Trailing stray characters> [Severity level: Warning] [Group: Undecoded] Option 82 Suboption: (11) Server ID Override (10.10.10.1) Length: 4 <Value: 0a0a0a01> Server ID Override: 10.10.10.1 Option 82 Suboption: (5) Link selection (10.10.10.0) Length: 4 <Value: 0a0a0a00> Link selection: 10.10.10.0 Option: (255) End Option End: 255 </pre>	<pre> Ethernet II, Src: 10:b3:d6:a4:85:97, Dst: 70:7d:b9:b8:4d:af Internet Protocol Version 4, Src: 13.13.13.254, Dst: 5.5.5.5 User Datagram Protocol, Src Port: 65518, Dst Port: 4789 Virtual eXtensible Local Area Network Flags: 0x0000, VXLAN Network ID (VNI) Group Policy ID: 0 VXLAN Network Identifier (VNI): 303030 Reserved: 0 Ethernet II, Src: 02:00:0d:0d:0d:fe, Dst: 70:7d:b9:b8:4d:af Internet Protocol Version 4, Src: 10.10.10.150, Dst: 172.16.10.8 User Datagram Protocol, Src Port: 67, Dst Port: 67 Dynamic Host Configuration Protocol (Offer) Message type: Boot Reply (2) Hardware type: Ethernet (0x01) Hardware address length: 6 Hops: 0 Transaction ID: 0xe9e35087 Seconds elapsed: 0 Bootp flags: 0x0000, Broadcast flag (Broadcast) Client IP address: 0.0.0.0 Your (client) IP address: 10.10.10.3 Next server IP address: 10.10.10.150 Relay agent IP address: 172.16.10.8 Client MAC address: 00:50:56:a5:fd:dd Server hardware address padding: 00000000000000000000 Server host name not given Boot file name not given Magic cookie: DHCP Option: (53) DHCP Message Type (Offer) Length: 1 <Value: 02> DHCP: Offer (2) Option: (1) Subnet Mask (255.255.255.0) Length: 4 <Value: ffffffff> Subnet Mask: 255.255.255.0 Option: (58) Renewal Time Value Length: 4 <Value: 0000a8c0> Renewal Time Value: 12 hours (43200) Option: (59) Rebinding Time Value Length: 4 <Value: 00012750> Rebinding Time Value: 21 hours (75600) Option: (51) IP Address Lease Time Length: 4 <Value: 00015180> IP Address Lease Time: 1 day (86400) Option: (54) DHCP Server Identifier (10.10.10.1) Length: 4 <Value: 0a0a0a01> DHCP Server Identifier: 10.10.10.1 Option: (15) Domain Name Length: 10 <Value: 636973636f2e636f6d00> Domain Name: cisco.com Option: (82) Agent Information Option Length: 47 <Value: 010e0108000600018a9200a00000000206707db9b84daf97090074656e616e742d610b040a0a0a0105040a0a0a00> Option 82 Suboption: (1) Agent Circuit ID Length: 14 <Value: 0108000600018a9200a000000000> Agent Circuit ID: 0108000600018a9200a000000000 Option 82 Suboption: (2) Agent Remote ID Length: 6 <Value: 707db9b84daf> Agent Remote ID: 707db9b84daf Option 82 Suboption: (151) VRF name/VPN ID Length: 9 <Value: 0074656e616e742d61> VRF name: Option 82 Suboption: (11) Server ID Override (10.10.10.1) Length: 4 <Value: 0a0a0a01> Server ID Override: 10.10.10.1 Option 82 Suboption: (5) Link selection (10.10.10.0) Length: 4 <Value: 0a0a0a00> Link selection: 10.10.10.0 Option: (255) End Option End: 255 </pre>
---	---

DHCP-aanbieding op LEAF-1

Aanbieding ontvangen op LEAF-1	Aanbieding verzenden op LEAF-1
--------------------------------	--------------------------------

<pre> > Ethernet II, Src: 18:b3:d6:a4:85:97, Dst: 70:7d:b9:b8:4d:af > Internet Protocol Version 4, Src: 13.13.13.254, Dst: 5.5.5.5 > User Datagram Protocol, Src Port: 65518, Dst Port: 4789 > Virtual eXtensible Local Area Network > Flags: 0x8000, VXLAN Network ID (VNI) Group Policy ID: 0 VXLAN Network Identifier (VNI): 383038 Reserved: 0 > Ethernet II, Src: 02:00:0d:0d:0d:fe, Dst: 70:7d:b9:b8:4d:af > Internet Protocol Version 4, Src: 10.10.10.150, Dst: 172.16.10.8 > User Datagram Protocol, Src Port: 67, Dst Port: 67 > Dynamic Host Configuration Protocol (Offer) Message type: Boot Reply (2) Hardware type: Ethernet (0x01) Hardware address length: 6 Hops: 0 Transaction ID: 0xe9e35087 Seconds elapsed: 0 > Bootp flags: 0x8000, Broadcast flag (Broadcast) Client IP address: 0.0.0.0 Your (client) IP address: 10.10.10.3 Next server IP address: 10.10.10.150 Relay agent IP address: 172.16.10.8 Client MAC address: 00:50:56:a5:fd:dd Client hardware address padding: 00000000000000000000 Server host name not given Boot file name not given Magic cookie: DHCP > Option: (53) DHCP Message Type (Offer) Length: 1 <Value: 02> DHCP: Offer (2) > Option: (1) Subnet Mask (255.255.255.0) Length: 4 <Value: ffffffff> Subnet Mask: 255.255.255.0 > Option: (58) Renewal Time Value Length: 4 <Value: 0000a8c0> Renewal Time Value: 12 hours (43200) > Option: (59) Rebinding Time Value Length: 4 <Value: 00012750> Rebinding Time Value: 21 hours (75600) > Option: (51) IP Address Lease Time Length: 4 <Value: 00015180> IP Address Lease Time: 1 day (86400) > Option: (54) DHCP Server Identifier (10.10.10.1) Length: 4 <Value: 0a0a0a01> DHCP Server Identifier: 10.10.10.1 > Option: (15) Domain Name Length: 10 <Value: 636973636f2e636f6d00> Domain Name: cisco.com > Option: (82) Agent Information Option Length: 47 <Value: 010e0108000600018a9200a000000000206707db9b84daf97090074656e616e742d610b040a0a0a0105040a0a00> > Option 82 Suboption: (1) Agent Circuit ID Length: 14 <Value: 0108000600018a9200a000000000> Agent Circuit ID: 0108000600018a9200a000000000 > Option 82 Suboption: (2) Agent Remote ID Length: 6 <Value: 707db9b84daf> Agent Remote ID: 707db9b84daf > Option 82 Suboption: (151) VRF name/VPN ID Length: 9 <Value: 0074656e616e742d61> VRF name: > Option 82 Suboption: (11) Server ID Override (10.10.10.1) Length: 4 <Value: 0a0a0a01> Server ID Override: 10.10.10.1 > Option 82 Suboption: (5) Link selection (10.10.10.0) Length: 4 <Value: 0a0a0a00> Link selection: 10.10.10.0 > Option: (255) End Option End: 255 </pre>	<pre> > Ethernet II, Src: 70:7d:b9:b8:4d:af, Dst: ff:ff:ff:ff:ff:ff > Internet Protocol Version 4, Src: 10.10.10.1, Dst: 255.255.255.255 > User Datagram Protocol, Src Port: 67, Dst Port: 68 > Dynamic Host Configuration Protocol (Offer) Message type: Boot Reply (2) Hardware type: Ethernet (0x01) Hardware address length: 6 Hops: 0 Transaction ID: 0xe9e35087 Seconds elapsed: 0 > Bootp flags: 0x8000, Broadcast flag (Broadcast) Client IP address: 0.0.0.0 Your (client) IP address: 10.10.10.3 Next server IP address: 10.10.10.150 Relay agent IP address: 10.10.10.1 Client MAC address: 00:50:56:a5:fd:dd Client hardware address padding: 00000000000000000000 Server host name not given Boot file name not given Magic cookie: DHCP > Option: (53) DHCP Message Type (Offer) Length: 1 <Value: 02> DHCP: Offer (2) > Option: (1) Subnet Mask (255.255.255.0) Length: 4 <Value: ffffffff> Subnet Mask: 255.255.255.0 > Option: (58) Renewal Time Value Length: 4 <Value: 0000a8c0> Renewal Time Value: 12 hours (43200) > Option: (59) Rebinding Time Value Length: 4 <Value: 00012750> Rebinding Time Value: 21 hours (75600) > Option: (51) IP Address Lease Time Length: 4 <Value: 00015180> IP Address Lease Time: 1 day (86400) > Option: (54) DHCP Server Identifier (10.10.10.1) Length: 4 <Value: 0a0a0a01> DHCP Server Identifier: 10.10.10.1 > Option: (3) Router Length: 4 <Value: 0a0a0a01> Router: 10.10.10.1 > Option: (15) Domain Name Length: 10 <Value: 636973636f2e636f6d00> Domain Name: cisco.com > Option: (255) End Option End: 255 </pre>
--	---

DHCP-aanbieding ontvangen op HOST-1

```
> Ethernet II, Src: 70:7d:b9:b8:4d:af, Dst: ff:ff:ff:ff:ff:ff
> Internet Protocol Version 4, Src: 10.10.10.1, Dst: 255.255.255.255
> User Datagram Protocol, Src Port: 67, Dst Port: 68
> Dynamic Host Configuration Protocol (Offer)
  Message type: Boot Reply (2)
  Hardware type: Ethernet (0x01)
  Hardware address length: 6
  Hops: 0
  Transaction ID: 0xe9e35087
  Seconds elapsed: 0
  > Bootp flags: 0x8000, Broadcast flag (Broadcast)
  Client IP address: 0.0.0.0
  Your (client) IP address: 10.10.10.3
  Next server IP address: 10.10.10.150
  Relay agent IP address: 10.10.10.1
  Client MAC address: 00:50:56:a5:fd:dd
  Client hardware address padding: 0000000000000000000000
  Server host name not given
  Boot file name not given
  Magic cookie: DHCP
  > Option: (53) DHCP Message Type (Offer)
    Length: 1
    <Value: 02>
    DHCP: Offer (2)
  > Option: (1) Subnet Mask (255.255.255.0)
    Length: 4
    <Value: ffffffff00>
    Subnet Mask: 255.255.255.0
  > Option: (58) Renewal Time Value
    Length: 4
    <Value: 0000a8c0>
    Renewal Time Value: 12 hours (43200)
  > Option: (59) Rebinding Time Value
    Length: 4
    <Value: 00012750>
    Rebinding Time Value: 21 hours (75600)
  > Option: (51) IP Address Lease Time
    Length: 4
    <Value: 00015180>
    IP Address Lease Time: 1 day (86400)
  > Option: (54) DHCP Server Identifier (10.10.10.1)
    Length: 4
    <Value: 0a0a0a01>
    DHCP Server Identifier: 10.10.10.1
  > Option: (3) Router
    Length: 4
    <Value: 0a0a0a01>
    Router: 10.10.10.1
  > Option: (15) Domain Name
    Length: 10
    <Value: 636973636f2e636f6d00>
    Domain Name: cisco.com
  > Option: (255) End
    Option End: 255
```

Verzoek verzenden door HOST-1

```

> Ethernet II, Src: 00:50:56:a5:fd:dd, Dst: ff:ff:ff:ff:ff:ff
> Internet Protocol Version 4, Src: 0.0.0.0, Dst: 255.255.255.255
> User Datagram Protocol, Src Port: 68, Dst Port: 67
> Dynamic Host Configuration Protocol (Request)
  Message type: Boot Request (1)
  Hardware type: Ethernet (0x01)
  Hardware address length: 6
  Hops: 0
  Transaction ID: 0xe9e35087
  Seconds elapsed: 0
  Bootp flags: 0x8000, Broadcast flag (Broadcast)
    1... .... .... .... = Broadcast flag: Broadcast
    .000 0000 0000 0000 = Reserved flags: 0x0000
  Client IP address: 0.0.0.0
  Your (client) IP address: 0.0.0.0
  Next server IP address: 0.0.0.0
  Relay agent IP address: 0.0.0.0
  Client MAC address: 00:50:56:a5:fd:dd
  Client hardware address padding: 00000000000000000000
  Server host name not given
  Boot file name not given
  Magic cookie: DHCP
  Option: (53) DHCP Message Type (Request)
    Length: 1
    <Value: 03>
    DHCP: Request (3)
  Option: (61) Client identifier
    Length: 7
    <Value: 01005056a5fddd>
    Hardware type: Ethernet (0x01)
    Client MAC address: 00:50:56:a5:fd:dd
  Option: (50) Requested IP Address (10.10.10.3)
    Length: 4
    <Value: 0a0a0a03>
    Requested IP Address: 10.10.10.3
  Option: (54) DHCP Server Identifier (10.10.10.1)
    Length: 4
    <Value: 0a0a0a01>
    DHCP Server Identifier: 10.10.10.1
  Option: (12) Host Name
    Length: 10
    <Value: 43584c6162732d573130>
    Host Name: CXLabs-W10
  Option: (81) Client Fully Qualified Domain Name
    Length: 13
    <Value: 00000043584c6162732d573130>
  Flags: 0x00
    0000 .... = Reserved flags: 0x0
    .... 0... = Server DDNS: Some server updates
    .... .0.. = Encoding: ASCII encoding
    .... ..0. = Server overrides: No override
    .... ...0 = Server: Client
  A-RR result: 0
  PTR-RR result: 0
  Client name: CXLabs-W10
  Option: (60) Vendor class identifier
    Length: 8
    <Value: 4d53465420352e30>
    Vendor class identifier: MSFT 5.0
  Option: (55) Parameter Request List
    Length: 14
    <Value: 0103060f1f212b2c2e2f7779f9fc>
    Parameter Request List Item: (1) Subnet Mask
    Parameter Request List Item: (3) Router
    Parameter Request List Item: (6) Domain Name Server
    Parameter Request List Item: (15) Domain Name
    Parameter Request List Item: (31) Perform Router Discover
    Parameter Request List Item: (33) Static Route
    Parameter Request List Item: (43) Vendor-Specific Information
    Parameter Request List Item: (44) NetBIOS over TCP/IP Name Server
    Parameter Request List Item: (46) NetBIOS over TCP/IP Node Type
    Parameter Request List Item: (47) NetBIOS over TCP/IP Scope
    Parameter Request List Item: (119) Domain Search
    Parameter Request List Item: (121) Classless Static Route
    Parameter Request List Item: (249) Private/Classless Static Route (Microsoft)
    Parameter Request List Item: (252) Private/Proxy autodiscovery
  Option: (255) End
  Option End: 255

```

Verzoek op LEAF-1

Verzoek ontvangen op LEAF-1	Verzoek verzenden via LEAF-1
<pre> > Ethernet II, Src: 00:50:56:a5:fd:dd, Dst: ff:ff:ff:ff:ff:ff > Internet Protocol Version 4, Src: 0.0.0.0, Dst: 255.255.255.255 > User Datagram Protocol, Src Port: 68, Dst Port: 67 > Dynamic Host Configuration Protocol (Request) Message type: Boot Request (1) Hardware type: Ethernet (0x01) Hardware address length: 6 Hops: 0 Transaction ID: 0xe9e35087 Seconds elapsed: 0 > Bootp flags: 0x0000, Broadcast flag (Broadcast) 1... = Broadcast flag: Broadcast .000 0000 0000 0000 = Reserved flags: 0x0000 Client IP address: 0.0.0.0 Your (client) IP address: 0.0.0.0 Next server IP address: 0.0.0.0 Relay agent IP address: 0.0.0.0 Client MAC address: 00:50:56:a5:fd:dd Client hardware address padding: 00000000000000000000 Server host name not given Boot file name not given Magic cookie: DHCP > Option: (53) DHCP Message Type (Request) Length: 1 <Value: 03> DHCP: Request (3) > Option: (61) Client identifier Length: 7 <Value: 01005056a5fddd> Hardware type: Ethernet (0x01) Client MAC address: 00:50:56:a5:fd:dd > Option: (50) Requested IP Address (10.10.10.3) Length: 4 <Value: 0a0a0a03> Requested IP Address: 10.10.10.3 > Option: (54) DHCP Server Identifier (10.10.10.1) Length: 4 <Value: 0a0a0a01> DHCP Server Identifier: 10.10.10.1 > Option: (12) Host Name Length: 10 <Value: 43584c6162732d573130> Host Name: CXLabs-W10 > Option: (81) Client Fully Qualified Domain Name Length: 13 <Value: 00000043584c6162732d573130> > Flags: 0x00 0000 = Reserved flags: 0x0 0... = Server DDNS: Some server updates 0.. = Encoding: ASCII encoding 0. = Server overrides: No override 0 = Server: Client A-RR result: 0 PTR-RR result: 0 Client name: CXLabs-W10 > Option: (60) Vendor class identifier Length: 8 <Value: 4d53465420352e30> Vendor class identifier: MSFT 5.0 > Option: (55) Parameter Request List Length: 14 <Value: 0103060f1f212b2c2e2f779f9fc> Parameter Request List Item: (1) Subnet Mask Parameter Request List Item: (3) Router Parameter Request List Item: (6) Domain Name Server Parameter Request List Item: (15) Domain Name Parameter Request List Item: (31) Perform Router Discover Parameter Request List Item: (33) Static Route Parameter Request List Item: (43) Vendor-Specific Information Parameter Request List Item: (44) NetBIOS over TCP/IP Name Server Parameter Request List Item: (46) NetBIOS over TCP/IP Node Type Parameter Request List Item: (47) NetBIOS over TCP/IP Scope Parameter Request List Item: (119) Domain Search Parameter Request List Item: (121) Classless Static Route Parameter Request List Item: (249) Private/Classless Static Route (Microsoft) Parameter Request List Item: (252) Private/Proxy autodiscovery > Option: (255) End Option End: 255 </pre>	<pre> > Ethernet II, Src: 70:7d:b9:b8:4d:af, Dst: 10:b3:d6:a4:85:97 > Internet Protocol Version 4, Src: 5.5.5.5, Dst: 13.13.13.254 > User Datagram Protocol, Src Port: 51730, Dst Port: 4789 > Virtual Extensible Local Area Network > Flags: 0x0000, VXLAN Network ID (VNI) Group Policy ID: 0 VXLAN Network Identifier (VNI): 303030 Reserved: 0 > Ethernet II, Src: 70:7d:b9:b8:4d:af, Dst: 02:00:0d:0d:0d:fe > Internet Protocol Version 4, Src: 172.16.10.8, Dst: 10.10.10.150 > User Datagram Protocol, Src Port: 67, Dst Port: 67 > Dynamic Host Configuration Protocol (Request) Message type: Boot Request (1) Hardware type: Ethernet (0x01) Hardware address length: 6 Hops: 1 Transaction ID: 0xe9e35087 Seconds elapsed: 0 > Bootp flags: 0x0000, Broadcast flag (Broadcast) Client IP address: 0.0.0.0 Your (client) IP address: 0.0.0.0 Next server IP address: 0.0.0.0 Relay agent IP address: 172.16.10.8 Client MAC address: 00:50:56:a5:fd:dd Client hardware address padding: 00000000000000000000 Server host name not given Boot file name not given Magic cookie: DHCP > Option: (53) DHCP Message Type (Request) Length: 1 <Value: 03> DHCP: Request (3) > Option: (61) Client identifier Length: 7 <Value: 01005056a5fddd> Hardware type: Ethernet (0x01) Client MAC address: 00:50:56:a5:fd:dd > Option: (50) Requested IP Address (10.10.10.3) Length: 4 <Value: 0a0a0a03> Requested IP Address: 10.10.10.3 > Option: (54) DHCP Server Identifier (10.10.10.150) Length: 4 <Value: 0a0a0a96> DHCP Server Identifier: 10.10.10.150 > Option: (12) Host Name Length: 10 <Value: 43584c6162732d573130> Host Name: CXLabs-W10 > Option: (81) Client Fully Qualified Domain Name Length: 13 <Value: 00000043584c6162732d573130> > Flags: 0x00 A-RR result: 0 PTR-RR result: 0 Client name: CXLabs-W10 > Option: (60) Vendor class identifier Length: 8 <Value: 4d53465420352e30> Vendor class identifier: MSFT 5.0 > Option: (55) Parameter Request List Length: 14 <Value: 0103060f1f212b2c2e2f779f9fc> Parameter Request List Item: (1) Subnet Mask Parameter Request List Item: (3) Router Parameter Request List Item: (6) Domain Name Server Parameter Request List Item: (15) Domain Name Parameter Request List Item: (31) Perform Router Discover Parameter Request List Item: (33) Static Route Parameter Request List Item: (43) Vendor-Specific Information Parameter Request List Item: (44) NetBIOS over TCP/IP Name Server Parameter Request List Item: (46) NetBIOS over TCP/IP Node Type Parameter Request List Item: (47) NetBIOS over TCP/IP Scope Parameter Request List Item: (119) Domain Search Parameter Request List Item: (121) Classless Static Route Parameter Request List Item: (249) Private/Classless Static Route (Microsoft) Parameter Request List Item: (252) Private/Proxy autodiscovery > Option: (82) Agent Information Option Length: 47 <Value: 010e010800060018a9200a000000000206707db9b84daf97090074656e16e742d610b040a0a0105040a0a00> > Option 82 Suboption: (1) Agent Circuit ID Length: 14 <Value: 0108000600018a9200a000000000> Agent Circuit ID: 0108000600018a9200a000000000 > Option 82 Suboption: (2) Agent Remote ID Length: 6 <Value: 707db9b84daf> Agent Remote ID: 707db9b84daf > Option 82 Suboption: (151) VRF name/VPN ID Length: 9 <Value: 0074656e16e742d61> > VRF name: [Expert Info (Warning/Undecoded): Trailing stray characters] > Option 82 Suboption: (11) Server ID Override (10.10.10.1) Length: 4 <Value: 0a0a0a01> Server ID Override: 10.10.10.1 > Option 82 Suboption: (5) Link selection (10.10.10.0) Length: 4 <Value: 0a0a0a00> Link selection: 10.10.10.0 > Option: (255) End Option End: 255 </pre>

Verzoek op SPINE

Aanvraag ontvangen op SPINE	Aanvraag verzenden via SPINE
-----------------------------	------------------------------

Ethernet II, Src: 70:7d:b9:b8:4d:af, Dst: 10:b3:d6:a4:85:97
Internet Protocol Version 4, Src: 5.5.5.5, Dst: 13.13.13.254
User Datagram Protocol, Src Port: 51730, Dst Port: 4789
Virtual Extensible Local Area Network
Flags: 0x8000, VLAN Network ID (VNI)
Group Policy ID: 0
VLAN Network Identifier (VNI): 303030
Reserved: 0

Ethernet II, Src: 70:7d:b9:b8:4d:af, Dst: 02:00:0d:0d:0d:fe
Internet Protocol Version 4, Src: 172.16.10.8, Dst: 10.10.10.150
User Datagram Protocol, Src Port: 67, Dst Port: 67

Dynamic Host Configuration Protocol (Request)

Message type: Boot Request (1)
Hardware type: Ethernet (0x01)
Hardware address length: 6
Hops: 1
Transaction ID: 0xe9e35087
Seconds elapsed: 0
Bootp flags: 0x8000, Broadcast flag (Broadcast)
Client IP address: 0.0.0.0
Your (client) IP address: 0.0.0.0
Next server IP address: 0.0.0.0
Relay agent IP address: 172.16.10.8
Client MAC address: 00:50:56:a5:fd:dd
Client hardware address padding: 00000000000000000000
Server host name not given
Boot file name not given
Magic cookie: DHCP
Option: (53) DHCP Message Type (Request)
Length: 1
<Value: 03>
DHCP: Request (3)
Option: (61) Client Identifier
Length: 7
<Value: 01005056a5fddd>
Hardware type: Ethernet (0x01)
Client MAC address: 00:50:56:a5:fd:dd
Option: (50) Requested IP Address (10.10.10.3)
Length: 4
<Value: 0a0a0a03>
Requested IP Address: 10.10.10.3
Option: (54) DHCP Server Identifier (10.10.10.150)
Length: 4
<Value: 0a0a0a96>
DHCP Server Identifier: 10.10.10.150
Option: (12) Host Name
Length: 10
<Value: 43584c6162732d573130>
Host Name: CXLabs-W10
Option: (81) Client Fully Qualified Domain Name
Length: 13
<Value: 00000043584c6162732d573130>
Flags: 0x00
A-RR result: 0
PTR-RR result: 0
Client name: CXLabs-W10
Option: (60) Vendor class identifier
Length: 8
<Value: 4d53465420352e30>
Vendor class identifier: MSFT 5.0
Option: (55) Parameter Request List
Length: 14
<Value: 0103060f1f212b2c2e2f7779f9fc>
Parameter Request List Item: (1) Subnet Mask
Parameter Request List Item: (3) Router
Parameter Request List Item: (6) Domain Name Server
Parameter Request List Item: (15) Domain Name
Parameter Request List Item: (31) Perform Router Discover
Parameter Request List Item: (33) Static Route
Parameter Request List Item: (43) Vendor-Specific Information
Parameter Request List Item: (44) NetBIOS over TCP/IP Name Server
Parameter Request List Item: (46) NetBIOS over TCP/IP Node Type
Parameter Request List Item: (47) NetBIOS over TCP/IP Scope
Parameter Request List Item: (119) Domain Search
Parameter Request List Item: (121) Classless Static Route
Parameter Request List Item: (249) Private/Classless Static Route (Microsoft)
Parameter Request List Item: (252) Private/Proxy autodiscovery
Option: (82) Agent Information Option
Length: 47
<Value: 010e018000600018a9200a00000000206707db9b84daf97090074656e616e742d610b0040a0a0105040a0a0a00>
Option 82 Suboption: (1) Agent Circuit ID
Length: 14
<Value: 0108000600018a9200a000000000>
Agent Circuit ID: 0108000600018a9200a000000000
Option 82 Suboption: (2) Agent Remote ID
Length: 6
<Value: 707db9b84daf>
Agent Remote ID: 707db9b84daf
Option 82 Suboption: (151) VRF name/VPN ID
Length: 9
<Value: 0074656e616e742d61>
VRF name:
[Expert Info (Warning/Undecoded): Trailing stray characters]
Option 82 Suboption: (11) Server ID Override (10.10.10.1)
Length: 4
<Value: 0a0a0a01>
Server ID Override: 10.10.10.1
Option 82 Suboption: (5) Link selection (10.10.10.0)
Length: 4
<Value: 0a0a0a00>
Link selection: 10.10.10.0
Option: (255) End
Option End: 255

Ethernet II, Src: 10:b3:d6:a4:85:97, Dst: 00:26:aa:85:95:87
Internet Protocol Version 4, Src: 5.5.5.5, Dst: 13.13.13.254
User Datagram Protocol, Src Port: 51730, Dst Port: 4789
Virtual Extensible Local Area Network
Flags: 0x8000, VLAN Network ID (VNI)
Group Policy ID: 0
VLAN Network Identifier (VNI): 303030
Reserved: 0

Ethernet II, Src: 70:7d:b9:b8:4d:af, Dst: 02:00:0d:0d:0d:fe
Internet Protocol Version 4, Src: 172.16.10.8, Dst: 10.10.10.150
User Datagram Protocol, Src Port: 67, Dst Port: 67

Dynamic Host Configuration Protocol (Request)

Message type: Boot Request (1)
Hardware type: Ethernet (0x01)
Hardware address length: 6
Hops: 1
Transaction ID: 0xe9e35087
Seconds elapsed: 0
Bootp flags: 0x8000, Broadcast flag (Broadcast)
Client IP address: 0.0.0.0
Your (client) IP address: 0.0.0.0
Next server IP address: 0.0.0.0
Relay agent IP address: 172.16.10.8
Client MAC address: 00:50:56:a5:fd:dd
Client hardware address padding: 00000000000000000000
Server host name not given
Boot file name not given
Magic cookie: DHCP
Option: (53) DHCP Message Type (Request)
Length: 1
<Value: 03>
DHCP: Request (3)
Option: (61) Client identifier
Length: 7
<Value: 01005056a5fddd>
Hardware type: Ethernet (0x01)
Client MAC address: 00:50:56:a5:fd:dd
Option: (50) Requested IP Address (10.10.10.3)
Length: 4
<Value: 0a0a0a03>
Requested IP Address: 10.10.10.3
Option: (54) DHCP Server Identifier (10.10.10.150)
Length: 4
<Value: 0a0a0a96>
DHCP Server Identifier: 10.10.10.150
Option: (12) Host Name
Length: 10
<Value: 43584c6162732d573130>
Host Name: CXLabs-W10
Option: (81) Client Fully Qualified Domain Name
Length: 13
<Value: 00000043584c6162732d573130>
Flags: 0x00
A-RR result: 0
PTR-RR result: 0
Client name: CXLabs-W10
Option: (60) Vendor class identifier
Length: 8
<Value: 4d53465420352e30>
Vendor class identifier: MSFT 5.0
Option: (55) Parameter Request List
Length: 14
<Value: 0103060f1f212b2c2e2f7779f9fc>
Parameter Request List Item: (1) Subnet Mask
Parameter Request List Item: (3) Router
Parameter Request List Item: (6) Domain Name Server
Parameter Request List Item: (15) Domain Name
Parameter Request List Item: (31) Perform Router Discover
Parameter Request List Item: (33) Static Route
Parameter Request List Item: (43) Vendor-Specific Information
Parameter Request List Item: (44) NetBIOS over TCP/IP Name Server
Parameter Request List Item: (46) NetBIOS over TCP/IP Node Type
Parameter Request List Item: (47) NetBIOS over TCP/IP Scope
Parameter Request List Item: (119) Domain Search
Parameter Request List Item: (121) Classless Static Route
Parameter Request List Item: (249) Private/Classless Static Route (Microsoft)
Parameter Request List Item: (252) Private/Proxy autodiscovery
Option: (82) Agent Information Option
Length: 47
<Value: 010e018000600018a9200a00000000206707db9b84daf97090074656e616e742d610b0040a0a0105040a0a0a00>
Option 82 Suboption: (1) Agent Circuit ID
Length: 14
<Value: 0108000600018a9200a000000000>
Agent Circuit ID: 0108000600018a9200a000000000
Option 82 Suboption: (2) Agent Remote ID
Length: 6
<Value: 707db9b84daf>
Agent Remote ID: 707db9b84daf
Option 82 Suboption: (151) VRF name/VPN ID
Length: 9
<Value: 0074656e616e742d61>
VRF name:
Option 82 Suboption: (11) Server ID Override (10.10.10.1)
Length: 4
<Value: 0a0a0a01>
Server ID Override: 10.10.10.1
Option 82 Suboption: (5) Link selection (10.10.10.0)
Length: 4
<Value: 0a0a0a00>
Link selection: 10.10.10.0
Option: (255) End
Option End: 255

Verzoek op LEAF-2-vPC

ReceivPcd aanvragen op LEAF-2-vPC	Aanvraag verzenden via vPCAF-2-vPC
<pre> Ethernet II, Src: 10:b3:d6:a4:85:97, Dst: 00:26:aa:85:95:87 Internet Protocol Version 4, Src: 5.5.5.5, Dst: 13.13.13.254 User Datagram Protocol, Src Port: 51730, Dst Port: 4789 Virtual extensible Local Area Network Flags: 0x0000, VXLAN Network ID (VNI) Group Policy ID: 0 VXLAN Network Identifier (VNI): 303030 Reserved: 0 Ethernet II, Src: 70:7d:b9:b8:4d:af, Dst: 02:00:0d:0d:0d:fe Internet Protocol Version 4, Src: 172.16.10.8, Dst: 10.10.10.150 User Datagram Protocol, Src Port: 67, Dst Port: 67 Dynamic Host Configuration Protocol (Request) Message type: Boot Request (1) Hardware type: Ethernet (0x01) Hardware address length: 6 Hops: 1 Transaction ID: 0xe9e35087 Seconds elapsed: 0 Bootp flags: 0x0000, Broadcast flag (Broadcast) Client IP address: 0.0.0.0 Your (client) IP address: 0.0.0.0 Next server IP address: 0.0.0.0 Relay agent IP address: 172.16.10.8 Client MAC address: 00:50:56:a5:fd:dd Client hardware address padding: 00000000000000000000 Server host name not given Boot file name not given Magic cookie: DHCP Option (53) DHCP Message Type (Request) Length: 1 <Value: 03> DHCP: Request (3) Option (61) Client identifier Length: 7 <Value: 01005056a5fddd> Hardware type: Ethernet (0x01) Client MAC address: 00:50:56:a5:fd:dd Option (50) Requested IP Address (10.10.10.3) Length: 4 <Value: 0a0a0a03> Requested IP Address: 10.10.10.3 Option (54) DHCP Server Identifier (10.10.10.150) Length: 4 <Value: 0a0a0a96> DHCP Server Identifier: 10.10.10.150 Option (12) Host Name Length: 10 <Value: 43584c6162732d573130> Host Name: CXLabs-W10 Option (81) Client Fully Qualified Domain Name Length: 13 <Value: 00000043584c6162732d573130> Flags: 0x00 A-RR result: 0 PTR-RR result: 0 Client name: CXLabs-W10 Option (60) Vendor class identifier Length: 8 <Value: 4d53465428352e30> Vendor class identifier: MSFT 5.0 Option (55) Parameter Request List Length: 14 <Value: 0103060f1f212b2c2e2f779f9fc> Parameter Request List Item: (1) Subnet Mask Parameter Request List Item: (3) Router Parameter Request List Item: (6) Domain Name Server Parameter Request List Item: (15) Domain Name Parameter Request List Item: (31) Perform Router Discover Parameter Request List Item: (33) Static Route Parameter Request List Item: (43) Vendor-Specific Information Parameter Request List Item: (44) NetBIOS over TCP/IP Name Server Parameter Request List Item: (46) NetBIOS over TCP/IP Node Type Parameter Request List Item: (47) NetBIOS over TCP/IP Scope Parameter Request List Item: (119) Domain Search Parameter Request List Item: (121) Classless Static Route Parameter Request List Item: (249) Private/Classless Static Route (Microsoft) Parameter Request List Item: (252) Private/Proxy autodiscovery Option (82) Agent Information Option Length: 47 <Value: 010e0108000600018a920a000000000206707db9b84daf97090074656e16e742d610b040a0a0a0105040a0a0a00> Option 82 Suboption: (1) Agent Circuit ID Length: 14 <Value: 0108000600018a920a0000000000> Agent Circuit ID: 0108000600018a920a0000000000 Option 82 Suboption: (2) Agent Remote ID Length: 6 <Value: 707db9b84daf> Agent Remote ID: 707db9b84daf Option 82 Suboption: (151) VRF name/VPN ID Length: 9 <Value: 0074656e16e742d61> VRF name: Option 82 Suboption: (11) Server ID Override (10.10.10.1) Length: 4 <Value: 0a0a0a01> Server ID Override: 10.10.10.1 Option 82 Suboption: (5) Link selection (10.10.10.0) Length: 4 <Value: 0a0a0a00> Link selection: 10.10.10.0 Option (255) End Option End: 255 </pre>	<pre> Ethernet II, Src: 00:26:aa:85:95:87, Dst: 00:50:56:a5:dc:ca Internet Protocol Version 4, Src: 172.16.10.8, Dst: 10.10.10.150 User Datagram Protocol, Src Port: 67, Dst Port: 67 Dynamic Host Configuration Protocol (Request) Message type: Boot Request (1) Hardware type: Ethernet (0x01) Hardware address length: 6 Hops: 1 Transaction ID: 0xe9e35087 Seconds elapsed: 0 Bootp flags: 0x0000, Broadcast flag (Broadcast) Client IP address: 0.0.0.0 Your (client) IP address: 0.0.0.0 Next server IP address: 0.0.0.0 Relay agent IP address: 172.16.10.8 Client MAC address: 00:50:56:a5:fd:dd Client hardware address padding: 00000000000000000000 Server host name not given Boot file name not given Magic cookie: DHCP Option (53) DHCP Message Type (Request) Length: 1 <Value: 03> DHCP: Request (3) Option (61) Client identifier Length: 7 <Value: 01005056a5fddd> Hardware type: Ethernet (0x01) Client MAC address: 00:50:56:a5:fd:dd Option (50) Requested IP Address (10.10.10.3) Length: 4 <Value: 0a0a0a03> Requested IP Address: 10.10.10.3 Option (54) DHCP Server Identifier (10.10.10.150) Length: 4 <Value: 0a0a0a96> DHCP Server Identifier: 10.10.10.150 Option (12) Host Name Length: 10 <Value: 43584c6162732d573130> Host Name: CXLabs-W10 Option (81) Client Fully Qualified Domain Name Length: 13 <Value: 00000043584c6162732d573130> Flags: 0x00 A-RR result: 0 PTR-RR result: 0 Client name: CXLabs-W10 Option (60) Vendor class identifier Length: 8 <Value: 4d53465428352e30> Vendor class identifier: MSFT 5.0 Option (55) Parameter Request List Length: 14 <Value: 0103060f1f212b2c2e2f779f9fc> Parameter Request List Item: (1) Subnet Mask Parameter Request List Item: (3) Router Parameter Request List Item: (6) Domain Name Server Parameter Request List Item: (15) Domain Name Parameter Request List Item: (31) Perform Router Discover Parameter Request List Item: (33) Static Route Parameter Request List Item: (43) Vendor-Specific Information Parameter Request List Item: (44) NetBIOS over TCP/IP Name Server Parameter Request List Item: (46) NetBIOS over TCP/IP Node Type Parameter Request List Item: (47) NetBIOS over TCP/IP Scope Parameter Request List Item: (119) Domain Search Parameter Request List Item: (121) Classless Static Route Parameter Request List Item: (249) Private/Classless Static Route (Microsoft) Parameter Request List Item: (252) Private/Proxy autodiscovery Option (82) Agent Information Option Length: 47 <Value: 010e0108000600018a920a000000000206707db9b84daf97090074656e16e742d610b040a0a0a0105040a0a0a00> Option 82 Suboption: (1) Agent Circuit ID Length: 14 <Value: 0108000600018a920a0000000000> Agent Circuit ID: 0108000600018a920a0000000000 Option 82 Suboption: (2) Agent Remote ID Length: 6 <Value: 707db9b84daf> Agent Remote ID: 707db9b84daf Option 82 Suboption: (151) VRF name/VPN ID Length: 9 <Value: 0074656e16e742d61> VRF name: Option 82 Suboption: (11) Server ID Override (10.10.10.1) Length: 4 <Value: 0a0a0a01> Server ID Override: 10.10.10.1 Option 82 Suboption: (5) Link selection (10.10.10.0) Length: 4 <Value: 0a0a0a00> Link selection: 10.10.10.0 Option (255) End Option End: 255 </pre>

Aanvraag ontvangen op DHCP-server

```
Ethernet II, Src: 60:26:aa:85:95:87, Dst: 00:50:56:a5:dc:ca
> Internet Protocol Version 4, Src: 172.16.10.8, Dst: 10.10.10.150
> User Datagram Protocol, Src Port: 67, Dst Port: 67
Dynamic Host Configuration Protocol (Request)
  Message type: Boot Request (1)
  Hardware type: Ethernet (0x01)
  Hardware address length: 6
  Hops: 1
  Transaction ID: 0xe9e35087
  Seconds elapsed: 0
  > Bootp flags: 0x8000, Broadcast flag (Broadcast)
  Client IP address: 0.0.0.0
  Your (client) IP address: 0.0.0.0
  Next server IP address: 0.0.0.0
  Relay agent IP address: 172.16.10.8
  Client MAC address: 00:50:56:a5:fd:dd
  Client hardware address padding: 00000000000000000000
  Server host name not given
  Boot file name not given
  Magic cookie: DHCP
  > Option: (53) DHCP Message Type (Request)
    Length: 1
    <Value: 03>
    DHCP: Request (3)
  > Option: (61) Client identifier
    Length: 7
    <Value: 01005056a5fd00>
    Hardware type: Ethernet (0x01)
    Client MAC address: 00:50:56:a5:fd:dd
  > Option: (50) Requested IP Address (10.10.10.3)
    Length: 4
    <Value: 0a0a0a03>
    Requested IP Address: 10.10.10.3
  > Option: (54) DHCP Server Identifier (10.10.10.150)
    Length: 4
    <Value: 0a0a0a96>
    DHCP Server Identifier: 10.10.10.150
  > Option: (12) Host Name
    Length: 10
    <Value: 43584c6162732d573130>
    Host Name: CXLabs-W10
  > Option: (81) Client Fully Qualified Domain Name
    Length: 13
    <Value: 00000043584c6162732d573130>
    > Flags: 0x00
    A-RR result: 0
    PTR-RR result: 0
    Client name: CXLabs-W10
  > Option: (60) Vendor class identifier
    Length: 8
    <Value: 4d53465420352e30>
    Vendor class identifier: MSFT 5.0
  > Option: (55) Parameter Request List
    Length: 14
    <Value: 0103060f1f212b2c2e2f7779f9fc>
    Parameter Request List Item: (1) Subnet Mask
    Parameter Request List Item: (3) Router
    Parameter Request List Item: (6) Domain Name Server
    Parameter Request List Item: (15) Domain Name
    Parameter Request List Item: (31) Perform Router Discover
    Parameter Request List Item: (33) Static Route
    Parameter Request List Item: (43) Vendor-Specific Information
    Parameter Request List Item: (44) NetBIOS over TCP/IP Name Server
    Parameter Request List Item: (46) NetBIOS over TCP/IP Node Type
    Parameter Request List Item: (47) NetBIOS over TCP/IP Scope
    Parameter Request List Item: (119) Domain Search
    Parameter Request List Item: (121) Classless Static Route
    Parameter Request List Item: (249) Private/Classless Static Route (Microsoft)
    Parameter Request List Item: (252) Private/Proxy autodiscovery
  > Option: (82) Agent Information Option
    Length: 47
    <Value: 010e0108000600018a9200a00000000206707db9b84daf97090074656e616e742d610b040a0a0a0105040a0a0a00>
  > Option 82 Suboption: (1) Agent Circuit ID
    Length: 14
    <Value: 0108000600018a9200a000000000>
    Agent Circuit ID: 0108000600018a9200a000000000
  > Option 82 Suboption: (2) Agent Remote ID
    Length: 6
    <Value: 707db9b84daf>
    Agent Remote ID: 707db9b84daf
  > Option 82 Suboption: (151) VRF name/VPN ID
    Length: 9
    <Value: 0074656e616e742d61>
    > VRF name:
  > Option 82 Suboption: (11) Server ID Override (10.10.10.1)
    Length: 4
    <Value: 0a0a0a01>
    Server ID Override: 10.10.10.1
  > Option 82 Suboption: (5) Link selection (10.10.10.0)
    Length: 4
    <Value: 0a0a0a00>
    Link selection: 10.10.10.0
  > Option: (255) End
    Option End: 255
```

ACK verzenden via DHCP Server

```

> Ethernet II, Src: 00:50:56:a5:dc:ca, Dst: 00:00:0a:0a:0a:0a
> Internet Protocol Version 4, Src: 10.10.10.150, Dst: 172.16.10.8
> User Datagram Protocol, Src Port: 67, Dst Port: 67
< Dynamic Host Configuration Protocol (ACK)
  Message type: Boot Reply (2)
  Hardware type: Ethernet (0x01)
  Hardware address length: 6
  Hops: 0
  Transaction ID: 0xe9e35087
  Seconds elapsed: 0
  < Bootp flags: 0x8000, Broadcast flag (Broadcast)
    1... .... .... .... = Broadcast flag: Broadcast
    .000 0000 0000 0000 = Reserved flags: 0x0000
  Client IP address: 0.0.0.0
  Your (client) IP address: 10.10.10.3
  Next server IP address: 0.0.0.0
  Relay agent IP address: 172.16.10.8
  Client MAC address: 00:50:56:a5:fd:dd
  Client hardware address padding: 00000000000000000000
  Server host name not given
  Boot file name not given
  Magic cookie: DHCP
  < Option: (53) DHCP Message Type (ACK)
    Length: 1
    <Value: 05>
    DHCP: ACK (5)
  < Option: (58) Renewal Time Value
    Length: 4
    <Value: 0000a8c0>
    Renewal Time Value: 12 hours (43200)
  < Option: (59) Rebinding Time Value
    Length: 4
    <Value: 00012750>
    Rebinding Time Value: 21 hours (75600)
  < Option: (51) IP Address Lease Time
    Length: 4
    <Value: 00015180>
    IP Address Lease Time: 1 day (86400)
  < Option: (54) DHCP Server Identifier (10.10.10.1)
    Length: 4
    <Value: 0a0a0a01>
    DHCP Server Identifier: 10.10.10.1
  < Option: (1) Subnet Mask (255.255.255.0)
    Length: 4
    <Value: ffffffff00>
    Subnet Mask: 255.255.255.0
  < Option: (81) Client Fully Qualified Domain Name
    Length: 3
    <Value: 00ffff>
    > Flags: 0x00
    A-RR result: 255
    PTR-RR result: 255
  < Option: (3) Router
    Length: 4
    <Value: 0a0a0a01>
    Router: 10.10.10.1
  < Option: (15) Domain Name
    Length: 10
    <Value: 636973636f2e636f6d00>
    Domain Name: cisco.com
  < Option: (82) Agent Information Option
    Length: 47
    <Value: 010e0108000600018a9200a000000000206707db9b84daf97090074656e616e742d610b040a0a0105040a0a0a00>
  < Option 82 Suboption: (1) Agent Circuit ID
    Length: 14
    <Value: 0108000600018a9200a000000000>
    Agent Circuit ID: 0108000600018a9200a000000000
  < Option 82 Suboption: (2) Agent Remote ID
    Length: 6
    <Value: 707db9b84daf>
    Agent Remote ID: 707db9b84daf
  < Option 82 Suboption: (151) VRF name/VPN ID
    Length: 9
    <Value: 0074656e616e742d61>
  < VRF name:
    < [Expert Info (Warning/Undecoded): Trailing stray characters]
      [Trailing stray characters]
      <Message: Trailing stray characters>
      [Severity level: Warning]
      [Group: Undecoded]
  < Option 82 Suboption: (11) Server ID Override (10.10.10.1)
    Length: 4
    <Value: 0a0a0a01>
    Server ID Override: 10.10.10.1
  < Option 82 Suboption: (5) Link selection (10.10.10.0)
    Length: 4
    <Value: 0a0a0a00>
    Link selection: 10.10.10.0
  < Option: (255) End
    Option End: 255

```

ACK op LEAF-2-vPC

ACK ontvangen op LEAF-2-vPC	ACK verzenden via LEAF-2-vPC
<pre> Ethernet II, Src: 00:50:56:a5:dc:ca, Dst: 00:00:0a:0a:0a:0a Internet Protocol Version 4, Src: 10.10.10.150, Dst: 172.16.10.8 User Datagram Protocol, Src Port: 67, Dst Port: 67 Dynamic Host Configuration Protocol (ACK) Message type: Boot Reply (2) Hardware type: Ethernet (0x81) Hardware address length: 6 Hops: 0 Transaction ID: 0xe9e35087 Seconds elapsed: 0 Bootp flags: 0x0000, Broadcast flag (Broadcast) 1... = Broadcast flag: Broadcast .000 0000 0000 0000 = Reserved flags: 0x0000 Client IP address: 0.0.0.0 Your (client) IP address: 10.10.10.3 Next server IP address: 0.0.0.0 Relay agent IP address: 172.16.10.8 Client MAC address: 00:50:56:a5:fd:dd Client hardware address padding: 00000000000000000000 Server host name not given Boot file name not given Magic cookie: DHCP Option: (53) DHCP Message Type (ACK) Length: 1 <Value: 05> DHCP: ACK (5) Option: (58) Renewal Time Value Length: 4 <Value: 0000a8c0> Renewal Time Value: 12 hours (43200) Option: (59) Rebinding Time Value Length: 4 <Value: 00012750> Rebinding Time Value: 21 hours (75600) Option: (51) IP Address Lease Time Length: 4 <Value: 00015180> IP Address Lease Time: 1 day (86400) Option: (54) DHCP Server Identifier (10.10.10.1) Length: 4 <Value: 0a0a0a01> DHCP Server Identifier: 10.10.10.1 Option: (1) Subnet Mask (255.255.255.0) Length: 4 <Value: ffffffff00> Subnet Mask: 255.255.255.0 Option: (81) Client Fully Qualified Domain Name Length: 3 <Value: 00ffff> Flags: 0x00 A-RR result: 255 PTR-RR result: 255 Option: (3) Router Length: 4 <Value: 0a0a0a01> Router: 10.10.10.1 Option: (15) Domain Name Length: 10 <Value: 636973636f2e636f6d00> Domain Name: cisco.com Option: (82) Agent Information Option Length: 47 <Value: 010e0108000600018a9200a00000000206707db9b84daf97090074656e616e742d610b040a0a0a0105040a0a0a00> Option 82 Suboption: (1) Agent Circuit ID Length: 14 <Value: 0108000600018a9200a000000000> Agent Circuit ID: 0108000600018a9200a000000000 Option 82 Suboption: (2) Agent Remote ID Length: 6 <Value: 707db9b84daf> Agent Remote ID: 707db9b84daf Option 82 Suboption: (151) VRF name/VPN ID Length: 9 <Value: 0074656e616e742d061> VRF name: [Expert Info (Warning/Undecoded): Trailing stray characters] [Trailing stray characters] <Message: Trailing stray characters> [Severity level: Warning] [Group: Undecoded] Option 82 Suboption: (11) Server ID Override (10.10.10.1) Length: 4 <Value: 0a0a0a01> Server ID Override: 10.10.10.1 Option 82 Suboption: (5) Link selection (10.10.10.0) Length: 4 <Value: 0a0a0a00> Link selection: 10.10.10.0 Option: (255) End Option End: 255 </pre>	<pre> Ethernet II, Src: 00:26:aa:85:95:07, Dst: 10:b3:d6:04:85:97 Internet Protocol Version 4, Src: 13.13.13.254, Dst: 5.5.5.5 User Datagram Protocol, Src Port: 65518, Dst Port: 4789 Virtual eXtensible Local Area Network Flags: 0x0000, VXLAN Network ID (VNI) Group Policy ID: 0 VXLAN Network Identifier (VNI): 303030 Reserved: 0 Ethernet II, Src: 02:00:0d:0d:0d:fe, Dst: 70:7d:b9:b8:4d:af Internet Protocol Version 4, Src: 10.10.10.150, Dst: 172.16.10.8 User Datagram Protocol, Src Port: 67, Dst Port: 67 Dynamic Host Configuration Protocol (ACK) Message type: Boot Reply (2) Hardware type: Ethernet (0x81) Hardware address length: 6 Hops: 0 Transaction ID: 0xe9e35087 Seconds elapsed: 0 Bootp flags: 0x0000, Broadcast flag (Broadcast) 1... = Broadcast flag: Broadcast .000 0000 0000 0000 = Reserved flags: 0x0000 Client IP address: 0.0.0.0 Your (client) IP address: 10.10.10.3 Next server IP address: 0.0.0.0 Relay agent IP address: 172.16.10.8 Client MAC address: 00:50:56:a5:fd:dd Client hardware address padding: 00000000000000000000 Server host name not given Boot file name not given Magic cookie: DHCP Option: (53) DHCP Message Type (ACK) Length: 1 <Value: 05> DHCP: ACK (5) Option: (58) Renewal Time Value Length: 4 <Value: 0000a8c0> Renewal Time Value: 12 hours (43200) Option: (59) Rebinding Time Value Length: 4 <Value: 00012750> Rebinding Time Value: 21 hours (75600) Option: (51) IP Address Lease Time Length: 4 <Value: 00015180> IP Address Lease Time: 1 day (86400) Option: (54) DHCP Server Identifier (10.10.10.1) Length: 4 <Value: 0a0a0a01> DHCP Server Identifier: 10.10.10.1 Option: (1) Subnet Mask (255.255.255.0) Length: 4 <Value: ffffffff00> Subnet Mask: 255.255.255.0 Option: (81) Client Fully Qualified Domain Name Length: 3 <Value: 00ffff> Flags: 0x00 .000 .000 = Reserved flags: 0x0 ... 0... = Server DNS: Some server updates 0. = Encoding: ASCII encoding 0. = Server overrides: No override 0 = Server: Client A-RR result: 255 PTR-RR result: 255 Option: (3) Router Length: 4 <Value: 0a0a0a01> Router: 10.10.10.1 Option: (15) Domain Name Length: 10 <Value: 636973636f2e636f6d00> Domain Name: cisco.com Option: (82) Agent Information Option Length: 47 <Value: 010e0108000600018a9200a00000000206707db9b84daf97090074656e616e742d610b040a0a0a0105040a0a0a00> Option 82 Suboption: (1) Agent Circuit ID Length: 14 <Value: 0108000600018a9200a000000000> Agent Circuit ID: 0108000600018a9200a000000000 Option 82 Suboption: (2) Agent Remote ID Length: 6 <Value: 707db9b84daf> Agent Remote ID: 707db9b84daf Option 82 Suboption: (151) VRF name/VPN ID Length: 9 <Value: 0074656e616e742d061> VRF name: [Expert Info (Warning/Undecoded): Trailing stray characters] [Trailing stray characters] <Message: Trailing stray characters> [Severity level: Warning] [Group: Undecoded] Option 82 Suboption: (11) Server ID Override (10.10.10.1) Length: 4 <Value: 0a0a0a01> Server ID Override: 10.10.10.1 Option 82 Suboption: (5) Link selection (10.10.10.0) Length: 4 <Value: 0a0a0a00> Link selection: 10.10.10.0 Option: (255) End Option End: 255 </pre>

ACK op RUGGENGRAAT

ACK ontvangen op RUGGENGRAAT	ACK verzenden via SPINE
<pre> Ethernet II, Src: 00:126:aa:85:95:87, Dst: 10:b3:d6:a4:85:97 Internet Protocol Version 4, Src: 13.13.13.254, Dst: 5.5.5.5 User Datagram Protocol, Src Port: 65518, Dst Port: 4789 Virtual eXtensible Local Area Network Flags: 0x0000, VXLAN Network ID (VNI) Group Policy ID: 0 VXLAN Network Identifier (VNI): 303030 Reserved: 0 Ethernet II, Src: 02:00:0d:0d:0d:fe, Dst: 70:7d:b9:b8:4d:af Internet Protocol Version 4, Src: 10.10.10.150, Dst: 172.16.10.8 User Datagram Protocol, Src Port: 67, Dst Port: 67 Dynamic Host Configuration Protocol (ACK) Message type: Boot Reply (2) Hardware type: Ethernet (0x01) Hardware address length: 6 Hops: 0 Transaction ID: 0xe9e35087 Seconds elapsed: 0 Bootp flags: 0x0000, Broadcast flag (Broadcast) 1... .. = Broadcast flag: Broadcast .000 0000 0000 0000 = Reserved flags: 0x0000 Client IP address: 0.0.0.0 Your (client) IP address: 10.10.10.3 Next server IP address: 0.0.0.0 Relay agent IP address: 172.16.10.8 Client MAC address: 00:50:56:a5:fd:dd Client hardware address padding: 00000000000000000000 Server host name not given Boot file name not given Magic cookie: DHCP Option: (53) DHCP Message Type (ACK) Length: 1 <Value: 05> DHCP: ACK (5) Option: (58) Renewal Time Value Length: 4 <Value: 0000a8c0> Renewal Time Value: 12 hours (43200) Option: (59) Rebinding Time Value Length: 4 <Value: 00012750> Rebinding Time Value: 21 hours (75600) Option: (51) IP Address Lease Time Length: 4 <Value: 00015180> IP Address Lease Time: 1 day (86400) Option: (54) DHCP Server Identifier (10.10.10.1) Length: 4 <Value: 0a0a0a01> DHCP Server Identifier: 10.10.10.1 Option: (1) Subnet Mask (255.255.255.0) Length: 4 <Value: ffffffff00> Subnet Mask: 255.255.255.0 Option: (81) Client Fully Qualified Domain Name Length: 3 <Value: 00ffff> Flags: 0x00 0000 = Reserved flags: 0x0 ... 0... = Server DNS: Some server updates 0. = Encoding: ASCII encoding 0. = Server overrides: No override 0 = Server: Client A-RR result: 255 PTR-RR result: 255 Option: (3) Router Length: 4 <Value: 0a0a0a01> Router: 10.10.10.1 Option: (15) Domain Name Length: 10 <Value: 636973636f2e636f6400> Domain Name: cisco.com Option: (82) Agent Information Option Length: 47 <Value: 010e0108000600018a9200a00000000206707db9b84daf97090074656e616e742d610b040a0a0105040a0a0000> Option 82 Suboption: (1) Agent Circuit ID Length: 14 <Value: 0108000600018a9200a000000000> Agent Circuit ID: 0108000600018a9200a000000000 Option 82 Suboption: (2) Agent Remote ID Length: 6 <Value: 707db9b84daf> Agent Remote ID: 707db9b84daf Option 82 Suboption: (151) VRF name/VPN ID Length: 9 <Value: 0074656e616e742d61> VRF name: [Expert Info (Warning/Undecoded): Trailing stray characters] [Trailing stray characters] <Message: Trailing stray characters> [Severity level: Warning] [Group: Undecoded] Option 82 Suboption: (11) Server ID Override (10.10.10.1) Length: 4 <Value: 0a0a0a01> Server ID Override: 10.10.10.1 Option 82 Suboption: (5) Link selection (10.10.10.0) Length: 4 <Value: 0a0a0a00> Link selection: 10.10.10.0 Option: (255) End Option End: 255 </pre>	<pre> Ethernet II, Src: 10:b3:d6:a4:85:97, Dst: 70:7d:b9:b8:4d:af Internet Protocol Version 4, Src: 10.10.10.150, Dst: 5.5.5.5 User Datagram Protocol, Src Port: 65518, Dst Port: 4789 Virtual eXtensible Local Area Network Flags: 0x0000, VXLAN Network ID (VNI) Group Policy ID: 0 VXLAN Network Identifier (VNI): 303030 Reserved: 0 Ethernet II, Src: 02:00:0d:0d:0d:fe, Dst: 70:7d:b9:b8:4d:af Internet Protocol Version 4, Src: 10.10.10.150, Dst: 172.16.10.8 User Datagram Protocol, Src Port: 67, Dst Port: 67 Dynamic Host Configuration Protocol (ACK) Message type: Boot Reply (2) Hardware type: Ethernet (0x01) Hardware address length: 6 Hops: 0 Transaction ID: 0xe9e35087 Seconds elapsed: 0 Bootp flags: 0x0000, Broadcast flag (Broadcast) 1... .. = Broadcast flag: Broadcast .000 0000 0000 0000 = Reserved flags: 0x0000 Client IP address: 0.0.0.0 Your (client) IP address: 10.10.10.3 Next server IP address: 0.0.0.0 Relay agent IP address: 172.16.10.8 Client MAC address: 00:50:56:a5:fd:dd Client hardware address padding: 00000000000000000000 Server host name not given Boot file name not given Magic cookie: DHCP Option: (53) DHCP Message Type (ACK) Length: 1 <Value: 05> DHCP: ACK (5) Option: (58) Renewal Time Value Length: 4 <Value: 0000a8c0> Renewal Time Value: 12 hours (43200) Option: (59) Rebinding Time Value Length: 4 <Value: 00012750> Rebinding Time Value: 21 hours (75600) Option: (51) IP Address Lease Time Length: 4 <Value: 00015180> IP Address Lease Time: 1 day (86400) Option: (54) DHCP Server Identifier (10.10.10.1) Length: 4 <Value: 0a0a0a01> DHCP Server Identifier: 10.10.10.1 Option: (1) Subnet Mask (255.255.255.0) Length: 4 <Value: ffffffff00> Subnet Mask: 255.255.255.0 Option: (81) Client Fully Qualified Domain Name Length: 3 <Value: 00ffff> Flags: 0x00 0000 = Reserved flags: 0x0 ... 0... = Server DNS: Some server updates 0. = Encoding: ASCII encoding 0. = Server overrides: No override 0 = Server: Client A-RR result: 255 PTR-RR result: 255 Option: (3) Router Length: 4 <Value: 0a0a0a01> Router: 10.10.10.1 Option: (15) Domain Name Length: 10 <Value: 636973636f2e636f6400> Domain Name: cisco.com Option: (82) Agent Information Option Length: 47 <Value: 010e0108000600018a9200a00000000206707db9b84daf97090074656e616e742d610b040a0a0105040a0a0000> Option 82 Suboption: (1) Agent Circuit ID Length: 14 <Value: 0108000600018a9200a000000000> Agent Circuit ID: 0108000600018a9200a000000000 Option 82 Suboption: (2) Agent Remote ID Length: 6 <Value: 707db9b84daf> Agent Remote ID: 707db9b84daf Option 82 Suboption: (151) VRF name/VPN ID Length: 9 <Value: 0074656e616e742d61> VRF name: [Expert Info (Warning/Undecoded): Trailing stray characters] [Trailing stray characters] <Message: Trailing stray characters> [Severity level: Warning] [Group: Undecoded] Option 82 Suboption: (11) Server ID Override (10.10.10.1) Length: 4 <Value: 0a0a0a01> Server ID Override: 10.10.10.1 Option 82 Suboption: (5) Link selection (10.10.10.0) Length: 4 <Value: 0a0a0a00> Link selection: 10.10.10.0 Option: (255) End Option End: 255 </pre>

ACK op LEAF-1

ACK ontvangen op LEAF-1	ACK versturen met LEAF-1
-------------------------	--------------------------

<pre> > Ethernet II, Src: 10:b3:06:a4:85:97, Dst: 70:7d:b9:b8:4d:af > Internet Protocol Version 4, Src: 13.13.13.254, Dst: 5.5.5.5 > User Datagram Protocol, Src Port: 65518, Dst Port: 4789 > Virtual eXtensible Local Area Network > Flags: 0x0000, VLAN Network ID (VNI) Group Policy ID: 0 VLAN Network Identifier (VNI): 303030 Reserved: 0 > Ethernet II, Src: 02:00:0d:0d:0d:fe, Dst: 70:7d:b9:b8:4d:af > Internet Protocol Version 4, Src: 10.10.10.150, Dst: 172.16.10.8 > User Datagram Protocol, Src Port: 67, Dst Port: 67 > Dynamic Host Configuration Protocol (ACK) Message type: Boot Reply (2) Hardware type: Ethernet (0x01) Hardware address length: 6 Hops: 0 Transaction ID: 0xe9e35087 Seconds elapsed: 0 > Bootp flags: 0x0000, Broadcast flag (Broadcast) 1... .. = Broadcast flag: Broadcast .000 0000 0000 0000 = Reserved flags: 0x0000 Client IP address: 0.0.0.0 Your (client) IP address: 10.10.10.3 Next server IP address: 0.0.0.0 Relay agent IP address: 172.16.10.8 Client MAC address: 00:50:56:a5:fd:dd Client hardware address padding: 00000000000000000000 Server host name not given Boot file name not given Magic cookie: DHCP > Option: (53) DHCP Message Type (ACK) Length: 1 <Value: 05> DHCP: ACK (5) > Option: (58) Renewal Time Value Length: 4 <Value: 0000a8c0> Renewal Time Value: 12 hours (43200) > Option: (59) Rebinding Time Value Length: 4 <Value: 00012750> Rebinding Time Value: 21 hours (75600) > Option: (51) IP Address Lease Time Length: 4 <Value: 00015180> IP Address Lease Time: 1 day (86400) > Option: (54) DHCP Server Identifier (10.10.10.1) Length: 4 <Value: 0a0a0a01> DHCP Server Identifier: 10.10.10.1 > Option: (1) Subnet Mask (255.255.255.0) Length: 4 <Value: ffffffff00> Subnet Mask: 255.255.255.0 > Option: (81) Client Fully Qualified Domain Name Length: 3 <Value: 00ffff> > Flags: 0x00 0000 ... = Reserved flags: 0x0 ... 0... = Server DNS: Some server updates 0.. = Encoding: ASCII encoding 0. = Server overrides: No override 0 = Server: Client A-RR result: 255 PTR-RR result: 255 > Option: (3) Router Length: 4 <Value: 0a0a0a01> Router: 10.10.10.1 > Option: (15) Domain Name Length: 10 <Value: 636973636f2e636f6d00> Domain Name: cisco.com > Option: (82) Agent Information Option Length: 47 <Value: 010e0108000600018a9200a00000000206707db9b84daf97090074656e616e742d6100040a0a0105040a0a000> > Option 82 Suboption: (1) Agent Circuit ID Length: 14 <Value: 0180000600018a9200a00000000000> Agent Circuit ID: 0180000600018a9200a0000000000000 > Option 82 Suboption: (2) Agent Remote ID Length: 6 <Value: 707db9b84daf> Agent Remote ID: 707db9b84daf > Option 82 Suboption: (151) VRF name/VPN ID Length: 9 <Value: 0074656e616e742d61> VRF name: > [Expert Info (Warning/Undecoded): Trailing stray characters] [Trailing stray characters] <Message: Trailing stray characters> [Severity level: Warning] [Group: Undecoded] > Option 82 Suboption: (11) Server ID Override (10.10.10.1) Length: 4 <Value: 0a0a0a01> Server ID Override: 10.10.10.1 > Option 82 Suboption: (5) Link selection (10.10.10.0) Length: 4 <Value: 0a0a0a00> Link selection: 10.10.10.0 > Option: (255) End Option End: 255 </pre>	<pre> > Ethernet II, Src: 70:7d:b9:b8:4d:af, Dst: ff:ff:ff:ff:ff:ff > Internet Protocol Version 4, Src: 10.10.10.1, Dst: 255.255.255.255 > User Datagram Protocol, Src Port: 67, Dst Port: 68 > Dynamic Host Configuration Protocol (ACK) Message type: Boot Reply (2) Hardware type: Ethernet (0x01) Hardware address length: 6 Hops: 0 Transaction ID: 0xe9e35087 Seconds elapsed: 0 > Bootp flags: 0x0000, Broadcast flag (Broadcast) 1... .. = Broadcast flag: Broadcast .000 0000 0000 0000 = Reserved flags: 0x0000 Client IP address: 0.0.0.0 Your (client) IP address: 10.10.10.3 Next server IP address: 0.0.0.0 Relay agent IP address: 10.10.10.1 Client MAC address: 00:50:56:a5:fd:dd Client hardware address padding: 00000000000000000000 Server host name not given Boot file name not given Magic cookie: DHCP > Option: (53) DHCP Message Type (ACK) Length: 1 <Value: 05> DHCP: ACK (5) > Option: (58) Renewal Time Value Length: 4 <Value: 0000a8c0> Renewal Time Value: 12 hours (43200) > Option: (59) Rebinding Time Value Length: 4 <Value: 00012750> Rebinding Time Value: 21 hours (75600) > Option: (51) IP Address Lease Time Length: 4 <Value: 00015180> IP Address Lease Time: 1 day (86400) > Option: (54) DHCP Server Identifier (10.10.10.1) Length: 4 <Value: 0a0a0a01> DHCP Server Identifier: 10.10.10.1 > Option: (1) Subnet Mask (255.255.255.0) Length: 4 <Value: ffffffff00> Subnet Mask: 255.255.255.0 > Option: (81) Client Fully Qualified Domain Name Length: 3 <Value: 00ffff> > Flags: 0x00 0000 ... = Reserved flags: 0x0 ... 0... = Server DNS: Some server updates 0.. = Encoding: ASCII encoding 0. = Server overrides: No override 0 = Server: Client A-RR result: 255 PTR-RR result: 255 > Option: (3) Router Length: 4 <Value: 0a0a0a01> Router: 10.10.10.1 > Option: (15) Domain Name Length: 10 <Value: 636973636f2e636f6d00> Domain Name: cisco.com > Option: (255) End Option End: 255 </pre>
--	--

ACK op HOST-1

```

> Ethernet II, Src: 70:7d:b9:b8:4d:af, Dst: ff:ff:ff:ff:ff:ff
> Internet Protocol Version 4, Src: 10.10.10.1, Dst: 255.255.255.255
> User Datagram Protocol, Src Port: 67, Dst Port: 68
< Dynamic Host Configuration Protocol (ACK)
  Message type: Boot Reply (2)
  Hardware type: Ethernet (0x01)
  Hardware address length: 6
  Hops: 0
  Transaction ID: 0xe9e35087
  Seconds elapsed: 0
< Bootp flags: 0x8000, Broadcast flag (Broadcast)
  1... .... .... .... = Broadcast flag: Broadcast
  .000 0000 0000 0000 = Reserved flags: 0x0000
  Client IP address: 0.0.0.0
  Your (client) IP address: 10.10.10.3
  Next server IP address: 0.0.0.0
  Relay agent IP address: 10.10.10.1
  Client MAC address: 00:50:56:a5:fd:dd
  Client hardware address padding: 000000000000000000000000
  Server host name not given
  Boot file name not given
  Magic cookie: DHCP
< Option: (53) DHCP Message Type (ACK)
  Length: 1
  <Value: 05>
  DHCP: ACK (5)
< Option: (58) Renewal Time Value
  Length: 4
  <Value: 0000a8c0>
  Renewal Time Value: 12 hours (43200)
< Option: (59) Rebinding Time Value
  Length: 4
  <Value: 00012750>
  Rebinding Time Value: 21 hours (75600)
< Option: (51) IP Address Lease Time
  Length: 4
  <Value: 00015180>
  IP Address Lease Time: 1 day (86400)
< Option: (54) DHCP Server Identifier (10.10.10.1)
  Length: 4
  <Value: 0a0a0a01>
  DHCP Server Identifier: 10.10.10.1
< Option: (1) Subnet Mask (255.255.255.0)
  Length: 4
  <Value: ffffff00>
  Subnet Mask: 255.255.255.0
< Option: (81) Client Fully Qualified Domain Name
  Length: 3
  <Value: 00ffff>
  < Flags: 0x00
    0000 .... = Reserved flags: 0x0
    .... 0... = Server DDNS: Some server updates
    .... .0.. = Encoding: ASCII encoding
    .... ..0. = Server overrides: No override
    .... ...0 = Server: Client
  A-RR result: 255
  PTR-RR result: 255
< Option: (3) Router
  Length: 4
  <Value: 0a0a0a01>
  Router: 10.10.10.1
< Option: (15) Domain Name
  Length: 10
  <Value: 636973636f2e636f6d00>
  Domain Name: cisco.com
< Option: (255) End
  Option End: 255

```

Gerelateerde informatie

[VXLAN BGP EVPN configureren](#)

[VXLAN configureren](#)

[DHCP-gerelateerde problemen oplossen bij Nexus 9000](#)

[Cisco Nexus 9000 Series NX-OS VXLAN-configuratiehandleiding, release 10.4\(x\)](#)

Over deze vertaling

Cisco heeft dit document vertaald via een combinatie van machine- en menselijke technologie om onze gebruikers wereldwijd ondersteuningscontent te bieden in hun eigen taal. Houd er rekening mee dat zelfs de beste machinevertaling niet net zo nauwkeurig is als die van een professionele vertaler. Cisco Systems, Inc. is niet aansprakelijk voor de nauwkeurigheid van deze vertalingen en raadt aan altijd het oorspronkelijke Engelstalige document ([link](#)) te raadplegen.