



The bridge to possible

UCS X シリーズ M7 X-Direct Xccelerate オフアー発注ガイド

はじめに

Cisco UCS X シリーズ ダイレクトは、Cisco UCS X シリーズ モジュラ システムを内蔵 Cisco UCS ファブリック インターコネクト 9108 100G のペアを備えた自己完結型システムに変換します。チャンネル接続は、すべて Cisco Intersight または実績のある Cisco UCS Manager を介して管理されます。

Cisco UCS X シリーズ ダイレクトは、クラウドから組み立てられ、ワークロードに合わせて形成され、継続的に最適化されるインフラストラクチャにより、管理の詳細からビジネス成果へと思考をシフトするように設計されています。ハードウェアがソフトウェアのような柔軟性を持ち、変化に対応できるようになったため、将来のビジョンを自由に思い描くことができます。これにより、エッジアプリケーションが大幅に簡素化されます。

- **クラウド運用インフラストラクチャによるシンプル化**：Cisco Intersight を使用してワークロード要件に合わせてシステム リソースをシェーピングすることで、インテリジェントな視覚化、最適化、オーケストレーションをすべてのアプリケーションとインフラストラクチャに提供できます。
- **適応性のあるプラットフォームでシンプル化**：エッジアプリケーションには、さまざまな要件があります。エッジで、ブレード サーバーの密度と効率性とラック サーバーの拡張性を組み合わせた単一のプラットフォームを使用することで、パフォーマンス、自動化、効率性を向上させることができます。
- **将来を見据えて設計されたシステムによる簡素化**：次世代のプロセッサ、アクセラレータ、およびインターコネクトに対応するように設計されたモジュラシステムを使用して、新興テクノロジーを取り入れてリスクを軽減します。Software-as-a-Service (SaaS) として次々と提供される新機能が自動的に管理されます。

目的、対象者、範囲

目的

このドキュメントでは、UCS X シリーズ M7 X-Direct Xcelrate オファァの注文方法について説明します。

対象範囲

この発注ガイドでは、以下に関する情報について説明します。

- Cisco UCS X シリーズ M7 X-Direct Xcelrate オファァの注文構造
- 製品 ID (PID) カタログ
- サーバー ハードウェアおよびソフトウェア オプションの注文
- その他の技術情報へのリンク

対象読者

シスコを通じた購入方法（例：直接取引のお客様および第 1 階層パートナー）：

- シナリオ 1: Cisco Intersight Software License のエンタープライズ契約がないお客様
- シナリオ 2 : Cisco Intersight ソフトウェア ライセンス のエンタープライズ契約を締結しているお客様

ディストリビュータによる購入方法（例：第 1 階層と第 2 階層パートナー）：

- シナリオ 1: Cisco Intersight Software License のエンタープライズ契約がないお客様
- シナリオ 2 : Cisco Intersight ソフトウェア ライセンス のエンタープライズ契約を締結しているお客様

UCS X-Series M7 X-Direct Xcelerate Offer Ordering Structure

***Products Not available to order standalone. Can be ordered only under MLB**

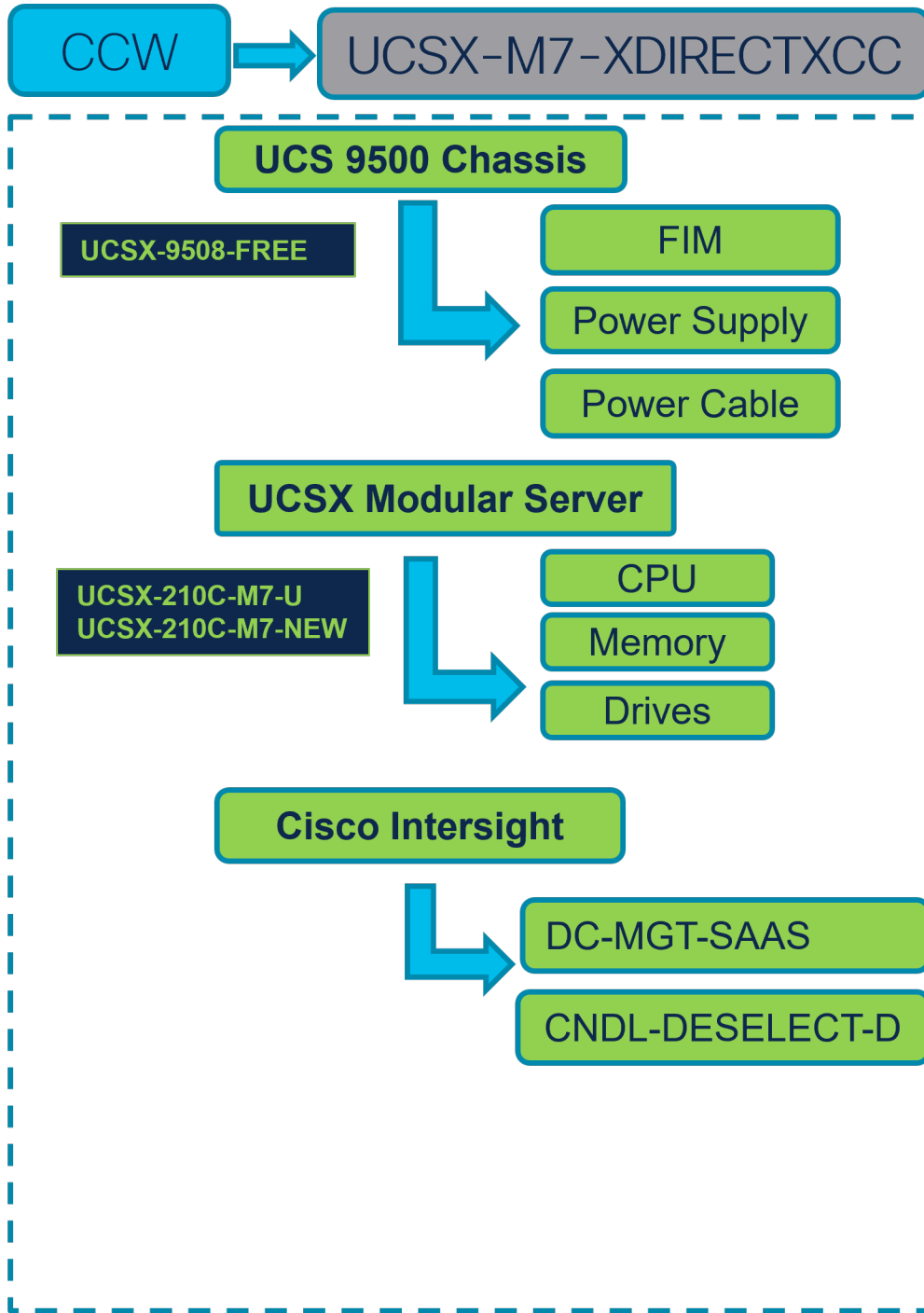

製品 ID (PID) カタログ

注： の部品番号の完全なリストについては、『Cisco UCS Fabric Interconnect 9108 100G Spec Sheet』、『Cisco UCS X9508 Chassis Spec Sheet』、および『Cisco UCS X210c M7 Compute Node Spec Sheet』を参照してください

表 1. 主要ラインのバンドル (MLB) の PID

製品 ID (PID)	説明
UCSX-M7-XDIRECTXCC	UCS-X M7 Xダイレクト XC加速オファー 承認が必要です

表 2. Cisco コンピューティング ハイパーコンバージド シャーシ メジャー ライン PID

製品 ID (PID)	説明
UCSX-9508-FREE	Cisco UCS 9508 シャーシの構成

表 3. Cisco コンピューティング ハイパーコンバージド サーバ ノード メジャー ライン PID

製品 ID (PID)	説明
UCSX-210C-M7-U (有料ノード)	Cisco UCS X210c M7 コンピューティング ノード 2S Intel 第 4 世代 CPU (CPU、メモリ、ドライブ ベイ、ドライブ、VIC アダプタ、またはメザニン アダプタ (有料ノード))
UCSX-210C-M7-NEW (無料ノード)	Cisco UCS X210c M7 コンピューティング ノード 2S Intel 第 4 世代 CPU (CPU、メモリ、ドライブ ベイ、ドライブ、VIC アダプタ、またはメザニン アダプタなし) (無料ノード)

表 4. Cisco Intersight メジャーライン PID

製品 ID (PID)	説明
DC-MGT-SAAS	Cisco Intersight SaaS
CNDL-DESELECT-D	条件付き選択解除

ステップバイステップの発注プロセス

シスコを通じた購入方法 (例: 直接取引のお客様および第 1 階層パートナー)

シナリオ 1: Cisco Intersight Software License のエンタープライズ契約がないお客様

ステップ 1.

CCW → UCSX-M7-XDIRECTXCC ← a

Add by SKU Description and Product Family 1 Add

Hardware, Software and Services Estimated Lead Time (Days) Unit List Price (USD) Qty Unit Net Price (USD) Discounts (%) Extended Net Price (USD)

SKU	Description	Lead Time	Unit Price	Qty	Net Price	Discounts	Extended Price
1.0 UCSX-M7-XDIRECTXCC	Invalid as of 03-Jun-2024 02:42:20 PDT	Not Applicable	0.00	1	0.00	0.00	0.00

b Select Options Validate Recommended Content Add Note Add Subtotal Copy Remove Line Additional Details

- CCW で MLB PID を検索して、[追加 (Add)] をクリックします。
- Configurator を入力するために、[オプションの選択 (Select Options)] をクリックします。

ステップ 2.

UCSX 9500 Chassis

UCSX-9508-FREE

FIM

Power Supply

Power Cable

UCSX 9500 CHASSIS > 1 Selected (Min 1, Max 1)

Product	Unit List Price (USD)	Adjusted List Price (USD)	Qty	Extended List Price (USD)
UCSX-9508-FREE Invalid		4,581.88	1	8,718.46
UCSX 9508 Free Chassis				

UCSX MODULAR SERVER > (Min 6, Max 8)

Product	Unit List Price (USD)	Adjusted List Price (USD)	Qty	Extended List Price (USD)
UCSX-210C-M7-U Invalid		7,455.38	5	37,276.90
UCS X210c M7 Compute Node 2S w/o CPU, Mem, Drv, Mezz				
UCSX-210C-M7-NEW Invalid		1,079.00	1	1,079.00
UCS X210c M7 R2L Free Compute Node 2S w/o CPU, Mem, Drv, Mez				

a b c

- 空きシャーシ : UCSX-9508-FREE は事前に選択されており、数量 1 のみを選択できます
- さらに構成が必要なため、UCSX-9508-FREE ATO ステータスが無効であることを通知します。
- Configurator を入力するために、[オプションの編集 (Edit Option)] をクリックします。

ステップ 3.

Product Configuration: UCSX-9508-FREE (part of UCSX-M7-XDIRECTXCC) | Estimated Lead Time: 21 days | Total (USD): 8,273.46

Configuration Summary:

Category	Qty	Extended List Price (USD)
Fabric Interconnect Module		
UCSX-S9108-100G	2	0.00
UCSX-S9108-SW	2	8,273.16
Power		
UCSX-PSU-2800AC-D	6	0.00
Accessory		
UCSX-C-DEBUGCBL-D	1	0.00
UCSX SW		
UCSX-CHASSIS-SW-D	1	0.00
Total		8,273.46
Estimated Lead Time		21 days

Power Cable Selection Table:

SKU	Qty	Estimated Lead Time	Unit List Price (USD)
<input type="radio"/> NO-POWER-CORD	6	3 days	0.00
<input type="radio"/> CAB-AC-2500W-EU	6	8 days	0.00
<input type="radio"/> CAB-AC-2500W-INT	6	8 days	0.00
<input type="radio"/> CAB-C19-CBN	6	14 days	0.00
<input type="radio"/> CAB-AC-C6K-TWLK	6	8 days	0.00

- ファブリック インターコネクト モジュールと電源のペアは、構成およびソフトウェア ライセンスに自動的に無料で付属しています。UCSX-S9108-SW が有料で事前に選択されています。
- 左側のカテゴリ ウィンドウから電源ケーブルを選択して、UCSX-9508-FREE を設定します。
- 「完了」をクリックします

ステップ 4.

Bundle Configuration: UCSX-M7-XDIRECTXCC | Estimated Lead Time: 21 days | Price List: Global Price List (USD) | Total: 47,074.36

Available Components:

Product	Unit List Price (USD)	Adjusted List Price (USD)	Qty	Extended List Price (USD)
UCSX 9500 CHASSIS > 1 Selected (Min 1, Max 1)				
UCSX-9508-FREE	0.30	4,581.88	1	8,718.46
UCSX MODULAR SERVER > 6 Selected (Min 6, Max 8)				
UCSX-210C-M7-U	7,455.38	7,455.38	5	37,276.90
UCSX-210C-M7-NEW	1,079.00	1,079.00	1	1,079.00
CISCO INTERSIGHT > 0 Selected (Min 1, Max 1)				

- a. ステータスには現在、[有効 (Valid)]として表示されています。
- b. [サービス/サブスクリプションの編集 (Edit Services/Subscriptions)]をクリックして、ハードウェアサポートの期間を編集します。

注： ハードウェア サポートの期間は、ソフトウェア サブスクリプション期間と一致させることをお勧めします。

ステップ 5.

The screenshot shows the 'Services/Subscriptions' configuration page for a UCS 9500 Chassis. The service selected is 'UCSX-9508-FREE' with a global price of 1,335.00 USD. The 'Service Options' section shows 'Choose Service Level from' set to 'All Service Programs' and 'Time Duration' set to 'Duration' with a value of 36 months. The 'Apply' button is highlighted with a red arrow 'b'. The 'Configuration Summary' at the bottom right shows 'Services' with a total price of 1,335.00 USD. The 'Done' button is also highlighted with a red arrow 'b'.

- a. [期間 (Term Duration)]を入力します。
- b. [適用 (Apply)]をクリックし、[完了 (Done)]をクリックします。

ステップ 6.

UCSX Modular Server

UCSX-210C-M7-U

CPU

Memory

Drives

Bundle Configuration
UCSX-M7-XDIRECTXCC

Estimated Lead Time
21 days

Global Price List (USD)

Set service preferences for this configuration

1: CISCO INTERSIGHT requires a minimum of 1 component(s). Please add additional quantities as necessary. (CE100010)
2: The category CISCO INTERSIGHT is required. (CE100103)
3: Please note that you are using a promotional PID which is available ONLY IF qualified for the 'UCS X-Series X-Direct Xccelerate' Program. For details on the program, Pls review Sales Connect, contact your Cisco Account Manager or reach out to ask-ucsx@external.cisco.com. We encourage you NOT to book this PID if you do not qualify. Order will be on hold after booking to check for eligibility. (CE202322)

Available Components	Unit List Price (USD)
UCSX 9500 CHASSIS	
UCSX MODULAR SERVER	
UCSX-210C-M7-U UCS X210c M7 Compute Node 2S w/o CPU, Mem, Drv, Mezz 5 required Estimated Lead Time: 21 days	6,376.38
UCSX-210C-M7-NEW UCS X210c M7 R2L Free Compute Node 2S w/o CPU, Mem, Drv, Mezz 1 required Estimated Lead Time: 21 days	0.00
CISCO INTERSIGHT	

UCSX 9500 CHASSIS > 1 Selected (Min 1, Max 1)	Unit List Price (USD)	Adjusted List Price (USD)	Qty	Extended List Price (USD)
UCSX-9508-FREE Valid UCS 9508 Free Chassis Add Custom Name Edit Options Edit Services/Subscriptions Remove Line		5,471.88	1	9,608.46

UCSX MODULAR SERVER > 5 Selected (Min 6, Max 8)	Unit List Price (USD)	Adjusted List Price (USD)	Qty	Extended List Price (USD)
UCSX-210C-M7-U Invalid UCS X210c M7 Compute Node 2S w/o CPU, Mem, Drv, Mezz Add Custom Name Edit Options Edit Services/Subscriptions Remove Line	7,455.38		5	37,276.90
UCSX-210C-M7-NEW UCS X210c M7 R2L Free Compute Node 2S w/o CPU, Mem, Drv, Mezz Add Custom Name Edit Options Edit Services/Subscriptions Remove Line	1,079.00		1	1,079.00

Add a UCSX MODULAR SERVER from the left panel

CISCO INTERSIGHT > 0 Selected (Min 1, Max 1)

- 有料サーバー：UCSX-210C-M7-U は MLB で数量 5 が事前に選択されており、最大数量 7 まで選択できます。
- さらに構成が必要なため、UCSX-210C-M7-U ATO ステータスが「無効」になっていることに注意してください。
- Configurator を入力するために、[オプションの編集 (Edit Option)] をクリックします。

ステップ 7.

UCSX Modular Server

UCSX-210C-M7-U

CPU
Memory
Drives

Product Configuration: UCSX-210C-M7-U part of UCSX-RECTXCC Estimated Lead Time: 21 days Price List: Global Price List in (USD) 38

Warning Messages:

- 1: A selection from Infrastructure and Workload is required. Please adjust the selections. (CE200277)
- 2: A selection of either UCSX-ML-V5Q50G-D or UCSX-ML-V5D200G-D or UCSX-MLV5D200GV2D from Rear MEZZ - MLOM/PCI is required. Please adjust the selections. (CE200096)
- 3: At least 1 selection(s) from Processor 4th Gen or Processor 5th Gen is required. Please make the selection. (CE200375)
- 4: UCSX-210C-M7-U quantity 1 requires a minimum quantity of 1 from Security Options (CE100012)

Configuration Summary

Category	Qty	Extended List Price (USD)
Processor 4th Gen		
Processor 5th Gen		
Memory 4800		
Memory 5600		
Front MEZZ - Controller		
Rear MEZZ - MLOM/PCI		
Storage Drives		
SATA M.2		
NVMe Boot		
Total		6,376.38
Estimated Lead Time		21 days

Options List:

SKU	Qty	Estimated Lead Time	Unit List Price (USD)
<input type="radio"/> UCSX-CPU-I8452Y Intel I8452Y 2GHz/300W 36C/67.5MB DDR5 4800MT/s	Qty	21 days	11,300.22
<input type="radio"/> UCSX-CPU-I8454H Intel I8454H 2.1GHz/270W 32C/82.5MB DDR5 4800MT/s	Qty	21 days	17,571.42
<input type="radio"/> UCSX-CPU-I8458P Intel I8458P 2.7GHz/350W 44C/82.5MB DDR5 4800MT/s	Qty	21 days	18,953.30
<input type="radio"/> UCSX-CPU-I8460H Intel I8460H 2.2GHz/330W 40C/105MB DDR5 4800MT/s	Qty	21 days	27,690.77
<input type="radio"/> UCSX-CPU-I8460Y+ Intel I8460Y+ 2GHz/300W 40C/105MB DDR5 4800MT/s	Qty	21 days	14,783.55

Buttons: Reset Configuration, Cancel, Done

- 左側のカテゴリ ウィンドウから周辺機器を選択して、UCSX--210C-M7-U を構成します。
- PID は右側のウィンドウにリストされます。メモリやストレージ ドライブなどの一部の PID はタイプまたはシリーズに従ってグループ化されます。右側の SKU ウィンドウの上にあるグループ化されたオプションから選択します。
- 警告メッセージに従って、最低限必要なオプション PID を構成します。
- 完了したら [完了 (Done)] をクリックします。

ステップ 8.

UCSX Modular Server

Bundle Configuration: UCSX-M7-XDIRECTXCC
Estimated Lead Time: 35 days
Price: Global Price List (USD)

Set service preferences for this configuration

1: CISCO INTERSIGHT requires a minimum of 1 component(s). Please add additional quantities as necessary. (CE100010)
2: The category CISCO INTERSIGHT is required. (CE100103)
3: Please note that you are using a promotional PID which is available ONLY IF qualified for the 'UCS X-Series X-Direct Xcelerate' Program. For details on the program, Pls review Sales Connect, contact your Cisco Account Manager or reach out to ask-ucsx@external.cisco.com. We encourage you NOT to book this PID if you do not qualify. Order will be on hold after booking to check for eligibility. (CE202322)

Product	Unit List Price (USD)	Adjusted List Price (USD)	Qty	Extended List Price (USD)
UCSX-9508-FREE Valid		5,471.88	1	9,608.46
UCSX-210C-M7-U Valid	19,845.99	19,845.99	5	456,155.70
UCSX-210C-M7-NEW Invalid	1,079.00	1,079.00	1	1,079.00

Available Components

- UCSX 9500 CHASSIS
- UCSX MODULAR SERVER
- UCSX-210C-M7-U (6,376.38)
- UCSX-210C-M7-NEW (0.00)
- CISCO INTERSIGHT

- ステータスには現在、[有効 (Valid)]として表示されています。
 - 同じ構成の倍数の数量を増やします。
 - 「PLUS」をクリックして、異なるオプション/数量の同じ製品を追加するか、異なる製品を選択します。
- ステップ 9.

UCSX Modular Server

Bundle Configuration: UCSX-M7-XDIRECTXCC
Estimated Lead Time: 35 days
Price: Global Price List (USD)

Set service preferences for this configuration

1: CISCO INTERSIGHT requires a minimum of 1 component(s). Please add additional quantities as necessary. (CE100010)
2: The category CISCO INTERSIGHT is required. (CE100103)
3: Please note that you are using a promotional PID which is available ONLY IF qualified for the 'UCS X-Series X-Direct Xcelerate' Program. For details on the program, Pls review Sales Connect, contact your Cisco Account Manager or reach out to ask-ucsx@external.cisco.com. We encourage you NOT to book this PID if you do not qualify. Order will be on hold after booking to check for eligibility. (CE202322)

Product	Unit List Price (USD)	Adjusted List Price (USD)	Qty	Extended List Price (USD)
UCSX-9508-FREE Valid		5,471.88	1	9,608.46
UCSX-210C-M7-U Valid	19,845.99	19,845.99	5	456,155.70
UCSX-210C-M7-NEW Invalid	1,079.00	1,079.00	1	1,079.00

Available Components

- UCSX 9500 CHASSIS
- UCSX MODULAR SERVER
- UCSX-210C-M7-U (6,376.38)
- UCSX-210C-M7-NEW (0.00)
- CISCO INTERSIGHT

- [サービス/サブスクリプションの編集 (Edit Services/Subscriptions)]をクリックして、ハードウェアサポートの期間を編集します。

注： ハードウェア サポートの期間は、ソフトウェア サブスクリプション期間と一致させることをお勧めします。

ステップ 10.

The screenshot shows the configuration page for the service **UCSX-210C-M7-U**. The page title is **UCSX Modular Server** and the service is categorized under **Services/Subscriptions**. The service price is listed as **3,237.00**. A notification states: "You may receive additional discounts because you selected two or more years of service. To review your discounts you can go to the Order or Quoting discount pages. (C0124)".

The **Service Options** section includes a search bar for service levels and a **Time Duration** section. The **Time Duration** section has three radio buttons: **Duration** (selected), **Delay service start to**, and **Co-Term service to**. The **Duration** field is set to **36** months. A red arrow labeled 'a' points to this field. Below the radio buttons are **Reset** and **Apply** buttons. A red arrow labeled 'b' points to the **Apply** button.

The **Service SKU** table shows the following items:

Service SKU	Product SKU	Unit List Price (USD)	Qty	Total List Price (USD)
Cisco Customer Experience Level 1 (1 ITEM) SERVICE PROGRAM	L1NCO (CX LEVEL 1 8X7XNCDOS) SUMMARY			
CON-L1NCO-UCSX023C CX LEVEL 1 8X7XNCDOS UCS X210c M7 Compute N... SERVICE SKU	UCSX-210C-M7-U UCS X210c M7 Compute Node 2S w/o CPU, Mem, Drv... PRODUCT SKU	3,237.00	1	3,237.00

At the bottom right, there is a **Configuration Summary** section showing "Services" with a price of "3,237.00". Below this are **Cancel** and **Done** buttons. A red arrow labeled 'b' points to the **Done** button.

- [期間 (Term Duration)] を入力します。
- [適用 (Apply)] をクリックし、[完了 (Done)] をクリックします。

ステップ 11.

UCSX Modular Server

UCSX-210C-M7-NEW

CPU

Memory

Drives

Bundle Configuration
UCSX-M7-XDIRECTXCC

Estimated Lead Time
35 days

Global Price List (USD)

Set service preferences for this configuration

1: CISCO INTERSIGHT requires a minimum of 1 component(s). Please add additional quantities as necessary. (CE100010)
2: The category CISCO INTERSIGHT is required. (CE100103)
3: Please note that you are using a promotional PID which is available ONLY IF qualified for the 'UCSX X-Series X-Direct Xccelerate' Program. For details on the program, Pls review Sales Connect, contact your Cisco Account Manager or reach out to ask-ucsx@external.cisco.com. We encourage you NOT to book this PID if you do not qualify. Order will be on hold after booking to check for eligibility. (CE202322)

Available Components	Unit List Price (USD)
UCSX 9500 CHASSIS	
UCSX MODULAR SERVER	
UCSX-210C-M7-U UCS X210c M7 Compute Node 2S w/o CPU, Mem, Drv, Mezz 5 required Estimated Lead Time: 21 days	6,376.38
UCSX-210C-M7-NEW UCS X210c M7 R2L Free Compute Node 2S w/o CPU, Mem, Drv, Mezz 1 required Estimated Lead Time: 21 days	0.00
CISCO INTERSIGHT	

UCSX 9500 CHASSIS > 1 Selected (Min 1, Max 1)	Unit List Price (USD)	Adjusted List Price (USD)	Qty	Extended List Price (USD)
UCSX-9508-FREE Valid UCS 9508 Free Chassis Add Custom Name Edit Options Edit Services/Subscriptions Remove Line		5,471.88	1	9,608.46

UCSX MODULAR SERVER > 6 Selected (Min 6, Max 6)	Unit List Price (USD)	Adjusted List Price (USD)	Qty	Extended List Price (USD)
UCSX-210C-M7-U Valid UCS X210c M7 Compute Node 2S w/o CPU, Mem, Drv, Mezz Add Custom Name Edit Options Edit Services/Subscriptions Remove Line		22,003.99	5	466,945.70
UCSX-210C-M7-NEW Invalid UCS X210c M7 R2L Free Compute Node 2S w/o CPU, Mem, Drv, Mezz Add Custom Name Edit Options Edit Services/Subscriptions Remove Line		1,079.00	1	1,079.00
CISCO INTERSIGHT > 0 Selected (Min 1, Max 1)				

- 空きサーバー : UCSX-210C-M7-NEW は事前に選択されており、数量 1 のみを選択できます。
- さらに構成が必要なため、UCSX-210C-M7 -NEW ATO ステータスが「無効」になっていることに注意してください。
- Configurator を入力するために、[オプションの編集 (Edit Option)] をクリックします。

注： 少なくとも 5 つの有料サーバーと 1 つの無料サーバーの構成は同じである必要があります。

ステップ 12.

UCSX Modular Server

UCSX-210C-M7-NEW

CPU

Memory

Drives

Product Configuration
UCSX-210C-M7-NEW part of UCSX-M7-XDIRECTXCC Estimated Lead Time 21 days Price List Global Price List in US Dollars (USD) 0.00

⚠️ 1: A selection from Infrastructure and Workload is required. Please adjust the selections. (CE200277)
 2: A selection of either UCSX-ML-V5Q50G-D or UCSX-ML-V5D200G-D or UCSX-MLV5D200GV2D from Rear MEZZ - MLOM/PCI is required. P
 3: At least 1 selection(s) from Processor 4th Gen or Processor 5th Gen is required. Please make the selection. (CE200375)
 4: Please note that this order will be placed on a Compliance Hold. Please reach out to sac-support@cisco.com to check if this order meets eligibility criteria for hold removal. Note that the order will remain on compliance hold if you do not reach out to sac-support@cisco.com to request eligibility check. (CE202322)

Configuration Summary [View Full Summary](#)

Category	Qty	Extended List Price (USD)
Processor 4th Gen		
Processor 5th Gen		
Memory 4800		
Memory 5600		
Front MEZZ - Controller		
Rear MEZZ - MLOM/PCI		
Storage Drives		
SATA M.2		
NVMe Boot		
Total		0.00
Estimated Lead Time		21 days

UCSX-210C-M7-NEW > Processor 4th Gen

8000 Processor Series 4th Gen | 6000 Processor Series 4th Gen | 5000 Processor Series 4th Gen | 4000 Processor Series 4th Gen | 3000 Processor Series 4th Gen

SKU	Qty	Estimated Lead Time	Unit List Price (USD)
<input type="radio"/> UCSX-CPU-I8452Y Intel I8452Y 2GHz/300W 36C/67.5MB DDR5 4800MT/s	Qty	21 days	0.00
<input type="radio"/> UCSX-CPU-I8454H Intel I8454H 2.1GHz/270W 32C/82.5MB DDR5 4800MT/s	Qty	21 days	0.00
<input type="radio"/> UCSX-CPU-I8458P Intel I8458P 2.7GHz/350W 44C/82.5MB DDR5 4800MT/s	Qty	21 days	0.00
<input type="radio"/> UCSX-CPU-I8460H Intel I8460H 2.2GHz/330W 40C/105MB DDR5 4800MT/s	Qty	21 days	0.00
<input type="radio"/> UCSX-CPU-I8460Y+ Intel I8460Y+ 2GHz/300W 40C/105MB DDR5 4800MT/s	Qty	21 days	0.00

Reset Configuration

- 左側のカテゴリ ウィンドウから周辺機器を選択して、UCSX-210C-M7-NEW を構成します。
- PID は右側のウィンドウにリストされます。メモリやストレージ ドライブなどの一部の PID はタイプまたはシリーズに従ってグループ化されます。右側の SKU ウィンドウの上にあるグループ化されたオプションから選択します。
- 警告メッセージに従って、最低限必要なオプション PID を構成します。
- 完了したら [完了 (Done)] をクリックします。

ステップ 13.

UCSX Modular Server

UCSX-210C-M7-NEW

➔

Services/Subscriptions

Bundle Configuration UCSX-M7-XDIRECTXCC	Estimated Lead Time 35 days	Price List Global Price List (USD)	Total 477,633.16
--	--------------------------------	---------------------------------------	---------------------

Set service preferences for this configuration Cancel Done

⚠ 1: CISCO INTERSIGHT requires a minimum of 1 component(s). Please add additional quantities as necessary. (CE100010)

2: The category CISCO INTERSIGHT is required. (CE100103)

3: Please note that you are using a promotional PID which is available ONLY IF qualified for the 'UCS X-Series X-Direct Xccelerate' Program. For details on the program, PIs review Sales Connect, contact your Cisco Account Manager or reach out to ask-ucsx@external.cisco.com. We encourage you NOT to book this PID if you do not qualify. Order will be on hold after booking to check for eligibility. (CE202322)

Available Components	Unit List Price (USD)	UCSX 9500 CHASSIS > 1 Selected (Min 1, Max 1)	Unit List Price (USD)	Adjusted List Price (USD)	Qty	Extended List Price (USD)
UCSX 9500 CHASSIS		UCSX-9508-FREE Valid ⚠		5,471.88	1	9,608.46
UCSX MODULAR SERVER		UCSX-210C-M7-U				
UCSX-210C-M7-U UCS X210c M7 Compute Node 2S w/o CPU, Mem, Drv, Mezz 5 required Estimated Lead Time: 21 days	6,376.38	UCSX-210C-M7-U Valid		22,003.99	5	466,945.70
UCSX-210C-M7-NEW UCS X210c M7 R2L Free Compute Node 2S w/o CPU, Mem, Drv, Mezz 1 required Estimated Lead Time: 21 days	0.00	UCSX-210C-M7-NEW Valid ⚠		1,079.00	1	1,079.00
CISCO INTERSIGHT		CISCO INTERSIGHT > 0 Selected (Min 1, Max 1)				

- a. ステータスには現在、[有効 (Valid)] として表示されています。
- b. [サービス/サブスクリプションの編集 (Edit Services/Subscriptions)] をクリックして、ハードウェアサポートの期間を編集します。

注： ハードウェア サポートの期間は、ソフトウェア サブスクリプション期間と一致させることをお勧めします。

ステップ 14.

UCSX Modular Server

Price List Global Price List **UCSX-210C-M7-NEW** Service Total 3,237.00

Services/Subscriptions

You may receive additional discounts because you selected two or more years of service. To review your discounts you can go to the Order or Quoting discount pages. (C0124)

Service Non Serviceable Products

The duration that you entered has been successfully applied to all the services. (C0329)

Service Options

Choose Service Level from All Service Programs

Search by Name & Description

Note: Cisco may still install another compatible service if required. Compatible services are the services that come with primary service and are based on products.

Time Duration

Duration 36

Delay service start to

Co-Term service to

Reset Apply

Service SKU	Product SKU	Unit List Price (USD)	Qty	Total List Price (USD)
Cisco Customer Experience Level 1 (1 ITEM) SERVICE PROGRAM	L1NCO (CX LEVEL 1 8X7XNCDOS) SUMMARY		36 Months	
CON-L1NCO-UCSX221C CX LEVEL 1 8X7XNCDOS UCS X210c M7 Compute N...	UCSX-210C-M7-NEW UCS X210c M7 R2L Free Compute Node 2S w/o CPU, ...	3,237.00	1	3,237.00

Remove All Services Remove All Additional Services

Configuration Summary All prices shown in USD

Services 3,237.00

Cancel Done

a. [期間 (Term Duration)] を入力します。

b. [適用 (Apply)] をクリックし、[完了 (Done)] をクリックします。

ステップ 15.

Cisco Intersight

Price List Global Price List **DC-MGT-SAAS**

Bundle Configuration UCSX-M7-DIRECTXCC Estimated Lead Time 35 days

Set service preferences for this configuration

1: The quantity of Cisco Intersight 2.0 - Infrastructure Services License under Offer: DC-MGT-SAAS should be equal to the quantity of Server selected. Please adjust the quantity. (CE200648)

2: Please note that you are using a promotional PID which is available ONLY IF qualified for the UCS X-Series X-Direct Xccelerate Program. For details on the program, PIs review Sales Connect, contact your Cisco Account Manager or reach out to ask-ucsx@external.cisco.com. We encourage you NOT to book this PID if you do not qualify. Order will be on hold after booking to check for eligibility. (CE202322)

DC-MGT-SAAS has been added to the bundle category CISCO INTERSIGHT.

Available Components

UCSX 9500 CHASSIS

UCSX MODULAR SERVER

CISCO INTERSIGHT

DC-MGT-SAAS
Cisco Intersight SaaS

CNDL-DESELECT-D
Conditional Deselect
Estimated Lead Time: --

UCSX 9500 CHASSIS > 1 Selected (Min 1, Max 1)

Product	Unit List Price (USD)	Adjusted List Price (USD)	Qty	Extended List Price (USD)
UCSX-9508-FREE Valid UCS 9508 Free Chassis		5,471.88	1	9,608.46

UCSX MODULAR SERVER > 6 Selected (Min 6, Max 8)

Product	Unit List Price (USD)	Adjusted List Price (USD)	Qty	Extended List Price (USD)
UCSX-210C-M7-U Valid UCS X210c M7 Compute Node 2S w/o CPU, Mem, Drv, Mezz		22,003.99	5	466,945.70
UCSX-210C-M7-NEW Valid UCS X210c M7 R2L Free Compute Node 2S w/o CPU, Mem, Drv, Mezz	3,237.00		1	3,237.00

Add a UCSX MODULAR SERVER from the left panel

CISCO INTERSIGHT > 1 Selected (Min 1, Max 1)

Product	Unit List Price (USD)	Adjusted List Price (USD)	Qty	Extended List Price (USD)
DC-MGT-SAAS Invalid Cisco Intersight SaaS		0.00	1	0.00

Requested Start Date 06-Jun-2024 Requested For 36 Months From 06-Jun-2024 To 06-Jun-2027 12 Months On 06-Jun-2027 Automatically Renews For Prepaid Term

- a. ハードウェア サポートの期間は、ソフトウェア サブスクリプション期間と同調させることをお勧めします。
- b. **Intersight** ソフトウェアを以前に購入していない場合は、**Intersight** を選択する必要があります。「PLUS」をクリックして選択してください【オプションの編集 (Edit Options)】をクリックします。

ステップ 16.

Cisco Intersight

Offer Configuration DC-MGT-SAAS(Part of UCSX-M7-DIRECTXCC)	Estimated Lead Time NA	<div style="background-color: #76b82a; color: white; padding: 2px 10px; border-radius: 5px; font-weight: bold; display: inline-block;">DC-MGT-SAAS</div>	Total (USD)
--	---------------------------	--	-------------

Requested Terms and Billing

Requested Start Date 06-Jun-2024	Requested For 36 Months From 06-Jun-2024 To 05-Jun-2027	Automatically Renews For 12 Months On 06-Jun-2027	Billing Frequency Prepaid Term
-------------------------------------	--	--	-----------------------------------

1: Cisco will apply a standard lead time to your requested start date based on the selected product. Cisco may not be able to honor the requested start date (RSD). In some cases, our systems may require additional lead-time to provision your services. Submitting a RSD that is too early could cause customer subscription billing issues. Verify the requested start date with your implementation team that aligns with customer deployment readiness. (C0742)

2: Your subscription will start and be eligible to be invoiced: i) 30 days or less (7 days for A-FLEX/A-FLEX-3/A-WHOLESALE) after Cisco notifies you that any portion of the subscription is ready for you to provision. OR, ii) the day any portion of the subscription is provisioned by Cisco, whichever of the two events happens first. (C01007)

REQUESTED FOR 36 Months From 06-Jun-2024 To 05-Jun-2027

<p>Requested Start Date</p> <p>Day: 6, Month: Jun, Year: 2024</p> <p><small>Enter any date up between 03-Jun-2024 and 31-Aug-2024</small></p>	<p>End Date</p> <p><input checked="" type="radio"/> Effective For 36 Months</p> <p><small>Enter any whole month value from 1-96</small></p> <p><input type="radio"/> Co-Term to an End Date</p> <p>Day: 5, Month: Jun, Year: 2027</p> <p><small>Enter any date up between 03-Sep-2024 and 05-Jun-2032</small></p>
--	--

<p>Automatically Renews For 12 Months On 06-Jun-2027</p> <p>Auto Renewal <input checked="" type="checkbox"/> On</p> <p>12 Months</p>	<p>Billing Frequency Prepaid Term</p> <p><input checked="" type="radio"/> Prepaid Term</p> <p><input type="radio"/> Annual Billing</p> <p><input type="radio"/> Quarterly Billing</p> <p><input type="radio"/> Monthly Billing</p>
--	---

Cancel Save Changes

- a. 希望開始日 (RSD) は、HW Ship Date に依存するようになり、HW が出荷されると自動的に開始されます。RSD を変更すると、ソフトウェアは選択した RSD またはハードウェア出荷日のいずれか遅い方から開始されます。
- b. 終了日 (月単位の期間) はデフォルトで 36 か月に設定され、自動更新 (オン/オフ) はデフォルトでオンに設定され、請求頻度はデフォルトで前払い期間に設定されます。それに応じて設定を変更することもできます。

ステップ 17.

© 2023 Cisco and/or its affiliates. All rights reserved.

16/58 ページ
Cisco Confidential

Cisco Intersight

↓

DC-MGT-SAAS

Offer Configuration: DC-MGT-SAAS(Part of UCSX-M7-XDIRECTXCC) | Estimated Lead Time: NA | Price: Global Price List (USD)

Requested Start Date: 06-Jun-2024 | Requested For: 36 Months From 06-Jun-2024 To 05-Jun-2027 | Automatically Renews For: 12 Months On 06-Jun-2027 | Billing Frequency: Prepaid Term

Please note that Cisco recommends Solution Support with Intersight which solves complex issues on average 44% faster than product support. For complete details, please refer to the following URL: https://www.cisco.com/c/m/en_us/customer-experience/support/solution-support.html (CE202322)

Your subscription will start and be eligible to be invoiced: i) 30 days or less (7 days for A-FLEX/A-FLEX-3/A-WHOLESALE) after Cisco notifies you that any portion of the subscription is ready for you to provision OR, ii) the day any portion of the subscription is provisioned by Cisco, whichever of the two events happens first. (C01007)

Configuration Summary

SKU	Qty	List Price
SVS-DCM-SUPT-BAS	1	\$0.00
		Per Each/Month
Total		\$0.00

DC-MGT-SAAS > Cisco Intersight 2.0 Infrastructure Services

Device	SKU	Description	Unit List Price (USD)	Action
Qty	DC-MGT-IS-SAAS-ES	Infrastructure Services SaaS/CVA - Essentials	Enter Qty to see List Price	Per Device/Month
Qty	DC-MGT-IS-SAAS-AD	Infrastructure Services SaaS/CVA - Advantage	Enter Qty to see List Price	Per Device/Month
Qty	DC-MGT-IS-PVAPP-ES	Infrastructure Services PVA - Essentials	Enter Qty to see List Price	Per Device/Month
Qty	DC-MGT-IS-PVAPP-AD	Infrastructure Services PVA - Advantage	Enter Qty to see List Price	Per Device/Month

Add-Ons

Device	SKU	Description	Unit List Price (USD)	Action
Qty	DC-MGT-IS-UCSD	UCS Director - 1 Server License (includes Network, Storage)	Enter Qty to see List Price	Per Device/Month

a. オファー DC-MGT-SAAS の下の Cisco Intersight 2.0 インフラストラクチャ サービス ライセンスの数量は、選択されたサーバの数量と同じである必要があります。数量を入力します。

ステップ 18.

Cisco Intersight

↓

DC-MGT-SAAS

Offer Configuration: DC-MGT-SAAS(Part of UCSX-M7-XDIRECTXCC) | Estimated Lead Time: NA | Price List: Global Price List (USD) | Total (USD): 0.00

Requested Start Date: 06-Jun-2024 | Requested For: 36 Months From 06-Jun-2024 To 05-Jun-2027 | Automatically Renews For: 12 Months On 06-Jun-2027 | Billing Frequency: Prepaid Term

Please note that Cisco recommends Solution Support with Intersight which solves complex issues on average 44% faster than product support. For complete details, please refer to the following URL: https://www.cisco.com/c/m/en_us/customer-experience/support/solution-support.html (CE202322)

Your subscription will start and be eligible to be invoiced: i) 30 days or less (7 days for A-FLEX/A-FLEX-3/A-WHOLESALE) after Cisco notifies you that any portion of the subscription is ready for you to provision OR, ii) the day any portion of the subscription is provisioned by Cisco, whichever of the two events happens first. (C01007)

Configuration Summary

SKU	Qty	List Price
SVS-DCM-SUPT-BAS	1	\$0.00
		Per Each/Month
Total		\$0.00

DC-MGT-SAAS > Cisco Intersight Support

Each	SKU	Description	Unit List Price (USD)	Action
Qty	SVS-SSTCS-DCMGMT	Solution Support for DC Mgmt	Enter Qty to see List Price	Per Each/Month
Qty	SVS-L1DCS-INTER	CXL1 for INTERSIGHT	Enter Qty to see List Price	Per Each/Month
Qty	SVS-L2DCS-INTER	CXL2 for INTERSIGHT	Enter Qty to see List Price	Per Each/Month
1	SVS-DCM-SUPT-BAS	Basic Support for DCM	\$0.00	Per Each/Month

a. Cisco Intersight License には、個別のサポートが付属しています。基本組み込み型サポートはデフォルトの選択です。お客様が HW の Solution Support または CX Success Track L1 または L2 にアップグレードすることをお勧めします。

ステップ 19.

Bundle Configuration: UCS-M7-XDIRECTXCC | Estimated Lead Time: 35 days | Price List: Global Price List (USD) | Total: 487,351.16

Set service preferences for this configuration | Cancel Done

⚠ Please note that you are using a promotional PID which is available ONLY IF qualified for the 'UCS X-Series X-Direct Xccelerate' Program. For details on the program, PIs review Sales Connect, contact your Cisco Account Manager or reach out to ask-ucsx@external.cisco.com. We encourage you NOT to book this PID if you do not qualify. Order will be on hold after booking to check for eligibility. (CE2023Z2)

Product	Unit List Price (USD)	Adjusted List Price (USD)	Qty	Extended List Price (USD)
UCS 9500 CHASSIS > 1 Selected (Min 1, Max 1)				
UCSX-9508-FREE Valid		5,471.88	1	9,608.46
UCS 9508 Free Chassis				
Add Custom Name Edit Options Edit Services/Subscriptions Remove Line				
UCSX MODULAR SERVER > 6 Selected (Min 6, Max 8)				
UCSX-210C-M7-U Valid		22,003.99	5	466,945.70
UCS X210c M7 Compute Node 2S w/o CPU, Mem, Drv, Mezz				
Add Custom Name Edit Options Edit Services/Subscriptions Remove Line				
UCSX-210C-M7-NEW Valid		3,237.00	1	3,237.00
UCS X210c M7 R2L Free Compute Node 2S w/o CPU, Mem, Drv, Mez				
Add Custom Name Edit Options Edit Services/Subscriptions Remove Line				
Add a UCSX MODULAR SERVER from the left panel				
CISCO INTERSIGHT > 1 Selected (Min 1, Max 1)				
DC-HGT-SAAS Valid		35.00	1	7,560.00
Cisco Intersight SaaS				
Add Custom Name Edit Options Remove Line				

Requested Start Date: 06-Jun-2024 | Requested For: 36 Months From 06-Jun-2024 To 05-Jun-2027 | Automatically Renews For: 12 Months On 06-Jun-2027 | Billing Frequency: Prepaid Term

- 各製品のステータスが [有効 (Valid)] であり、警告メッセージがなくなると MLB の構成が完了します。
- 「PLUS」をクリックして、展開して、各製品に行った選択を表示します。
- MLB 構成を完了するために、[完了 (Done)] をクリックします。

シナリオ 2 : Cisco インターサイト ソフトウェア ライセンスのエンタープライズ契約を締結しているお客様
ステップ 1.

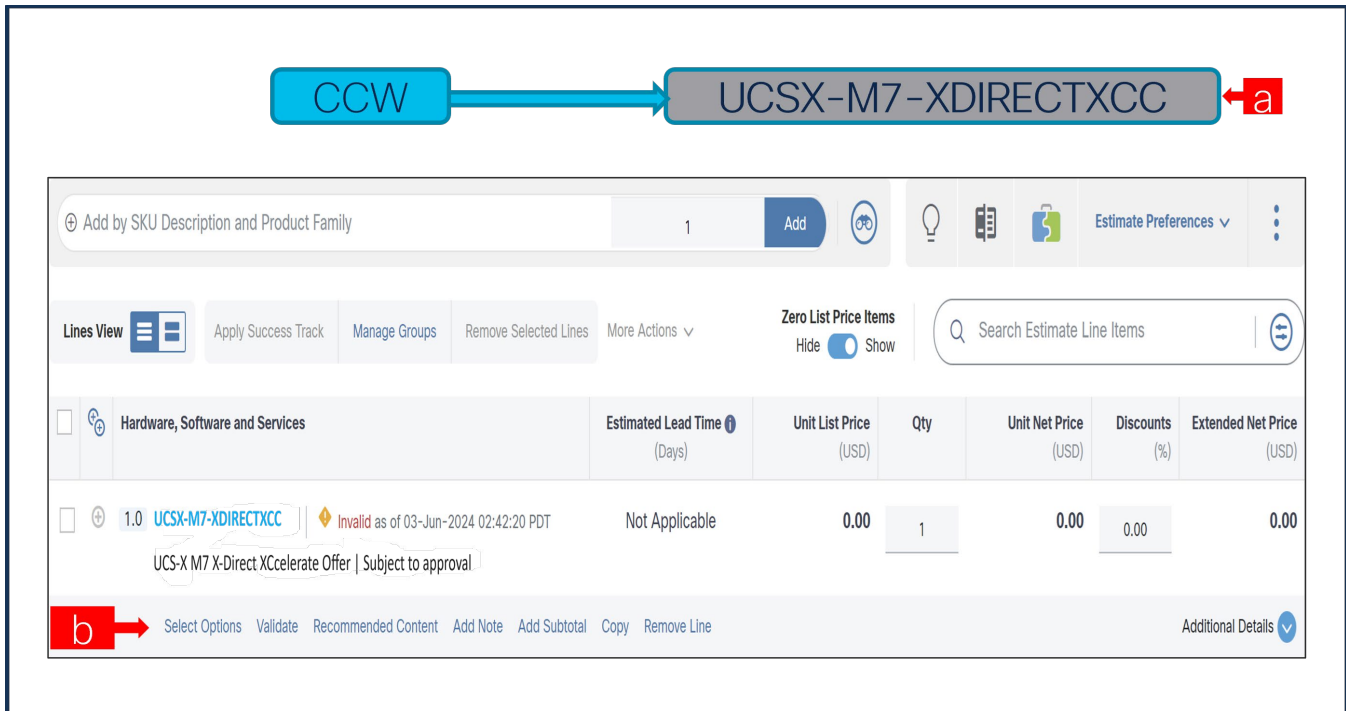

- a. CCW で MLB PID を検索して、[追加 (Add)] をクリックします。
- b. Configurator を入力するために、[オプションの選択 (Select Options)] をクリックします。

ステップ 2.

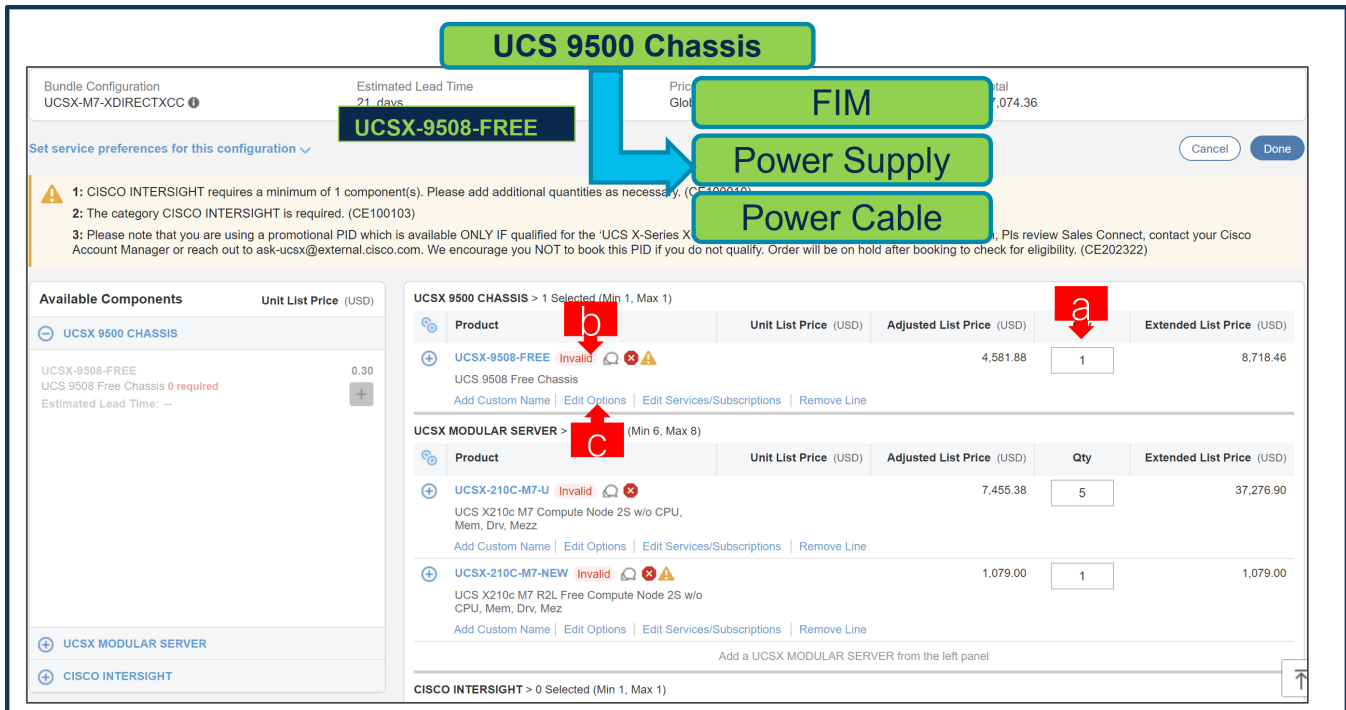

- a. 空きシャーシ : UCSX-9508-FREE は事前に選択されており、数量 1 のみを選択できます
- b. さらに構成が必要なため、UCSX-9508-FREE ATO ステータスが無効であることを通知します。
- c. Configurator を入力するために、[オプションの編集 (Edit Option)] をクリックします。

ステップ 3.

Product Configuration
UCSX-9508-FREE part of UCSX-M7-XDIRECTXCC Estimated Lead Time 21 days Total (USD) 8,273.46

1: The quantity of Power Cable must be equal to the quantity of UCSX-9508-FREE. (CE200050)
2: Please note that this order will be placed on a Compliance Hold. Please reach out to sac-support@cisco.com for more information. Note that the order will remain on compliance hold if you do not reach out to sac-support@cisco.com to request eligibility check. (CE202322)
3: Use Power Calculator to determine the correct power supply. The Power Calculator can be found at <http://ucspowercalc.cisco.com>.
4: UCSX-S9108-SW is defaulted under Software License. (CE100033)

Configuration Summary View Full Summary

Category	Qty	Extended List Price (USD)
Fabric Interconnect Module		
UCSX-S9108-100G	2	0.00
UCSX-S9108-SW	2	8,273.16
Power		
UCSX-PSU-2800AC-D	6	0.00
Accessory		
UCSX-C-DEBUGCBL-D	1	0.00
UCSX SW		
UCSX-CHASSIS-SW-D	1	0.00
Chassis Expansion		
Total		8,273.46
Estimated Lead Time		21 days

Option Search Multiple Options Search

UCSX-9508-FREE Power

Power Cable

SKU	Qty	Estimated Lead Time	Unit List Price (USD)
<input type="radio"/> NO-POWER-CORD ECO friendly green option, no power cable will be shipped More	6	3 days	0.00
<input type="radio"/> CAB-AC-2500W-EU SNP *** Power Cord, 250Vac 16A, Europe	6	8 days	0.00
<input type="radio"/> CAB-AC-2500W-INT Power Cord, 250Vac 16A, INTL	6	8 days	0.00
<input type="radio"/> CAB-C19-CBN Cabinet Jumper Power Cord, 250 VAC 16A, C20-C19 Connectors	6	14 days	0.00
<input type="radio"/> CAB-AC-C6K-TWLK SNP *** Power Cord, 250Vac 16A, twist lock NEMA L6-20 plug, US	6	8 days	0.00

Reset Configuration Cancel Done

- ファブリック インターコネクト モジュールと電源のペアは、構成およびソフトウェア ライセンスに自動的に無料で付属しています。UCSX-S9108-SW が有料で事前に選択されています。
- 左側のカテゴリ ウィンドウから電源ケーブルを選択して、UCSX-9508-FREE を設定します。
- 「完了」をクリックします

ステップ 4.

Bundle Configuration
UCSX-M7-XDIRECTXCC Estimated Lead Time 21 days Price List Global Price List (USD) Total 47,074.36

Set service preferences for this configuration

1: CISCO INTERSIGHT requires a minimum of 1 component(s). Please add additional quantities as necessary. (CE100010)
2: The category CISCO INTERSIGHT is required. (CE100103)
3: Please note that you are using a promotional PID which is available ONLY IF qualified for the 'UCS X-Series X-Direct Xcelerate' Program. For details on the program, PIs review Sales Connect, contact your Cisco Account Manager or reach out to ask-ucsx@external.cisco.com. We encourage you NOT to book this PID if you do not qualify. Order will be on hold after booking to check for eligibility. (CE202322)

Available Components Unit List Price (USD)

Product	Unit List Price (USD)	Adjusted List Price (USD)	Qty	Extended List Price (USD)
UCSX 9500 CHASSIS > 1 Selected (Min 1, Max 1)				
UCSX-9508-FREE Valid UCS 9508 Free Chassis 0 required Estimated Lead Time: --	0.30		1	8,718.46
UCSX MODULAR SERVER > 6 Selected (Min 6, Max 8)				
UCSX-210C-M7-U Invalid UCS X210c M7 Compute Node 2S w/o CPU, Mem, Drv, Mezz	7,455.38		5	37,276.90
UCSX-210C-M7-NEW Invalid UCS X210c M7 R2L Free Compute Node 2S w/o CPU, Mem, Drv, Mezz	1,079.00		1	1,079.00
CISCO INTERSIGHT > 0 Selected (Min 1, Max 1)				

Cancel Done

- a. ステータスには現在、[有効 (Valid)]として表示されています。
- b. [サービス/サブスクリプションの編集 (Edit Services/Subscriptions)]をクリックして、ハードウェアサポートの期間を編集します。

注： ハードウェア サポートの期間は、ソフトウェア サブスクリプション期間と一致させることをお勧めします。

ステップ 5.

UCS 9500 Chassis

Service Subscription UCSX-9508-FREE	Price List Global Price	UCSX-9508-FREE	Ser 1,335	Total (USD)
--	----------------------------	----------------	--------------	-------------

Services/Subscriptions

You may receive additional discounts because you selected two or more years of service. To review your discounts you can go to the Order or Quoting discount pages. (C0124)

The duration that you entered has been successfully applied to all the services. (C0329)

Service Options

Choose Service Level from All Service Programs

Search by Name & Description

Note: Cisco may still install another compatible service if required. Compatible services are the services that come with primary service and are based on products.

Time Duration ⓘ

Duration
 Delay service start to
 Co-Term service to

Duration ⓘ

36

Service SKU	Product SKU	Unit List Price (USD)	Qty	Total List Price (USD)
Cisco Customer Experience Level 1 (1 ITEM) <small>SERVICE PROGRAM</small>	L1NCO (CX LEVEL 1 8X7XNCDOS) <small>SUMMARY</small>		Duration 36 Months	
CON-L1NCO-UCSX9508 <small>CX LEVEL 1 8X7XNCDOS UCS 9508 Free Chassis</small> <small>SERVICE SKU</small>	UCSX-9508-FREE <small>UCS 9508 Free Chassis</small> <small>PRODUCT SKU</small>	1,335.00	1	1,335.00

Configuration Summary ⓘ All prices shown in USD

Services 1,335.00

- a. [期間 (Term Duration)]を入力します。
- b. [適用 (Apply)]をクリックし、[完了 (Done)]をクリックします。

ステップ 6.

UCSX Modular Server

UCSX-210C-M7-U

CPU
Memory
Drives

Bundle Configuration
UCSX-M7-XDIRECTXCC

Estimated Lead Time
21 days

Global Price List (USD)

Set service preferences for this configuration

1: CISCO INTERSIGHT requires a minimum of 1 component(s). Please add additional quantities as necessary. (CE100010)
 2: The category CISCO INTERSIGHT is required. (CE100103)
 3: Please note that you are using a promotional PID which is available ONLY IF qualified for the 'UCS X-Series X-Direct Xccelerate' Program. For details on the program, Pls review Sales Connect, contact your Cisco Account Manager or reach out to ask-ucsx@external.cisco.com. We encourage you NOT to book this PID if you do not qualify. Order will be on hold after booking to check for eligibility. (CE202322)

Available Components	Unit List Price (USD)
UCSX 9500 CHASSIS	
UCSX MODULAR SERVER	
UCSX-210C-M7-U UCS X210c M7 Compute Node 2S w/o CPU, Mem, Drv, Mezz 5 required Estimated Lead Time: 21 days	6,376.38
UCSX-210C-M7-NEW UCS X210c M7 R2L Free Compute Node 2S w/o CPU, Mem, Drv, Mezz 1 required Estimated Lead Time: 21 days	0.00
CISCO INTERSIGHT	

UCSX 9500 CHASSIS > 1 Selected (Min 1, Max 1)				
Product	Unit List Price (USD)	Adjusted List Price (USD)	Qty	Extended List Price (USD)
UCSX-9508-FREE Valid UCS 9508 Free Chassis Add Custom Name Edit Options Edit Services/Subscriptions Remove Line		5,471.88	1	9,608.46
UCSX MODULAR SERVER > 1 Selected (Min 6, Max 8)				
Product	Unit List Price (USD)	Adjusted List Price (USD)	Qty	Extended List Price (USD)
UCSX-210C-M7-U Invalid UCS X210c M7 Compute Node 2S w/o CPU, Mem, Drv, Mezz Add Custom Name Edit Options Edit Services/Subscriptions Remove Line		7,455.38	5	37,276.90
UCSX-210C-M7-NEW UCS X210c M7 R2L Free Compute Node 2S w/o CPU, Mem, Drv, Mezz Add Custom Name Edit Options Edit Services/Subscriptions Remove Line		1,079.00	1	1,079.00

Add a UCSX MODULAR SERVER from the left panel

CISCO INTERSIGHT > 0 Selected (Min 1, Max 1)

- 有料サーバー：UCSX-210C-M7-U は MLB で数量 5 が事前に選択されており、最大数量 7 まで選択できます。
- さらに構成が必要なため、UCSX-210C-M7-U ATO ステータスが「無効」になっていることに注意してください。
- Configurator を入力するために、[オプションの編集 (Edit Option)] をクリックします。

ステップ 7.

UCSX Modular Server

UCSX-210C-M7-U

CPU
Memory
Drives

Product Configuration: UCSX-210C-M7-U part of UCSX-RECTXCC Estimated Lead Time: 21 days Price List: Global Price List in (USD) 38

Warning Messages:

- 1: A selection from Infrastructure and Workload is required. Please adjust the selections. (CE200277)
- 2: A selection of either UCSX-ML-V5Q50G-D or UCSX-ML-V5D200G-D or UCSX-MLV5D200GV2D from Rear MEZZ - MLOM/PCI is required. Please adjust the selections. (CE200096)
- 3: At least 1 selection(s) from Processor 4th Gen or Processor 5th Gen is required. Please make the selection. (CE200375)
- 4: UCSX-210C-M7-U quantity 1 requires a minimum quantity of 1 from Security Options (CE100012)

Configuration Summary

Category	Qty	Extended List Price (USD)
Processor 4th Gen		
Processor 5th Gen		
Memory 4800		
Memory 5600		
Front MEZZ - Controller		
Rear MEZZ - MLOM/PCI		
Storage Drives		
SATA M.2		
NVMe Boot		
Total		6,376.38
Estimated Lead Time		21 days

Options List:

SKU	Qty	Estimated Lead Time	Unit List Price (USD)
<input type="radio"/> UCSX-CPU-I8452Y Intel I8452Y 2GHz/300W 36C/67.5MB DDR5 4800MT/s	Qty	21 days	11,300.22
<input type="radio"/> UCSX-CPU-I8454H Intel I8454H 2.1GHz/270W 32C/82.5MB DDR5 4800MT/s	Qty	21 days	17,571.42
<input type="radio"/> UCSX-CPU-I8458P Intel I8458P 2.7GHz/350W 44C/82.5MB DDR5 4800MT/s	Qty	21 days	18,953.30
<input type="radio"/> UCSX-CPU-I8460H Intel I8460H 2.2GHz/330W 40C/105MB DDR5 4800MT/s	Qty	21 days	27,690.77
<input type="radio"/> UCSX-CPU-I8460Y+ Intel I8460Y+ 2GHz/300W 40C/105MB DDR5 4800MT/s	Qty	21 days	14,783.55

Buttons: Reset Configuration, Cancel, Done

- 左側のカテゴリ ウィンドウから周辺機器を選択して、UCSX--210C-M7-U を構成します。
- PID は右側のウィンドウにリストされます。メモリやストレージ ドライブなどの一部の PID はタイプまたはシリーズに従ってグループ化されます。右側の SKU ウィンドウの上にあるグループ化されたオプションから選択します。
- 警告メッセージに従って、最低限必要なオプション PID を構成します。
- 完了したら [完了 (Done)] をクリックします。

ステップ 8.

UCSX Modular Server

UCSX-210C-M7-U

CPU

Memory

Drives

Available Components

Product	Unit List Price (USD)	Adjusted List Price (USD)	Qty	Extended List Price (USD)
UCSX-9508-FREE Valid		5,471.88	1	9,608.46
UCSX-210C-M7-U Valid		19,845.99	5	456,155.70
UCSX-210C-M7-NEW Invalid	1,079.00		1	1,079.00

- ステータスには現在、[有効 (Valid)]として表示されています。
 - 同じ構成の倍数の数量を増やします。
 - 「PLUS」をクリックして、異なるオプション/数量の同じ製品を追加するか、異なる製品を選択します。
- ステップ 9.

UCSX Modular Server

UCSX-210C-M7-U

Services/Subscriptions

Available Components

Product	Unit List Price (USD)	Adjusted List Price (USD)	Qty	Extended List Price (USD)
UCSX-9508-FREE Valid		5,471.88	1	9,608.46
UCSX-210C-M7-U Valid		19,845.99	5	456,155.70
UCSX-210C-M7-NEW Invalid	1,079.00		1	1,079.00

- [サービス/サブスクリプションの編集 (Edit Services/Subscriptions)]をクリックして、ハードウェアサポートの期間を編集します。

注： ハードウェア サポートの期間は、ソフトウェア サブスクリプション期間と一致させることをお勧めします。

ステップ 10.

UCSX Modular Server

UCSX-210C-M7-U

Services/Subscriptions

Service Subscription
UCSX-210C-M7-U

Price List
Global Price List in US Dollars (USD)

3,237.00

You may receive additional discounts because you selected two or more years of service. To review your discounts you can go to the Order or Quoting discount pages. (C0124)

Service Non Serviceable Products

The duration that you entered has been successfully applied to all the services. (C0329)

Service Options

Choose Service Level from All Service Programs

Search by Name & Description

Note: Cisco may still install another compatible service if required. Compatible services are the services that come with primary service and are based on products.

Time Duration

Duration 36

Duration

Delay service start to

Co-Term service to

Reset Apply

Service SKU	Product SKU	Unit List Price (USD)	Qty	Total List Price (USD)
Cisco Customer Experience Level 1 (1 ITEM) SERVICE PROGRAM	L1NCO (CX LEVEL 1 8X7XNCDOS) SUMMARY			
CON-L1NCO-UCSX023C CX LEVEL 1 8X7XNCDOS UCS X210c M7 Compute N... SERVICE SKU	UCSX-210C-M7-U UCS X210c M7 Compute Node 2S w/o CPU, Mem, Drv... PRODUCT SKU	3,237.00	1	3,237.00

Remove All Services Remove All Additional Services

Configuration Summary All prices shown in USD

Services 3,237.00

Cancel Done

- [期間 (Term Duration)] を入力します。
- [適用 (Apply)] をクリックし、[完了 (Done)] をクリックします。

ステップ 11.

UCSX Modular Server

UCSX-210C-M7-NEW

CPU
Memory
Drives

Bundle Configuration: UCSX-M7-XDIRECTXCC
Estimated Lead Time: 35 days

Set service preferences for this configuration

⚠️ 1: CISCO INTERSIGHT requires a minimum of 1 component(s). Please add additional quantities as necessary. (CE100010)
 2: The category CISCO INTERSIGHT is required. (CE100103)
 3: Please note that you are using a promotional PID which is available ONLY IF qualified for the 'UCSX X-Series X-Direct Xccelerate' Program. For details on the program, Pls review Sales Connect, contact your Cisco Account Manager or reach out to ask-ucsx@external.cisco.com. We encourage you NOT to book this PID if you do not qualify. Order will be on hold after booking to check for eligibility. (CE202322)

Available Components	Unit List Price (USD)
UCSX 9500 CHASSIS	
UCSX MODULAR SERVER	
UCSX-210C-M7-U UCS X210c M7 Compute Node 2S w/o CPU, Mem, Drv, Mezz 5 required Estimated Lead Time: 21 days	6,376.38
UCSX-210C-M7-NEW UCS X210c M7 R2L Free Compute Node 2S w/o CPU, Mem, Drv, Mezz 1 required Estimated Lead Time: 21 days	0.00
CISCO INTERSIGHT	

UCSX 9500 CHASSIS > 1 Selected (Min 1, Max 1)	Unit List Price (USD)	Adjusted List Price (USD)	Qty	Extended List Price (USD)
UCSX-9508-FREE Valid UCS 9508 Free Chassis		5,471.88	1	9,608.46

UCSX MODULAR SERVER > 6 Selected (Min 6, Max 6)	Unit List Price (USD)	Adjusted List Price (USD)	Qty	Extended List Price (USD)
UCSX-210C-M7-U Valid UCS X210c M7 Compute Node 2S w/o CPU, Mem, Drv, Mezz		22,003.99	5	466,945.70
UCSX-210C-M7-NEW Invalid UCS X210c M7 R2L Free Compute Node 2S w/o CPU, Mem, Drv, Mezz		1,079.00	1	1,079.00

CISCO INTERSIGHT > 0 Selected (Min 1, Max 1)

- 空きサーバー : UCSX-210C-M7-NEW は事前に選択されており、数量 1 のみを選択できます。
- さらに構成が必要なため、UCSX-210C-M7 -NEW ATO ステータスが「無効」になっていることに注意してください。
- Configurator を入力するために、[オプションの編集 (Edit Option)] をクリックします。

注： 少なくとも 5 つの有料サーバーと 1 つの無料サーバーの構成は同じである必要があります。

ステップ 12.

UCSX Modular Server

UCSX-210C-M7-NEW

CPU
Memory
Drives

Product Configuration: UCSX-210C-M7-NEW part of UCSX-M7-XDIRECTXCC
Estimated Lead Time: 21 days
Price List: Global Price List in US Dollars (USD)
Unit List Price: 0.00

Warning Messages:

- 1: A selection from Infrastructure and Workload is required. Please adjust the selections. (CE200277)
- 2: A selection of either UCSX-ML-V5Q50G-D or UCSX-ML-V5D200G-D or UCSX-MLV5D200GV2D from Rear MEZZ - MLOM/PCI is required. Please make the selection. (CE200375)
- 3: At least 1 selection(s) from Processor 4th Gen or Processor 5th Gen is required. Please make the selection. (CE200375)
- 4: Please note that this order will be placed on a Compliance Hold. Please reach out to sac-support@cisco.com to check if this order meets eligibility criteria for hold removal. Note that the order will remain on compliance hold if you do not reach out to sac-support@cisco.com to request eligibility check. (CE202322)

Configuration Summary

Category	Qty	Extended List Price (USD)
Processor 4th Gen		
Processor 5th Gen		
Memory 4800		
Memory 5600		
Front MEZZ - Controller		
Rear MEZZ - MLOM/PCI		
Storage Drives		
SATA M.2		
NVMe Boot		
Total		0.00
Estimated Lead Time		21 days

Option Search | **Multiple Options Search**

UCSX-210C-M7-NEW > Processor 4th Gen

8000 Processor Series 4th Gen | 6000 Processor Series 4th Gen | 5000 Processor Series 4th Gen | 4000 Processor Series 4th Gen | 3000 Processor Series 4th Gen

SKU	Qty	Estimated Lead Time	Unit List Price (USD)
<input type="radio"/> UCSX-CPU-I8452Y Intel I8452Y 2GHz/300W 36C/67.5MB DDR5 4800MT/s	Qty	21 days	0.00
<input type="radio"/> UCSX-CPU-I8454H Intel I8454H 2.1GHz/270W 32C/82.5MB DDR5 4800MT/s	Qty	21 days	0.00
<input type="radio"/> UCSX-CPU-I8458P Intel I8458P 2.7GHz/350W 44C/82.5MB DDR5 4800MT/s	Qty	21 days	0.00
<input type="radio"/> UCSX-CPU-I8460H Intel I8460H 2.2GHz/330W 40C/105MB DDR5 4800MT/s	Qty	21 days	0.00
<input type="radio"/> UCSX-CPU-I8460Y+ Intel I8460Y+ 2GHz/300W 40C/105MB DDR5 4800MT/s	Qty	21 days	0.00

Buttons: Reset Configuration, Cancel, Done

- 左側のカテゴリ ウィンドウから周辺機器を選択して、UCSX-210C-M7-NEW を構成します。
- PID は右側のウィンドウにリストされます。メモリやストレージ ドライブなどの一部の PID はタイプまたはシリーズに従ってグループ化されます。右側の SKU ウィンドウの上にあるグループ化されたオプションから選択します。
- 警告メッセージに従って、最低限必要なオプション PID を構成します。
- 完了したら [完了 (Done)] をクリックします。

ステップ 13.

UCSX Modular Server

UCSX-210C-M7-NEW

➔

Services/Subscriptions

Bundle Configuration UCSX-M7-XDIRECTXCC	Estimated Lead Time 35 days	Price List Global Price List (USD)	Total 477,633.16
--	--------------------------------	---------------------------------------	---------------------

Set service preferences for this configuration Cancel Done

⚠ 1: CISCO INTERSIGHT requires a minimum of 1 component(s). Please add additional quantities as necessary. (CE100010)

2: The category CISCO INTERSIGHT is required. (CE100103)

3: Please note that you are using a promotional PID which is available ONLY IF qualified for the 'UCS X-Series X-Direct Xcelerate' Program. For details on the program, PIs review Sales Connect, contact your Cisco Account Manager or reach out to ask-ucsx@external.cisco.com. We encourage you NOT to book this PID if you do not qualify. Order will be on hold after booking to check for eligibility. (CE202322)

Available Components	Unit List Price (USD)	UCSX 9500 CHASSIS > 1 Selected (Min 1, Max 1)	Unit List Price (USD)	Adjusted List Price (USD)	Qty	Extended List Price (USD)
UCSX 9500 CHASSIS		UCSX-9508-FREE Valid ⚠		5,471.88	1	9,608.46
UCSX MODULAR SERVER		UCSX-210C-M7-U				
UCSX-210C-M7-U UCS X210c M7 Compute Node 2S w/o CPU, Mem, Drv, Mezz 5 required Estimated Lead Time: 21 days	6,376.38	UCSX-210C-M7-U Valid		22,003.99	5	466,945.70
UCSX-210C-M7-NEW UCS X210c M7 R2L Free Compute Node 2S w/o CPU, Mem, Drv, Mezz 1 required Estimated Lead Time: 21 days	0.00	UCSX-210C-M7-NEW Valid ⚠		1,079.00	1	1,079.00
CISCO INTERSIGHT		CISCO INTERSIGHT > 0 Selected (Min 1, Max 1)				

- a. ステータスには現在、[有効 (Valid)] として表示されています。
- b. [サービス/サブスクリプションの編集 (Edit Services/Subscriptions)] をクリックして、ハードウェア サポートの期間を編集します。

注： ハードウェア サポートの期間は、ソフトウェア サブスクリプション期間と一致させることをお勧めします。

ステップ 14.

UCSX Modular Server

Price List Global Price List **UCSX-210C-M7-NEW** Service Total 37.00

Services/Subscriptions

You may receive additional discounts because you selected two or more years of service. To review your discounts you can go to the Order or Quoting discount pages. (C0124)

Service Non Serviceable Products

The duration that you entered has been successfully applied to all the services. (C0329)

Service Options

Choose Service Level from All Service Programs

Search by Name & Description

Note: Cisco may still install another compatible service if required. Compatible services are the services that come with primary service and are based on products.

Time Duration

Duration 36

Delay service start to

Co-Term service to

Reset Apply

Service SKU	Product SKU	Unit List Price (USD)	Qty	Total List Price (USD)
Cisco Customer Experience Level 1 (1 ITEM) SERVICE PROGRAM	L1NCO (CX LEVEL 1 8X7XNCDOS) SUMMARY		36 Months	
CON-L1NCO-UCSX221C CX LEVEL 1 8X7XNCDOS UCS X210c M7 Compute N...	UCSX-210C-M7-NEW UCS X210c M7 R2L Free Compute Node 2S w/o CPU, ...	3,237.00	1	3,237.00

Remove All Services Remove All Additional Services

Configuration Summary All prices shown in USD

Services 3,237.00

Cancel Done

- [期間 (Term Duration)] を入力します。
- [適用 (Apply)] をクリックし、[完了 (Done)] をクリックします。

ステップ 15.

Cisco Intersight

Price List Global Price List (USD) Total 479,791.16

CNDL-DESELECT-D

Get service preferences for this configuration

1: Please note that Intersight is required selection and needed for the M7 Server to function. All orders with CNDL-DESELECT-D will be manually reviewed for Compliance. (CE202322)

2: Please note that you are using a promotional PID which is available ONLY IF qualified for the 'UCS X-Series X-Direct Xcelerate' Program. For details on the program, Pls review Sales Connect, contact your Cisco Account Manager or reach out to ask-ucsx@external.cisco.com. We encourage you NOT to book this PID if you do not qualify. Order will be on hold after booking to check for eligibility. (CE202322)

CNDL-DESELECT-D has been added to the bundle category CISCO INTERSIGHT.

Available Components	Unit List Price (USD)
UCSX 9500 CHASSIS	
UCSX MODULAR SERVER	
CISCO INTERSIGHT	
DC-MGT-SAAS Cisco Intersight SaaS	0.00
CNDL-DESELECT-D Conditional Deselect Estimated Lead Time: 7 days	

UCSX 9500 CHASSIS > 1 Selected (Min 1, Max 1)

Product	Unit List Price (USD)	Adjusted List Price (USD)	Qty	Extended List Price (USD)
UCSX-9508-FREE Valid UCS 9508 Free Chassis		5,471.88	1	9,608.46

UCSX MODULAR SERVER > 6 Selected (Min 6, Max 8)

Product	Unit List Price (USD)	Adjusted List Price (USD)	Qty	Extended List Price (USD)
UCSX-210C-M7-U Valid UCS X210c M7 Compute Node 2S w/o CPU, Mem, Drv, Mezz	22,003.99		5	466,945.70
UCSX-210C-M7-NEW Valid UCS X210c M7 R2L Free Compute Node 2S w/o CPU, Mem, Drv, Mez	3,237.00		1	3,237.00

CISCO INTERSIGHT > 1 Selected (Min 1, Max 1)

Product	Unit List Price (USD)	Adjusted List Price (USD)	Qty	Extended List Price (USD)
CNDL-DESELECT-D Inv Conditional Deselect		0.00	1	0.00

- CNDL-DESELECT-D** は、お客様が EA 契約を介して Cisco Intersight ライセンスをすでに購入している場合、または注文が Disti Fulfillment である場合にのみ選択することを意図しています。

ステップ 16.

Product Configuration: CNDL-DESELECT-D (part of UCSX-M7-XDIRECTXCC)

Estimated Lead Time: 7 days

Price List: Global Price List in US Dollars (USD) 0.00

Configuration Summary

Category	Qty	Extended List Price (USD)
Reason Codes		
OPTOUT-EA-ONLY	1	0.00

CNDL-DESELECT-D > Reason Codes

SKU	Qty	Estimated Lead Time	Unit List Price (USD)
<input type="radio"/> OPTOUT-DISTI-ONLY For Distl when ordering mandatory licenses separately	1	3 days	0.00
<input checked="" type="radio"/> OPTOUT-EA-ONLY License not needed: Customer already owns Licenses in an EA	1	3 days	0.00
<input type="radio"/> OPTOUT-ENTL-SWAP License not needed: Entitlements updated in Smart Account. More	1	3 days	0.00

Clear Selection | Show Incompatible SKUs

Total: 0.00
Estimated Lead Time: 7 days

Buttons: Reset Configuration, Cancel, Done

a. 適切な [理由コード (Reason Code)] を選択してください。

ステップ 17.

Bundle Configuration: UCSX-M7-XDIRECTXCC

Estimated Lead Time: 35 days

Price List: Global Price List (USD)

Total: 479,791.16

Get service preferences for this configuration

Warning 1: Please note that Intersight is required selection and needed for the M7 Server to function. All orders with CNDL-DESELECT-D will be manually reviewed for Compliance. (CE202322)

Warning 2: Please note that you are using a promotional PID which is available ONLY IF qualified for the 'UCS X-Series X-Direct Xcelerate' Program. For details on the program, pls review Sales Connect, contact your Cisco Account Manager or reach out to ask-ucsx@external.cisco.com. We encourage you NOT to book this PID if you do not qualify. Order will be on hold after booking to check for eligibility. (CE202322)

Available Components

Component	Unit List Price (USD)
UCSX 9500 CHASSIS	0.30
UCSX 9508-FREE	0.30
UCSX 9508 Free Chassis 0 required	
Estimated Lead Time: --	
UCSX MODULAR SERVER	
CISCO INTERSIGHT	

UCSX 9500 CHASSIS > 1 Selected (Min 1, Max 1)

Product	Unit List Price (USD)	Adjusted List Price (USD)	Qty	Extended List Price (USD)
UCSX-9508-FREE Valid UCS 9508 Free Chassis	5,471.88		1	9,608.46

UCSX MODULAR SERVER > 6 Selected (Min 6, Max 8)

Product	Unit List Price (USD)	Adjusted List Price (USD)	Qty	Extended List Price (USD)
UCSX-210C-M7-U Valid UCS X210c M7 Compute Node 2S w/o CPU, Mem, Drv, Mezz	22,003.99		5	466,945.70
UCSX-210C-M7-NEW Valid UCS X210c M7 R2L Free Compute Node 2S w/o CPU, Mem, Drv, Mezz	3,237.00		1	3,237.00

Add a UCSX MODULAR SERVER from the left panel

CISCO INTERSIGHT > 1 Selected (Min 1, Max 1)

Product	Unit List Price (USD)	Adjusted List Price (USD)	Qty	Extended List Price (USD)
CNDL-DESELECT-D Valid Conditional Deselect	0.00		1	0.00

Buttons: Cancel, Done

- 各製品のステータスが [有効 (Valid)] であり、警告メッセージがなくなると MLB の構成が完了します。
- 「PLUS」をクリックして、展開して、各製品に行った選択を表示します。
- MLB 構成を完了するために、[完了 (Done)] をクリックします。

ディストリビュータを通じた購入方法（例：直接取引のお客様および第1階層パートナー）

シナリオ 1：Cisco インターサイト ソフトウェア ライセンスのエンタープライズ契約がないお客様
ステップ 1.

The screenshot shows a configuration interface with a search bar containing 'Add by SKU Description and Product Family'. Below the search bar, there are buttons for 'Apply Success Track', 'Manage Groups', 'Remove Selected Lines', and 'More Actions'. A 'Zero List Price Items' section is visible with 'Hide' and 'Show' options. The main table lists items with columns for 'Hardware, Software and Services', 'Estimated Lead Time (Days)', 'Unit List Price (USD)', 'Qty', 'Unit Net Price (USD)', 'Discounts (%)', and 'Extended Net Price (USD)'. One item is listed: '1.0 UCSX-M7-XDIRECTXCC' with a status of 'Invalid as of 03-Jun-2024 02:42:20 PDT'. Below the table, there are buttons for 'Select Options', 'Validate', 'Recommended Content', 'Add Note', 'Add Subtotal', 'Copy', and 'Remove Line'. A red arrow 'b' points to the 'Select Options' button.

- CCW で MLB PID を検索して、[追加 (Add)] をクリックします。
- Configurator を入力するために、[オプションの選択 (Select Options)] をクリックします。

ステップ 2.

The screenshot shows a configuration interface for a 'UCS 9500 Chassis'. A green box labeled 'UCS 9500 Chassis' has a blue arrow pointing to a table of components. The table has columns for 'Product', 'Unit List Price (USD)', 'Adjusted List Price (USD)', 'Qty', and 'Extended List Price (USD)'. Two items are listed: 'UCSX-9508-FREE' with a quantity of 1 and 'UCSX-210C-M7-NEW' with a quantity of 1. A red arrow 'a' points to the quantity '1' for 'UCSX-9508-FREE', and a red arrow 'b' points to the 'Edit Options' button for the same item. Another red arrow 'c' points to the 'Edit Options' button for 'UCSX-210C-M7-NEW'. A green box labeled 'FIM' is above the table, and another green box labeled 'Power Supply' is below it. A green box labeled 'Power Cable' is below that. A red arrow 'a' also points to the 'Qty' column header.

- 空きシャーシ : UCSX-9508-FREE は事前に選択されており、数量 1 のみを選択できます
- さらに構成が必要なため、UCSX-9508-FREE ATO ステータスが無効であることを通知します。
- Configurator を入力するために、[オプションの編集 (Edit Option)] をクリックします。

ステップ 3.

The screenshot shows the Cisco UCS Configurator interface. At the top, it displays 'Product Configuration' for 'UCSX-9508-FREE' with an estimated lead time of 21 days and a total price of 8,273.46 USD. A warning message is visible: '1: The quantity of Power Cable must be equal to the quantity of UCSX-9508-FREE...'. Below this is a 'Configuration Summary' table with columns for Category, Qty, and Extended List Price (USD). The 'Power' category is selected, showing 6 units of 'UCSX-PSU-2800AC-D' for 0.00 USD. To the right, a list of 'Power Cable' options is shown, including 'NO-POWER-CORD', 'CAB-AC-2500W-EU', 'CAB-AC-2500W-INT', 'CAB-C19-CBN', and 'CAB-AC-C6K-TWLK'. A red callout 'a' points to the 'Power' category in the summary, 'b' points to the 'UCSX-9508-FREE' option in the list, and 'c' points to the 'Done' button at the bottom. Green callouts 'UCS 9500 Chassis', 'UCSX-9508-FREE', 'FIM', 'Power Supply', and 'Power Cable' are also present.

- ファブリック インターコネクト モジュールと電源のペアは、構成およびソフトウェア ライセンスに自動的に無料で付属しています。UCSX-S9108-SW が有料で事前に選択されています。
- 左側のカテゴリ ウィンドウから電源ケーブルを選択して、UCSX-9508-FREE を設定します。
- 「完了」をクリックします

ステップ 4.

UCS 9500 Chassis

UCSX-9508-FREE → **Services/Subscriptions**

Bundle Configuration: UCSX-M7-XDIRECTXCC | Estimated Lead Time: 21 days | Price List: Global Price List (USD) | Total: 47,074.36

Set service preferences for this configuration [Cancel] [Done]

1: CISCO INTERSIGHT requires a minimum of 1 component(s). Please add additional quantities as necessary. (CE100010)
2: The category CISCO INTERSIGHT is required. (CE100103)
3: Please note that you are using a promotional PID which is available ONLY IF qualified for the 'UCS X-Series X-Direct Xcelerate' Program. For details on the program, PIs review Sales Connect, contact your Cisco Account Manager or reach out to ask-ucsx@external.cisco.com. We encourage you NOT to book this PID if you do not qualify. Order will be on hold after booking to check for eligibility. (CE202322)

Available Components	Unit List Price (USD)
UCSX 9500 CHASSIS	
UCSX-9508-FREE UCS 9508 Free Chassis 0 required Estimated Lead Time: --	0.30
UCSX MODULAR SERVER	
CISCO INTERSIGHT	

UCSX 9500 CHASSIS > 1 Selected (Min 1, Max 1)				
Product	Unit List Price (USD)	Adjusted List Price (USD)	Qty	Extended List Price (USD)
UCSX-9508-FREE Valid [a]		4,581.88	1	8,718.46
UCS 9508 Free Chassis				
Add Custom Name Edit Options Edit Services/Subscriptions Remove Line				
UCSX MODULAR SERVER > 6 Selected (Min 6, Max 8)				
Product	Unit List Price (USD)	Adjusted List Price (USD)	Qty	Extended List Price (USD)
UCSX-210C-M7-U Invalid [b]		7,455.38	5	37,276.90
UCS X210c M7 Compute Node 2S w/o CPU, Mem, Drv, Mezz				
Add Custom Name Edit Options Edit Services/Subscriptions Remove Line				
UCSX-210C-M7-NEW Invalid [b]		1,079.00	1	1,079.00
UCS X210c M7 R2L Free Compute Node 2S w/o CPU, Mem, Drv, Mezz				
Add Custom Name Edit Options Edit Services/Subscriptions Remove Line				
Add a UCSX MODULAR SERVER from the left panel				
CISCO INTERSIGHT > 0 Selected (Min 1, Max 1)				

- a. ステータスには現在、[有効 (Valid)] として表示されています。
- b. [サービス/サブスクリプションの編集 (Edit Services/Subscriptions)] をクリックして、ハードウェア サポートの期間を編集します。

注： ハードウェア サポートの期間は、ソフトウェア サブスクリプション期間と一致させることをお勧めします。

ステップ 5.

UCS 9500 Chassis

UCSX-9508-FREE → **Services/Subscriptions**

Service Subscription: UCSX-9508-FREE | Price List: Global Price | Set Sub: 1.8 | Total (USD):

You may receive additional discounts because you selected two or more years of service. To review your discounts you can go to the Order or Quoting discount pages. (C0124)

Service: Non Servicable Products

The duration that you entered has been successfully applied to all the services. (C0329)

Service Options

Choose Service Level from: All Service Programs

Search by Name & Description

Note: Cisco may still install another compatible service if required. Compatible services are the services that come with primary service and are based on products.

Time Duration: [a] Duration: 36 [b]

Duration
 Delay service start to
 Co-Term service to

[Reset] [Apply]

Service SKU	Product SKU	Unit List Price (USD)	Qty	Total List Price (USD)
Cisco Customer Experience Level 1 (1 ITEM)	L1NCO (CX LEVEL 1 8X7XNCDOS)			
CON-L1NCO-UCSX9508		1,335.00	1	1,335.00
CX LEVEL 1 8X7XNCDOS UCS 9508 Free Chassis	UCSX-9508-FREE		1	
	UCS 9508 Free Chassis			

[Remove All Services] [Remove All Additional Services]

Configuration Summary: All prices shown in USD
Services: 1,335.00

[Cancel] [Done] [b]

- a. [期間 (Term Duration)]を入力します。
- b. [適用 (Apply)]をクリックし、[完了 (Done)]をクリックします。

ステップ 6.

- a. 有料サーバー : UCSX-210C-M7-U は MLB で 5 数量が事前に選択されており、最大 7 数量まで選択できます。
- b. さらに構成が必要なため、UCSX-210C-M7-U ATO ステータスが「無効」になっていることに注意してください。
- c. Configurator を入力するために、[オプションの編集 (Edit Option)] をクリックします。

ステップ 7.

UCSX Modular Server

UCSX-210C-M7-U

CPU
Memory
Drives

Product Configuration: UCSX-210C-M7-U part of UCSX-RECTXCC Estimated Lead Time: 21 days Price List: Global Price List in (USD) 38

Warning Messages:

- 1: A selection from Infrastructure and Workload is required. Please adjust the selections. (CE200277)
- 2: A selection of either UCSX-ML-V5Q50G-D or UCSX-ML-V5D200G-D or UCSX-MLV5D200GV2D from Rear MEZZ - MLOM/PCI is required. Please adjust the selections. (CE200096)
- 3: At least 1 selection(s) from Processor 4th Gen or Processor 5th Gen is required. Please make the selection. (CE200375)
- 4: UCSX-210C-M7-U quantity 1 requires a minimum quantity of 1 from Security Options (CE100012)

Configuration Summary

Category	Qty	Extended List Price (USD)
Processor 4th Gen		
Processor 5th Gen		
Memory 4800		
Memory 5600		
Front MEZZ - Controller		
Rear MEZZ - MLOM/PCI		
Storage Drives		
SATA M.2		
NVMe Boot		
Total		6,376.38
Estimated Lead Time		21 days

Options List:

SKU	Qty	Estimated Lead Time	Unit List Price (USD)
<input type="radio"/> UCSX-CPU-I8452Y Intel I8452Y 2GHz/300W 36C/67.5MB DDR5 4800MT/s	Qty	21 days	11,300.22
<input type="radio"/> UCSX-CPU-I8454H Intel I8454H 2.1GHz/270W 32C/82.5MB DDR5 4800MT/s	Qty	21 days	17,571.42
<input type="radio"/> UCSX-CPU-I8458P Intel I8458P 2.7GHz/350W 44C/82.5MB DDR5 4800MT/s	Qty	21 days	18,953.30
<input type="radio"/> UCSX-CPU-I8460H Intel I8460H 2.2GHz/330W 40C/105MB DDR5 4800MT/s	Qty	21 days	27,690.77
<input type="radio"/> UCSX-CPU-I8460Y+ Intel I8460Y+ 2GHz/300W 40C/105MB DDR5 4800MT/s	Qty	21 days	14,783.55

Buttons: Reset Configuration, Cancel, Done

- 左側のカテゴリ ウィンドウから周辺機器を選択して、UCSX--210C-M7-U を構成します。
- PID は右側のウィンドウにリストされます。メモリやストレージ ドライブなどの一部の PID はタイプまたはシリーズに従ってグループ化されます。右側の SKU ウィンドウの上にあるグループ化されたオプションから選択します。
- 警告メッセージに従って、最低限必要なオプション PID を構成します。
- 完了したら [完了 (Done)] をクリックします。

ステップ 8.

UCSX Modular Server

CPU
Memory
Drives

Bundle Configuration: UCSX-M7-XDIRECTXCC | Estimated Lead Time: 35 days | Price: Global Price List (USD)

UCSX-210C-M7-U

Set service preferences for this configuration

1: CISCO INTERSIGHT requires a minimum of 1 component(s). Please add additional quantities as necessary. (CE100010)
 2: The category CISCO INTERSIGHT is required. (CE100103)
 3: Please note that you are using a promotional PID which is available ONLY IF qualified for the 'UCS X-Series X-Direct Xcelerate' Program. For details on the program, Pls review Sales Connect, contact your Cisco Account Manager or reach out to ask-ucsx@external.cisco.com. We encourage you NOT to book this PID if you do not qualify. Order will be on hold after booking to check for eligibility. (CE202322)

Available Components	Unit List Price (USD)
UCSX 9500 CHASSIS	
UCSX MODULAR SERVER	
UCSX-210C-M7-U UCS X210c M7 Compute Node 2S w/o CPU, Mem, Drv, Mezz 5 required Estimated Lead Time: 21 days	6,376.38
UCSX-210C-M7-NEW UCS X210c M7 R2L Free Compute Node 2S w/o CPU, Mem, Drv, Mezz 1 required Estimated Lead Time: 21 days	0.00
CISCO INTERSIGHT	

UCSX 9500 CHASSIS > 1 Selected (Min 1, Max 1)				
Product	Unit List Price (USD)	Adjusted List Price (USD)	Qty	Extended List Price (USD)
UCSX-9508-FREE Valid UCS 9508 Free Chassis		5,471.88	1	9,608.46

UCSX MODULAR SERVER > 6 Selected (Min 6, Max 8)				
Product	Unit List Price (USD)	Adjusted List Price (USD)	Qty	Extended List Price (USD)
UCSX-210C-M7-U Valid UCS X210c M7 Compute Node 2S w/o CPU, Mem, Drv, Mezz		19,845.99	5	456,155.70
UCSX-210C-M7-NEW Invalid UCS X210c M7 R2L Free Compute Node 2S w/o CPU, Mem, Drv, Mezz		1,079.00	1	1,079.00

CISCO INTERSIGHT > 0 Selected (Min 1, Max 1)

- ステータスには現在、[有効 (Valid)]として表示されています。
 - 同じ構成の倍数の数量を増やします。
 - 「PLUS」をクリックして、異なるオプション/数量の同じ製品を追加するか、異なる製品を選択します。
- ステップ 9.

UCSX Modular Server

Services/Subscriptions

Bundle Configuration: UCSX-M7-XDIRECTXCC | Estimated Lead Time: 35 days | Price: Global Price List (USD)

UCSX-210C-M7-U

Set service preferences for this configuration

1: CISCO INTERSIGHT requires a minimum of 1 component(s). Please add additional quantities as necessary. (CE100010)
 2: The category CISCO INTERSIGHT is required. (CE100103)
 3: Please note that you are using a promotional PID which is available ONLY IF qualified for the 'UCS X-Series X-Direct Xcelerate' Program. For details on the program, Pls review Sales Connect, contact your Cisco Account Manager or reach out to ask-ucsx@external.cisco.com. We encourage you NOT to book this PID if you do not qualify. Order will be on hold after booking to check for eligibility. (CE202322)

Available Components	Unit List Price (USD)
UCSX 9500 CHASSIS	
UCSX MODULAR SERVER	
UCSX-210C-M7-U UCS X210c M7 Compute Node 2S w/o CPU, Mem, Drv, Mezz 5 required Estimated Lead Time: 21 days	6,376.38
UCSX-210C-M7-NEW UCS X210c M7 R2L Free Compute Node 2S w/o CPU, Mem, Drv, Mezz 1 required Estimated Lead Time: 21 days	0.00
CISCO INTERSIGHT	

UCSX 9500 CHASSIS > 1 Selected (Min 1, Max 1)				
Product	Unit List Price (USD)	Adjusted List Price (USD)	Qty	Extended List Price (USD)
UCSX-9508-FREE Valid UCS 9508 Free Chassis		5,471.88	1	9,608.46

UCSX MODULAR SERVER > 6 Selected (Min 6, Max 8)				
Product	Unit List Price (USD)	Adjusted List Price (USD)	Qty	Extended List Price (USD)
UCSX-210C-M7-U Valid UCS X210c M7 Compute Node 2S w/o CPU, Mem, Drv, Mezz		19,845.99	5	456,155.70
UCSX-210C-M7-NEW Invalid UCS X210c M7 R2L Free Compute Node 2S w/o CPU, Mem, Drv, Mezz		1,079.00	1	1,079.00

CISCO INTERSIGHT > 0 Selected (Min 1, Max 1)

- [サービス/サブスクリプションの編集 (Edit Services/Subscriptions)] をクリックして、ハードウェアサポートの期間を編集します。

注： ハードウェア サポートの期間は、ソフトウェア サブスクリプション期間と一致させることをお勧めします。

ステップ 10.

The screenshot shows the configuration page for the service **UCSX-210C-M7-U**. The price is listed as 3,237.00 USD. A message indicates that the duration has been successfully applied. In the **Service Options** section, the **Time Duration** is set to 36 months. The **Apply** button is highlighted with a red arrow labeled 'b'. Below the options, a table lists the service and product SKUs with their respective prices and quantities. The **Done** button at the bottom right is also highlighted with a red arrow labeled 'b'.

Service SKU	Product SKU	Unit List Price (USD)	Qty	Total List Price (USD)
Cisco Customer Experience Level 1 (1 ITEM) SERVICE PROGRAM	L1NCO (CX LEVEL 1 8X7XNCDOS) SUMMARY			
CON-L1NCO-UCSX023C CX LEVEL 1 8X7XNCDOS UCS X210c M7 Compute N... SERVICE SKU	UCSX-210C-M7-U UCS X210c M7 Compute Node 2S w/o CPU, Mem, Drv... PRODUCT SKU	3,237.00	1	3,237.00

- [期間 (Term Duration)] を入力します。
- [適用 (Apply)] をクリックし、[完了 (Done)] をクリックします。

ステップ 11.

UCSX Modular Server

UCSX-210C-M7-NEW

CPU

Memory

Drives

Bundle Configuration: UCSX-M7-XDIRECTXCC
Estimated Lead Time: 35 days

Set service preferences for this configuration

1: CISCO INTERSIGHT requires a minimum of 1 component(s). Please add additional quantities as necessary. (CE100010)
2: The category CISCO INTERSIGHT is required. (CE100103)
3: Please note that you are using a promotional PID which is available ONLY IF qualified for the 'UCSX X-Series X-Direct Xccelerate' Program. For details on the program, Pls review Sales Connect, contact your Cisco Account Manager or reach out to ask-ucsx@external.cisco.com. We encourage you NOT to book this PID if you do not qualify. Order will be on hold after booking to check for eligibility. (CE202322)

Available Components	Unit List Price (USD)
UCSX 9500 CHASSIS	
UCSX MODULAR SERVER	
UCSX-210C-M7-U UCS X210c M7 Compute Node 2S w/o CPU, Mem, Drv, Mezz 5 required Estimated Lead Time: 21 days	6,376.38
UCSX-210C-M7-NEW UCS X210c M7 R2L Free Compute Node 2S w/o CPU, Mem, Drv, Mezz 1 required Estimated Lead Time: 21 days	0.00
CISCO INTERSIGHT	

UCSX 9500 CHASSIS > 1 Selected (Min 1, Max 1)	Unit List Price (USD)	Adjusted List Price (USD)	Qty	Extended List Price (USD)
UCSX-9508-FREE Valid UCS 9508 Free Chassis		5,471.88	1	9,608.46

UCSX MODULAR SERVER > 6 Selected (Min 6, Max 6)	Unit List Price (USD)	Adjusted List Price (USD)	Qty	Extended List Price (USD)
UCSX-210C-M7-U Valid UCS X210c M7 Compute Node 2S w/o CPU, Mem, Drv, Mezz		22,003.99	5	466,945.70
UCSX-210C-M7-NEW Invalid UCS X210c M7 R2L Free Compute Node 2S w/o CPU, Mem, Drv, Mezz		1,079.00	1	1,079.00

CISCO INTERSIGHT > 0 Selected (Min 1, Max 1)

- 空きサーバー：UCSX-210C-M7-NEW は事前に選択されており、数量 1 のみを選択できます。
- さらに構成が必要なため、UCSX-210C-M7 -NEW ATO ステータスが「無効」になっていることに注意してください。
- Configurator を入力するために、[オプションの編集 (Edit Option)] をクリックします。

注： 少なくとも5つの有料サーバーと1つの無料サーバーの構成は同じである必要があります。

ステップ 12.

UCSX Modular Server

UCSX-210C-M7-NEW

CPU

Memory

Drives

Product Configuration
UCSX-210C-M7-NEW part of UCSX-M7-XDIRECTXCC Estimated Lead Time 21 days Price List Global Price List in US Dollars (USD) 0.00

⚠️ 1: A selection from Infrastructure and Workload is required. Please adjust the selections. (CE200277)
2: A selection of either UCSX-ML-V5Q50G-D or UCSX-ML-V5D200G-D or UCSX-MLV5D200GV2D from Rear MEZZ - MLOM/PCI is required. P
3: At least 1 selection(s) from Processor 4th Gen or Processor 5th Gen is required. Please make the selection. (CE200375)
4: Please note that this order will be placed on a Compliance Hold. Please reach out to sac-support@cisco.com to check if this order meets eligibility criteria for hold removal. Note that the order will remain on compliance hold if you do not reach out to sac-support@cisco.com to request eligibility check. (CE202322)

Configuration Summary View Full Summary

Category	Qty	Extended List Price (USD)
Processor 4th Gen		
Processor 5th Gen		
Memory 4800		
Memory 5600		
Front MEZZ - Controller		
Rear MEZZ - MLOM/PCI		
Storage Drives		
SATA M.2		
NVMe Boot		
Total		0.00
Estimated Lead Time		21 days

Option Search Multiple Options Search

UCSX-210C-M7-NEW > Processor 4th Gen

8000 Processor Series 4th Gen | 6000 Processor Series 4th Gen | 5000 Processor Series 4th Gen | 4000 Processor Series 4th Gen | 3000 Processor Series 4th Gen

SKU	Qty	Estimated Lead Time	Unit List Price (USD)
<input type="radio"/> UCSX-CPU-I8452Y Intel I8452Y 2GHz/300W 36C/67.5MB DDR5 4800MT/s	Qty	21 days	0.00
<input type="radio"/> UCSX-CPU-I8454H Intel I8454H 2.1GHz/270W 32C/82.5MB DDR5 4800MT/s	Qty	21 days	0.00
<input type="radio"/> UCSX-CPU-I8458P Intel I8458P 2.7GHz/350W 44C/82.5MB DDR5 4800MT/s	Qty	21 days	0.00
<input type="radio"/> UCSX-CPU-I8460H Intel I8460H 2.2GHz/330W 40C/105MB DDR5 4800MT/s	Qty	21 days	0.00
<input type="radio"/> UCSX-CPU-I8460Y+ Intel I8460Y+ 2GHz/300W 40C/105MB DDR5 4800MT/s	Qty	21 days	0.00

Reset Configuration Cancel Done

- 左側のカテゴリ ウィンドウから周辺機器を選択して、UCSX-210C-M7-NEW を構成します。
- PID は右側のウィンドウにリストされます。メモリやストレージ ドライブなどの一部の PID はタイプまたはシリーズに従ってグループ化されます。右側の SKU ウィンドウの上にあるグループ化されたオプションから選択します。
- 警告メッセージに従って、最低限必要なオプション PID を構成します。
- 完了したら [完了 (Done)] をクリックします。

ステップ 13.

UCSX Modular Server
UCSX-210C-M7-NEW
➔
Services/Subscriptions

Bundle Configuration UCSX-M7-XDIRECTXCC	Estimated Lead Time 35 days	Price List Global Price List (USD)	Total 477,633.16
--	--------------------------------	---------------------------------------	---------------------

Set service preferences for this configuration Cancel Done

⚠️ 1: CISCO INTERSIGHT requires a minimum of 1 component(s). Please add additional quantities as necessary. (CE100010)

2: The category CISCO INTERSIGHT is required. (CE100103)

3: Please note that you are using a promotional PID which is available ONLY IF qualified for the 'UCS X-Series X-Direct Xccelerate' Program. For details on the program, PIs review Sales Connect, contact your Cisco Account Manager or reach out to ask-ucsx@external.cisco.com. We encourage you NOT to book this PID if you do not qualify. Order will be on hold after booking to check for eligibility. (CE202322)

Available Components	Unit List Price (USD)	UCSX 9500 CHASSIS > 1 Selected (Min 1, Max 1)	Unit List Price (USD)	Adjusted List Price (USD)	Qty	Extended List Price (USD)
UCSX 9500 CHASSIS		UCSX-9508-FREE Valid ⚠️		5,471.88	1	9,608.46
UCSX MODULAR SERVER		UCSX-210C-M7-U				
UCSX-210C-M7-U UCS X210c M7 Compute Node 2S w/o CPU, Mem, Drv, Mezz 5 required Estimated Lead Time: 21 days	6,376.38	UCSX-210C-M7-U Valid		22,003.99	5	466,945.70
UCSX-210C-M7-NEW UCS X210c M7 R2L Free Compute Node 2S w/o CPU, Mem, Drv, Mezz 1 required Estimated Lead Time: 21 days	0.00	UCSX-210C-M7-NEW Valid ⚠️		1,079.00	1	1,079.00
CISCO INTERSIGHT		CISCO INTERSIGHT > 0 Selected (Min 1, Max 1)				

- a. ステータスには現在、[有効 (Valid)] として表示されています。
- b. [サービス/サブスクリプションの編集 (Edit Services/Subscriptions)] をクリックして、ハードウェア サポートの期間を編集します。

注： ハードウェア サポートの期間は、ソフトウェア サブスクリプション期間と一致させることをお勧めします。

ステップ 14.

UCSX Modular Server

Price List Global Price List **UCSX-210C-M7-NEW** Service Total 37.00

Services/Subscriptions

You may receive additional discounts because you selected two or more years of service. To review your discounts you can go to the Order or Quoting discount pages. (C0124)

Service Non Serviceable Products

The duration that you entered has been successfully applied to all the services. (C0329)

Service Options

Choose Service Level from All Service Programs

Search by Name & Description

Note: Cisco may still install another compatible service if required. Compatible services are the services that come with primary service and are based on products.

Time Duration

Duration 36

Delay service start to

Co-Term service to

Reset Apply

Service SKU	Product SKU	Unit List Price (USD)	Qty	Total List Price (USD)
Cisco Customer Experience Level 1 (1 ITEM) SERVICE PROGRAM	L1NCO (CX LEVEL 1 8X7XNCDOS) SUMMARY			
CON-L1NCO-UCSX221C CX LEVEL 1 8X7XNCDOS UCS X210c M7 Compute N...	UCSX-210C-M7-NEW UCS X210c M7 R2L Free Compute Node 2S w/o CPU, ...	3,237.00	1	3,237.00
Change Service Remove Service				

Remove All Services Remove All Additional Services

Configuration Summary All prices shown in USD

Services 3,237.00

Cancel Done

- a. [期間 (Term Duration)] を入力します。
- b. [適用 (Apply)] をクリックし、[完了 (Done)] をクリックします。

ステップ 15.

Cisco Intersight

Bundle Configuration UCSX-M7-XDIRECTXCC Estimated Lead Time 35 days Total 479,791.16

Get service preferences for this configuration

1: Please note that Intersight is required selection and needed for the M7 Server to function. All orders with CNDL-DESELECT-D will be manually reviewed for Compliance. (CE202322)

2: Please note that you are using a promotional PID which is available ONLY IF qualified for the 'UCS X-Series X-Direct Accelerate' Program. For details on the program, please review Sales Connect, contact your Cisco Account Manager or reach out to ask-ucsx@external.cisco.com. We encourage you NOT to book this PID if you do not qualify. Order will be on hold until you qualify.

CNDL-DESELECT-D has been added to the bundle category CISCO INTERSIGHT.

Available Components Unit List Price (USD)

- UCSX 9500 CHASSIS
- UCSX MODULAR SERVER
- CISCO INTERSIGHT
- DC-MGT-SaaS
Cisco Intersight SaaS 0.00
- CNDL-DESELECT-D
Conditional Deselect
Estimated Lead Time: 7 days

UCSX 9500 CHASSIS > 1 Selected (Min 1, Max 1)

Product	Unit List Price (USD)	Adjusted List Price (USD)	Qty	Extended List Price (USD)
UCSX-9508-FREE Valid UCS 9508 Free Chassis		5,471.88	1	9,608.46

UCSX MODULAR SERVER > 6 Selected (Min 6, Max 8)

Product	Unit List Price (USD)	Adjusted List Price (USD)	Qty	Extended List Price (USD)
UCSX-210C-M7-U Valid UCS X210c M7 Compute Node 2S w/o CPU, Mem, Drv, Mezz		22,003.99	5	466,945.70
UCSX-210C-M7-NEW Valid UCS X210c M7 R2L Free Compute Node 2S w/o CPU, Mem, Drv, Mezz		3,237.00	1	3,237.00

Add a UCSX MODULAR SERVER from the left panel

CISCO INTERSIGHT > 1 Selected (Min 1, Max 1)

Product	Unit List Price (USD)	Adjusted List Price (USD)	Qty	Extended List Price (USD)
CNDL-DESELECT-D Conditional Deselect		0.00	1	0.00

- a. **CNDL-DESELECT-D** は、お客様が EA 契約を介して Cisco Intersight ライセンスをすでに購入している場合、または注文が Distri Fulfillment である場合にのみ選択することを意図しています。

- b. M7 Server が機能するには、Intersight の選択が必要であることを注意してください。CNDL-DESELECT-D を含むすべての注文は、遵守について手動で確認されます。

ステップ 16.

The screenshot shows the 'Configuration Summary' for 'CNDL-DESELECT-D'. The 'Reason Codes' table is as follows:

SKU	Qty	Estimated Lead Time	Unit List Price (USD)
<input checked="" type="radio"/> OPTOUT-DISTI-ONLY For Dist when ordering mandatory licenses separately	1	3 days	0.00
<input type="radio"/> OPTOUT-EA-ONLY License not needed: Customer already owns Licenses in an EA	1	3 days	0.00
<input type="radio"/> OPTOUT-ENTL-SWAP License not needed: Entitlements updated in Smart Account. More	1	3 days	0.00

- a. 適切な [理由コード (Reason Code)] を選択してください。

ステップ 17.

The screenshot shows the 'Available Components' and 'Product' list. The 'Product' list is as follows:

Product	Unit List Price (USD)	Adjusted List Price (USD)	Qty	Extended List Price (USD)
<input checked="" type="checkbox"/> UCSX-9508-FREE Valid ⚠️ UCS 9508 Free Chassis		5,471.88	1	9,608.46
<input checked="" type="checkbox"/> UCSX-210C-M7-U Valid ⚠️ UCS X210c M7 Compute Node 2S w/o CPU, Mem, Mezz		22,003.99	5	466,945.70
<input checked="" type="checkbox"/> UCSX-210C-M7-NEW Valid ⚠️ UCS X210c M7 R2L Free Compute Node 2S w/o CPU, Mem, Drv, Mez		3,237.00	1	3,237.00
<input checked="" type="checkbox"/> CNDL-DESELECT-D Valid ⚠️ Conditional Deselect		0.00	1	0.00

Warning messages:

- Please note that Intersight is required selection and needed for the M7 Server to function. All orders with CNDL-DESELECT-D will be manually reviewed for Compliance. (CE202322)
- Please note that you are using a promotional PID which is available ONLY IF qualified for the 'UCS X-Series X-Direct Xcelerate' Program. For details on the program, pls review Sales Connect, contact your Cisco Account Manager or reach out to ask-ucsx@external.cisco.com. We encourage you NOT to book this PID if you do not qualify. Order will be on hold after booking to check for eligibility. (CE202322)

- a. 各製品のステータスが [有効 (Valid)] であり、警告メッセージがなくなると MLB の構成が完了します。

- b. 「PLUS」 をクリックして、展開して、各製品に行った選択を表示します。
- c. MLB 構成を完了するために、[完了 (Done)] をクリックします。

ステップ 18.

The screenshot displays the Cisco Intersight interface. At the top, there is a search bar with the text "Add by SKU Description and Product Family" and a search icon. Below the search bar, there are several tabs and buttons: "Lines View", "Apply Success Track", "Manage Groups", "Remove Selected Lines", and "More Actions". To the right, there are icons for "Import Saved Configuration", a lightbulb, a list, and a wallet, along with "Estimate Preferences" and a vertical ellipsis menu. Below these, there is a "Zero List Price Items" section with "Hide" and "Show" toggle buttons, and a search bar for "Search Estimate Line Items". The main part of the screenshot is a table with the following columns: "Hardware, Software and Services", "Estimated Lead Time (Days)", "Unit List Price (USD)", "Qty", "Unit Net Price (USD)", "Discounts (%)", and "Extended Net Price (USD)". The table contains one row with the following data: "1.0 UCSX-M7-XDIRECTXCC", "Valid as of 04-Jun-2024 01:26:10 PDT", "35", "21,052.99", "1", "21,052.99", "0.00", and "446,707.02". Below the table, there are several action buttons: "Edit Options", "Validate", "Recommended Content", "Add Note", "Add Subtotal", "Copy", "Remove Line", and "Additional Details".

- a. CCW で DC-MGT-SAAS を検索し、[追加] をクリックします
- b. Cisco Intersight ソフトウェアを以前に購入していない場合は、Intersight を選択する必要があります。Configurator を入力するために、[オプションの選択 (Select Options)] をクリックします。

ステップ 19.

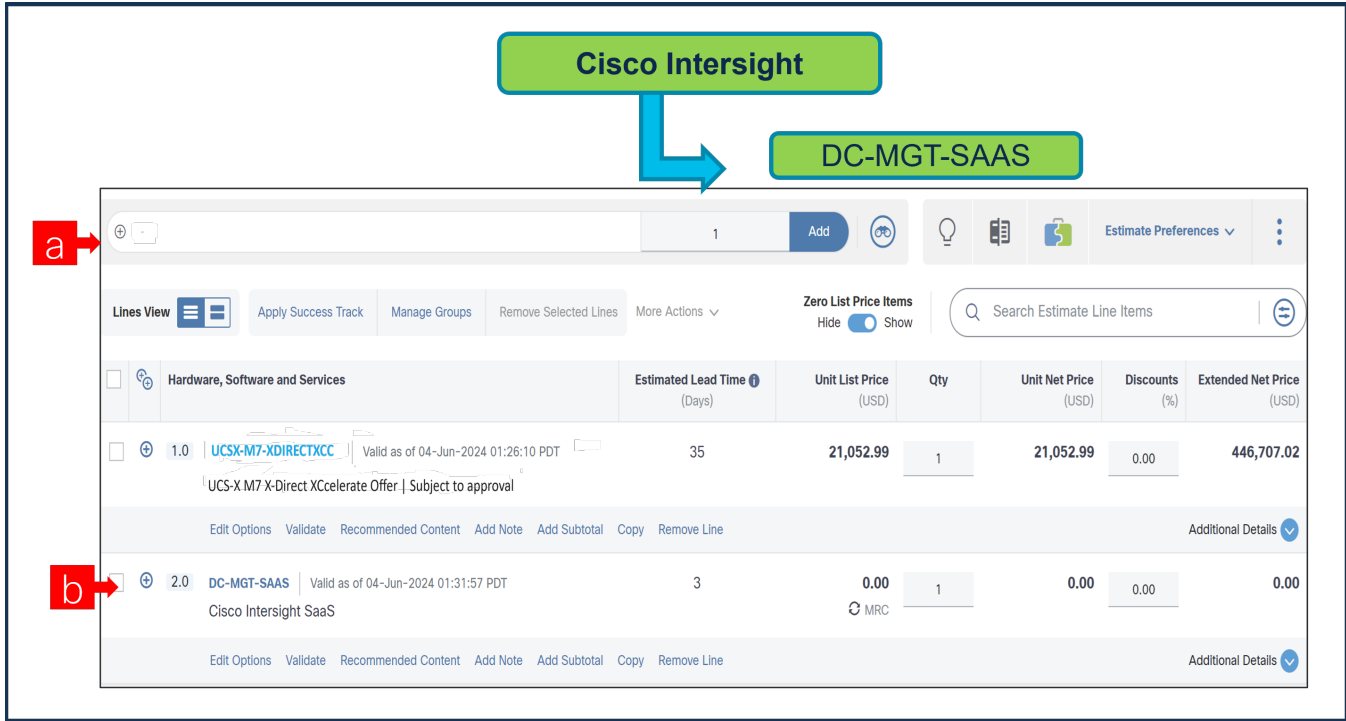

- a. オファー DC-MGT-SAAS の下の Cisco Interact 2.0 インフラストラクチャ サービス ライセンスの数量は、選択されたサーバの数量と同じである必要があります。数量を入力します。

ステップ 20.

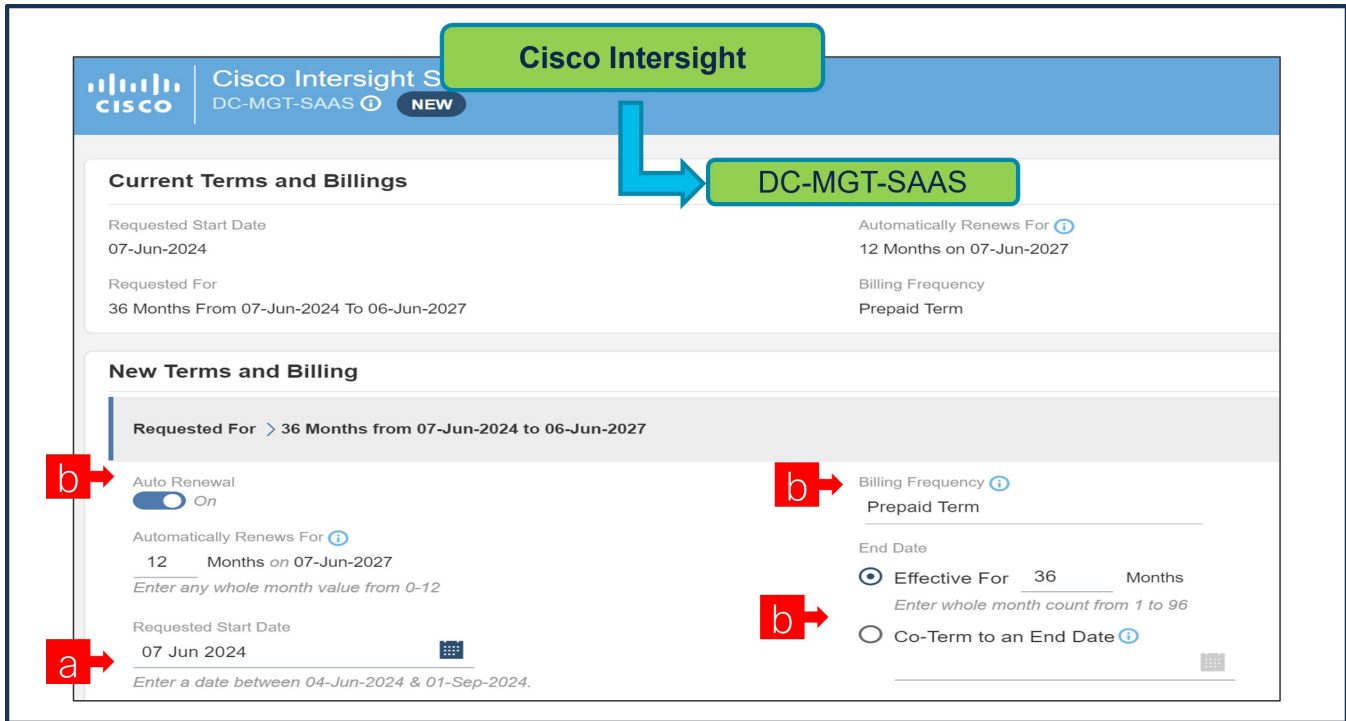

- a. 開始希望日 (RSD) : Software-as-a-Service (SaaS) 製品を予約する際には、90 日先の開始希望日 (RSD) を選択することをお勧めします。

- b. 終了日（月単位の期間）はデフォルトで **36** か月に設定され、自動更新（オン/オフ）はデフォルトでオンに設定され、請求頻度はデフォルトで前払い期間に設定されます。それに応じて設定を変更することもできます。

ステップ 21.

Cisco Intersight

DC-MGT-SAAS

Subscription USD 7,560.00 | Service USD 0.00

PRODUCTS	UNIT LIST PRICE	STATUS	QUANTITY	ACTION
Cisco Intersight 2.0 Infrastructure Services				
Infrastructure Services SaaS/CVA - Essentials DC-MGT-IS-SAAS-ES SA	35.00 Per Device/Month	Added	6 Device	Delete
Infrastructure Services SaaS/CVA - Advantage DC-MGT-IS-SAAS-AD SA	Enter Qty to see List Price Per Device/Month	Not Added	Qty Device	+ Add
Infrastructure Services PVA - Essentials DC-MGT-IS-PVAPP-ES SA	Enter Qty to see List Price Per Device/Month	Not Added	Qty Device	+ Add
Infrastructure Services PVA - Advantage DC-MGT-IS-PVAPP-AD SA	Enter Qty to see List Price Per Device/Month	Not Added	Qty Device	+ Add
Add-Ons				
UCS Director - 1 Server License (includes Network, Storage) DC-MGT-IS-UCSD	Enter Qty to see List Price Per Device/Month	Not Added	Qty Device	+ Add

Configuration Summary

PRODUCTS	QUANTITY	EXTENDED LIST PRICE
Cisco Intersight 2.0 Infrastructure Services		
DC-MGT-IS-SAAS-ES SA 35.00 Per Device/Month x 36 Months	6 Device	7,560.00
Cisco Intersight Support		
SVS-DCM-SUPT-BAS	1 Each	0.00
Auto Expansion		
DC-MGT-UCSC-1S SA	6 Device	0.00
DC-MGT-ADOPT-BAS	1 License	0.0000

- a. オファー DC-MGT-SAAS の下の Cisco Intersight 2.0 インフラストラクチャ サービス ライセンスの数量は、選択されたサーバの数量と同じである必要があります。数量を入力します。

ステップ 22.

Cisco Intersight

DC-MGT-SAAS

Subscription USD 7,560.00 | Service USD 0.00

PRODUCTS	UNIT LIST PRICE	STATUS	QUANTITY	ACTION
Cisco Intersight Support				
Solution Support for DC Mgmt SVS-SSTCS-DCMGMT SA	Enter Qty to see List Price Per Each/Month	Not Added	Qty Each	Swap
CXL1 for INTERSIGHT SVS-L1DCS-INTER SA	Enter Qty to see List Price Per Each/Month	Not Added	Qty Each	Swap
CXL2 for INTERSIGHT SVS-L2DCS-INTER SA	Enter Qty to see List Price Per Each/Month	Not Added	Qty Each	Swap
Basic Support for DCM SVS-DCM-SUPT-BAS	0.00 Per Each/Month	Added	1 Each	Delete

Configuration Summary

PRODUCTS	QUANTITY	EXTENDED LIST PRICE
Cisco Intersight 2.0 Infrastructure Services		
DC-MGT-IS-SAAS-ES SA 35.00 Per Device/Month x 36 Months	6 Device	7,560.00
Cisco Intersight Support		
SVS-DCM-SUPT-BAS	1 Each	0.00
Auto Expansion		
DC-MGT-UCSC-1S SA	6 Device	0.00
DC-MGT-ADOPT-BAS	1 License	0.0000

- a. Cisco Intersight License には、個別のサポートが付属しています。基本組み込み型サポートはデフォルトの選択です。お客様が HW の Solution Support または CX Success Track L1 または L2 にアップグレードすることをお勧めします。

ステップ 23.

SKU	Estimated Lead Time (Days)	Unit List Price (USD)	Qty	Unit Net Price (USD)	Discounts (%)	Extended Net Price (USD)
1.0 UCSX-M7-XDIRECTXCC Valid as of 04-Jun-2024 01:26:10 PDT UCS-X M7 X-Direct Xccelerate Offer Subject to approval	35	21,052.99	1	21,052.99	0.00	446,707.02
2.0 DC-MGT-SAAS Valid as of 04-Jun-2024 01:41:12 PDT Cisco Intersight SaaS	3	210.00	1	210.00	0.00	7,560.00

- a. これで UCSX-M7-XDIRECTXCC および DC-MGT-SAAS の構成が完了し、各製品のステータスが有効と表示されます。
- b. 「PLUS」をクリックして、展開して、各製品に行った選択を表示します。

シナリオ 2 : Cisco インターサイト ソフトウェア ライセンスのエンタープライズ契約を締結しているお客様
ステップ 1.

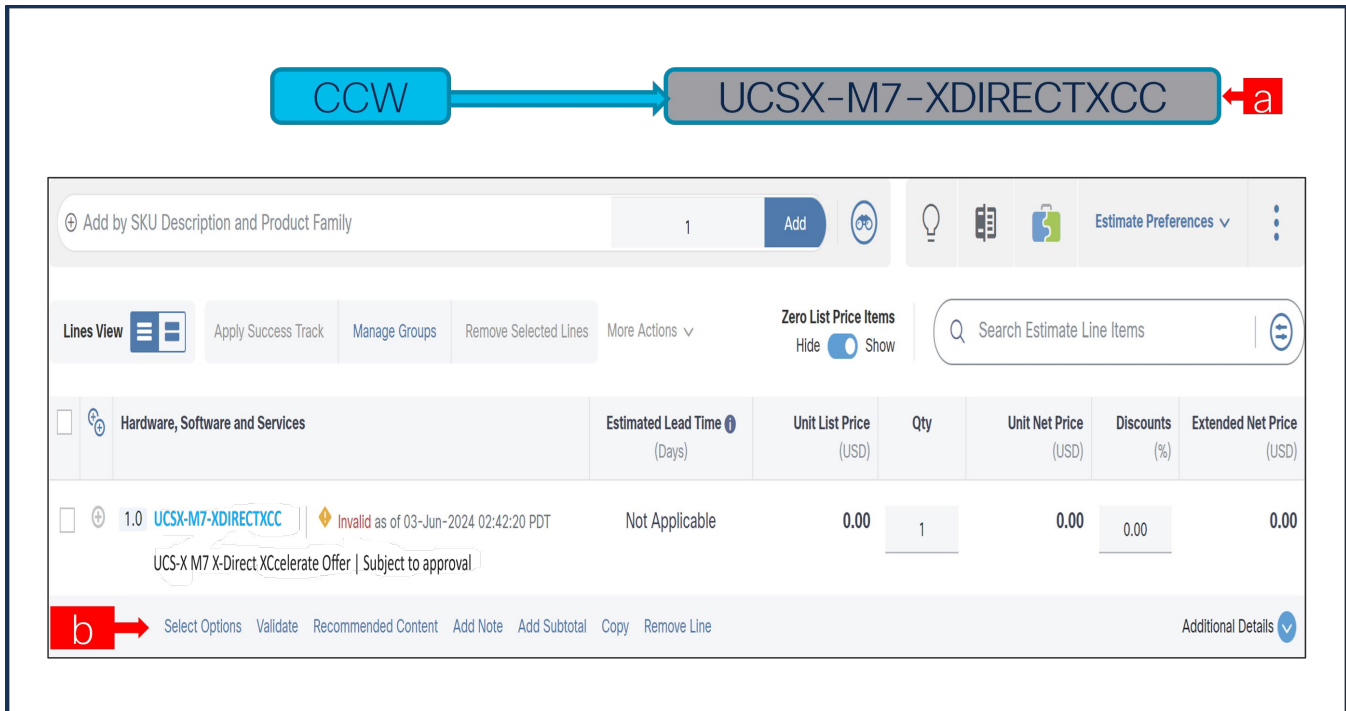

- a. CCW で MLB PID を検索して、[追加 (Add)] をクリックします。
- b. Configurator を入力するために、[オプションの選択 (Select Options)] をクリックします。

ステップ 2.

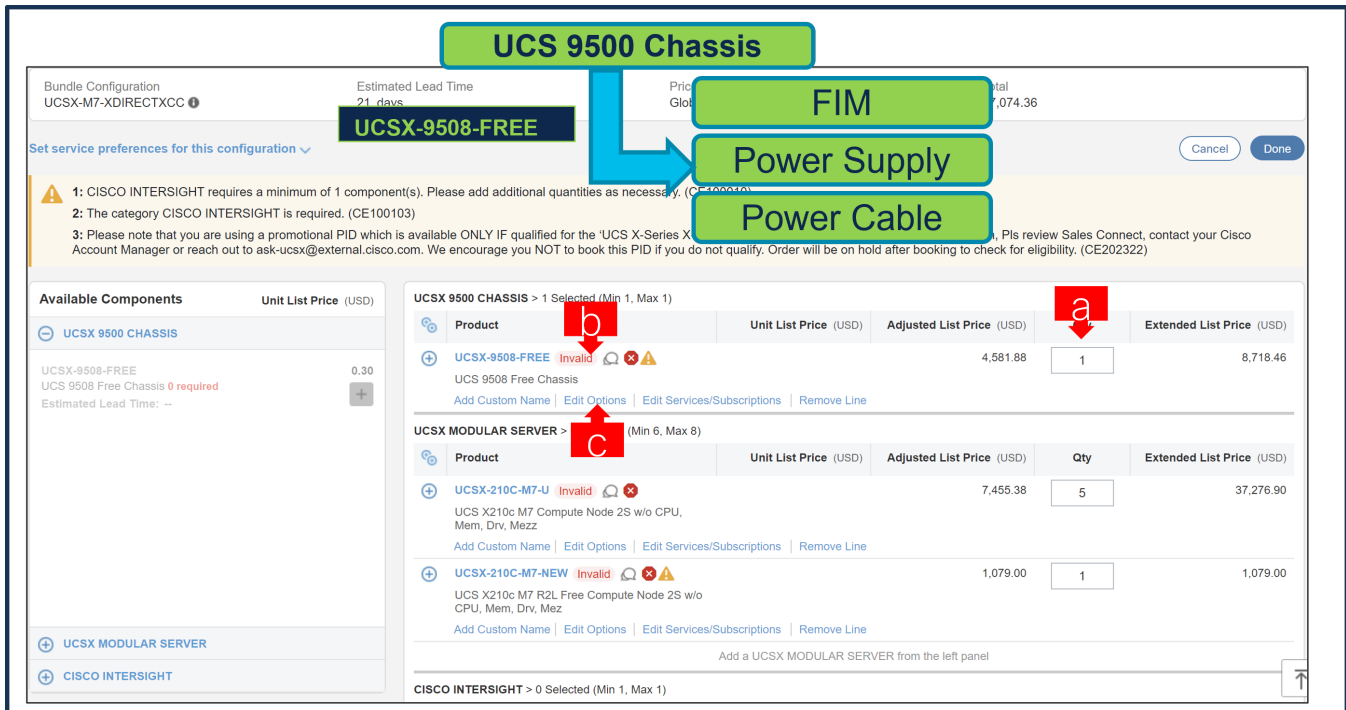

- a. 空きシャーシ : UCSX-9508-FREE は事前に選択されており、数量 1 のみを選択できます
- b. さらに構成が必要なため、UCSX-9508-FREE ATO ステータスが無効であることを通知します。
- c. Configurator を入力するために、[オプションの編集 (Edit Option)] をクリックします。

ステップ 3.

Product Configuration: UCSX-9508-FREE (part of UCSX-M7-XDIRECTXCC) | Estimated Lead Time: 21 days | Total (USD): 8,273.46

Configuration Summary:

Category	Qty	Extended List Price (USD)
Fabric Interconnect Module		
UCSX-S9108-100G	2	0.00
UCSX-S9108-SW	2	8,273.16
Power		
UCSX-PSU-2800AC-D	6	0.00
Accessory		
UCSX-C-DEBUGCBL-D	1	0.00
UCSX SW		
UCSX-CHASSIS-SW-D	1	0.00
Total		8,273.46
Estimated Lead Time		21 days

Power Cable Selection Table:

SKU	Qty	Estimated Lead Time	Unit List Price (USD)
NO-POWER-CORD	6	3 days	0.00
CAB-AC-2500W-EU	6	8 days	0.00
CAB-AC-2500W-INT	6	8 days	0.00
CAB-C19-CBN	6	14 days	0.00
CAB-AC-C6K-TWLK	6	8 days	0.00

- ファブリック インターコネクト モジュールと電源のペアは、構成およびソフトウェア ライセンスに自動的に無料で付属しています。UCSX-S9108-SW が有料で事前に選択されています。
- 左側のカテゴリ ウィンドウから電源ケーブルを選択して、UCSX-9508-FREE を設定します。
- 「完了」をクリックします

ステップ 4.

Bundle Configuration: UCSX-M7-XDIRECTXCC | Estimated Lead Time: 21 days | Price List: Global Price List (USD) | Total: 47,074.36

Available Components:

Product	Unit List Price (USD)	Adjusted List Price (USD)	Qty	Extended List Price (USD)
UCSX 9500 CHASSIS > 1 Selected (Min 1, Max 1)				
UCSX-9508-FREE	0.30	4,581.88	1	8,718.46
UCSX MODULAR SERVER > 6 Selected (Min 6, Max 8)				
UCSX-210C-M7-U	7,455.38	7,455.38	5	37,276.90
UCSX-210C-M7-NEW	1,079.00	1,079.00	1	1,079.00
CISCO INTERSIGHT > 0 Selected (Min 1, Max 1)				

- a. ステータスには現在、[有効 (Valid)]として表示されています。
- b. [サービス/サブスクリプションの編集 (Edit Services/Subscriptions)]をクリックして、ハードウェアサポートの期間を編集します。

注： ハードウェア サポートの期間は、ソフトウェア サブスクリプション期間と一致させることをお勧めします。

ステップ 5.

The screenshot shows the configuration page for 'UCS 9500 Chassis'. At the top, there are labels for 'UCS 9500 Chassis' and 'Services/Subscriptions'. Below this, the 'Service Subscription' is listed as 'UCSX-9508-FREE' with a 'Global Price' of '1,335.00'. A message states: 'You may receive additional discounts because you selected two or more years of service. To review your discounts you can go to the Order or Quoting discount pages. (C0124)'. The 'Service' is identified as 'Non Serviceable Products'. A notification says: 'The duration that you entered has been successfully applied to all the services. (C0329)'. Under 'Service Options', there is a search bar and a 'Time Duration' section with radio buttons for 'Duration' (selected), 'Delay service start to', and 'Co-Term service to'. The 'Duration' field is set to '36'. There are 'Reset' and 'Apply' buttons. Below this is a table with columns: 'Service SKU', 'Product SKU', 'Unit List Price (USD)', 'Qty', and 'Total List Price (USD)'. The table contains one row: 'Cisco Customer Experience Level 1 (1 ITEM) L1NCO (CX LEVEL 1 8X7XNCDOS) Duration 36 Months' with a unit price of '1,335.00' and a total price of '1,335.00'. Below the table are buttons for 'Remove All Services' and 'Remove All Additional Services'. At the bottom right, there is a 'Configuration Summary' showing 'Services' with a total price of '1,335.00' and 'Cancel' and 'Done' buttons.

- a. [期間 (Term Duration)]を入力します。
- b. [適用 (Apply)]をクリックし、[完了 (Done)]をクリックします。

ステップ 6.

UCSX Modular Server

UCSX-210C-M7-U

CPU

Memory

Drives

Bundle Configuration
UCSX-M7-XDIRECTXCC

Estimated Lead Time
21 days

Global Price List (USD)

Set service preferences for this configuration

1: CISCO INTERSIGHT requires a minimum of 1 component(s). Please add additional quantities as necessary. (CE100010)
2: The category CISCO INTERSIGHT is required. (CE100103)
3: Please note that you are using a promotional PID which is available ONLY IF qualified for the 'UCS X-Series X-Direct Xccelerate' Program. For details on the program, Pls review Sales Connect, contact your Cisco Account Manager or reach out to ask-ucsx@external.cisco.com. We encourage you NOT to book this PID if you do not qualify. Order will be on hold after booking to check for eligibility. (CE202322)

Available Components	Unit List Price (USD)
UCSX 9500 CHASSIS	
UCSX MODULAR SERVER	
UCSX-210C-M7-U UCS X210c M7 Compute Node 2S w/o CPU, Mem, Drv, Mezz 5 required Estimated Lead Time: 21 days	6,376.38
UCSX-210C-M7-NEW UCS X210c M7 R2L Free Compute Node 2S w/o CPU, Mem, Drv, Mezz 1 required Estimated Lead Time: 21 days	0.00
CISCO INTERSIGHT	

UCSX 9500 CHASSIS > 1 Selected (Min 1, Max 1)	Unit List Price (USD)	Adjusted List Price (USD)	Qty	Extended List Price (USD)
UCSX-9508-FREE Valid UCS 9508 Free Chassis Add Custom Name Edit Options Edit Services/Subscriptions Remove Line		5,471.88	1	9,608.46

UCSX MODULAR SERVER > 5 Selected (Min 6, Max 8)	Unit List Price (USD)	Adjusted List Price (USD)	Qty	Extended List Price (USD)
UCSX-210C-M7-U Invalid UCS X210c M7 Compute Node 2S w/o CPU, Mem, Drv, Mezz Add Custom Name Edit Options Edit Services/Subscriptions Remove Line	7,455.38		5	37,276.90
UCSX-210C-M7-NEW UCS X210c M7 R2L Free Compute Node 2S w/o CPU, Mem, Drv, Mezz Add Custom Name Edit Options Edit Services/Subscriptions Remove Line	1,079.00		1	1,079.00

Add a UCSX MODULAR SERVER from the left panel

CISCO INTERSIGHT > 0 Selected (Min 1, Max 1)

- 有料サーバー：UCSX-210C-M7-U は MLB で数量 5 が事前に選択されており、最大数量 7 まで選択できます。
- さらに構成が必要なため、UCSX-210C-M7-U ATO ステータスが「無効」になっていることに注意してください。
- Configurator を入力するために、[オプションの編集 (Edit Option)] をクリックします。

ステップ 7.

UCSX Modular Server

UCSX-210C-M7-U

CPU
Memory
Drives

Product Configuration: UCSX-210C-M7-U part of UCSX-RECTXCC Estimated Lead Time: 21 days Price List: Global Price List in (USD) 38

Warning Messages:

- 1: A selection from Infrastructure and Workload is required. Please adjust the selections. (CE200277)
- 2: A selection of either UCSX-ML-V5Q50G-D or UCSX-ML-V5D200G-D or UCSX-MLV5D200GV2D from Rear MEZZ - MLOM/PCI is required. Please adjust the selections. (CE200096)
- 3: At least 1 selection(s) from Processor 4th Gen or Processor 5th Gen is required. Please make the selection. (CE200375)
- 4: UCSX-210C-M7-U quantity 1 requires a minimum quantity of 1 from Security Options (CE100012)

Configuration Summary

Category	Qty	Extended List Price (USD)
Processor 4th Gen		
Processor 5th Gen		
Memory 4800		
Memory 5600		
Front MEZZ - Controller		
Rear MEZZ - MLOM/PCI		
Storage Drives		
SATA M.2		
NVMe Boot		
Total		6,376.38
Estimated Lead Time		21 days

Options List:

SKU	Qty	Estimated Lead Time	Unit List Price (USD)
<input type="radio"/> UCSX-CPU-I8452Y Intel I8452Y 2GHz/300W 36C/67.5MB DDR5 4800MT/s	Qty	21 days	11,300.22
<input type="radio"/> UCSX-CPU-I8454H Intel I8454H 2.1GHz/270W 32C/82.5MB DDR5 4800MT/s	Qty	21 days	17,571.42
<input type="radio"/> UCSX-CPU-I8458P Intel I8458P 2.7GHz/350W 44C/82.5MB DDR5 4800MT/s	Qty	21 days	18,953.30
<input type="radio"/> UCSX-CPU-I8460H Intel I8460H 2.2GHz/330W 40C/105MB DDR5 4800MT/s	Qty	21 days	27,690.77
<input type="radio"/> UCSX-CPU-I8460Y+ Intel I8460Y+ 2GHz/300W 40C/105MB DDR5 4800MT/s	Qty	21 days	14,783.55

Buttons: Reset Configuration, Cancel, Done

- 左側のカテゴリ ウィンドウから周辺機器を選択して、UCSX--210C-M7-U を構成します。
- PID は右側のウィンドウにリストされます。メモリやストレージ ドライブなどの一部の PID はタイプまたはシリーズに従ってグループ化されます。右側の SKU ウィンドウの上にあるグループ化されたオプションから選択します。
- 警告メッセージに従って、最低限必要なオプション PID を構成します。
- 完了したら [完了 (Done)] をクリックします。

ステップ 8.

UCSX Modular Server

Bundle Configuration: UCSX-M7-XDIRECTXCC
Estimated Lead Time: 35 days
Price: Global Price List (USD)

Set service preferences for this configuration

1: CISCO INTERSIGHT requires a minimum of 1 component(s). Please add additional quantities as necessary. (CE100010)
2: The category CISCO INTERSIGHT is required. (CE100103)
3: Please note that you are using a promotional PID which is available ONLY IF qualified for the 'UCS X-Series X-Direct Xcelerate' Program. For details on the program, Pls review Sales Connect, contact your Cisco Account Manager or reach out to ask-ucsx@external.cisco.com. We encourage you NOT to book this PID if you do not qualify. Order will be on hold after booking to check for eligibility. (CE202322)

Available Components	Unit List Price (USD)
UCSX 9500 CHASSIS	
UCSX MODULAR SERVER	
UCSX-210C-M7-U UCS X210c M7 Compute Node 2S w/o CPU, Mem, Drv, Mezz 5 required Estimated Lead Time: 21 days	6,376.38
UCSX-210C-M7-NEW UCS X210c M7 R2L Free Compute Node 2S w/o CPU, Mem, Drv, Mezz 1 required Estimated Lead Time: 21 days	0.00
CISCO INTERSIGHT	

UCSX 9500 CHASSIS > 1 Selected (Min 1, Max 1)				
Product	Unit List Price (USD)	Adjusted List Price (USD)	Qty	Extended List Price (USD)
UCSX-9508-FREE Valid UCS 9508 Free Chassis		5,471.88	1	9,608.46

UCSX MODULAR SERVER > 6 Selected (Min 6, Max 8)				
Product	Unit List Price (USD)	Adjusted List Price (USD)	Qty	Extended List Price (USD)
UCSX-210C-M7-U Valid UCS X210c M7 Compute Node 2S w/o CPU, Mem, Drv, Mezz		19,845.99	5	456,155.70
UCSX-210C-M7-NEW Invalid UCS X210c M7 R2L Free Compute Node 2S w/o CPU, Mem, Drv, Mezz		1,079.00	1	1,079.00

CISCO INTERSIGHT > 0 Selected (Min 1, Max 1)

- ステータスには現在、[有効 (Valid)]として表示されています。
 - 同じ構成の倍数の数量を増やします。
 - 「PLUS」をクリックして、異なるオプション/数量の同じ製品を追加するか、異なる製品を選択します。
- ステップ 9.

UCSX Modular Server

Bundle Configuration: UCSX-M7-XDIRECTXCC
Estimated Lead Time: 35 days
Price: Global Price List (USD)

Set service preferences for this configuration

1: CISCO INTERSIGHT requires a minimum of 1 component(s). Please add additional quantities as necessary. (CE100010)
2: The category CISCO INTERSIGHT is required. (CE100103)
3: Please note that you are using a promotional PID which is available ONLY IF qualified for the 'UCS X-Series X-Direct Xcelerate' Program. For details on the program, Pls review Sales Connect, contact your Cisco Account Manager or reach out to ask-ucsx@external.cisco.com. We encourage you NOT to book this PID if you do not qualify. Order will be on hold after booking to check for eligibility. (CE202322)

Available Components	Unit List Price (USD)
UCSX 9500 CHASSIS	
UCSX MODULAR SERVER	
UCSX-210C-M7-U UCS X210c M7 Compute Node 2S w/o CPU, Mem, Drv, Mezz 5 required Estimated Lead Time: 21 days	6,376.38
UCSX-210C-M7-NEW UCS X210c M7 R2L Free Compute Node 2S w/o CPU, Mem, Drv, Mezz 1 required Estimated Lead Time: 21 days	0.00
CISCO INTERSIGHT	

UCSX 9500 CHASSIS > 1 Selected (Min 1, Max 1)				
Product	Unit List Price (USD)	Adjusted List Price (USD)	Qty	Extended List Price (USD)
UCSX-9508-FREE Valid UCS 9508 Free Chassis		5,471.88	1	9,608.46

UCSX MODULAR SERVER > 6 Selected (Min 6, Max 8)				
Product	Unit List Price (USD)	Adjusted List Price (USD)	Qty	Extended List Price (USD)
UCSX-210C-M7-U Valid UCS X210c M7 Compute Node 2S w/o CPU, Mem, Drv, Mezz		19,845.99	5	456,155.70
UCSX-210C-M7-NEW Invalid UCS X210c M7 R2L Free Compute Node 2S w/o CPU, Mem, Drv, Mezz		1,079.00	1	1,079.00

CISCO INTERSIGHT > 0 Selected (Min 1, Max 1)

- [サービス/サブスクリプションの編集 (Edit Services/Subscriptions)]をクリックして、ハードウェアサポートの期間を編集します。

注： ハードウェア サポートの期間は、ソフトウェア サブスクリプション期間と一致させることをお勧めします。

ステップ 10.

UCSX Modular Server

UCSX-210C-M7-U

Services/Subscriptions

Service Subscription
UCSX-210C-M7-U

Price List
Global Price List in US Dollars (USD)

Service Price
3,237.00

You may receive additional discounts because you selected two or more years of service. To review your discounts you can go to the Order or Quoting discount pages. (C0124)

Service Non Serviceable Products

The duration that you entered has been successfully applied to all the services. (C0329)

Service Options

Choose Service Level from All Service Programs

Search by Name & Description

Note: Cisco may still install another compatible service if required. Compatible services are the services that come with primary service and are based on products.

Time Duration

Duration 36

Duration

Delay service start to

Co-Term service to

Reset Apply

Service SKU	Product SKU	Unit List Price (USD)	Qty	Total List Price (USD)
Cisco Customer Experience Level 1 (1 ITEM) SERVICE PROGRAM	L1NCO (CX LEVEL 1 8X7XNCDOS) SUMMARY		36 Months	
CON-L1NCO-UCSX023C CX LEVEL 1 8X7XNCDOS UCS X210c M7 Compute N... SERVICE SKU	UCSX-210C-M7-U UCS X210c M7 Compute Node 2S w/o CPU, Mem, Drv... PRODUCT SKU	3,237.00	1	3,237.00

Remove All Services Remove All Additional Services

Configuration Summary All prices shown in USD

Services 3,237.00

Cancel Done

- [期間 (Term Duration)] を入力します。
- [適用 (Apply)] をクリックし、[完了 (Done)] をクリックします。

ステップ 11.

UCSX Modular Server

UCSX-210C-M7-NEW

CPU
Memory
Drives

Bundle Configuration: UCSX-M7-XDIRECTXCC
Estimated Lead Time: 35 days
Global Price List (USD)

Set service preferences for this configuration

⚠️ 1: CISCO INTERSIGHT requires a minimum of 1 component(s). Please add additional quantities as necessary. (CE100010)
2: The category CISCO INTERSIGHT is required. (CE100103)
3: Please note that you are using a promotional PID which is available ONLY IF qualified for the 'UCSX X-Series X-Direct Xccelerate' Program. For details on the program, Pls review Sales Connect, contact your Cisco Account Manager or reach out to ask-ucsx@external.cisco.com. We encourage you NOT to book this PID if you do not qualify. Order will be on hold after booking to check for eligibility. (CE202322)

Available Components	Unit List Price (USD)
UCSX 9500 CHASSIS	
UCSX MODULAR SERVER	
UCSX-210C-M7-U UCS X210c M7 Compute Node 2S w/o CPU, Mem, Drv, Mezz 5 required Estimated Lead Time: 21 days	6,376.38
UCSX-210C-M7-NEW UCS X210c M7 R2L Free Compute Node 2S w/o CPU, Mem, Drv, Mezz 1 required Estimated Lead Time: 21 days	0.00
CISCO INTERSIGHT	

UCSX 9500 CHASSIS > 1 Selected (Min 1, Max 1)	Unit List Price (USD)	Adjusted List Price (USD)	Qty	Extended List Price (USD)
UCSX-9508-FREE Valid UCS 9508 Free Chassis Add Custom Name Edit Options Edit Services/Subscriptions Remove Line		5,471.88	1	9,608.46

UCSX MODULAR SERVER > 6 Selected (Min 6, Max 6)	Unit List Price (USD)	Adjusted List Price (USD)	Qty	Extended List Price (USD)
UCSX-210C-M7-U Valid UCS X210c M7 Compute Node 2S w/o CPU, Mem, Drv, Mezz Add Custom Name Edit Options Edit Services/Subscriptions Remove Line		22,003.99	5	466,945.70
UCSX-210C-M7-NEW Invalid UCS X210c M7 R2L Free Compute Node 2S w/o CPU, Mem, Drv, Mezz Add Custom Name Edit Options Edit Services/Subscriptions Remove Line		1,079.00	1	1,079.00

CISCO INTERSIGHT > 0 Selected (Min 1, Max 1)

- 空きサーバー : UCSX-210C-M7-NEW は事前に選択されており、数量 1 のみを選択できます。
- さらに構成が必要なため、UCSX-210C-M7 -NEW ATO ステータスが「無効」になっていることに注意してください。
- Configurator を入力するために、[オプションの編集 (Edit Option)] をクリックします。

注： 少なくとも 5 つの有料サーバーと 1 つの無料サーバーの構成は同じである必要があります。

ステップ 12.

UCSX Modular Server

UCSX-210C-M7-NEW

CPU

Memory

Drives

Product Configuration
UCSX-210C-M7-NEW part of UCSX-M7-XDIRECTXCC Estimated Lead Time 21 days Price List Global Price List in US Dollars (USD) 0.00

⚠️ 1: A selection from Infrastructure and Workload is required. Please adjust the selections. (CE200277)
2: A selection of either UCSX-ML-V5Q50G-D or UCSX-ML-V5D200G-D or UCSX-MLV5D200GV2D from Rear MEZZ - MLOM/PCI is required. P
3: At least 1 selection(s) from Processor 4th Gen or Processor 5th Gen is required. Please make the selection. (CE200375)
4: Please note that this order will be placed on a Compliance Hold. Please reach out to sac-support@cisco.com to check if this order meets eligibility criteria for hold removal. Note that the order will remain on compliance hold if you do not reach out to sac-support@cisco.com to request eligibility check. (CE202322)

Configuration Summary View Full Summary

Category	Qty	Extended List Price (USD)
Processor 4th Gen		
Processor 5th Gen		
Memory 4800		
Memory 5600		
Front MEZZ - Controller		
Rear MEZZ - MLOM/PCI		
Storage Drives		
SATA M.2		
NVMe Boot		
Total		0.00
Estimated Lead Time		21 days

Option Search Multiple Options Search

UCSX-210C-M7-NEW > Processor 4th Gen

8000 Processor Series 4th Gen | 6000 Processor Series 4th Gen | 5000 Processor Series 4th Gen | 4000 Processor Series 4th Gen | 3000 Processor Series 4th Gen

SKU	Qty	Estimated Lead Time	Unit List Price (USD)
<input type="radio"/> UCSX-CPU-I8452Y Intel I8452Y 2GHz/300W 36C/67.5MB DDR5 4800MT/s	Qty	21 days	0.00
<input type="radio"/> UCSX-CPU-I8454H Intel I8454H 2.1GHz/270W 32C/82.5MB DDR5 4800MT/s	Qty	21 days	0.00
<input type="radio"/> UCSX-CPU-I8458P Intel I8458P 2.7GHz/350W 44C/82.5MB DDR5 4800MT/s	Qty	21 days	0.00
<input type="radio"/> UCSX-CPU-I8460H Intel I8460H 2.2GHz/330W 40C/105MB DDR5 4800MT/s	Qty	21 days	0.00
<input type="radio"/> UCSX-CPU-I8460Y+ Intel I8460Y+ 2GHz/300W 40C/105MB DDR5 4800MT/s	Qty	21 days	0.00

Reset Configuration Cancel Done

- 左側のカテゴリ ウィンドウから周辺機器を選択して、UCSX-210C-M7-NEW を構成します。
- PID は右側のウィンドウにリストされます。メモリやストレージ ドライブなどの一部の PID はタイプまたはシリーズに従ってグループ化されます。右側の SKU ウィンドウの上にあるグループ化されたオプションから選択します。
- 警告メッセージに従って、最低限必要なオプション PID を構成します。
- 完了したら [完了 (Done)] をクリックします。

ステップ 13.

UCSX Modular Server

UCSX-210C-M7-NEW

➔

Services/Subscriptions

Bundle Configuration UCSX-M7-XDIRECTXCC	Estimated Lead Time 35 days	Price List Global Price List (USD)	Total 477,633.16
--	--------------------------------	---------------------------------------	---------------------

Set service preferences for this configuration Cancel Done

⚠ 1: CISCO INTERSIGHT requires a minimum of 1 component(s). Please add additional quantities as necessary. (CE100010)

2: The category CISCO INTERSIGHT is required. (CE100103)

3: Please note that you are using a promotional PID which is available ONLY IF qualified for the 'UCS X-Series X-Direct Xccelerate' Program. For details on the program, PIs review Sales Connect, contact your Cisco Account Manager or reach out to ask-ucsx@external.cisco.com. We encourage you NOT to book this PID if you do not qualify. Order will be on hold after booking to check for eligibility. (CE202322)

Available Components	Unit List Price (USD)	UCSX 9500 CHASSIS > 1 Selected (Min 1, Max 1)	Unit List Price (USD)	Adjusted List Price (USD)	Qty	Extended List Price (USD)
UCSX 9500 CHASSIS		UCSX-9508-FREE Valid ⚠		5,471.88	1	9,608.46
UCSX MODULAR SERVER		UCS 9508 Free Chassis				
UCSX-210C-M7-U UCS X210c M7 Compute Node 2S w/o CPU, Mem, Drv, Mezz 5 required	6,376.38	UCSX MODULAR SERVER > 6 Selected (Min 6, Max 8)				
UCSX-210C-M7-NEW UCS X210c M7 R2L Free Compute Node 2S w/o CPU, Mem, Drv, Mezz 1 required	0.00	UCSX-210C-M7-U Valid		22,003.99	5	466,945.70
		UCS X210c M7 Compute Node 2S w/o CPU, Mem, Drv, Mezz				
		UCSX-210C-M7-NEW Valid ⚠		1,079.00	1	1,079.00
		UCS X210c M7 R2L Free Compute Node 2S w/o CPU, Mem, Drv, Mezz				

Add a UCSX MODULAR SERVER from the left panel

CISCO INTERSIGHT > 0 Selected (Min 1, Max 1)

- a. ステータスには現在、[有効 (Valid)] として表示されています。
- b. [サービス/サブスクリプションの編集 (Edit Services/Subscriptions)] をクリックして、ハードウェア サポートの期間を編集します。

注： ハードウェア サポートの期間は、ソフトウェア サブスクリプション期間と一致させることをお勧めします。

ステップ 14.

UCSX Modular Server

Service Subscription: UCSX-210C-M7-NEW
Price List: Global Price List
Service Total: 3,237.00

Services/Subscriptions

You may receive additional discounts because you selected two or more years of service. To review your discounts you can go to the Order or Quoting discount pages. (C0124)

Service: Non Serviceable Products

The duration that you entered has been successfully applied to all the services. (C0329)

Service Options

Choose Service Level from: All Service Programs

Search by Name & Description

Note: Cisco may still install another compatible service if required. Compatible services are the services that come with primary service and are based on products.

Time Duration: Duration (36) Delay service start to Co-Term service to

Buttons: Reset, Apply

Service SKU	Product SKU	Unit List Price (USD)	Qty	Total List Price (USD)
Cisco Customer Experience Level 1 (1 ITEM) SERVICE PROGRAM	L1NCO (CX LEVEL 1 8X7XNCDOS) SUMMARY		36 Months	
CON-L1NCO-UCSX221C CX LEVEL 1 8X7XNCDOS UCS X210c M7 Compute N...	UCSX-210C-M7-NEW UCS X210c M7 R2L Free Compute Node 2S w/o CPU, ...	3,237.00	1	3,237.00

Buttons: Remove All Services, Remove All Additional Services

Configuration Summary: All prices shown in USD
Services: 3,237.00

Buttons: Cancel, Done

- [期間 (Term Duration)] を入力します。
- [適用 (Apply)] をクリックし、[完了 (Done)] をクリックします。

ステップ 15.

Bundle Configuration: UCSX-M7-DIRECTXCC
Estimated Lead Time: 35 days
Total: 479,791.16

Cisco Intersight

Set service preferences for this configuration

1: Please note that Intersight is required selection and needed for the M7 Server to function. All orders with CNL-DESELECT-D will be...
2: Please note that you are using a promotional PID which is available ONLY IF qualified for the 'UCS X-Series X-Direct Xccelerate' Program...
ask-ucsx@external.cisco.com. We encourage you NOT to book this PID if you do not qualify. Order will be on hold after booking to check for eligibility. (CE202322)

1 CNL-DESELECT-D has been added to the bundle category CISCO INTERSIGHT.

Available Components

Component	Unit List Price (USD)
UCSX 9500 CHASSIS	0.00
UCSX MODULAR SERVER	0.00
CISCO INTERSIGHT	0.00
DC-MGT-SAAS Cisco Intersight SaaS	0.00
CNLD-DESELECT-D Conditional Deselect Estimated Lead Time: 7 days	0.00

UCSX 9500 CHASSIS > 1 Selected (Min 1, Max 1)

Product	Unit List Price (USD)	Adjusted List Price (USD)	Qty	Extended List Price (USD)
UCSX-9508-FREE Valid UCS 9508 Free Chassis		5,471.88	1	9,608.46

UCSX MODULAR SERVER > 6 Selected (Min 6, Max 8)

Product	Unit List Price (USD)	Adjusted List Price (USD)	Qty	Extended List Price (USD)
UCSX-210C-M7-U Valid UCS X210c M7 Compute Node 2S w/o CPU, Mem, Drv, Mezz		22,003.99	5	466,945.70
UCSX-210C-M7-NEW Valid UCS X210c M7 R2L Free Compute Node 2S w/o CPU, Mem, Drv, Mezz		3,237.00	1	3,237.00

CISCO INTERSIGHT > 1 Selected (Min 1, Max 1)

Product	Unit List Price (USD)	Adjusted List Price (USD)	Qty	Extended List Price (USD)
CNLD-DESELECT-D Conditional Deselect		0.00	1	0.00

- CNLD-DESELECT-D は、お客様が EA 契約を介して Cisco Intersight ライセンスをすでに購入している場合、または注文が Disti Fulfillment である場合にのみ選択することを意図しています。
- M7 Server が機能するには、Intersight の選択が必要であることに注意してください。CNLD-DESELECT-D を含むすべての注文は、遵守について手動で確認されます。

ステップ 16.

Cisco Intersight

Product Configuration: CNDL-DESELECT-D part of UCSX-M7-XDIRECTXCC | Estimated Lead Time: 7 days | Price List: Global Price List (USD)

Configuration Summary | View Full Summary

Category	Qty	Extended List Price (USD)
Reason Codes		
OPTOUT-DISTI-ONLY	1	0.00

CNDL-DESELECT-D > Reason Codes

Reason Codes

SKU	Qty	Estimated Lead Time	Unit List Price (USD)
<input checked="" type="radio"/> OPTOUT-DISTI-ONLY For Disti when ordering mandatory licenses separately	1	3 days	0.00
<input type="radio"/> OPTOUT-EA-ONLY License not needed: Customer already owns Licenses in an EA	1	3 days	0.00
<input type="radio"/> OPTOUT-ENTL-SWAP License not needed: Entitlements updated in SmartAccount. More	1	3 days	0.00

Clear Selection | Show Incompatible SKUs

Total: 0.00 | Estimated Lead Time: 7 days

Reset Configuration | Cancel | Done

- a. 適切な [理由コード (Reason Code)] を選択してください

ステップ 17.

Bundle Configuration: UCSX-M7-XDIRECTXCC | Estimated Lead Time: 35 days | Price List: Global Price List (USD) | Total: 479,791.16

Get service preferences for this configuration

Available Components | Unit List Price (USD)

- UCSX 9500 CHASSIS: 0.30
- UCSX 210C M7 MODULAR SERVER: 466,945.70
- CISCO INTERSIGHT: 0.00

UCSX 9500 CHASSIS > 1 Selected (Min 1, Max 1)

Product	Unit List Price (USD)	Adjusted List Price (USD)	Qty	Extended List Price (USD)
UCSX-9508-FREE Valid		5,471.88	1	9,608.46

UCSX MODULAR SERVER > 6 Selected (Min 6, Max 8)

Product	Unit List Price (USD)	Adjusted List Price (USD)	Qty	Extended List Price (USD)
UCSX-210C-M7-U Valid		22,003.99	5	466,945.70
UCSX-210C-M7-NEW Valid		3,237.00	1	3,237.00

CISCO INTERSIGHT > 1 Selected (Min 1, Max 1)

Product	Unit List Price (USD)	Adjusted List Price (USD)	Qty	Extended List Price (USD)
CNDL-DESELECT-D Valid		0.00	1	0.00

Cancel | Done

- a. 各製品のステータスが [有効 (Valid)] であり、警告メッセージがなくなると MLB の構成が完了します。
- b. 「PLUS」をクリックして、展開して、各製品に行った選択を表示します。
- c. MLB 構成を完了するために、[完了 (Done)] をクリックします。

翻訳について

このドキュメントは、米国シスコ発行ドキュメントの参考和訳です。リンク情報につきましては、日本語版掲載時点で、英語版にアップデートがあり、リンク先のページが移動/変更されている場合がありますことをご了承ください。あくまでも参考和訳となりますので、正式な内容については米国サイトのドキュメントを参照ください。