



UCC 5G UPF Configuration and Administration Guide, Release 2024.02

First Published: 2024-04-30

Americas Headquarters

Cisco Systems, Inc.
170 West Tasman Drive
San Jose, CA 95134-1706
USA
<http://www.cisco.com>
Tel: 408 526-4000
800 553-NETS (6387)
Fax: 408 527-0883

THE SPECIFICATIONS AND INFORMATION REGARDING THE PRODUCTS IN THIS MANUAL ARE SUBJECT TO CHANGE WITHOUT NOTICE. ALL STATEMENTS, INFORMATION, AND RECOMMENDATIONS IN THIS MANUAL ARE BELIEVED TO BE ACCURATE BUT ARE PRESENTED WITHOUT WARRANTY OF ANY KIND, EXPRESS OR IMPLIED. USERS MUST TAKE FULL RESPONSIBILITY FOR THEIR APPLICATION OF ANY PRODUCTS.

THE SOFTWARE LICENSE AND LIMITED WARRANTY FOR THE ACCOMPANYING PRODUCT ARE SET FORTH IN THE INFORMATION PACKET THAT SHIPPED WITH THE PRODUCT AND ARE INCORPORATED HEREIN BY THIS REFERENCE. IF YOU ARE UNABLE TO LOCATE THE SOFTWARE LICENSE OR LIMITED WARRANTY, CONTACT YOUR CISCO REPRESENTATIVE FOR A COPY.

The Cisco implementation of TCP header compression is an adaptation of a program developed by the University of California, Berkeley (UCB) as part of UCB's public domain version of the UNIX operating system. All rights reserved. Copyright © 1981, Regents of the University of California.

NOTWITHSTANDING ANY OTHER WARRANTY HEREIN, ALL DOCUMENT FILES AND SOFTWARE OF THESE SUPPLIERS ARE PROVIDED "AS IS" WITH ALL FAULTS. CISCO AND THE ABOVE-NAMED SUPPLIERS DISCLAIM ALL WARRANTIES, EXPRESSED OR IMPLIED, INCLUDING, WITHOUT LIMITATION, THOSE OF MERCHANTABILITY, FITNESS FOR A PARTICULAR PURPOSE AND NON-INFRINGEMENT OR ARISING FROM A COURSE OF DEALING, USAGE, OR TRADE PRACTICE.

IN NO EVENT SHALL CISCO OR ITS SUPPLIERS BE LIABLE FOR ANY INDIRECT, SPECIAL, CONSEQUENTIAL, OR INCIDENTAL DAMAGES, INCLUDING, WITHOUT LIMITATION, LOST PROFITS OR LOSS OR DAMAGE TO DATA ARISING OUT OF THE USE OR INABILITY TO USE THIS MANUAL, EVEN IF CISCO OR ITS SUPPLIERS HAVE BEEN ADVISED OF THE POSSIBILITY OF SUCH DAMAGES.

Any Internet Protocol (IP) addresses and phone numbers used in this document are not intended to be actual addresses and phone numbers. Any examples, command display output, network topology diagrams, and other figures included in the document are shown for illustrative purposes only. Any use of actual IP addresses or phone numbers in illustrative content is unintentional and coincidental.

All printed copies and duplicate soft copies of this document are considered uncontrolled. See the current online version for the latest version.

Cisco has more than 200 offices worldwide. Addresses and phone numbers are listed on the Cisco website at www.cisco.com/go/offices.

Cisco and the Cisco logo are trademarks or registered trademarks of Cisco and/or its affiliates in the U.S. and other countries. To view a list of Cisco trademarks, go to this URL: <https://www.cisco.com/c/en/us/about/legal/trademarks.html>. Third-party trademarks mentioned are the property of their respective owners. The use of the word partner does not imply a partnership relationship between Cisco and any other company. (1721R)

© 2024 Cisco Systems, Inc. All rights reserved.



CONTENTS

Full Cisco Trademarks with Software License ?

PREFACE

About this Guide xxxiii

Conventions Used xxxiii

CHAPTER 1

5G Architecture 1

Feature Summary and Revision History 1

Summary Data 1

Revision History 1

Overview 2

Control Plane Network Functions 2

User Plane Network Function 3

Subscriber Microservices Infrastructure Architecture 3

Control Plane Network Function Architecture 5

CHAPTER 2

5G-UPF Overview 9

Feature Summary and Revision History 9

Summary Data 9

Revision History 9

Product Description 10

Use Cases and Features 10

Configuration and Deployment Requirement for UPF 10

Anchor Point for Intra-RAT and Inter-RAT Mobility 11

External PDU Session Point of Interconnect to Data Network 11

Packet Inspection 12

User Plane Part of Policy Rule Enforcement 12

Lawful Intercept	12
Traffic Usage Reporting (Charging)	12
QoS Handling for User Plane	13
Downlink Packet Buffering and Data Notification Triggering	13
Forwarding End Markers to the Source NG-RAN Node	13
MVNO Support	13
Deployment Architecture and Interfaces	14
UPF Architecture	14
UPF Deployment Architecture	14
VM Deployment	15
Supported Interfaces	17
License Information	17
Standards Compliance	18
<hr/>	
PART I	Features and Functionality 19
<hr/>	
CHAPTER 3	1:1 Redundancy 21
Feature Summary and Revision History	21
Summary Data	21
Revision History	21
Feature Description	22
How it Works	22
Configuring 1:1 UPF Redundancy	28
Configuring BFD Monitoring Between Active UPF and Standby UPF	29
Configuring BGP Status Monitoring Between Each UPF and Next-Hop Router	29
Configuring Sx/N4 Monitoring on the Active UPF and Standby UPF	30
Configuring VPP Monitor on Active UPF and Standby UPF	31
Preventing User Plane Function Switchback	32
Preventing Dual Active Error Scenarios	33
Resetting Sx/N4 Monitor Failure	33
Changing UPF State from Pending-Active to Active	33
Monitoring and Troubleshooting	33
Show Command(s) and/or Outputs	33
show srp monitor bfd	33

show srp monitor bgp	34
show srp monitor sx	35
show srp monitor vpp	35
show srp statistics	36
L2 ICSR Support	36
Feature Description	36
SRP Loopback Interface	37
How it Works	37
State Machine	38
Configuring L2 ICSR in SRP Context	39
Configuring C-C and C-R BFD from Primary and Backup Chassis	39
Verifying L2 ICSR Configuration	39
OAM Support	41
Show Command Support	41

CHAPTER 4

ADC for Dynamic Rules	43
Feature Description	43
How it Works	43
OAM Support	44
Show Command Output	44
show subscribers user-plane-only full all	44
show subscribers user-plane-only callid callid pdr full all	46

CHAPTER 5

APN ACL Support	51
Feature Summary and Revision History	51
Summary Data	51
Revision History	51
Feature Description	52
Rule(s)	52
Actions	52
Criteria	53
Rule Order	53
Limitations	54
Configuring ACL	54

Verifying ACL Configuration 54
 IP Source Violation 55
 Gating Control 55

CHAPTER 6

APN AMBR Traffic Policing 57

Feature Summary and Revision History 57
 Summary Data 57
 Revision History 57
 Feature Description 58
 Limitations 58
 Configuring the APN AMBR Traffic Policing Feature 58
 Monitoring and Troubleshooting 59
 Show Commands and/or Outputs 59

CHAPTER 7

Bulk Statistics Support 61

Feature Summary and Revision History 61
 Summary Data 61
 Revision History 62
 Feature Description 62

CHAPTER 8

Charging Support 65

Feature Summary and Revision History 65
 Summary Data 65
 Revision History 65
 Feature Description 66
 Offline Charging Events Reporting over N4 66
 Online Charging Support over N4 66
 How it Works 67
 Call Flows 67
 PFCP Session Establishment Procedure 67
 PFCP Session Modification Procedure 68
 PFCP Session Reporting Procedure 69
 PFCP Session Deletion Procedure 69
 IEs Supported for Offline Charging Reporting 70

IEs Supported for Online Charging Reporting	71
Usage Reporting in PFCP Modification Response	73
Usage Reporting for Online and Offline Charging	73
Usage Reporting with Rating-Group and Service ID	73
Implementing the QAURR Flag	74
Supported Functionality and Limitations	74
PTT no-quota Limited Pass	75
PTT quota exhaust Limited Pass	76
Tariff Time Support	77
TCP Maximum Segment Size	77
Configuring Credit Control for Usage Reporting	77
Configuring ACS Rulebase for Usage Reporting	78
Monitoring and Troubleshooting	80
Show Commands and/or Outputs	80
show-user-plane-service statistics rulebase name <name>	80

CHAPTER 9

Cisco Ultra Traffic Optimization with VPP	81
Feature Summary and Revision History	81
Summary Data	81
Revision History	81
Feature Description	82
RCM Support	82
Sending the GBR or MBR Values to Cisco Ultra Traffic Optimization	83
Cisco Ultra Traffic Optimization Library Deinitialization	83
How it Works	83
Architecture	83
Limitations	85
Show Commands and Outputs	85
Show Commands and Outputs	85
Bulkstats	87
Sample Configuration	89

CHAPTER 10

Collection and Reporting of Usage Data over N4 Interface	91
Feature Summary and Revision History	91

- Summary Data 91
- Revision History 91
- Feature Description 92
- How it Works 92
 - Standards Compliance 93
- Configuration to Collect and Report Volume Measurement over N4 Interface 93
 - Configuring Charging Action for a Required Billing Action 93
 - Associating a Charging Action with a Rulebase 93

CHAPTER 11 Control Plane-Initiated N4 Association Support 95

- Feature Summary and Revision History 95
 - Summary Data 95
 - Revision History 95
- Feature Description 96
 - SMF initiated N4 Association Setup Procedure 96
- How it Works 96
 - Call Flows 96
 - Session Management Function Initiated N4 Association Setup Procedure 96
- Configuring the CP-Initiated N4 Association Setup Feature 96
 - CP-Initiated N4 Association Setup Feature OAM Support 97
 - Show Command Support 97

CHAPTER 12 Converged Datapath 99

- Feature Summary and Revision History 99
 - Summary Data 99
 - Revision History 99
- Feature Description 100
 - Architecture 100
- How it Works 101
 - SxDemuxMgr 101
 - SessMgr 101
 - Datapath 101
 - Charging 101
 - Call Flows 101

Initial Attach with SGW-C/cnSGW and SMF/IWF	102
5G to 4G Handover with Collapsed UPF	103
Intra S-GW Handover with Collapsed UPF	105
Idle/Active DDN Handling with Collapsed UPF	106
IDFT Handling during S1 Handover	107
S-GW Relocation with Same SGW-U	108
WiFi to LTE Handover	110
Limitations	112
Charging for Converged Calls	113
Feature Description	113
How it Works	113
Limitations	114
Configuring eGCDR	114
Configuring GTPP Group	115
Generating Usage Report with Volume Count for Converged Sxa Calls	115
Configuration Example	115
Configuring Converged Datapath	115
Enabling Converged Datapath at UPF	115
Configuring Remote Peers for Sxa and N4	116
Configuring User Plane Service for Sxa and N4	116
Monitoring and Troubleshooting	116
Show Commands and/or Outputs	116
show subscribers user-plane-only all	116
show subscribers user-plane-only full all	117
show user-plane-service statistics all	117

CHAPTER 13

Deep Packet Inspection and Inline Services	119
Feature Summary and Revision History	119
Summary Data	119
Revision History	119
Feature Description	120
DNS Server Readdressing	120
How it Works	122
DSCP Marking for Downlink and Uplink Packets	122

Transport Level Marking IE	122
Transport Level Marking Options IE	122
Inner Packet Marking IE	123
Traffic Readdressing or Redirecting	124
Redirect Information IE	124
Supported Inline Services	125
Application Detection and Control	125
QUIC IETF Implementation	125
Configuring QUIC IETF	125
Statistics	126
Content Filtering	126
DNS Snooping	127
Event Data Records	128
Feature Description	128
How It Works	128
Configuring Event Data Records	131
Monitoring and Troubleshooting	133
Firewall Support	134
Feature Description	135
Subscriber Firewall Configuration	135
Monitoring and Troubleshooting	137
Flow Idle Timeout Randomization	139
Configuring Flow Idle Timeout Randomization in ACS	139
HTTP URL Filtering	140
IP Readdressing	142
Configuring IP Readdressing	143
Show Commands	144
L7 Protocol	144
DNS	145
FTP	145
HTTP	145
HTTPS	147
RTP/RTSP	148
SIP	148

Monitoring and Troubleshooting	148
NAT Support on N4	149
Feature Description	149
Configuring NAT	150
Monitoring and Troubleshooting	152
Tethering Detection	156
Feature Description	156
Configuring Tethering Support	156
Monitoring and Troubleshooting	157
RTP Dynamic Flow Detection	158
Rule-matching for Bearer-specific Filters	159
URL Blockedlisting	160
Feature Description	160
How it Works	160
Configuring URL Blockedlisting	161
Monitoring and Troubleshooting	162
Configuring the Static and Pre-Defined Rules	164
Configuring ACS Ruledef for L7 Protocols for DPI	165
Charging Action Configuration for L7 Protocols for DPI	167

CHAPTER 14

Device ID in EDNS0 Records	171
Feature Summary and Revision History	171
Summary Data	171
Revision History	171
Feature Description	172
How it Works	172
Process Flow	173
EDNS0 Packet Format	173
EDNS0 with IP Readdressing	174
Behavior and Restrictions	174
Limitation	175
Configuring EDNS Format and Trigger Action	175
Sample Configuration	177
Monitoring and Troubleshooting	177

Show Commands and Outputs 178

Bulk Statistics 179

CHAPTER 15

Downlink Data Notification 181

Feature Summary and Revision History 181

Summary Data 181

Revision History 181

Feature Description 182

How It Works 182

Downlink Data Notification – Delay (DDN-D) Support 182

5G SMF Calls 183

DDN Throttling Support 183

No User Connect Timer Support 184

DDN Call Flows 185

DDN Success Scenario 185

DDN Failure Scenario 186

No User Connect Timer Support 187

DDN Delay Timer 188

Sx Interface 189

Limitations 191

DDN Throttling for non-Release 10 Compliant MME 191

DDN Throttling for Release 10 Compliant MME 193

Idle Timer for SAE-GW Sessions 194

Limitations 194

Configuring Idle Timer for SAE-GW Sessions 194

S-GW Session Idle Timeout 195

Configuring Session Idle Timeout 195

Show Commands Input and/or Outputs 195

show subscribers user-plane-only full all 196

show subscribers user-plane-only full callid <call_id> 196

CHAPTER 16

DSCP Markings For Collapse Calls 197

Feature Summary and Revision History 197

Feature Description 198

DSCP Markings for 5G Calls	198
DSCP Markings for 4G Collapsed Datapath Calls	198
How It Works	198
SessMgr SMF Changes	199
Configuration	201
Monitoring and Troubleshooting	202
Show Commands Outputs	202

CHAPTER 17
Dynamic and Static PCC Rules 203

Feature Summary and Revision History	203
Summary Data	203
Revision History	204
Feature Description	204
How it Works	204
Predefined PCC Rules Support	204
Provisioning of Predefined PCC Rules	204
Dynamic PCC Rules Support	205
Policing	206
Bandwidth Policy Configuration Limits	208
Rate Limiting for Static and Predefined Rules	208
Rate Limiting for Dynamic Rules	209
Standards Compliance	210
Configuring the URR IDs	210
Threshold Configuration	211

CHAPTER 18
ECS Regular Expression 213

Feature Summary and Revision History	213
Summary Data	213
Revision History	213
Feature Description	214
How It Works	214
Configuring Regex Rule	215
Sample Configuration	216
Monitoring and Troubleshooting	216

Show Commands and Outputs 216

CHAPTER 19

GTP-U Support 217

- Feature Summary and Revision History 217
 - Summary Data 217
 - Revision History 217
- Feature Description 218
- How it Works 219
 - Call Flows 219
 - Initial Attach on E-UTRAN via MME and S-GW 219
 - 5G to EPS Handover with N26 Interface 220
 - Error Indication Handling on UPF 221
 - GTP-U Path Failure Support at UPF 221
- Enabling Dual Stack Support on S5u/N3 Interface 222
- Disabling UDP Checksum 222
 - Disabling UDP Checksum 222

CHAPTER 20

Heartbeat Support for N4/Sx Interface 223

- Feature Summary and Revision History 223
 - Summary Data 223
 - Revision History 223
- Feature Description 224
- How It Works 224
 - Path Failure Detection 224
 - Path Failure Handling 225
- Configuring Heartbeat for N4/Sx Interface 225
 - Enabling Heartbeat for Sx Interface 225
 - Configuring Detection Policy for Path Failure 226
- Monitoring and Troubleshooting 226
 - Show Command(s) and/or Outputs 226
 - show sx-service all 226
 - show sx-service statistics all 227
 - Disconnect Reasons 227
 - SNMP Traps 227

CHAPTER 21**Idle Mode Buffering and Paging 229**

- Feature Summary and Revision History 229
 - Summary Data 229
 - Revision History 229
- Feature Description 230
 - How it Works 230
 - Provisioning of Buffering Action Rule in the UPF 230
- Buffering Action Rule Call Flow 230
- Downlink Data Report for First DL Packet 231
- Paging Policy Differentiation 231
 - Paging Policy Indicator (PPI) 231
 - Frame Format for the PDU Session User Plane Protocol 232
 - QoS Flow Identifier (QFI) 232
 - Paging Policy Presence 232
 - Paging Policy Indicator 232

CHAPTER 22**Indirect Forwarding Tunnel 233**

- Revision History 233
- Feature Description 233
- How It Works 233
 - Call Flow 233
 - Supported Functionality 236
 - Limitations 236
- Configuring Indirect Forwarding Tunnel 236
 - Enabling Indirect Forwarding Tunnel Feature 237
 - Verifying the Indirect Forwarding Tunnel Feature 237
 - show sgw-service name <service_name> 237
- Monitoring and Troubleshooting 237
 - Show Commands Input and/or Outputs 237
 - show subscribers saegw-only full all 237
 - show subscribers user-plane-only callid <call_id> pdr all 237
 - show subscribers user-plane-only full all 238

CHAPTER 23	IPsec Support for IPv6	239
	Feature Summary and Revision History	239
	Summary Data	239
	Revision History	239
	Feature Description	240
	IPsec AH and ESP	240
	IPsec Transport and Tunnel Mode	240
	IPsec Terminology	240
	Crypto Access Control List	240
	Transform Set	241
	ISAKMP Policy	241
	Crypto Map	241
	Crypto Template	241
	Supported Algorithms	241
	Limitations and Restrictions	242
	Example Configurations	242
	Monitoring and Troubleshooting	243
	Show Commands	243

CHAPTER 24	LTE - Wi-Fi Seamless Handover	245
	Feature Summary and Revision History	245
	Summary Data	245
	Revision History	245
	Feature Description	245
	How It Works	246
	EPC to Non-3GPP Untrusted Wi-Fi Handover Call Flow	246
	Non-3GPP Untrusted Wi-Fi to EPC Handover Call Flow	249
	ICSR and Session Recovery	252
	Limitations	253
	Standards Compliance	253

CHAPTER 25	Monitor Subscriber	255
	Feature Summary and Revision History	255

Summary Data	255
Revision History	255
Feature Description	256
How It Works	257
SMF and UPF Interactions	257
Subscriber Tracing from SMF	257
Fastpath and Slowpath Packet Captures	261
UPF SessMgr Functionality	262
Multi PDN Multi-trace	262
MonSub Statistics	262
X-Header	263
Configuration Procedure for Monitor Subscriber on UPF	263
Monsub CLI Options	264
Context, CDRMOD, and Hexdump Interaction for Monitor Subscriber	266
PCAP File Name Convention	266
PCAP File Location	268
Limitations	269
Configuring the Hexdump Module for MonSub in UPF	270
Configuring MonSub Poll Timer	270
Configuring MonSub File Name	271
Monitoring and Troubleshooting	272
SNMP Traps	272

CHAPTER 26
MPLS Support on UPF 273

Feature Summary and Revision History	273
Summary Data	273
Revision History	273
Feature Description	274
How it Works	274
MPLS-CE Connected to PE	275
Sample Configuration	276
VPN-related CLI Commands	278
Monitoring and Troubleshooting	281
Show Commands and Outputs	281

show mpls ftm vpp 281

CHAPTER 27

Multiple cnSGW Support 283

Feature Summary and Revision History 283

Summary Data 283

Revision History 283

Feature Description 284

How it Works 284

Configuring Multiple SMF/cnSGWs 284

Configuring Multiple SMF/cnSGWs on UPF 285

Monitoring and Troubleshooting 285

Show Commands and/or Outputs 285

show subscribers user-plane-only full all 285

show sx peers 285

CHAPTER 28

Multiple N4/Sx Interfaces 287

Feature Summary and Revision History 287

Summary Data 287

Revision History 287

Feature Description 288

How it Works 288

Configuring Multiple N4/Sx Interfaces 289

Configuring Multiple Peer Nodes 289

Monitoring and Troubleshooting 290

Show Commands and/or Outputs 290

show ip chunks 290

show ipv6 chunks 290

show subscribers user-plane-only full all 290

show sx peers 290

show user-plane-service statistics peer-address <address> 290

CHAPTER 29

NextHop Forwarding Support 291

Revision History 291

Feature Description 291

How It Works	291
Architecture	291
Limitations	296
Configuring Next Hop Forwarding Support	296
Configuring Next Hop Forwarding Through Charging Action	296
Configuring Next Hop Forwarding Through DNN Profile	297
Configuring Next Hop Forwarding at IP Pool Through IPAM Profile for IPv4 Addresses	297
Configuring Next Hop Forwarding at IP Pool Through IPAM Profile for IPv6 Addresses	298
Configuration Example	299
VLAN Segmentation Using Next Hop Forwarding	300
Feature Description	300
How it Works	301
Enabling VLAN Segmentation Using Next Hop Forwarding	301
Configuration Example	301
Configuring Network Reachability Server on UPF	302
Configuration Example	303
OAM Support	303
Monitoring Support	303
Monitoring and Troubleshooting	304
Show Commands and Outputs	305

CHAPTER 30 **N:M Redundancy and Redundancy Configuration Manager** **307**

Feature Summary and Revision History	307
Summary Data	307
Revision History	307
Feature Description	308

CHAPTER 31 **N3 Transfer of PDU Session Information** **309**

Feature Summary and Revision History	309
Summary Data	309
Revision History	309
Feature Description	309
How it Works	310
Transfer of PDU Session Information for Downlink Data Packets	310

Transfer of PDU Session Information for Uplink Data Packets	310
PDU Session Information Frame IEs	311
Standards Compliance	312
Limitations	312

CHAPTER 32	N4 Interface Compliance with 3GPP Specification	313
	Feature Summary and Revision History	313
	Summary Data	313
	Revision History	313
	Feature Description	314
	Averaging Window	314
	Paging Policy Indicator	314
	Outer Header Creation	315
	Outer Header Removal	316

CHAPTER 33	N4 Interface Configuration	319
	Feature Summary and Revision History	319
	Summary Data	319
	Revision History	319
	Feature Description	320
	Configuring N4 Interface	320
	Identifying an N4 Interface	320
	Modification of N4-type Parameters in an Sx Service	320
	Statistics	321
	show control-plane-group	321
	show sx-service all	321
	show subscribers user-plane-only all	321
	show user-plane-service statistics all	321
	show subscribers user-plane-only seid number pdr all	321
	show subscribers user-plane-only callid number pdr full all	322

CHAPTER 34	N4/Sx over IPSec	323
	Feature Summary and Revision History	323
	Summary Data	323

Revision History	323
Feature Description	324
Recommended Timers	325
Recommended Configurations	326
Example Configurations in SMF	327
Example Router Configurations	330
Example Configurations in UPF	331
Example SRP Configurations	332
Sample Configurations	332
Monitoring and Troubleshooting	335

CHAPTER 35**N4 Session Management, Node Level, and Reporting Procedures 337**

Feature Summary and Revision History	337
Summary Data	337
Revision History	337
Feature Description	338
N4 Session Management, Node Level, and Reporting Procedures	338
N4 Node-level Procedures	338
N4 Session Management	338
N4 Session/Node-level Reporting Procedures	338
Relationships	338
End Marker Support	339
UEs IPv4, IPv6, and IPv4v6 Support	339
How it Works	339
N4 Node-level Procedure Call Flows	339
N4 Association Setup Procedure Call Flow	339
N4 Association Update Procedure Call Flow	340
N4 Association Release Procedure Call Flow	340
N4 Heartbeat Procedure	341
N4 Session Management Procedures Call Flows	341
N4 Session Establishment Call Flow	341
N4 Session Modification Call Flow	342
N4 Session Delete Call Flow	343
N4 Session/Node Level Reporting Procedure Call Flows	343

Session Level Reporting Due to the GTP-u Error Indication Call Flow	343
Node-level Reporting Procedure due to GTP-u Path Failure Call Flow	344
PDN Update Procedure - eNodeB F-TEIDu	346
UEs IPv4, IPv6, and IPv4v6 Support Call Flows	347
N4 Session Establishment and Modification Procedure for IPv6 Call Flow	347
N4 Session Establishment and Modification Procedure for IPv4v6 Call Flow	348
Configuring the N4 Session/Node Level Reporting Procedures	349
Enabling the GTP-u Echo Request Procedure	349
Verifying the N4 Session/Node Level Reporting Procedure Configuration	350
N4 Session Node Level Reporting Procedure OA and M Support	350
SNMP Traps	352

CHAPTER 36**NRF Support 353**

Feature Summary and Revision History	353
Summary Data	353
Revision History	353
Feature Description	354
NRF Management Services	354
How it Works	355
UPF Registration	355
UPF Heartbeat	355
UPF DeRegistration	355
Standards Compliance	355
Configuring NRF Management Services	355
Monitoring and Troubleshooting	357
Show Commands and/or Outputs	357

CHAPTER 37**Password Expiration Notification 359**

Feature Summary and Revision History	359
Summary Data	359
Revision History	359
Feature Description	360
Upgrading and Downgrading Procedures using Save Configuration Command	361

CHAPTER 38**QCI 80 Support on UPF 363**

Feature Summary and Revision History 363

Summary Data 363

Revision History 363

Feature Description 364

How it Works 364

Dynamic QoS Flow Establishment based on Detected Traffic 364

Call Flow 364

Limitations 366

Configuring ADC Rule 366

Monitoring and Troubleshooting 367

CHAPTER 39**QoS Group of Ruledefs Support 369**

Feature Summary and Revision History 369

Summary Data 369

Revision History 369

Feature Description 370

How it Works 370

Limitations 372

OAM Support 372

Show Commands Support 372

show subscribers user-plane-only callid call_id far full all 372

show subscribers user-plane-only callid call_id qer full all 373

show subscribers user-plane-only callid call_id qos-group all 373

show subscribers user-plane-only callid call_id qos-group statistics 373

show subscribers user-plane-only full all 374

show user-plane-service qos-group-of-ruledefs 375

show user-plane-service statistics qos-group sessmgr 375

CHAPTER 40**Roaming Support 377**

Feature Summary 377

Summary Data 377

Revision History 377

- Feature Description 378
 - Relationships 378
 - Architecture 379
 - Inter-PLMN Mobility Support 380
- How it Works 381
 - Standards Compliance 397
 - Limitations 397
- Configuring the HR Roaming Support for UPF 398
 - Roaming Status in Sub-Params IE 399
 - Source Interface Type IE 400
- Monitoring and Troubleshooting 400
 - show user-plane-service statistics all 400
 - show subscribers user-plane-only full all 401
 - show subscribers user-plane-only callid pdr full all 401
 - show user-plane-service gtpu statistics gtpu-service n9-egress 402
 - show user-plane-service gtpu statistics gtpu-service n9-ingress 404

CHAPTER 41

Security Group Tag Support 407

- Feature Summary and Revision History 407
 - Summary Data 407
 - Revision History 407
- Feature Description 408
- How it Works 408
 - Call Flow 408
 - Limitations 408
- Monitoring and Troubleshooting 409
 - Show Commands and Outputs 409

CHAPTER 42

Session Recovery 411

- Feature Summary and Revision History 411
 - Summary Data 411
 - Revision History 411
- Feature Description 411
- How it Works 412

Configuring the System to Support Session Recovery	412
Enabling Session Recovery	412
Enabling Session Recovery on an Out-of-Service System	412
Enabling Session Recovery on an In-Service System	413
Disabling the Session Recovery Feature	414
Viewing Session Recovery Status	414
Viewing Recreated Session Information	415

CHAPTER 43
Session Report Rejection Procedure 417

Feature Summary and Revision History	417
Summary Data	417
Revision History	417
Feature Description	417
Relationships to Other Features	418
Call Flow	418
OAM Support	419
Show Command(s) and/or Output(s)	419

CHAPTER 44
Smart Licensing 421

Feature Summary and Revision History	421
Summary Data	421
Revision History	421
Overview	422
Cisco Smart Software Manager	423
Smart Accounts/Virtual Accounts	423
Smart Licensing Mode	423
Request a Cisco Smart Account	423
Software Tags and Entitlement Tags	424
Configuring Smart Licensing	426
Monitoring and Troubleshooting Smart Licensing	428

CHAPTER 45
Software Management Operations 429

Feature Summary and Revision History	429
Summary Data	429

- Revision History 429
- Overview 430
- SNMP Traps 431
- Limitations 431
- Health Checks 431
- Build Upgrade 433
- UPF Upgrade 435
- UPF Downgrade 435

CHAPTER 46

Standard QCI Support 437

- Feature Summary and Revision History 437
 - Summary Data 437
 - Revision History 437
- Feature Description 437
 - Limitations 438
- Configurations 438

CHAPTER 47

System Logs 439

- Feature Summary and Revision History 439
 - Summary Data 439
 - Revision History 440
- System Log Types 440
- Configuring Event Logging Parameters 441
 - Configuring Event Log Filters 441
 - Exec Mode Filtering 441
 - Global Configuration Mode Filtering 443
 - Configuring Syslog Servers 444
- Configuring Active Logs 446
- Specifying Facilities 447
- Configuring Trace Logging 455
- Configuring Monitor Logs 456
 - Enabling Monitor Logs 456
 - Disabling Monitor Logs 456
- Viewing Logging Configuration and Statistics 456

Viewing Event Logs Using the CLI	457
Configuring and Viewing Crash Logs	458
Crash Logging Architecture	458
Configuring Software Crash Log Destinations	459
Viewing Abridged Crash Log Information Using the CLI	459
Reducing Excessive Event Logging	460
Configuring Log Source Thresholds	461
Checkpointing Logs	462
Saving Log Files	462
Event ID Overview	464
Event Severities	472
Understanding Event ID Information in Logged Output	472

CHAPTER 48

UPF Ingress Interfaces	475
Feature Summary and Revision History	475
Summary Data	475
Revision History	475
Feature Description	476
UPF Ingress Interface Type Configuration	476
Configuring UPF Ingress Interface Type	476
Configuration Example	477
Configuring Echo Response for N9 Interface	477
Separating N3 and N9 BGP Routes	477
Verifying the UPF Ingress Interface Type Configuration	481
show user-plane-service all	481
Multiple GTPU IP Addresses Support	482
Feature Description	482
How it Works	482
Limitations	483
Configuring Multiple Bind Addresses on N3 Interface	483
Configuration Example	484
Configuration Verification	484
OAM Support	485
Monitoring Support	485

CHAPTER 49	UPF Local Configuration	489
	Feature Summary and Revision History	489
	Summary Data	489
	Revision History	489
	Feature Description	490
	How it Works	490
	Configuring the Local Configuration Support for UPF	491

CHAPTER 50	UPF Reporting of Load Control Over N4 Interface	493
	Feature Summary and Revision History	493
	Summary Data	493
	Revision History	493
	Feature Description	493
	Supported IE and Messages	494
	Reporting Load Information to SMF	494
	Configuring the Max Sessions	495
	Show Command Support	495

CHAPTER 51	UPF Usage Monitoring over PCF	497
	Feature Summary and Revision History	497
	Summary Data	497
	Revision History	497
	Feature Description	498
	Usage Reporting	498

CHAPTER 52	Virtual Routing and Forwarding	499
	Feature Summary and Revision History	499
	Revision History	499
	Feature Description	499
	Overlapping IP Pool	500
	VRF Name as Identifier	501
	Limitations and Restrictions	501
	Configuring VRF	502

VLAN Segmentation Using VRF	504
Feature Description	505
Enabling VLAN Segmentation Using VRF	505
Configuration Example	505
Monitoring and Troubleshooting	506
Show Commands and Outputs	506
show ip chunks	506
show ipv6 chunks	507
show ip bgp vpnv4	507
show ip bgp vpnv6	507
show mpls ilm	508
<hr/>	
CHAPTER 53	Voice over New Radio 509
Feature Summary and Revision History	509
Summary Data	509
Revision History	509
Feature Description	510
How it Works	510
VoNR Call Flow for UPF	510
<hr/>	
CHAPTER 54	WPS Prioritization 513
Feature Description	513
How it Works	514
Limitations	516
Configuring WPS Prioritization	516
Enabling WPS Prioritization	516
Mapping the Session Priority Profile	517
OAM Support	517
Show Commands Support	517
show subscribers user-plane-only full all	517
show user-plane-service all	518
show user-plane-service session-priority-profile name all	518
show user-plane-service statistics all	519
show user-plane-service statistics session-priority-profile	519

CHAPTER 55	X-Header Insertion and Encryption	521
	Feature Summary and Revision History	521
	Summary Data	521
	Revision History	521
	Feature Description	522
	How it Works	522
	X-Header Insertion	522
	X-Header Encryption	522
	Limitations	523
	Configuring X-Header Insertion and Encryption	523
	Configuring X-Header Insertion	523
	Configuring X-Header Encryption	524
	Verifying X-header Insertion and Encryption Configuration	525
	Monitoring and Troubleshooting X-Header Insertion and Encryption Configuration	525
	Anti-Spoofing Support	526
	Feature Description	526
	Limitations	526
	Enabling Anti-Spoofing in X-Header	526
	OAM Support	527
PART II	Troubleshooting Information	529
CHAPTER 56	UPF Troubleshooting Information	531
	Debug Logging	531
	Monitoring CLI	532
	Monitoring Protocol	532
	RAT Type-based Statistics	532
	Subscriber Level CLI	537
	show subscribers user-plane-only full msid msid_value	537
	VPP Statistics	542
	show subscribers user-plane-only callid callid_value drop-statistics	543
	show user-plane-service statistics drop-counter	543
	show subscribers user-plane-only callid callid_value flows full	544

show subscribers user-plane-only callid callid_value flows flow-id flow_id	545
SNMP Support	546
Troubleshooting UPF Features	547

PART III **UPF Sample Basic Configuration** 549

CHAPTER 57	Sample UPF Configuration	551
	Sample Configuration	551



About this Guide



Note Control and User Plane Separation (CUPS) represents a significant architectural change in the way StarOS-based products are deployed in the 3G, 4G, and 5G networks. This document provides information on the features and functionality specifically supported by this 5G UPF product deployed in a 5G network. It should not be assumed that features and functionality that have been previously supported in legacy or non-CUPS products are supported by this product. References to any legacy or non-CUPS products or features are for informational purposes only. Furthermore, it should not be assumed that any constructs (including, but not limited to, commands, statistics, attributes, MIB objects, alarms, logs, services) referenced in this document imply functional parity with legacy or non-CUPS products. Please contact your Cisco Account or Support representative for any questions about parity between this product and any legacy or non-CUPS products.



Note The documentation set for this product strives to use bias-free language. For purposes of this documentation set, bias-free is defined as language that does not imply discrimination based on age, disability, gender, racial identity, ethnic identity, sexual orientation, socioeconomic status, and intersectionality. Exceptions may be present in the documentation due to language that is hardcoded in the user interfaces of the product software, language used based on RFP documentation, or language that is used by a referenced third-party product.

This preface describes the *5G User Plane Function Guide*, how it is organized and its document conventions.

This guide describes the Cisco User Plane Function (UPF) and includes infrastructure and interfaces, feature descriptions, specification compliance, session flows, configuration instructions, and CLI commands for monitoring and troubleshooting the system.

- [Conventions Used, on page xxxiii](#)

Conventions Used

The following tables describe the conventions used throughout this documentation.

Notice Type	Description
Information Note	Provides information about important features or instructions.

Notice Type	Description
Caution	Alerts you of potential damage to a program, device, or system.
Warning	Alerts you of potential personal injury or fatality. May also alert you of potential electrical hazards.

Typeface Conventions	Description
Text represented as a <code>screen display</code>	This typeface represents displays that appear on your terminal screen, for example: <code>Login:</code>
Text represented as commands	This typeface represents commands that you enter, for example: show ip access-list This document always gives the full form of a command in lowercase letters. Commands are not case sensitive.
Text represented as a command variable	This typeface represents a variable that is part of a command, for example: show card <i>slot_number</i> <i>slot_number</i> is a variable representing the desired chassis slot number.
Text represented as menu or sub-menu names	This typeface represents menus and sub-menus that you access within a software application, for example: Click the File menu, then click New



CHAPTER 1

5G Architecture

- [Feature Summary and Revision History, on page 1](#)
- [Overview, on page 2](#)
- [Subscriber Microservices Infrastructure Architecture, on page 3](#)
- [Control Plane Network Function Architecture, on page 5](#)

Feature Summary and Revision History

Summary Data

Table 1: Summary Data

Applicable Product(s) or Functional Area	<ul style="list-style-type: none">• PCF• SMF• UPF
Applicable Platform(s)	SMI
Feature Default Setting	Not Applicable
Related Documentation	Not Applicable

Revision History

Table 2: Revision History

Revision Details	Release
First introduced.	Pre-2020.02.0

Overview

The Ultra Cloud Core is Cisco's solution supporting 3GPP's standards for 5G new radio (NR) standalone (SA) mode. These standards define various network functions (NFs) based on the separation of control plane (CP) and user plane (UP) (for example CUPS) functionality for increased network performance and capabilities.

Control Plane Network Functions

The CP-related NFs that comprise the Ultra Cloud Core are based on a common architecture that is designed around the following tenants:

- Cloud-scale—Fully virtualized for simplicity, speed, and flexibility.
- Automation and orchestration—Optimized operations, service creation, and infrastructure.
- Security—Multiple layers of security across the deployment stack from the infrastructure through the NF applications.
- API exposure—Open and extensive for greater visibility, control, and service enablement.
- Access agnostic—Support for heterogeneous network types (for example 5G, 4G, 3G, Wi-Fi, and so on).

These control plane NFs are each designed as containerized applications (for example microservices) for deployment through the Subscriber Microservices Infrastructure (SMI).

The SMI defines the common application layers for functional aspects of the NF such as life-cycle management (LCM), operations and management (OAM), and packaging.

Figure 1: Ultra Cloud Core CP Architectural Components

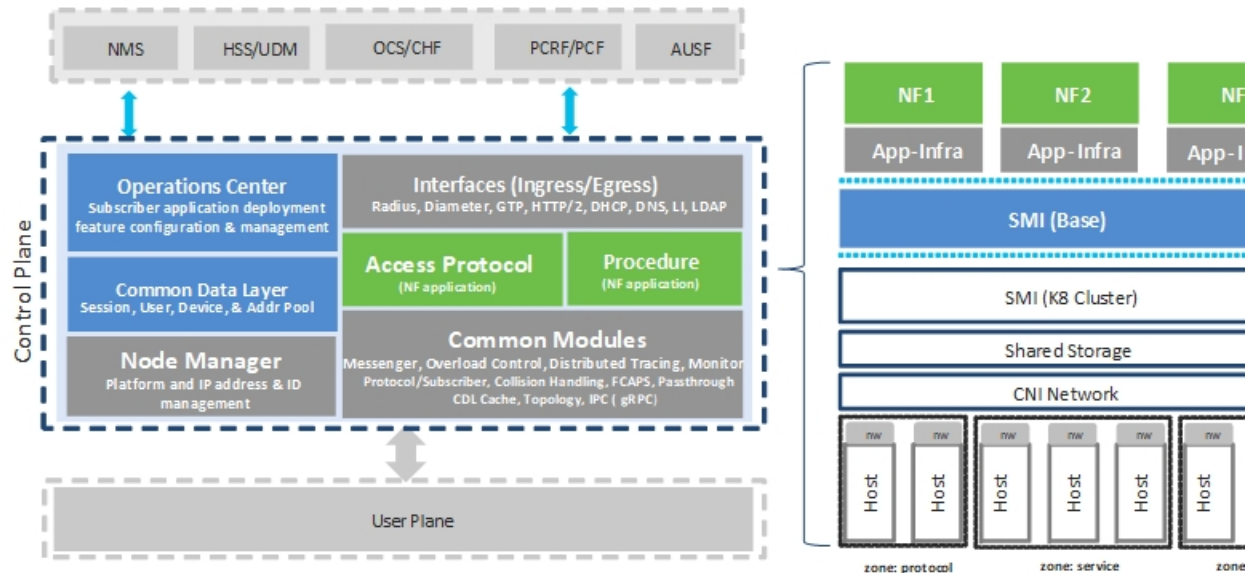

User Plane Network Function

The 5G UP NF within the Ultra Cloud Core is the User Plane Function (UPF). Unlike the CP-related NFs, the 5G UPF leverages the same Vector Packet Processing (VPP) technology currently in use by the user plane component within Cisco 4G CUPS architecture. This commonality ensures the delivery of a consistent set of capabilities between 4G and 5G such as:

- Ultrafast packet forwarding.
- Extensive integrated IP Services such as Subscriber Firewall, Tethering, Deep-Packet Inspection (DPI), Internet Content Adaption Protocol (ICAP), Application Detection and Control (ADC), and header enrichment (HE).
- Integrated third-party applications for traffic and TCP optimization.

Subscriber Microservices Infrastructure Architecture

The Ultra Cloud Core (UCC) Subscriber Microservices Infrastructure (SMI) is a layered stack of cloud technologies that enable the rapid deployment of, and seamless life-cycle operations for microservices-based applications.

The SMI stack consists of the following:

- SMI Cluster Manager—Creates the Kubernetes (K8s) cluster, creates the software repository, and provides ongoing LCM for the cluster including deployment, upgrades, and expansion.

- **Kubernetes Management**—Includes the K8s primary and etcd functions, which provide LCM for the NF applications that are deployed in the cluster. This component also provides cluster health monitoring and resources scheduling.
- **Common Execution Environment (CEE)**—Provides common utilities and OAM functionalities for Cisco Cloud native NFs and applications, including licensing and entitlement functions, configuration management, telemetry and alarm visualization, logging management, and troubleshooting utilities. Also, it provides consistent interaction and experience for all customer touch points and integration points in relation to these tools and deployed applications.
- **Common Data Layer (CDL)**—Provides a high performance, low latency, stateful data store, designed specifically for 5G and subscriber applications. This next generation data store offers high availability in local or geo-redundant deployments.
- **Service Mesh**—Provides sophisticated message routing between application containers, enabling managed interconnectivity, extra security, and the ability to deploy new code and new configurations in low risk manner.
- **NB Streaming**—Provides Northbound Data Streaming service for billing and charging systems.
- **NF or Application Worker Nodes**—The containers that comprise an NF application pod.
- **NF or Application Endpoints (EPs)**—The NFs or applications and their interfaces to other entities on the network
- **Application Programming Interfaces (APIs)**—Provides various APIs for deployment, configuration, and management automation.

The following figure depicts how these components interconnect to comprise a microservice-based NF or application.

Figure 2: SMI Components

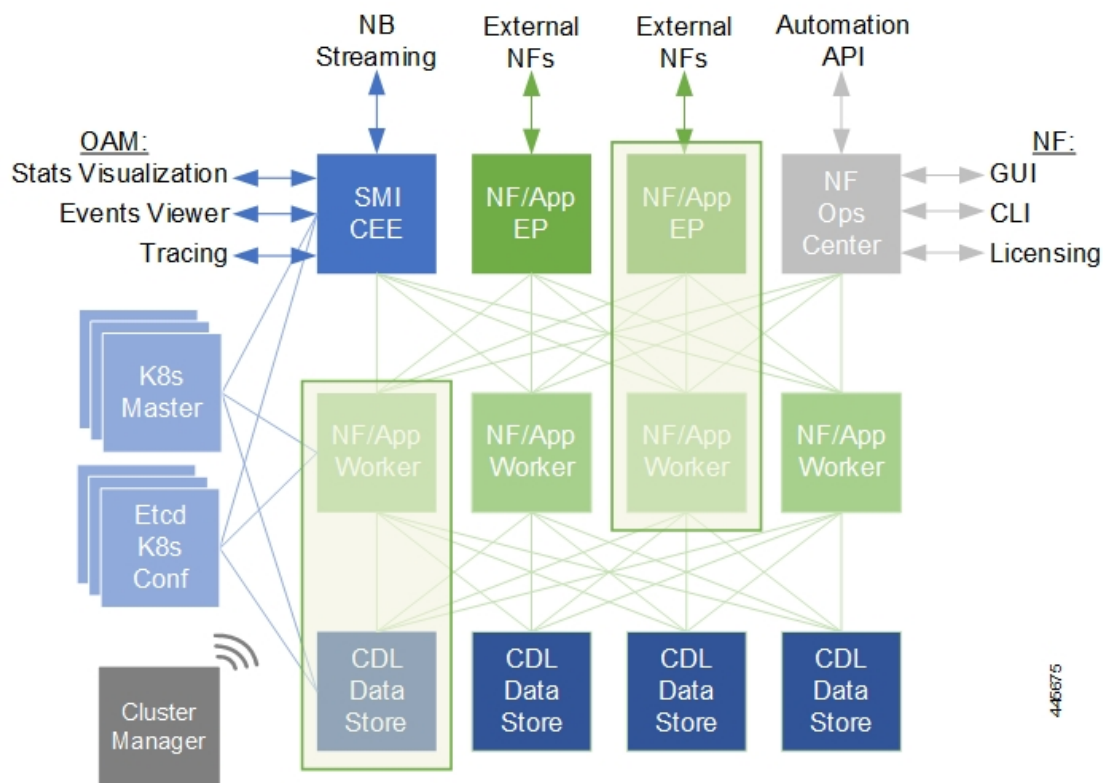

For more information on SMI components, see [Ultra Cloud Core Subscriber Microservices Infrastructure](#) and the related documentation at *Deployment Guide > Overview* chapter.

Control Plane Network Function Architecture

Control plane (CP) NFs are designed around a three-tiered architecture that take advantage of the stateful or stateless capabilities that are afforded within cloud native environments.

The architectural tiers are as follows:

- **Protocol Load Balancer Services**—These are stateless microservices that are primarily responsible for dynamic discovery of application containers as well as for protocol proxy and termination. These include traditional 3GPP protocols and new protocols that are introduced with 5G.
- **Applications Services**—Responsible for implementing the core application or business logic, these are the stateless services that render the actual application based on the received information. This layer may contain varying degrees of microservice granularity. Application services are stateless.
- **State management services**—Enable stateless application services by providing a common data layer (CDL) to store or cache state information (for example session and subscriber data). This layer supports various data storage technologies from in-memory caches to full-fledge databases.

Figure 3: Control Plan Network Function Tiered Architecture

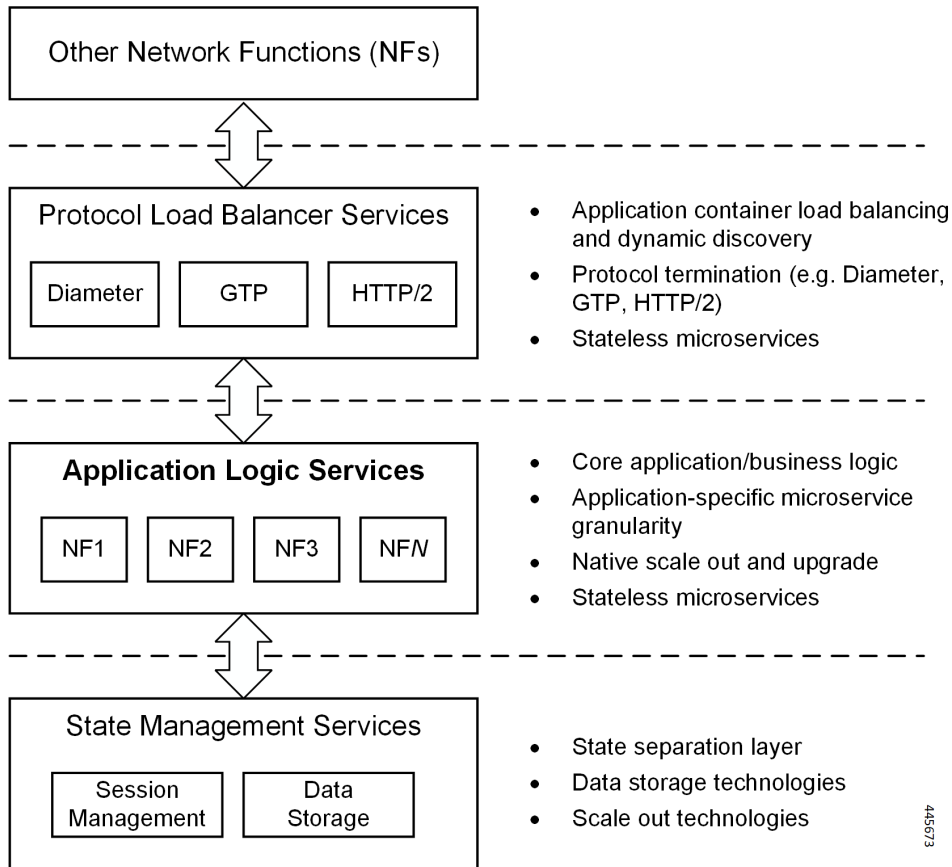

445673

The three-tiered architecture on which Cisco CP NFs are designed fully support the 5G core (5GC) Service-based Architecture (SBA) defined by 3GPP. These NFs communicate with each other and with third-party NFs over the Service-based Interface (SBI) using HTTP/2 over TCP as defined by 3GPP.

Figure 4: Cisco CP NF Service-based Architecture Support

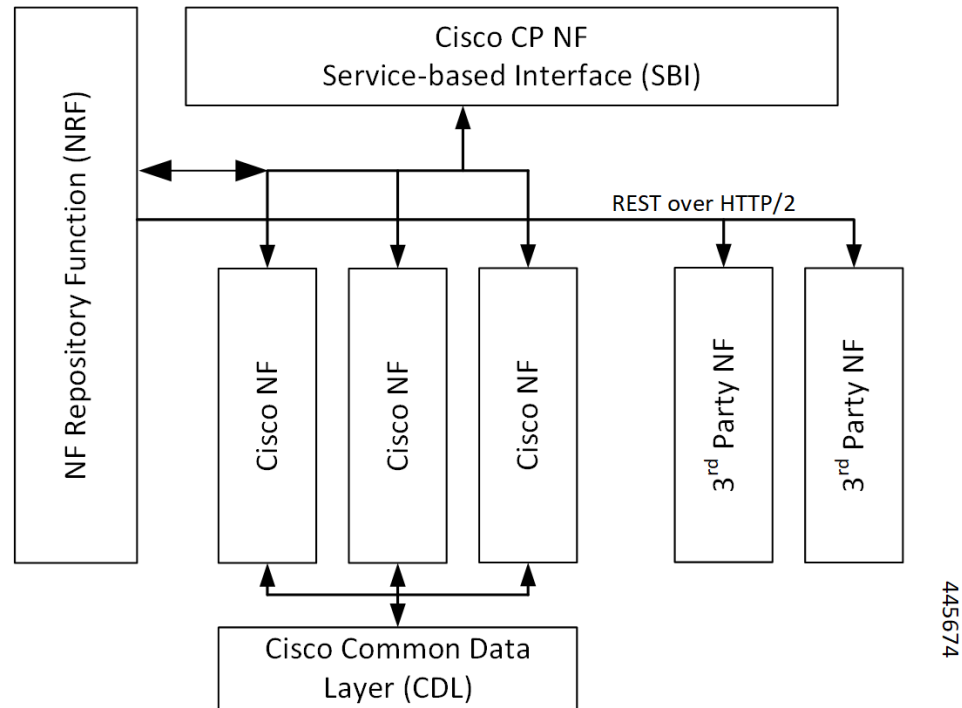

For more information on the Cisco network functions, see their corresponding network function documentation.



CHAPTER 2

5G-UPF Overview

This chapter covers the following topics:

- [Feature Summary and Revision History, on page 9](#)
- [Product Description, on page 10](#)
- [Use Cases and Features, on page 10](#)
- [Deployment Architecture and Interfaces, on page 14](#)
- [License Information, on page 17](#)
- [Standards Compliance, on page 18](#)

Feature Summary and Revision History

Summary Data

Table 3: Summary Data

Applicable Product(s) or Functional Area	5G-UPF
Applicable Platform(s)	VPC-SI SMI
Feature Default Setting	Disabled – License Required
Related Changes in this Release	Not Applicable
Related Documentation	Not Applicable

Revision History

Table 4: Revision History

Revision Details	Release
Added support for UPF cloud-native deployment.	2023.01.0
First introduced.	2020.02.0

Product Description

The User Plane Function (UPF) is one of the network functions (NFs) of the 5G core network (5GC). The UPF is responsible for packet routing and forwarding, packet inspection, QoS handling, and external PDU session for interconnecting Data Network (DN), in the 5G architecture.

UPF is a distinct Virtual Network Function (VNF) that offers a high-performance forwarding engine for the user traffic. Using Vector Packet Processing (VPP) technology, the UPF achieves ultra-fast packet forwarding while retaining compatibility with all the user plane functionality. For instance, Shallow Packet Inspection(SPI)/Deep Packet Inspection (DPI), traffic optimization, and inline services (NAT, Firewall, DNS snooping, and so on). UPF is currently designed to offer Integrated Deep Packet Based Inspection (DPI) Services.

A single instance of UPF provides some or all the following functionalities:

- Anchor point for Intra-RAT and Inter-RAT mobility (when applicable).
- External PDU session point of interconnect to Data Network.
- Packet routing and forwarding.
- Packet inspection. For example, Application detection that is based on the service data flow template and the optional PFDs received from the SMF in addition.
- User Plane part of policy rule enforcement. For example, Gating, Redirection, Traffic steering.
- Lawful intercept (UP collection).
- Traffic usage reporting.
- QoS handling for User Plane. For example, Uplink (UL) and Downlink (DL) rate enforcement, Reflective QoS marking in DL, and so on.
- Uplink Traffic verification (SDF to QoS Flow mapping).
- Transport level packet marking in the Uplink and Downlink.
- Downlink packet buffering and Downlink Data Notification triggering.
- Sending and forwarding of one or more "End Marker" to the source NG-RAN node.

The UPF also provides support for an enterprise mobile virtual network operator (MVNO) model, which enables a mobile network operator (MNO) to perform secondary authentication for the leased MVNO subscribers.

Use Cases and Features

Configuration and Deployment Requirement for UPF

With 5G deployment, interoperability is required between Cisco UPF with non-Cisco SMF, and Cisco SMF with non-Cisco UPF. Also, decoupling of configuration-related messaging between SMF and UPF has the following benefits:

- Alignment with 3GPP standards for configuration bifurcation between User Plane and Control Plane.
- Reduced complexity for configuration management on SMF.
- Simplicity and efficiency for the configuration and change management for User Plane related configuration, as it does not require SMF to manage and distribute the configuration.
- Can be enhanced to achieve interworking between non-Cisco SMF and UPFs.

The Cisco UPF supports 3GPP-specified attributes on the N4 interface. In the current architecture, only UPF associates with the SMF.

The following features are related to this use case:

- [UPF Deployment Architecture, on page 14](#)
- [UPF Local Configuration, on page 489](#)
- [N4 Session Management, Node Level, and Reporting Procedures, on page 337](#)
- [Session Recovery, on page 411](#)
- [1:1 Redundancy, on page 21](#)
- [UPF Ingress Interfaces, on page 475](#)

Anchor Point for Intra-RAT and Inter-RAT Mobility

The UPF is the anchor point between the mobile infrastructure and the Data Network (DN). That is, the encapsulation and decapsulation of GPRS Tunneling Protocol for the User Plane (GTP-U). Intra-RAT mobility like Xn handover and inter-RAT mobility like 4G to 5G and 5G to 4G handover are supported for this use case.

The [GTP-U Support, on page 217](#) feature is related to this use case.

External PDU Session Point of Interconnect to Data Network

The UPF acts as an external PDU session point of interconnect to Data Network and supports N3, N4, and N6 interfaces. The PDU layer corresponds to the PDU that is transported between the UE and the PDN during a PDU session. The PDU session can be of type IPv4 or IPv6 for transporting IP packets. The GPRS tunneling protocol for the user plane (GTP-U) supports multiplexing of the traffic from different PDU sessions by tunneling user data over the N3 interface (between a 5G access node and the UPF) in the core network. The GTP encapsulates all end-user PDUs and provides encapsulation per-PDU session. This layer also transports the marking associated with the QoS flow. The 5G encapsulation layer supports multiplexing the traffic from different PDU sessions over the N9 interface (an interface between different UPFs). It provides encapsulation per PDU session and carries the marking associated with the QoS flows.

The following features are related to this use case:

- [Control Plane-Initiated N4 Association Support, on page 95](#)
- [N3 Transfer of PDU Session Information, on page 309](#)
- [N4 Session Management, Node Level, and Reporting Procedures, on page 337](#)
- [UPF Reporting of Load Control Over N4 Interface, on page 493](#)

Packet Inspection

The Cisco UPF performs L3/L4 and L7 inspection for the user traffic that is received. L3/L4 inspection involves IP-address/port matching and Deep Packet Inspection involves matching of L7 header fields.

The [Deep Packet Inspection and Inline Services, on page 119](#) feature is related to this use case.

User Plane Part of Policy Rule Enforcement

Cisco UPF provides different enforcement mechanisms based on policy received from the SMF. The UPF is the boundary between the Access and IP domains and is the ideal location to implement policy-based enforcement. The pcc-rules provided by the PCF and the pre-defined rules on the SMF are uploaded over the N4 interface and installed on the UPF on a per-DNN basis. This allows for dynamic policy changes that enable differentiated charging and QoS enforcement.

- [Dynamic and Static PCC Rules, on page 203](#)
- [Voice over New Radio, on page 509](#)

Lawful Intercept

Lawful Interception (LI) enables a LEA to perform electronic surveillance on an individual (a target) as authorized by a judicial or administrative order. To facilitate the lawful intercept process, certain legislation and regulations require service providers and Internet service providers to implement their networks to explicitly support authorized electronic surveillance. Actions taken by the service providers include: provisioning the target identity in the network to enable isolation of target communications (separating it from other users' communications), duplicating the communications for the purpose of sending the copy to the LEA, and delivering the Interception Product to the LEA.

For information about the support of Lawful Intercept by UPF, contact your Cisco Account representative.

Traffic Usage Reporting (Charging)

The usage measurement and reporting function in UPF is controlled by the SMF. The SMF controls these functions by:

- Creating the necessary PDRs to represent the service data flow, application, bearer or session (if they are not existing already).
- Creating the URRs for each Charging Key and combination of Charging Key and Service ID. Also, creating URRs for a combination of Charging Key, Sponsor ID, and Application Service Provider ID.
Please note that, for static rules, the UPF creates the URR ID. The URR ID is created based on the online/offline and Content ID+Service ID combination that is configured on UPF.
- Associating the URRs to the relevant PDRs defined for the PFCP session, for usage reporting at SDF, Session or Application level.
- For online charging, the SMF provisions Volume and Time quota, if it receives it from the Online Charging Server (OCS).

The [Charging Support, on page 65](#) feature is related to this use case.

QoS Handling for User Plane

The 5G QoS model allow classification and differentiation of specific services, based on subscription-related and invocation-related priority mechanisms. These mechanisms provide abilities such as invoking, modifying, maintaining, and releasing QoS Flows with priority, and delivering QoS Flow packets according to the QoS characteristics under network congestion conditions.

The [Dynamic and Static PCC Rules, on page 203](#) feature is related to this use case.

Downlink Packet Buffering and Data Notification Triggering

A Buffering Action Rule (BAR) provides instructions to control the buffering behavior of the UPF. The BAR controls the buffering behavior for all Forwarding Action Rules (FARs) of the Packet Forwarding Control Protocol (PFCP) session. This control is applicable when the PFCP session is set with an Apply Action parameter, which requests packets to be buffered and associated with the respective BAR.

The [Idle Mode Buffering and Paging, on page 229](#) feature is related to this use case.

Forwarding End Markers to the Source NG-RAN Node

At the time of the handover procedure, the PDU session for the UE – which comprises of UPF node – acts as a PDU session anchor and an intermediate UPF terminating N3 reference point. The SMF sends an N4 Session Modification Request message with the new AN Tunnel Info of NG-RAN to specify the UPF to switch to the N3 paths. In addition, the SMF also specifies the UPF to send the End Marker packets on the old N3 user plane path. After the UPF receives the indication, the End Markers are constructed and sent to each N3 GTP-U tunnel toward the source NG-RAN, after sending the last PDU on the old path.

The [N4 Session Management, Node Level, and Reporting Procedures, on page 337](#) feature is related to this use case.

MVNO Support

The UPF provides support for an enterprise MVNO model. A mobile network operator can perform secondary authentication for the leased MVNO subscribers and also support any additional features related to the AAA server.

The following features are related to this use case:

- [APN ACL Support, on page 51](#)

A configurable mechanism to apply traffic classification and policy enforcement on selective subscriber sessions.

- [Dynamic and Static PCC Rules, on page 203](#)

Increase in maximum number of groups per bandwidth policy.

- [Virtual Routing and Forwarding, on page 499](#)

Support for Overlapping IP Pools and IP Pool chunks.

Deployment Architecture and Interfaces

Cisco UPF is part of the 5GC network functions portfolio (AMF/SMF/NRF/PCF/NSSF/UPF) with a common Mobile Core Platform architecture.

UPF Architecture

The User Plane Function (UPF) is a fundamental component of a 3GPP 5G core infrastructure system architecture. The UPF represents the data plane evolution of a Control and User Plane Separation (CUPS) strategy, first introduced as an extension to existing Evolved Packet Cores (EPCs) by the 3GPP in Release 14 specifications. The CUPS decouples Packet Gateway (P-GW) Control and User Plane functions, enabling the data forwarding component (PGW-U) to be decentralized. This allows packet processing and traffic aggregation to be performed closer to the network edge, increasing bandwidth efficiencies while reducing network load. The P-GW handling signaling traffic (PGW-C) remains in the core, northbound of the Mobility Management Entity (MME).

The primary goal of CUPS is to support 5G New Radio (NR) implementations enabling early IoT applications and higher data rates. Committing to a complete implementation of CUPS is a complex proposition as it only provides a subset of advantages to the operator adopting a 5G User Plane Function (5G-UPF), offering network slicing. Deployed as a Virtual Machine (VM), the User Plane Function delivers the packet processing foundation for Service-Based Architectures (SBAs).

The UPF identifies User Plane traffic flow that is based on information that is received from the SMF over the N4 reference point. The N4 interface employs the Packet Forwarding Control Protocol (PFCP), which is defined in the 3GPP technical specification 29.244 for use on Sx/N4 reference points in support of CUPS. The PFCP is similar to OpenFlow but can be limited to only the functionality that is required to support mobile networks. The PFCP sessions, which are established with the UPF, define how packets are identified (Packet Detection Rule / PDR), forwarded (Forwarding Action Rules / FARs), processed (Buffering Action Rules / BARs), marked (QoS Enforcement Rules / QERs) and reported (Usage Reporting Rules / URRs).

UPF Deployment Architecture

The following diagram illustrates the high-level deployment architecture of UPF along with other NFs.

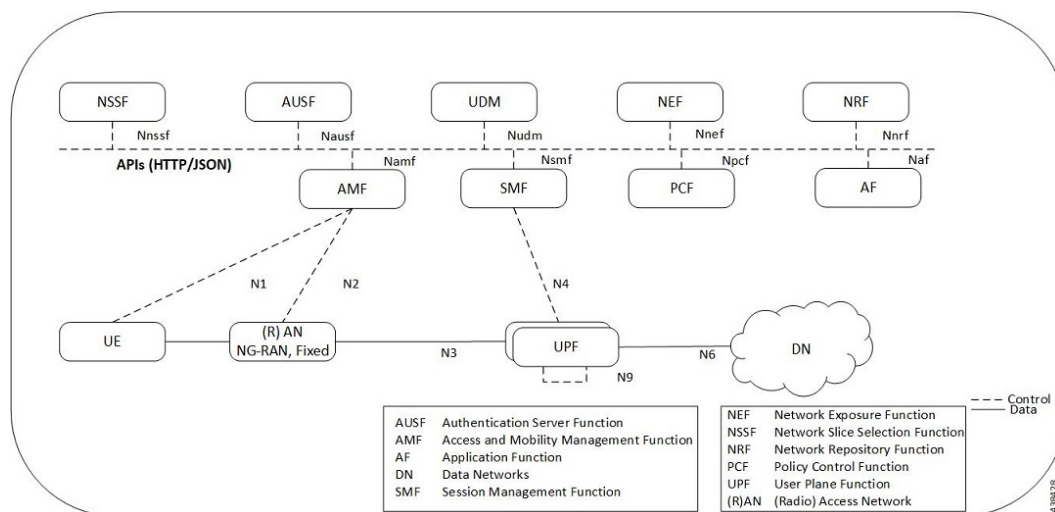

VM Deployment

Virtualized Packet Core—Single Instance (VPC-SI)

VPC-SI consolidates the operations of a physical Cisco ASR 5500 chassis running StarOS into a single Virtual Machine (VM) able to run on commercial off-the-shelf (COTS) servers. VPC-SI can be used as a stand-alone single VM within an enterprise, remote site, or customer data center. Alternatively, VPC-SI can be integrated as part of a larger service provider orchestration solution.

VPC-SI only interacts with supported hypervisors KVM (Kernel-based Virtual Machine) and VMware ESXi. It has little or no knowledge of physical devices.

The UPF functions as user plane node in 5G-based VNF deployments. UPF is deployed as a VNFC running a single, stand-alone instance of the StarOS. Multiple UPF VNFCs can be deployed for scalability based on your deployment requirements.

Hypervisor Requirements

VPC-SI has been qualified to run under the following hypervisors:

- Kernel-based Virtual Machine (KVM) - QEMU emulator 2.0. The VPC-SI StarOS installation build includes a libvirt XML template and `ssi_install.sh` for VM creation under Ubuntu Server 18.04.



Note When a port on the UPF is shutdown and brought up subsequently, the port interfaces are visible in Ubuntu version 18.04 and NIC driver i40e version 2.12.6. BGP on these interfaces does not recover automatically.

To fully restore the UPF, you must reload the UPFs. In Ubuntu version 20.04 and NIC driver i40e version 2.17.15, both port interfaces and BGP recover automatically.

- KVM - Red Hat Enterprise Linux 7.2: The VPC-SI StarOS installation build includes an install script called `qpc-si_install.sh`.
- VMware ESXi 6.7: The VPC-SI StarOS installation build includes OVF (Open Virtualization Format) and OVA (Open Virtual Application) templates for VM creation via the ESXi GUI.

vNIC Options

The supported vNIC options include:

- VMXNET3—Paravirtual NIC for VMware
- VIRTIO—Paravirtual NIC for KVM
- ixgbe—Intel 10-Gigabit NIC virtual function
- enic—Cisco UCS NIC
- SR-IOV—Single-root I/O virtualization

The SR-IOV specification provides a mechanism by which a single root function (for example, a single Ethernet port) can appear to be multiple separate physical devices. Intel 82599 10G is an SR-IOV capable device and can be configured (usually by the Hypervisor) to appear in the PCI configuration space as multiple

functions (PFs and VFs). The virtual functions (VFs) can be assigned to Nova VMs, causing traffic from the VMs to bypass the Hypervisor and go directly to the fabric interconnect. This feature increases traffic throughput to the VM and reduces CPU load on the UCS Servers.

Capacity, CEPS and Throughput

Sizing a VPC-SI instance requires modeling of the expected call model.

Many service types require more resources than others. Packet size, throughput per session, CEPS (Call Events per Second) rate, IPsec usage (site-to-site, subscriber, LI), contention with other VMs, and the underlying hardware type (CPU speed, number of vCPUs) will further limit the effective number of maximum subscribers. Qualification of a call model on equivalent hardware and hypervisor configuration is required.

Sample VPP Configuration

For 5G-UPF, the FORWARDER_TYPE is "vpp".

The following is a sample output of VPP configuration.

```
show cloud configuration
Thursday January 30 12:18:10 UTC 2020
Card 1:
  Config Disk Params:
  -----
FORWARDER_TYPE=vpp
VNFM_INTERFACE=MAC:fa:11:3e:22:d8:33
MGMT_INTERFACE=MAC:fa:11:3e:44:af:9e
VNFM_IPV4_ENABLE=true
VNFM_IPV4_DHCP_ENABLE=true
SERVICE1_INTERFACE=MAC:fa:11:3e:11:9d:23
SERVICE2_INTERFACE=MAC:fa:11:3e:99:ec:7b
VPP_CPU_WORKER_CNT=8
VPP_DPDK_TX_QUEUES=9
VPP_DPDK_RX_QUEUES=8
CHASSIS_ID=xxxxxxxxxxxxxxxxxxxxxxxxxxxxxxxxxxxxxxxxxxxxxxxxxxxxxxxxxxxxxxxx
-----
  Local Params:
  -----
  No local param file available
```



Note For additional information about VPC-SI build components, boot parameters, configuring VPC-SI boot parameters, VM configuration, vCPU and vRAM options, VPP configuration parameters, and so on, refer the *VPC-SI System Administration Guide*.

UPF Deployment with VPC-SI

For additional information on VPC-SI, supported operating system and hypervisor packages, platform configurations, software download and installation, and UPF deployment, contact your Cisco Account representative.

For information on Release Package, refer the corresponding Release Notes included with the build.

UPF Deployment with SMI Cluster Manager

The Ultra Cloud Core Subscriber Microservices Infrastructure (SMI) provides a run time environment for deploying and managing Cisco Cloud-Native Network Functions (CNFs), also referred to as applications.

It is built around Open Source projects like Kubernetes (K8s), Docker, Helm, etcd, confd, and gRPC, and provides a common set of services used by deployed cNFs.

The SMI is a layered stack of cloud technologies that enable the rapid deployment of, and seamless life-cycle operations for microservices-based applications.

The SMI stack consists of SMI Cluster Manager that creates the Kubernetes (K8s) cluster and the software repository. The SMI Cluster Manager also provides ongoing Life Cycle Management (LCM) for the cluster including deployment, upgrades, and expansion.

The SMI Cluster Manager leverages the Kernel-based Virtual Machine (KVM)—a virtualization technology—to deploy the User Plane Function (UPF) VMs.

For more information, refer the *UCC SMI Operations Guide*.

Same UP Pools for SAEGW-C and SMF

The same pool of UPs can be used by SAEGW and SMF. The user plane can act as UP and UPF at the same time. It can serve SAEGW over the Sx interface and SMF over the N4 interface. The same subscriber IP pool on SAEGW and SMF is supported only with different VRFs.

This functionality is qualified for the user plane acting as UP and UPF to simultaneously support CUPS and SAEGW Sx interfaces (Sxa, Sxb, and Sxab) for 2G, 3G, 4G RAT, and SMF N4 interface for 5G call.



Note The combined UP and UPF call is not qualified in this release.

Supported Interfaces

This section describes the interfaces supported between the UPF and other network functions in 5GC.

- N3: Interface between the RAN (gNB) and the (initial) UPF; compliant with 3GPP TS 29.281 and 3GPP TS 38.415 (December-2018).
- N4: Interface between the Session Management Function (SMF) and the UPF; compliant with 3GPP TS 29.244 (December-2018).
- N6: Interface between the Data Network (DN) and the UPF; compliant with 3GPP TS 29.561 (December-2018).
- Sx: Interface between the Control-Plane and User-Plane in a split P-GW, S-GW, and TDF architecture in an Evolved Packet Core (EPC); compliant with 3GPP TS 23.214 and 3GPP TS 33.107.

License Information

The UPF requires specific license(s). Contact your Cisco account representative for more information on how to obtain a license.

Standards Compliance

Cisco UPF complies with the following standards:

- Interface between the Control Plane and the User Plane Nodes: 3GPP TS 29.244 version 15.4.0. (December-2018)
- General Packet Radio System (GPRS) Tunneling Protocol User Plane (GTPv1-U): 3GPP TS 29.281 version 15.5.0 (December-2018).
- NG-RAN; PDU Session User Plane protocol: 3GPP TS 38.415 (December-2018)
- 5G System; Interworking between 5G Network and external Data Networks; Stage 3: 3GPP TS 29.561 (December-2018)



PART I

Features and Functionality

- [1:1 Redundancy, on page 21](#)
- [ADC for Dynamic Rules, on page 43](#)
- [APN ACL Support, on page 51](#)
- [APN AMBR Traffic Policing, on page 57](#)
- [Bulk Statistics Support, on page 61](#)
- [Charging Support, on page 65](#)
- [Cisco Ultra Traffic Optimization with VPP, on page 81](#)
- [Collection and Reporting of Usage Data over N4 Interface, on page 91](#)
- [Control Plane-Initiated N4 Association Support, on page 95](#)
- [Converged Datapath, on page 99](#)
- [Deep Packet Inspection and Inline Services, on page 119](#)
- [Device ID in EDNS0 Records, on page 171](#)
- [Downlink Data Notification, on page 181](#)
- [DSCP Markings For Collapse Calls, on page 197](#)
- [Dynamic and Static PCC Rules, on page 203](#)
- [ECS Regular Expression, on page 213](#)
- [GTP-U Support, on page 217](#)
- [Heartbeat Support for N4/Sx Interface, on page 223](#)
- [Idle Mode Buffering and Paging, on page 229](#)
- [Indirect Forwarding Tunnel, on page 233](#)
- [IPsec Support for IPv6, on page 239](#)
- [LTE - Wi-Fi Seamless Handover, on page 245](#)
- [Monitor Subscriber, on page 255](#)
- [MPLS Support on UPF, on page 273](#)

- Multiple cnSGW Support, on page 283
- Multiple N4/Sx Interfaces, on page 287
- Nexthop Forwarding Support , on page 291
- N:M Redundancy and Redundancy Configuration Manager, on page 307
- N3 Transfer of PDU Session Information, on page 309
- N4 Interface Compliance with 3GPP Specification, on page 313
- N4 Interface Configuration, on page 319
- N4/Sx over IPSec, on page 323
- N4 Session Management, Node Level, and Reporting Procedures, on page 337
- NRF Support, on page 353
- Password Expiration Notification, on page 359
- QCI 80 Support on UPF , on page 363
- QoS Group of Ruledefs Support, on page 369
- Roaming Support, on page 377
- Security Group Tag Support, on page 407
- Session Recovery, on page 411
- Session Report Rejection Procedure, on page 417
- Smart Licensing, on page 421
- Software Management Operations, on page 429
- Standard QCI Support, on page 437
- System Logs, on page 439
- UPF Ingress Interfaces, on page 475
- UPF Local Configuration, on page 489
- UPF Reporting of Load Control Over N4 Interface, on page 493
- UPF Usage Monitoring over PCF, on page 497
- Virtual Routing and Forwarding, on page 499
- Voice over New Radio, on page 509
- WPS Prioritization, on page 513
- X-Header Insertion and Encryption, on page 521



CHAPTER 3

1:1 Redundancy

- [Feature Summary and Revision History, on page 21](#)
- [Feature Description, on page 22](#)
- [How it Works, on page 22](#)
- [Configuring 1:1 UPF Redundancy, on page 28](#)
- [Monitoring and Troubleshooting, on page 33](#)
- [L2 ICSR Support, on page 36](#)

Feature Summary and Revision History

Summary Data

Applicable Product(s) or Functional Area	5G-UPF
Applicable Platform(s)	VPC-SI SMI
Feature Default Setting	Disabled – Configuration Required
Related Changes in this Release	Not Applicable
Related Documentation	Not Applicable

Revision History

Revision Details	Release
Added support for L2 ICSR.	2023.01.0

Revision Details	Release
Support is added for the following functionality: <ul style="list-style-type: none"> • Zero Accounting Loss in User Plane Function • Early PDU Recovery • Session Prioritization during Recovery • Configuration to change the state of UPF from Pending-Active to Active 	2021.02.0
First introduced.	2020.02.0

Feature Description

The 1:1 UPF Redundancy feature, for 5G deployment, supports the detection of a failed User Plane Function (UPF) and seamlessly handles the functions of the failed UPF. Each of the Active UPF has a dedicated Standby UPF. The 1:1 UPF Redundancy architecture is based on the UPF to UPF Interchassis Session Recovery (ICSR) connection.

How it Works

The 5G-UPF deployment leverages the ICSR framework infrastructure for checkpointing and switchover of the UPF node as shown in the following figure. The Active UPF communicates to its dedicated Standby UPF through the Service Redundancy Protocol (SRP) link that is provisioned between the UPFs.

Figure 5: UPF 1:1 Redundancy Using SRP

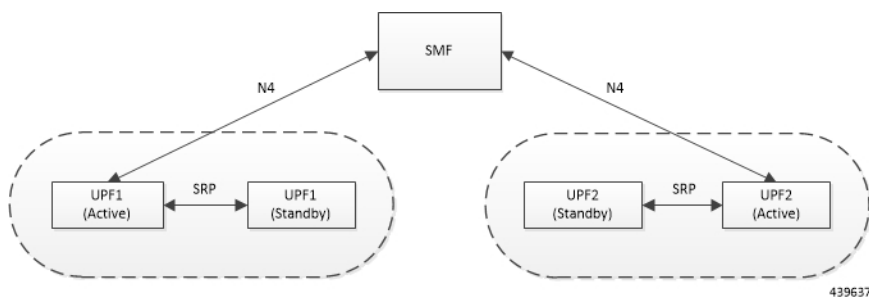

The Session Management Function (SMF) node does not have the Standby UPF information that is available in the UPF group configuration. Therefore, the SMF is not aware of the UPF redundancy configuration and the switchover event among the UPFs.

The Active UPF communicates to the SMF through the N4 interface address configured in the UPF. The Standby UPF takes over the same Sx/N4 address when it transitions to Active during the switchover event. This implies that the Sx/N4 interface is SRP-activated and is in line with the existing configuration method, therefore UPF switchover is transparent to the SMF.

Figure 6: UPF 1:1 Redundancy Switchover

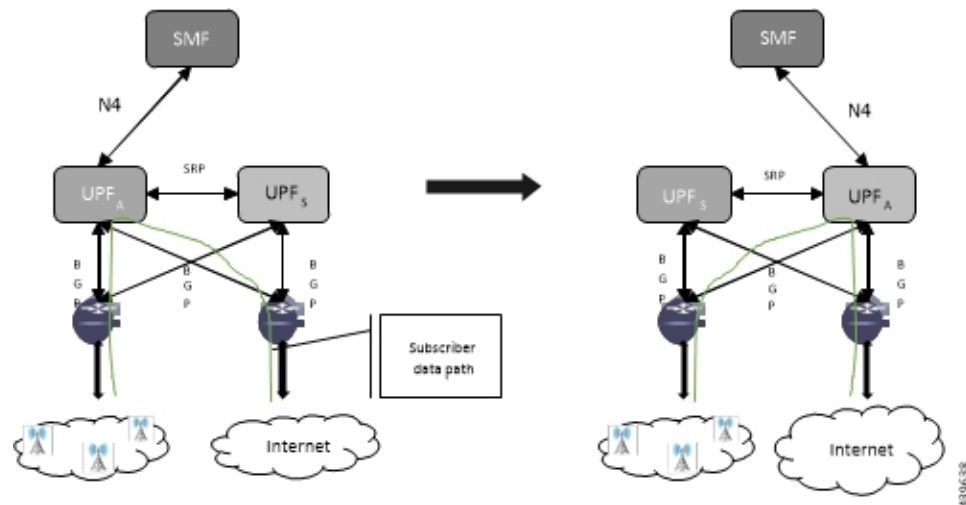

To make redundancy fully compliant, it addresses the following dependencies on the SRP-based ICSR in the 5G environment.

- Configuration Synchronization (or, Replica Configuration on Standby UPF)
- Sx/N4 Association Checkpoint
- Sx/N4 Link Monitoring

Besides the dependencies listed, the UPF implements data collection and checkpoint procedures specific to the UPF node. For example, checkpointing for IP-pool chunks. The UPF integrates these procedures into the existing ICSR checkpointing framework.

Independent Configuration of Standby UPF

After UPF is up with base configuration (for example, services, contexts, interfaces, and so on), the rest of the configuration (for example, ACS and policy-related configuration) is done through an Ops-center or Redundancy and Configuration Manager (RCM) POD. This configuration is common for both SMF and UPF policies. For SRP redundancy to work, the Active and Standby UPF has same configuration, except SRP-related configuration with which SRP connections are established between the Active and Standby UPF. The RCM configures Active and Standby UPF independently.

BFD Monitor Between Active UP and Standby UP

The Bidirectional Forwarding Detection (BFD) monitors the SRP link between the Active UPF and Standby UPF for a fast failure-detection and switchover. When the Standby UPF detects a BFD failure in this link, it takes over as the Active UPF.

The BFD link can be single-hop or multi-hop.

To configure the BFD monitor, between the Active UP and Standby UP, see *Configuring BFD Monitoring Between Active UPF and Standby UPF*.

Sample Configuration for Multihop BFD Monitoring

Primary UPF:

```

config
  context srp
    bfd-protocol
      bfd multihop-peer 209.165.200.225 interval 50 min_rx 50 multiplier 20
    #exit
    service-redundancy-protocol
      monitor bfd context srp 209.165.200.225 chassis-to-chassis
      peer-ip-address 209.165.200.225
      bind address 209.165.201.1
    #exit
    interface srp
      ip address 209.165.201.1 255.255.255.224
    #exit
    ip route static multihop bfd bfd1 209.165.201.1 209.165.200.225
    ip route 209.165.201.1 255.255.255.224 209.165.201.1 srp
  #exit
end

```

Backup UPF:

```

config
  context srp
    bfd-protocol
      bfd multihop-peer 209.165.201.1 interval 50 min_rx 50 multiplier 20
    #exit
    service-redundancy-protocol
      monitor bfd context srp 209.165.201.1 chassis-to-chassis
      peer-ip-address 209.165.201.1
      bind address 209.165.201.1
    #exit
    interface srp
      ip address 209.165.201.1 255.255.255.224
    #exit
    ip route static multihop bfd bfd1 209.165.200.225 209.165.201.1
    ip route 209.165.201.1 255.255.255.224 209.165.200.225 srp
  #exit
End

```

Router between Primary and Backup UPF:

```

config
  context one
    interface one
      ip address 209.165.201.1 255.255.255.224
    #exit
    interface two
      ip address 209.165.200.225 255.255.255.224
    #exit
  #exit
end

```

Sample Configuration for Single-Hop BFD Monitoring

Primary UPF:

```

config
  context srp
    bfd-protocol
      #exit
    service-redundancy-protocol
      monitor bfd context srp 209.165.201.1 chassis-to-chassis
      peer-ip-address 209.165.201.1
      bind address 209.165.201.4
    #exit
    interface srp
      ip address 209.165.201.1 255.255.255.224

```

```

        bfd interval 50 min_rx 50 multiplier 10
    #exit
    ip route static bfd srp 209.165.201.4
#exit
end

```

Backup UPF:

```

config
 context srp
  bfd-protocol
  #exit
  service-redundancy-protocol
    monitor bfd context srp 209.165.200.225 chassis-to-chassis
    peer-ip-address 209.165.201.4
    bind address 209.165.201.7
  #exit
  interface srp
    ip address 209.165.201.4 255.255.255.224
    bfd interval 50 min_rx 50 multiplier 10
  #exit
  ip route static bfd srp 209.165.201.7
#exit
end

```

VPP Monitor

When SRP VPP monitor is configured, the UPF chassis is SRP Active and if the VPP subsystem fails, then SRP initiates switchover to Standby UPF. Currently, VPP health monitoring is limited to heartbeat mechanism between NPUMgr task and VPP process.

To configure the VPP monitor, see *Configuring VPP Monitor on Active UPF and Standby UPF*.

Sx/N4 Association Checkpoint

Whenever an Active UPF initiates an Sx/N4 association to SMF, the Standby UPF checkpoints this data. This maintains the association information even after the UPF switchover.

The Sx/N4 heartbeat messages are sent and the Active UPF responds back even after back-to-back UPF switchovers.

Sx/N4 Monitor

It is critical to monitor the Sx/N4 interface between the UPF and SMF. The SRP monitoring is enabled on Sx/N4 interface and the existing Sx/N4 heartbeat mechanism is leveraged to detect the monitor failure. The Sx/N4 module on Active UPF, on detecting the failure, informs the SRP VPNMgr to trigger UPF switchover event so that the Standby UPF takes over.



Note Sx/N4 monitoring is available only in the UPF.

It is important to ensure that the SMF Sx/N4 heartbeat timeout is higher than the UPF Sx/N4 heartbeat timeout plus UPF ICSR switchover time. This is to ensure that the SMF does not detect the Sx/N4 path failure during a UPF switchover because of the UPF Sx/N4 monitor failure.

The Standby UPF itself has no independent connectivity to the SMF. The Active UPF Sx/N4 context is replicated to the Standby UPF so that it is ready to takeover during SRP switchover. This implies that when the Active UPF has switched over to Standby because of Sx/N4 monitor failure, the new Standby has no way

of knowing if the UPF to SMF link is working. To prevent a switchback of the new Standby to Active state again due to Sx/N4 monitor failure in new Active, use the **disallow-switchover-on-peer-monitor-fail** keyword in the **monitor sx** CLI command.

After a chassis becomes Standby due to Sx/N4 monitoring failure, the Sx/N4 failure status is not reset even if Sx/N4 up checkpoint is received from the new Active UPF. This is to prevent the new Active to cause an unplanned switchback again due to Sx/N4 monitor failure when the previous cause of switchover itself was Sx/N4 monitor failure. This prevents back-to-back switchovers when SMF is down. The Sx/N4 monitor failure status must be manually reset when the operator is convinced that the network connectivity is normal. To reset, use the new **srp reset-sx-fail** CLI command (see *Resetting Sx/N4 Monitor Failure*) in the Standby chassis.

To configure the Sx/N4 monitor, see *Configuring Sx/N4 Monitoring on the Active UPF and Standby UPF*.

Sx/N4 Monitor—Pending-Active

The UPF chassis can turn into Pending-Active state for one of the following reasons:

- When Sx/N4 heartbeat times out during SMF upgrade, the Sx/N4 connection is terminated. So, Sx/N4 monitoring failure triggers ICSR switchover in UPF. This switchover causes the old Standby UPF to transition to Pending-Active state. The UPF in Pending-Active state neither receives any Sx/N4 heartbeats from SMF nor any subscriber traffic. As a result, the UPF remains in Pending-Active state indefinitely and can't be utilized without a manual intervention.
- When appropriate procedure to upgrade UPF is not followed, one of the UPF may end up in Pending-Active state. Also, if SMF goes down during the UPF upgrade or if the UPF switchover takes more time than the SMF heartbeat timeout, then one of the UPF remains in Pending-Active state indefinitely.
- When Sx/N4 session times out between SMF and UPF due to network issues, and if a UPF ICSR switchover happens almost simultaneously (Double fault scenario), the UPF in Pending-Active state doesn't transition to active state.

Whenever a UPF chassis turns Pending-Active, start a timer with a callback which forcefully transitions the UPF from Pending-Active to active state. Before forcing the transition, check if the SRP link is up and if the SRP peer is in standby state. If not, restart the timer. The duration of the timer is configurable using **force-pactv-to-actv-timeout value_seconds** CLI command (see *Changing UPF state from Pending-Active to Active* section for configuration details). When this CLI command is not configured, the UPF remains in Pending-Active state indefinitely.

BGP Monitor

Configure BGP peer monitor and peer group monitors for the next-hop routers from UPF (both Gi and Gn side). This is the existing ICSR configuration. BGP may run with BFD assist to detect fast BGP peer failure.

Figure 7: BGP Peer Groups and Routing

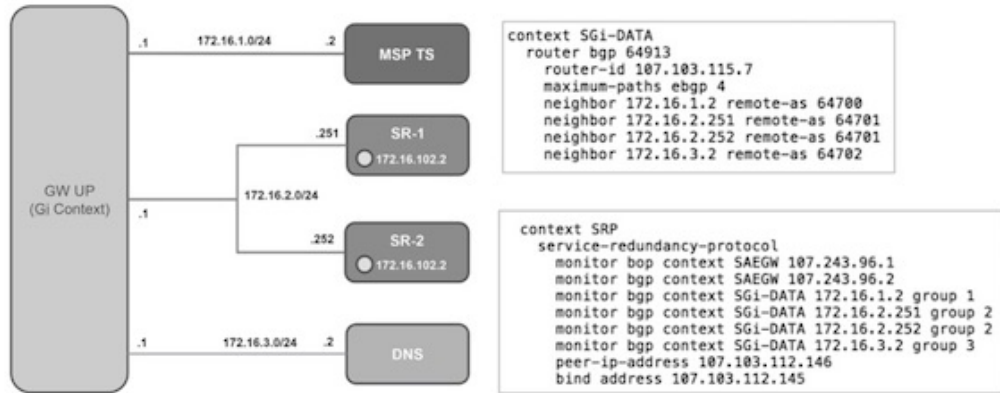

Loopback is not needed if only one peer is present for each group

437171

To configure BGP monitoring and flag BPG monitoring failure, see *Configuring BGP Status Monitoring Between Each UP and Next-Hop Router*.

UPF Session Checkpoints

The Active chassis sends a collection of UPF data as checkpoints to the peer Standby chassis in the following scenarios:

- New call setup
- For every state change in the call
- Periodically for accounting buckets

On receiving these checkpoints, the Standby chassis acts on the data and updates the necessary information either at the call, node, or instance level.

VPN IP Pool Checkpoints

During Sx/N4 Association, the IP pool that is allocated to each of the UPF is sent by SMF to the respective UPF. The VPNMgr receives this message in the UPF and checkpoints the same information to the Standby UPF when the SRP is configured.

The IP pool information is also sent during the SRP VPNMgr restart and during the SRP link down and up scenarios.

Validation of the presence of IP pool information in the Standby is vital before switchover. If the IP pool information is not present, then route advertisement is not possible. Therefore, traffic does not reach the UPF.

External Audit and PFD Configuration Audit Interaction

External Audit management is done in Active UPF. The Session Manager gets a start and complete notification of the Configuration Audit. The Session Manager does not start the External Audit if Configuration Audit is in progress. If the Configuration Audit start-notification arrives when the External Audit is already underway, then the Session Manager raises a flag such that the External Audit restarts when it completes. Restarting the External Audit is necessary because it does not achieve its purpose if it occurs when Configuration Audit is already underway.

Zero Accounting Loss for User Plane Function

Zero accounting loss feature is implemented on the User Plane Function (UPF) so that accounting-data or billing loss is reduced from 18 seconds, which is the default checkpoint time from Active UPF to Standby UPF, or for the configured accounting checkpoint time.

This change in UPF is to support the Gz, Gy, VoGx, and RADIUS URRs. Only planned switchover is supported for zero accounting loss or URR data counters loss. This feature doesn't impact the current ICSR framework or the way checkpointing is done and recovered.

The Sx/N4 usage report is blocked during the “pending active state” until the chassis becomes Active.

Early PDU Recovery for UPF Session Recovery

Early PDU Recovery feature overcomes the earlier limitation of Session Recovery feature wherein it didn't prioritize the CRRs that were selected for recovery. All the CRRs were fetched from the AAAMgr and then the calls were recovered sequentially. The time taken to fetch all the CRRs was a major factor in the perceived delay during session recovery. When a failure occurred, the delay was sometimes long if there were many sessions in a Session Manager. Also, since the calls were recovered in no particular order, the idle sessions were sometimes recovered before active sessions.



Note The Early PDU Recovery feature can recover a maximum of 5-percent sessions.

Session Prioritization during Recovery

Without this functionality, the Session Recovery function didn't prioritize the sessions selected for recovery and loops through all the calls in the call recovery list, and are recovered sequentially when the session recovery is triggered.

As part of Session Prioritization during Recovery, a separate skip list is maintained only for priority calls so that these records can be sent from AAAMgr immediately without going through the loop, thus leading to quicker recovery of the priority calls and reducing the data outage time.

There are two types of sessions at User Plane—Prioritized sessions and normal sessions. Session is considered to be prioritized session based on message priority flag received from SMF and it's recovered first followed by normal calls. These prioritized sessions also take priority in case of early PDU handling. The early PDU of normal calls initiates recovery only when all prioritized sessions are recovered.

In case of critical flush (GR), checkpoints for prioritized sessions are sent first followed by the normal calls. The data of all the calls (both normal and prioritized) are allowed during switchover.



Note The SMF is responsible to set the priority flags for all the calls. The UPF uses the priority call details that are received from the SMF for the Session Prioritization feature.

Configuring 1:1 UPF Redundancy

The following sections provide information about the CLI commands available in support of the feature.

Configuring BFD Monitoring Between Active UPF and Standby UPF

Use the following configuration to configure Bidirectional Forwarding Detection (BFD) monitoring on the Active UPF and Standby UPF. Configure this command in the SRP Configuration Mode.

```
configure
  context context_name
    service-redundancy-protocol
      [ no ] monitor bfd context context_name { ipv4_address | ipv6_address }
    { chassis-to-chassis | chassis-to-router }
  end
```

NOTES:

- **no**: Disables BFD monitoring on the Active and Standby UPF.
- **context context_name** : Specifies the context that is used. It refers to the context where the BFD peer is configured (SRP context).
context_name must be an existing context expressed as an alphanumeric string of 1 through 79 characters.
- **ipv4_address | ipv6_address**: Defines the IP address of the BFD neighbor to be monitored, entered using IPv4 dotted-decimal or IPv6 colon-separated-hexadecimal notation.
It refers to the IP address of the configured BFD (ICSR) peer.
- **chassis-to-chassis | chassis-to-router**:
chassis-to-chassis: BFD runs between primary and backup chassis on non-SRP links.
chassis-to-router: BFD runs between chassis and router.



Caution Don't use the **chassis-to-router** keyword for BFD monitoring on the SRP link between the Active UPF and the Standby UPF.

- This command is disabled by default.

Configuring BGP Status Monitoring Between Each UPF and Next-Hop Router

Use the following commands to configure Border Gateway Protocol (BGP) monitoring between each UPF and next-hop router. The command is configured in the SRP Configuration Mode.

```
configure
  context context_name
    service-redundancy-protocol
      [ no ] monitor bgp context bgp-session-context-name [
  nexthop-router-ipv4-address | nexthop-router-ipv6-address ] { vrf
  bgp-session-vrf-name } { group group-number }
  end
```

NOTES:

- **no**: Disables BGP status monitoring on the UPF.

- **bgp context** *bgp-session-context-name*: Specifies the context where BGP peer is configured. *bgp-session-context-name* specifies the context string.
- **nexthop-router-ipv4-address** | **nexthop-router-ipv6-address**: Specifies the configured BGP peer IPv4 or IPv6 address to monitor.
- **vrf** *bgp-session-vrf-name*: Specifies the BGP VPN Routing and Forwarding (VRF) instance. *bgp-session-vrf-name* specifies the VRF name.
- **group** *group-number* : Specifies the BGP peer group where the BGP peer should be included. *group-number* specifies the group number.

On implementing this keyword, the behavior is as follows:

- If any BGP peer in that group is up, the BGP peer group is up.

Omitting group configuration for a BGP monitor includes that monitor in group 0.

BGP group 0 monitors in a context from an implicit group. Each context forms a separate BGP group 0 implicit monitor group.

If any BGP peer group is down, BGP monitor is down.

- This command is disabled by default.

Alternate Algorithm to Flag BGP monitoring failure

In this release, an alternate (new) algorithm is introduced to flag BGP monitoring failure.

Use the following commands to flag BGP monitor failure on a single BGP peer (User Plane Function) failure. This command is configured in the SRP Configuration Mode.

```
configure
context context_name
  service-redundancy-protocol
    [ no ] monitor bgp exclusive-failover
  end
```

NOTES:

- **no**: Disables flagging of BGP monitor failure on a single BGP peer failure.
- On implementing the new **exclusive-failover** keyword, the behavior is as follows:
 - BGP peer group is Up if any BGP peer in that group is Up.
 - Including a BGP peer in group 0 is same as making it non-group (omitting group).
 - BGP monitor is down if any BGP peer group or any non-group BGP peer is down.
- This command is disabled by default.

Configuring Sx/N4 Monitoring on the Active UPF and Standby UPF

Use the following configuration to configure Sx/N4 monitoring on the Active UPF and Standby UPF. This command is configured in the SRP Configuration Mode.

```

configure
  context context_name
    service-redundancy-protocol
      [ no ] monitor sx [ { context context_name | bind-address { ipv4_address
| ipv6_address } | { peer-address { ipv4_address | ipv6_address } } ]
      end

```

NOTES:

- **no**: Disables Sx/N4 monitoring on the Active and Standby UPF.
- **context context_name** : Specifies the context of the Sx/N4 service.
context_name must be an existing context expressed as an alphanumeric string of 1 through 79 characters.
- **bind-address { ipv4_address | ipv6_address }**: Defines the service IP address of the Sx/N4 service, entered using IPv4 dotted-decimal or IPv6 colon-separated-hexadecimal notation.



Note The IP address family of the **bind-address** and **peer-address** must be same.

- **peer-address { ipv4_address | ipv6_address }**: Defines the IP address of the Sx/N4 peer, entered using IPv4 dotted-decimal or IPv6 colon-separated-hexadecimal notation.
- **disallow-switchover-on-peer-monitor-fail**:
Prevents the switchback of the UPF to Active state when the working status of the UPF to SMF link is unknown.
- It's possible to implement this CLI command multiple times for monitoring multiple N4/Sx connections.
- The Sx/N4 monitor state goes down when any of the monitored Sx/N4 connections are down.
- This command is disabled by default.
- A maximum of 18 peer nodes can be configured.

Configuring VPP Monitor on Active UPF and Standby UPF

Use the following configuration to configure Vector Packet Processing (VPP) monitor to trigger UPF switchover on the Active UPF if VPP goes down. This command is configured in the SRP Configuration Mode.

```

configure
  context context_name
    service-redundancy-protocol
      monitor system vpp delay-period seconds
      end

```

NOTES:

- If previously configured, use the **no monitor system vpp** CLI command to disable VPP monitoring on the Active and Standby UPF.
- **vpp delay-period seconds** : Specifies the delay period in seconds for a switchover, after a VPP failure. *seconds* must be in the range of 0 through 300.

If the delay period is a value greater than zero (0), then the switchover is initiated after the specified delay period when VPP fails. The last VPP status notification within the delay period is the final trigger for switchover action. The default value is 0 seconds, which initiates an immediate switchover.

The need for delay is to address the scenario wherein the VPP is temporarily down and the revival is in process. This implies that a switchover may not be necessary.

- This command is disabled by default.

Preventing User Plane Function Switchback

Use the following configuration to prevent the switchback of the new Standby UPF to Active state again due to Sx/N4 monitor failure in the new Active.

```
configure
context context_name
service-redundancy-protocol
monitor sx disallow-switchover-on-peer-monitor-fail timeout seconds
end
```

Use either of the following CLIs to allow switchback of the new Standby UPF to Active state.

```
no monitor sx disallow-switchover-on-peer-monitor-fail
```

Or

```
monitor sx disallow-switchover-on-peer-monitor-fail timeout 0
```

NOTES:

- **no**: Disables prevention of switchover.
 - **disallow-switchover-on-peer-monitor-fail [timeout seconds]** : Prevents the switchback of the UPF to Active state when the working status of the UPF to SMF link is unknown.
- timeout seconds**: Timeout after which the switchback is allowed even if the Sx/N4 failure status is not reset in the Standby peer. The valid values range from 0 through 2073600 (24 days).



Note Assigning 0 seconds as the timeout allows unplanned switchover.

If **timeout** keyword is not specified, the Active chassis waits indefinitely for the Sx/N4 failure status to be reset in the Standby peer.

- The default configuration is to allow unplanned switchover due to Sx/N4 monitor failure in all conditions.



Note Manual planned switchover is allowed irrespective of whether this CLI is configured or not.

Preventing Dual Active Error Scenarios

Use the following CLI configuration in CP to prevent dual Active error scenarios for UPF 1:1 redundancy.

```
configure
  user-plane-group group_name
    sx-reassociation disabled
  end
```

NOTE:

- **sx-reassociation disabled**: Disables UP Sx reassociation when the association already exists with the CP.

Resetting Sx/N4 Monitor Failure

Use the following configuration only on the Standby chassis to reset the Service Redundancy Protocol (SRP) Sx/N4 monitor failure information. This command is configured in the Exec Mode.

```
srp reset-sx-fail
```

Changing UPF State from Pending-Active to Active

Use the following configuration to change the UPF chassis state from Pending-Active to Active.

```
configure
  context context_name
    service-redundancy-protocol
      force-pactv-to-actv-timeout value_seconds
```

NOTES:

- *value_seconds*: Specifies the timeout value in seconds and must be in the range of 1-300.
- Use the **show config context *context_name*** CLI command to verify the configuration.

Monitoring and Troubleshooting

This section provides information regarding the CLI command available in support of monitoring and troubleshooting the feature.

Show Command(s) and/or Outputs

This section provides information regarding show commands and/or their outputs in support of this feature.

show srp monitor bfd

The output of this CLI command contains the following fields for the 5G UPF 1:1 Redundancy feature:

- Type:
 - (A) - Auth. probe

- (B) - BGP
- (D) - Diameter
- (F) - BFD
- (E) - EGQC
- (C) - Card
- (V) - VPP

- State:
 - (I) - Initializing
 - (U) - Up
 - (D) - Down

- GroupId
- IP Addr
- Port
- Context (VRF Name)
- Last Update

show srp monitor bgp

The output of this CLI command contains the following fields for the 5G UPF 1:1 UPF Redundancy feature:

- Type:
 - (A) - Auth. probe
 - (B) - BGP
 - (D) - Diameter
 - (F) - BFD
 - (E) - EGQC
 - (C) - Card
 - (V) - VPP
 - (S) - Sx

- State:
 - (I) - Initializing
 - (U) - Up
 - (D) - Down

- GroupId
- IP Addr
- Port
- Context (VRF Name)
- Last Update

show srp monitor sx

The output of this CLI command contains the following fields in support of Sx/N4 monitor status:

- Type:
 - (A) - Auth. probe
 - (B) - BGP
 - (D) - Diameter
 - (F) - BFD
 - (E) - EGQC
 - (C) - Card
 - (V) - VPP
 - (S) - SX
- State:
 - (I) - Initializing
 - (U) - Up
 - (D) - Down
- GroupId
- IP Addr
- Port
- Context (VRF Name)
- Last Update

show srp monitor vpp

The output of this CLI command contains the following fields for the 5G UPF 1:1 UPF Redundancy feature:

- Type:
 - (A) - Auth. probe
 - (B) - BGP

- (D) - Diameter
- (F) - BFD
- (E) - EGQC
- (C) - Card
- (V) - VPP

- State:
 - (I) - Initializing
 - (U) - Up
 - (D) - Down

- GroupId
- IP Addr
- Port
- Context (VRF Name)
- Last Update

show srp statistics

The output of this CLI command contains the following fields for the Sx/N4 Monitor—Pending-Active functionality:

- Pending-active timer started
- Pending-active timer stopped
- Pending-active to Active forced
- Pending-active to Active force-failed
- Pending-active to Active force-skipped - peer-not-sby
- Pending-active to Active force-skipped - not-PActv

L2 ICSR Support

Feature Description

UPF supports Layer 2-based (L2) ICSR in a two-server architecture to disambiguate packet forwarding between Active and Standby UPFs. UPF uses Gratuitous Address Resolution Protocol (GARP) and Unsolicited Neighbor Advertisement messages to achieve L2 ICSR.

L2 ICSR between SRP peers is configurable in the SRP context. UPF also configures a loopback interface under the same subnet as that of the physical interface. UPF supports SRP BFD monitoring to avoid the Active to Active scenario.

SRP Loopback Interface

SRP loopback interface is the loopback interface for Service IP (N3) or Next-hop IP for IP-Pools (N6). The IP addresses of these loopback interfaces must be on the same subnet as the ethernet interfaces of the context. The SRP loopback interfaces have the same IP address on both Active and Standby UPFs.

- When UPF is Standby, SRP loopback interfaces will not send ARP reply or GARP packets. For IPv6, the UPF does not respond with the Solicited or the Unsolicited Neighbor Advertisement message.
- When UPF is Standby, SRP loopback interfaces are enabled with an IP address attached inside boxer so that the UPF services bound to these interfaces remain in running state.
- When UPF transitions from any other state to the Active state, the SRP loopback interfaces send out GARP packets. For IPv6, the UPF sends Unsolicited Neighbor Advertisement messages.

The following figure illustrates the 3RU wiring diagram for non-bonded interfaces.

Figure 8: 3RU Wiring for Non-Bonded Interfaces

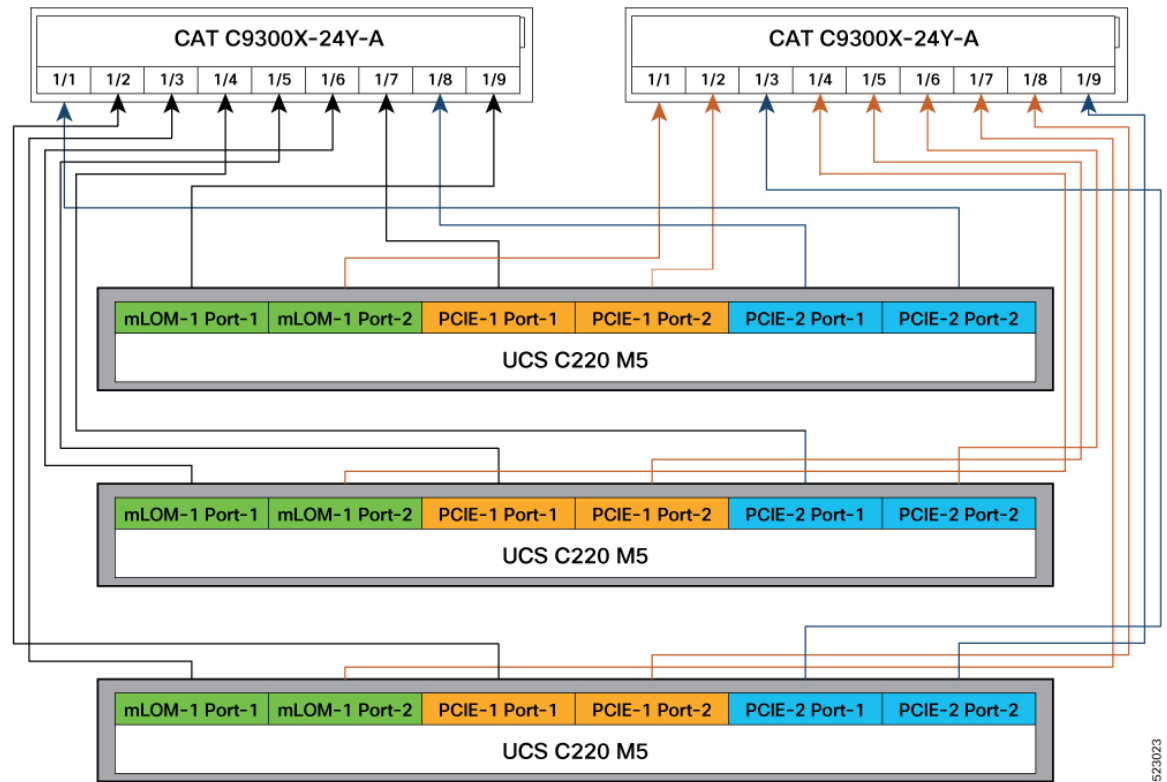

523023

How it Works

UPF directly connects gNB on N3 router or Server on N6 router in the same subnet. UPF ICSR will not be visible to gNB/N3 and Server/N6.

The L2 switch supports BFD. On all N3 and N6 subnets, the switch must have an IP address.

UPF requires Chassis-Chassis (C-R) BFD and Chassis-Router (C-R) BFD for the L2 ICSR solution to work. To avoid the Active-Active state, BFD runs between C-C and C-R. C-C BFD must have a higher timeout value than C-R BFD.

For a two-leaf network design and non-bonded UPF interfaces, each UPF connects to a separate leaf. The IP addresses of the L2 switch are part of the leaf.

The following figure illustrates the high-level diagram of L2 switch wiring for non-bonded interfaces.

Figure 9: L2 Switch Wiring for Non-Bonded Interfaces

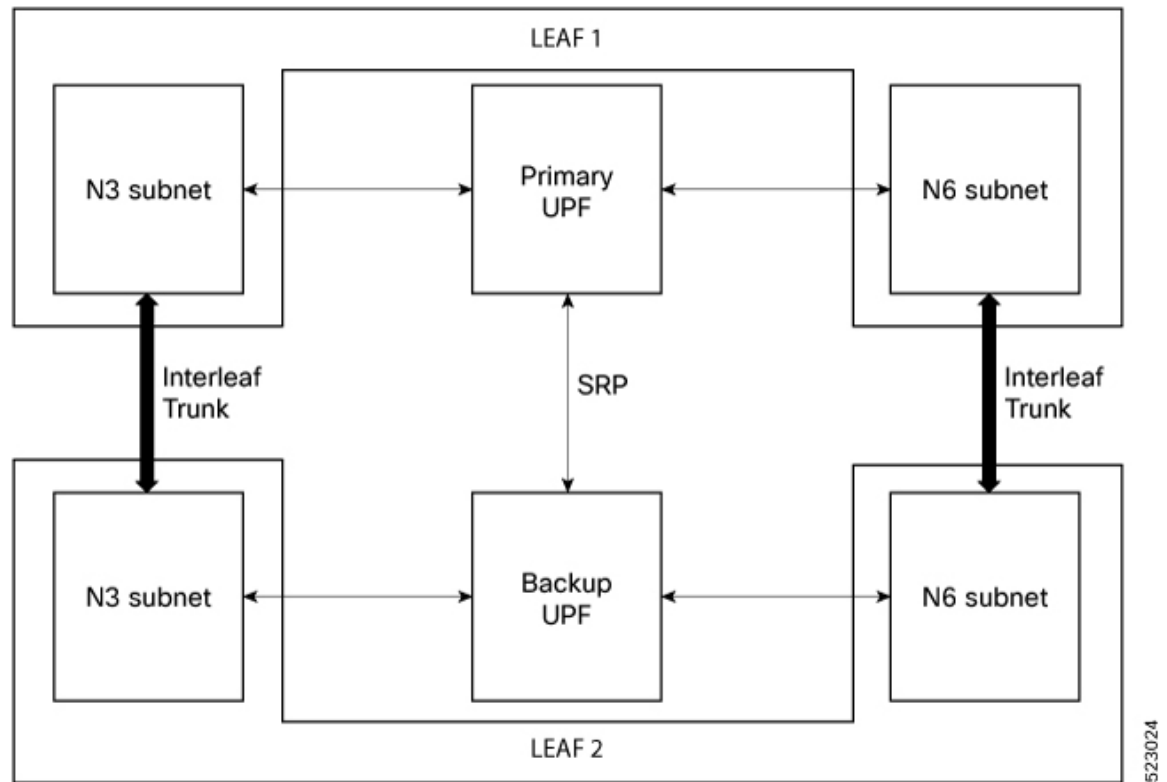

State Machine

This table provides information about the UPF states.

Table 5: States Machine

S.No.	Previous State	Internal Fault	C-R BFD	C-C BFD	SRP Link State	Next State	Pull Down BFD
1	X	Yes	X	X	X	Standby	Yes
2	X	X	Any-Down	X	X	Standby	Yes
3	X	No	All-Up	Any-Down	X	Active	No

S.No.	Previous State	Internal Fault	C-R BFD	C-C BFD	SRP Link State	Next State	Pull Down BFD
4	X	No	All-Up	All-Up	Down	No-Change	No
5	X	No	All-Up	All-Up	Up	SRP-Protocol -Decided	No

NOTES:

- For C-R BFDs going from "Not-All-Up" to "All-Up", a delay is introduced in SRP State processing to allow all C-C BFDs to reach steady state.
- To avoid the dual-active scenario, ensure that the states in row 3 of the above table do not occur in both UPFs. This must not happen in a properly functioning and configured system.

Configuring L2 ICSR in SRP Context

To enable or disable L2 ICSR between SRP peers, use the following configuration:

```
configure
  context context_name
    service-redundancy-protocol
      l2-icsr [ disable | enable ]
    end
```

NOTES:

- **disable:** Disable L2 ICSR between SRP peers. This is the default setting.
- **enable:** Enable L2 ICSR between SRP peers.

Configuring C-C and C-R BFD from Primary and Backup Chassis

To configure the C-C and C-R BFD from a Primary and Backup Chassis use the following configuration. The C-C BFD configures as multi-hop to give a different timeout value than the C-R BFD.

```
context SAEGW
bfd-protocol
  bfd multihop-peer 209.165.200.227 interval 50 min_rx 50 multiplier 6
#exit
interface S5_SGW_PGW
  ip address 209.165.200.226 255.255.255.0
  ipv6 address 2001:DB8:A:B::1/64 secondary
  bfd interval 50 min_rx 50 multiplier 3
#exit
ip route static bfd S5_SGW_PGW 209.165.200.225
ip route static multihop bfd bfdcc 209.165.200.226 209.165.200.227
ip igmp profile default
#exit
```

Verifying L2 ICSR Configuration

To verify the configuration, use the following commands:

- **show config context srp**

- **show srp monitor all**
- **show srp info**

The following is a sample output of **show config context srp** command:

```
[local]upf# show config context srp
context srp
bfd-protocol
#exit
service-redundancy-protocol
  checkpoint session duration non-ims-session 0
  checkpoint session duration ims-session 0
  force-pactv-to-actv-timeout 1
  l2-icsr enable
[output truncated]
```

The following is a sample output of **show srp monitor all** command:

```
[local]upf# show srp monitor all
+----- Type: (A) - Auth. probe (B) - BGP (D) - Diameter (F) - BFD (E) - EGQC (C) - Card
| (V) - VPP (S) - Sx
|
|+---- State: (I) - Initializing (U) - Up (D) - Down
||
||+---- GroupId
|||
vvv IP Addr Port Context(VRF Name) Last Update
-----
FU0 209.165.200.225 3785 SAEGW Thu Jan 05 01:13:08 2023
FU0 209.165.200.227 3785 SAEGW Thu Jan 05 01:13:08 2023
FU0 209.165.200.230 3785 ISP Thu Jan 05 01:13:08 2023
FU0 209.165.200.231 3785 ISP Thu Jan 05 01:13:08 2023
-----
[local]upf#
[local]upf# context SAEGW
[SAEGW]upf# show bfd neighbors >>>>
All the time intervals are in ms
OurAddr NeighAddr LD/RD DtctTime State Intf
209.165.200.226 209.165.200.225 1/1090519046 150 Up S5_SGW_PGW
209.165.200.226 209.165.200.227 2/1 300 Up
Total Sessions 2
Sessions in UP state 2
```

The following is a sample output of **show srp info** command:

```
sample o/p:
[local]l110-ru34-up1# show srp info
Service Redundancy Protocol:
-----
Context: srp
Local Address: 209.165.201.234
Chassis State: Active
Chassis Mode: Primary
Chassis Priority: 47299
Local Tiebreaker: 00-50-56-AE-EE-8D
Route-Modifier: 33

Peer Remote Address: 209.165.201.235
Peer State: Standby
Peer Mode: Backup
Peer Priority: 1673325643
Peer Tiebreaker: 00-00-00-00-00-00
Peer Route-Modifier: 0
Last Hello Message received: Tue Jan 10 04:40:43 2023 (2 seconds ago)
```

```

Peer Configuration Validation: Complete
Last Peer Configuration Error: None
Last Peer Configuration Event: Tue Jan 10 04:32:31 2023 (494 seconds ago)
Last Validate Switchover Status: None
Connection State: Connected
Next Peer Audit Scheduled:
Periodicity Audit Scheduled : -
Daily-Start-time Audit Scheduled : -
Cron-Job Audit Scheduled : -
Peer Audit State: Unknown
Last Peer Audit Type: Unknown
Last Peer Audit Successful: -
DSCP Configuration:
Control flow : be
Session flow : be
Feature Configured-status Operational-status
allow-volte-data-traffic: Disabled Enabled
allow-all-data-traffic: Disabled Enabled

[local]l110-ru34-up1#

```

OAM Support

This section describes operations, administration, and maintenance information for this feature.

Show Command Support

Use the **show ip interface** or **show ipv6 interface** command to display the GARP statistics.

The following is a sample output of this command:

```

[EPC2]l110-ru32-up1# show ip interface
Interface Name           : S5_SGW_PGW
Interface Type           : Broadcast
Description              :
VRF                      : None
IP State                 : UP (Bound to 1/10 vlan id 2141, 802.1P prior 0, ifIndex
  17432595)
IP Address               : 209.165.200.226
Subnet Mask              : 255.255.255.0
Bcast Address           : 209.165.200.255
MTU                      : 1500
Resoln Type             : ARP
ARP timeout              : 1200 secs
L3 monitor LC-port switchover : Disabled
Number of Secondary Addresses : 1
  IPv6 Address: 2001:DB8:A:B::1/64
GARP sent through this interface : 45
GARP sent for this interface   : 0
GARP sent for/through this interface successfully: 45
Last GARP sent for/through this interface: Tue Dec 06 18:40:26 2022

```



CHAPTER 4

ADC for Dynamic Rules

Table 6: Feature History

Feature Name	Release Information	Description
ADC Dynamic Rules over Gx	2024.02.0	<p>UPF leverages the dynamic ADC rules for traffic matching and charging. This feature allows the service providers to manage IoT devices, such as connected cars, and charge their subscribers based on the traffic flows classified by SMF or UPF. With this traffic classification, the service providers enable service monetization.</p> <p>In summary, SMF first processes the dynamic ADC rules received from PCF with TDF-App-Identifier, Service ID, and Rating group. SMF then sends this information to UPF to classify ruledefs and perform charging.</p> <p>Default Setting: Enabled – Always-on</p>

- [Feature Description, on page 43](#)
- [How it Works, on page 43](#)
- [OAM Support, on page 44](#)

Feature Description

UPF processes N4 messages received from SMF and installs, removes, and modifies the message entities (PDR/URR/FAR/QER) of dynamic ADC rules.

UPF matches the configured ruledef with the TDF-App-Identifier AVP received in the dynamic ADC rule as part of PDR installation from SMF. If matched, UPF classifies the packets and charges the subscribers as per the Rating Group and Service ID of the Dynamic rule PDR.

How it Works

PCRF installs a dynamic ADC rule with charging rule definition on SMF. UPF receives the N4 messages from SMF containing the dynamic ADC rule-related PDRs, URRs, QERs, and FARs. The dynamic ADC rule PDR contains the Application ID corresponding to the TDF-App-Identifier received from the PCRF and the Mute notification. UPF does not enable any Application Start/Stop triggers as Mute is enabled.

Upon receiving the N4 message, UPF matches the ruledef pointed using the Application ID/TDF-App-Identifier. UPF then charges the packets matching to this ruledef against the URR received and applies bandwidth policing based on the QER received for the dynamic ADC rule PDR.

UPF supports the following three use cases to support dynamic ADC rules:

- **Installing a Dynamic ADC Rule per Subscription:** Upon receiving the dynamic ADC rule from PCRF, SMF installs the rule and sends an N4 Session Establishment Request to UPF to create PDR, QER, FAR, and URR. The Create PDR Request for this dynamic ADC rule contains the TDF-App-Identifier and Mute AVP enabled for all dynamic ADC rules.

UPF matches the configured ruledef with the TDF-App-Identifier and charges the packets according to the RG/SI received in the Dynamic ADC rule. UPF does not generate the N4 Session report for APP-START/STOP, as Mute notifications are enabled from PCRF on SMF during rule install.

- **Modifying a Dynamic ADC Rule from PCRF/SMF:** PCRF sends a Re-authorization request (RAR) to SMF along with a Dynamic ADC Rule Modification request. SMF then sends a Session Modification Request to UPF to update QER containing the updated gate status and MBR values.

UPF performs modifications of the AVPs and sends a N4 Session Modification Response to SMF.

- **Removing a Dynamic ADC Rule from PCRF/SMF:** UPF receives an N4 Modify Request with Remove PDRs and QERs corresponding to the dynamic ADC rule. UPF also receives Remove URRs occasionally, if it is the last rule for that Rating-Group/Service-ID.

Upon receiving the N4 Modify Request, UPF stops matching the rule for the ruledef pointed by the TDF-App-Identifier from the Session Modification Request.

For detailed information on dynamic ADC rules, see the *UCC 5G SMF Configuration and Administration Guide* applicable for the release.

OAM Support

This section describes operations, administration, and maintenance support for this feature.

Show Command Output

This section describes the show commands supported in this feature.

show subscribers user-plane-only full all

The output of the show command **show subscribers user-plane-only full all** has been enhanced to display the number of associated ADC PDRs.

```
[local]UPF1# show subscribers user-plane-only full all

Local SEID       : [0x0004000000000002] 1125899906842626
Remote SEID      : [0x00000004bebf6665] 20380083813
State            : Connected
Connect Time     : Wed Apr 3 12:45:51 2024
Idle time        : 00h00m07s
Access Type:     uplane-ipv4v6           Network Type: IP
user-plane-service-name: user-plane-service
active-service-scheme-name:
Callid: 00004e23
Rulebase: adcl
```

```

Interface Type: N4
eMPS Session: No
eMPS Session Priority: 0
Session-Type: normal
Precedence-order: 0
Data Queue: 0
Card/Cpu: 1/0                               Sessmgr Instance: 1
IP address: 2001:cb0:0:3::4e:2301,11.11.0.4
Next Hop Ip Address: N/A,
Source context: EPC2-UP                       Destination context: ISP
PDN-Instance: cnpgw
User-plane-Sx-addr: 20.20.20.106
Control-plane-Sx-addr: 20.20.20.3
Number of associated PDRs : 4
Number of associated ADC PDRs : 2
Number of associated FARs : 4
Number of associated QERs : 3
Number of associated BARs : 0
Number of associated URRs : 5
Number of associated BLIs : 1
Uplink APN AMBR (bps) : 100000                 Downlink APN AMBR (bps) : 100000
active input acl: n/a                          active output acl: n/a
active input ipv6 acl: n/a                      active output ipv6 acl: n/a
Bandwidth Policy: n/a
FW-and-NAT Policy: n/a
FW-and-NAT Policy ID: n/a
Firewall Policy IPv4: n/a
Firewall Policy IPv6: n/a
NAT Policy NAT44: n/a
NAT Policy NAT64: n/a
Converged Session: No                          Converged Peer Callid:      n/a
Visited Call: No
Subscriber Parameters:
IMSI: 123456781300001
IMEI: 123456781312381
MSISDN: 22331101101010
Rat Type: 6
Old Rat Type: n/a
MCC MNC: 123456
SGSN Address: 20.20.20.15
ULI: TAI+ECGI=21635400152163540000000d00
CF Policy ID: n/a
GX CF Policy ID: n/a
S-NSSAI: 0x01000002
Roaming Status: Homer
Old Roaming Status: n/a
input pkts: 5                                  output pkts: 5
input bytes: 5200                              output bytes: 200
input bytes dropped: 0                          output bytes dropped: 0
input pkts dropped: 0                           output pkts dropped: 0
CF Buffered Uplink Packets: 0                   CF Buffered Downlink Packets: 0
CF Buffered Uplink Bytes: 0                     CF Buffered Downlink Bytes: 0
Uplink Packets in Buffer: 0                      Downlink Packets in Buffer: 0
Buff Over-limit Uplink Pkts: 0                  Buff Over-limit Downlink Pkts: 0
DDN buffered pkts : 0                           DDN buffered bytes : 0
DDN buffer overflow drop pkts : 0               DDN buffer overflow drop bytes : 0
pk rate from user(bps): 0                       pk rate to user(bps): 0
ave rate from user(bps): 0                       ave rate to user(bps): 0
sust rate from user(bps): 0                      sust rate to user(bps): 0
pk rate from user(pps): 0                       pk rate to user(pps): 0
ave rate from user(pps): 0                       ave rate to user(pps): 0
sust rate from user(pps): 0                     sust rate to user(pps): 0
ipv4 bad hdr: 0                                 ipv4 ttl exceeded: 0
ipv4 fragments sent: 0                          ipv4 could not fragment: 0

```

show subscribers user-plane-only callid callid pdr full all

```

ipv4 bad length trim: 0
input pkts dropped (0 mbr): 0
ipv4 input acl drop: 0
ipv6 input acl drop: 0
ip source violations: 0
ipv6 bad hdr: 0
ipv4 icmp packets dropped: 0
APN AMBR Uplink Pkts Drop: 0
APN AMBR Uplink Bytes Drop: 0
APN AMBR Uplink Pkts IP pref lowered: 0
0
APN AMBR Uplink Bytes IP pref lowered: 0
0
ITC Uplink Pkts Drop: 0
ITC Uplink Bytes Drop: 0
ITC Uplink Pkts IP pref lowered: 0
ITC Uplink Bytes IP pref lowered: 0
ITC Terminated Flows:: 0
Flow Action Terminated Flows: 0
ToS marked Uplink Pkts: 0
CC Dropped Uplink Pkts: 0
CC Dropped Uplink bytes: 0
Uplink Inflight Pkts: 0
QFI Mismatch Uplink Pkts Drop: 0
Total QoS-Group(s) Active: 0
DNS-to-EDNS Uplink Pkts: 0
EDNS Response Received: 0

output pkts dropped (0 mbr): 0
ipv4 output acl drop: 0
ipv6 output acl drop: 0
ipv4 output no-flow drop: 0
ipv6 bad length trim: 0

APN AMBR Downlink Pkts Drop: 0
APN AMBR Downlink Bytes Drop: 0
APN AMBR Downlink Pkts IP pref lowered:
0
APN AMBR Downlink Bytes IP pref lowered:
0
ITC Downlink Pkts Drop: 0
ITC Downlink Bytes Drop: 0
ITC Downlink Pkts IP pref lowered: 0
ITC Downlink Bytes IP pref lowered: 0
ITC Redirected Flows: 0
Flow Action Redirected Flows: 0
ToS marked Downlink Pkts: 0
CC Dropped Downlink Pkts: 0
CC Dropped Downlink Bytes: 0
Downlink Inflight Pkts: 0
QFI Mismatch Downlink Pkts Drop: 0
DNS-to-EDNS Uplink Bytes: 0

Flow information:
  Current Active Flows:
    TCP: 1
    UDP: 0
  Total Flows:
    TCP: 1
    UDP: 0
    FP: 1

```

show subscribers user-plane-only callid *callid* pdr full all

The output of the show command **show subscribers user-plane-only callid *callid* pdr full all** has been modified to display the following new fields:

- TDF App Id
- TDF Notifications
- Total ADC PDRs found

```
[local]UPF1# show subscribers user-plane-only callid 00004e21 pdr full all
```

```

Callid: 00004e21
Interface Type: N4
IP address: 2001:cb0:0:3::4e:2301,11.11.0.4
PDR-ID: 0x0003
Rule Name: port-2000
TDF App Id: port-2000
TDF Notifications: Disabled
Hits: 1 Match Bypassed: 4
Matched Bytes: 200 Matched Packets: 5
Precedence: 55
Source Interface: Core
Source Interface Type: N/A
SDF Filter(s):

```

```

No SDF filters present
Local F-TEID:          0x0
Local F-TEID IP Addr:
  IPv4:                N/A
  IPv6:                N/A
Outer header removal:
Application ID:        N/A
Associated FARID:      0x80000001
Destination Interface: Access
Apply Action:          FORWARD
Outer Header Creation: GTP-U/UDP/IPv4
Remote TEID:          0x3000000
Transport Level Marking: N/A
Transport Level Marking Options:
  Copy Inner:          No
  Copy Outer:          No
Inner Packet Marking: N/A
Remote IP Address:    20.20.20.15
Remote Port:          N/A
Associated QERIDs:    2
QER-IDs               Correlation-ID
  0x00000003           n/a
  0x00000001           0x0000000E
Associated URRIDs:    4
URR-IDs               Parent URR-ID
  0x00000011           0x80000002
  0x00000027           n/a
  0x80000002           n/a
  0x80000009           n/a
Activation Time:      N/A
Deactivation Time:    N/A
Bearer Level Info-id: 1
  5QI:                 5
  ARP:                 20
  Charging Id:         4

PDR-ID:               0x0004
Rule Name:             port-2000
TDF App Id:           port-2000
TDF Notifications:    Disabled
Hits:                 1 Match Bypassed: 4
Matched Bytes:        5200 Matched Packets: 5
Precedence:           55
Source Interface:     Access
Source Interface Type: S5U(1)
SDF Filter(s):
  No SDF filters present
Local F-TEID:          0x8001
Local F-TEID IP Addr:
  IPv4:                20.20.20.46
  IPv6:                N/A
Outer header removal: GTP-U/UDP/IPv4
Application ID:        N/A
Associated FARID:      0x80000002
Destination Interface: Core
Apply Action:          FORWARD
Outer Header Creation:
Remote TEID:          0x0
Transport Level Marking: N/A
Transport Level Marking Options:
  Copy Inner:          No
  Copy Outer:          No
Inner Packet Marking: N/A
Remote IP Address:

```

```
show subscribers user-plane-only callid callid pdr full all
```

```

Remote Port:                N/A
Associated QERIDs:          2
  QER-IDs                   Correlation-ID
  0x00000003                n/a
  0x00000001                0x0000000E
Associated URRIDs:          4
  URR-IDs                   Parent URR-ID
  0x00000011                0x80000002
  0x00000027                n/a
  0x80000002                n/a
  0x80000009                n/a
Activation Time:            N/A
Deactivation Time:          N/A
Bearer Level Info-id:      1
  5QI:                       5
  ARP:                        20
  Charging Id:                4

PDR-ID:                     0x0005
Rule Name:                   ipv6rsradl
TDF App Id:                  N/A
TDF Notifications:           N/A
Hits:                        3 Match Bypassed:      0
Matched Bytes:               312 Matched Packets:     3
Precedence:                  1
Source Interface:CP-function
Source Interface Type: N/A
SDF Filter(s):
  No SDF filters present
Local F-TEID:                0x8000a001
Local F-TEID IP Addr:
  IPv4:                      20.20.20.46
  IPv6:                      N/A
Outer header removal:        GTP-U/UDP/IPv4
Application ID:              N/A
Associated FARID:            0x0003
Destination Interface: Access
Apply Action:                FORWARD
Outer Header Creation:       GTP-U/UDP/IPv4
Remote TEID:                 0x3000000
Transport Level Marking:     N/A
Transport Level Marking Options:
  Copy Inner:                 No
  Copy Outer:                 No
  Inner Packet Marking:       N/A
Remote IP Address:           20.20.20.15
Remote Port:                 N/A
Associated QERIDs:          1
  QER-IDs                   Correlation-ID
  0x00000002                n/a
Associated URRIDs:          0
Activation Time:            N/A
Deactivation Time:          N/A
Bearer Level Info-id:      N/A

PDR-ID:                     0x0006
Rule Name:                   ipv6rsraul
TDF App Id:                  N/A
TDF Notifications:           N/A
Hits:                        0 Match Bypassed:      0
Matched Bytes:               0 Matched Packets:     0
Precedence:                  1
Source Interface:            Access
Source Interface Type:       S5U(1)

```

```
SDF Filter(s):
Filter 1
  Protocol:          ICMPV6
  Src IP Addr:       ANY
  Src Port:          ANY
  Dst IP Addr:       ff05::2/128
  Dst Port:          ANY
  SPI:               0
Filter 2
  Protocol:          ICMPV6
  Src IP Addr:       ANY
  Src Port:          ANY
  Dst IP Addr:       ff02::2/128
  Dst Port:          ANY
  SPI:               0
Filter 3
  Protocol:          ICMPV6
  Src IP Addr:       ANY
  Src Port:          ANY
  Dst IP Addr:       ff01::2/128
  Dst Port:          ANY
  SPI:               0
Local F-TEID:       0x8001
Local F-TEID IP Addr:
  IPv4:              20.20.20.46
  IPv6:              N/A
Outer header removal: GTP-U/UDP/IPv4
Application ID:      N/A
Associated FARID:    0x0004
  Destination Interface: CP-function
  Apply Action:      FORWARD
Outer Header Creation: GTP-U/UDP/IPv4
Remote TEID:        0x4
Transport Level Marking: N/A
Transport Level Marking Options:
  Copy Inner:        No
  Copy Outer:        No
Inner Packet Marking: N/A
Remote IP Address:   20.20.20.3
Remote Port:         N/A
Associated QERIDs:   0
Associated URRIDs:   0
Activation Time:     N/A
Deactivation Time:   N/A
Bearer Level Info-id: N/A
```

Total ADC PDRs found: 2

Total PDRs found: 4

■ show subscribers user-plane-only callid callid pdr full all



CHAPTER 5

APN ACL Support

This chapter covers the following topics:

- [Feature Summary and Revision History, on page 51](#)
- [Feature Description, on page 52](#)
- [IP Source Violation, on page 55](#)
- [Gating Control, on page 55](#)

Feature Summary and Revision History

Summary Data

Table 7: Summary Data

Applicable Product (s) or Functional Area	5G-UPF
Applicable Platforms	VPC-SI SMI
Feature Default Setting	Enabled – Always-on
Related Changes in this Release	Not Applicable
Related Documentation	<i>UCC 5G UPF Configuration and Administration Guide</i>

Revision History

Table 8: Revision History

Revision Details	Release
Gating control feature is enhanced to display the gating status as enabled/disabled through an additional QER per PDR for dynamic rules.	2024.01.1

Revision Details	Release
A configurable mechanism has been introduced to apply traffic classification and policy enforcement on selective subscriber sessions.	2021.01.0
First introduced.	2020.02.0

Feature Description

IP Access Lists, commonly known as Access Control Lists (ACLs), control the flow of packets into and out of the system. The configuration is per-context basis and consists of "rules" (ACL rules) or filters that control the action applicable for packets that match the filter criteria. Once configured, an ACL can be applied to an individual subscriber. Separate ACLs can be created for IPv4 and IPv6 access routes.

The following are the two main aspects of ACLs:

- Rule(s)
- Rule Order

Rule(s)

A single ACL consists of one or more ACL rules. Each rule is a filter configured to take a specific action when packets match a specific criteria.

Each rule specifies the action to take when a packet matches the specifies criteria. This section discusses the rule actions and criteria supported by the system.

Actions

ACLs specify that one of the following actions can be taken on a packet that matches the specified criteria:

- **Permit:** The packet is accepted and processed for classification and policy enforcement.
- **Deny:** The packet is rejected.
- **Redirect CSS:** The behaviour is the same as Permit action.

NOTES:

- In UPF, it's recommended to use Permit option instead of Redirect CSS. Functionally, both the options are equivalent in UPF. Support for Redirect CSS option is only for backward compatibility and should be used only in such scenarios.
- Configured ACLs consisting of no rules imply a "deny any" rule. This is the default behavior for an empty ACL.
- In UPF, if ACLs aren't associated with an APN, then call is up. By default, traffic is processed for classification and policy enforcement. For non-UPF architecture, call fails as Redirect CSS is mandatory.
- If only Deny option is given in the ACL for certain traffic, then to pass the rest of the traffic, Permit option must be given explicitly.

- If only permit option is given in the ACL for certain traffic, then to pass the rest of the traffic, permit must be given explicitly for that traffic.
- Router Advertisement/Router Solicitation (RA/RS) packets are candidate for ACL. So, take caution in putting the IPv6 ACL.
- Configuration change in ACL is applied for a new call and not on the existing call.

Criteria

Each ACL consists of one or more rules specifying the criteria that packets will be compared against.

The following criteria are supported:

- **Any**: Filters all packets
- **Host**: Filters packets based on the source host IP address
- **ICMP**: Filters Internet Control Message Protocol (ICMP) packets
- **IP**: Filters Internet Protocol (IP) packets
- **Source IP Address**: Filter packets based on one or more source IP addresses
- **TCP**: Filters Transport Control Protocol (TCP) packets
- **UDP**: Filters User Datagram Protocol (UDP) packets

Each of the above-mentioned criteria is described in detail in the sections that follow.

- **Any**: The rule applies to all packets.
- **Host**: The rule applies to a specific host as determined by its IP address.
- **ICMP**: The rule applies to specific Internet Control Message Protocol (ICMP) packets, Types, or Codes. ICMP type and code definitions can be found at www.iana.org (RFC 3232).
- **IP**: The rule applies to specific IP packets or fragments.
- **Source IP Address**: The rule applies to specific packets originating from a specific source address or a group of source addresses.
- **TCP**: The rule applies to any TCP traffic and could be filtered on any combination of source/destination IP addresses, a specific port number, or a group of port numbers. TCP port numbers definitions can be found at www.iana.org.
- **UDP**: The rule applies to any UDP traffic and could be filtered on any combination of source/destination IP addresses, a specific port number, or a group of port numbers. UDP port numbers definitions can be found at www.iana.org.

Rule Order

A single ACL can consist of multiple rules. Each packet is compared against each of the ACL rules, in the order in which they were entered, until a match is found. Once a match is identified, all subsequent rules are ignored.

Limitations

Following are the known limitations of APN ACL feature in UPF:

- Readdress option in ACL is not supported.
- Redirect ACL for context and next-hop is not supported.
- Log option is not supported in ACLs.
- APN-level bulkstats for ACL drops (only IPv4) are supported.

Configuring ACL

To apply the ACL to individual subscriber through APN, use the following configuration:

```

configure
  context dest_context_name [ -noconfirm ]
    { ip | ipv6 } access-list acl_list_name
      { permit | deny | redirect }acl
    end
configure
  apn apn_name
    { ip | ipv6 } access-group acl_list_name [ in | out ]
  end

```

Notes:

- The ACL to be applied must be in the destination context of the APN (which can be different from the context where the APN is configured).
- If neither the **in** nor the **out** keyword is specified, the ACL will be applied to all inbound and outbound packets.
- Four access-groups can be applied for each APN, for example:

```

ip access-group acl_list_name_1 in
ip access-group acl_list_name_2 out
ipv6 access-group acl_list_name_3 in
ipv6 access-group acl_list_name_4 out

```

Verifying ACL Configuration

Use the following CLI commands in Exec mode to check if your ACL lists were applied properly, and also for packet drops due to ACL:

- **show subscriber user-plane-only full all**
- **show subscribers user-plane-only full callid** *call_id*
- **show user-plane-service pdn-instance statistics** *name*

IP Source Violation

Source validation requires the source address of incoming packets to match the IP address of the subscriber during the session. This allows operators to configure the network to prevent problems when a user gets handed back and forth between two gateways several times during a handoff scenario.

When the UPF receives a subscriber packet with a source IP address violation, the system increments the IP source violation drop-limit counter and starts the timer for the IP source violation period. Every subsequent packet that is received with a bad source address during the IP source violation period causes the drop-limit counter to increment. For example, if you set the drop limit to 10, after 10 source violations, the call is dropped. The detection period timer continues to count throughout this process.

The following must be configured in the User Planes APN configuration:

```
ip source-violation { ignore | check [ drop-limit limit ] } [
exclude-from-accounting ]
```



Note For information on IP source violation CLI commands, refer to the *StarOS Command Line Interface Reference*.

Gating Control

Table 9: Feature History

Feature Name	Release Information	Description
Gating Control Using Additional QER	2024.01.1	<p>The number of QERs per PDR supported in UPF is increased from two to three in this release.</p> <p>All rules and filters are sent to UPF through PDRs. SMF sends an additional QER for dynamic rules installed on default QFI/bearer. The Gate Status IE indicates whether the gate is open or closed.</p> <p>Default Setting: Not Applicable</p>

Gating Control in the UPF enables or disables the forwarding of IP packets belonging to a service data flow or detected application's traffic to pass through to the desired endpoint. See 3GPP TS 23.203, subclause 4.3.2.

The SMF controls the gating status in the UPF by creating QERs associated with the PDRs for service data flow(s) or application's traffic to be detected. The QER associated with the Gate Status IE indicates whether the service data flow or detected application traffic is allowed to be forwarded (the gate is open) or to be discarded (the gate is closed) in the uplink and/or in downlink directions.

The default PDRs two QERs get associated to the dynamic rule's PDRs on default QFI/bearer. Therefore, SMF creates an additional QER to display the GATE status for the dynamic rule on default QFI/bearer. The additional QER gets associated with the PDR in the dynamic rule. Hence, the UPF supports up to three QERs per PDR association.

The UPF identifies the UL and DL flows by the Source Interface IE in the PDI of the PDRs or the destination Interface IE in the FARs. The UPF applies UL and DL gating accordingly.

The SMF requests the UPF to discard the packets that are received for the PDR by setting the gate fields in the Gate Status IE of QERs to CLOSED.



CHAPTER 6

APN AMBR Traffic Policing

- [Feature Summary and Revision History, on page 57](#)
- [Feature Description, on page 58](#)
- [Configuring the APN AMBR Traffic Policing Feature, on page 58](#)
- [Monitoring and Troubleshooting, on page 59](#)

Feature Summary and Revision History

Summary Data

Table 10: Summary Data

Applicable Product (s) or Functional Area	5G-UPF
Applicable Platforms	VPC-SI SMI
Feature Default Setting	Disabled – Configuration Required
Related Changes in this Release	Not Applicable
Related Documentation	Not Applicable

Revision History

Table 11: Revision History

Revision Details	Release
First introduced.	2021.01.0

Feature Description

The APN-AMBR is a subscription parameter that is stored per APN in the HSS. S-GW provides APN-AMBR during default bearer establishment procedure. APN-AMBR limits the aggregate bit rate that can be expected to be provided across all non-GBR bearers and across all PDN connections of the same APN. Each of those non-GBR bearers can potentially utilize the entire APN-AMBR, for example, when the other non-GBR bearers do not carry any traffic. The P-GW enforces the APN-AMBR in downlink and uplink direction.

Limitations

The `token-replenishment-interval` and `violate-action shape` CLI commands are not supported.

Configuring the APN AMBR Traffic Policing Feature

This section describes how to configure the APN-AMBR Traffic Policing feature.

```
configure
    context context_name
        apn apn_name
            apn-ambr rate-limit direction { downlink | uplink } [ burst-size
{ auto-readjust duration { milliseconds msec | seconds } | violate-action
{ drop | lower-ip-precedence | transmit }
            end
```

NOTES:

- **rate-limit direction { downlink | uplink }**: Specifies that the rate limit is to be applied to either the downlink (network to subscriber) traffic or the uplink (subscriber to network) traffic.
- **burst-size { auto-readjust duration milliseconds msec | seconds }**: This parameter is used by policing algorithms to permit short bursts of traffic not to exceed the allowed data rates. It's the maximum size of the token bucket.
 - **auto-readjust duration seconds**: The duration (in seconds) used in this burst size calculation: burst size = peak data rate/8 * auto-readjust duration.
 - Seconds must be an integer value from 1-30. Default is 1 second.
 - **milliseconds**: msec must be an integer value from 100-900, in increments of 100 milliseconds. For example, 100, 200, or 300, and so on.
- **violate-action { drop | lower-ip-precedence | transmit }**: The action that the P-GW takes when the data rate of the bearer context exceeds the AMBR.
 - **drop**: Drops violating packets.
 - **lower-ip-precedence**: Sets the DSCP value to zero ("best effort") for violating packets.
 - **transmit**: Transmits violating packets. This is the default behavior of the feature.
- Prior to this feature, the default behavior was to drop the violating packets.

Monitoring and Troubleshooting

This section provides information about the commands available to monitor and/or troubleshoot the APN-AMBR Traffic Policing feature.

Show Commands and/or Outputs

This section provides information about the show commands available for monitoring and/or troubleshooting the APN-AMBR Traffic Policing feature.

- **show user-plane-service pdn-instance name <apn_name>**

Use this show command in UPF to see if the rate limit is enabled/disabled, burst size, and other such parameters for downlink/uplink traffic:

- APN-AMBR
 - Downlink Apn Ambr: Indicates if the rate limit is enabled or disabled for downlink traffic.
 - Burst Size: Indicates the burst size of the downlink traffic.
 - Auto Readjust: Indicates if the auto-readjust is enabled or disabled for downlink burst size.
 - Auto Readjust Duration: Indicates the duration used in downlink burst size calculation.
 - Burst Size(bytes): Indicates the burst size in bytes.
 - Violate Action: Indicates the action that the P-GW takes when the data rate of the bearer context exceeds the AMBR for downlink traffic.
 - Uplink Apn Ambr: Indicates if the rate limit is enabled or disabled for uplink traffic.
 - Burst Size: Indicates the burst size of the uplink traffic.
 - Auto Readjust: Indicates if the auto-readjust is enabled or disabled for uplink burst size.
 - Auto Readjust Duration: Indicates the duration used in uplink burst size calculation.
 - Burst Size(bytes): Indicates the burst size in bytes.
 - Violate Action: Indicates the action that the P-GW takes when the data rate of the bearer context exceeds the AMBR for uplink traffic.
 - Token Replenishment Interval: Indicates the token replenishment interval duration.

- **show sub user-plane-only full all**

Use this show command in UPF to see the count of packets that are dropped, and IP precedence lowered due to APN-AMBR policer. The following fields are introduced in support of this feature:

- APN AMBR Uplink Pkts Drop: Indicates the number of APN-AMBR packets that are dropped for uplink traffic.

- APN AMBR Uplink Bytes Drop: Indicates the number of APN-AMBR bytes that are dropped for uplink traffic.
- APN AMBR Uplink Pkts IP pref lowered: Indicates the number of APN-AMBR uplink packets for which IP precedence is lowered.
- APN AMBR Uplink Bytes IP pref lowered: Indicates the number of APN-AMBR uplink bytes for which IP precedence is lowered.
- APN AMBR Downlink Pkts Drop: Indicates the number of APN-AMBR packets that are dropped for downlink traffic.
- APN AMBR Downlink Bytes Drop: Indicates the number of APN-AMBR bytes that are dropped for downlink traffic.
- APN AMBR Downlink Pkts IP pref lowered: Indicates the number of APN-AMBR downlink packets for which IP precedence is lowered.
- APN AMBR Downlink Bytes IP pref lowered: Indicates the number of APN-AMBR downlink bytes for which IP precedence is lowered.



CHAPTER 7

Bulk Statistics Support

- [Feature Summary and Revision History, on page 61](#)
- [Feature Description, on page 62](#)

Feature Summary and Revision History

Summary Data

Table 12: Summary Data

Applicable Product (s) or Functional Area	5G-UPF
Applicable Platforms	VPC-SI SMI
Feature Default Setting	Enabled – Always-on
Related Changes in this Release	Not Applicable
Related Documentation	<i>UCC 5G UPF Configuration and Administration Guide</i>

Revision History

Table 13: Revision History

Revision Details	Release
The following new bulk statistic schemas are now supported: <ul style="list-style-type: none"> • P2P Schema • Sx Schema • System Schema • Userplane Schema 	2021.01.0
First introduced.	2020.02.0

Feature Description

This chapter identifies bulk statistic schemas for the Cisco Ultra Cloud 5G User Plane Function (UPF) software release.

Bulk statistics is a collection of software features and framework that collects and exports the important performance and health-related statistics of the packet core node to an external node. These statistics provide an effective way for the operators to perform the following functions:

- Monitor the overall health and performance of the nodes.
- Help take corrective actions.
- Optimize the packet core network for better utilization.
- Reduce the overall operation expenses.

The individual statistics are configured to be collected in a group called 'schema.'

The system-supported bulk statistics allows operators to choose statistics that are of importance to them and configure the presentation format. This simplifies the post-processing of statistical data because it allows data formatting that facilitates external, backend processors to parse it.

Statistics or bulk statistics reporting is important on a Mobile Packet Core node. For a product to be deployed in the network, it has to support statistics that meets Carrier Grade requisites.

Operators use bulk statistics for the following:

- Performance KPI monitoring
- Network Fault analysis and debugging
- Network Optimization
- Traffic pattern analysis
- Node health analysis

When used along with an element management system (EMS), the data can be parsed, archived, and graphed.

In the 5G environment, the system can be configured to collect for the following network functions:

- Access and Mobility Management Function (AMF)
- Network Repository Functions (NRF)
- Network Slice Selection Functions (NSSF)
- Policy Control Function (PCF)
- Session Management Function (SMF)
- User Plane Function (UPF)

The system supports the configuration of up to four sets (primary and secondary) of receivers. Each set is configured to collect specific sets of statistics from the supported list of schemas. Statistics can be pulled manually from the system or sent at configured intervals. The bulk statistics are stored on the receivers in files.

You can configure the format of the bulk statistic data files. You can specify the following:

- Format of the filename
- File headers and footers to include information such as the date, system hostname, and system uptime.
- IP address of the system generating the statistics (available for only for headers and footers)
- Time that the file was generated.

An EMS is capable of further processing the statistics data through XML parsing, archiving, and graphing. The Bulk Statistics Server component of an EMS parses collected statistics and stores the information in its PostgreSQL database. It can also generate XML output and can send it to a Northbound NMS or an alternate bulk statistics server for further processing.

Also, the Bulk Statistics server can archive files to an alternate directory on the server. The directory can be on a local file system or on an NFS-mounted file system on an EMS server.

The implementation of bulk statistics in 5G is as follows:

- The NFs collect and export the statistics separately to an aggregator node in the 5G architecture.
- The receiver correlates the statistics from the NFs using the node-names or any other information that is configured as part of the bulk statistics configuration. Any EMS tool can render this data similar to how it is rendered from a standalone system.

Supported Schemas

This release supports the following schemas in the 5G architecture.

APN Schema

The APN schema provides Access Point Name (APN) statistics.

Card Schema

The Card schema provides card-level statistics.

ECS Schema

The ECS schema provides Enhanced Charging Service statistics.

GTP-U Schema

The GTP-U schema provides GPRS Tunneling Protocol- User message statistics.

P2P Schema

The P2P schema provides point-to-point statistics.

P-GW Schema

The P-GW schema provides user-plane service statistics.

Port Schema

The Port schema provides port-level statistics.

Rulebase

The Rulebase schema provides rule base statistics.

Sx Schema

The Sx schema provides N4 related message statistics.

System Schema

The System schema provides system-level statistics.

Userplane Schema

The Userplane schema provides User Plane statistics.



Important For more information on bulk statistic configuration, refer to the *Bulk Statistics* chapter in the *ASR 5500 System Administration Guide*.



CHAPTER 8

Charging Support

This chapter covers the following topics:

- [Feature Summary and Revision History, on page 65](#)
- [Feature Description, on page 66](#)
- [How it Works, on page 67](#)
- [Configuring Credit Control for Usage Reporting, on page 77](#)
- [Configuring ACS Rulebase for Usage Reporting, on page 78](#)
- [Monitoring and Troubleshooting, on page 80](#)

Feature Summary and Revision History

Summary Data

Table 14: Summary Data

Applicable Product(s) or Functional Area	5G-UPF
Applicable Platform(s)	VPC-SI SMI
Feature Default Setting	Disabled - Configuration Required
Related Changes in this Release	Not Applicable
Related Documentation	Not Applicable

Revision History

Table 15: Revision History

Revision Details	Release
The feature is enhanced to support Recalculate IE on N4 interface	2023.04.0

Revision Details	Release
The feature is enhanced to support following functionality: <ul style="list-style-type: none"> • PTT no-quota Limited Pass • PTT quota exhaust Limited Pass • Tariff Time • TCP Maximum Segment Size 	2021.02.0
Usage reporting with Rating-Group and Service ID is introduced.	2020.02.5
First introduced.	2020.02.0

Feature Description

The usage measurement and reporting function in User Plane Function (UPF) is controlled by the Session Management Function (SMF). The SMF controls these functions by:

- Creating the necessary PDRs to represent the service data flow, application, bearer or session (if they are not existing already).
- Creating the URRs for each Charging Key and combination of Charging Key and Service ID. Also, creating URRs for a combination of Charging Key, Sponsor ID, and Application Service Provider Id.
- Associating the URRs to the relevant PDRs defined for the PFCP session, for usage reporting at SDF, Session or Application level.
- For online charging, the SMF provisions Volume and Time quota, if it receives it from the Online Charging Server (OCS).

Offline Charging Events Reporting over N4

The User Plane Function (UPF) supports session-based offline charging, PDU session level reporting triggers in URR (volume and time threshold), PFCP session report procedure, and usage report IE support in the PFCP modification response for the Session-AMBR change, QoS, and User Location triggers.

Online Charging Support over N4

The UPF supports flow-based online charging support, which includes URR enhancements for Volume and Time quota and Usage reporting IE in PFCP modify response. In addition, the UPF supports online charging triggers, which include a PFCP session report request support with usage reporting IE.

How it Works

Call Flows

The following sections describe the call flows between SMF and UPF for PFCP Session Management.

PFCP Session Establishment Procedure

The PFCP Session Establishment procedure establishes a PFCP session between SMF and UPF. It also configures rules in UPF for handling incoming packets. In addition, the SMF sends Create URR Information Element (IE), which comprises of triggers and thresholds that are intended for reporting.

The following call flow depicts the PFCP Session Establishment procedure.

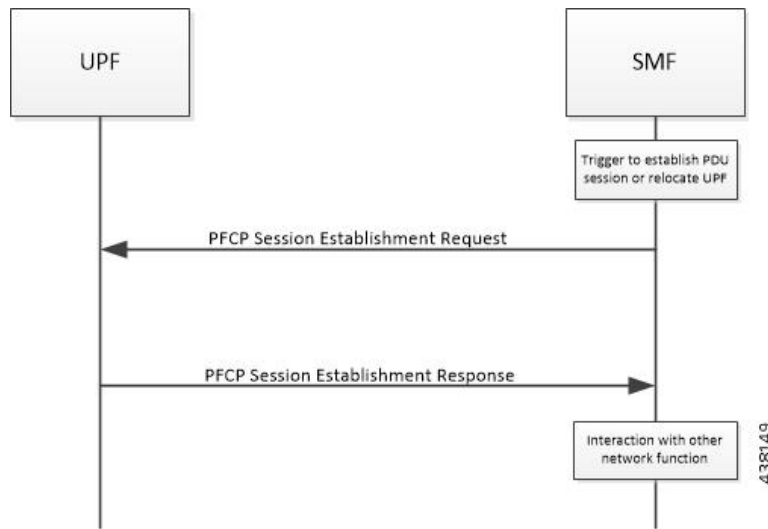

Step	Description
1	The SMF receives the trigger to establish a new PDU Session or change the UPF for an established PDU Session.
2	The SMF sends the PFCP Session Establishment Request message to the UPF. This message contains the structured control information, which defines the UPF's behavior.
3	The SMF provisions URR with Create URR IE. The Create URR associates with PDRs by adding URR-ID IE in Create PDR IE. It includes various triggers and thresholds for usage reporting.
4	When the same URR is associated with multiple PDRs, URRs are linked with another URR. Therefore, if a report for an URR is sent, its linked URR is also reported.
5	The UPF responds with the PFCP Session Establishment Response message to the SMF. For instance, Created PDR IE, in which UPF Flow-TEID is sent to gNB for GTP-u encapsulation for data traffic.
6	The SMF interacts with the network function, which triggered this procedure. For instance, AMF or PCF.

PFCP Session Modification Procedure

The SMF uses the PFCP Session Modification procedure to modify an existing PFCP session on the UPF. For instance, configuring a new rule, modifying an existing rule, or deleting an existing rule, and so on. The SMF sends the Create URR IE, Update URR IE (to update the trigger or threshold) and Remove URR IE (to remove an existing URR created earlier by SMF during Session Establishment Procedure) in the same message.

The following call flow depicts the PFCP Session Modification procedure.

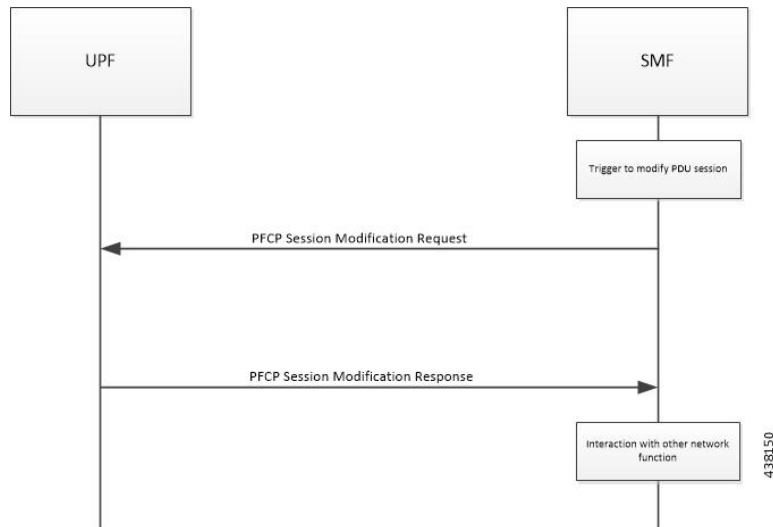

Step	Description
1	The SMF receives the trigger to modify the existing PDU Session.
2	The SMF sends an N4 session modification request message to the UPF. This message contains the structured control information, which defines the UPF's behavior.
3	The UPF identifies the PFCP session context for the Session ID to modify. It updates the parameters of this session context according to the list of parameters sent by the SMF. It then responds with a PFCP Session Modification Response message. The message contains the information, which the UPF must provide to the SMF (in response to the control information received).
4	<ul style="list-style-type: none"> If the SMF sends the QAURR flag set in PFCPSMReq-Flag IE or URR ID (s) with Query URR IE (e), then UPF sends the usage report IE for the corresponding URR with the PFCP Session Modification response. The custom Information Element (IE) called Recalculate Measurement is added to the Update-URR IE (for URR-ID: Gz-Bearer) to support the PGWCDR generation due to the Max-LOSDV condition with the N4 Session Modify Request. After receiving the IE, UPF reconciles the Volume and Duration of the URR according to the URR-ID present inside the IE.
5	The UPF provisions and acts based on the Create URR, Update URR or Remove URR IE sent by the SMF.
6	The SMF interacts with the network function, which triggered this procedure. For instance, AMF or PCF.

PFCP Session Reporting Procedure

The UPF uses PFCP Session Reporting procedure to report information that is related to the PFCP session to the SMF (usage report IE). Once the threshold hits the volume, time or event measurement and sets the corresponding trigger for reporting, the message is sent to the SMF by the UPF.

The following call flow depicts the PFCP Session Reporting procedure.

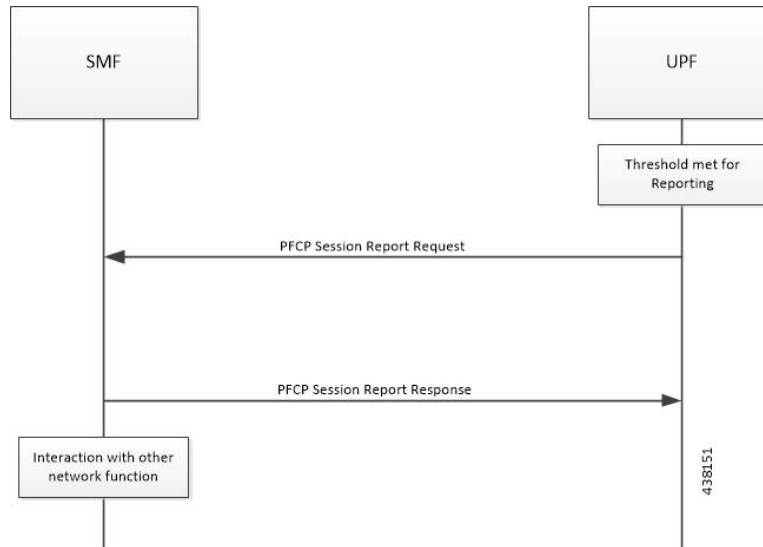

Step	Description
1	<ul style="list-style-type: none"> Once the provisioned threshold is met (for time, volume or event, and trigger is set for reporting), the UPF sends PFCP Session Report Request with usage report IE and usage details for volume, time, or threshold. The custom Information Element (IE) called Recalculate Measurement is added to the Update-URR IE (for URR-ID: Gz-Bearer) to support the PGWCDR generation due to the Max-LOSDV condition with the N4 Session Modify Request. After receiving the IE, UPF reconciles the Volume and Duration of the URR according to the URR-ID present inside the IE.
2	The SMF responds with PFCP Session Modification Response with success or failure message. No failure handling is needed on the UPF.
3	The SMF interacts with the network function, which triggered this procedure. For instance, AMF or PCF.

PFCP Session Deletion Procedure

The PFCP Session Deletion procedure deletes an existing PFCP session between the SMF and UPF. The SMF initiates a PFCP Session Deletion procedure toward the UPF to delete an existing PFCP session. The UPF sends the Session Deletion Response including the Usage Report for all URRs provisioned earlier.

The following call flow depicts the PFCP Session Deletion procedure.

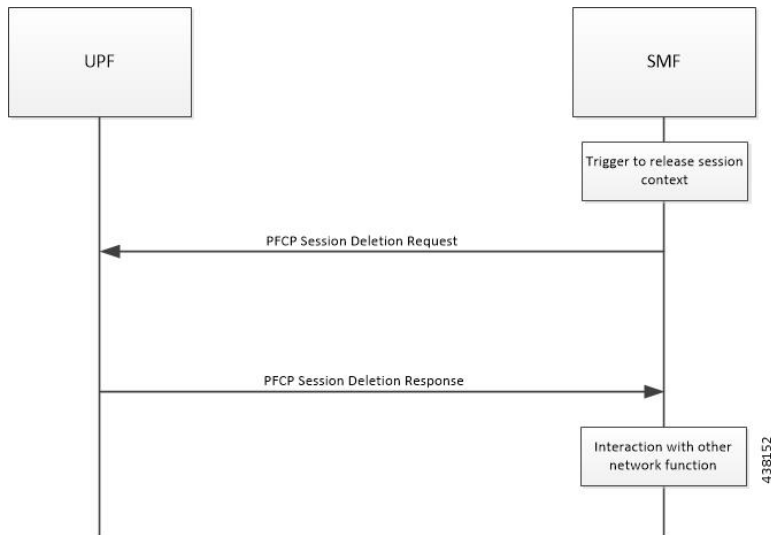

Step	Description
1	The SMF receives the trigger to remove the PFCP session context for the PDU Session.
2	It sends the PFCP Session Delete Request message to the UPF.
3	The UPF identifies the PFCP session context for the Session ID to remove. It then removes the whole session context. In addition, the UPF responds with a PFCP Session Delete Response message that contains any information the UPF provides to the SMF. For instance, the UPF sends usage report for all the URR provisioned for this session.
4	The SMF interacts with the network function, which triggered this procedure. For instance, AMF or PCF.

IEs Supported for Offline Charging Reporting

Table 16: Feature History

Feature Name	Release Information	Description
Recalculate Measurement IE on the N4 Interface	2023.04	UPF supports the Recalculate Measurement custom IE as received over the N4 interface. This IE is added to the Update-URR process (URR-ID: Gz-Bearer) to support the PGW-CDR generation due to the max_LOSDV change condition.

The following trigger Information Elements (IEs) support offline charging Reporting over N4:

- Periodic Reporting – When this trigger is set, the UPF sends resource usage report periodically to Session Management Function (SMF). The intervals that are required for periodic reporting are sent with the measurement period IE.
- Volume Threshold (when the volume threshold reaches UL, DL, and Total) – This trigger is set when the volume-based measurement is required. The SMF sends the traffic volume value along with the

volume threshold IE, while the UPF sends the traffic usage report when the traffic volume is reached for the specific Usage Reporting Rule (URR).

- Time Threshold (when the time threshold is reached) – This trigger is set when the time-based measurement is set. The SMF sends the time threshold value along with the time threshold IE, while the UPF sends resource usage report when the time threshold is reached for the specific URR.
- Linked Usage Reporting – The UPF sends the usage report of this specific URR when this trigger is set. In addition, the usage report is sent to any of the URRs linked to UPF when this trigger is set. The UPF sends the linked URR-Id along with the linked URR-Id IE.
- Packet Forwarding Control Protocol (PFCP) Session Deletion – A usage report generates (in a PFCP Deletion Response) for a URR due to the termination of the PFCP session. Similarly, a usage report generates (in a PFCP modification response) for a URR due to the removal of a specific URR.
- Update URR – This trigger is set when update URR request is received.
- Recalculate Measurement – The custom Information Element (IE) called Recalculate Measurement is added to the Update-URR process (URR-ID: Gz-Bearer) to support the PGWCDR generation due to the Max-LOSDV condition. After receiving the IE, UPF reconcile the Volume and Duration of the URR according to the URR-ID present inside the IE.



Note

- The total usage for the given URR-ID is reset, and if there are any linked URRs, the usage is recalculated.
 - The timestamps for first-pkt-time, last-pkt-time and duration are also adjusted accordingly.
 - The threshold values remain unchanged.
-

- Recalculate Interface - The custom IE called ‘Recalculate Interface’ is sent by SMF via N4 Modify Request. When Recalculate Interface IE is received along with Query URR(s) or Update URR(s) IEs in the same Sx Modify Request, Recalculate Interface IE will be processed independently in the end. After receiving the IE, the UPF iterates through all the URRs, fetching only the URRs mentioned as per the flags mentioned by SMF and execute the recalculate functionality. The UPF subsequently reconciles the Volume and Duration of all the retrieved URRs.



Note

- The usage accumulated for the URRs is discarded, and if there are any linked URRs, their usage is reconciled.
 - The timestamps for first-pkt-time, last-pkt-time and duration are adjusted accordingly.
 - The threshold values for the linked URRs remain unchanged.
-

IEs Supported for Online Charging Reporting

The following IEs support online charging:

- Volume Quota – The SMF requests the UPF to stop forwarding packets or allow forwarding some limited user plane traffic (based on the operator policy in UPF) with this IE. If no Volume Threshold is provisioned – to generate a usage report – and when the measured traffic reaches the quota, this IE is used.
- Time Quota - The SMF requests the UPF to stop forwarding packets or allow forwarding some limited user plane traffic (based on operator policy in UPF) with this IE. If no Volume Threshold is provisioned – to generate a usage report – and when the measured traffic reaches the quota, this IE is used.
- Monitoring Time – This IE is used by the SMF to send the time (UTC format) at which the UPF can re-apply the volume or time threshold. Also, the SMF sends any one of the Subsequent Volume, Time, Volume Quota, Time Quota, and Quota IEs, which is re-applied at the Monitoring Timestamp.
- FAR (Forwarding Action Rule) ID for Quota Action – This IE is used by the SMF to identify the substitute FAR the UPF applies – for the traffic that is associated to the URR – when any of the Volume, Time or quota is exhausted. This FAR requires the UPF to drop the packets or redirect the traffic toward a redirect destination.
- Subsequent Volume Threshold – When volume-based measurement is used and Monitoring Time IE is available, this IE is also present. The presence of this IE indicates the existence of the traffic volume value (the network resources usage reported by the UPF to the SMF) for this specific URR and the period after the Monitoring Time.
- Subsequent Time Threshold - When time-based measurement is used and Monitoring Time IE is available, this IE is also present. The presence of this IE indicates the existence of the time usage (the network resources usage reported by the UP function to the CP function) for this specific URR and the period after the Monitoring Time.
- Linked URR ID – When the linked usage reporting is required, this IE is used. It is possible to link multiple URR-IDs with an URR. Also, linked usage reporting is also sent in the Reporting Trigger IE.
- Measurement Method – The SMF specifies the measurement method of the network usage with the presence of this IE. The measurement method is based on volume and duration.
- Measurement Period – This IE is present to modify the measurement period.
- Periodic Reporting - When this trigger is set, the UPF sends resource usage report periodically to the SMF. The intervals that are required for periodic reporting are sent with the measurement period IE. When the trigger is set to 1, a request for periodic reporting is sent.
- Volume Threshold – This trigger is set when volume-based measurement is required. The SMF sends the traffic volume value along with the volume threshold IE, while the UPF sends the traffic usage report when the traffic volume is reached for the specific Usage Reporting Rule (URR). When the trigger is set to 1, a request for reporting – when the data volume usage reaches a volume threshold – is sent.
- Time Threshold - This trigger is set when time-based measurement is set. The SMF sends the time threshold value along with the time threshold IE, while the UPF sends resource usage report when the time threshold is reached for the specific URR. When the trigger is set to 1, a request for reporting – when the time usage reaches a time threshold - is sent.
- Start of Traffic – The UPF sends the Usage Report once the traffic starts for an application, when this trigger is set.
- Linked Usage Reporting - The UPF sends the usage report of this specific URR when this trigger is set. In addition, the usage report is sent to any of the URRs linked to UPF when this trigger is set. The UPF sends the linked URR-Id along with the linked URR-Id IE. When the trigger is set to 1, a request for linked usage reporting is sent.

Usage Reporting in PFCP Modification Response

The UPF sends session modification response after receiving session modification request based on the IEs received in the request message. The UPF includes usage report IE in the session modification response for the following scenarios:

- Query URR Handling—The URR-Id IE is included when the SMF requests immediate usage reports from the UPF in the session modification response (for the URR-Id present in this specific IE).
- Query All URRs (QAURR) Handling—The UPF sends the usage report with session modification response for all the URRs provisioned prior by the SMF for this PFCP session once it receives the QUARR flag set in PFCPSMReq-Flags IE from SMF.
- Update URR—The SMF updates the new value of the existing IE with the old value during the session modification procedure.
- Remove URR—During the session modification procedure, the SMF removes the IE, which is not received but was available earlier.

Usage Reporting for Online and Offline Charging

Usage Reporting for Online and Offline Charging is supported in the following ways:

- URR for online charging based on Rating-Group level even if the Service ID is present under Charging-Action. This behavior is seen when diameter ignore-service-id is configured under Credit Control Group.
- URR for offline charging based on a combination of Rating-Group level and Service ID, for static and predefined rules, as configured in the Charging-Action.

Both URRs are linked by the SMF. These URRs are linked such that when an online URR is reported, an offline URR is also reported.

Usage Reporting with Rating-Group and Service ID

The functionality enables usage reporting to the SMF with the Rating-Group (RG) and/or Service ID (SI) populated in the Usage Report IE within the Session Report Request.

The RG and SI are populated using proprietary PFCP IEs and are applicable for usage reporting of URRs associated only with Static and Predefined configured rules. The values are derived from the configured charging-action associated with the ruledefs, resulting in creation of the URRs during predefined activation or traffic hit for static rules.

Any change in RG/SI properties of the charging-action is reflected only in new URRs. The existing URRs associated with such charging-actions continue to report usage with the earlier RG+SI values.

UPF does not differentiate between usage reporting for Online and Offline URRs, and reports the RG+SI/RG/SI values configured in the charging-action, resulting in creation of the URRs.

NOTE: To know how SMF handles this functionality, refer *Dynamic Configuration Change Support* section in the *SMF Charging* chapter of *UCC 5G SMF Configuration and Administration Guide*.

Implementing the QAURR Flag

The SMF sets the QAURR flag of PFCPSMReq-Flags IE to request immediate usage reports for all the URRs previously provisioned earlier. Alternatively, SMF queries report for selected URR by sending URR-ID with Query URR IE. The UPF sends the usage report IE for corresponding URR with PFCP session modification response when the SMF sends the QAURR flag set in PFCPSMReq-Flag IE or URR-Id with Query URR IE.

Supported Functionality and Limitations

Basic call flow with Volume-Quota mechanism is supported with the following limitations:

- Dynamic Rules with Online Enabled is supported; both at Session-Setup and Mid-Session.
- Predefined Rules (dynamic-only) is supported; both at Session-Setup and Mid-Session. No restriction on configuring the "preemptively request".
- Static-rules with Online Charging are supported.
- Ignore-service-id is supported.
- Volume-Quota/Volume-Threshold mechanisms are supported.
- Event-Triggers (through which the Query URR occurs), and sending of usage information to the OCS is supported.
- The "updateURR" procedure, through the Sx/N4-Session-Modification procedure where the OCS grants a fresh Quota, is supported.
- Pending-Traffic-Treatment (PTT) Drop/Pass is supported with following limitations:
 - The scenarios currently supported are no-quota and quota-exhausted.
 - The trigger or re-authorization scenarios are not supported.
 - The PTT action (Forward/Drop) is considered after the quota-get is exhausted.
- Wall-Clock time-quota mechanism is supported.
- Other Time Quota Mechanisms (Discrete Time Period and Continuous-Time-Period) are not supported.
- Final-Unit-Indication Terminate mechanism is supported.
- FUI-Restrict is not supported.
- Server-Unreachable (SU) mechanism is now supported with minor change in behavior compared to non-5G UPF P-GW.
 - When an URR needs quota at UPF, the usage-report is generated to SMF and until the SMF responds with the linked SU_URR, the packets matching this URR are treated with Pending-Traffic-Treatment configuration.
 - When the SU Time Quota is used and it's reported to SMF for the Quota Exhaust, and if the session goes into Server-Unreachable state again, the time elapsed from the last Usage-Report is accounted in the usage.
- Pending-Traffic-Treatment Buffer mechanism is not supported.

- Quota-Hold-Time is supported.
- Quota-Consumption-Time mechanism is not supported.
- Quota-Validity-Time is supported.
- Configuring different "rating-group" value other than the "content-id" is supported.
 - The RG 0 is not supported.
- Trigger to PCF for the Out-of-Credit, Reallocation-of-Credit events are not qualified.



Important Event-trigger Out-of-Credit toward PCF is validated with a limitation of having only one time Grant-Quota (Keeping Total Volume and Granted Volume at same value).

- Service-Specific-Units are not supported.
- Tariff-Time change is supported as per 3GPP specification.
- FUI-Redirect is supported with following limitations:
 - Redirection for HTTPs is not supported.
 - The FUI-Redirect with Filter-IDs/Filter-Rules are not supported.
 - The WSP Protocol is not supported.
 - The **redirect-require-user-agent** CLI command is not supported; the redirection continues to work even if the user-agent is not present.
 - Appending the original URL is not supported.
 - Token-based mechanism, to come out of Redirection, is not supported. To end the redirection in 5G UPF, OCS sends Redirect Validity-Time or RAR.
 - FUI-Redirection is supported only for the URL, similar to the behavior in non-5G UPF architecture.
 - Check pointing of FUI Redirection URL is not supported.

PTT no-quota Limited Pass

This feature allows the subscriber to use the network while waiting for the response from OCS. The Limited-Pass configuration allows to specify the Volume which the subscriber can consume while waiting for the quota-response from OCS. The usage is accounted in the respective charging bucket and is adjusted against the next-quota allocation.

Use the following CLI commands to enable the feature:

configure

```

active-charging service service_name
  credit-control
    pending-traffic-treatment noquota limited-pass volume volume
  end

```

Limited Pass Volume is used only for **noquota** case (Rating Group (RG) seeking quota for the first time) and not for **quota-exhausted**. Limited Pass Volume isn't used for subsequent credit requests.

The traffic is allowed to pass until the Limited-Pass Volume gets exhausted. The usage is counted in the respected charging-bucket and adjusted against the "Quota" granted. If the "Quota" allocation is less than the actual usage, immediate reporting towards OCS with the usage-report occurs requesting for more quota allocation. The subsequent incoming packets are handled as per the "quota-exhausted" PTT configuration.

If the Limited Pass Volume is NOT exhausted before the OCS responds with denial of quota, traffic is blocked after the OCS response. The gateway reports usage on Limited-Pass Volume in next `SX_SESSION_REPORT_REQUEST`.

If the Limited Pass Volume is exhausted before the OCS responds, then the subsequent incoming packets for the session are dropped until quota is granted from OCS.

The default pending-traffic-treatment for **noquota** is Drop. The **default pending-traffic-treatment noquota** command removes any Limited Pass Volume size configured.

PTT quota exhaust Limited Pass

Quota Exhausted Limited pass is proposed as an alternative to the Quota Exhausted Buffer due to the practical issues of the latter in the high-speed network. Buffering requires packet buffering for large number of packets at the gateway. The large number of packets can result in risking to run out of memory affecting the bandwidth speed. So, Limited Pass is an alternate to the Buffer option. Limited Pass allows the traffic to pass through until the configured limit on the Quota-Exhaust scenarios.

Use the following CLI command to enable the feature:

```
configure
  active-charging service service_name
  credit-control
    pending-traffic-treatment quota-exhausted limited-pass volume volume
  end
```



Note The above CLI is only applicable for the 5G UPF architecture.

After the Limited-Pass volume exhausts, the further packets drop until the quota allocation comes.

Limited Pass allows the traffic until the Limited-Pass volume exhausts. The Limited Pass counts and adjusts the usage in the respective charging-bucket against the "Quota" granted. If the "Quota" allocation is less than the actual usage, there's immediate reporting toward OCS with the usage-report and asking for more quota allocation.

If the limited pass volume doesn't exhaust before the OCS responds with denial of quota, there's traffic blockage after the OCS response. Gateway reports the usage in `SX_SESSION_REPORT_REQUEST`.

If the limited pass volume exhausts before the OCS responds, then further incoming packets for the session drop until grant quota from OCS.

The default pending-traffic-treatment for quota-exhausted is drop. The default pending-traffic-treatment quota-exhausted command removes any Limited Pass Volume size configured.

Tariff Time Support

The Tariff switch time functionality is applied when a subscriber switch from one tariff plan to another.

The Tariff-Time-Change AVP is used to determine the tariff switch time, and the Monitoring-Time IE is used to support the Tariff Time support functionality.

After a tariff timer expiry, the Gateway accumulates the usage separately in a charging bucket and continues to consume from the original quota value. At the time of next reporting (Quota exhausted or another control events), the Gateway reports both usages (before and after tariff time change) for the same Charging Bucket.

The first reporting of this charging-bucket will have the Reporting-Reason: Monitoring Time and the second bucket will contain the last reporting reason, and the quota usage after the tariff-timer expiry.

The data traffic usage can be split into resource usage before a tariff switch and resources used after a tariff switch. The Tariff-Change-Usage AVP is used within the Used-Service-Units AVP to distinguish reported usage before and after the tariff time change.

Limitations

Following are the known limitations of this feature:

- Only one tariff time per RG/Service ID combination is supported.
- Allocation of different quota before and after tariff time change isn't supported. This functionality isn't in compliance with the 3GPP standards.

TCP Maximum Segment Size

TCP/IP Stack always inserts Maximum Segment Size (MSS) field in the header. This causes difference in MSS insertion behavior with and without TCP Proxy.

Using **tcp mss** configurations, TCP MSS can be limited if already present in the TCP SYN packets. If there are no errors detected in IP header or TCP mandatory header, and there are no memory allocation failures, TCP optional header is parsed. If TCP MSS is present in the optional header and its value is greater than the configured MSS value, the value present in the TCP packet is replaced with the one that is configured.

If the TCP optional header is not present in the SYN packet and there are no errors in already-present TCP header, the configured TCP MSS value is inserted while sending out the current packet.

Configuring Credit Control for Usage Reporting

This configuration enables to accept/ignore service ID in the Service-Identifier AVP defined in the Diameter dictionaries.

```
configure
  require active charging
  active-charging service service_name
    credit-control group group_name
      diameter ignore-service-id
    end
```

- **diameter ignore-service-id** : This command can be used to disable the usage of the Service-Identifier AVP for Gy interface implementations even if any of the Diameter dictionaries support the

Service-Identifier AVP, and if this AVP should not be used for Gy interactions but must be present in GCDRs/eGCDRs.

Configuring ACS Rulebase for Usage Reporting

This section describes how to create, configure, or delete an ACS rulebase. A rulebase is a collection of protocol rules to match a flow and associated actions to be taken for matching flow. The default rulebase is used when a subscriber/APN is not configured with a specific rulebase to use.

Rulebase configuration is the one that combines all the specified configurations together to construct the static and predefined PCC rules.

configure

```

active-charging service service_name
  rulebase rulebase_name
    action priority action_priority { [ dynamic-only ] |
static-and-dynamic | timedef timedef_name } { group-of-ruledefs
ruledefs_group_name | ruledef ruledef_name } charging-action charging_action_name [
monitoring-key monitoring_key ] [ description description ] }
    cca quota { holding-time holding_time content-id content_id |
retry-time retry_time [ max-retries retries ] }
    credit-control-group cc_group_name
    dynamic-rule order { always-first | first-if-tied }
    egcdr threshold { interval interval [ regardless-of-other-triggers
] | volume { downlink | total | uplink } bytes }
    route priority route_priority ruledef ruledef_name analyzer { dns |
file-transfer | ftp-control | ftp-data | h323 | http | imap | mip6 | mms
| pop3 | pptp | radius | rtcp | rtp | rtsp | sdp | secure-http | sip [
advanced | basic-and-advanced ] | smtp | tftp | wsp-connection-less |
wsp-connection-oriented } [ description description ]
    tcp check-window-size
    tcp mss tcp_mss { add-if-not-present | limit-if-present |
limit-if-present add-if-not-present }
    tcp packets-out-of-order { timeout timeout_duration | transmit [
after-reordering | immediately ] }
  end

```

NOTES:

- **rulebase** *rulebase_name*: Specifies the name of the ACS rulebase. *rulebase_name* must be an alphanumeric string of 1 to 63 characters.
- **action priority** *action_priority* { [**dynamic-only**] | **static-and-dynamic** | **timedef** *timedef_name* } { **group-of-ruledefs** *ruledefs_group_name* | **ruledef** *ruledef_name* } **charging-action** *charging_action_name* [**monitoring-key** *monitoring_key*] [**description** *description*]}: Configures the priority order in which ruledefs are matched and the associated charging action.
 - *priority* must be an integer value in the range of 1-65535.
 - *monitoring_key* must be an integer value in the range of 100000-4000000000.

- **cca quota** { **holding-time** *holding_time* **content-id** *content_id* | **retry-time** *retry_time* [**max-retries** *retries*] }: Configures the quota for the online charging.
 - *holding_time*: must be an integer value in the range of 1-4000000000
 - *content_id*: must be an integer value in the range of 1-2147483647
 - *retry_time*: must be an integer value in the range of 0-86400
 - *retries*: must be an integer value in the range of 1-65535
 - **credit-control-group** *cc_group_name*: Configures the online charging parameters used by this rulebase. *cc_group_name* must be an alphanumeric string of 1 to 63 characters.
 - **dynamic-rule order**: Configures the order of dynamic rule matching vs the static rules in a rulebase.
 - **egcdr threshold** { **interval** *interval* [**regardless-of-other-triggers**] | **volume** { **downlink** | **total** | **uplink** } **bytes** }: Configures the threshold for offline charging.
 - **interval**: must be an integer value in the range of 60-40000000.
 - **downlink**: must be an integer value in the range of 100000-4000000000. Default: 4000000000.
 - **uplink**: must be an integer value in the range of 100000-4000000000. Default: 4000000000.
 - **total**: must be an integer value in the range of 100000-4000000000.
 - **route priority** *route_priority* **ruledef** *ruledef_name* **analyzer** { **dns** | **file-transfer** | **ftp-control** | **ftp-data** | **h323** | **http** | **imap** | **mip6** | **mms** | **pop3** | **pptp** | **radius** | **rtcp** | **rtp** | **rtsp** | **sdp** | **secure-http** | **sip** [**advanced** | **basic-and-advanced**] | **smtp** | **tftp** | **wsp-connection-less** | **wsp-connection-oriented** } [**description** *description*]: This command is used only on UPF.
 - *route_priority* must be an integer value in the range of 0-65535.
 - *ruledef_name* must be an alphanumeric string of 1 to 63 characters.
 - **tcp check-window-size**: This command is used only on UPF.
 - **tcp mss** *tcp_mss*: This command is used only on UPF. *tcp_mss* must be an integer value in the range of 496-65535.
 - **add-if-not-present** : Specifies to add the TCP MSS if not present in the packet.
 - **limit-if-present** : Specifies to limit the TCP MSS if present in the packet.
 - **limit-if-present add-if-not-present** : Specifies to limit the TCP MSS if present, else, adds it to the packets.
-  **Note** The **tcp mss** *tcp_mss* **limit-if-present add-if-not-present** CLI command is available in 2021.02.0 and later releases.
- **tcp packets-out-of-order** { **timeout** *timeout_duration* | **transmit** [**after-reordering** | **immediately**] }: This command is used only on UPF.
 - *timeout_duration* must be an integer value in the range of 100-30000. Default value is 5000.

Sample Configuration

```

active-charging service acs
  ruledef ip-any-rule
    ip any-match = TRUE
  #exit
  urr-list upf
    rating-group 10 ser 10 urr-id 10
    rating-group 10 urr-id 50
  #exit
  charging-action starent
    content-id 10
    service-identifier 10
    billing-action egcdr
    cca charging credit rating-group 10
  exit
  credit-control group CCG
    diameter ignore-service-id
  #exit
  rulebase starent
    billing-records egcdr
    action priority 30 ruledef ip-any-rule charging-action starent
    egcdr threshold interval 3600
    egcdr threshold volume total 200000
    egcdr threshold volume downlink 100000 uplink 100000
    dynamic-rule order first-if-tied
    credit-control-group CCG
  #exit
#exit

context ISP
  apn starent.com
    accounting-mode gtp
    gtp group my_grp accounting-context ISP
    ip context-name ISP
  #exit
  gtp group my_grp
    gtp egcdr service-data-flow threshold interval 1200
    gtp egcdr service-data-flow threshold volume downlink 13000
    gtp egcdr service-data-flow threshold volume uplink 17000
    gtp egcdr service-data-flow threshold volume total 22222
  #exit
end

```

Monitoring and Troubleshooting

Show Commands and/or Outputs

This section provides information about the show CLI commands that are available in support of the feature.

show-user-plane-service statistics rulebase name <name>

Use this CLI command to see the following fields that are available in support of TCP Maximum Segment Size (MSS) feature:

- TCP MSS Inserted Pkts: Displays the total number of MSS Inserted packets.
- TCP MSS Limited Pkts: Displays the total number of TCP MSS Limited packets.



CHAPTER 9

Cisco Ultra Traffic Optimization with VPP

- [Feature Summary and Revision History, on page 81](#)
- [Feature Description, on page 82](#)
- [RCM Support, on page 82](#)
- [Sending the GBR or MBR Values to Cisco Ultra Traffic Optimization , on page 83](#)
- [How it Works, on page 83](#)
- [Show Commands and Outputs, on page 85](#)
- [Sample Configuration, on page 89](#)

Feature Summary and Revision History

Summary Data

Table 17: Summary Data

Applicable Product(s) or Functional Area	5G-UPF
Applicable Platform(s)	VPC-SI
Feature Default Setting	Disabled - Configuration Required
Related Changes in this Release	Not Applicable
Related Documentation	Not Applicable

Revision History

Table 18: Revision History

Revision Details	Release
First introduced.	2022.01.1

Feature Description

The UPF supports Cisco Ultra Traffic Optimization (CUTO) on Vector Packet Processing (VPP).

The Cisco Ultra Traffic Optimization is a RAN optimization technology that increases the subscriber connection speeds in congested cells and, as a result, increases the cell capacity significantly. The result is an optimized RAN, where Mobile Network Operators (MNOs) can deploy fewer cells, on an ongoing basis, and absorb more traffic growth while meeting network quality targets.

Large traffic flows, such as Adaptive Bit Rate (ABR) video, saturate radio resources and swamp the eNodeB scheduler. The Cisco Ultra Traffic Optimization employs machine learning algorithms to detect large traffic flows (such as video) in the network. It also optimizes the Delivery of those flows to mitigate the network congestion without changing the user quality (that is, video works the same for you). In other words, by employing software intelligence at the network core, Cisco Ultra Traffic Optimization mitigates the overwhelming impact the video has on the RAN.

The resulting benefits are seen in congested network sites. The Cisco Ultra Traffic Optimization:

- Increases average user throughput.
- Increases congested cell site capacity.
- Reduces scheduler latency.
- Maintains user quality of experience even when more users and more traffic share a cell.
- Is measured directly by eNodeB performance counters (for example, average UE throughput, scheduler latency). These are the key performance indicators that are used for network capacity planning.
- Provides permanent savings in RAN investment requirements.
- Is integrated in the Cisco StarOS P-GW.
- Requires no new hardware or cabling complexity - it can be turned on for a market in an hour.
- Supports HTTP or HTTPS, and QUIC traffic.

Licensing

The Cisco Ultra Traffic Optimization with VPP is a licensed Cisco solution. Contact your Cisco account representative for detailed information on specific licensing requirements. For information on installing and verifying licenses, refer to the *Managing License Keys* section of the *Software Management Operations* chapter in the *VPC-SI System Administration Guide*.

RCM Support

This feature enables the Redundancy and Configuration Management (RCM) support for the Cisco Ultra Traffic Optimization (CUTO). All relevant configuration to enable CUTO using service scheme and application of the CUTO profile or policy on UPF is supported using RCM.

Sending the GBR or MBR Values to Cisco Ultra Traffic Optimization

If the flow level MBR is greater than the APN-AMBR for a non GBR bearer, traffic is throttled at APN-AMBR. In such a case APN-AMBR is sent as the upper limit to the CUTO library. If there is no valid flow level MBR specific to the flow, APN-AMBR is sent as the upper limit to the CUTO library.

For a GBR bearer, the flow level GBR is sent as the lower limit and flow level MBR is sent as the upper limit to the CUTO library.

Cisco Ultra Traffic Optimization Library Deinitialization

This feature currently doesn't support the Deinitialization. Deinitialization happens when the Cisco Ultra Traffic Optimization (CUTO) license is removed from the system.

How it Works

Architecture

The following figure illustrates the architecture of Cisco Ultra Traffic Optimization on VPP.

Figure 10: Architecture

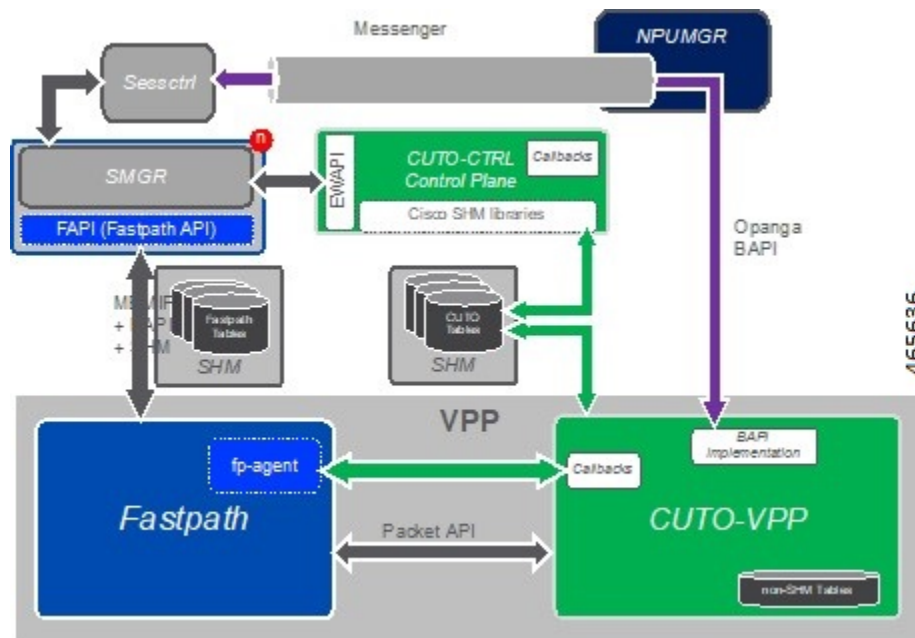

CUTO-CTRL

- CUTO-CTRL receives guidance and requests from SMGR through the East-West API (EWAPI), through which clients (SMGR instances) are registered and deregistered, and new streams or flows are created and terminated.
- CUTO-CTRL manages a set of shared memory (SHM) tables using a North-South API (NSAPI) consisting of Cisco-provided SHM infrastructure.
- It is through this SHM environment that CUTO-VPP can read and write content that is visible to both CUTO-VPP and CUTO-CTRL.
- The SHM is used for all high volume, scalable/mutable content necessary for the high-performance configuration and administration of the CUTO solution in VPP.

NPUMGR

NPUMGR is the management layer that is responsible for the overall VPP operation. It sends Binary API (BAPI) requests to CUTO-VPP for initialization, global runtime configuration, and policy configuration.

SMGR

SMGR is the main subscriber control plane. There are N SMGR instances, and all instances are managed by the SessCtrl. In the context of VPPMOB/Fastpath, the SMGR instances are also known as “Clients”, and each client has a unique ID.

SMGR issues policy directives to SessCtrl through the Messenger tunnel, and sends updated Policy guidance to CUTO-VPP through the Binary API.

SMGR communicates with Fastpath for pre-existing functionality with a set of MEMIF, Binary API, and shared memory (SHM) infrastructures.

Session Control (SessCtrl)

Session Control is the management layer responsible for overseeing the set of SMGR instances.

The BAPI requests are tunnelled from SessCtrl to NPUMGR through Messenger.

Fastpath

VPP is responsible for packet processing. Fastpath performs subscriber-related packet processing within the VPP environment. Subscriber flows are divided into unidirectional Streams, and a Stream conduit is the pipeline of functions through which a packet is transformed and egressed from subscriber processing.

A packet API between the Fastpath and CUTO-VPP facilitates the exchange of packets traversing the Fastpath conduit.

CUTO-VPP

- CUTO-VPP is the packet processing engine in the UPF.
- In fastpath, Cisco Ultra Traffic Optimization is applied to packets on a stream configured with its operation.
- Packets are sent from the Stream conduit to a particular CUTO-VPP operation, and after some potential delay (0-N milliseconds), traffic is returned to the same Conduit.
- Packets are never dropped by the Cisco Ultra Traffic optimization library.

CUTO-TODR

Traffic Optimization Data Records (TODR) can only be generated as events, and are enabled only when the configuration is available.

Limitations

The Cisco Ultra Traffic Optimization feature has the following limitations:

- CUTO configuration changes done in Service Schema do not take effect immediately for existing flows.
- Cisco Ultra Traffic Optimization VPP global deinitialization is not supported.
- Bearer-related triggers for enabling Cisco Ultra Traffic Optimization are not supported.
- Rule match change trigger must be configured for CUTO in UPF.
- Enabling/Disabling of Traffic optimization is not supported on "loc-update" trigger.
- Removal of CUTO license doesn't trigger global deinitialization. CUTO configurations must be removed to disengage CUTO functionality for new flows.

Show Commands and Outputs

This section provides information regarding show commands and their outputs in support of Cisco Ultra Traffic Optimization.

For information on other supporting show commands, refer to *Monitoring and Troubleshooting* section under the *Cisco Ultra Traffic Optimization* chapter in the *P-GW Administration Guide*.

Show Commands and Outputs

show user-plane-service traffic-optimization counters sessmgr all

The output of this command includes the following fields:

TCP Traffic Optimization Flows:

- Active Normal Flow Count
- Active Large Flow Count
- Active Managed Large Flow Count
- Active Unmanaged Large Flow Count
- Total Normal Flow Count
- Total Large Flow Count
- Total Managed Large Flow Count
- Total Unmanaged Large Flow Count
- Total IO Bytes

- Total Large Flow Bytes
- Total Recovered Capacity Bytes
- Total Recovered Capacity ms

UDP Traffic Optimization Flows:

- Active Normal Flow Count
- Active Large Flow Count
- Active Managed Large Flow Count
- Active Unmanaged Large Flow Count
- Total Normal Flow Count
- Total Large Flow Count
- Total Managed Large Flow Count
- Total Unmanaged Large Flow Count
- Total IO Bytes
- Total Large Flow Bytes
- Total Recovered Capacity Bytes
- Total Recovered Capacity ms

show user-plane-service traffic-optimization info

The output of this command includes the following fields:

- CUTO Ctrl Library Version
- CUTO VPP Library Version
- Mode
- Configuration
 - Data Records (TODR)
 - Statistics Options
 - EFD Flow Cleanup Interval
 - Statistics Interval

show user-plane-service traffic-optimization policy all

The output of this command includes the following fields:

- Policy Name
- Policy-Id

- Bandwidth-Mgmt
 - Backoff-Profile
 - Min-Effective-Rate
 - Min-Flow-Control-Rate
- Curbing-Control:
 - Time
 - Rate
 - Max-Phases
 - Threshold-Rate
- Heavy-Session:
 - Threshold
 - Standard-Flow-Timeout
 - Seed-Time
- Detection-Mode
- Link-Profile:
 - Initial-Rate
 - Max-Rate
 - Peak-Lock
- Session-Params:
 - Tcp-Ramp-Up
 - Udp-Ramp-Up
- Total traffic-optimization-policies found

Bulkstats

The following existing bulk statistics are supported by Cisco Ultra Traffic Optimization in UPF:

Bulk Statistics	Description
cuto-uplink-drop	Indicates the total number of uplink packets dropped by CUTO library
cuto-uplink-hold	Indicates the total number of uplink packets held by CUTO library
cuto-uplink-forward	Indicates the total number of uplink packets forwarded by CUTO library

Bulk Statistics	Description
cuto-uplink-rx	Indicates the total number of uplink packets received by CUTO library
cuto-uplink-tx	Indicates the total number of uplink packets sent by CUTO library
cuto-dnlink-drop	Indicates the total number of downlink packets dropped by CUTO library
cuto-dnlink-hold	Indicates the total number of downlink packets held by CUTO library
cuto-dnlink-forward	Indicates the total number of downlink packets forwarded by CUTO library
cuto-dnlink-rx	Indicates the total number of downlink packets received by CUTO library
cuto-dnlink-tx	Indicates the total number of downlink packets sent by CUTO library
cuto-todrs-generated	Indicates the total number of TODRs generated.
tcp-active-normal-flow-count	Indicates the number of TCP active-normal-flow count for Cisco Ultra Traffic Optimization.
tcp-active-large-flow-count	Indicates the number of TCP active-large-flow count for Cisco Ultra Traffic Optimization.
tcp-active-managed-large-flow-count	Indicates the number of TCP active-managed-large-flow count for Cisco Ultra Traffic Optimization.
tcp-active-unmanaged-large-flow-count	Indicates the number of TCP active-unmanaged-large-flow count for Cisco Ultra Traffic Optimization.
tcp-total-normal-flow-count	Indicates the number of TCP total-normal-flow count for Cisco Ultra Traffic Optimization.
tcp-total-large-flow-count	Indicates the number of TCP total-large-flow count for Cisco Ultra Traffic Optimization.
tcp-total-managed-large-flow-count	Indicates the number of TCP total-managed-large-flow count for Cisco Ultra Traffic Optimization.
tcp-total-unmanaged-large-flow-count	Indicates the number of TCP total-unmanaged-large-flow count for Cisco Ultra Traffic Optimization.
tcp-total-io-bytes	Indicates the number of TCP total-IO bytes for Cisco Ultra Traffic Optimization.
tcp-total-large-flow-bytes	Indicates the number of TCP total-large-flow bytes for Cisco Ultra Traffic Optimization.

Bulk Statistics	Description
tcp-total-recovered-capacity-bytes	Indicates the number of TCP total-recovered capacity bytes for Cisco Ultra Traffic Optimization.
tcp-total-recovered-capacity-ms	Indicates the number of TCP total-recovered capacity ms for Cisco Ultra Traffic Optimization.
udp-active-normal-flow-count	Indicates the number of UDP active-normal-flow count for Cisco Ultra Traffic Optimization.
udp-active-large-flow-count	Indicates the number of UDP active-large-flow count for Cisco Ultra Traffic Optimization.
udp-active-managed-large-flow-count	Indicates the number of UDP active-managed-large-flow count for Cisco Ultra Traffic Optimization.
udp-active-unmanaged-large-flow-count	Indicates the number of UDP active-unmanaged-large-flow count for Cisco Ultra Traffic Optimization.
udp-total-normal-flow-count	Indicates the number of UDP total-normal-flow count for Cisco Ultra Traffic Optimization.
udp-total-large-flow-count	Indicates the number of UDP total-large-flow count for Cisco Ultra Traffic Optimization.
udp-total-managed-large-flow-count	Indicates the number of UDP total-managed-large-flow count for Cisco Ultra Traffic Optimization.
udp-total-unmanaged-large-flow-count	Indicates the number of UDP total-unmanaged-large-flow count for Cisco Ultra Traffic Optimization.
udp-total-io-bytes	Indicates the number of UDP total-IO bytes for Cisco Ultra Traffic Optimization.
udp-total-large-flow-bytes	Indicates the number of UDP total-large-flow bytes for Cisco Ultra Traffic Optimization.
udp-total-recovered-capacity-bytes	Indicates the number of UDP total-recovered capacity bytes for Cisco Ultra Traffic Optimization.
udp-total-recovered-capacity-ms	Indicates the number of UDP total-recovered capacity ms for Cisco Ultra Traffic Optimization.

Sample Configuration

Sample configuration to enable the CUTO feature:

```
configure
  active-charging service ACS
  trigger-action TA1
    traffic-optimization policy custom1
  #exit
  trigger-condition TC1
```

```

    rule-name = dynamic-rule2
#exit
service-scheme SS1
    trigger rule-match-change
        priority 5 trigger-condition TC1 trigger-action TA1
    #exit
subs-class SB1
    rulebase = cisco
#exit
subscriber-base default
    priority 5 subs-class SB1 bind service-scheme SS1
#exit
traffic-optimization-profile
    mode active
    data-record
#exit
traffic-optimization-policy custom1
    bandwidth-mgmt min-effective-rate 800 min-flow-control-rate 250
    heavy-session threshold 200000
    link-profile max-rate 20000
#exit
traffic-optimization-policy default
#exit
end

```

CUTO-TODR

Sample configuration to enable the CUTO-TODR:

```

context ISP
edr-module active-charging-service
file name EDR directory TODR_CUTO rotation volume 51200 headers
cdr use-harddisk

```



CHAPTER 10

Collection and Reporting of Usage Data over N4 Interface

This chapter covers the following topics:

- [Feature Summary and Revision History, on page 91](#)
- [Feature Description, on page 92](#)
- [How it Works, on page 92](#)
- [Configuration to Collect and Report Volume Measurement over N4 Interface, on page 93](#)

Feature Summary and Revision History

Summary Data

Table 19: Summary Data

Applicable Product(s) or Functional Area	5G-UPF
Applicable Platform(s)	VPC-SI SMI
Feature Default Setting	Enabled – Always-on
Related Changes in this Release	Not Applicable
Related Documentation	Not Applicable

Revision History

Table 20: Revision History

Revision Details	Release
First Introduced	2020.02.0

Feature Description

With this release, the User Plane Function (UPF) supports offline charging and reporting of usage data over the N4 interface.

Here, the SMF controls the collection and reporting of usage data by creating necessary PDRs and URRs, and associates the URRs with its relevant PDRs defined for a PFCP session. It also controls data usage reporting at an IP-CAN bearer level, IP-CAN session, TDF session, SDF, or at an application level.

The URR consists of the usage measurement method, reporting triggers, threshold, and quota values.



Important In this release, only URR creation is supported during PFCP session establishment.

How it Works

This section describes how UPF supports offline charging of usage data.

To implement offline charging, the charging information is sent to the SMF only during PFCP session deletion.

Time and volume-based reporting is supported in the offline charging implementation. The following call flow illustrates offline charging in UPF.

Figure 11: Offline Charging in UPF

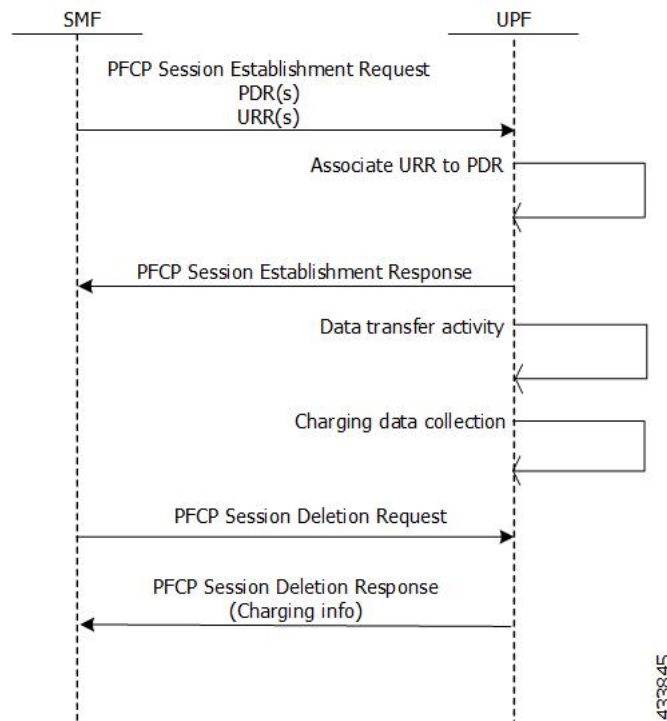

During the PFCP session deletion, UPF transfers the following charging information to the SMF:

- Timestamp of the first and last data packet
- Duration measurement – This IE specifies the time difference between URR creation and usage-reporting
- Volume measurement – This IE specifies the uplink data, downlink data and the total bytes transferred from the UPF to gNodeB.

Standards Compliance

UPF support for collection and reporting of data is compliant with the following standards:

- 3GPP TS 29.244 - LTE; Interface between the Control Plane and the User Plane of EPC Nodes
- 3GPP TS 23.501 - 5G; System Architecture for the 5G System
- 3GPP TS 23.502v - 5G; Procedures for the 5G System

Configuration to Collect and Report Volume Measurement over N4 Interface

This section describes the configuration required to collect and report volume measurement (usage data). However, to achieve this, SMF-based configurations for volume measurement needs to be configured.

The following SMF-based configuration is required to send volume measurement data in the URR by the UPF.

Configuring Charging Action for a Required Billing Action

Use the following configuration to configure charging-action for a required billing-action:

```
configure
  require active-charging
  active-charging service service_name
    charging-action charging_action_name
    billing-action interface_name
  end
```

NOTES:

- **billing-action:** Enables the specified billing type. The supported interfaces are:
 - **egcdr:** Enables the GGSN charging data record.

Associating a Charging Action with a Rulebase

Use the following configuration to associate a charging action with a rulebase:

```
configure
```

```
require active-charging
active-charging service service_name
    rulebase rulebase_name
        billing-records interface_name
        action priority priority_value ruledef ruledef_name charging-action
charging_action_name
end
```

NOTES:

- **rulebase**: Enables the Active Charging Service Rulebase configuration.
- **billing-records**: Enables the generation of billing records. The supported interface is **egcdr**.
- **action**: Decides the action to be taken on the ruledef.
- **priority**: Assigns priority to a ruledef in the rulebase. Priority must be a unique integer value ranging from 1 to 65535.
- **ruledef**: Specifies the ruledef.
- **charging-action**: Specifies the charging action.



CHAPTER 11

Control Plane-Initiated N4 Association Support

This chapter covers the following topics:

- [Feature Summary and Revision History, on page 95](#)
- [Feature Description, on page 96](#)
- [How it Works, on page 96](#)
- [Configuring the CP-Initiated N4 Association Setup Feature, on page 96](#)

Feature Summary and Revision History

Summary Data

Table 21: Summary Data

Applicable Product(s) or Functional Area	5G-UPF
Applicable Platform(s)	VPC-SI SMI
Feature Default Setting	Disabled – Configuration Required
Related Changes in this Release	Not Applicable
Related Documentation	Not Applicable

Revision History

Table 22: Revision History

Revision Details	Release
First Introduced.	2020.02.0

Feature Description

SMF initiated N4 Association Setup Procedure

The N4 association set up procedure sets up an N4 association between the Session Management Function (SMF) and User Plane Function (UPF). It enables the SMF to use the UPF resources to establish the N4 sessions. The SMF and UPF exchange the supported functionalities on each side during this procedure.

How it Works

The N4 association setup is initiated by the SMF. The setting of N4 association setup procedure is controlled through **sx-association initiated-by-cp** CLI command in the Control Plane Group Configuration mode. By default, the configuration is set to support the UPF-initiated N4 association setup procedure.

Call Flows

Session Management Function Initiated N4 Association Setup Procedure

The following call flow depicts the SMF-initiated N4 Association Setup procedure.

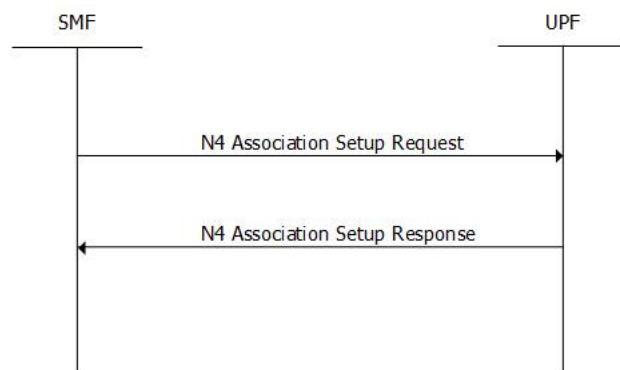

Step	Description
1	The SMF initiates the N4 Association Setup procedure to request the setup of an N4 association towards a UPF prior to establishing a first N4 session on this UPF.
2	After receiving an N4 Association Setup Request, the UPF sends an N4 Association Setup Response.

Configuring the CP-Initiated N4 Association Setup Feature

This section describes how to configure the CP-Initiated N4 Association Setup feature.

Configuring this feature involves using the "**sx-association initiated-by-cp**" CLI command in the Control Plane Group Configuration mode. The default configuration is UPF-initiated N4 association setup procedure.

Use the following configuration to configure the N4 association setup feature.

```
configure
  context
    control-plane-group group_name
      peer-node-id ipv4-address ip_address interface n4
      sx-association { initiated-by-cp | initiated-by-up }
    end
```

NOTES:

- **initiated-by-cp**: This keyword is used to initiate the Sx association request through control plane.
- **initiated-by-up**: This keyword is used to initiate the Sx association request through user plane.
- By default, the UPF-initiated N4 association setup procedure is configured.
- To revert to the default setting, use the **no sx-association** command.

CP-Initiated N4 Association Setup Feature OAM Support

This section describes operations, administration, and maintenance information for this feature.

Show Command Support

Use the following show command to verify the CP-initiated N4 Association Setup feature configuration.

```
show control-plane-group all
```

The following is a sample output of the show command.

```
show control-plane-group all
Control Plane Group
-----
Name           : default
Sx-Association : initiated-by-up
Name           : default
Sx-Association : initiated-by-up
Node-Id        : 209.165.200.230
Interface      : N4
```



CHAPTER 12

Converged Datapath

- [Feature Summary and Revision History, on page 99](#)
- [Feature Description, on page 100](#)
- [How it Works, on page 101](#)
- [Charging for Converged Calls, on page 113](#)
- [Configuring Converged Datapath, on page 115](#)
- [Monitoring and Troubleshooting, on page 116](#)

Feature Summary and Revision History

Summary Data

Table 23: Summary Data

Applicable Product(s) or Functional Area	5G-UPF
Applicable Platform(s)	VPC-SI SMI
Feature Default Setting	Disabled – Configuration Required
Related Changes in this Release	Not Applicable
Related Documentation	<i>UCC 5G UPF Configuration and Administration Guide</i>

Revision History

Table 24: Revision History

Revision Details	Release
Support added for WiFi to LTE handover, and configuration to enable Converged Datapath feature at UPF.	2021.02.0

Revision Details	Release
First introduced.	2021.01.0

Feature Description

The Converged Datapath feature allows interconnection of the same UE's session at UPF instance with SGW-C/cnSGW and Session Management Function (SMF)/Inter-Working Function (IWF) to build converged/collapsed datapath and achieve higher throughput. With this feature:

- The UP/UPF selection logic is enhanced to aid same node selection on SGW-C/cnSGW and SMF.
- The SxDemux selects the same Session Manager (SessMgr) instance based on existing session of N4 or Sxa respectively.
- The Sxa session and N4 session correlation is done at SessMgr.
- The datapath is allowed to be collapsed in the forwarding plane.
- Extra hop in subscriber's datapath is eliminated, resulting in reduced latency and improved user experience.

Architecture

As part of this feature, there are two sessions on the same UPF instance established by SGW-C/cnSGW and SMF. Once they are established, the software logic determines the peer session so that the converged/collapsed datapath for packet processing is possible at the UPF node.

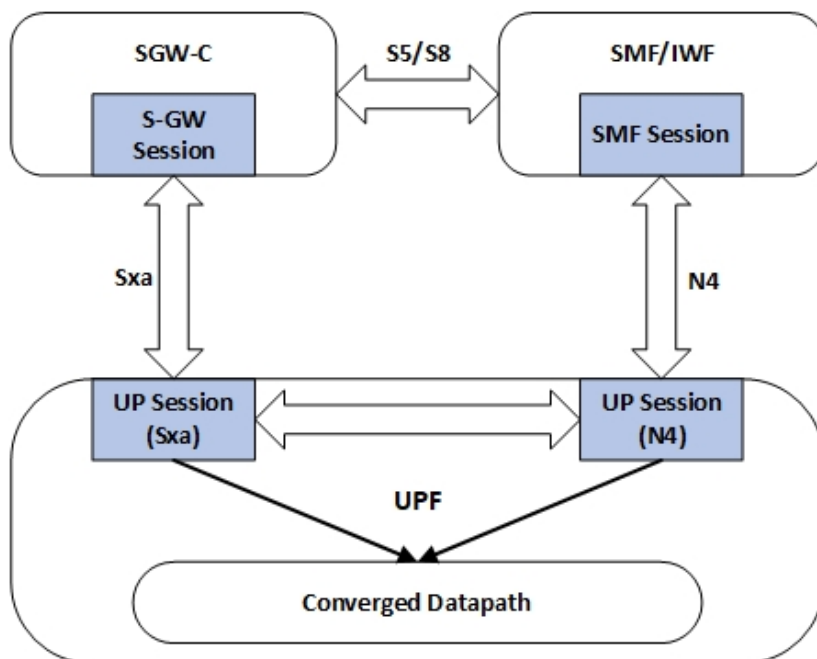

How it Works

This section describes how the feature works.

SxDemuxMgr

In distributed architecture of UP/UPF, sessions (Sxa or N4) run on different SessMgr instances. To support collapsing or converging the sessions to a single SessMgr, the SessMgr instance is selected by both sessions during establishment.

At SxDemux, when Sx Establishment Request (Sxa or N4) is received for selecting the SessMgr instance, it's parsed for finding the SessMgr instance from remote F-TEID, where corresponding sessions (N4 or Sxa respectively) are established. The F-TEID, that contains the Tunnel Identifier that is embedded with SessMgr instance, is extracted.

UPF also maintains IMSI entry at SxDemux. IMSI entry has information of SessMgr ID where the current session is hosted. When Converged Datapath feature is enabled, on receiving Sx Session Establishment Request, SxDemux first tries to find the SessMgr ID using F-TEID. If F-TEID is not present, IMSI lookup is done. If both F-TEID and IMSI is not present, then SxDemux doesn't select the same SessMgr ID for Sxa/N4 leg.

SessMgr

There are two sessions, Sxa and N4, that exist on the same SessMgr instance. To converge them, the following logic is used to identify the session:

- For Uplink Packet: Egress FARs F-TEID matches with Ingress PDRs F-TEID.
- For Downlink Packet: Ingress FAR's F-TEID should match with Egress PDR's F-TEID.

The F-TEID includes both Tunnel Identifier and the endpoint IP address. After the session is identified, the required information is used in datapath to build the converged datapath.

Datapath

After convergence of session occurs at SessMgr, the SessMgr removes the existing Bearer stream (3 tuple) from Fast Path that is installed for Sxa session. It's established only when flow-level stream (6 tuple), based on received packet, is analyzed.

The uplink packet is received by S-GW ingress PDR endpoint. The downlink packet is forwarded using S-GW Ingress FAR-based outer header.

Charging

UPF supports charging of SMF leg (N4 leg) and S-GW .

Call Flows

This section describes the call flows associated with Converged Datapath feature.

Initial Attach with SGW-C/cnSGW and SMF/IWF

The following illustration describes the initial attach call flow with collapsed UPF.

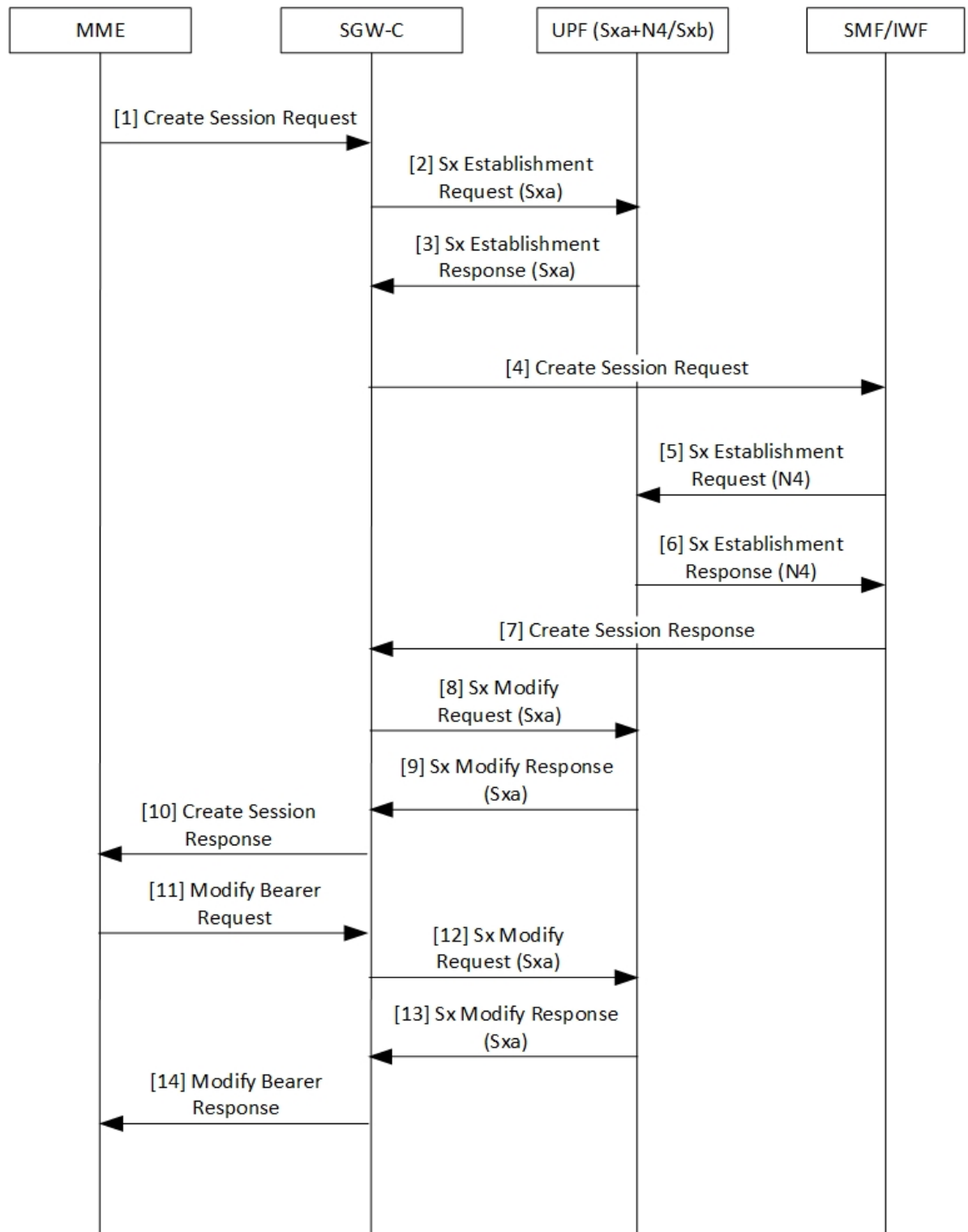
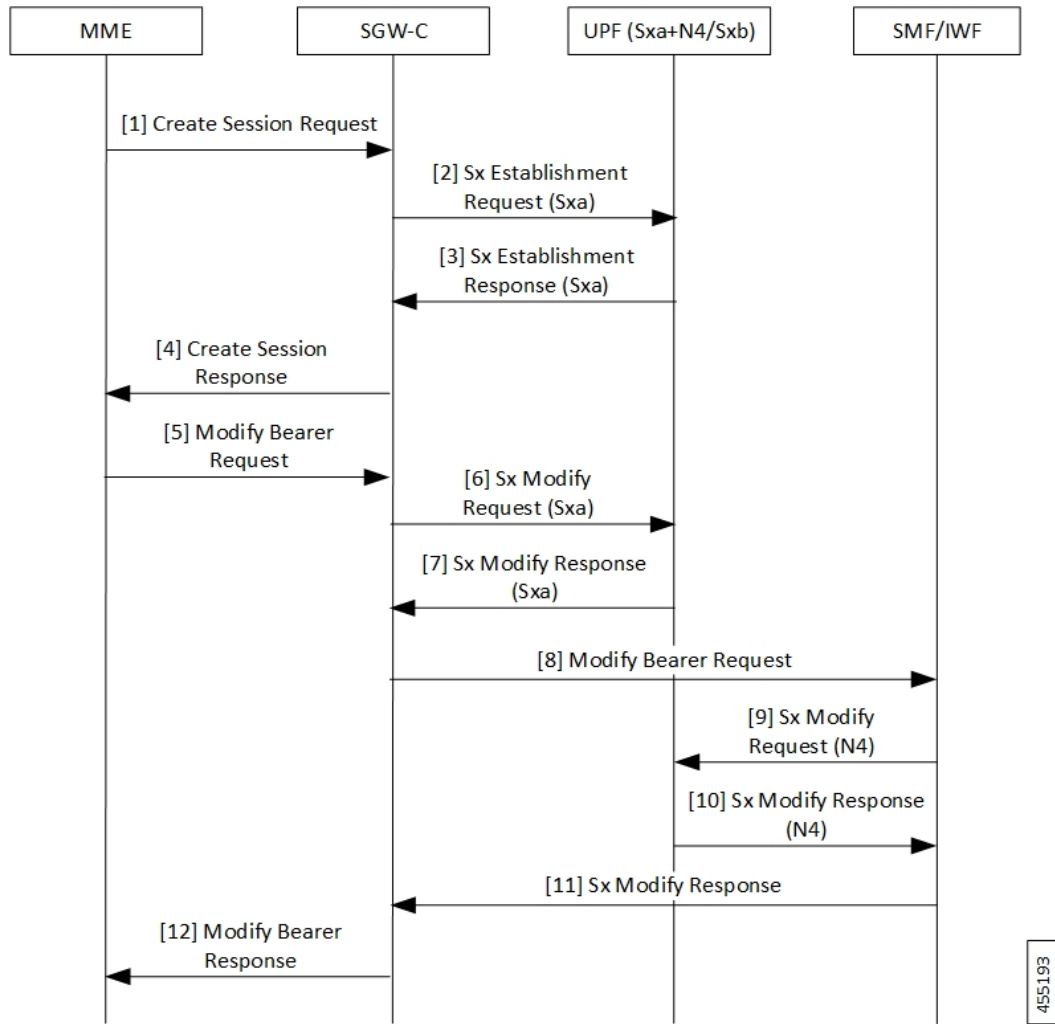

Table 25: Initial Attach with SGW-C/cnSGW and SMF/IWF Call Flow Description

Step	Description
1	Create Session Request (CSReq) is received by SGW-C/cnSGW and it selects the UPF.
2	The SGW-C/cnSGW sends Sx Establishment Request (Sxa) to the UPF. The UPF: <ul style="list-style-type: none"> • Allocates Sxa session • Allocates S-GW Ingress and Egress local F-TEID
3	The UPF sends Sx Establishment Response (Sxa) back to SGW-C/cnSGW.
4	The SGW-C/cnSGW sends CSReq to SMF/IWF. The SMF/IWF selects the same UPF that is selected by SGW-C/cnSGW.
5	The SMF/IWF sends Sx Establishment Request (N4) to the UPF.
6	The UPF sends Sx Establishment Response (N4) to the SMF/IWF.
7	The SMF/IWF sends Create Session Response to the SGW-C/cnSGW.
8	The SGW-C/cnSGW sends Sx Modify Request (Sxa) to the UPF. The UPF updates P-GW data F-TEID as part of Egress FAR. The UPF also interconnects Sxa and N4 session using internal logic and removes already-created Bearer Stream (3 tuple).
9	The UPF sends Sx Modify Response (Sxa) to the SGW-C/cnSGW.
10	The SGW-C/cnSGW sends Create Session Response to the MME.
11	The MME sends Modify Bearer Request to the SGW-C/cnSGW.
12	The SGW-C/cnSGW sends Sx Modify Request (Sxa) to the UPF. The UPF updates eNodeB F-TEID as part of Ingress FAR.
13	The UPF sends Sx Modify Response to the SGW-C/cnSGW.
14	The SGW-C/cnSGW sends Modify Bearer Response to the MME.

5G to 4G Handover with Collapsed UPF

The following illustration describes the 5G to 4G handover call flow with collapsed UPF.



455193

Table 26: 5G to 4G Handover with Collapsed UPF Call Flow Description

Step	Description
1	As part of UE initial attach, N4 session is already established with SMF and UPF. The MME sends Create Session Request (CSReq) to SGW-C/cnSGW. If it's a handover request, the SGW-C/cnSGW selects the same UPF that is selected by the SMF.
2	The SGW-C/cnSGW sends Sx Establishment Request (Sxa) to the UPF. At UPF: <ul style="list-style-type: none"> • SxDemux selects the same SessMgr instance extracted from the P-GW F-TEID that is received in FAR. Both Sxa and N4 session are on the same SessMgr. • Allocates Sxa session • Allocates S-GW Ingress and Egress local F-TEID • Interconnects Sxa and N4 session using internal logic and doesn't install Bearer Stream (3 tuple)

Step	Description
3	The UPF sends Sx Establishment Response (Sxa) back to SGW-C/cnSGW.
4	The SGW-C/cnSGW sends Create Session Response to the MME.
5	The MME sends Modify Bearer Request to the SGW-C/cnSGW.
6	The SGW-C/cnSGW sends Sx Modify Request (Sxa) to the UPF. The UPF updates eNodeB F-TEID for downlink data.
7	The UPF sends Sx Modify Response (Sxa) to the SGW-C/cnSGW.
8	The SGW-C/cnSGW sends Modify Bearer Request to the SMF/IWF.
9	The SMF/IWF sends Sx Modify Bearer Request (N4) to the UPF. The UPF: <ul style="list-style-type: none"> • Updates N4 session FAR towards S-GW with F-TEID • Updates TEP entries at VPP with new F-TEID
10	The UPF sends Sx Modify Response (N4) to the SMF/IWF.
11	The SMF/IWF sends Sx Modify Response to the SGW-C/cnSGW.
12	The SGW-C/cnSGW sends Modify Bearer Response to the MME.

Intra S-GW Handover with Collapsed UPF

The following illustration describes the intra-SGW handover call flow with collapsed UPF.

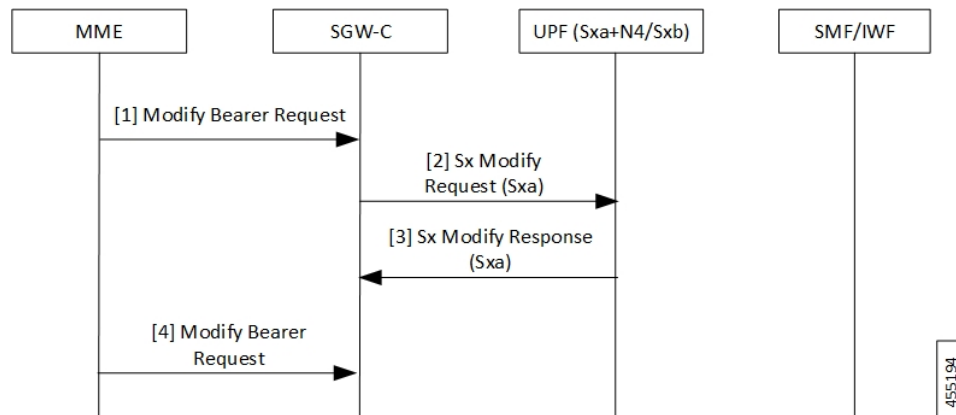

Table 27: Intra S-GW Handover with Collapsed UPF Call Flow Description

Step	Description
1	As part of UE initial attach, N4 and Sxa session is already established with SMF and UPF. At UPF, N4+Sxa session exists and are interconnected. The MME sends Modify Bearer Request to the SGW-C/cnSGW. The SGW-C/cnSGW updates eNodeB F-TEID in FAR.

Step	Description
2	The SGW-C/cnSGW sends Sx Modify Request (Sxa) to the UPF. The UPF: <ul style="list-style-type: none"> • Updates eNodeB F-TEID for downlink data • Updates TEP entries at VPP with new Remove TEID
3	The UPF sends Sx Modify Response (Sxa) to the SGW-C/cnSGW.
4	The SGW-C/cnSGW sends Modify Bearer Response to the MME.

Idle/Active DDN Handling with Collapsed UPF

The following illustration describes the Idle/Active DDN handling with collapsed UPF.

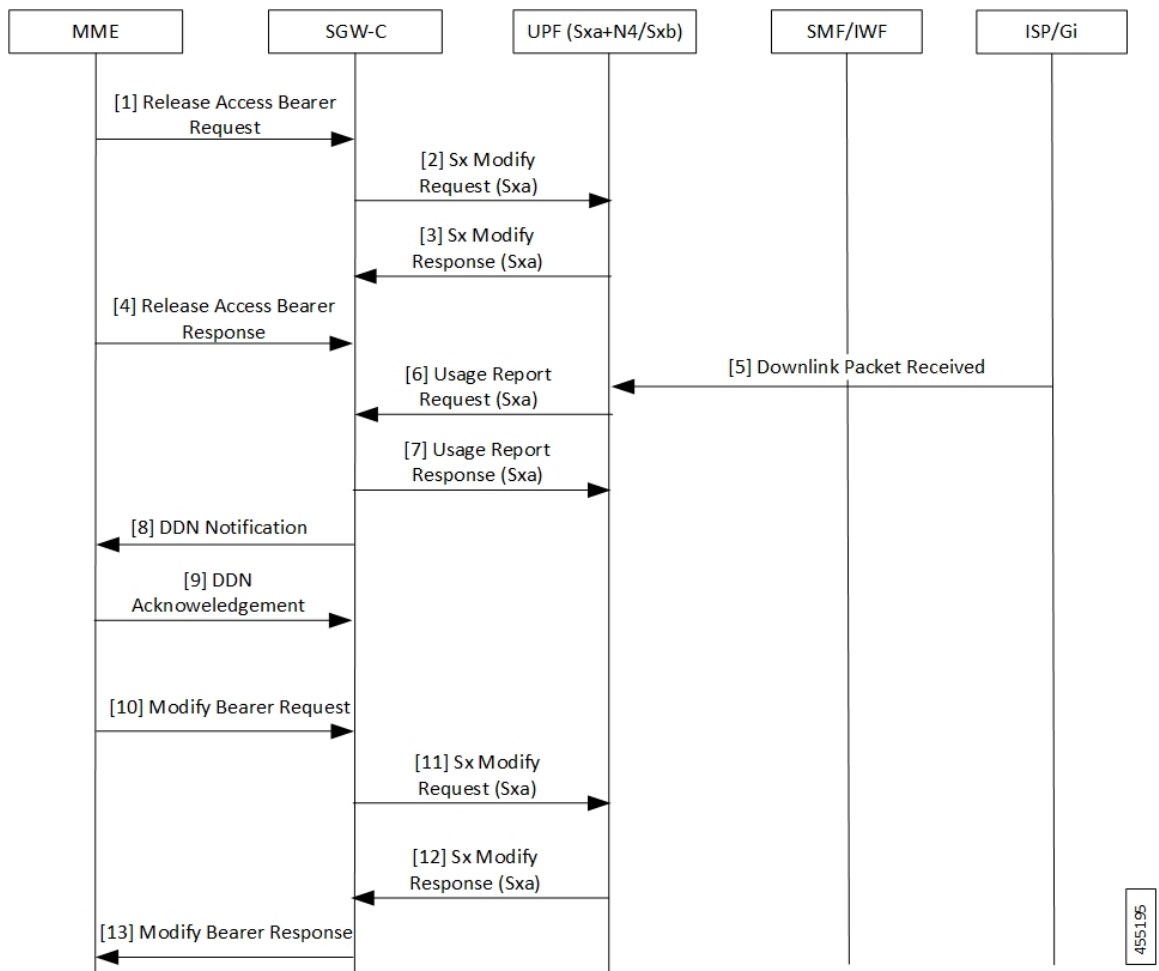

455195

Table 28: Idle/Active DDN Handling with Collapsed UPF Call Flow Description

Step	Description
1	As part of UE initial attach, N4 and Sxa session is already established with SMF and UPF. At UPF, N4+Sxa session exists and are interconnected. At MME, the UE goes from Active to Idle state. The MME sends Release Access Bearer Request to the SGW-C/cnSGW. The SGW-C/cnSGW informs UPF to buffer packets.
2	The SGW-C/cnSGW sends Sx Modify Request (Sxa) to the UPF. The UPF updates FAR action towards eNodeB to buffer state. 6 tuple flows are unloaded for buffering.
3	The UPF sends Sx Modify Response (Sxa) back to SGW-C/cnSGW.
4	The MME sends Release Access Bearer Response to the SGW-C/cnSGW.
5	The ISP/Gi sends the received downlink packet to the UPF. The packet received by UPF at N4 session is passed to interconnect Sxa session for buffering.
6	The UPF sends Usage Report Request (Sxa) to the SGW-C/cnSGW.
7	The SGW-C/cnSGW sends Usage Report Response (Sxa) to the UPF.
8	The SGW-C/cnSGW sends DDN notification to the MME.
9	The MME sends DDN Acknowledgment back to the SGW-C/cnSGW.
10	At MME, the UE moves from Idle to Active. The MME sends Modify Bearer Request to the SGW-C/cnSGW. The SGW-C/cnSGW: <ul style="list-style-type: none"> • Updates eNodeB F-TEID in FAR • Updates FAR action to Forward
11	The SGW-C/cnSGW sends Sx Modify Request (Sxa) to the UPF. The UPF: <ul style="list-style-type: none"> • Updates eNodeB F-TEID for downlink data • Updates TEP entries at VPP with new Remove TEID • Releases buffered packets by finding respective 6 tuple streams
12	The UPF sends Sx Modify Response (Sxa) to the SGW-C/cnSGW.
13	The SGW-C/cnSGW sends Modify Bearer Response to the MME.

IDFT Handling during S1 Handover

The following illustration describes the IDFT handling during S1 handover with collapsed UPF.

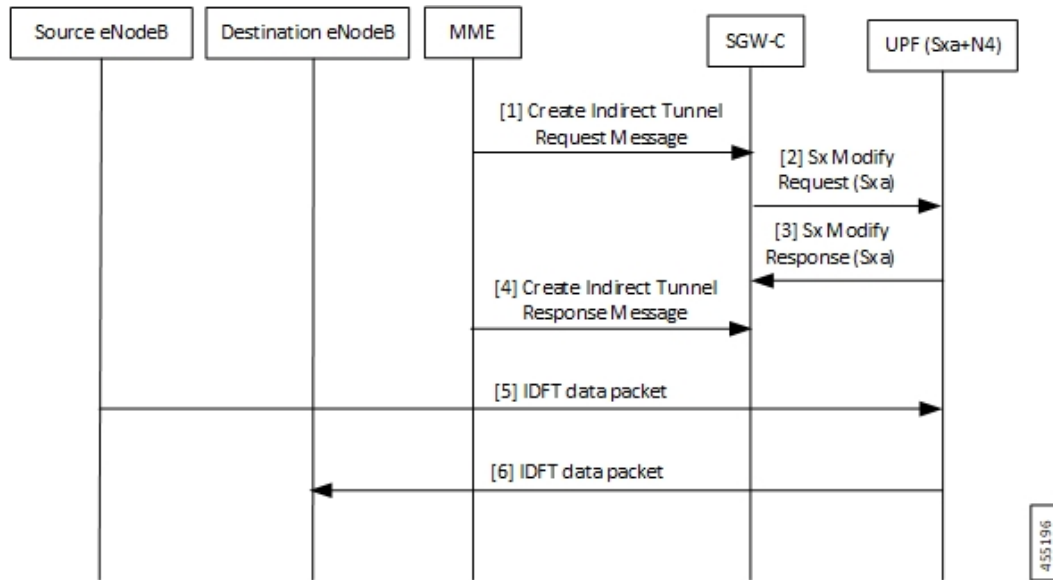

Table 29: IDFT Handling during S1 Handover Call Flow Description

Step	Description
1	As part of initial attach, N4 and Sxa session is already established with SMF and UPF. S1 handoff is triggered. The MME sends Indirect Tunnel Request Message to the SGW-C/cnSGW.
2	The SGW-C/cnSGW sends Sx Modify Request (Sxa) to the UPF. At UPF: <ul style="list-style-type: none"> • IDFT PDR is detected at SessMgr • New F-TEID is allocated for IDFT tunnel • Converged datapath is not required and traffic goes through Slowpath
3	The UPF sends Sx Modify Response (Sxa) to the SGW-C/cnSGW.
4	The SGW-C/cnSGW sends Create Indirect Tunnel Response Message to the MME.
5	The Source eNodeB sends IDFT data packet to the UPF. If there's no matching 3 tuple stream at UPF, the packet is forwarded to SessMgr.
6	The UPF sends IDFT data packet to the destination eNodeB.

S-GW Relocation with Same SGW-U

The following illustration describes the S-GW relocation with destination S-GW selecting the same UPF.

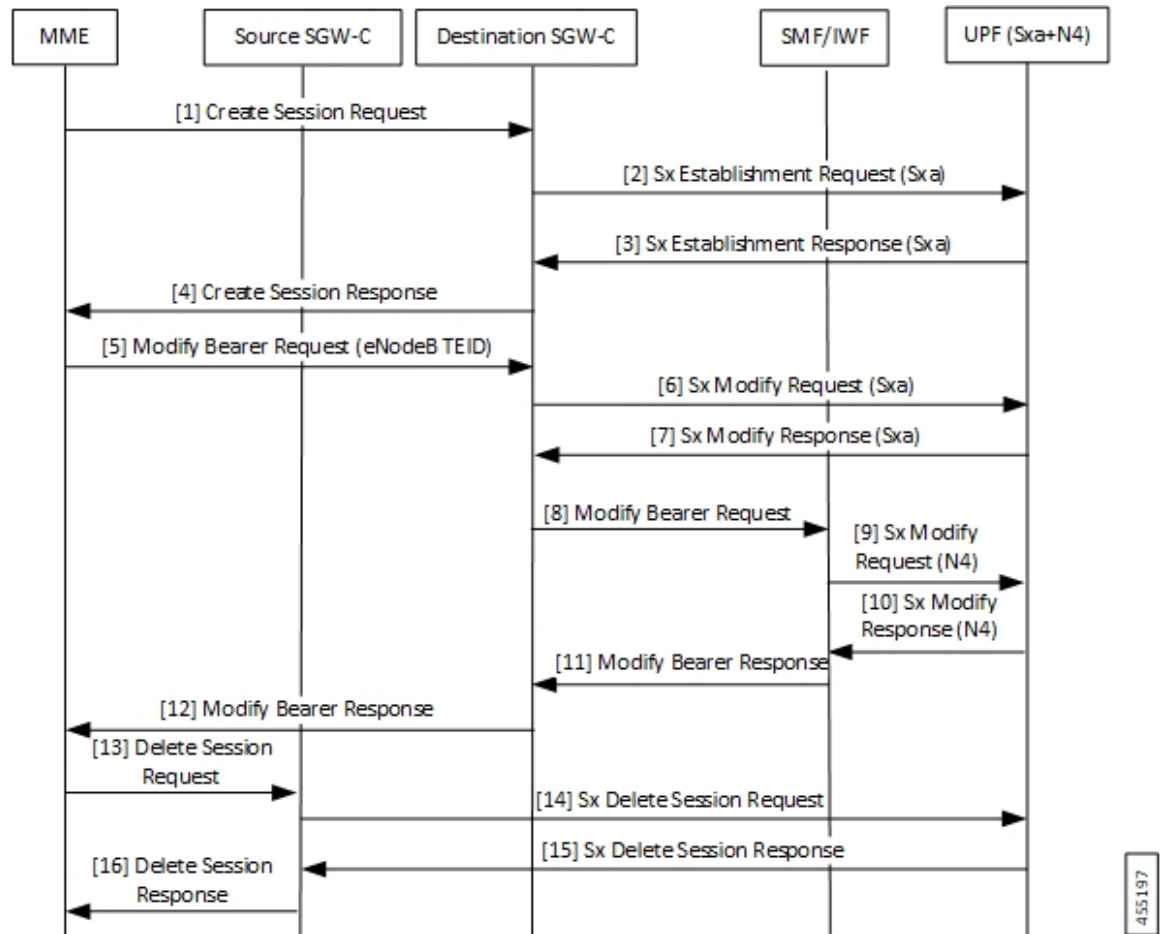

Table 30: S-GW Relocation with Same SGW-U Call Flow Description

Step	Description
1	As part of initial attach, N4 and Sxa session is already established with Source SGW-C/cnSGW, SMF/IWF, and UPF. The MME sends Create Session Request to the destination SGW-C/cnSGW.
2	The destination SGW-C/cnSGW sends Sx Establishment Request (Sxa) to the UPF. The UPF links new Sxa session with the N4 session for uplink packets (Slowpath).
3	The UPF sends Sx Establishment Response (Sxa) to the destination SGW-C/cnSGW.
4	The destination SGW-C/cnSGW sends Create Session Response to the MME.
5	The MME sends Modify Bearer Request (eNodeB F-TEID) to the destination SGW-C/cnSGW.
6	The destination SGW-C/cnSGW sends Sx Modify Request (Sxa) to the UPF.
7	The UPF sends Sx Modify Response (Sxa) to the destination SGW-C/cnSGW.
8	The destination SGW-C/cnSGW sends Modify Bearer Request to the SMF/IWF.

Step	Description
9	The SMF/IWF sends Sx Modify Request (N4) to the UPF. The UPF switches downlink tunnel and links the N4 session with the new Sxa session.
10	The UPF sends Sx Modify Response (N4) to the SMF/IWF.
11	The SMF/IWF sends Modify Bearer Response to the destination SGW-C/cnSGW.
12	The destination SGW-C/cnSGW sends Modify Bearer Response to the MME.
13	The MME sends Delete Session Request to the source SGW-C/cnSGW.
14	The source SGW-C/cnSGW sends Sx Delete Session Request to the UPF.
15	The UPF sends Sx Delete Session Response to the source SGW-C/cnSGW.
16	The source SGW-C/cnSGW sends Delete Session Request to the MME.

WiFi to LTE Handover

The following illustration describes the WiFi to LTE handover call flow.

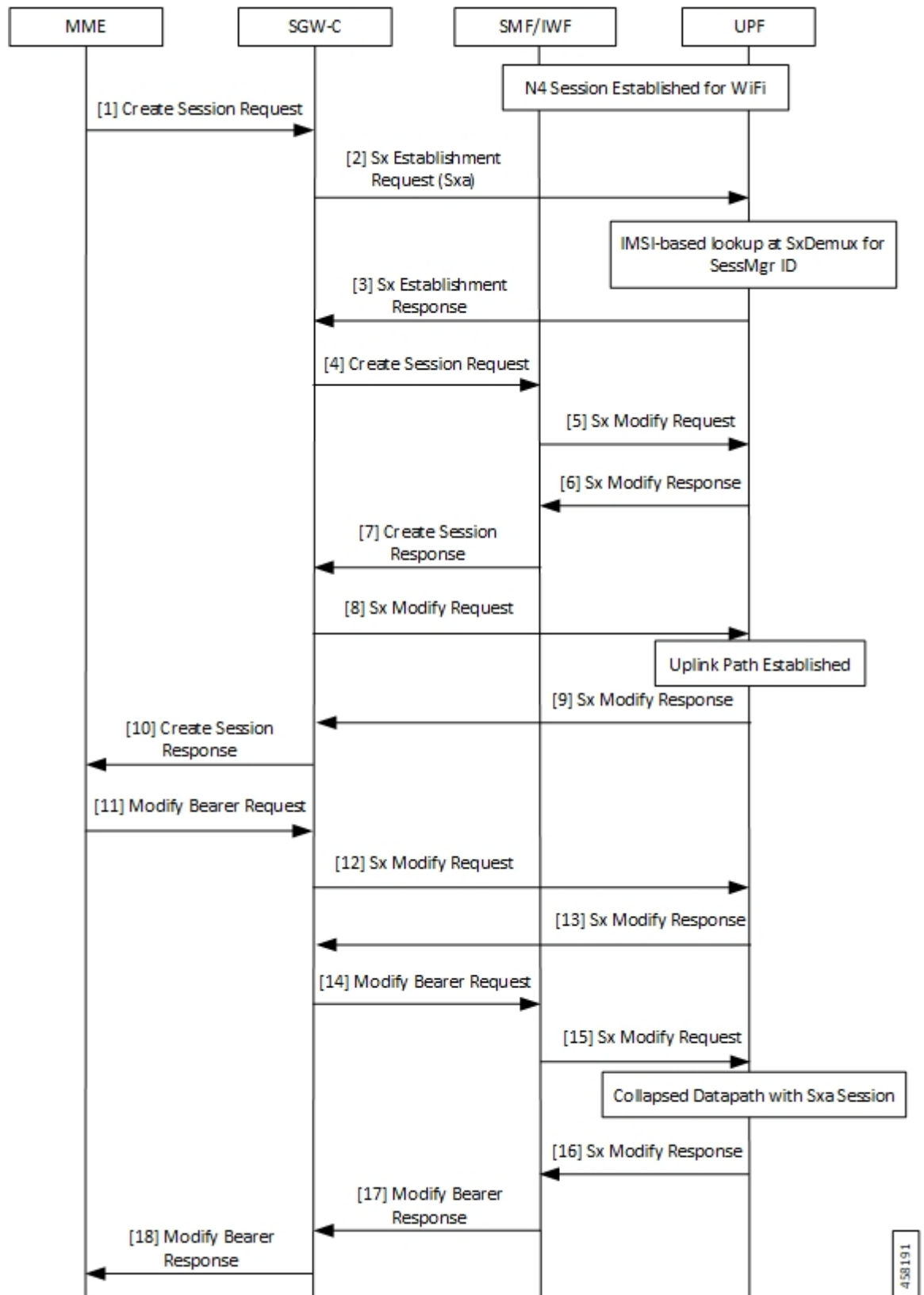

Table 31: WiFi to LTE Handover Call Flow Description

Step	Description
1	N4 Session is established for WiFi between SMF/IWF and UPF. The MME sends Create Session Request (relocating to 4G) to the SGW-C/cnSGW.
2	The SGW-C/cnSGW sends Sx Session Establishment Request (No F-TEID) to the UPF.
3	IMSI-based lookup is done at SxDemux for SessMgr ID. The UPF sends Sx Establishment Response to the SGW-C/cnSGW.
4	The SGW-C/cnSGW sends Create Session Request to the SMF/IWF.
5	The SMF/IWF sends Sx Modify Request with new Uplink RB PDR to the UPF.
6	The UPF sends Sx Modify Response to the SMF/IWF with new TEID for Uplink data.
7	The SMF/IWF sends Create Session Response to the SGW-C/cnSGW.
8	The SGW-C/cnSGW sends Sx Modify Request to the UPF with updated Uplink FAR.
9	Uplink path is established. The UPF sends Sx Modify Response to the SGW-C/cnSGW.
10	The SGW-C/cnSGW sends Create Session Response to the MME.
11	The MME sends Modify Bearer Request to the SGW-C/cnSGW.
12	The SGW-C/cnSGW sends Sx Modify Request to the UPF with eNodeB TEIDs.
13	The UPF sends Sx Modify Response back to the SGW-C/cnSGW.
14	The SGW-C/cnSGW sends Modify Bearer Request to the SMF/IWF.
15	The SMF/IWF sends tunnel switch Sx Modify Request to the UPF.
16	Collapsed datapath with Sxa session is established at UPF. The UPF sends Sx Modify Response to the SMF/IWF.
17	The SMF/IWF sends Modify Bearer Response to the SGW-C/cnSGW.
18	The SGW-C/cnSGW sends Modify Bearer Response to the MME.

Limitations

The following are the known limitations of the feature:

- If Sxa leg is of one user-plane-service and N4 leg is of another user-plane-service, then datapath won't be collapsed.
- If Sxa leg is under one context and N4 leg is in another context, then datapath can't be collapsed.
- The S-GW part of the **show subscribers user-plane-only full all** CLI output doesn't display ToS-marked Uplink and Downlink packets.

- For the S-GW part of the **show user-plane-service statistics rat all** CLI output, the session statistics for Unknown is incremented, however, the data statistics aren't incremented under RAT-type Unknown.
- Lawful Intercept for S-GW isn't supported.
- S-GW bearer inactivity timeout isn't honored, as it's determined by S-GW URR for which processing isn't done for collapsed datapath.
- If S-GW leg of call is locally purged for converged session, then the UPF continues to send data toward eNodeB.

Charging for Converged Calls

Table 32: Feature History

Feature Name	Release Information	Description
Charging Support for Converged Calls	2024.02.0	<p>UPF supports S-GW Charging Data Record (CDR) volume reporting for converged calls. This feature allows you to use these CDRs for reporting and charging during inbound LBO roaming scenario.</p> <p>This feature introduces a new CLI command converged-sxa-usage-reporting in the ACS Service configuration, to generate the usage report with volume count.</p> <p>Default Setting: Disabled – Configuration Required to Enable</p>

Feature Description

For a converged call, SGW-U sends the usage report to SGW-C based on which the SGW-C generates the CDR. You can enable this feature through the **converged-sxa-usage-reporting** CLI command. Once enabled, SGW-U sends a usage report with volume accounting to SGW-C, based on which the SGW-C generates the CDR.

How it Works

For the SGW-U to update a volume report, the URR linking happens between SGW-U bearer URR and PGW-U, UPF bearer, or SDF level URRs. While the reconciliation of charging on UPF, the reconciliation of charging on Sxa also happens simultaneously. Depending on the threshold triggers, the SGW-U generates the usage report. Examples of threshold triggers are time threshold, volume threshold, and Query URR. Then, SGW-U sends the usage report to SGW-C based on which the SGW-C generates CDR.

To update the volume count for SGW-U bearer URRs along with PGW-U or UPF URRs for a converged call, the following process happens:

- The reference pointer of SGW-U default bearer URR is stored at PGW-U or UPF default bearer URR.

- The reference pointer of SGW-U dedicated bearer URRs is stored at SDF level URRs of the corresponding dedicated bearer of PGW-U or UPF.

While reconciling the LC count, the URRs of PGW-U or UPF and SGW-U bearer are traversed. Then, the volume counts are updated for both the call ID URRs.



Note

- If a call is established as a converged call, then the reference pointer of SGW-U bearer URR is stored at PGW-U, UPF bearer, or SDF level URR while call convergence.
 - In the case of S-GW relocation from a nonconverged call to a converged call, the URR linking happens. The URR linking implies that the reference pointer of the SGW-U bearer URR is stored at PGW-U, UPF bearer, or SDF level URR.
 - In the case of S-GW relocation from a converged call to a nonconverged call, the URR delinking happens. The URR delinking implies that the reference pointer of SGW-U bearer URR is removed from PGW-U, UPF bearer, or SDF level URR.
 - In the case of recovery, recreation of the link happens, which implies that the reference pointer of SGW-U URR is stored at PGW-U or UPF URR during recovery to maintain consistent behavior.
-

Limitations

The charging for converged calls feature has the following limitations:

- Volume reporting in S-GW URRs is based on the corresponding PGW-U or UPFs URR usage count. For example, the uplink packets that are dropped due to P-GW processing aren't accounted in the Sxa call.
- RA or RS packet charging doesn't happen at UPF. As the Sxa usage report depends on the UPF, the RA or RS packets aren't accounted for charging on the Sxa call.
- Multiple bearers using the same URR ID lead to inconsistency in the usage report that is generated as Sxa.
- For converged calls, if packets aren't charged at N4 leg, then these packets aren't charged at Sxa as well.
- Charging for predefined rules on a dedicated bearer isn't supported for converged calls.
- When the call is getting converged, the feature configuration, either enabled or disabled, remains the same until the duration of the existing call. The change in configuration is applicable from the new call onwards. If the feature is enabled, the charging continues for existing and new URRs. However, if the feature is disabled, the charging doesn't happen for the existing and new URRs.

Configuring eGCDR

The eGCDR configuration is required on PGW-U or UPF to create static default bearer URR at PGW-U or UPF.

The following is a sample configuration:

```
config
  active-charging service ACS
  rulebase starent
```



```
        billing-records egcdr
    end
```

Configuring GTPP Group

The GTPP group configuration is required on PGW-U or UPF to create static default bearer URR at PGW-U or UPF.

The following is a sample configuration:

```
config
  context ISP
    apn intershat
      gtp group my_grp
    end
```

Generating Usage Report with Volume Count for Converged Sxa Calls

To generate the usage report with volume count for Sxa call, use the following sample configuration:

```
config
  active-charging service service_name
    converged-sxa-usage-reporting
  end
```

NOTES:

- **converged-sxa-usage-reporting**: Enable generation of usage reports for converged SxA calls. To disable this functionality, add the **no converged-sxa-usage-reporting** syntax. The default value is **no converged-sxa-usage-reporting**.

Configuration Example

The following is an example configuration of generation of usage report for the converged Sxa call:

```
config
  active-charging service ACS
    converged-sxa-usage-reporting
  end
```

Configuring Converged Datapath

This section describes the CLI commands available in support of the feature.

Enabling Converged Datapath at UPF

Use the following configuration to enable Converged Datapath at UPF.

```
configure
  user-plane converged-mode
end
```

NOTES:

- **user-plane**: Specifies the UPF related to the configuration.
- **converged-mode**: Specifies the collapse datapath of Sxa and N4 calls.
- By default, the CLI is disabled.
- It is recommended to add the CLI in boot configuration.

Configuring Remote Peers for Sxa and N4

Use the following CLI commands to configure remote peers for Sxa and N4 interface.

```
configure
  control-plane-group group_name
    peer-node-id ipv4-address ipv4_address interface n4
    peer-node-id ipv4-address ipv4_address
  end
```

Configuring User Plane Service for Sxa and N4

Use the following CLI commands to configure UP Service for Sxa and N4 interface.

```
configure
  user-plane-service service_name
    associate gtpu-service gtpu_service upf-ingress
    associate gtpu-service gtpu_service sgw-ingress
    associate gtpu-service gtpu_service sgw-egress
    associate gtpu-service gtpu_service cp-tunnel
    associate sx-service sx_service
    associate control-plane-group group_service
  end
```

Monitoring and Troubleshooting

Show Commands and/or Outputs

This section provides information about the show CLI commands and/or outputs available in support of the Converged Datapath feature.

show subscribers user-plane-only all

The output of this CLI command is enhanced to display the following fields to indicate if the session is converged or non-converged:

- Converged
- Non Converged

show subscribers user-plane-only full all

The output of this CLI command is enhanced to display the following fields:

- Converged Session
- Converged Peer Callid

show user-plane-service statistics all

The output of this CLI command is enhanced to display the following fields:

- Converged Data Session PDNs:
 - Active
 - Setup
 - Released

show user-plane-service statistics all



CHAPTER 13

Deep Packet Inspection and Inline Services

- [Feature Summary and Revision History, on page 119](#)
- [Feature Description, on page 120](#)
- [How it Works, on page 122](#)
- [Supported Inline Services, on page 125](#)
- [Configuring the Static and Pre-Defined Rules, on page 164](#)
- [Configuring ACS Ruledef for L7 Protocols for DPI, on page 165](#)
- [Charging Action Configuration for L7 Protocols for DPI, on page 167](#)

Feature Summary and Revision History

Summary Data

Applicable Product(s) or Functional Area	5G-UPF
Applicable Platform(s)	VPC-SI SMI
Feature Default Setting	Disabled – Configuration Required
Related Changes in this Release	Not Applicable
Related Documentation	<i>UCC 5G UPF Configuration and Administration Guide</i>

Revision History

Revision Details	Release
<ul style="list-style-type: none">• NAT Support on the N4 interface has been added.• Subscriber Firewall support in a TCP Idle Timeout has been added.• Support added for capturing data stall issues using 2 new attributes.	2023.04.0

Revision Details	Release
Support has been added for the following functionality: <ul style="list-style-type: none"> • IP Readdressing • RTP Dynamic Flow Detection • Rule-matching for Bearer-specific Filters • QUIC IETF implementation 	2021.02.0
New L7 protocols have been introduced as part of Deep Packet Inspection (DPI).	2021.01.0
The following EDR attributes have been added for TCP: <ul style="list-style-type: none"> • SYN and SYN-ACK packet • SYN-ACK and ACK packet 	2021.01.0
New DNS attributes have been introduced in EDRs.	2021.01.0
First introduced.	2020.02.0

Feature Description

One of the key product capability of Cisco 5G-UPF is integrated Deep Packet Inspection (DPI) based services. DPI is the examination of layer 7 (L7), which contains Uniform Resource Identifier (URI) information. In some cases, layer 3 (L3) and layer 4 (L4) analyzers that identify a trigger condition are insufficient for billing purposes, so layer 7 (L7) examination is used.

DPI performs packet inspection beyond L4 inspection and is typically deployed for detection of URI information at L7 (for example, DNS, HTTP, HTTPS, RTP, and RTSP URLs).

DNS Server Readdressing

Whenever you use an unauthorized DNS server, you can modify the request to readdress the DNS IPs to use authorized servers. A ruledef determines if a packet belongs to a DNS query. It also determines if the DNS query belongs to a set of authorized DNS servers. If the DNS query does not belong to the authorized DNS servers, the flow action picks up DNS servers from the readdress server list.

You can configure the **readdress-server-list** command under active-charging service. When the flow matches a **ruledef**, you can configure the flow action to use the servers from **readdress-server-list**.

To configure the readdress server list under active-charging service, use the following configuration:

```
configure
  active-charging service service_name
    readdress-server-list name_of_list
      server ipv4_address [ port ]
      server ipv6_address [ port ]
```



Note You can configure a maximum number of 10 servers in a readdress server list and a maximum of 10 readdress server lists under active-charging service. Both IPv4 and IPv6 addresses can be configured in the same **readdress-server-list**.

Select the **readdress-server-list** from the list using one of the following methods:

- Round-robin—Server selection occurs in a round-robin manner for every new flow. Inactive servers in the list are not considered during the selection.

This method is the default selection.

- Hierarchy—The servers that are tagged in this approach are primary, secondary, tertiary, and so on, depending on the order they are defined in the **readdress-server-list**. All flows are readdressed to the primary server as long as it is available. If the primary server goes down, then flows are readdressed to the secondary server and the same logic recurs. Once the primary server is active, then flows switch back to the primary server for readdressing.

To configure the DNS readdress server list, use the following CLI configuration under active-charging service.

configure

```

active-charging service service_name
  readdress-server-list name_of_list
    server ipv4_address [ port ]
    server ipv6_address [ port ]
    consecutive-failures integer_value
    response-timeout integer_value
    reactivation-time integer_value

  charging-action action_name
    flow action readdress server-list name_of_list
  exit

```

NOTES:

- **consecutive-failures**—Specify an integer ranging from 1–10. The default value is 5.
- **response-timeout**—Specify an integer ranging from 1–10000 milliseconds. The default value is 1000.
- **reactivation-time**—Specify an integer ranging from 1–1800 seconds. The default value is 300.

Readdress Server States

This section describes the readdress server states:

- Active state—Once configured, all servers are marked as Active.
- Inactive state—If no response is received from the readdressed server, then the server is marked as Inactive.
- Active-Pending state—Once the server is in Active-Pending state, it is available to accept the requests for readdressing. In this state, if a request is readdressed to this server and response is returned from it, then the server state is changed to Active. Otherwise, it is moved back to Inactive state.

How it Works

This section describes the following functionality of DPI:

- DSCP Marking of downlink and uplink packets.
- Traffic Readdressing or Redirecting.

DSCP Marking for Downlink and Uplink Packets

Transport-level marking is the process of marking traffic at UPF with a Differentiated Services Code Point (DSCP) value. The transport-level marking, executed on per-QoS flow, is based on the mapping from 5QI and optional Allocation and Retention Policy (ARP) configuration from SMF.

SMF controls the transport-level marking by providing the DSCP in the ToS (IPv4) or Traffic Class (IPv6) within the Transport Level Marking IE in the FAR, that is associated to the PDR matching the traffic to be marked. UPF performs the transport level marking for detected traffic and sends the marked packet to the peer entity. The SMF can change the transport-level marking by changing the Transport Level Marking IE in the related FAR.

UPF supports the following IEs:

- Inner Packet Marking IE—Marks the tunnel packets for inner packet marking.
- Transport Level Marking Options IE—Copies DSCP of the inner packet to the outer IP header.

Transport Level Marking IE

The "Transport Level Marking" IE type is encoded as shown in the following figure. It indicates the DSCP value for the downlink transport-level marking.

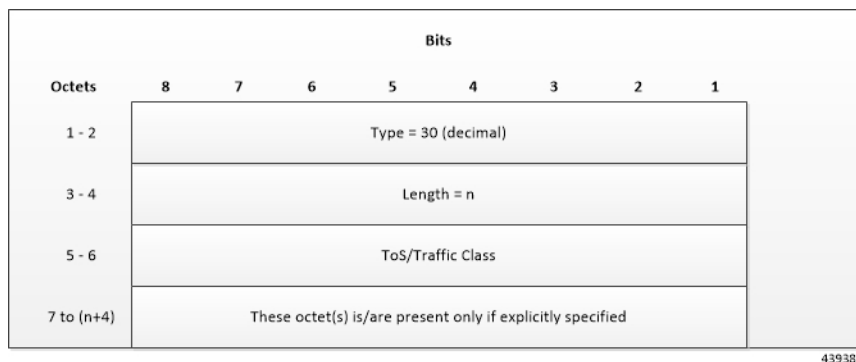

The encoding for Type-of-Service (ToS) or Traffic Class takes place in the form of two octets as an OctetString. The first octet contains the DSCP value in the IPv4 Type-of-Service or the IPv6 Traffic-Class field and the second octet contains the ToS/Traffic Class mask field, which is set to *0xFC*.

Transport Level Marking Options IE

The "Transport Level Marking Options" IE type is encoded as shown in the following figure. The DSCP for downlink transport-level marking is copied from the inner packet.

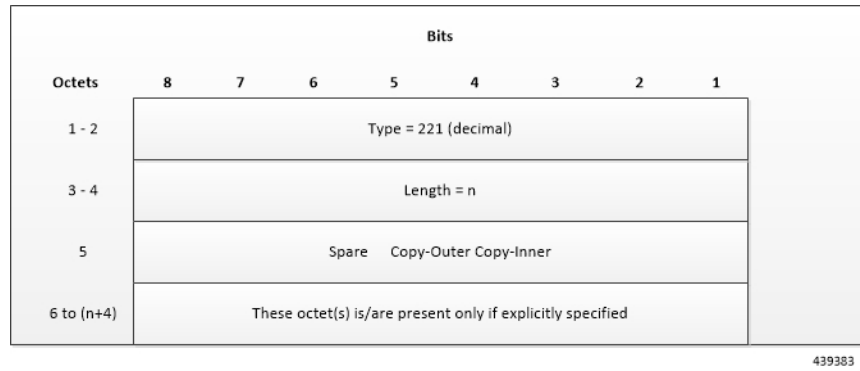

The Copy-Inner and Copy-Outer flags are present in bit-0 and bit-1 of octet 5. Copy-Outer flag is not used for downlink packets because there is no outer header present in packets coming from ISP. If a Copy-Inner flag is present, then the UPF uses DSCP value from the inner packet to mark the transport-level IP header.

Inner Packet Marking IE

The "Inner Packet Marking" IE type is encoded as shown in the following figure. It indicates the DSCP value for the downlink inner packet marking.

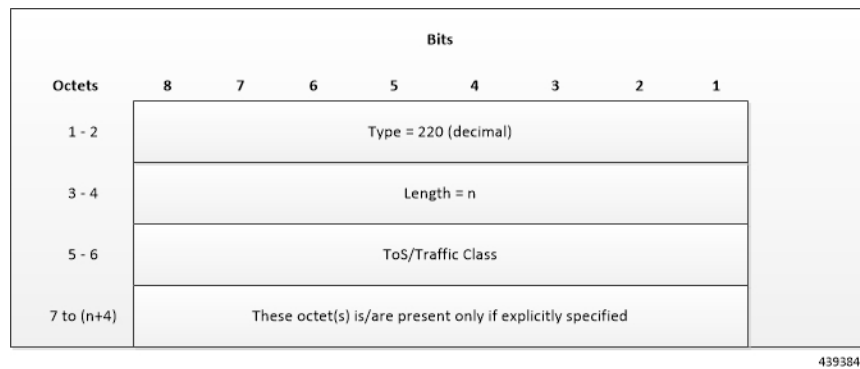

The encoding for ToS/Traffic Class takes place in the form of two octets as an OctetString. The first octet contains the DSCP value in the IPv4 ToS or the IPv6 Traffic Class field and the second octet contains the ToS/Traffic Class mask field, which is set to *0xFC*.

NOTES:

- The original ECN bits in the IP header of User Plane packets do not change after applying transport-level marking or inner packet marking.
- If "Transport Level Marking" IE, "Inner Packet Marking" IE, or both the IEs are associated with uplink FAR, then the following rule applies for uplink packet marking:
 - If "Transport Level Marking" or "Inner Packet Marking" IE is present, its DSCP value is used.
 - If both "Transport Level Marking" and "Inner Packet Marking IE" are present, then the value from "Transport Level Marking" IE is used for uplink packet marking.

Traffic Readdressing or Redirecting

Traffic Redirection is the process of redirecting uplink application traffic to a redirect destination. For example, redirect some HTTP flows to service provisioning page. The redirect destination is provided by the PCF or it is preconfigured in the SMF or in the UPF.

The traffic redirection enforcement is applicable for the SMF or in the UPF if the traffic that the UPF supports subjects to traffic redirection. The UPF reports to the SMF whether it supports traffic redirection enforcement in the UPF through the "UP-Function Features" IE.

To enforce the traffic redirection in the UPF, the SMF takes the following actions:

- Creates the necessary PDRs, if it does not exist, to represent the traffic redirection.
- Creates a FAR with:
 - The "Redirect Information" IE, that includes the redirect destination, if the traffic needs redirection toward a redirect destination that is provided by the SMF. The redirect destination from the SMF prevails over a redirect destination that is preconfigured in the UPF.
 - For HTTP traffic redirection, the Redirection Address Type is set to "URL" and the SMF sets the "Destination Interface" IE in the FAR to "Access" (to forward the HTTP Response message with a status-code indicating redirect). For other types of traffic redirection, the "Destination Interface" IE in the FAR is set to "Core".
- Associates the FAR to the above PDRs of the PFCP session.

Redirect Information IE

Redirect information is encoded as follows:

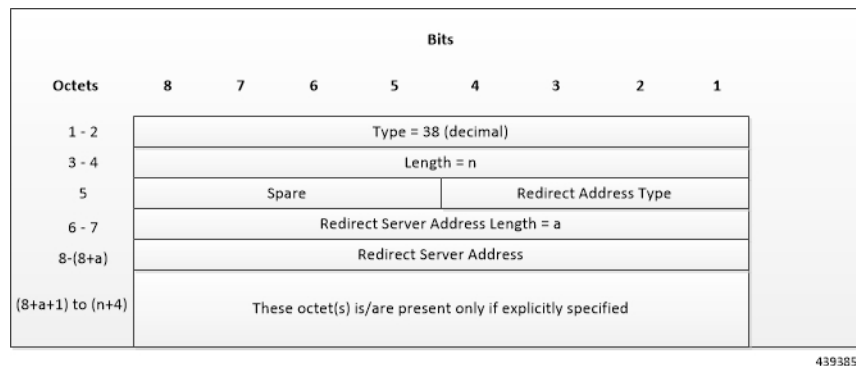

"Redirect Address Type" indicates the type of the redirect address:

Redirect Address Type	Value (Decimal)
IPv4 address	0
IPv6 address	1
URL	2
SIP URI	3
Spare, for future use.	4–15

The "Redirect Server Address Length" indicates the length of the "Redirect Server Address". The "Redirect Server Address" encoding is in UTF8String format and contains the address of the redirect server (for example, HTTP redirect server, SIP server) with which the end user connects.



Important In this release, only Redirect Address Type URL is supported for dynamic rule when FAR is associated with URR where quota expires.

Supported Inline Services

Application Detection and Control

The ADC in-line service is used to detect Peer-to-Peer protocols by analyzing traffic. Other popular applications that generate the bulk of Internet traffic like Social Networking and Gaming applications can be detected.

The in-line service known as ADC is also referred as "P2P". Peer to Peer (P2P) is a term used in two slightly different contexts. At a functional level, it means protocols that interact in a peering manner, in contrast to client/server manner. There is no clear differentiation between the function of one node or another. Any node can function as a client, a server, or both—a protocol may not clearly differentiate between the two. For example, peering exchanges may simultaneously include client and server functionality, sending and receiving information.



Note The ADC support is a licensed feature. Contact your Cisco Account or Support representative for information on how to obtain a license.

QUIC IETF Implementation

In the current framework, Deep Packet Inspection (DPI) is done for every packet in a flow when it reaches the plugin. The DPI is done by analyzing the packets and extracting deterministic patterns. The DPI is done in-order to detect the application and to classify its subtype. Plugin excludes the flow after the DPI. The flow is offloaded after the detection. As part of QUIC IETF, the initial QUIC handshake packets (Client/Server Hello) are encrypted over the network. Hence, there are no deterministic patterns available for detection of the application. Support is added in p2p plugin to decrypt and obtain the SNI (Server Name Indication) for detection.

Configuring QUIC IETF

Use the following configuration to enable or disable the QUIC IETF decryption.

```
configure
  active-charging service acs_service_name
    p2p-detection debug-param protocol-param p2p_quic_ietf_decrypt 1
  end
```

**Note**

- By default, the CLI is disabled and there's minimal impact on the performance due to TLS decryption.
- Runtime change of configuration doesn't impact the existing flow. Change is applicable only for new flow.

Statistics

show user-plane-service statistics analyzer name p2p

Use this show CLI command to determine the packets that are analyzed for QUIC and application.

Content Filtering

Content Filtering is an in-line service available for 3GPP and 3GPP2 networks to filter HTTP requests from mobile subscribers based on the URLs in the requests. This enables operators to filter and control the content that an individual subscriber can access, so that subscribers are inadvertently not exposed to universally unacceptable content and/or content inappropriate as per the subscribers' preferences.

Content Filtering Configuration

Use the following additional configuration to enable the content filtering:

```
configure
  require user-plane content-filtering
  content-filtering category database directory path path_address
  content-filtering category database max-version version_number
end
```

**Note**

The above configuration must be configured on the UPF, during boot time, to enable Content Filtering. Defining the above configuration post the User Plane configuration will lead to errors and inconsistencies.

Show Commands Input and/or Outputs**show subscribers user-plane-only callid *call_id* full all**

SMF provides Content Filtering Policy ID in the Session Establishment/Modification Request. The following fields are displayed in support of this feature:

- SUBSCRIBER PARAMS
 - Content Filtering Policy ID

DNS Snooping

Charging

The charging of DNS Snooping takes place at SM-P.

Rule Definitions

Use the following CLI commands for specifying the rule definition hostnames (domain-names) and part of the host names.

```
ruledef <ruledef_name>
    ip [server-domain-name {contains|=|ends-with|starts-with} <url_string>]
    ip [server-domain-name {contains|=|ends-with|starts-with} <url_string>]
    multi-line-OR enabled
```

Use the no version of this CLI to delete the ruleline for ip server- domain-name.

```
ruledef <ruledef_name>
    no ip [server-domain-name {contains|=|ends-with|starts-with} <url_string>]
    exit
```

Use the following CLI for configurable timer of DNS entries at ECS level.

```
configure
    active-charging service <service_name>
        ip dns-resolved-entries timeout <value_secs>
    end
```

Whenever the ruledef containing the ip server-domain-name keyword is defined and used in rulebase, the ip-table is created per rulebase per instance.

Rule Matching

The functionality remains the same as the non-CUPS architecture.

Show CLIs

Use the following CLIs to check the table for DNS IP entries:**show user-plane-service [statistics dns-learnt-ip-addresses {summary | sessmgr instance <id> |all [verbose] }]**

Bulkstats

The following bulkstats are available in support of DNS Snooping feature:

- ecs-dns-learnt-ipv4-entries
- ecs-dns-flushed-ipv4-entries
- ecs-dns-replaced-ipv4-entries
- ecs-dns-overflown-ipv4-entries
- ecs-dns-learnt-ipv6-entries

- ecs-dns-flushed-ipv6-entries
- ecs-dns-replaced-ipv6-entries
- ecs-dns-overflown-ipv6-entries

The above bulkstats are added in the ECS schema same as in the non-CUPS architecture.



Note The SNMP Trap generation commands are not supported in CUPS DNS snooping feature.

Event Data Records

Table 33: Feature History

Feature Name	Release Information	Feature Description
EDR Last Uplink and Downlink Packet Time Attributes	2023.04	The EDR configuration supports two new attributes sn-last-uplink-pkt-time and sn-last-downlink-pkt-time to identify the data stall issue.

Feature Description

Event Data Records (EDR) are usage records with support to configure content information, format, and generation triggers by the system administrative user.

When a flow is terminated, the UPF generates EDRs with detail information of the terminated flow.

How It Works

EDRs are generated from the User Plane on flow termination. During call setup and call modification, all call-specific attributes that are required for EDR generation is sent from SMF to UPF as part of the "Subscriber Params" IE within the Sx Establishment/Modification request messages.

On flow termination, the charging counters are fetched from VPP. All configured call-level attributes in the EDR format configuration along with the charging/volume counter attributes is sent to the CDRMOD procllet. This procllet writes these records to a file/disk, which is transferred to a configured external server.

TCP Fast Open

TCP Fast Open (TFO) is an extension to speed up the opening of successive TCP connections between two endpoints. It works by using a TFO cookie (a TCP option), which is a cryptographic cookie that is stored on the client and set upon the initial connection with the server. When the client reconnects, it sends the initial SYN packet along with the TFO cookie data to authenticate itself. If successful, the server starts sending data to the client even before the reception of the final ACK packet of the three-way handshake. Due to this, the difference between the following packets are recorded to calculate and record the time difference between control packets of TCP flow in EDR:

- SYN and SYN-ACK packet

- SYN-ACK and ACK packet

For information about rule variables that are added to capture the information in EDRs, refer *Configuring Additional TCP Fields* section.

Transaction Complete EDR

Transaction Complete EDRs are generated for HTTP EDRs when an HTTP transaction is completed. On completion, the charging counters are fetched from VPP. All configured call-level attributes in the EDR format configuration along with the charging/volume counter attributes is sent to the CDRMOD procllet. This procllet writes these records to a file/disk, which is transferred to a configured external server.

The following EDR attributes are supported:

- sn-start-time
- sn-end-time
- sn-start-time format MM/DD/YYYY-HH:MM:SS:sss
- sn-end-time format MM/DD/YYYY-HH:MM:SS:sss
- radius-calling-station-id
- radius-called-station-id
- bearer 3gpp imsi
- bearer 3gpp imei
- bearer 3gpp rat-type
- bearer 3gpp user-location-information
- ip subscriber-ip-address
- ip dst-address
- sn-ruledef-name
- sn-subscriber-port
- sn-server-port
- sn-app-protocol
- sn-volume-amt ip bytes uplink
- sn-volume-amt ip bytes downlink
- sn-flow-start-time format seconds
- sn-flow-end-time format seconds
- sn-volume-amt ip pkts uplink
- sn-volume-amt ip pkts downlink
- sn-direction
- traffic-type

- p2p protocol
- p2p app-identifier tls-cname
- p2p app-identifier tls-sni
- p2p app-identifier quic-sni
- bearer 3gpp sgsn-address
- sn-rulebase
- sn-charging-action
- flow tethered-ip-ttl
- flow ttl
- flow ip-control-param
- bearer qci
- tcp flag
- ip server-ip-address
- sn-flow-id
- sn-closure-reason
- sn-duration
- ip src-address
- ip protocol
- sn-charge-volume ip bytes uplink
- sn-charge-volume ip bytes downlink

The following HTTP EDR attributes are supported:

- http url length 2000
- http request method
- http content type
- http user-agent length 255
- http reply code
- http referer
- http host
- http cookie
- http header-length
- transaction-uplink-bytes
- transaction-downlink-bytes

The following DNS EDR attributes are supported:

- dns answer-ip-list
- dns answer-name
- dns previous-state
- dns query-name
- dns query-type
- dns return-code
- dns state
- dns tid

EDR Attributes to Identify Data Stalling

EDR supports the following attributes to identify the data stalling issue:

- **sn-last-uplink-pkt-time**
- **sn-last-downlink-pkt-time**

When the average difference is higher between the last packet on uplink or downlink direction and **sn-end time** (flow release time), it indicates data stalling.

These EDR variables do not capture the packet time of the control packets (FIN/RST/FIN-ACK/TCP TEAR DOWN ACK). The packet time for these packets is captured at the session manager using **sn-end time**.

For the offloaded flows, the attributes **sn-last-uplink-pkt-time** and **sn-last-downlink-pkt-time** is updated for packets going through the fastpath.

Limitations

The EDR feature in UPF has the following limitations:

- EDR will be generated only for flow end condition: Idle timeout, HAGR, normal flow termination, and during the end of a session.
- Charging-Action based EDR configuration is not supported.
- Reporting EDRs are not supported.
- The packet time of the control packet will not be updated for `last_uplink_packet_time` and `last_downlink_packet_time` except mid session TCP ACKs in EDR.

Configuring Event Data Records

Configuring EDRs on UPF

Use the following configuration to configure EDRs on UPF:

```
active-charging service service_name
  rulebase rulebase_name
    flow end-condition { timeout | normal-end-signaling | session-end |
```

```

hagr } charging-edr charging_edr_format_name
      edr transaction-complete { http | dns } charging-edr
charging_edr_format_name
      exit
      edr-format format_name
      attribute attribute_name format time_format priority priority_val

```

NOTES:

- **flow end-condition**—This command allows you to configure the end condition of the session flows related to a user session and triggers EDR generation.
- **timeout**—Creates an EDR with the specified EDR format whenever a flow ends due to a timeout condition.
- **normal-end-signaling**—Creates an EDR with the specified EDR format whenever the flow end is signaled normally. For example, detecting FIN and ACK for a TCP flow, and create an EDR for the flow using the specified EDR format.
- **session-end**—Creates an EDR with the specified EDR format whenever a subscriber session ends. By this option, the session manager creates an EDR with the specified format name for every flow that has had any activity since the last EDR was created for the flow on session end.
- **charging-edr** *charging_edr_format_name*—Specifies the charging EDR format.
- **hagr**—Creates an EDR with the specified EDR format whenever a flow is terminated due to Inter-chassis Session Recovery action.
- **http**—Specifies HTTP protocol-related configuration.
- **dns**—Specifies DNS protocol-related configuration.
- **edr-format** *format_name*—Specifies an EDR that has to be configured.
- **attribute** *attribute_name* **format** *time_format* **priority** *priority_val*—Specifies the specific attribute to capture in EDR. **format** *time_format* specifies the timestamp format. It supports the following time formats:
 - MM/DD/YY-HH:MM:SS
 - MM/DD/YY-HH:MM:SS:sss
 - MM/DD/YYYY-HH:MM:SS
 - MM/DD/YYYY-HH:MM:SS:sss
 - YYYY/MM/DD-HH:MM:SS
 - YYYY/MM/DD-HH:MM:SS:sss
 - YYYYMMDDHHMMSS
 - YYYYMMDDHHMMSSsss
 - Seconds

priority *priority_val* specifies the position priority of the value within the EDR record. It must be an integer from 1 through 65535.

Configuration to Enable EDR Module

Use the following configuration to enable EDR module.

```
configure
  context context_name
    edr-module active-charging-service
  end
```

Configuring Additional TCP Fields

Prior to using the following CLI commands to configure additional TCP fields in the EDR, ensure that all the other EDR configurations are present.

```
configure
  active-charging service service_name
    edr-format edr_format_name
      rule-variable tcp syn-synack-rtt priority priority_value
      rule-variable tcp synack-ack-rtt priority priority_value
    end
```

Monitoring and Troubleshooting

show user-plane-service statistics rulebase name *rulebase_name*

The following fields are displayed in support of this feature:

- Rulebase Name
 - EDRs
 - Charge Volume
 - Uplink Pkts
 - Uplink Bytes
 - Downlink Pkts
 - Downlink Bytes
- Charging EDRs
 - Total Charging EDRs generated
 - EDRs generated for handoff
 - EDRs generated for timeout
 - EDRs generated for normal-end-signaling
 - EDRs generated for session end
 - EDRs generated for rule match
 - EDRs generated for hagr
 - EDRs generated for flow-end content-filtering
 - EDRs generated for flow-end url-blacklisting

```
show user-plane-service edr-format all
```

- EDRs generated for content-filtering
- EDRs generated for url-blacklisting
- EDRs generated for any-error packets
- EDRs generated for firewall deny rule match
- EDRs generated for transaction completion
- EDRs generated for voip call end
- EDRs generated for dcca failure handling
- EDRs generated for TCP optimization on
- EDRs generated for tethering signature change
- EDRs generated for interim interval
- Total Flow-Overflow EDRs
- Total zero-byte EDRs suppressed

```
show user-plane-service edr-format all
```

The following fields are displayed in support of Additional TCP Fields in EDR feature:

- Service Name
 - EDR Format Name
 - rule-variable tcp syn-synack-rtt priority 1
 - rule-variable tcp synack-ack-rtt priority 2

Firewall Support

Table 34: Feature History

Feature Name	Release Information	Description
Firewall TCP Idle Timeout Action	2023.04	<p>The Firewall feature inspects subscriber traffic performing IP session-based access control to protect subscribers from security attacks.</p> <p>UPF supports the TCP Idle Timeout action to drop the subscriber flow or send reset on TCP timeout expiry.</p>

Feature Description

The Firewall feature in UPF inspects subscriber traffic and performs IP session-based access control of individual subscriber sessions to protect the subscribers from malicious security attacks. UPF supports the TCP Idle Timeout action to drop the subscriber flow or send reset on TCP timeout expiry.

The firewall configuration allows the system to inspect each packet of the subscriber data session. It also evaluates the security threat and applies the policies configured on uplink and downlink traffic. Firewall supports validation at per flow-level and per packet.

The Firewall feature supports the following functionality:

- Protection against DoS and DDoS attacks
- Application-level Gateway
- Stateful Packet Inspection and Filtering
- Stateless Packet Inspection and Filtering
- SNMP Thresholding

Subscriber Firewall Configuration

The firewall configurations are available under active charging configuration in UPF:

- Access-Ruledefs
- Firewall-NAT Policy

Enabling Default Firewall for IPv4 and IPv6

To configure the default firewall for IPv4 and IPv6, use the following configuration:

```
configure
  active-charging service service_name
    fw-and-nat policy policy_name
      firewall policy ipv4-and-ipv6
    end
```

Configuring TCP Idle Timeout Action

To configure the TCP Idle timeout action, use the following configuration:

```
configure
  active-charging service service_name
    fw-and-nat policy policy_name
      firewall tcp-idle-timeout-action { drop | reset }
    end
```

NOTES:

- **firewall tcp-idle-timeout-action { drop | reset }**—Specify the Stateful Firewall action to be taken on TCP idle timer expiry.
 - **drop**—Subscriber flow will be cleared or dropped without sending a reset on TCP timeout expiry.
 - **reset**—Specify to send a reset on TCP timeout expiry. This is the default value.

- The **firewall tcp-idle-timeout-action reset** CLI command is applicable only to firewall.
- UPF does not support flow mapping.

Along with the preceding service configuration, the following configuration is the default CLI behavior of various Firewall-related CLI within the service.

```

Dos-Protection:
  Source-Route           : Disabled
  Win-Nuke               : Disabled
  Mime-Flood            : Disabled
  FTP-Bounce            : Disabled
  IP-Unaligned-Timestamp : Disabled
  Seq-Number-Prediction  : Disabled
  TCP-Window-Containment : Disabled
  Teardrop              : Disabled
  UDP Flooding          : Disabled
  ICMP Flooding         : Disabled
  SYN Flooding          : Disabled
  Port Scan             : Disabled
  IPv6 Extension Headers Limit : Disabled
  IPv6 Hop By Hop Options : Disabled
  Hop By Hop Router Alert Option : Disabled
  Hop By Hop Jumbo Payload Option : Disabled
  Invalid Hop By Hop Options : Disabled
  Unknown Hop By Hop Options : Disabled
  IPv6 Destination Options : Disabled
  Invalid Destination Options : Disabled
  Unknown Destination Options : Disabled
  IPv6 Nested Fragmentation : Disabled

Max-Packet-Size:
  ICMP                   : 65535
  Non-ICMP               : 65535

Flooding:
  ICMP limit             : 1000
  UDP limit              : 1000
  TCP-SYN limit          : 1000
  Sampling Interval      : 1

TCP-SYN Flood Intercept:
  Mode                   : None
  Max-Attempts           : 5
  Retrans-timeout        : 60
  Watch-timeout          : 30

Mime-Flood Params:
  HTTP Header-Limit      : 16
  HTTP Max-Header-Field-Size : 4096

No Firewall Ruledef Match Action:
  Uplink Action          : permit
  Downlink Action        : deny

TCP RST Message Threshold : Disabled
ICMP Dest-Unreachable Threshold : Disabled
Action upon receiving TCP SYN packet with ECN/CWR Flag set : Permit
Action upon receiving a malformed packet : Deny
Action upon IP Reassembly Failure : Deny
Action upon receiving an IP packet with invalid Options : Permit
Action upon receiving a TCP packet with invalid Options : Permit
Action upon receiving an ICMP packet with invalid Checksum: Deny
Action upon receiving a TCP packet with invalid Checksum: Deny
Action upon receiving an UDP packet with invalid Checksum: Deny
Action upon receiving an ICMP echo packet with id zero : Permit

```

```
TCP Stateful Checks : Enabled
First Packet Non-SYN Action: Drop
ICMP Stateful Checks: Enabled
TCP Partial Connection Timeout: 30
```

IP Reassembly

This section describes the reassembly functionality:

- In the non-CUPS architecture, fragments are buffered up to 64K bytes with the default Firewall configuration. All buffered and subsequent fragments are dropped beyond 64K bytes. In UPF, it is possible to reassemble the packet size to 9K bytes in a maximum of six fragments.
- The **firewall ip-reassembly-failure** CLI configures teardrop attack, nested fragmentation, and general ip-reassembly-failure. The maximum IP packet size is limited to six fragments (~9000 bytes).
- The following counters in firewall statistics get incremented for all attacks related to reassembly:
 - Downlink Packets Dropped due to IPv4 Reassembly Failure
 - Uplink Packets Dropped due to IPv4 Reassembly Failure
 - Downlink Dropped Bytes on IPv4 Reassembly Failure
 - Uplink Dropped Bytes on IPv4 Reassembly Failure
 - Downlink Packets Dropped due to IPv6 Reassembly Failure
 - Uplink Packets Dropped due to IPv6 Reassembly Failure
 - Downlink Dropped Bytes on IPv6 Reassembly Failure
 - Uplink Dropped Bytes on IPv6 Reassembly Failure

Monitoring and Troubleshooting

This section provides information about show commands and their output in support of this feature.

show config active-charging service name acs verbose

```
fw-and-nat policy SFW_NAT_TEST
  no firewall dos-protection source-router
  no firewall dos-protection winnuke
  no firewall dos-protection mime-flood
  no firewall dos-protection ftp-bounce
  no firewall dos-protection ip-unaligned-timestamp
  no firewall dos-protection tcp-window-containment
  no firewall dos-protection teardrop
  no firewall dos-protection flooding udp
  no firewall dos-protection flooding icmp
  no firewall dos-protection flooding tcp-syn
  no firewall dos-protection port-scan
  no firewall dos-protection ipv6-extension-hdrs
  no firewall dos-protection ipv6-hop-by-hop
  no firewall dos-protection ipv6-hop-by-hop router-alert
  no firewall dos-protection ipv6-hop-by-hop jumbo-payload
  no firewall dos-protection ipv6-hop-by-hop invalid-options
  no firewall dos-protection ipv6-hop-by-hop unknown-options
  no firewall dos-protection ipv6-dst-options
  no firewall dos-protection ipv6-dst-options invalid-options
  no firewall dos-protection ipv6-dst-options unknown-options
```

```

no firewall dos-protection ipv6-frag-hdr nested-fragmentation
no firewall dos-protection ip-sweep tcp-syn
no firewall dos-protection ip-sweep udp
no firewall dos-protection ip-sweep icmp
firewall max-ip-packet-size 65535 protocol icmp
firewall max-ip-packet-size 65535 protocol non-icmp
firewall flooding protocol icmp packet limit 1000
firewall flooding protocol udp packet limit 1000
firewall flooding protocol tcp-syn packet limit 1000
firewall flooding sampling-interval 1
firewall tcp-syn-flood-intercept mode none
firewall tcp-syn-flood-intercept watch-timeout 30
firewall mime-flood http-headers-limit 16
firewall mime-flood max-http-header-field-size 4096
no firewall icmp-destination-unreachable-message-threshold
access-rule no-ruledef-matches uplink action permit
access-rule no-ruledef-matches downlink action deny
firewall tcp-idle-timeout-action reset
no firewall tcp-reset-message-threshold
firewall tcp-syn-with-ecn-cwr permit
firewall malformed-packets drop
firewall ip-reassembly-failure drop
no firewall validate-ip-options
firewall tcp-options-error permit
firewall icmp-echo-id-zero permit
firewall icmp-checksum-error drop
firewall tcp-checksum-error drop
firewall udp-checksum-error drop
firewall tcp-fsm first-packet-non-syn drop
firewall icmp-fsm
firewall policy ipv4-and-ipv6
firewall tcp-partial-connection-timeout 30
no nat policy
no nat binding-record
no nat pkts-dropedr-format
no nat pkts-drop timeout
default nat suppress-aaa-update
nat private-ip-flow-timeout 180
nat check-point-info basic limit-flows 100
nat check-point-info sip-alg
nat check-point-info h323-alg
nat max-chunk-per-realm single-ip
#exit

```

Show CLIs

This section describes the supported show CLI commands for UPF:

- **show subscribers user-plane-only full all**
- **show subscribers user-plane-only flows**
- **show user-plane-service inline-services firewall statistics verbose**
- **show user-plane-service statistics rulebase all**
- **show alarm outstanding all**
- **show alarm outstanding all verbose**
- **show alarm statistics**
- **show user-plane-service statistics rulebase name *rulebase_name***

SNMP Traps

This section describes the SNMP traps. To enable the trap, use the respective trap CLIs on the User Plane.

- **DoS-Attacks**—When the number of DoS attacks exceeds the set threshold value, the SNMP trap is generated. When the number falls below the threshold value within the configured time interval, the trap is cleared.
- **Drop-Packets**—When the number of packets dropped exceeds the threshold value, the SNMP trap is generated. When the number falls below the threshold value within the configured time interval, the trap is cleared.
- **Deny-Rule**—When the number of Deny Rules exceeds the threshold value, the SNMP trap is generated. When the number falls below the threshold value within the configured time interval, the trap is cleared.
- **No-Rule**—When the number of No Rules exceeds the threshold value, the SNMP trap is generated. When the number falls below the threshold value within the configured time interval, the trap is cleared.

Flow Idle Timeout Randomization

Every two seconds, the Session Manager polls the time of the latest packet from Session Manager instance, or the fastpath stream to determine idle flows. Short length flows become idle quickly as they are short due to the lesser number of packets and are short lived, within 5–10 seconds. As a result, large number of idle flows must be deleted due to the timeout at the given polling cycle of two seconds. Deletion of idle flows is CPU intensive as it involves statistics reconciliation, EDR generation, and fast path stream deletion. You can accommodate more flows with this feature as the short lived flows get cleared aggressively.

Configuring Flow Idle Timeout Randomization in ACS

Use the following configuration to randomize the idle timeout flow.

```
configure
active-charging service service_name
  idle-timeout randomize-range range
    { default | no } idle-timeout randomize-range
  end
```

NOTES:

- **idle timeout**: Specifies the maximum duration that a flow can remain idle for, in seconds. Seconds must be an integer from 5 through 30. The flow will then be terminated based on the random value.
- **randomize-range**: Specifies the range of a period of time in seconds. The idle timeout applied, will be different for each flow.

For example,

```
idle-timeout randomize-range 20
```

An integer random number is generated from 0 through 20. This number is added to the configured idle timeout value to check if the flow has become idle in the two second timer processing. If the idle timeout configured is 60 seconds, the actual timeout that is applied to each flow will be random in the range between $60 + 20$ seconds causing staggered flow deletion.

- **no**: Disables the idle timeout randomization. This command is disabled by default.

- **default**: Configures the idle timeout randomization command with its default setting in seconds. Seconds must be an integer from 0 through 30. Default range is 0–30 seconds.

For example, **default idle-timeout randomize-range** is equal to **idle-timeout randomize-range 30**.

HTTP URL Filtering

The HTTP URL Filtering feature simplifies rule definitions used for URL detection.

The HTTP request packet can have a proxy (prefixed) URL and an actual URL. If a proxy URL is found in the HTTP request packet, the HTTP URL Filtering feature truncates this URL from the parsed information and only the actual URL is used for rule matching and Event Data Records (EDR) generation.

Configuring the HTTP URL Filtering Feature

This section describes how to configure the HTTP URL Filtering feature.

Configuring Group of Prefixed URLs

To configure the group of prefixed URLs, use the following CLI commands:

```
configure
  active-charging service ecs_service_name
    group-of-prefixed-urls prefixed_urls_group_name
  end
```

Configuring URLs in the Group of Prefixed URLs

To configure URLs to be filtered in the group of prefixed URLs, use the following CLI commands:

```
configure
  active-charging service ecs_service_name
    group-of-prefixed-urls prefixed_urls_group_name
      prefixed-url url_1
      ...
      prefixed-url url_10
    end
```

Enabling the Group of Prefixed URLs in Rulebase

To enable the group of prefixed URLs in rulebase for processing prefixed URLs, use the following CLI commands:

```
configure
  active-charging service ecs_service_name
    rulebase rulebase_name
      url-preprocessing bypass group-of-prefixed-urls
prefixed_urls_group_name_1
      ...
      url-preprocessing bypass group-of-prefixed-urls
prefixed_urls_group_name_64
    end
```

This configuration on the control plane chassis will be pushed to the user plane with a PFD message for “group-of-prefixed-urls” and “rulebase-url-preprocessing” separately.

The group of prefixed URLs has the list of proxy URLs, which must be truncated. The rulebase contains multiple group of prefixed urls, which must be filtered. Charging ruledefs contain rules for actual URLs that must be searched after truncating URLs in the group of prefixed URLs.



-
- Note**
- Each group of prefixed URLs can have a maximum of ten prefixed URLs.
 - A maximum of 64 group of prefixed URLs can be created and configured.
-

Show Commands

show user-plane-service group-of-prefixed-urls all | name *group_name*

This show command can be used on the user plane to verify whether the group of prefixed URLs are pushed or not. The output of this command is as follows:

- Name of the group of prefixed URLs
- Prefixed URLs
- Total number of prefixed URLs found

show user-plane-service rulebase name *rbase_name*

This show command can be used on the user plane to check whether the group of prefixed URLs is configured in rulebase or not. The output of this command is as follows:

- Name of rulebase
- Name of the groups of prefixed Urls for URL pre-processing

show user-plane-service statistics analyzer name http

The output of this command is as follows:

- Total HTTP Sessions
- Current HTTP Sessions
- Total Uplink Bytes
- Total Downlink Bytes
- Total Uplink Pkts
- Total Downlink Pkts
- Uplink Bytes Retrans
- Downlink Bytes Retrans
- Uplink Pkts Retrans
- Downlink Pkts Retrans
- Total Request Succeed
- Total Request Failed

- GET Requests
- POST Requests
- CONNECT Requests
- PUT requests
- HEAD requests
- Websocket Flows
- Invalid packets
- Wrong FSM packets
- Unknown request method
- Pipeline overflow requests
- Corrupt request packets
- Corrupt response packets
- Unhandled request packets
- Unhandled response packets
- Partial HTTP Header Anomaly prevented
- New requests on closed connection
- Memory allocation failures
- Packets after permanent failure
- Prefixed Urls Bypassed
- FastPath Statistics
- Total FP Flows
- Uplink (Total FP Pkts)
- Downlink (Total FP Pkts)
- Uplink (Total FP Bytes)
- Downlink (Total FP Bytes)



Note Prefixed URLs Bypassed counter has been added in http analyzer stats as a performance measurement to show the number of truncated prefixed URLs.

IP Readdressing

The IP Readdressing feature enables redirecting unknown gateway traffic based on the destination IP address of the packets to known/trusted gateways.

IP Readdressing is configured in the flow action defined in a charging action. IP readdressing works for traffic that matches a particular ruledef, and hence the charging action. IP readdressing is applicable to both uplink and downlink traffic. In the Enhanced Charging Subsystem, uplink packets are modified after packet inspection, rule matching, and so on, where the destination IP or port is determined, and replaced with the readdress IP or port just before they are sent out. Downlink packets (containing the readdressed IP or port) are modified when they are received, before the packet inspection, where the source IP or port is replaced with the original server IP or port number.

For one flow from an MS, if one packet is re-addressed, then all the packets in that flow is re-addressed to the same server. Features like DPI and rule-matching remain unaffected. Each IP address and port combination are defined as a ruledef.

In case of IP fragmentation, packets with successful IP reassembly are readdressed. However, IP fragmentation failure packets are not readdressed.

There are two different approaches for the readdress server selection, in case, server-list is configured under charging-action.

- **round-robin:** In round-robin approach, server selection happens in round-robin manner for every new flow. In round-robin, only active servers in the list are considered for selection.
- **hierarchy-based approach:** In hierarchy-based approach, servers are tagged as primary, secondary, tertiary, and so on, depending on the order they are defined in the readdress server-list. All flows are readdressed to the primary server until it is up and running. If Primary server goes down, then flows are readdressed to secondary server and the same logic goes on. Once primary server is active then flows switch back to primary server for readdressing.

An extra CLI is provided that enables user to select from hierarchy or round-robin approach for server selection. Both round-robin and hierarchy-based server selection approaches are applicable for both IPv4 and IPv6 based servers.

Configuring IP Readdressing

Readdressing of packets based on the destination IP address of the packets enables redirecting unknown gateway traffic to known/trusted gateways. This is implemented by configuring the re-address server in the charging action.

To configure the IP Readdressing feature, use the following configuration:

```
configure
  active-charging service acs_service_name
    charging-action charging_action_name
      flow action readdress server ipv4_address/ipv6_address [
discard-on-failure ] [ dns-proxy-bypass ] [ port port_number [
discard-on-failure ] [ dns-proxy-bypass ] ]
      end
```

To configure the IP Readdressing feature when the readdress server-list is defined under charging-action, use the following configuration:

```
configure
  active-charging service acs_service_name
    charging-action charging_action_name
      flow action readdress server-list server_list_name [ hierarchy ] [
round-robin ] [ dns-proxy-bypass ] [ discard-on-failure ]
      end
```

Following is the sample server-list configuration:

```
readdress-server-list DRE
consecutive-failures 1
response-timeout 10000
server 209.165.200.225 port 53
server 209.165.200.226 port 53
server 2001:420:54fe::1019 port 53
server 2001:420:54fe::1039 port 53
server 2001:420:54fe::1049 port 53
server 2001:420:54fe::1059 port 53
server 209.165.201.30 port 8080
#exit
```



Note A maximum of 10 servers can be configured in the list and a maximum of 10 lists can be configured in active-charging service.

Show Commands

This section provides information about the show CLI commands available in support of IP Readdressing feature.

CLI Command	Description
show user-plane-service readdress-server-list statistics all	Use these show CLI commands to display the readdress server list statistics.
show user-plane-service readdress-server-list statistics instance <i>instance</i>	
show user-plane-service readdress-server-list statistics name <i>name</i>	
show user-plane-service readdress-server-list statistics	

Use the **clear user-plane-service readdress-server-list statistics all** CLI to clear the readdress server list statistics.

Use the **show user-plane-service statistics charging-action all** CLI to check the "flows readdressed" counter.

L7 Protocol

The following L7 protocols are supported as part of DPI:

- DNS
- FTP
- HTTP
- HTTPS
- RTP/RTSP
- SIP

DNS

The UPF supports DNS protocol as part of L7 Analyzer.

FTP

The UPF supports FTP protocol as part of L7 Analyzer.

HTTP

On completion of HTTP Request or HTTP Response, the uplink or downlink data packets are offloaded to VPP in the following cases:

- **Content-Length**—Volume-based offloading is supported for methods such as GET and POST. The HTTP flow with chunk-encoding data transfer mechanism does not get offloaded irrespective of the method defined in HTTP. If the stream is offloaded based on content-length, then the stream on the other end will also get offloaded until the former is not unloaded.
- **CONNECT Method**—The method where both uplink and downlink streams are offloaded after the flow is upgraded to CONNECT.
- **WebSocket Method**—After the flow is classified as WebSocket protocol, both uplink and downlink streams are offloaded.
- The streams are unloaded back in either of the following cases:
 - FIN packet received
 - Content-length is breached
 - PDN update

Header Parsing

Only the header fields defined in ruledefs, which are included in rulebase, are parsed. For x-header features, redirection is configured with dependencies on some HTTP header fields.

HTTP Charging

- Complete packets are charged.
- Partial packets are charged on completion. Packet completing the partial packet is also charged.
- Concatenated packets are charged.
- Delay Charging is enabled – Control packets are charged against application-based rule, depending on delay charging CLI configuration.
- Response-based charging is enabled – After HTTP request's response is received, then the HTTP request is charged against response rule's CA.

X-Header Parsing and Rule-Matching

Ruledefs with x-header rule-lines are parsed and matched.

WebSocket

Involves charging of subsequent packets of the flow after HTTP GET request as per the HTTP request, if the HTTP flow is upgraded to be a websocket flow.

Response-based TRM

Transactional Rule Matching is engaged after HTTP response packet is received.

X-Header Insertion

X-header Insertion is supported in HTTP Requests.

URL-based Redirection

The redirect URL specifies UPF to return a redirect response to the subscriber and terminate the TCP connections. The subscriber web browser automatically sends the original HTTP packet to the specified URL. If the flow is not HTTP, UPF ignores the redirect URL option and forwards the packet normally. UPF supports redirection only for certain types of HTTP packets (for example, GET requests), that are only sent in the uplink direction. When a URL redirection occurs, UPF allows appending the dynamic fields to the redirected URL.

UPF supports the following dynamic fields for URL redirection:

- #ACSMGR_BEARER_CALLED_STATION_ID#
- #BEARER.IMSI#
- #BEARER.MSISDN#
- #HTTP.HOST#
- #HTTP.URL#
- #HTTP.URI#
- #RTSP.URI#
- #RULEBASE#

URL Encryption

Table 35: Feature History

Feature Name	Release Information	Description
Redirect URL Encryption	2024.01	UPF supports the URL encryption of the dynamic fields using the Blowfish and AES encryption methods. Default Setting: Disabled – Configuration Required

The redirect URL consists of the URL address with one or more dynamic fields. These dynamic fields can be encrypted using the Blowfish 128-bit or AES 256-bit encryption methods.

UPF supports encryption of the following dynamic fields:

- #BEARER.MSISDN#
- #BEARER.IMSI#

UPF supports the following encryption methods to encrypt the dynamic fields:

- **Blowfish Encryption**—A symmetric block cipher that accommodates a variable-length key ranging from 32 to 448 bits. UPF uses single 128-bit key encryption for both encrypting and decrypting data.
- **AES Encryption**—A symmetric block cipher with encryption key of sizes 128, 192, and 256 bits. UPF uses Advanced Encryption Standard (AES) with Cipher Block Chaining (CBC) mode and 256-bit keys for encryption.

For AES encryption with CBC mode, a key phrase is taken as a configurable field from the operator. This key phrase is internally converted to a 256-bit key. UPF uses a hardcoded value of 10 rounds of 256-bit keys for AES encryption.

Configuring URL Encryption

To enable encryption of the dynamic fields in the redirected URL, use the following sample configuration:

```

configure
  active-charging service service_name
    charging-action charging_action_name
      flow action redirect-url redirect_url [ encryption { blowfish128 |
aes256 } [ encrypted ] key key ]
    end

```

NOTES:

- **flow action redirect-url** *redirect_url*—Specify the redirect URL. It can include up to 16 dynamic fields. *redirect_url* must be an alphanumeric string of 1 through 511 characters.
- **encryption { blowfish128 | aes256 }** [**encrypted**] **key** *key*—Specify to enable encryption for dynamic fields of the redirect URL.
 - **blowfish128**—Specify to use Blowfish encryption with 128-bit key for encrypting the dynamic fields.
 - **aes256**—Specify to use AES-CBC encryption with 256-bit key for encrypting the dynamic fields.
 - **encrypted**—Specify to encrypt the key.
 - **key** *key*—Specify the key to use for encryption of dynamic fields. *key* must be an alphanumeric string of 1 through 523 characters.
- If encoding is enabled in the URL to be redirected, the encrypted URL supports up to 2300 characters. If the length exceeds, then the URL will be truncated at 2300 characters.

HTTPS

The UPF supports HTTPS protocol as part of L7 Analyzer.

RTP/RTSP

The UPF supports RTP and RTSP protocols as part of L7 Analyzer.

SIP

Session Initiation Protocol is an IETF-defined signaling protocol widely used for controlling communication sessions such as voice and video calls over Internet Protocol (IP). The protocol can be used for creating, modifying and terminating two-party (unicast) or multiparty (multicast) sessions. Sessions may consist of one or several media streams.

The UPF supports SIP as part of L7 Analyzer.

Monitoring and Troubleshooting

This section provides information regarding the CLI command available in support of monitoring and troubleshooting the feature.

Show Command(s) and/or Outputs

This section provides information regarding show commands and/or their outputs in support of this feature.

DNS

Use the following CLI command to get statistics related to DNS:

```
show user-plane-service statistics analyzer name dns
```

FTP

Use the following CLI command to get statistics related to FTP:

```
show user-plane-service statistics analyzer name ftp
```

HTTP

Use the following CLI command to get statistics related to HTTP:

```
show user-plane-service statistics analyzer name http
```

HTTPS

Use the following CLI command to get statistics related to HTTPS:

```
show user-plane-service statistics analyzer name secure-http
```

RTP

Use the following CLI command to get statistics related to RTP:

```
show user-plane-service statistics analyzer name rtp
```

RTSP

Use the following CLI commands to get statistics related to RTSP:

- `show user-plane-service statistics analyzer name rtsp`

- `show user-plane-service statistics analyzer name rtsp verbose`

SIP

Use the following CLI command to get statistics related to SIP:

```
show user-plane-service statistics analyzer name sip
```

NAT Support on N4

Table 36: Feature History

Feature Name	Release Information	Description
NAT Support on the N4 interface	2023.04	The Network Address Translation (NAT) feature translates non-routable private IP addresses to routable public IP addresses from a pool of public IP addresses. UPF supports NAT on the N4 interface to configure network addresses and send NAT binding records to N4. The NAT policy and IP pool for NAT public IP addresses are configured on UPF for N4.

Feature Description

The Network Address Translation (NAT) feature translates non-routable private IP address(es) to routable public IP address(es) from a pool of public IP addresses. This feature enables the user to conserve on the number of public IP addresses required to communicate with external networks. This feature also ensures security as the IP address scheme for the internal network is masked from external hosts, and each outgoing and incoming packet goes through the translation process.

UPF supports NAT on the N4 interface to configure network addresses. The system is configured to automatically forward data packets encapsulating the source IP or source port address of the UE with NAT IP address and NAT port.

The supported NAT combinations include:

- NAT44 On Demand Many to One
- NAT44 On Demand One to One
- NAT64 On Demand Many to One
- NAT 64 On Demand One to One
- NAT44 Not On Demand Many to One
- NAT44 Not On Demand One to One
- NAT64 Not On Demand Many to One

- NAT64 Not On Demand One to One

For supplemental information about NAT, see the *StarOS NAT Administration Guide*.

NOTE: Not all features and/or functionality that are mentioned in the *StarOS NAT Administration Guide* are applicable to UPF.

Limitations

NAT support on the N4 interface has the following limitations:

- Supports only NAT44 with many-to-one and on-demand modes.
- All NAT pools are configured at respective User Plane in the destination context.
- Does not support charging action with CLI action deny in fw-and-nat policy and flow-any-error charging action in active-charging-service.
- Does not support access-rules which are configured with "dynamic-only" and "static-and-dynamic" rules from external servers.
- Does not support multiple IPs from the same realm.
- Does not support the next hop forwarding in NAT pool.
- Does not support the port range in NAT pool.
- Does not support the skip private IP check CLI.
- Does not support RADIUS and Gy returned Fw-and-nat policy-based applying NAT policy.
- Does not support the bearer-specific filters in access-ruledefs.
- Access-rules do not support trigger open-port port range configuration in fw-and-nat policy.
- Does not support the NAT port recovery (fw-and-nat action) after SR/ICSR.
- Does not support the NAT reassembly timeout CLI in active-charging service. The generic context-level CLI on UP must be used instead.
- Does not support the NAT fragmentation reassembly failure.
- Does not support the NAT flow-mapping timer.
- For N:M redundancy, the NAT IP pools to be configured from RCM done as part of interface configuration for each UP host and the pool name must be unique across all active user planes. It is mandatory to use NAT groups for all pools so that the same NAT realm referred in fw-and-nat policy can be applicable to all user planes.
- In N:M redundancy, the total number of NAT IP pools collectively configured on all UPs through RCM must be as per the maximum limit (2000) of IP pools. The configuration in standby User Plane fails if the cumulative total of all active UPs exceeds the maximum value.

Configuring NAT

The NAT policy (Firewall-and-NAT policy) and access-ruledef configurations are made under active-charging service in UPF.

For information on NAT-related CLI commands, refer to the *StarOS NAT Administration Guide > NAT Configuration* chapter.



Note Not all CLI commands and configurations mentioned in the *StarOS NAT Administration Guide > NAT Configuration* chapter are applicable to UPF.

Sample Configurations

User Plane

The following pool-related configuration is required at User Plane in ISP context.

```
configure
  context ISP1-UP
    ip pool NAT44_PUBLIC1 209.165.200.225 255.255.255.224 napt-users-per-ip-address 2
  on-demand port-chunk-size 16 max-chunks-per-user 4 group-name NAT44_GRP1
    ip pool NAT44_PUBLIC2 209.165.200.226 255.255.255.224 napt-users-per-ip-address 2
  on-demand port-chunk-size 16 max-chunks-per-user 4 group-name NAT44_GRP1
    ip pool NAT44_PUBLIC3 209.165.200.227 255.255.255.224 napt-users-per-ip-address 2
  on-demand port-chunk-size 8 max-chunks-per-user 1 group-name NAT44_GRP2
    ip pool NAT44_PUBLIC4 209.165.200.228 255.255.255.224 napt-users-per-ip-address 4
  on-demand port-chunk-size 32256 max-chunks-per-user 4 group-name NAT44_GRP2
    ip pool NAT44_PUBLIC5 209.165.200.229 255.255.255.224 napt-users-per-ip-address 8064
  on-demand port-chunk-size 8 max-chunks-per-user 2
end
```

Sample NAT Pool Related Configuration for Different NAT Pool Types

```
1-1 on-demand:
-----
config
context ISP1-UP
ip pool NAT44_ipv4_1_1 209.165.200.230 255.255.255.224 nat-one-to-one on-demand
nat-binding-timer 60
end

N-1 Not-on-demand:
-----
config
context ISP1-UP
ip pool NAT44_ipv4_N_1 209.165.200.231 255.255.255.224 napt-users-per-ip-address 2
max-chunks-per-user 2 port-chunk-size 8
end

1-1 Not-on-demand:
-----
config
context ISP1-UP
ip pool NAT44_ipv4_NOD_1_1 209.165.200.232 255.255.255.224 nat-one-to-one
end
```



Note In Control Plane configuration needs to be added along with one or more access ruledef mapped to any of the required NAT Pool/Group configured in User Plane. For more information, see *Ultra Packet Core CUPS Control Plane Administration Guide*.

Monitoring and Troubleshooting

Gathering NAT Statistics

The following table lists the commands that can be used to gather NAT statistics.

The first column lists the statistics to gather and the second column lists the command to use.

Statistics/Information	Show Command
Information for all current subscribers who have either active or dormant sessions. Checks IP address associated with subscriber. Also displays all the IP addresses that are in use in a NAT realm.	show subscribers user-plane-only full all
Information on NAT subsystem statistics.	show user-plane-service statistics all
All NAT-related statistics.	show user-plane-service statistics nat all
All NAT Realm-related statistics.	show user-plane-service statistics nat nat-realm all
Statistics of all NAT IP pools in a NAT IP pool group.	show user-plane-service statistics nat nat-realm <i>pool_name</i>
Information on NAT bind records generated.	show user-plane-service edr-format statistics all
Verifying association of fw-and-nat policy in APN on UP.	show user-plane-service pdn-instance name <i>name</i>
Verifying configuration of fw-an-nat policy on UP.	show user-plane-service fw-and-nat policy all
Information on NAT bind records generated for port chunk allocation and release.	show user-plane-service rulebase name <i>name</i>
Information on access ruledef.	show user-plane-service ruledef all
Verifying association of fw-and-nat policy in rulebase on UP.	show user-plane-service rulebase name <i>name</i>

Clear Commands

The following clear CLI commands are available in support of this feature:

- **clear user-plane-service statistics nat nat-realm all**
- **clear user-plane-service statistics nat all**

SNMP Traps for NAT Parameter Thresholds

The following SNMP traps for NAT parameter thresholds are supported.

SNMP Traps	Description
ThreshNATPortChunks	Generated when NAT port chunk usage reaches configured threshold limit
ThreshClearNATPortChunks	Generated when NAT port chunk usage reaches configured clear threshold limit.

SNMP Traps	Description
ThreshNATPktDrop	Generated when NAT packet drop reaches configured threshold limit.
ThreshClearNATPktDrop	Generated when NAT packet drop reaches configured clear threshold limit.
ThreshIPPoolUsed	Generated when the number of IPs used in the IP Pool reaches configured threshold limit.
ThreshClearIPPoolUsed	Generated when the number of IPs used in the IP Pool reaches configured clear threshold limit.
ThreshIPPoolFree	Generated when IP pool is free and threshold limit reached.
ThreshClearIPPoolFree	Generated when IP pool is used, and clear threshold limit reached.
ThreshIPPoolAvail	Generated when IP pool is available for next flow and configured threshold reached.
ThreshClearIPPoolAvail	Generated when IP pool is used, and configured threshold is reached.

NOTE: The respective CLIs must be configured in the User Plane to enable these traps.

Bulk Statistics

NAT-realm Schema

The NAT realms are configured in User Plane and statistics are stored per-context per-realm. These statistic variables, both cumulative and snapshot, are available in the nat-realm schema.

Table 37: NAT-realm Schema

Variable Name	Data Type	Counter Type	Description
Vpnname	String	Info	Context name.
Realmname	String	Info	Realm name.
nat-rlm-bind-updates	Int64	Counter	Total interim AAA NBU sent.
nat-rlm-bytes-txferred	Int64	Counter	Total number of NAT44 and NAT64 bytes transferred by realm (uplink + downlink).
nat-rlm-bytes-nat44-tx	Int64	Counter	Total number of NAT44 bytes transferred by realm.
nat-rlm-bytes-nat64-tx	Int64	Counter	Total number of NAT64 bytes transferred by realm.
nat-rlm-ip-flows	Int64	Counter	Total number of NAT44 and NAT64 flows used by the realm.

Variable Name	Data Type	Counter Type	Description
nat-rlm-nat44-flows	Int64	Counter	Total number of NAT44 flows processed by realm.
nat-rlm-nat64-flows	Int64	Counter	Total number of NAT64 flows processed by realm.
nat-rlm-ip-denied	Int32	Counter	Total number of NAT44 and NAT64 flows denied NAT IP address.
nat-rlm-ip-denied-nat44	Int64	Counter	Total number of NAT44 flows denied IP.
nat-rlm-ip-denied-nat64	Int64	Counter	Total number of NAT64 flows denied IP.
nat-rlm-port-denied	Int32	Counter	Total number of NAT44 and NAT64 flows denied ports.
nat-rlm-port-denied-nat44	Int64	Counter	Total number of NAT44 flows denied ports.
nat-rlm-port-denied-nat64	Int64	Counter	Total number of NAT64 flows denied ports.
nat-rlm-memory-denied	Int64	Counter	Total number of NAT44 and NAT64 flows denied memory.
nat-rlm-memory-denied-nat44	Int64	Counter	Total number of NAT44 flows denied memory.
nat-rlm-memory-denied-nat64	Int64	Counter	Total number of NAT64 flows denied memory.
nat-rlm-ttl-ips	Int32	Gauge	Total number of NAT public IP addresses, per context per NAT realm. Is a static value.
nat-rlm-ips-in-use	Int32	Gauge	Total number of NAT IP addresses currently in use, per context per NAT realm.
nat-rlm-current-users	Int32	Gauge	Total number of subscribers currently using the NAT realm.
nat-rlm-ttl-port-chunks	Int32	Gauge	Total number port-chunks, per context per NAT realm. Is a static value.
nat-rlm-chunks-in-use	Int32	Gauge	Total number of port-chunks currently in use, per context per NAT realm.
nat-rlm-port-chunk-size	Int32	Gauge	Size of the port chunk in the NAT realm.
nat-rlm-port-chunk-average-usage-tcp	Int32	Gauge	Average TCP port usage in the allocated TCP ports, i.e. out of allocated TCP ports how many got used. Not percentage value.

Variable Name	Data Type	Counter Type	Description
nat-rlm-port-chunk-average-usage-udp	Int32	Gauge	Average UDP port usage in the allocated UDP ports, i.e. out of allocated UDP ports how many got used. Not percentage value.
nat-rlm-port-chunk-average-usage-others	Int32	Gauge	Average other (ICMP or GRE) port usage in the allocated other ports, i.e. out of allocated 'other' ports how many got used. Not percentage value.
nat-rlm-max-port-chunk-subscribers	Int64	Counter	Total number of subscribers who used maximum number of port chunks.
nat-rlm-max-port-chunk-used	Int32	Counter	Maximum port chunks used.
nat-rlm-max-cur-port-chunk-subscribers	Int64	Gauge	Current number of subscribers using maximum number of port chunks.
nat-rlm-max-cur-port-chunk-used	Int32	Gauge	Maximum port chunks used by active subscribers.

NAT Binding Records

Whenever a NAT IP address or NAT port-chunk is allocated/deallocated to/from a subscriber, NAT Binding Records (NBR) can be generated. Generation of NBRs is configurable in the Firewall-and-NAT policy configuration.

Sample NBR

```
#sn-start-time,sn-end-time,ip-protocol,ip-subscriber-ip-address,ip-server-ip-address,sn-subscriber-port,
sn-server-port,sn-nat-ip,sn-nat-port-block-start,sn-nat-port-block-end,sn-subscriber-nat-flow-ip,sn-subscriber-nat-flow-port,
sn-nat-realm-name,sn-nat-subscribers-per-ip-address,sn-nat-binding-timer,sn-nat-gmt-offset,sn-nat-port-chunk-alloc-dealloc-flag,
sn-nat-port-chunk-alloc-time-gmt,sn-nat-port-chunk-dealloc-time-gmt,sn-nat-no-port-packet-dropped,sn-closure-reason
,,,209.165.200.225,,,,,209.165.201.1,1024,1039,,,NAT44_PUBLIC2,2,60,+0530,1,02/18/2020
06:41:08,,,
,,,209.165.200.225,,,,,209.165.201.2,1024,1031,,,NAT44_PUBLIC5,8064,60,+0530,1,02/18/2020
06:41:14,,,
,,,209.165.200.225,,,,,209.165.201.3,1024,1039,,,NAT44_PUBLIC2,2,60,+0530,0,02/18/2020
06:41:08,02/18/2020 06:42:12,,
,,,209.165.200.225,,,,,209.165.201.14,1024,1031,,,NAT44_PUBLIC5,8064,60,+0530,0,02/18/2020
06:41:14,02/18/2020 06:44:24,,
```

EDRs

The following NAT-specific attributes are supported in regular EDRs:

- sn-nat-subscribers-per-ip-address: Subscriber(s) per NAT IP address
- sn-subscriber-nat-flow-ip: NAT IP address of NAT-enabled subscribers
- sn-subscriber-nat-flow-port: NAT port number of NAT-enabled subscribers

Sample EDR

```
#sn-start-time,sn-end-time,ip-protocol,ip-subscriber-ip-address,ip-server-ip-address,sn-subscriber-port,sn-server-port,
```

```
sn-nat-ip,sn-nat-port-block-start,sn-nat-port-block-end,sn-subscriber-nat-flow-ip,sn-subscriber-nat-flow-port,sn-nat-realm-name,
sn-nat-subscribers-per-ip-address,sn-nat-binding-timer,sn-nat-gtt-offset,sn-nat-port-chunk-alloc-dealloc-flag,sn-nat-port-chunk-alloc-time-gtt,
sn-nat-port-chunk-dealloc-time-gmt,sn-nat-no-port-packet-dropped,sn-closure-reason
02/18/2020 12:11:11:630,02/18/2020
12:11:11:632,1,209.165.200.225,209.165.201.1,0,0,,,,,209.165.200.230,1024,,2,,,,,0,0
02/18/2020 12:11:08:672,02/18/2020
12:11:09:671,6,209.165.200.225,209.165.201.1,1001,3000,,,,,209.165.200.230,1034,,2,,,,,0,0
02/18/2020 12:11:14:499,02/18/2020
12:11:14:499,17,209.165.200.225,209.165.201.1,1001,3000,,,,,209.165.200.240,1025,,8064,,,,,0,0
```

Packet Drop EDR

Sample Packet Drop EDR

```
#sn-nat-no-port-packet-dropped,sn-start-time,sn-end-time,sn-subscriber-imsi
2,03/13/2020 08:28:24,03/13/2020 08:28:54,123456789012345
```

Tethering Detection

Feature Description

Tethering refers to the use of a mobile smartphone as a USB dongle or modem to provide Internet connectivity to PC devices (laptops, PDAs, tablets, and so on) running on the smartphone's data plan. Typically, for smartphone users, most operators have in place an unlimited data plan, the usage of which is intended to be from the smartphone as a mobile device. However, some subscribers use the low cost or unlimited usage data plan to provide Internet connectivity to their laptops in places where normal Internet connection through broadband or Wi-Fi may be costly, unavailable, or insecure.

The Tethering Detection feature enables detection of subscriber data traffic originating from PC devices tethered to mobile smartphones, and also provides effective reporting to enable service providers take business decisions on how to manage such usage and to bill subscribers accordingly. Tethering Detection is supported for IPv4 (TCP) and IPv6 traffic flows.

In this release, IP-TTL based tethering is supported. This feature is configurable at the rulebase level and is applicable on all flows for all subscribers having IP-TTL configuration within the rulebase.

Configuring Tethering Support

This section describes how to configure the Tethering Support feature.

Configuring the Tethering Support feature involves the following steps:

- Rulebase Configuration for Tethering
- Ruledef Configuration for Tethering
- EDR Configuration for Tethering

Rulebase Configuration for Tethering

Use the following commands to configure the rulebase parameters for tethering.

```
configure
  active-charging service service_name
  rulebase rulebase_name
```

```
tethering-detection ip-ttl value t1_value
end
```

NOTES:

- **tethering-detection**: This command allows you to enable/disable the Tethering Detection feature for the current rulebase, and specifies the database to use.
- **ip-ttl value *t1_value***: Specifies to perform tethering detection using IP-TTL configuration. *t1_value* must be an integer from 1 through 255 to configure TTL values for tethered flows.

Ruledef Configuration for Tethering

Use the following commands to configure ruledef parameters for tethering.

configure

```
active-charging service service_name
  ruledef ruledef_name
    ip any-match operator_condition
    tethering-detection ip-ttl flow-tethered
  end
```

NOTES:

- **ip any-match *operator_condition***: This command allows you to define rule expressions to match all IPv4/IPv6 packets.
- **ip-ttl**: Specifies to select flows that were tethered or non-tethered as per IP-TTL values.
- **flow-tethered**: Specifies to match if tethering is detected on flow.

EDR Configuration for Tethering

Use the following commands to configure EDR for tethering:

configure

```
active-charging service service_name
  edr-format format_name
    rule-variable flow tethered-ip-ttl priority priority_value
    rule-variable flow ttl priority priority_value
  end
```

NOTES:

- **edr-format *format_name***: configures EDR formats.
- **flow**: Configures the flow related fields in an EDR.
- **tethered-ip-ttl**: IP-TTL based tethering detected on flow.
- **ttl**: Time To Live/Max hops value received in the first packet of the flow.

Monitoring and Troubleshooting

This section provides information regarding the CLI command available in support of monitoring and troubleshooting the feature.

Show Command(s) and/or Outputs

This section provides information regarding show commands and/or their outputs in support of this feature.

show user-plane-service statistics tethering-detection

The following fields are displayed in support of this feature:

- Current Tethered Subscribers
- Total Tethered Subscribers
- Total flows scanned
- Total Tethered flows detected
- Total Tethered flows recovered
- Total flows bypassed for scanning
- Tethering Detection Statistics (ip-ttl)
 - Total flows scanned
 - Tethered flows detected
 - Tethered uplink packets
 - Tethered downlink packets

show user-plane-service statistics rulebase name rulebase_name

The following fields are displayed in support of this feature:

- Tethering Detection (ip-ttl)
 - Total flows scanned
 - Tethered flows detected
 - Tethered uplink packets
 - Tethered downlink packets

RTP Dynamic Flow Detection

The **rtp dynamic-flow-detection** CLI command, under the ACS Rulebase Configuration mode, enables the Real Time Streaming Protocol (RTSP) and Session Description Protocol (SDP) analyzers to detect the child RTP and RTCP flows. If you configure the RTSP/SIP and SDP analyzers, and **rtp dynamic-flow-detection** CLI is present, then there's no need for configuring RTP/RTCP explicitly. With the **rtp dynamic-flow-detection** CLI command, the child RTP or RTCP flows get correlated to their parent RTSP/SIP-SDP flows.

Once the parent flow (RTSP/SIP-SDP) gets cleared, the child RTP/RTCP flows also gets cleared. In the absence of this CLI, the L7 layer analysis for RTP and RTCP needs a separate analyzer configuration. There's no correlation of RTP/RTCP flows to RTSP/SIP-SDP flow.

Rule-matching for Bearer-specific Filters

The Rule-matching for Bearer-specific Filters functionality includes:

- IMSI-based rules are matched as per the subscribers IMSI.
- APN-based rules allow you to define rule expressions to match Access Point Name (APN) of the bearer flow.
- RAT-Type allows you to define rule expressions to match Radio Access Technology (RAT) in the bearer flow.

Configuring IMSI Pool

Use the following CLI commands to configure the IMSI pool.

```
configure
  active-charging service service_name
    imsi-pool pool_name
      imsi { imsi_number | range start_imsi to end_imsi }
```

The imsi-pool can contain either IMSI value or range of IMSI.

Configuring Rule-line ACS Ruledef

Use the following CLI commands to configure rule-line in ACS Ruledef Configuration mode.

```
configure
  active-charging service service_name
    ruledef ruledef_name
      bearer 3gpp imsi { = imsi_value } | { range imsi-pool pool_name }
      bearer 3gpp apn operator apn_name
      bearer 3gpp rat-type operator rat_type
```

IMSI range can be configured in a rule with the help of IMSI pool.

bearer 3gpp rat-type *operator* *rat_type*:

- *operator* must be one of the following:
 - != : Does not equal
 - = : Equals
- **NOTE:** In this release, **wlan** is the qualified *rat_type*.

Configuring HTTP Content-Type

Use the following CLI commands to define rule expressions to match value in HTTP Content-Type entity-header field.

```
configure
  active-charging service service_name
    ruledef ruledef_name
      http content type [ case-sensitive ] operator content_type
```

Show CLIs

Use the following CLI on UPF to see information about IMSI pool that is configured in a service: **show user-plane-service imsi-pool name *pool_name***

URL Blockedlisting

Feature Description

The URL blockedlisting feature regulates the subscriber's access to view or download content from websites whose URL or URI has been blockedlisted. It uses a database that records a list of URLs that indicates if the detected URL is categorized to be blocked or not.

How it Works

To enable the URL blockedlisting feature on UPF, URL blockedlisting database should be present with a name "optblk.bin" under flash, or SFTP or under its subdirectory. This database directory path must be configured on user-plane, after user-plane services are brought up.

HTTP Analyzer must be enabled for URL blockedlisting. The HTTP analyzer extracts URL information from the incoming HTTP request data packet. Extracted URL content is compared with the URL Blockedlisting database. When the URL of incoming HTTP data packet matches with the database URL entry, that URL is treated as blockedlisted URL and one of the following actions takes place on that HTTP packet:

- Termination of flow
- Packet is discarded

The URL blockedlisting configurations must be configured under Rulebase configuration in Active Charging Service. Also, two URL blockedlisting methods – Exact and Generic, are supported at Active Charging Service-level configuration.



Important Blockedlisting database(s) are provided by – Internet Watch Foundation (IWF) and National Center for Missing and Exploited Children (NCMEC). The UPF always receives the blockedlisting database in Optimized Format.

URL Blockedlisting Database Upgrade

URL database upgrade is supported in following two ways:

- Timer-based upgrade or Auto upgrade
- CLI-based upgrade or Manual upgrade

Timer-based or Auto-upgrade

After the database is loaded on the chassis for the first time, a timer, for a duration of 5 minutes, is started. This process is started to auto upgrade the database.

If at the expiry of the timer, a valid database with higher version is available at the directory path, then database upgrade procedure is initiated, and a newer version of the database is loaded on the UPF.

To upgrade a URL blockedlisting database, a higher version of valid URL Blockedlisting database with name “optblk_f.bin” should be present at same directory as that of current database “optblk.bin”.

After the database is upgraded successfully, the earlier “optblk.bin” file gets renamed as “optblk_0.bin” and “optblk_f.bin” file gets renamed as “optblk.bin”. Here, “optblk_0.bin” file is treated as a backup file of older database.

If an additional upgrade is performed, then “optblk_0.bin” file will be renamed as “optblk_1.bin” file and current “optblk.bin” will get renamed as “optblk_0.bin”, and so on.

See the *Loading URL Blockedlisting Database on UPF* section to configure the number of backup files to be stored in the database.

CLI-based or Manual Upgrade

See the *Upgrading the URL Blockedlisting Database* section to upgrade the current database to a newer version.

Configuring URL Blockedlisting

Loading URL Blockedlisting Database on UPF

Use the following configuration to load URL blockedlisting database on UPF.

In releases prior to 2022.01.0:

configure

```
url-blacklisting database directory path database_directory_path
url-blacklisting database max-versions max_version_value
end
```

From 2022.01.0 and later releases:

configure

```
url-blockedlisting database directory path database_directory_path
url-blockedlisting database max-versions max_version_value
end
```

NOTES:

- **database directory path:** Configures the database directory path.
The *database_directory_path* is a string of size 1 to 255.
- **max-versions:** Configures the maximum database upgrade versions.
The *max_version_value* is an integer from 0 to 3.

Upgrading the URL Blockedlisting Database

Use this configuration to manually upgrade the URL blockedlisting database.

In releases prior to 2022.01.0:

```
upgrade url-blacklisting database
end
```

From 2022.01.0 and later releases:

```
upgrade url-blockedlisting database
end
```

Configuration to Enable URL Blockedlisting

Use the following configuration to enable URL blockedlisting feature on UPF.

In releases prior to 2022.01.0:

```
configure
  active-charging service service_name
    url-blacklisting match-method [ exact | generic ]
    rulebase rulebase_name
      url-blacklisting action [ discard | terminate-flow ]
    end
```

From 2022.01.0 and later releases:

```
configure
  active-charging service service_name
    url-blockedlisting match-method [ exact | generic ]
    rulebase rulebase_name
      url-blockedlisting action [ discard | terminate-flow ]
    end
```

NOTES:

- **match-method [exact | generic]**: Specifies the match method used for URL blockedlisting.
 - **exact**: URL Blockedlisting perform an exact-match of URL.
 - **generic**: URL Blockedlisting perform generic-match of URL.
- **url-blockedlisting action [discard | terminate-flow]**:
 - **discard**: Discards the HTTP packet received.
 - **terminate-flow**: Terminates the flow of the HTTP packet received.

Monitoring and Troubleshooting

This section provides information regarding the CLI command available in support of monitoring and troubleshooting the feature.

Show Command(s) and/or Outputs

This section provides information regarding show commands and/or their outputs in support of this feature.

```
show user-plane-service url-blacklisting database
```

The following fields are displayed in support of this feature:

- URL Blacklisting Static Rating Databases:
 - Last Upgrade Status
 - Path

- Database Status
- Number of URLs in DB
- Type
- Version
- Creation Time
- Hostname
- Comment
- Last Access Time
- Last Modification Time
- Last Status Change Time

show user-plane-service url-blacklisting database url database_directory_path

The following fields are displayed in support of this feature:

- URL Blacklisting Static Rating Databases:
 - Last Upgrade Status
 - Path
 - Database Status
 - Number of URLs in DB
 - Type
 - Version
 - Creation Time
 - Hostname
 - Comment
 - Last Access Time
 - Last Modification Time
 - Last Status Change Time

show user-plane-service url-blacklisting database facility sessmgr all

The following fields are displayed in support of this feature:

- URL-Blacklisting SessMgr Instance Based Database Configuration
 - SessMgr Instance
 - BL DB Load Status

show user-plane-service rulebase name rulebase_name

- BL DB Version
- Number of URLs
- Checksum

show user-plane-service rulebase name rulebase_name

The following fields are displayed in support of this feature:

- URL-Blacklisting Action
- URL-Blacklisting Content ID

show user-plane-service inline-services info

The following fields are displayed in support of this feature:

- URL-Blacklisting: Enabled
 - URL-Blacklisting Match-method: Generic

show user-plane-service inline-services url-blockedlisting statistics

The following are displayed in support of this feature:

- Cumulative URL-Blockedlisting Statistics
 - Blockedlisted URL hits
 - Blockedlisted URL misses
 - Total rulebases matched

show user-plane-service inline-services url-blacklisting statistics rulebase name rulebase_name

The following fields are displayed in support of this feature:

- Rulebase Name
 - URL-Blacklisting Statistics
 - Blacklisted URL hits
 - Blacklisted URL misses
- Total rulebases matched

Configuring the Static and Pre-Defined Rules

This section describes how to configure the static and pre-defined rules under the charging action configuration.

```
configure
  active-charging service service_name
```

```

charging-action charging_action_name
    flow action { discard [ downlink | uplink ] | redirect-url
redirect_url | terminate-flow }
    end

```

NOTES:

- **flow action:** Specifies the action to take on packets that match rule definitions.
 - **discard [downlink | uplink]:** Specifies to discard downlink or uplink packets.
 - **redirect-url redirect_url:** Specifies the URL to be redirected. For example, `http://search.com/subtarg=#HTTP.URL#`
 - **terminate-flow:** Specifies to terminate the flow.
- For redirect-url, configure HTTP analyzer under rulebase. Example:

```

route priority 70 ruledef http-port analyzer HTTP
    ruledef http-port
    tcp either-port = 80
    rule-application routing
    exit

```

Configuring ACS Ruledef for L7 Protocols for DPI

A ruledef represents a set of matching conditions across multiple L3 – L7 protocol based on protocol fields and state information. Each ruledef can be used across multiple rulebases within the active charging service.



Note In UPF, if rule-line addition or deletion inside a ruledef is done during active calls and data flows, then this configuration change is not applied for current flows. However, the configuration change applies to new calls and new flows on same calls.

The following is a sample configuration that describes how to create, configure, or delete ACS rule definitions.

```

configure
    active-charging service service_name
        ruledef ruledef_name
            dns { any-match value | query-type query_type | query-name query_name
            }
            ip any-match [ = | != ] [ TRUE | FALSE ]
            ip dst-address { operator { { ipv4_address | ipv6_address } | {
ipv4_address/mask | ipv6_address/mask } | address-group ipv6_address } | { !range |
range } host-pool host_pool_name }
            ip server-ip-address { operator { { ipv4_address | ipv6_address } | {
ipv4_address/mask | ipv6_address/mask } | address-group ipv6_address } | { !range |
range } host-pool host_pool_name }
            multi-line-or all-lines
            rule-application { charging | post-processing | routing }

```

```

{ tcp | udp } { either-port port_number }
end

```

NOTES:

- **ruledef** *ruledef_name*: Specifies the ruledef to add, configure, or delete. *ruledef_name* must be the name of an ACS ruledef, and must be an alphanumeric string of 1 to 63 characters, and can contain punctuation characters. Each ruledef must have a unique name. Host pool, port map, IMSI pool, and firewall, routing, and charging ruledefs must have unique names.
- If the named ruledef does not exist, it is created, and the CLI mode changes to the ACS Ruledef Configuration Mode wherein the ruledef can be configured.
- If the named ruledef already exists, the CLI mode changes to the ACS Ruledef Configuration Mode for that ruledef. The ACS Ruledef Configuration Mode is used to create and manage rule expressions in individual rule definitions (ruledefs).
- **ip any-match** [= | !=] [TRUE | FALSE]: This command defines the rule expressions to match IPv4/IPv6 packets. The *operator* and *condition* in the command specifies the following:
 - *operator*
 - !=: Does not equal
 - <=: Equals
 - *condition*
 - FALSE
 - TRUE
- **ip dst-address** { *operator* { { *ipv4_address* | *ipv6_address* } | { *ipv4_address/mask* | *ipv6_address/mask* } } | **address-group** *ipv6_address* } | { **!range** | **range** } **host-pool** *host_pool_name* }: This command allows defining rule expressions to match IP destination address field within IP headers.
 - *ipv4_address* | *ipv6_address*: Specifies the IP address of the destination node for outgoing traffic. *ipv4_address* | *ipv6_address* must be an IP address in IPv4 dotted-decimal or IPv6 colon-separated-hexadecimal notation.
 - *ipv4_address/mask* | *ipv6_address/mask*: Specifies the IP address of the destination node for outgoing traffic. *ipv4_address/mask* | *ipv6_address/mask* must be an IP address in IPv4 dotted-decimal or IPv6 colon-separated-hexadecimal notation with subnet mask bit. The mask bit is a numeric value which corresponds to the number of bits in the subnet mask.
 - *address-group ipv6_address*: Specifies a group of IPv6 addresses configured with wildcard input and/or specialized range input. Multiple wildcard characters can be accepted as input and only one 2 byte range input will be accepted. Both wildcard character input and 2-byte range input can be configured together within a given IPv6 address.
 - **host-pool** *host_pool_name*: Specifies the name of the host pool. *host_pool_name* must be an alphanumeric string of 1 to 63 characters.
 - The *operator* in the command specifies the following:
 - !=: Does not equal
 - <: Lesser than or equals

- =: Equals
 - >=: Greater than or equals
- **multi-line-or all-lines**: This command allows a single ruledef to specify multiple URL expressions. When a ruledef is evaluated, if the multi-line-or all-lines command is configured, the logical OR operator is applied to all the rule expressions in the ruledef to decide if the ruledef matches or not. If the multi-line-or all-lines command is not configured, the logical AND operator is applied to all the rule expressions.
 - **rule-application { charging | post-processing | routing }**: This command specifies the rule application for a rule definition.
 - **charging**: Specifies that the current ruledef is for charging purposes.
 - **post-processing**: Specifies that the current ruledef is for post-processing purposes. This enables processing of packets even if the rule matching for them has been disabled.
 - **routing**: Specifies that the current ruledef is for routing purposes. Up to 256 rule definitions can be defined for routing in an Active Charging Service. Default: Disabled.
 - **dns { any-match value | query-type query_type | query-name query_name }**: This command allows you to define rule expressions to match all DNS packets, or packets based on the query type or query name.
 - **ip server-ip-address ip_address_value**: This command allows you to define rule expressions to match the IP address of the destination end of the connection.
 - **{ tcp | udp } { either-port port_number }**: This command allows you to define rule expressions to match either a destination or source port number in UDP/TCP headers.

Charging Action Configuration for L7 Protocols for DPI

This section describes how to configure charging action. The charging action represents actions to be taken when a configured rule is matched. Actions could range from generating an accounting record (for example, an EDR) to dropping the IP packet, and so on. The charging action will also determine the metering principle—whether to count retransmitted packets and which protocol field to use for billing (L3, L4, L7, and so on).

The charging action configuration is used to define the QoS and charging related parameters associated with ruledefs.

configure

```

active-charging service service_name
  charging-action charging_action
  allocation-retention-priority priority [ pci pci_value | pvi pvi_value

  billing-action egcdr
  cca charging credit [ rating-group coupon_id ] [ preemptively-request
]
  content-id content_id
  flow action { discard [ downlink | uplink ] | redirect-url
redirect_url | terminate-flow }
```

```

    flow limit-for-bandwidth { { direction { downlink | uplink }
peak-data-rate bps peak-burst-size bytes violate-action { discard |
lower-ip-precedence } [ committed-data-rate bps committed-burst-size bytes
[ exceed-action { discard | lower-ip-precedence } ] ] } | { id id } }
    nexthop-forwarding-address ipv4_address/ipv6_address
    qos-class-identifier qos_class_identifier
    service-identifier service_id
    tft packet-filter packet_filter_name
    tft-notify-ue
    tos { af11 | af12 | af13 | af21 | af22 | af23 | af31 | af32 |
af33 | af41 | af42 | af43 | be | ef | lower-bits tos_value } [ downlink |
uplink ]

```

NOTES:

- **charging-action** *charging_action_name*: Specifies the name of a charging action. *charging_action_name* must be an alphanumeric string of 1 to 63 characters and can contain punctuation characters. Each charging action must have a unique name.
- If the named charging action does not exist, it is created, and the CLI mode changes to the ACS Charging Action Configuration Mode wherein the charging action can be configured.
- If the named charging action already exists, the CLI mode changes to the ACS Charging Action Configuration Mode for that charging action.
- **allocation-retention-priority** *priority* [**pci** *pci_value* | **pvi** *pvi_value*]: Configures the Allocation Retention Priority (ARP). *priority* must be an integer value in the range of 1-15.
 - **pci** *pci_value* : **Specifies the Preemption Capability Indication (PCI) value. The options are:**
 - MAY_PREEMPT - Flow can be preempted. This is the default value.
 - NOT_PREEMPT - Flow cannot be preempted
 - **pvi** *pvi_value*: Specifies the Preemption Vulnerability Indication (PVI) value. The options are:
 - NOT_PREEMPTABLE - Flow cannot be preempted. This is the default value.
 - PREEMPTABLE - Flow can be preempted
- **billing-action**: Configures the billing action for packets that match specific rule definitions.
- **cca charging credit**: Enables or disables credit control charging credit behaviour.
- **content-id**: Configures the rating group.
- **flow action**: Specifies the action to take on packets that match rule definitions.
 - **discard** [**downlink** | **uplink**]: Specifies to discard downlink or uplink packets.
 - **redirect-url** *redirect_url*: Specifies the URL to be redirected.
 - **terminate-flow**: Specifies to terminate the flow.
- **flow limit-for-bandwidth**: Configures the QoS parameters such as MBR, GBR, and so on.
 - peakdata-rate(MBR): Default is 3000 bps

- **peakburstsize**: Default is 3000 bytes
- **committedDataRate(GBR)**: Default is 144000 bps
- **committedBurstSize**: Default is 3000 bytes
- **nexthop-forwarding-address** *ipv4_address/ipv6_address* ,: Configures the nexthop forwarding address.
- **qos-class-identifier** *qos_class_identifier* : Configures the QCI for a charging action. *qos_class_identifier* must be an integer value in the range of 1-9 or from 128-254 (Operator specific).
- **service_identifier** *service_id*: Configures the service identifier to use in generated billing records.*service_id* must be an integer value in the range of 1-2147483647.
- **tft packet-filter** *packet_filter_name*: Specifies the packet filter to add or remove from the current charging action. *packet_filter_name* must be the name of a packet filter, and must be an alphanumeric string of 1 to 63 characters.
- **tft-notify-ue**: Control the TFT updates towards the UE based on certain trigger conditions.
- **tos**: Configures the Type of Service (ToS) octets.



CHAPTER 14

Device ID in EDNS0 Records

- [Feature Summary and Revision History, on page 171](#)
- [Feature Description, on page 172](#)
- [How it Works, on page 172](#)
- [Configuring EDNS Format and Trigger Action, on page 175](#)
- [Monitoring and Troubleshooting, on page 177](#)

Feature Summary and Revision History

Summary Data

Table 38: Summary Data

Applicable Product (s) or Functional Area	5G-UPF
Applicable Platforms	VPC-SI SMI
Feature Default Setting	Disabled – Configuration Required
Related Changes in this Release	Not Applicable
Related Documentation	<i>UCC 5G UPF Configuration and Administration Guide</i>

Revision History

Table 39: Revision History

Revision Details	Release
TCP support is added.	2021.02.1
First introduced.	2021.01.2

Feature Description

The Device ID in EDNS0 offers each enterprise with a customized domain blocking through Umbrella. To enable this functionality:

- The UPF must reformat a subscriber DNS request into an EDNS0 request, and.
- The UPF must include an Umbrella “Device ID” in the EDNS0 packet so that the Umbrella DNS resolver can use the Device ID to apply the domain filter associated or configured with the Device ID in the EDNS0 packet.

Presently, the Session Management Function (SMF) receives the domain filtering policy ID from PCRF/PCF. The SMF passes the domain filtering policy ID to the User Plane Function (UPF) in the Subscriber Parameters. The UPF uses the domain filtering policy ID to apply domain filtering functionality to the subscriber.

How it Works

New CLIs are introduced to configure and trigger the EDNS0 functionality.

The EDNS0 packet receives the 64-bit device ID as OPT RR data. The first 32 bits of all device IDs is a fixed value that is configured in the UPF. The last 32 bits of a subscriber device ID is the content filter ID value received from the PCRF/PCF. The UPF concatenates the two 32-bit values to build a subscriber full 64-bit Device ID for populating in the subscriber EDNS0 queries. New CLI helps to configure the first 32 bit of static device-id value. If you don't configure the 32-bit static prefix CLI, the outgoing packet shows the device-id = 32-bit CF PolicyID.

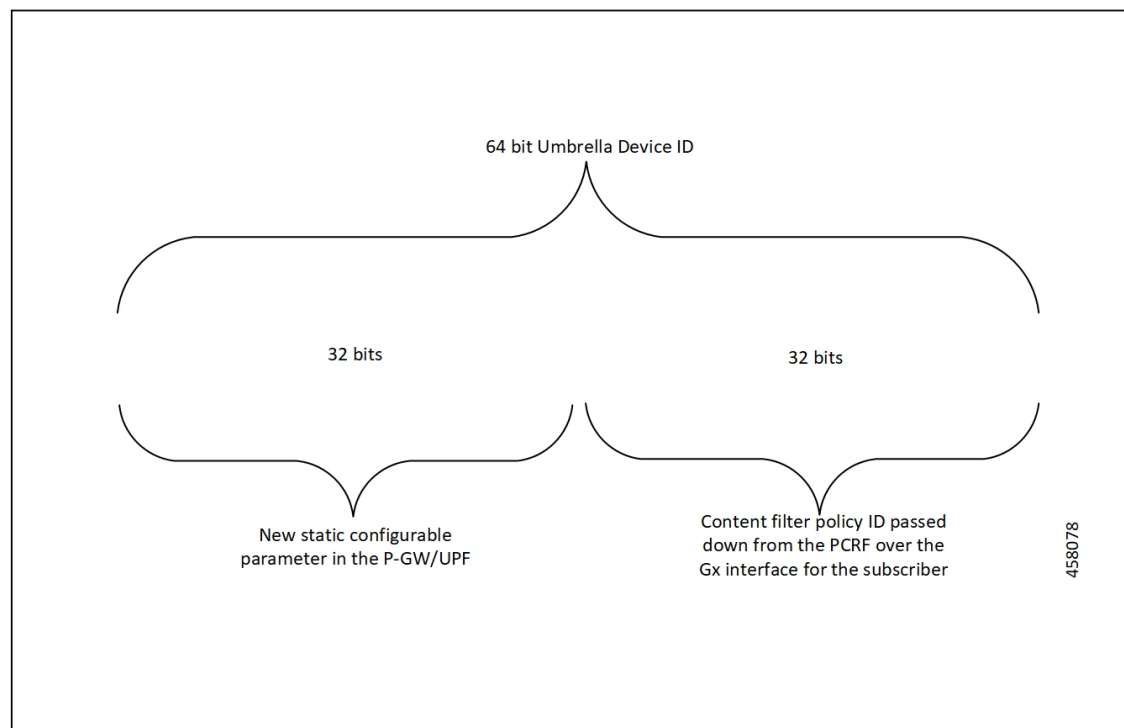

The Device ID number in the EDNS0 record allows the Umbrella DNS system to apply a custom set of domain filters for the EDNS0 queries.

Process Flow

The following process flow describes about the Content Filtering enhancement to insert Device ID in EDNS0 records:

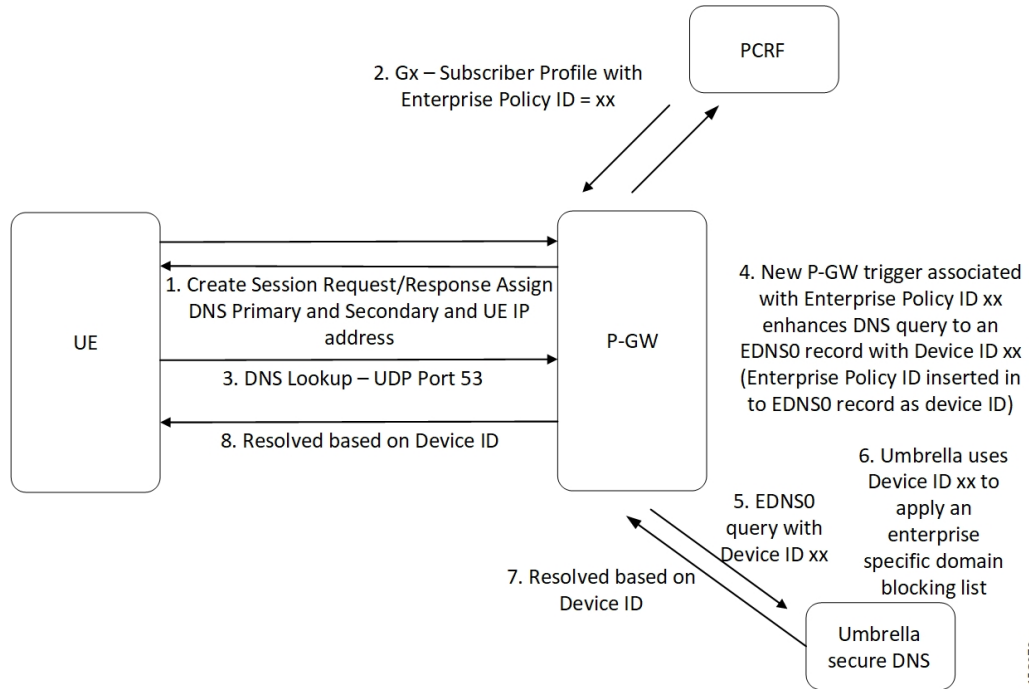

458079

EDNS0 Packet Format

The enterprise policy ID (CF_POLICY_ID) from PCRF helps to create the Device ID. The SMF sends the device ID to the UPF. Adding the Device ID to the DNS packet helps in creating the EDNS0 packet. The format of EDNS0 packets is specified by RFC2671. The following are few specifics:

- Following is the structure for the fixed part of an OPT RR:

Field Name	Field Type	Description
NAME	domain name	empty (root domain)
TYPE	u_int16_t	OPT
CLASS	u_int16_t	sender's UDP payload size
TTL	u_int32_t	extended RCODE and flags
RDLLEN	u_int16_t	describes RDATA
RDATA	octet stream	{attribute, value} pairs

- Following is the variable part of an OPT RR encoded in its RDATA:

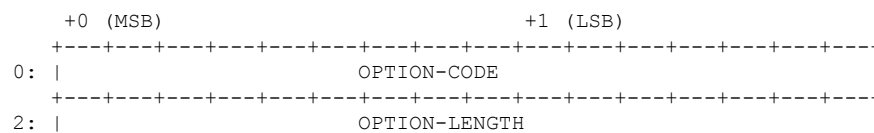

```

+-----+-----+-----+-----+-----+-----+-----+-----+-----+-----+
4: |                                           |
/                               OPTION-DATA   /
/                                           /
+-----+-----+-----+-----+-----+-----+-----+-----+-----+-----+

```

- OPTION-CODE: Assigned by IANA
- OPTION-LENGTH: Size (in octets) of OPTION-DATA
- OPTION-DATA- Varies per OPTION-CODE

Example: If received policy-id from PCF/PCRF is “1234” and static prefix configured on UPF is “5678”. 64-bits Device-ID will be “0000162e000004d2”.

- 0000162e -- 5678 (Decimal)
- 000004d2 -- 1234 (Decimal)

RDATA 69 42 00 0f 4f 70 65 6e 44 4e 53 00 00 16 2e 00 00 04 d2

- 6942 -- option-code
- 000f -- option-length
- 4f70656e444e53 -- OpenDNS (String)
- 0000162e -- 5678 (MSB)
- 000004d2 -- 1234 (LSB)

EDNS0 with IP Readdressing

The new CLI is configured within trigger action to readdress the DNS traffic to the Umbrella DNS. This CLI uses the existing readdress server list configuration from the ACS service. Readdressing of packets based on the destination IP address of the packets enables redirecting gateway traffic to configured server/port in the readdressed server list.

Behavior and Restrictions

Following are the behavior and restrictions applicable for this feature:

- Trigger Condition is evaluated at flow creation time. Any change in trigger condition in between the flow doesn't affect the existing flow but affects the new flows.
- Any change to trigger action is applicable on the same flow.
- Neither CF nor EDNS is enforced when the CF Policy ID range is defined but Service-schema is not defined, or the Trigger condition pertaining to EDNS is not configured.
- If no CF Policy ID is received from Gx, range check is not performed, and content filtering works as defined in rule base.
- Cases where the 'security-profile' CLI is not associated with the 'EDNS format' CLI in Trigger Action, the device-id in the outgoing EDNS packet is sent with only 32-bit CF Policy ID.

- DNS queries with type other than A, AAAA, CNAME, NS, PTR, SRV, TXT, NULL are not to be EDNS converted.
- CF Policy ID change over Gx in between inflow are not applicable for the current flows. The current flows continue to insert the CF Policy ID present at the time of flow creation.

Limitation

Following are the limitations for this feature:

- The feature doesn't support the EDNS response packet reformat.
- The UPF must be able to include the IMSI MSISDN tag value in the EDNS0 queries. This feature doesn't support the encrypted IMSI in EDNS0 packet. This feature also doesn't support the following configuration on the EDNS fields currently.

```

configure
  active-charging-service service_name
    edns
      fields fields_name
        tag default device-id
        tag 101 imsi encrypt
        tag 102 pgw-address
      end

```

Configuring EDNS Format and Trigger Action

Use the following configuration to enable DNS filtering:

```

configure
  active-charging-service service_name
    content-filtering range start_min_val to end_max_val

```

If the range parameter is set from 10 through 1000, any subscriber profile with a content filter policy ID from 10 through 1000 uses the standard content filtering functionality. Any subscriber profile with a content filter policy ID higher than 1000 or lower than 10 triggers the new EDNS0 functionality.

Use the following configuration to disable DNS filtering:

```

configure
  active-charging-service service_name
    no content-filtering range

```

When DNS filtering is disabled, the standard content filtering policies resume as configured or as received from the PCF.

Use the following configuration to configure the EDNS packet action and format under the active-charging service:

```

configure
  active-charging-service service_name
    trigger-condition trigger_condition_name
    external-content-filtering

```

```

    app-proto = dns
end

```

NOTES:

- **external-content-filtering**: Enables EDNS0 feature. When this flag is true along with the range criteria, EDNS0 feature is enabled. By default, this flag is disabled.
- **app-proto = dns**: Avoids the IP readdressing of the non-DNS traffic. If this CLI is enabled with `multiline-or cli`, then all DNS traffic is EDNS encoded.

The following configuration leads the trigger action to define the EDNS format to be inserted in the EDNS packet:

```

configure
  active-charging-service service_name
  trigger-action trigger_action_name
  edns-format format_name
  security-profile profile_name
  flow action readdress server-list server_list_name [ hierarchy ]
[ round-robin ] [ discard-on-failure ]
end

```

NOTES:

- **trigger-action** *trigger_action_name*: Enables you to configure the flow action CLIs in the trigger action.
- **edns-format** *format_name*: Use the EDNS format when EDNS is applied.
- **security-profile** *profile_name*: Defines the security profile configuration in the EDNS to add mapping with the Device-ID.



Note Device ID in EDNS0 Records feature supports multiple security profiles.

- **flow action readdress server-list** *server_list_name* [**hierarchy**] [**round-robin**] [**discard-on-failure**]: Associates the EDNS with IP readdressing. Use IP readdressing to readdress the packets to the configured server IPs. This CLI in trigger action supports only server list configuration. It doesn't support single-server IP or port configuration like charging action.

Use the following configuration to insert the CF policy ID in the EDNS:

```

configure
  active-charging-service service_name
  edns
  fields fields_name
  tag { val { imsi | msisdn | cf-policy-id }}
end

```

To configure the 32 MS bit, static value is provided at the EDNS level with the security profile.

```

security-profile security_profile cf-policy-id-static-prefix value

```

Use the following configuration to insert a new tag specifying the payload length:

```

tag default payload-length [ tcp | udp ] value

```

Value range: 576–4096

Sample Configuration

Following is the sample configuration for configuring the EDNS packets:

```
configure
active-charging service ACS
content-filtering range 10 to 100
ruledef dns-port
udp either-port = 53
tcp either-port = 53
multi-line-or all-lines
rule-application routing
#exit
readdress-server-list re_adr_list_ta
server 209.165.202.141
server 2001::14
server 209.165.202.142
server 2001::15
#exit
rulebase starent
route priority 20 ruledef dns-port analyzer dns
#exit
edns
security-profile sec_profile cf-policy-id-static-prefix 123456
fields test_fields
tag 26946 cf-policy-id
#exit
format test_format
fields test_fields encode
#exit
#exit
trigger-action TA1
edns format test_format security-profile sec_profile
flow action readdress server-list re_adr_list_ta hierarchy
#exit
trigger-condition TC1
external-content-filtering
app-proto = dns
#exit
service-scheme SS1
trigger flow-create
priority 1 trigger-condition TC1 trigger-action TA1
#exit
subs-class SC1
rulebase = starent
multi-line-or all-lines
#exit
subscriber-base SB1
priority 1 subs-class SC1 bind service-scheme SS1
exit
end
```

Monitoring and Troubleshooting

Following are the show commands and outputs in support of enhance content filtering support to Insert device ID in EDNS0 records.

Show Commands and Outputs

Following are the show commands and outputs that are modified in support of the enhance content filtering support to Insert device ID in EDNS0 records.

- **show user-plane-service inline-services info**

```
CF Range: Enabled <<<<
Start Value: 1 <<<<
End Value: 1000 <<<
```

- **show user-plane-service statistics analyzer name dns:** output is modified to include the “EDNS Response Received” in both “EDNS Over UDP” and “EDNS Over TCP” sections.

- **show subscribers user-plane-only full callid:** output is modified to include the following parameters in the EDNS statistics per subscriber.

- DNS-to-EDNS Uplink Pkts
- DNS-to-EDNS Uplink Bytes
- EDNS Response Received

- **show user-plane-service edns all**

```
Fields:
Fields Name: fields_1
tag 26946 cf-policy-id

Fields Name: fields_2
tag 2001 imsi
tag 2002 msisdn
tag 26946 cf-policy-id

Format:
Format Name: format_1
fields fields_1 encode

Format Name: format_2
fields fields_2 encode

Security-profile Name: high
CF Prefix Policy ID: 1234
```

Use the following show commands to view the Trigger Action statistics:

- **show user-plane-service statistics trigger-action all**

- **show user-plane-service statistics trigger-action name** *trigger_action_name*

- **show user-plane-service trigger-condition all**

```
Trigger-Condition: TC1
External-content-filtering : Enabled
App-proto : dns
Multi-line-OR All lines : Disabled
```

- **show user-plane-service trigger-action all**

```
Trigger-Action: TA1
HTTP Response Based TRM : none
HTTP Response Based Charging : none
Throttle Suppress : Disabled
```



```

Flow Recovery                : Disabled
Traffic Optimization         : Disabled
Step Up GBR                  : Disabled
Step Down GBR                : Disabled
TCP Acceleration             : Disabled
TCP Acceleration Threshold   : Disabled
Service-Chain                : none
UP-Service-Chain            : none
EDNS-Encode                  : Enabled
Flow-IP-Readdressing        : Enabled

```

Bulk Statistics

The following bulk statistics are available in support of the Device ID in EDNS0 Records feature:

SCHEMA: ECS	
Statistics	Description
ecs-dns-udp-edns-encode-succeed	The count of DNS to EDNS converted packets over UDP
ecs-dns-udp-edns-encode-failed	The count of failed DNS to EDNS conversions over UDP
ecs-dns-udp-edns-encode-response	The count of responses received for EDNS query over UDP
ecs-dns-tcp-edns-encode-succeed	The count of DNS to EDNS converted packets over TCP
ecs-dns-tcp-edns-encode-failed	The count of failed DNS to EDNS conversions over TCP
ecs-dns-tcp-edns-encode-response	The count of responses received for EDNS query over TCP



CHAPTER 15

Downlink Data Notification

- [Feature Summary and Revision History, on page 181](#)
- [Feature Description, on page 182](#)
- [How It Works, on page 182](#)
- [DDN Throttling for non-Release 10 Compliant MME, on page 191](#)
- [DDN Throttling for Release 10 Compliant MME, on page 193](#)
- [Idle Timer for SAE-GW Sessions, on page 194](#)
- [S-GW Session Idle Timeout, on page 195](#)
- [Show Commands Input and/or Outputs, on page 195](#)

Feature Summary and Revision History

Summary Data

Applicable Product(s) or Functional Area	5G-UPF
Applicable Platform(s)	VPC-SI SMI
Feature Default Setting	Disabled – Configuration Required
Related Changes in this Release	Not Applicable
Related Documentation	<i>UCC 5G UPF Configuration and Administration Guide</i>

Revision History

Revision Details	Release
First introduced.	2021.02.0

Feature Description

The Downlink Data Notification (DDN) messages with support for DDN Delay and DDN Throttling, and buffering in SAEGW when UE is in Idle State, is supported in 5G-UPF.

How It Works

This section provides an overview of how this feature works.

- Buffering is supported at SAEGW-U.
- Support of buffering starts when UE moves to IDLE state due to Release Access Bearer.
- ACTIVE to IDLE transition:
 - When the UE moves to ECM-IDLE state, since the SAEGW supports buffering capability and decides to activate buffering in SAEGW-U for the session, the SAEGW-C informs the SAEGW-U through an Sx session modification.
 - After the buffering starts, when the first downlink packet arrives on any bearer, the SAEGW-U informs the SAEGW-C. The SAEGW-U sends an Sx reporting message to the SAEGW-C, unless specified otherwise, and identifies the S5/S8 bearer on which the downlink packet is received.
 - On receiving the reporting message, the SAEGW-C decides whether to send a DDN message to the MME, as defined in 3GPP TS 23.401 [2]. The DDN notification is sent with the Sx-Usage-Report.
- IDLE to ACTIVE transition:
 - At the UE transition to ECM-CONNECTED state, the SAEGW-C updates the SAEGW-U through Sxa interface with the F-TEIDu of the eNodeB/RNC/SGSN. The buffered data packets, if any, are then forwarded to the eNodeB/RNC/SGSN by the SAEGW-U.
- If the Apply Action is BUFFER, and SGW-U recovers, the SGW-U initiates Sx Report (with DLDR Report Type) on arrival of the downlink data packet.
- In SGW-U, a timer is implemented that starts after each Sx Report (with DLDR report Type) is sent. If the Apply Action is not changed, then on timer expiry, Sx Report (with DLDR Report Type) gets initiated again.
- ARP of the bearer is included in the DDN message.
- In a multi-PDN session, if the DDN is initiated for one PDN and then data is received on another PDN, wherein the bearer has higher priority, then the DDN is initiated again with the higher priority ARP value.

Downlink Data Notification – Delay (DDN-D) Support

Under certain conditions, when UE triggers a service request, uplink and downlink data is triggered and is received at the SGW-C even before the Modify Bearer Request (MBR) is received causing unnecessary Downlink Packet Notification messages sent that increases the load in MME.

In such cases, the MME monitors the rate at which these events occur. If the rate becomes significant (as configured by the operator) and the MME's load exceeds an operator-configured value, the MME indicates "Delay Downlink Packet Notification Request" with parameter D to the Serving Gateway, where D is the requested delay given as an integer with multiples of 50 milliseconds, or zero. The S-GW then uses this delay in between receiving downlink data and sending the Downlink Data Notification message.

The Downlink Data Notifications are supported for both Collapsed and Pure-S calls.

Due to the distributed nature of the system, sessions from a particular MME are offloaded on different session managers. Therefore, all session managers are notified when a session is offloaded. Also, the functionality is designed to not allow all session managers to message the DEMUX manager.

- In DDN Delay feature, DDN delay timer support is at Session Management Function.
- When first data packet arrives, Sx/N4 Report message is initiated but DDN message is initiated from Session Management Function after the expiry of Delay timer.
- DDN Delay feature is a peer level feature and so, it is applied for all the session on that peer from where the DDN Delay value is received.
- In case a previous delay value was received from a peer and it is absent in the current message, the delay value will be considered as 0.

Session Recovery and ICSR is supported for DDNs.

5G SMF Calls

Downlink Data Notification - 5G UE

When UE turns to Idle state in the 5G call mode, SMF sends Sx_Modify_Request with FAR Apply Action set to BUFFER value. For every QFI (default/dedicated), the FAR Apply Action is set to BUFFER value.

Once the Downlink packet is received from the server, UPF sends the Sx_Report_Request with Downlink Data Notification with Rule Id (PDR Id)/QFI as per packet rulematch. UPF continues buffering packets until the packet limit reaches 5 for every FAR.

When UE is active, Sx_Modify_Request reaches UPF with FAR Apply Action set to FWD (Forward) and TEID (Tunnel Endpoint Identifier). UPF debuffers the packets and sends them to UE as FIFO. For each packet, rule match will take place after the debuffering process.

DDN Throttling Support

Too many DDN requests toward MME from SGW-C could lead to processing overload at MME. To reduce this load, MME dynamically requests SGW-C to reduce a certain percentage of DDN messages sent toward it for a given period time.

For DDN throttling, S-GW is required to drop a given percentage of DDNs over a given period of time. S-GW implements this functionality using a probabilistic algorithm at each session manager.

Whereas the conventional implementation of DDN throttling requires each session manager to share its list of pending DDNs for low-priority bearers with a central entity that would then calculate the net load of pending DDNs and then decide how many DDNs each session manager would have to drop. This implementation would require buffering of DDN messages at session manager. Also, due to distributed processing nature of

software subsystem in chassis, it would require considerable amount of messaging between the session managers and the central entity (demuxmgr in case of Boxer) at regular intervals.

Implementing a probabilistic algorithm removes the need for buffering at session manager and also messaging with demuxmgr. Accuracy of probabilistic algorithm increase with increasing low ARP priority paging load at session manager. Even with lower paging load, accuracy would be fairly close to the throttling factor provided.

For non-release 10 compliant MME, SGW_C provides option to enable throttling through the CLI.

Threshold ARP values for low-priority bearer must be configured through S-GW Service Configuration. For example, if configured ARP value is 9, any bearer with $ARP > 9$ is considered low-priority bearer. DDN throttling is enabled through this configuration. If DDN throttling is enabled through SGW service configuration, each DDN message toward MME would contain the ARP IE.

No User Connect Timer Support

- Timer is introduced when a Modify Bearer Request is not received after positive Downlink Data Notification acknowledgment.
- It is initiated at SGW-C when DDN acknowledgment is received.
- On arrival of Modify Bearer Request, SGW-C stops this timer.
- On timer expiry SGW-C informs SGW-U to drop buffered packets.

DDN Call Flows

DDN Success Scenario

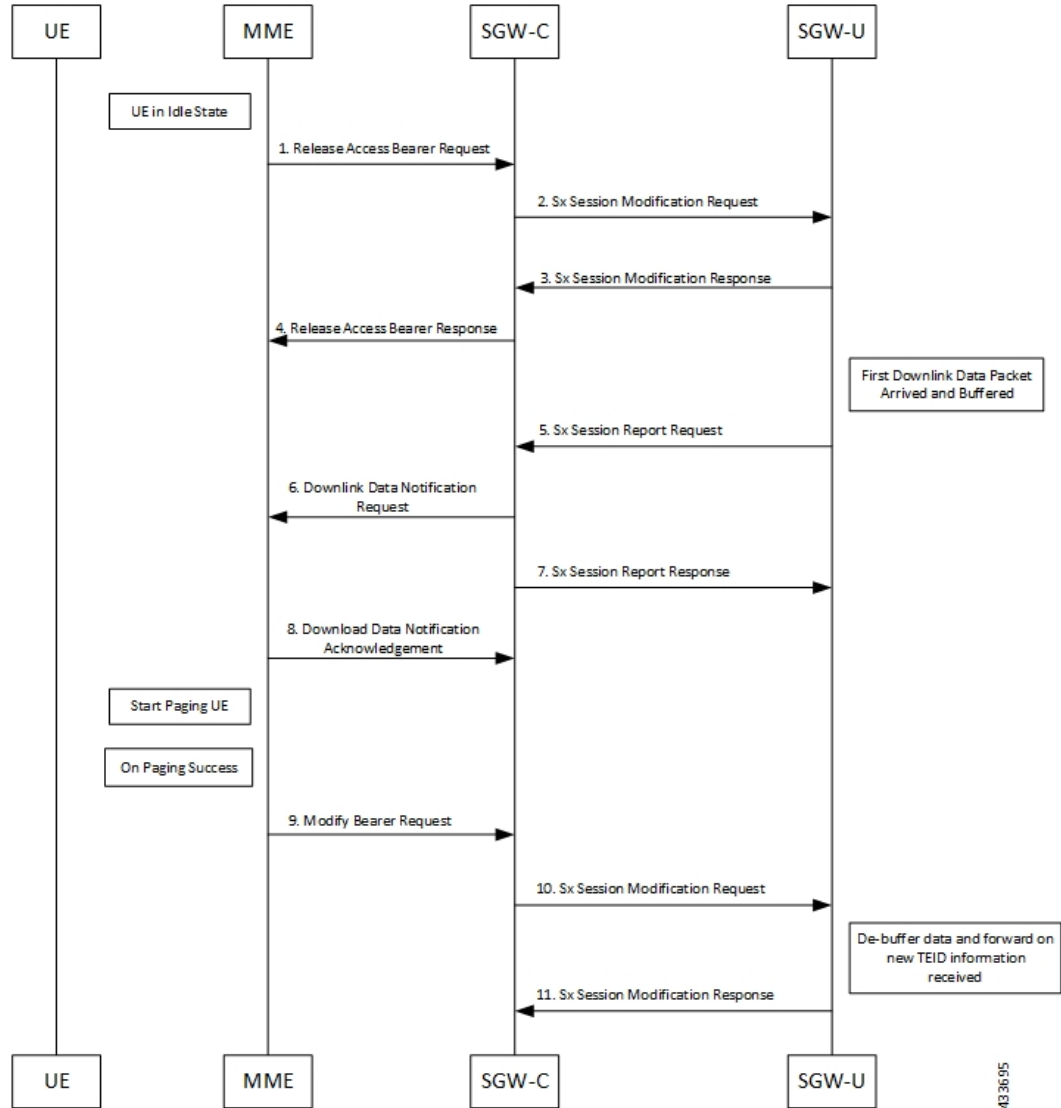

1. MME sends Release Access Bearer request to SGW-C to release downlink remote TEIDs of all the bearers for that UE.
2. On arrival of Release Access Bearer request, SGW-C informs the same to SGW-U by updating FAR with Apply Action as BUFFER in Sx Modification Request for all the PDNs.
3. SGW-U send Sx Modification response after applying Buffering in SGW-U for corresponding PDN.
4. SGW-C sends Release Access Bearer response to MME.
5. First Downlink data arriving in SGW-U triggers Sx Report Request (with Report Type as Downlink Data Report) towards SGW-C.

6. On arrival of Sx Report Request message, the SGW-C initiates Downlink Data Notification request message towards MME.
7. SGW-C sends Sx Report Response message towards SGW-U.
8. If MME is able to send a paging request towards UE, it sets the cause as “Request Accepted” in Downlink Data Notification Acknowledgment Message and sends it to SGW-C.
9. On successful paging, MME sends a Modify Bearer request to the S-GW with eNodeB TEIDs that sets up the S1-U connection at the SGW.
10. SGW-C sends Sx Modification request with updated FAR for new TEID information to SGW-U. SGW-U can now forward all the buffered data to UE through eNodeB.
11. SGW-U sends Sx Modification response to SGW-C.

DDN Failure Scenario

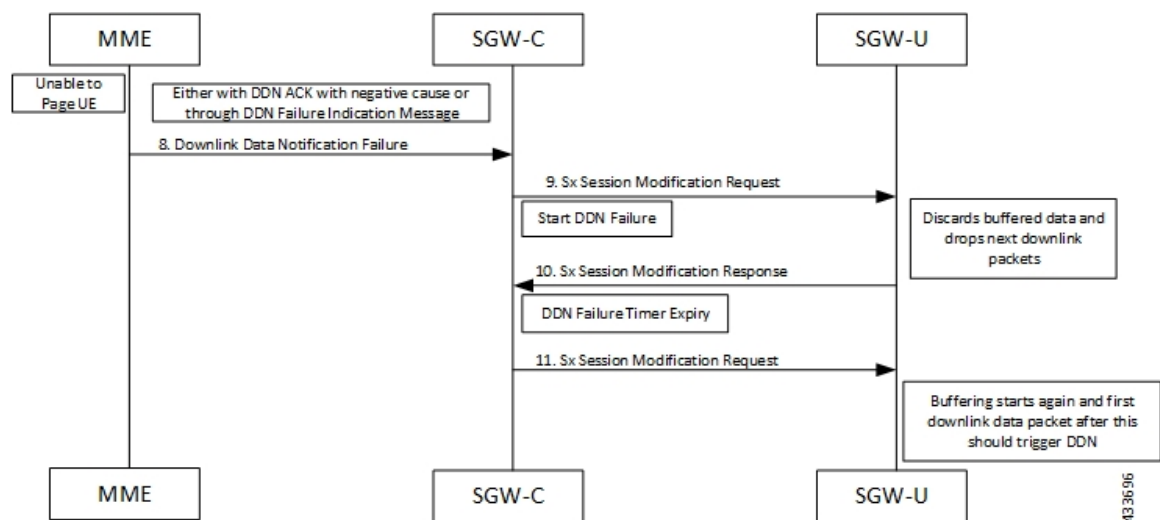

1. MME sends Release Access Bearer request to SGW-C to release downlink remote TEIDs of all the bearers for that UE.
2. On arrival of Release Access Bearer request, SGW-C informs the same to SGW-U by updating FAR with Apply Action as BUFFER in Sx Modification Request for all the PDNs.
3. SGW-U send Sx Modification response after applying Buffering in SGW-U for corresponding PDN.
4. SGW-C sends Release Access Bearer response to MME.
5. First Downlink data arriving in SGW-U triggers Sx Report Request (with Report Type as Downlink Data Report) toward SGW-C.
6. On arrival of Sx Report Request message, the SGW-C initiates Downlink Data Notification request message toward MME.
7. SGW-C sends Sx Report Response message toward SGW-U.
8. If MME is not able to page UE then it can reject Downlink Data Notification Request with relevant cause.

OR

If MME accepts Downlink Data Notification Request. But later sends Downlink Data Notification Failure indication in order to indicate SGW-C that the UE did not respond to paging.

9. SGW-C received DDN failure and hence to stop sending next DDN immediately , SGW-C starts DDN Failure Timer. SGW-C sends Sx Modification Request with DROBU flag to discard buffered packets and Apply Action as DROP to drop subsequent packets.
10. SGW-U sends Sx Modification Response to SGW-C.
11. On DDN Failure Timer Expiry SGW-C initiates Sx Modification with Apply Action as BUFFER in order to start buffering again.

Further steps are continued from Step 3 in the [DDN Success Scenario, on page 185](#) call flow.

No User Connect Timer Support

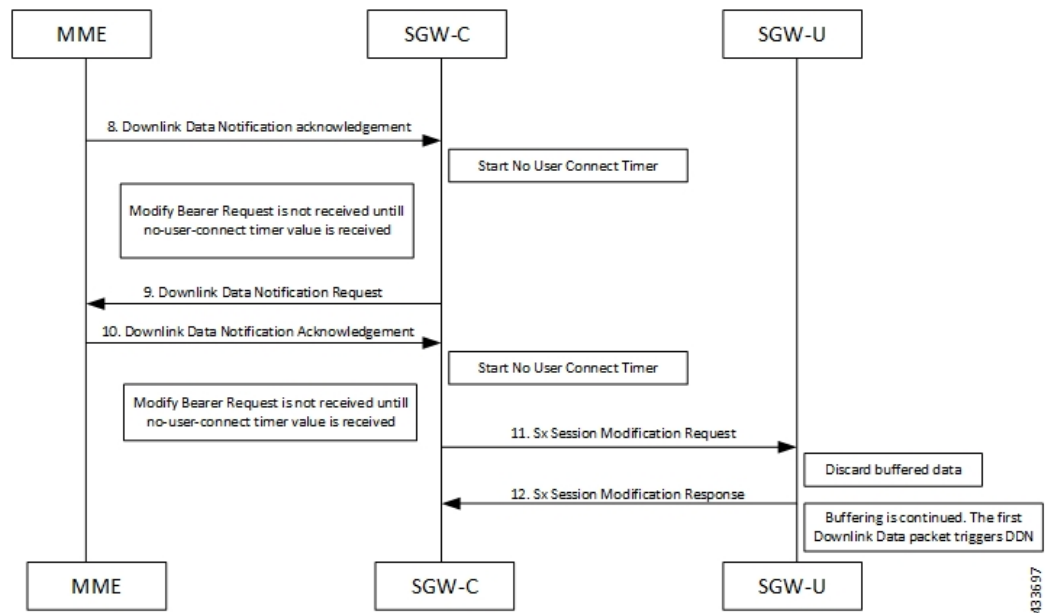

1. MME sends Release Access Bearer request to SGW-C to release downlink remote TEIDs of all the bearers for that UE.
2. On arrival of Release Access Bearer request, SGW-C informs the same to SGW-U by updating FAR with Apply Action as BUFFER in Sx Modification Request for all the PDNs.
3. SGW-U send Sx Modification response after applying Buffering in SGW-U for corresponding PDN.
4. SGW-C sends Release Access Bearer response to MME.
5. First Downlink data arriving in SGW-U triggers Sx Report Request (with Report Type as Downlink Data Report) towards SGW-C.
6. On arrival of Sx Report Request message, the SGW-C initiates Downlink Data Notification request message towards MME.
7. SGW-C sends Sx Report Response message towards SGW-U.

8. Downlink Data Notification Acknowledgment is received from MME. SGW-C starts no-user-connect timer.
9. If the Modify Bearer request with eNodeB TEID information is not received and no-user-connect timer expires, SGW-C sends Downlink Data Notification again.
10. Downlink Data Notification Acknowledgment is received from MME. SGW-C initiates the no-user-connect timer again.
11. SGW-C initiates Sx Session Modification request towards SGW-U with DROBU flag set in the message. On receiving this flag SGW-U drops the buffered data. New data will be buffered, and the subsequent first packet initiates a Sx Report message for initiating Downlink Data Notification message.
12. SGW-U sends Sx Modification Response.

DDN Delay Timer

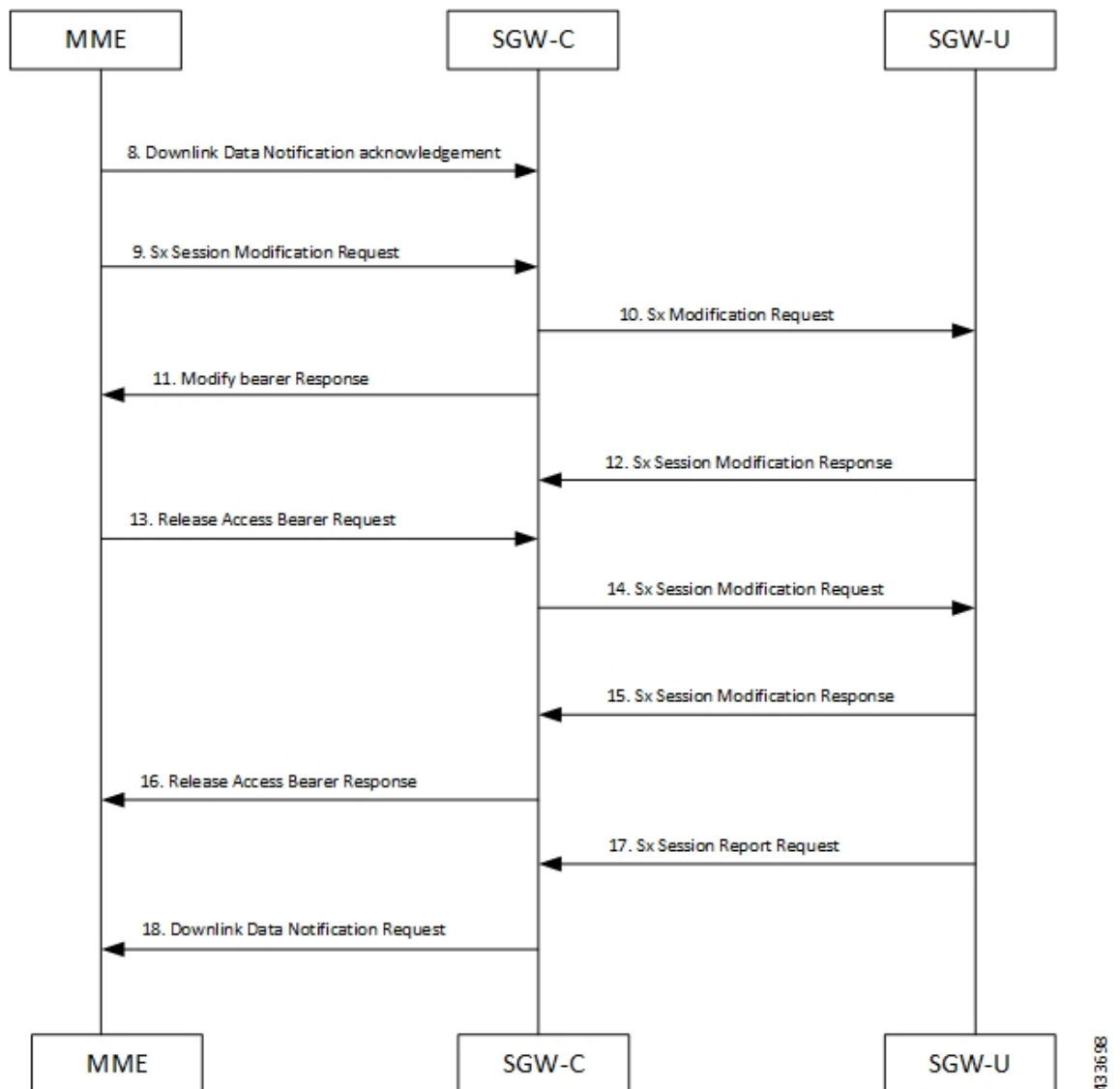

433698

1. MME sends Release Access Bearer request to SGW-C to release downlink remote TEIDs of all the bearers for that UE.
2. On arrival of Release Access Bearer request, SGW-C informs the same to SGW-U by updating FAR with Apply Action as BUFFER in Sx Modification Request for all the PDNs.
3. SGW-U send Sx Modification response after applying Buffering in SGW-U for corresponding PDN.
4. SGW-C sends Release Access Bearer response to MME.
5. First Downlink data arriving in SGW-U triggers Sx Report Request (with Report Type as Downlink Data Report) towards SGW-C.
6. On arrival of Sx Report Request message, the SGW-C initiates Downlink Data Notification request message towards MME.
7. SGW-C sends Sx Report Response message towards SGW-U.
8. Downlink Data Notification Acknowledgment is received from MME with DDN Delay Timer value. This timer value will be saved for this peer, and now onwards every Downlink Data notification that we initiate should be after this delay for that peer.
9. On success paging, MME sends a Modify bearer request to the SGW with eNodeB TEIDs that sets up the S1-U connection at the SGW.
10. SGW-C sends Sx Modification Request with updated FAR for new TEID information to SGW-U. SGW-U can now forward all the buffered data to UE via eNodeB.
11. SGW-C sends Modify Bearer Response to MME.
12. SGW-U sends Sx Modification Response to SGW-C.
13. MME sends Release Access Bearer Request to SGW-C to release downlink remote TEIDs of all the bearers for that UE.
14. On arrival of Release Access Bearer Request, SGW-C inform the same to SGW-U via updating FAR with Apply Action as BUFFER in Sx Modification Request for all the PDNs.
15. SGW-U send Sx Modification Response after applying Buffering in SGW-U for corresponding PDN.
16. SGW-C sends Release Access Bearer Response to MME.
17. First Downlink data arriving in SGW-U triggers Sx Report Request (with Report Type as Downlink Data Report) towards SGW-C.
18. On arrival of Sx Report Request message, SGW-C starts DDN Delay Timer. On DDN Delay timer expiry SGW-C Initiates Downlink Data Notification message towards MME.

Sx Interface

Sx Session Level Reporting Procedure

Detection of first Downlink Data for Idle-Mode UE (by SAEGW-U):

When SAEGW-U receives the downlink packet but no S1-bearer for transmission and the buffering is performed by SAEGW-U, it reports the detection of first downlink data to SAEGW-C, for the purpose of paging the UE.

PFPCP Session Report Request

The PFPCP Session Report Request is sent over the Sxab interface by the User Plane function to report information related to a PFPCP session to the Control Plane function.

Information elements	P	Condition / Comment	Appl.				IE Type
			Sxa	Sxb	Sxc	N4	
Report Type	M	This IE shall indicate the type of the report.	X	X	X	X	Report Type
Downlink Data Report	C	This IE shall be present if the Report Type indicates a Downlink Data Report.	X	-	-	X	Downlink Data Report

Downlink Data Report IE within PFPCP Session Report Request

The Downlink Data Report grouped IE is encoded as shown in the following table.

Octet 1 and 2		Downlink Data Report IE Type = 83 (decimal)					
Octets 3 and 4		Length = n					
Information elements	P	Condition / Comment	Appl.				IE Type
			Sxa	Sxb	Sxc	N4	

PDR ID	M	This IE shall identify the PDR for which downlink data packets have been received at the UP function. More than one IE with this type may be included to represent multiple PDRs having received downlink data packets.	X	-	-	X	PDR ID
--------	---	--	---	---	---	---	--------

Notification to User Plane Function for DDN Failure

The Control Plane function notifies User Plane function for any failure so that buffered packets can be dropped and DDN related flags can be reset through DROBU flag in PFCP Sx Modification message.

PFCPSMReq-Flags	C	DROBU (Drop Buffered Packets): The CP function shall set this flag if the UP function is requested to drop the packets currently buffered for this PFCP session (see NOTE 1).
-----------------	---	---

Limitations

Following are the known limitations of this feature:

- SAEGW Buffering is done for five data packets per PDN session.
- DDN profile configuration is not supported.
- Support for buffered data (data packet stream) that get deleted due to Flow Idle Timeout or other cases, is not present.

DDN Throttling for non-Release 10 Compliant MME

Use the following configuration to configure DDN throttling for a non-release 10 MME:

```

configure
  context context_name
    sgw-service service_name
      ddn throttle arp-watermark arp_value [ rate-limit limit time-factor
seconds throttle-factor percent increment-factor percent [ poll-interval seconds
] throttle-time-sec seconds [ throttle-time-min minutes ] [
throttle-time-hour hour ] stab-time-sec seconds [ stab-time-min minutes ] [
stab-time-hour hour ]
      no ddn throttle
    end
end

```

NOTES:

- **rate-limit:** DDN permitted per second.
- **time-factor:** Time period in seconds over which SGW makes throttling decision (valid range 1-300 seconds).
- **arp-value:** Valid ARP value between 1 and 15. All the packets which have ARP greater than the configured values are throttled as per the throttling factor.
- **throttling-factor:** Percentage of DDN to be dropped upon detecting DDN surge (valid range between 1-100).
- **throttling-time-sec:** Time period in seconds over which DDN is throttled at SGW (valid range between 0-59 seconds).
- **throttling-time-min:** Time period in minutes over which DDN is throttled at SGW (valid range between 0-59 minutes).
- **throttling-time-hour:** Time period in hours over which DDN is throttled at SGW (valid range between 0-310 hours).
- **increment-factor:** Percentage value by which throttling factor is incremented dynamically, if existing throttling factor is insufficient to curb the DDN surge.
- **poll-interval:** Time in seconds (optional argument, default value = 1 second, poll interval < time-factor)
- **stab-time-sec/min/hours:** Stabilization time factor, time period over which if DDN rate returns to normal, then throttling need not be applied over the entire throttling time period.

DDN throttling for non-Release-10 compliant MME makes use of existing Release-10 throttling implementation at SGW. By providing a configuration mechanism for SGW service, operator can still apply ddn throttling without needing any feedback from MME. Some salient points of this feature are described below:

1. The CLI configuration is applied per MME/S4-SGSN. Throttling parameters are tracked independently per MME/S4-SGSN.
2. On configuring this feature through CLI, demuxmgr polls each sessmgr for number of DDNs sent. By default, polling is done every second. This time interval can be changed by configuring the poll-interval time. Greater the poll interval time, lesser the number of internal messages within the chassis. However, it would take longer to detect a DDN surge.
3. By configuring time-factor, operator can specify the time interval for S-GW to apply throttling, if needed. It allows for some surge of DDNs if the net DDN rate is within specified limit over time-factor time interval. For example, time-factor= 10 seconds, ddn rate = 1000, poll interval = 2 seconds. Demux would poll each sessmgr every 2 seconds. Acceptable DDN rate limit is $1000 * 10 = 10000$ DDNs every 10

seconds. Say after 2 seconds, 4000 DDNs were sent, in that case S-GW wouldn't apply throttling until rate limit of 10000 DDNs is crossed within time period of 10 seconds. This allows for intermittent bursts of DDNs.

4. DDN rate limit is configured through CLI. For example, if DDN rate limit is 1000 and poll interval = 1 second, time-factor = 5 seconds, then acceptable rate limit is 5000 DDNs over 5 seconds. If the number of DDNs sent by S-GW is greater than 5000 after 5 seconds, demuxmgr would ask all sessmgrs to initiate throttling.
5. Percentage of DDNs to be throttled is configured through throttling-factor.
6. Operator can specify increment-factor to increment throttling factor if the existing throttling factor is insufficient to curb the DDN surge. For example, if throttling-factor = 10%, ddn-rate = 1000, increment-factor=10%. Once throttling is applied, S-GW drops ~10% DDNs. However, if DDN rate is still greater than 1000, S-GW would increase throttling-factor to 20%. If this is still not sufficient, it would be incremented to 30%. After incrementing throttling factor, if number of DDNs dropped are greater than expected, throttling-factor would then be decrement by increment-factor. For example, in this case, after increasing throttling factor to 30%, if DDNs sent is less than 1000 per second (taking time-factor and poll-interval into consideration), throttling factor would be decremented to 20. The cap for decrementing throttling-factor would be the configured value (10% in this case).
7. Operator can configure the time duration for which throttling is applicable at S-GW. This could be a large value in order of days (for example: 10 days or 240 hours). The operator has an option to stop throttling if DDN rate is well under control by configuring stabilization time factor. In such a case, DDNs won't be needlessly dropped. For example, throttling-time =10 days, stab-time = 8 hours. After S-GW starts DDN throttling, in a time span of 8 hours, DDNs sent + DDNs dropped < ddn-rate * 8 hours, throttling would be stopped.

DDN Throttling for Release 10 Compliant MME

DDN throttling is enabled through Call Control Profile by providing the ARP value. For example, if the ARP value provided is 10, then all bearers with ARP value between 10-15 are treated as low priority bearers and are given throttling treatment. Throttling would not be enabled if ARP value is not provided through S-GW service configuration. Also, ARP IE in DDN message towards MME would not be included unless DDN throttling is configured using S-GW service. If MME is Release 10 compliant, the user need not configure the duration value as the DDN Acknowledgment would have the throttling IE. Otherwise, throttling can be enabled at S-GW by setting the duration value. If it's set to 0, S-GW would apply throttling recurringly. To enable throttling only for a given duration of time (in non Rel-10 compliant MME), user needs to set the value in hours and minutes. From the time of configuration, throttling would be applied at S-GW until the timer duration expires. For example, if user sets hours = 10, minutes = 30, S-GW would apply throttling for next 10 hours 30 minutes.

On re-configuration, all the parameters will be set with new values, but they will be applicable only from the next recalibration except from polling time and time factor.

Use the following configuration to configure DDN throttling for release 10 MME:

```
configure
context context_name
  sgw-service service_name
    [ no ] ddn throttle arp-watermark arp_value
  end
```

NOTES:

- **arp-value:** Valid ARP value between 1 and 15. All the packets which have ARP greater than the configured values will be throttled as per the throttling factor.

Idle Timer for SAE-GW Sessions

An Idle Timer is supported to identify and remove idle sessions that occur in the SAE-GW.

A session becomes idle in some cases where the session is removed from other network nodes, but due to a technical mishap the session could still remain on the SAE-GW leading to resources being held by these idle sessions.

The Idle Timer, once configured, removes those sessions that remain idle for longer than the configured time limit effectively utilizing the system capacity.



Important This feature is currently restricted to Pure-P and Collapsed Call.

Limitations

The Idle Timer feature does not support recovery of Idle Timer in case of redundancy events.

Configuring Idle Timer for SAE-GW Sessions

The Idle Timer is configurable at APN level.

Use the following commands to configure the idle timer for SAE-GW sessions:

```
configure
  context context_name
    apn apn_name
      timeout idle timeout_value
      no timeout idle
      default timeout idle
    end
```

- **no:** Disables the idle timer configuration.
- **default:** Configures the default value for subscriber's time out settings. The default idle timeout value is 0.
- **idle timeout_value:** Designates the maximum duration a session can remain idle, in seconds, before system automatically terminates the session. Must be followed by number of seconds between 0 and 4294967295. Zero indicates function is disabled.

S-GW Session Idle Timeout

This chapter describes the Idle Timeout Handling feature for S-GW sessions. On the ASR5500 platform, subscriber session is represented by call-line. The S-GW product call-line interfaces to its peers through MME/S4-SGSN on S11/S4 and P-GW on S5/S8. In some scenarios, peer sessions are deleted by respective peers, S-GW does not receive or miss deletion messages, and as a result S-GW session remains idle. Such idle or stale sessions are counted toward valid call-lines in system for effectively consuming resources and causing capacity reduction. In such cases, S-GW triggers to get the new subscriber session, which results in the removal of old session for same subscriber. The Idle Timeout Handling support enables the identification of such sessions and initiates deletion to release the resources.

The following points describe the idle timeout handling for S-GW sessions:

- The subscriber session is idle when there is no data traffic activity for the subscriber. The session manager keeps track of the call-line state, when no data traffic is recorded for call-line, such sessions are moved to idle state.
- Session which is idle for defined timeframe referred as idle timeout is considered for idle timeout handling. In idle timeout session, S-GW initiates the deletion of session toward its peers.
- Idle timeout is configured in seconds depending on the network requirements. The timeout range is 1-4294967295 seconds.
- The idle timeout configuration is applicable on S-GW service level for enabling the idle timeout handling for set of subscribers handled by that service.

Configuring Session Idle Timeout

The session idle timer for S-GW sessions is configurable from S-GW service.

To configure Session Idle Timeout for S-GW, use the following configuration:

```
configure
  context context_name
    sgw-service service_name
      [ no | default ] timeout idle timeout_duration
    end
```

NOTES:

- **timeout idle** *timeout_duration*: Specifies the maximum duration a session can remain idle for, in seconds, before the system automatically terminates the session. *timeout_duration* must be an integer in the range of 1-4294967295. 0 disables the feature. By default, it is disabled for the S-GW service.

Show Commands Input and/or Outputs

This section provides information regarding show commands and their outputs in support of the feature.

show subscribers user-plane-only full all

The output of this command displays the following fields in support of this feature:

- buffered pkts
- buffered bytes
- buffer overflow drop pkts
- buffer overflow drop bytes

show subscribers user-plane-only full callid <call_id>

Use the following configuration to check the buffering per subscriber:

- DDN buffered packets
- DDN buffered bytes
- DDN buffer overflow drop packets
- DDN buffer overflow drop bytes

When the buffered packets are debuffered the state changes back to zero.

Each time the packet limit reaches 5, the additional packets get dropped as overflow drops.



CHAPTER 16

DSCP Markings For Collapse Calls

- [Feature Summary and Revision History, on page 197](#)
- [Feature Description, on page 198](#)
- [How It Works, on page 198](#)
- [Configuration, on page 201](#)
- [Monitoring and Troubleshooting, on page 202](#)

Feature Summary and Revision History

Table 40: Summary Data

Applicable Product (s) or Functional Area	5G-UPF
Applicable Platforms	VPC-SI SMI
Feature Default Setting	Disabled – Configuration Required
Related Changes in this Release	Not Applicable
Related Documentation	Not Applicable

Table 41: Revision History

Revision Details	Release
Provided updated output for show subscribers user-plane-only full all and show user-plane-service statistics qos-group sessmgr all CLI commands.	2022.04.0
First introduced	2021.02.0

Feature Description

Currently, QCI-based DSCP markings are applicable for Pure-S and Pure-P calls. The DSCP markings are based on QCI-QOS-Mapping associated with respective S-GW service or P-GW service. For collapse calls QCI-QOS-Mapping associated with PGW-service is applicable. This feature helps to apply the DSCP markings for collapse calls based on associated S-GW and P-GW services for uplink and downlink traffic. For uplink traffic, DSCP markings associated with logical P-GW service are applicable. For downlink traffic, DSCP markings associated with logical S-GW service are applicable. The DSCP markings are present in IP header of data traffic as a part of GTP-U header and Inner IP. There's option to enable or disable this functionality by CLI configuration. When you enable the feature, then only the new functionality is applicable otherwise existing functionality also works. By default, this feature is disabled, so that there's no impact on customers who upgrades to this feature.

DSCP Markings for 5G Calls

The QCI/QOS mapping table in SMF drives the DSCP values being put on the packets. It's similar configuration as in PGW-CP. The DSCP values are sent as part of FAR during call establishment (Sx establishment request/Sx modification request). The DSCP values are being applied to inner packet and outer GTPU packet.

DSCP Markings for 4G Collapsed Datapath Calls

For collapsed Datapath calls:

- On Sxa leg, DSCP marking is sent in FAR from SGWC/Cn-SGWC.
- On N4 leg, DSCP marking is sent in FAR from SMF.
- For uplink packets, UPF applies the DSCP marking as per SMF configuration.
- For downlink packets, UPF applies the DSCP marking as per SGWC/Cn-SGWC configuration in GTPU header.
- For inner packet, DSCP marking is as per SMF configuration.

The SMF configuration/logic of sending the DSCP marking is similar as PGW-C. In case of the DSCP marking for the ECS charging action, priority is given to the charging action configuration for inner packet DSCP marking.

How It Works

Following are the steps that describe the DSCP markings for the collapse calls.

- In case of Collapse call:
 - For ACCESS side, QCI-QOS mapping table associated with SGW-service is used.
 - For CORE side, QCI-QOS mapping table associated with PGW-service is used.
- The preceding conditions apply once you enable the feature, otherwise QCI-QOS mapping table associated with PGW-service is applicable for both sides.

- APN associated QCI-QOS mapping table is preferred over the P-GW service QCI-QOS mapping table.
- APN-Profile associated QCI-QOS mapping table is preferred over SGW-Service QCI-QOS mapping table for ACCESS side DSCP markings.
- In case, only P-GW service has QCI-QOS mapping table configuration, then these DSCP markings is applicable on both ACCESS & CORE side for collapse call.
- In case only S-GW service has QCI-QOS mapping table configuration then these DSCP markings is applicable on ACCESS side for collapse call.
- There's a new configurable parameter inside the SAEGW service which indicates whether the feature is enabled or disable.
- For Pure-P to Collapse HO and conversely, transport layer markings are updated in FAR as a part of Sx Modify request.
- Layer2 markings are also modified based on QCI-QOS mapping table picked for ACCESS and CORE side.
- DSCP markings continue to apply on existing bearers post session recovery.
- DSCP markings continue for the bearers on standby chassis once it switches to active mode.

SessMgr SMF Changes

DSCP markings for Uplink/CORE and Downlink/ACCESS are present at bearer level inside `sessmgr_sub_session_t` → `sessmgr_qci_tab_t`.

User datagram DSCP markings are updated in IP header of inner packet. That is, packet sent from UE to Internet and the opposite way.

Encaps header DSCP markings are updated in IP header of outer IP layer having GTP-U header (Outer header).

DSCP markings are sent from SMF to UPF inside FAR IE as follows:

- Transport Level Marking - The DSCP markings is configured in encaps header for ACCESS side and User-datagram on CORE side for collapse call.
- Transport Level Marking Options—Includes two options and are applicable only for outer header:
 - Copy-inner: Copy the inner packets markings to outer header
 - Copy-outer: Relay the DSCP markings for outer header

Inner Packet Marking—DSCP markings is configured in user datagram for ACCESS side. For CORE side, it's N/A for collapse call.

Logic to fetch the DSCP marking has changed for collapse call:

- Fetch the DSCP markings based on QCI and "qrp_pl" for session from the associated SGW Service for ACCESS/downlink side.
- Fetch the DSCP markings based on QCI and "qrp_pl" for session from the associated PGW Service for CORE/uplink side.
- For ACCESS/downlink side, QCI-QOS-mapping table associated with APN-profile takes preference over SGW Service QCI-QOS-mapping table.

- For CORE/uplink side QCI-QOS-mapping table associated with APN config takes preference over PGW Service QCI-QOS-mapping table.
- In case SGW Service QCI-QOS-mapping table isn't configured, then PGW Service QCI-QOS-mapping table is applicable on both ACCESS/CORE side.
- In case PGW Service QCI-QOS-mapping table isn't configured, then SGW Service QCI-QOS-mapping table is applicable on ACCESS side and no DSCP markings are applicable on CORE side.
- DSCP markings are updated on UPF in create/update FAR sent as a part of Sx/N4 Establishment/Modification request from SMF to UPF.
- Update the TLM, IPM, and TLMO in case of HO from Pure-P to Collapse and vice versa in Sx/N4 Modification request as a part of Update FAR IE.
- Update the Layer2 markings in case of HO from Pure-P to Collapse and vice versa in Sx/N4 Modification request as a part of Update FAR IE.

Following table depicts the various possible config combinations and outcome for DSCP markings to be applied on ACCESS and CORE side for COLLAPSE call:

S. No.	Feature Enable / Disable	PGW Service QOS-QCI Table Configured (Q1)	SGW Service QOS-QCI Table Configured (Q2)	APN QOS-QCI Table Configured (Q3)	APN-Profile QOS-QCI Table Configured (Q4)	ACCESS/Downlink DSCP Markings for Collapse Call	CORE/Uplink DSCP Markings for Collapse Call
1	ENABLE	YES	YES	YES	YES	Q4 (APN-Profile)	Q3(APN)
2	ENABLE	YES	YES	YES	NO	Q2 (SGW-Service)	Q3(APN)
3	ENABLE	YES	YES	NO	YES	Q4 (APN-Profile)	Q1 (PGW-service)
4	ENABLE	YES	YES	NO	NO	Q2 (SGW-Service)	Q1 (PGW-service)
5	ENABLE	YES	NO	YES	YES	Q4 (APN-Profile)	Q3(APN)
6	ENABLE	YES	NO	YES	NO	Q3(APN)	Q3(APN)
7	ENABLE	YES	NO	NO	YES	Q4 (APN-Profile)	Q1 (PGW-service)
8	ENABLE	YES	NO	NO	NO	Q1 (PGW-service)	Q1 (PGW-service)
9	ENABLE	NO	YES	YES	YES	Q4 (APN-Profile)	Q3(APN)
10	ENABLE	NO	YES	YES	NO	Q2 (SGW-Service)	Q3(APN)
11	ENABLE	NO	YES	NO	YES	Q4 (APN-Profile)	N/A (NO DSCP)
12	ENABLE	NO	YES	NO	NO	Q2 (SGW-Service)	N/A (NO DSCP)
13	ENABLE	NO	NO	YES	YES	Q4 (APN-Profile)	Q3(APN)
14	ENABLE	NO	NO	YES	NO	Q3(APN)	Q3(APN)
15	ENABLE	NO	NO	NO	YES	Q4 (APN-Profile)	N/A (NO DSCP)
16	ENABLE	NO	NO	NO	NO	N/A (NO DSCP)	N/A (NO DSCP)
17	DISABLE	YES	YES	YES	YES	Q3(APN)	Q3(APN)

S. No.	Feature Enable / Disable	PGW Service QOS-QCI Table Configured (Q1)	SGW Service QOS-QCI Table Configured (Q2)	APN QOS-QCI Table Configured (Q3)	APN-Profile QOS-QCI Table Configured (Q4)	ACCESS/Downlink DSCP Markings for Collapse Call	CORE/Uplink DSCP Markings for Collapse Call
18	DISABLE	YES	YES	YES	NO	Q3(APN)	Q3(APN)
19	DISABLE	YES	YES	NO	YES	Q1 (PGW-service)	Q1 (PGW-service)
20	DISABLE	YES	YES	NO	NO	Q1 (PGW-service)	Q1 (PGW-service)
21	DISABLE	YES	NO	YES	YES	Q3(APN)	Q3(APN)
22	DISABLE	YES	NO	YES	NO	Q3(APN)	Q3(APN)
23	DISABLE	YES	NO	NO	YES	Q1 (PGW-service)	Q1(PGW-service)
24	DISABLE	YES	NO	NO	NO	Q1 (PGW-service)	Q1 (PGW-service)
25	DISABLE	NO	YES	YES	YES	Q3(APN)	Q3(APN)
26	DISABLE	NO	YES	YES	NO	Q3(APN)	Q3(APN)
27	DISABLE	NO	YES	NO	YES	N/A (NO DSCP)	N/A (NO DSCP)
28	DISABLE	NO	YES	NO	NO	N/A (NO DSCP)	N/A (NO DSCP)
29	DISABLE	NO	NO	YES	YES	Q3(APN)	Q3(APN)
30	DISABLE	NO	NO	YES	NO	Q3(APN)	Q3(APN)
31	DISABLE	NO	NO	NO	YES	N/A (NO DSCP)	N/A (NO DSCP)
32	DISABLE	NO	NO	NO	NO	N/A (NO DSCP)	N/A (NO DSCP)

Configuration

Configure the following command inside the SAEGW service to enable/disable this feature.

```
configure
context egress
  saegw-service saegw_service_name
    downlink-dscp-per-call-type [ enabled | disabled ]
  end
```



Note For collapsed call, when you enable the feature, use the S-GW service QCI-QOS mapping DSCP markings for downlink. By default, the downlink-DSCP-per-call-type is Disabled.

Monitoring and Troubleshooting

This section provides information on CLI commands that are available for monitoring and troubleshooting for DSCP markings for collapse calls.

Show Commands Outputs

This section provides information about show CLI commands that are available in support of DSCP markings for collapse calls.

show saegw-service all

This show command is to check if the feature is enabled or Disabled.

```
Service name : SAEGW11
Service-Id : 47
Context : EPC1
Status : STARTED
sgw-service : SGW11
pgw-service : PGW11
sx-service : SX11C
User Plane Tunnel GTPU Service : SAEGW11SXU
Newcall policy : n/a
downlink-dscp-per-call-type : enabled
CUPS Enabled : Yes
Service name : SAEGW21
Service-Id : 25
Context : EPC2
Status : STARTED
sgw-service : SGW21
pgw-service : PGW21
sx-service : SX21C
User Plane Tunnel GTPU Service : SAEGW21SXU
Newcall policy : n/a
downlink-dscp-per-call-type : disabled
CUPS Enabled : Yes
```

show subscribers user-plane-only callid <call_id> far full all

Use this User Plane CLIs to validate the Transport level marking options and inner packet markings for UPLINK/DOWNLINK FAR.

show subscribers user-plane-only full all

Use this User Plane CLI to see the number of TOS marked packets for U/L and D/L.

```
ToS marked Uplink Pkts: 0
ToS marked Downlink Pkts: 0
```

show user-plane-service statistics qos-group sessmgr all

Use this User Plane CLI to see the statistics for U/L and D/L packets of QoS group Sessmgr instance.

```
Uplink Packets Marked: 0
Downlink Packets Marked: 0
```



CHAPTER 17

Dynamic and Static PCC Rules

This chapter covers the following topics:

- [Feature Summary and Revision History, on page 203](#)
- [Feature Description, on page 204](#)
- [Provisioning of Predefined PCC Rules, on page 204](#)
- [Dynamic PCC Rules Support, on page 205](#)
- [Policing, on page 206](#)
- [Bandwidth Policy Configuration Limits, on page 208](#)
- [Rate Limiting for Static and Predefined Rules, on page 208](#)
- [Rate Limiting for Dynamic Rules, on page 209](#)
- [Standards Compliance, on page 210](#)
- [Configuring the URR IDs, on page 210](#)
- [Threshold Configuration, on page 211](#)

Feature Summary and Revision History

Summary Data

Table 42: Summary Data

Applicable Product(s) or Functional Area	5G-UPF
Applicable Platform(s)	VPC-SI SMI
Feature Default Setting	Enabled – Always-on
Related Changes in this Release	Not Applicable
Related Documentation	<i>UCC 5G UPF Configuration and Administration Guide</i>

Revision History

Table 43: Revision History

Revision Details	Release
Added support for: <ul style="list-style-type: none"> • Flow-level policing • Increase in the the maximum number of groups per bandwidth policy 	2021.01.0
First introduced.	2020.02.0

Feature Description

Dynamic PCC rules are provisioned by the PCF to the PCEF through the HTTP interface and may be either predefined/static or dynamically generated in the PCF. Dynamic PCC rules can be installed, modified and removed at any time.

Predefined PCC rules are configured in the PCEF and can be activated or deactivated by the PCF or by the PCEF at any time. Static PCC rules within the PCEF may be grouped allowing the PCF to dynamically activate a set of static PCC rules over the HTTP reference point. Those static PCC rules to be locally activated by the PCEF are not explicitly known in the PCF, but the PCF simply knows identifiers of static PCC rules to be activated from the PCF.

How it Works

Predefined PCC Rules Support

Config URR IDs are applicable for static rules and also predefined rules. When a subscriber call comes up, it traverses the static rules in rule base. The subscriber primary URR list with bucket IDs as key updates the corresponding URR buckets for the various interfaces with the charging action configuration. For dynamic rules and predefined rules, URR ID list in PDR creates the URR buckets on the User Plane.

Following are the ecosystem changes to support Cisco SMF and UPF to work independently for Charging Action (vendor agnostic way) to work:

- Configurable "Config URR IDs" at UPF
- UPF to enable the local configuration for thresholds

Provisioning of Predefined PCC Rules

Predefined PCC rule is preconfigured in the SMF (for 5GC). Predefined PCC rules can be activated or deactivated by the PCF at any time. The Predefined PCC rules may be grouped allowing the PCF to dynamically activate a set of PCC rules. The SMF may enforce an activated predefined PCC rule by the PCF in the UPF by:

- Determining the service data filters or application IDs referred by the activated predefined PCC rule(s) and the corresponding QoS and charging control information respectively.
- Creating the necessary PDR(s) to identify the service data flow(s), application(s) that the predefined PCC or ADC rule refer to, if not already existing.
- Creating the necessary QER for the QoS enforcement at service data flow or application-level accordingly.
- Creating the necessary FAR if a new FAR must be created as result of QoS flow binding and QoS control for forwarding the detected service data flow or application traffic, or to redirect or to apply traffic steering control if included in the predefined PCC rule.
- Creating the necessary URR(s) for each monitoring key, charging key, combination of charging key and service ID, or combination of charging key, sponsor ID and Application Service Provider ID if included in the predefined PCC rule.

And, later by:

- Associating the created URR(s) to the newly created PDR(s).
- Associating the existing FAR or the new FAR to the newly created PDR(s).

Optionally, the traffic handling policies common to many PFCP sessions (that is, predefined QER(s)/FAR(s)/URR(s)) can be configured in the UPF. The SMF activates these traffic handling policies by including the Activate Predefined Rules IE within one of the following:

- The Create PDR IE in an PFCP Session Establishment Request
- The Create PDR IE in an PFCP Session Modification Request

For traffic matching PDR(s) associated with the activated predefined rules, the UPF enforces the rules. For example, the UPF generates Usage Report(s) and sends it to the SMF, for URR, and the SMF handles the usage reports.

The URR IDs used in reports triggered by a predefined rule in UPF are also preconfigured at the SMF.

Dynamic PCC Rules Support

For dynamic PCC rules multiple flows are supported on per Packet Forwarding Control Protocol (PFCP) session:

- The 5G QoS model allows classification and differentiation of specific services based on subscription-related and invocation-related priority mechanisms. These mechanisms provide abilities such as invoking, modifying, maintaining, and releasing QoS Flows with priority, and delivering QoS Flow packets according to the QoS characteristics under network congestion conditions.
- The 5G QoS model is based on QoS Flows. The 5G QoS model supports both QoS Flows that require guaranteed flow bit rate (GBR QoS Flows) and QoS Flows that do not require guaranteed flow bit rate (Non-GBR QoS Flows).
- The QoS Flow is the finest granularity of QoS differentiation in the PDU session. A QoS Flow ID (QFI) is used to identify a QoS Flow in the 5G System. User Plane traffic with the same QFI within a PDU session receives the same traffic forwarding treatment (Example - scheduling, admission threshold).

- Within the 5GS, a QoS Flow associated with the default QoS rule is required to be established for a PDU session and remains established throughout the lifetime of the PDU session. This QoS Flow must be a Non-GBR QoS Flow.
- A QoS flow is associated with QoS requirements as specified by QoS parameters and QoS characteristics. A QoS flow can either be "GBR" or "Non-GBR" depending on its QoS profile.
 - For each QoS Flow, the QoS profile includes the QoS parameters:
 - 5G QoS Identifier (5QI)
 - Allocation and Retention Priority (ARP)
 - For each GBR QoS flow only, the QoS profile must also include the QoS parameters:
 - Guaranteed Flow Bit Rate (GFBR) - UL and DL
 - Maximum Flow Bit Rate (MFBR) - UL and DL
 - In case of a GBR QoS Flow only, the QoS profile may also include one or more of the QoS parameters:
 - Notification control
 - Maximum Packet Loss Rate - UL and DL

During PDR creation or modification UPF receives the QER for QoS enforcement on flows.

The QoS enforcement rule correlation ID is assigned by the CP function to correlate QERs from multiple PFCP session contexts. For instance, the enforcement of APN-AMBR in the PGW-U is achieved by setting the same QoS enforcement rule correlation ID to the QERs from different PFCP sessions associated with all the PDRs corresponding to the non-GBR bearers of all the UE's PDN connections to the same APN. The QERs that are associated to the same QoS Enforcement Rule Correlation ID in multiple PFCP sessions will be provisioned with the same QER contents in each of these PFCP sessions. The QoS enforcement rule correlation ID is only used to enforce the APN-AMBR when the UE is in EPC, it may be provided by the CP function over N4 to the UP function for a PDU session may move to EPC in a later stage.

If the UPF receives QoS Enforcement Rule Correlation ID for 5G PFCP sessions, then it enforces it.

Policing

The policer configuration uses inputs from the session manager, these inputs are received either from PCF as AMBR or from flow-level QoS information. The values received from the PCF are always accepted for session-level AMBR policing. However, the flow-level policing is prioritized, if available, and AMBR policing is applied sequentially. That is to say, the policer engine applies the hierarchical policing—first the flow-level/rule bandwidth limiting and then the session-level bandwidth limiting.



Note AMBR modifications during session run-time through RAR or CCA-U is applicable.

The input values received from the session manager are pushed into a policer configuration and a policer token bucket. For each direction - uplink or downlink, a new record is created for Policer configuration and Policer token bucket.

The Policer configuration is the reference for the policer engine, and the policer token bucket is used for calculation and restoration of values.

Currently, Policing is supported for AMBR received from PCF and rule-level QoS information for dynamic rules. For static and predefined rules, bandwidth limiting is achieved by the bandwidth policy configuration. Extended bit rates configured in bandwidth-policy configuration in Active Charging Service Configuration mode on SMF is provided to the UPF by RCM, and same is applied for policing by the UPF. An example configuration of bandwidth policy, with extended bit rate, is given below:

```
configure
  active-charging service ACS
    bandwidth-policy BWP

      flow limit-for-bandwidth id 1 group-id 2

      flow limit-for-bandwidth id 2 group-id 3
      flow limit-for-bandwidth id 100 group-id 100

      group-id 2 direction uplink peak-data-rate 256000 peak-burst-size 1000 violate-action
discard
      group-id 3 direction downlink peak-data-rate 256000 peak-burst-size 1000 violate-action
discard
      group-id 4 direction uplink peak-data-rate 300000 peak-burst-size 1200 violate-action
lower-ip-precedence
      group-id 5 direction downlink peak-data-rate 300000 peak-burst-size 1200 violate-action
lower-ip-precedence committed-data-rate 256000 committed-burst-size 1000 exceed-action
lower-ip-precedence
      group-id 100 direction downlink peak-data-rate-kbps 4294967295 peak-burst-size
4294967295 violate-action discard
      group-id 100 direction uplink peak-data-rate-kbps 4294967295 peak-burst-size 4294967295
violate-action discard
      exit
    charging-action catchall
      flow limit-for-bandwidth id 1
      exit
    rulebase cisco
      bandwidth default-policy BWP
      exit
    end
```

Limitations

In this release, Policing has the following limitations:

- Modification of **bandwidth-policy** isn't supported.
- Interaction with other features, such as token replenishment (both APN-level and ACL-level) isn't supported.
- Currently, policer-based statistics aren't supported. You can verify bandwidth limiting using network performance monitoring tools.

Bandwidth Policy Configuration Limits

The user can configure bandwidth limits in both SMF and UPF, for both downlink and uplink packets. The configuration is done in all charging actions of predefined PCC rules, even if the bandwidth limitation configuration is the same for all charging actions.

To optimize these configurations, you must define a bandwidth ID to include all bandwidth-related configurations and associate the bandwidth ID under charging actions.

If the bandwidth value changes, the new subscribers use the configured bandwidth values while the existing subscribers continue to use the old values.

The following are the bandwidth-policy configuration limits:

- Maximum number of bandwidth policies—64
- Maximum number of groups per bandwidth policy—1000
- Maximum number of bandwidth IDs per bandwidth policy—1000
- Maximum number of groups across bandwidth policies—10000
- Maximum number of bandwidth IDs across bandwidth policies—10000

Rate Limiting for Static and Predefined Rules

For static and predefined rules, bandwidth limiting is achieved by the bandwidth policy configuration. Bandwidth Policy must be configured on SMF and UPF under Active Charging Service Configuration Mode.

The following is an example configuration of bandwidth policy with extended bit rate:

```
config
  active-charging service ACS
    bandwidth-policy BWP
      flow limit-for-bandwidth id 1 group-id 2
      flow limit-for-bandwidth id 2 group-id 3
      flow limit-for-bandwidth id 100 group-id 100
      group-id 2 direction uplink peak-data-rate 256000 peak-burst-size 1000 violate-action
      discard
      group-id 3 direction downlink peak-data-rate 256000 peak-burst-size 1000
      violate-action discard
      group-id 4 direction uplink peak-data-rate 300000 peak-burst-size 1200 violate-action
      lower-ip-precedence
      group-id 5 direction downlink peak-data-rate 300000 peak-burst-size 1200
      violate-action
      lower-ip-precedence committed-data-rate 256000 committed-burst-size 1000
      exceed-action
      lower-ip-precedence
      group-id 100 direction downlink peak-data-rate-kbps 4294967295 peak-burst-size
      4294967295 violate-action discard
      group-id 100 direction uplink peak-data-rate-kbps 4294967295 peak-burst-size
      4294967295 violate-action discard
      exit
      charging-action catchall
      flow limit-for-bandwidth id 1
      exit
  rulebase cisco
```

```
bandwidth default-policy BWP
exit
end
```



Note UPF does not support the modification of bandwidth-policy configuration.

Rate Limiting for Dynamic Rules

As per 3GPP TS 29.244, the following Information Element (IE) is received from SMF for QoS enforcement in Create QER or Update QER in Session Establishment or Modification Request:

- **Maximum Bitrate:** This IE is present if an MBR enforcement action is applied to packets matching this PDR. When present, this IE indicates the uplink and/or downlink maximum bit rate to be enforced for packets matching the PDR. For 5GC, this IE may be set to the value of:
 - Session-AMBR—for a QER that is referenced by all the PDRs of the non-GBR QoS flows of a PDU session.
 - QoS Flow MBR—for a QER that is referenced by all the PDRs of a QoS Flow.
 - SDF MBR—for a QER that is referenced by all the PDRs of an SDF.
- **Guaranteed Bitrate:** This IE is present if a GBR has been authorized to packets matching this PDR. When present, this IE indicates the authorized uplink and/or downlink guaranteed bit rate. This IE may be set to the value of:
 - Aggregate GBR—for a QER that is referenced by all the PDRs of a GBR bearer
 - QoS Flow GBR—for a QER that is referenced by all the PDRs of a QoS Flow
 - SDF GBR—for a QER that is referenced by all the PDRs of an SDF
- **QoS flow identifier (QFI):** This IE is present if the QoS flow identifier is inserted by the UPF.
- **Gate Status:** This IE indicates whether the packets are allowed to be forwarded (the gate is open) or it is discarded (the gate is closed) in the uplink and/or downlink directions.
- **QER Correlation ID:** This IE is present if the UP function is required to correlate the QERs of several PFCP sessions, for APN-AMBR enforcement of multiple UE's PDN connections to the same APN.



Note Although it is not applicable, but if UPF receives QoS Enforcement Rule Correlation ID for 5G PFCP sessions then it enforces it.

The SMF provisions QoS enforcement in UPF by creating necessary PDRs to represent SDF, QoS Flow and session and associating respective QERs as follows:

- Creating QERs for the QoS enforcement at session level, SDF level.
- Creating QERs for the QoS enforcement of the aggregate of SDFs with the same GBR QFI.

- Associating the session level QER to all the PDRs defined for the session.
- Associating the SDF or application QER to the PDRs associated to the SDF or application.
- Associating the QER of the aggregate of SDFs to the PDRs associated to SDFs or applications that share the QER.

Standards Compliance

The N4 interface between SMF and UPF is specified in 3GPP TS 23.501 and 3GPP TS 23.502.

Configuring the URR IDs

Config URR IDs are applicable for static rules and predefined rules that are bound to the default bearer. When a subscriber call comes up, static rules in the Rulebase are traversed. The corresponding URR buckets for the various interfaces configured in the Charging Action are updated in the subscriber primary URR list with bucket IDs as key. For Dynamic rules and Predefined rules that are bound to dedicated bearers, the URR ID list in PDR is used for creating URR buckets on the UP.

Currently, the Config URR IDs are generated using running counter at SessCtrl.

To achieve the configurable Config URR IDs:

- Configuration template outside of Charging Action allows URR-ID mapping with “Rating Group” and “Service-id”.
- If a separate Rating Group (RG) is configured for Gy, then that RG is applied to the Gy bucket. If no separate RG is configured for Gy, then the same “Content-id” is applicable for all interfaces.
- “Service-id” is optional for URR-ID mapping.
- URR-ID is unique. This must be ensured through **show configuration error** CLI command, a separate validation script, or checking during config time.
- For UPF, the value for URR-ID generation is taken from the configuration. The UP receives Config URR-ID from configuration rather than PFD message. The PFD mechanism is not used between SMF and UPF.
- SMF does not support the URR-ID list configuration.
- URR-ID is generated independently on UPF and SMF for Static or Predefined rules having rating group/content-id,service-id, and so on.

The following is a sample configuration for URR-ID profile template:

```
rg <x> si <y> urr-id <abc>
rg <x1> si <y1> urr-id <abc1>
rg <x> urr-id <abc2>
```

Use the following configuration to enable Config URR ID.

```
configure
  active-charging service service_name
    urr-list list_name
```



```

        rating-group group_number { service-identifier service_number | urr-id
id_range }
    end

```

NOTES:

- **urr-list** *list_name*: Configures the active charging service URR list. *list_name* must be an alphanumeric string of 1 to 63 characters.
- **rating-group** *group_number* : Specifies the rating ID used in prepaid charging. *group_number* must be an integer in the range of 0 to 2147483647.
- **service-identifier** *service_number* : Specifies the number given to the service.
- **urr-id** *id_range* : Specifies the URR identifier for rating/service group. *id_range* must be an integer in the range of 1-134217727.
- The values can be changed dynamically. However, it will take effect only for new sessions.

Threshold Configuration

The GTPP group configuration is required for threshold calculation at UPF.

UPF uses GTPP group name available from APN configuration. Only one GTPP group should be associated under APN configuration.

The following is a sample configuration:

```

configure
context context_name
  apn apn_name
    gtp group group_name
    ip context-name name
  exit
  gtp group group_name
    gtp egcdr service-data-flow threshold interval interval
    gtp egcdr service-data-flow threshold volume downlink bytes
    gtp egcdr service-data-flow threshold volume uplink bytes
    gtp egcdr service-data-flow threshold total bytes
  end

```

If any one of the above service-data-flow thresholds is hit for offline URR, the UPF sends SX_SESSION_REPORT_REQUEST towards SMF reporting the data volume.



CHAPTER 18

ECS Regular Expression

- [Feature Summary and Revision History, on page 213](#)
- [Feature Description, on page 214](#)
- [How It Works, on page 214](#)
- [Configuring Regex Rule, on page 215](#)
- [Sample Configuration, on page 216](#)
- [Monitoring and Troubleshooting, on page 216](#)

Feature Summary and Revision History

Summary Data

Table 44: Summary Data

Applicable Product(s) or Functional Area	5G-UPF
Applicable Platform(s)	VPC-SI SMI
Feature Default Setting	Disabled - Configuration Required
Related Changes in This Release:	Not Applicable
Related Documentation	Not Applicable

Revision History

Table 45: Revision History

Revision Details	Release
First introduced.	2022.01.2

Feature Description

The ECS Regular Expression feature supports the implementation of regex engine in the User Plane Function (UPF). Furthermore, this feature allows you to configure the regex rule through RCM.

The UPF supports the following protocols as part of regex engine rebuild and rule matching.

- HTTP
 - URL
 - URI
 - HOST
- WWW
 - URL
 - URI
- RTSP
 - URL
 - URI

How It Works

The following table lists the special characters that you can use in regex rule expressions.

Convention	Description
*	Zero or more characters.
+	Zero or more repeated instances of the token preceding the +.
?	Zero or one character.
\character	Escaped character.
\?	Match on a question mark (\<ctrl-v>?)
\+	Match on a plus sign
*	Match on an asterisk
\a	Alert (ASCII 7)
\b	Backspace (ASCII 8)
\f	Form-feed (ASCII 12)
\n	New line (ASCII 10)
\r	Carriage return (ASCII 13)

Convention	Description
\t	Tab (ASCII 9)
\v	Vertical tab (ASCII 11)
\0	Null (ASCII 0)
\\	Back slash
Bracketed range [0-9]	Matching any single character from the range.
A leading ^ in a range	No match in the range. All other characters represent themselves.
.\x##	Any ASCII character as specified in two-digit hex notation. For example, \x5A yields a 'Z'.

The following diagram illustrates the regex rule configuration through RCM:

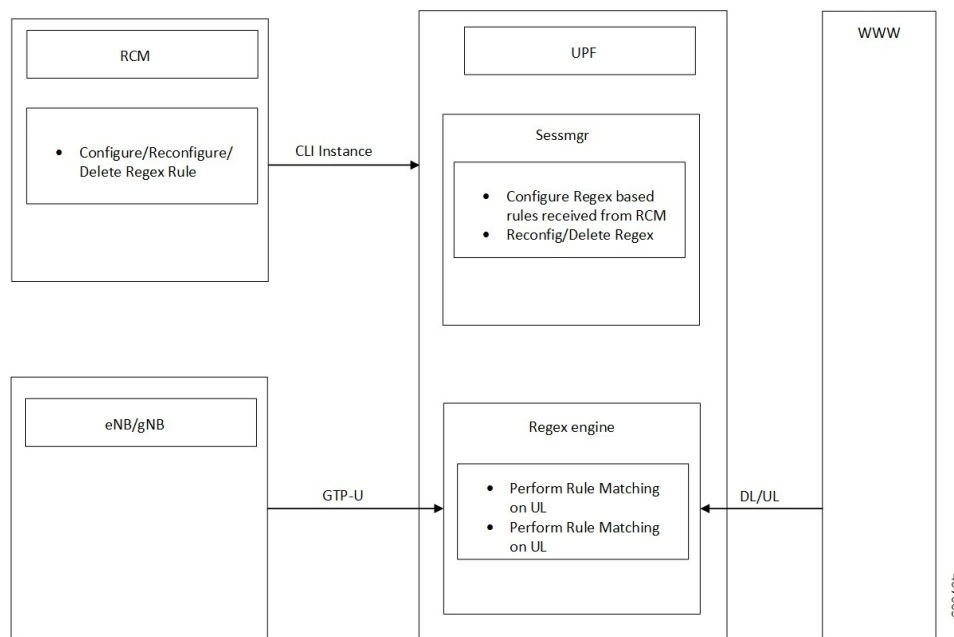

Configuring Regex Rule

Configure the regex rule through RCM using UPF CLI instance or directly on the UPF through CLI.

```
configure
  require rcm-configmgr
end
```

Sample Configuration

Following is a sample configuration for configuring the Regex Rule.

```
configure
  active-charging service <service_name>
    ruledef <ruledef_name>
      http url regex <regex_url>
      rtsp uri regex <regex_uri>
      www url regex <regex_url>
    end
end
```

Monitoring and Troubleshooting

This section provides information on CLI commands that are available for monitoring and troubleshooting the feature.

Show Commands and Outputs

This section provides information about show CLI commands that are available in support of ECS Regex feature in UPF.

Show Commands	Description
show user-plane-service regex status	Use this command to display the engine status for the SessMgr instance.
show user-plane-service regex statistics memory	Use this command to display the memory statistics for the SessMgr instance.
show user-plane-service regex statistics memory summary	Use this command to display the combined memory summary for the SessMgr.
show user-plane-service regex statistics ruledef	Use this command to display the regex ruledef statistics for the SessMgr.
show user-plane-service regex statistics ruledef summary	Use this command to display the combined regex ruledef statistics summary for the SessMgr.



CHAPTER 19

GTP-U Support

- [Feature Summary and Revision History, on page 217](#)
- [Feature Description, on page 218](#)
- [How it Works, on page 219](#)
- [Enabling Dual Stack Support on S5u/N3 Interface, on page 222](#)
- [Disabling UDP Checksum, on page 222](#)

Feature Summary and Revision History

Summary Data

Table 46: Summary Data

Applicable Product(s) or Functional Area	5G-UPF
Applicable Platform(s)	VPC-SI SMI
Feature Default Setting	Enabled – Always-on
Related Changes in this Release	Not Applicable
Related Documentation	Not Applicable

Revision History

Table 47: Revision History

Revision Details	Release
Optimization of UDP checksum is added in this release.	2021.02.0
First introduced	2020.02.0

Feature Description

Table 48: Feature History

Feature Name	Release Information	Description
Dual Stack Support on S5u Interface	2024.02.0	UPF supports dual stack to handle IPv4 and IPv6 connections between SGW-U and PGW-U on the S5u interface. Default Setting: Enabled – Always-on
Dual Stack Support on S1-U and N3 Interfaces	2024.01	UPF supports dual stack to handle IPv4 and IPv6 connections on N3 and S1-U interfaces. Default Setting: Enabled – Always-on

3GPP specifies provisions for UEs capable of supporting both 5G and 4G NAS to connect to the E-UTRAN and 5G core network.

To forward data (G-PDUs and End Marker packets) during an EPS to 5GS handover, the SMF performs the following tasks:

- Provisions one PDR per E-RAB (that supports data forwarding for at least one QoS flow).
- Creates and associates one QER with each PDR to request the UPF to insert a GTP-U PDU Session Container extension header including the QFI. The PDR includes the QFI IE set to the QFI value of one of the QoS flows mapped to the E-RAB.

Data forwarding during handovers between 5GS and EPS is supported as follows. For reference, see 3GPP TS 38.300.

- For 5G to 4G handover, the source NG-RAN node sends one or several end-markers including one QFI of those QoS flows mapped to the same E-RAB and sends the end-marker packets to the UPF over the PDU session tunnel. UPF removes the QFI and maps to an appropriate E-RAB tunnel toward SGW.
- For 4G to 5G handover, the source eNB forwards the received end markers in the EPS bearer tunnel to the SGW. Then SGW forwards them to the UPF. The UPF adds one QFI among the QoS flows mapped to that E-RAB to the end-markers. Then, the UPF sends those end-markers to the target NG-RAN node in the per PDU session tunnel.



Note UPF supports dual-stack to handle IPv4 and IPv6 connections over the S1-U, S5u, and N3 GTP-U interfaces.

Error Indication and GTP-U Path Failure

The UPF notifies an Error Indication message for a GTP-U peer to the sender when a GTP-PDU is received with a TEID that doesn't exist. This notification ensures that there are no stale sessions or bearers, and maintains consistency in the network.

Error Indication and GTP-U Path Failure between SMF and UPF nodes are supported over the N4 interface. For the neighbor nodes, it's supported over the S1u/S5u interfaces.

Behavior variations of local-purge or signal-peer for Error Indication and GTP-U Path Failure are considered in this implementation.

- When Error Indication is received, the UPF communicates the TEID and GTPU-peer information with the SMF to ensure deletion or modification of the GTPU-peer.
- On receiving a GTP-U packet with nonexisting TEID, the UPF generates and sends Error Indication with TEID and GTP-U peer entries.
- The deletion of a session or a bearer is decided based on the Path Failure detection at SMF or UPF.
- GTP-U Path Failure is detected using GTP-U echo messages between the UPF nodes, and between the UPF and SMF nodes.

How it Works

Call Flows

Initial Attach on E-UTRAN via MME and S-GW

Initial attach on E-UTRAN/EPS follows the procedure defined in 3GPP TS 23.401, Section 5.3.2.1.

The following diagram shows the call flow derived from 3GPP reference for initial attach on E-UTRAN/EPS.

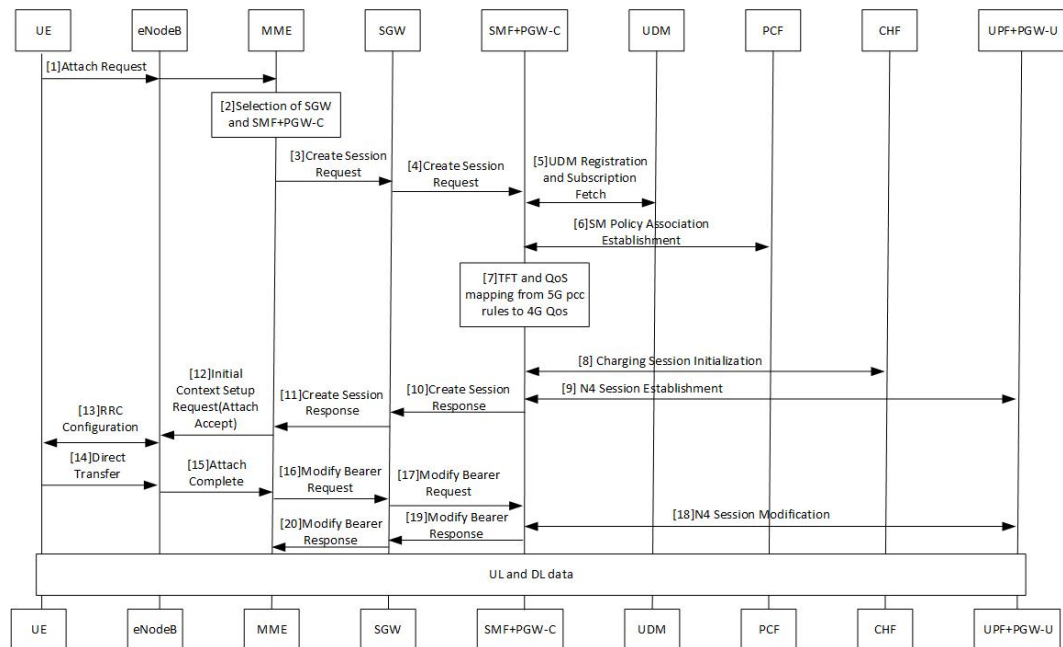

Table 49: Initial Attach on E-UTRAN via 5G Core Call Flow

Step	Description
1	At Step 9, SMF+PGW-C perform a UPF selection and perform N4 Session Establishment procedure. Since this session is a 4G session connecting to SMF+PGW-C, separate CN tunnel is created for each bearer and QFI is not sent in the QER and PDR, correlation ID might be present.
2	At Step 18, SMF+PGW-C performs N4 Session Modification to update the eNodeB TEID on the data path to the UPF.

The 3GPP specifications provide mechanisms to achieve mobility of a UE from LTE to 5G NR and vice versa. This mobility is achieved in two different architectures – with and without N26 interface between AMF and MME.

5G to EPS Handover with N26 Interface

5G to EPS handover with N26 interface is defined in 3GPP TS 23.502, Section 4.11.1.2.1. The following diagram shows the detailed call flow for N26 interface.

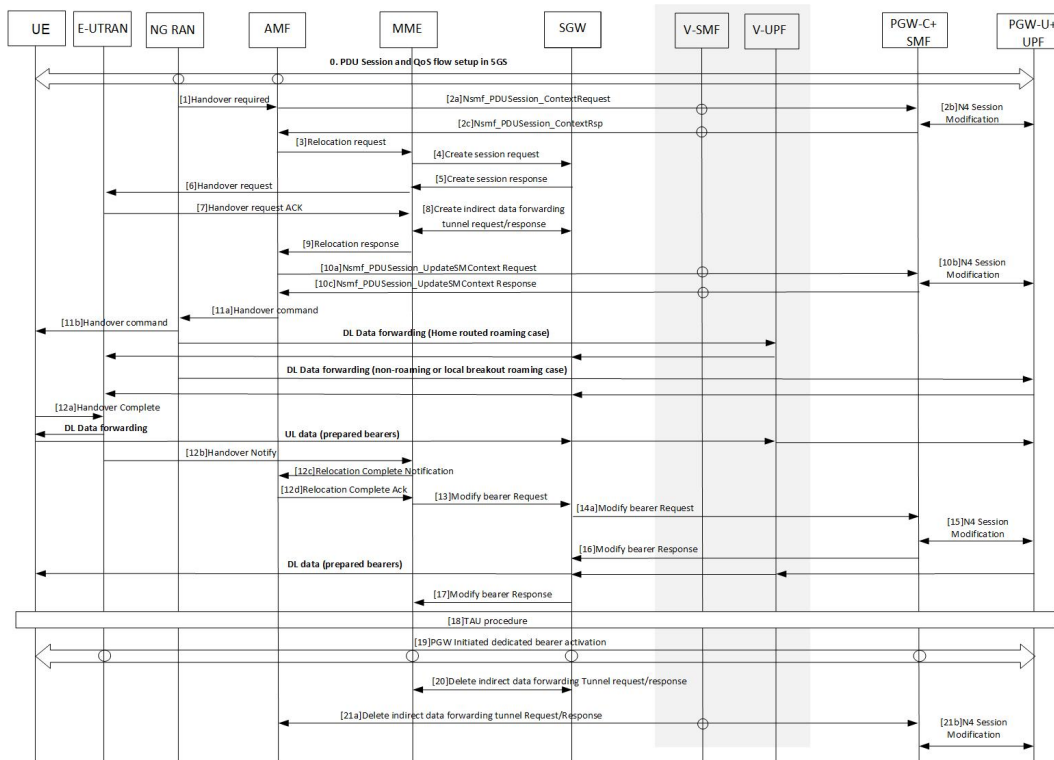

Table 50: 5G to EPS Handover with N26 Interface Call Flow

Step	Description
1	In Step 2b, the SMF+PGW-C sends the N4 Session modification to the UPF to establish the CN tunnel for each EPS bearer. The bearer mapping to the 5G QoS and PCC rules received from PCC is already present with SMF. The SMF also contains the bearer IDs obtained from the Bearer ID Allocation procedure. SMF+PGW-C creates new PDRs for the N4 session and gets TEID allocated for each bearer as required by the 4G system.
2	In Step 10b, SMF+PGW-C sends N4 Modification Request to UPF to create additional PDRs and FARs to receive the redirected DL data over the indirect tunnel from NG RAN and forward them to eNodeB. The uplink PDRs in this case has the QFI to match forwarded DL data from NG RAN and the associated QER does not have the QFI as data needs to be forwarded to eNodeB. Also, the FAR redirects the received data to eNodeB over appropriate tunnel based on the QFI.
3	At Step 11, for the QoS flows indicated in QoS Flows for Data Forwarding, NG-RAN initiates data forwarding through the UPF based on the CN Tunnel Info for Data Forwarding per PDU Session. Then the UPF maps data received from the data forwarding tunnel(s) in the 5GS to the data forwarding tunnel(s) in EPS and sends the data to the target eNodeB through the Serving GW.
4	In Step 15, the SMF sends N4 Modification Request to UPF to activate the DL data path to E-UTRAN. At this time, both the indirect tunnel and the direct DL path are activated towards eNodeB.
5	At Step 21, the SMF sends N4 Modification Request to the UPF to delete the indirect forwarding tunnel.

Other call flows related to EPS to 5G and 5G to EPS handover with N26 interface, or without N26 interface are defined in 3GPP 23.502, Section 4.11.1.2.1 and Section 4.11.2.

Error Indication Handling on UPF

UPF, on receiving Error Indication, initiates a PFCP Session Report Request with Error Indication Report that includes remote F-TEID containing TEID and GTP-U Peer address.

- For PGW-U, Error Indication message is sent or received over S5u.
- For SAEGW-U, Error Indication message is sent or received over S1u.
- For SGW-U, Error Indication message is sent and received over S1u and S5u.

UPF generates Error Indication with TEID and GTP-U Peer Address towards a peer when a data packet is received with TEID for which a session or bearer doesn't exist.

GTP-U Path Failure Support at UPF

GTP-U Echo Requests is initiated and sent periodically as per the configured interval on UPF. GTP-U Echo Response is sent for the GTP-U Echo Request received from SMF over GTP-U tunnel.

If Response is not received for the GTP-U Echo Request, the UPF retries Echo Requests based on configured retransmission timeout and maximum retries. When retries are exhausted, the UPF initiates PFCP node

Report Request including (Node ID, Node Report Type, User Plane Path Failure Report including Remote GTP-U Peer).

If UPF receives PFCP Node Report Response and PFCP Session Deletion Request to delete the session, it responds to the deletion request with usage reports.

Enabling Dual Stack Support on S5u/N3 Interface

The following is a sample configuration to enable dual stack on S5u/N3 interface:

```
context SAEGW
  interface pgw-gtpu loopback
    ip address 81.81.20.5 255.255.255.255
  exit

  gtpu-service pgw-gtpu
    no udp-checksum
    bind ipv4-address 81.81.21.x ipv6-address 2001:4888:81:81::21:5 bearer-type all
  exit

  user-plane-service user_plane_svc
    associate gtpu-service pgw-gtpu upf-ingress
    associate gtpu-service SxC cp-tunnel
    associate sx-service sx-svc
    associate fast-path service
    associate control-plane-group SAEGW
  exit
```

Disabling UDP Checksum

This functionality disables the UDP checksum in UDP header of the GTP-U packet. The value of the UDP checksum is set to zero.

Disabling UDP Checksum

Use the following configuration to disable the UDP checksum in UDP header of the GTP-U packet.

```
configure
  context context_name
    gtpu-service service_name
      no udp-checksum
    end
```



CHAPTER 20

Heartbeat Support for N4/Sx Interface

- [Feature Summary and Revision History, on page 223](#)
- [Feature Description, on page 224](#)
- [How It Works, on page 224](#)
- [Configuring Heartbeat for N4/Sx Interface, on page 225](#)
- [Monitoring and Troubleshooting, on page 226](#)

Feature Summary and Revision History

Summary Data

Table 51: Summary Data

Applicable Product (s) or Functional Area	5G-UPF
Applicable Platforms	VPC-SI SMI
Feature Default Setting	Disabled – Configuration Required
Related Changes in this Release	Not Applicable
Related Documentation	<i>UCC 5G UPF Configuration and Administration Guide</i>

Revision History

Revision Details	Release
First introduced.	2021.01.0

Feature Description

In accordance with 3GPP TS 29.244, support has been added for node-level Heartbeat procedures between the Session Management Function (SMF) and User Plane Function (UPF) over N4/Sx interface.

The Heartbeat procedure contains the following two messages:

1. Heartbeat Request
2. Heartbeat Response

Heartbeat Request

The SMF or the UPF sends a Heartbeat Request on a path to the peer node to find out if it is alive. The Heartbeat Request messages are sent for each peer with which a Packet Forwarding Control Protocol (PFCP) control association is established.

For each peer with which a PFCP control association is established, an SMF or UPF is prepared to receive a Heartbeat Request at any time, and replies with a Heartbeat Response.

Heartbeat Response

This message is sent as a response to a Heartbeat Request.

How It Works

The SMF and UPF sends Heartbeat messages after configurable time duration. If the peer does not respond, the message is retried for configured number of times with the retry-interval and then the configured action is taken for the calls associated with the corresponding peer.

Recovery Time Stamp Information Element (IE), which contains the start time of the node, is supported by both Heartbeat Request and Heartbeat Response. Heartbeat Request contains its own Recovery Time Stamp value and sends it to the peer while Heartbeat Response contains the peers Recovery Time Stamp value.

Path Failure Detection

Path failure is detected in following conditions:

1. Heartbeat failure: This condition occurs when the peer does not respond to the Heartbeat that is sent and also retires.
2. Recovery Time stamp change in Heartbeat: This condition occurs when the Heartbeat Request or Heartbeat Response has a new larger value than the previously received value.
3. Recovery Time stamp change in N4/Sx Association message: This condition occurs when the N4/Sx association message is received again from the peer with a new Recovery Time Stamp.

Path Failure Handling

When the Recovery Time Stamp value received is more than the previously received value, then the peer restart is detected. If the Recovery Time Stamp value is lower than the previously received value then the value is ignored and peer restart is not detected.

When a peer restart is detected, an SNMP Trap is generated to indicate the path failure for the peer. Also, based on the path failure configuration (refer [Configuring Heartbeat for N4/Sx Interface, on page 225](#)), all the calls connected to that peer can be cleared.

Configuring Heartbeat for N4/Sx Interface

This section provides information about the CLI commands available in support of this feature.

Enabling Heartbeat for Sx Interface

Use the following commands under Sx Service Configuration mode to enable Heartbeat parameters for N4/Sx interface.

```

configure
  context context_name
    sx-service service_name
      [ default ] sx-protocol heartbeat { interval seconds |
max-retransmissions number | path-failure detection-policy {
control-recovery-timestamp-change | heartbeat-retry-failure |
heartbeat-recovery-timestamp-change } | retransmission-timeout seconds }
      no sx-protocol heartbeat { interval | path-failure detection-policy
      { control-recovery-timestamp-change | heartbeat-retry-failure |
heartbeat-recovery-timestamp-change }
      end

```

Notes:

- **default**: Sets/restores default value assigned for specified parameter.
- **no**: Disables the followed option.
- **heartbeat**: Configures N4/Sx Heartbeat parameters.
- **interval** *seconds*: Configures Heartbeat interval (in seconds) for N4/Sx Service. *seconds* must be an integer in the range of 1 to 3600.
- **max-retransmissions** *number*: Configures maximum retries for N4/Sx Heartbeat request. Must be followed by integer, ranging from 0 to 15. Default is 4.
- **retransmission-timeout** *seconds*: Configures the Heartbeat retransmission timeout for N4/Sx service, in seconds, ranging from 1 to 20. Default is 5.
- **path-failure**: Specifies the policy to be used when path failure happens through Heartbeat request timeout.

Configuring Detection Policy for Path Failure

Use the following commands under Sx Service Configuration mode to specify detection policy to be used for path failure.

```
configure
  context context_name
    sx-service service_name
      [ default | no ] sx-protocol heartbeat path-failure detection-policy
      { control-recovery-time-stamp-change | heartbeat-retry-failure |
heartbeat-recovery-
timestamp-change }
    end
```

NOTES:

- **default:** Sets/restores default value assigned for specified parameter.
- **no:** Disables the followed option.
- **detection-policy:** Specifies the policy to be used. Default action is to do cleanup upon Heartbeat request timeout.
- **control-recovery-time-stamp-change:** Path failure is detected when the recovery timestamp in control request/response message changes.
- **heartbeat-retry-failure:** Path failure is detected when the retries of Heartbeat messages times out.
- **heartbeat-recovery-timestamp-change:** Path failure is detected when the recovery timestamp in Heartbeat request/response message changes.

Monitoring and Troubleshooting

This section provides information about CLI commands available for monitoring and troubleshooting the feature.

Show Command(s) and/or Outputs

This section provides information regarding show commands and/or their outputs in support of this feature.

show sx-service all

The output of this show command has been enhanced to include the following fields introduced in support of this feature.

- SX Heartbeat
 - Interval
 - Retransmission Timeout
 - Max Retransmission
- SX path failure detection policy

- Heartbeat Timeout
- Heartbeat Req/Rsp Recovery timestamp change
- Control Msg Recovery timestamp counter change

show sx-service statistics all

The output of this show command has been enhanced to include the following fields introduced in support of this feature.

- Heartbeat Request
 - Total TX
 - Total RX
 - Initial TX
 - Initial RX
 - Retrans TX
- Heartbeat Response
 - Total TX
 - Total RX

Disconnect Reasons

The following disconnect reason has been added in support of this feature:

- sx-path-failure - When the Recovery timestamp changes or heartbeat failure is detected, based on the configuration, calls are cleared with this disconnect reason.

SNMP Traps

The following SNMP traps have been added in support of this feature:

- SxPathFailure - This trap is generated when the peer path failure is detected.
- SxPathFailureClear - This trap is generated when the path is restored for the peer.



CHAPTER 21

Idle Mode Buffering and Paging

This chapter covers the following topics:

- [Feature Summary and Revision History](#), on page 229
- [Feature Description](#), on page 230
- [Buffering Action Rule Call Flow](#), on page 230
- [Downlink Data Report for First DL Packet](#), on page 231
- [Paging Policy Differentiation](#), on page 231

Feature Summary and Revision History

Summary Data

Table 52: Summary Data

Applicable Product(s) or Functional Area	5G-UPF
Applicable Platform(s)	VPC-SI SMI
Feature Default Setting	Enabled – Always-on
Related Changes in this Release	Not Applicable
Related Documentation	Not Applicable

Revision History

Table 53: Revision History

Revision Details	Release
First introduced.	2020.02.0

Feature Description

A Buffering Action Rule (BAR) provides instructions to control the buffering behavior of the User Plane Function (UPF). The BAR controls the buffering behavior for all Forwarding Action Rules (FARs) of the Packet Forwarding Control Protocol (PFCP) session. This control is applicable when the PFCP session is set with an Apply Action parameter, which requests packets to be buffered and associated with the respective BAR.

How it Works

If the User Plane Function indicates the support of the feature UL or DL Buffering Control (UDBC), the SMF provides the buffering packet count IE in a BAR. The buffering count IE is created during a PFCP Session Establishment procedure or a PFCP Session Modification procedure. The SMF modifies it in a subsequent PFCP session modification request, "and" or "or" a PFCP Session Report Response message. The same BAR associates with all the FARs in a PFCP session to indicate that all service data flows in the PFCP session shares the same buffer in the UPF for the PFCP session. One BAR is created per PFCP session.

Provisioning of Buffering Action Rule in the UPF

The SMF provisions multiple buffering parameters in a BAR. It is in Create BAR or Update BAR in various PFCP messages.

Currently, UPF supports the following IE:

- The suggested buffering packet count IE—If the UPF indicates the support of the feature UDBC to indicate the number of packets. It includes both uplink or downlink that the SMF suggests buffering in the UPF, until it receives new instructions from the SMF. Example: when the new quota is granted.
- DL buffering suggested packet count IE—This IE is received with update BAR from SMF in Session Report Response message, if SMF wants more DL packets to be buffered on UPF.

The UPF does not apply the DL buffering duration and DL buffering suggested packet count parameters and deletes these parameters from the BAR (without explicit request from the SMF) when extended buffering of downlink data packets ends in the UPF. The UPF does not apply buffering when it receives the new instruction from the SMF. The buffered packets are either dropped or forwarded following the packet forwarding model and considering that the buffered packets are already processed earlier.

Buffering Action Rule Call Flow

This section describes the provisioning of buffering action rule in the UPF call flow.

Figure 12: Buffering Action Rule

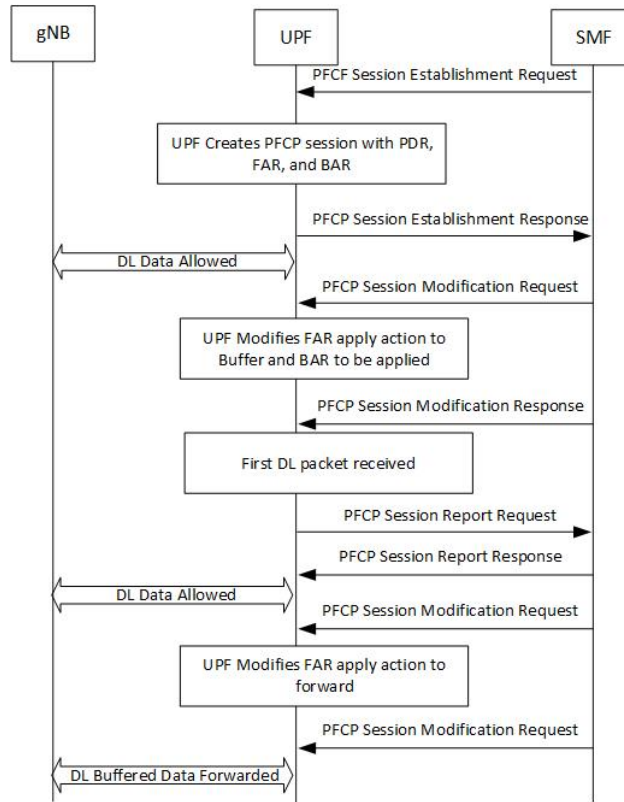

Downlink Data Report for First DL Packet

When instructed to buffer and notify the SMF about the arrival of a DL packet, the UPF notifies the SMF, when it receives a first downlink packet for a given FAR. The UPF notifies the DL packet arrival by sending a PFCP Session Report Request including a Downlink Data Report IE identifying the PDR(s) for which downlink packets was received.

Paging Policy Differentiation

The UPF supports the Paging Policy Differentiation, for each PDR and for each packet that triggers a Downlink Data Notification, the UPF function copies the value of the DSCP in ToS (IPv4) or TC (IPv6) information received in the IP payload in Downlink Data Service Information IE.

For each PDR and for each packet that triggers a Downlink Data Notification, if the QFI of the downlink data packet is available, the QFI is also sent in Downlink Data Service Information IE.

Paging Policy Indicator (PPI)

The SMF sends the PPI value in Create QER or Update QER, if UPF needs to set Paging Policy Indicator in outgoing PDU packets.

Frame Format for the PDU Session User Plane Protocol

Downlink PDU Session Information (PDU Type 0) - This frame format is defined to allow the NG-RAN to receive some control information elements which are associated with the transfer of a packet over the interface. The following figure shows the respective DL PDU SESSION INFORMATION frame.

Figure 13: DL PDU SESSION INFORMATION (PDU Type 0) Format

Bits								Number of Octets
7	6	5	4	3	2	1	0	
PDU Type (=0)				Spare				1
PPP	RQI	QoS Flow Identifier						1
PPI		Spare						0 or 1
Padding								0-3

QoS Flow Identifier (QFI)

Description: When present, the QoS Flow Identifier (QFI) parameter indicates the QoS Flow Identifier of the QoS flow to which the transferred packet belongs.

Value Range: The value range is between 0 to 2⁶-1.

Field Length: 6 bits.

Paging Policy Presence

Description: The Paging Policy Presence (PPP) parameter indicates the presence of the Paging Policy Indicator (PPI).

Value Range: A value of 0 indicates that Paging Policy Indicator is not present and 1 indicates that Paging Policy Indicator is present.

Field Length: 1 bit.

Paging Policy Indicator

Description: When present, the Paging Policy Indicator (PPI) is used for paging policy differentiation (see details in 3GPP TS 23.501). This field applies to PDU sessions of IP type.

Value Range: the value range is between 0 to 2³-1.

Field Length: 3 bits.



CHAPTER 22

Indirect Forwarding Tunnel

- [Revision History](#), on page 233
- [Feature Description](#), on page 233
- [How It Works](#), on page 233
- [Configuring Indirect Forwarding Tunnel](#), on page 236
- [Monitoring and Troubleshooting](#), on page 237

Revision History

Revision Details	Release
First introduced	2021.02.0

Feature Description

The UPF supports Indirect Forwarding Tunnel (IDFT) procedures for creation and deletion, which are applicable for Pure-S and Collapsed calls with dedicated bearers. This feature is applicable for IDFT support with S-GW Relocation.



Note The IDFT in UPF is a CLI-controlled feature. By default, the IDFT feature in UPF is disabled.

How It Works

Call Flow

The following call flow illustrates the IDFT support with S-GW Relocation.

Figure 14: IDFT Support with S-GW Relocation

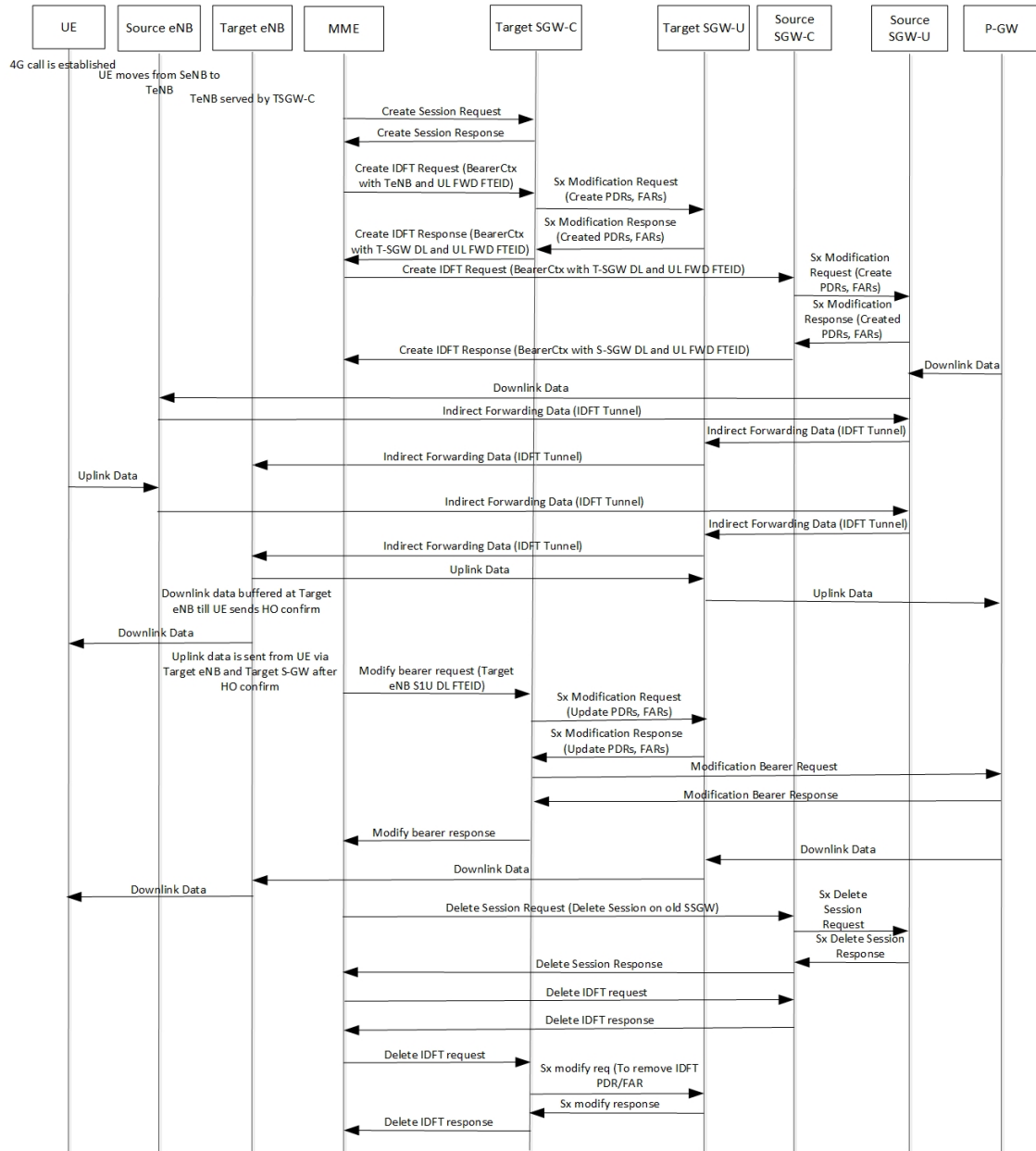

The above call flow describes the IDFT tunnels establishment and deletion with S-GW relocation and without MME change.

If IDFT tunnels are not deleted by MME, then S-GW initiates the local delete of IDFT tunnels.

This feature supports the following scenarios for the Pure-S and Collapse calls:

- S-GW relocation with same MME
- S-GW relocation with same MME and different eNodeB
- S-GW relocation with different MME

- S1-based eNodeB Handoff
- EUTRAN to UTRAN Handoff
- EUTRAN to UTRAN Handoff with S-GW relocation
- UTRAN to EUTRAN Handoff
- UTRAN to EUTRAN Handoff with S-GW relocation
- Tracking Area Update (TAU) with S-GW change and indirect data forwarding
- Radio Access Bearer (RAB) during Active IDFT
- Sx transaction timeout during IDFT setup or removal
- Pending Sx transaction (event from PCRF or OCS) and IDFT request comes in
- Create Bearer Request (CBR) during Active IDFT
- Update Bearer Request (UBR) during Active IDFT
- Delete Bearer Request (DBR) during Active IDFT
- Modify Bearer Request (MBR) behavior on other PDN during Active IDFT
- Source MME path failure
- Target MME path failure
- MME path failure with NTSR enabled
- eGTP-C S5 path failure
- eGTP-C S5 path failure with P-GW restart notification enabled
- Sx path failure (clean IDFT and calls)
- Abort session (clear sub all, local abort, and so on.)
- CBR, UBR on other PDN during Active IDFT
- DBR on other PDN/bearer during Active IDFT
- S1-u path failure for target eNodeB
- S1-u path failure for source eNodeB
- S-GW path failure for source S-GW
- S-GW path failure for target S-GW
- S1-u error indication on the default bearer while Active IDFT
- S1-u error indication on the dedicated bearer while Active IDFT
- S1-u error indication from the target S-GW to source S-GW bearer
- S1-u error indication from the target eNodeB to target S-GW bearer
- Sending End Marker when tearing down IDFT tunnel after failure
- If SMF ICSR/SR leads to the cleanup of IDFTs, the UPF also cleans the IDFT PDRs/FARs

5G to 4G Handover with IDFT

In compliance with 3GPP TS 23.502 v15.5.1, the 5G to 4G handover with IDFT is supported in UPF. Refer the "5GS to EPS handover using N26 interface" section in the 3GPP specification for details about call/datapath flow for IDFT.

This functionality isn't CLI-controlled in UPF.

4G to 5G Handover with IDFT

In compliance with 3GPP TS 23.502 v15.5.1, the 4G to 5G handover with IDFT is supported in UPF. Refer the "EPS to 5GS handover using N26 interface" (preparation and execution phase) section in the 3GPP specification for details about the call flow.

This functionality isn't CLI-controlled in UPF.

Supported Functionality

The IDFT feature supports the following functionality:

- Create IDFT request for Collapsed, Pure-S, combination of Collapsed and Pure-S multi-PDN calls with multiple bearers.
- Data transfer on downlink and uplink IDFT bearers.
- Deletion of IDFT request from MME. Also, timer-based deletion of IDFT bearer after expiration of a default value of 100 seconds, if the MME does not send an IDFT request for deletion.
- Deletion of IDFT PDN, including Clear/Delete subscribers from MME/P-GW, when normal PDN goes down.
- IDFT creation of Sx Failure Handling for Pure-S and Collapsed PDN.

**Important**

Transport GTP-U address capability is assumed to be same across eNodeB and S-GW.

Limitations

The IDFT feature has the following limitations:

- Message interaction and collision during IDFT PDN establishment or deletion with any other procedure is not supported.
- S11/S5 and Sx Path Failure Handling on non-IDFT PDN is not supported when IDFT PDN is Active.
- Deletion of partial dedicated bearers in IDFT connected-state is not supported.

Configuring Indirect Forwarding Tunnel

This section describes the CLI commands available in support of IDFT feature.

Enabling Indirect Forwarding Tunnel Feature

On SMF, use the following CLI commands to enable or disable the IDFT feature.

```
configure
context context_name
  sgw-service service_name
    [ default | no ] egtp idft-support
  end
```

NOTES:

- **idft-support**: Enables/Disables the IDFT feature in UPF.
- By default, the IDFT feature is disabled and this CLI command is applicable on run-time change.

Verifying the Indirect Forwarding Tunnel Feature

show sgw-service name <service_name>

On SMF, the output of this CLI command has been enhanced to display if the IDFT feature is enabled or disabled.

- IDFT-Feature Support for CUPS: Enabled/Disabled

Monitoring and Troubleshooting

This section provides information regarding the CLI commands available in support of monitoring and troubleshooting the feature.

Show Commands Input and/or Outputs

This section provides information regarding show commands and their outputs in support of the feature.

show subscribers saegw-only full all

On UPF, use this command to see the IDFT Local and Remote TEID data. The following is a sample output:

```
Indirect Fwding   : Active
DL fwd local  addr: 209.165.201.28      DL fwd remote  addr: 209.165.201.27
DL fwd local  teid: [0x80028004]        DL fwd remote  teid: [0x2002d2e5]
UL fwd local  addr: 209.165.201.28      UL fwd remote  addr: 209.165.201.27
UL fwd local  teid: [0x8002a004]        UL fwd remote  teid: [0x20042bca]
```

show subscribers user-plane-only callid <call_id> pdr all

On UPF, use this command to see the PDRs created for IDFT. The following is a sample output:



Important IDFT PDRs will have ACCESS as the source and destination interface type.

show subscribers user-plane-only full all

```

+-----Source Interface:      (C) - Core          (A) - Access
|-----Type                  (P) - CP-function   (.) - Unknown
|
|+-----Destination Interface: (C) - Core          (A) - Access
||-----Type                 (P) - CP-function   (.) - Unknown
||
||
||+-----Rule-Type:          (S) - Static        (P) - Predefined
|||-----Type                (D) - Dynamic        (.) - Unknown
|||
|||
vvv   PDR-ID      Associated FAR-ID   Associated URR-ID(s)   Associated QER-ID(s)
---   -
ACS   0x0001     0x8001              n/a                    0x80000001
CAS   0x0002     0x8002              n/a                    0x80000001
ACD   0x0003     0x0003              0x00000007            0x00000002
      0x0004     0x0004              n/a                    0x80000003
CAD   0x0004     0x0004              0x00000007            0x00000002
      0x0005     0x0005              n/a                    0x80000003
CAD   0x0005     0x0005              0x00000000            n/a
ACD   0x0006     0x0006              0x00000000            n/a
CAD   0x0007     0x0007              0x00000000            n/a
ACD   0x0008     0x0008              0x00000000            n/a
AAD   0x0009     0x0009              0x00000000            n/a
AAD   0x000A     0x000A              0x00000000            n/a
AAD   0x000B     0x000B              0x00000000            n/a
AAD   0x000C     0x000C              0x00000000            n/a

```

Total subscribers matching specified criteria: 1

Similarly, you can use the **show subscribers user-plane-only callid *call_id* far all** CLI command to see the FARs created for IDFT

show subscribers user-plane-only full all**Important**

Data statistics on IDFT PDRs are captured in the same way as existing PDR statistics. However, it is captured with a limitation – Statistics for DL and UL IDFT will be incremented in Pkts-Down and Bytes-Down category.

The following is sample output:

```

Static & Predef Rule Match stats:
Rule Name      Pkts-Down  Bytes-Down  Pkts-Up   Bytes-Up   Hits   Match-Bypassed
FP-Down (Pkts/Bytes)  FP-Up (Pkts/Bytes)
-----
catchall      0/0         0/0         0         3          1368   3              0

```

```

Dynamic Rule Match stats:
PDR Id  Pkts-Down  Bytes-Down  Pkts-Up   Bytes-Up   Hits   Match-Bypassed
FP-Down (Pkts/Bytes)  FP-Up (Pkts/Bytes)
-----
0x0004   2          856         0         0         2     0              0/0
0x000b   2          856         0         0         2     0              0/0
0x000c   2          168         0         0         2     0              0/0

```



CHAPTER 23

IPsec Support for IPv6

- [Feature Summary and Revision History, on page 239](#)
- [IPsec AH and ESP, on page 240](#)
- [IPsec Transport and Tunnel Mode, on page 240](#)
- [IPsec Terminology, on page 240](#)
- [Monitoring and Troubleshooting, on page 243](#)

Feature Summary and Revision History

Summary Data

Table 54: Summary Data

Applicable Product (s) or Functional Area	5G-UPF
Applicable Platforms	VPC-SI SMI
Feature Default Setting	Enabled – Always-on
Related Changes in this Release	Not Applicable
Related Documentation	<i>UCC 5G UPF Configuration and Administration Guide</i>

Revision History

Table 55: Revision History

Revision Details	Release
First introduced	2021.04.0

Feature Description

IPsec is a suite of protocols that interact with one another to provide secure private communications across IP networks. These protocols allow the system to establish and maintain secure tunnels with peer security gateways. IPsec provides confidentiality, data integrity, access control, and data source authentication to IP datagrams.

IPsec AH and ESP

Authentication Header (AH) and Encapsulating Security Payload (ESP) are the two main wire-level protocols that are used by IPsec. They authenticate (AH) and encrypt-plus-authenticate (ESP) the data flowing over that connection.

- AH is used to authenticate – but not encrypt – IP traffic. Authentication is performed by computing cryptographic hash-based message authentication code over nearly all the fields of the IP packet (excluding those which may be modified in transit, such as TTL or the header checksum), and stores this in a newly added AH header that is sent to the other end. This AH header is injected between the original IP header and the payload.
- ESP provides encryption and optional authentication. It includes header and trailer fields to support the encryption and optional authentication. Encryption for the IP payload is supported in transport mode and for the entire packet in the tunnel mode. Authentication applies to the ESP header and the encrypted data.

IPsec Transport and Tunnel Mode

Transport Mode provides a secure connection between two endpoints as it encapsulates the IP payload. The Tunnel Mode encapsulates the entire IP packet to provide a virtual secure hop between two gateways.

Tunnel Mode forms the more familiar VPN functionality, where entire IP packets are encapsulated inside another and delivered to the destination. It encapsulates the full IP header and the payload.



Note The UPF:UPF ICSR over IPsec works only with Tunnel Mode. Transport Mode is not supported.

IPsec Terminology

Crypto Access Control List

Access Control Lists define rules, usually permissions, for handling subscriber data packets that meet certain criteria. Crypto ACLs, however, define the criteria that must be met for a subscriber data packet to be routed over an IPsec tunnel.

Unlike other ACLs that are applied to interfaces, contexts, or one or more subscribers, crypto ACLs are matched with crypto maps. In addition, crypto ACLs contain only a single rule while other ACL types can consist of multiple rules.

Before routing, the system examines the properties of each subscriber data packet. If the packet properties match the criteria that are specified in the crypto ACL, the system initiates the IPsec policy that is dictated by the crypto map.

Transform Set

Transform Sets are used to define IPsec security associations (SAs). IPsec SAs specify the IPsec protocols to use to protect packets.

Transform sets are used during Phase 2 of IPsec establishment. In this phase, the system and a peer security gateway negotiate one or more transform sets (IPsec SAs) containing the rules for protecting packets. This negotiation ensures that both peers can properly protect and process the packets.

ISAKMP Policy

Internet Security Association Key Management Protocol (ISAKMP) policies are used to define Internet Key Exchange (IKE) SAs. The IKE SAs dictate the shared security parameters (such as which encryption parameters to use, how to authenticate the remote peer, and so on) between the system and a peer security gateway.

During Phase 1 of IPsec establishment, the system and a peer security gateway negotiate IKE SAs. These SAs are used to protect subsequent communications between the peers including the IPsec SA negotiation process.

Crypto Map

Crypto Maps define the tunnel policies that determine how IPsec is implemented for subscriber data packets.

There are several types of crypto maps that are supported in 5G-UPF. They are:

- Manual crypto maps
- IKEv2 crypto maps
- Dynamic crypto maps

Crypto Template

A Crypto Template configures an IKEv2 IPsec policy. It includes most of the IPsec parameters and IKEv2 dynamic parameters for cryptographic, and authentication algorithms. Security gateway service cannot function without a configured crypto template.

Only one crypto template can be configured per service.

Supported Algorithms

IPsec in 5G-UPF supports the protocols in the following table, which are specified in RFC 5996.

Protocol	Type	Supported Options (with VPP)
Internet Key	IKEv2 Encryption	

Protocol	Type	Supported Options (with VPP)
Exchange version 2	IKEv2 Pseudo Random Function	PRF-HMAC-SHA1, PRF-HMAC-MD5, AES-XCBC-PRF-128
	IKEv2 Integrity	HMAC-SHA1-96, HMAC-SHA2-256-128, HMAC-SHA2-384-192, HMAC-SHA2-512-256, HMAC-MD5-96, AES-XCBC-96
	IKEv2 Diffie-Hellman Group	Group 1 (768 bit), Group 2 (1024 bit), Group 5 (1536 bit), Group 14 (2048 bit)
IP Security	IPsec Encapsulating Security Payload Encryption	NULL, DES-CBC, 3DES-CBC, AES-CBC-192, AES-CBC-128, AES-CBC-256, AES-128-GCM-128, AES-128-GCM-64, AES-128-GCM-96, AES-192-GCM, AES-256-GCM-128, AES-256-GCM-64, AES-256-GCM-96
	Extended Sequence Number	Value of 0 or off is supported (ESN itself is not supported)
	IPsec Integrity	NULL, HMAC-SHA1-96, HMAC-MD5-96, HMAC-SHA2-256-128, HMAC-SHA2-384-192, HMAC-SHA2-512-256 Important HMAC-SHA2-384-192 and HMAC-SHA2-512-256 are not supported on VPC-DI and VPC-SI platforms if the hardware does not have a crypto hardware.

Limitations and Restrictions

Following are the limitations and restrictions for this feature:

- The feature does not support modification of application ToS.
- If the reordering of packets occurs in an SA, the receiver may discard packets because of anti replay mechanism.
- IPv4 traffic cannot pass through the IPv6 tunnels as this configuration is not allowed. However, IPv4 and IPv6 traffic need IPv4 and IPv6 tunnels respectively.

Example Configurations

Sample Configuration

```
context ipsec-s
ipv6 access-list foo6
permit ip host 2002::1 host 2001::1
#exit
ipsec transform-set B-foo6
#exit
```



```
ikev2-ikesa transform-set ikesa-foo6
#exit
crypto map foo6 ikev2-ipv6
match address foo6
authentication local pre-shared-key encrypted key <encrypted_key>
authentication remote pre-shared-key encrypted key <encrypted_key>
ikev2-ikesa max-retransmission 3
ikev2-ikesa retransmission-timeout 15000
ikev2-ikesa transform-set list ikesa-foo6
ikev2-ikesa rekey
payload foo6-sa0 match ipv6
ipsec transform-set list B-foo6
rekey keepalive
#exit
peer fd4d:5643:2886:6e::7c:1
ikev2-ikesa policy error-notification
#exit
interface ike
ipv6 address fd4d:5643:2886:6e:6b::1/64
crypto-map foo6
#exit
interface loop1 loopback
ipv6 address 2002::1/128
#exit
subscriber default
exit
aaa group default
#exit
ipv6 route 2001::1/128 next-hop fd4d:5643:2886:6e::7c:1 interface ike
#exit
#exit
end
```

Monitoring and Troubleshooting

This section describes the CLI commands available to monitor and troubleshoot the IPsec support for the IPv6 feature.

Show Commands

This section provides information about show commands and their outputs in support of this feature.

- **show crypto map**
- **show crypto map tag** *map_name*: Use this command to verify the map status.
- **show crypto map summary**
- **show crypto ikev2-ikesa security-associations**
- **show crypto ikev2-ikesa security-associations tag** *map_name*
- **show crypto ikev2-ikesa security association summary**: Use this command to verify if the IKEv2 SAs are initiated.
- **show crypto ipsec security associations**: Use this command to verify if the IPsec SAs are stabilized.
- **show crypto ipsec security-associations tag** *map_name*

- **show crypto ipsec security-associations peer** *Peer IP Address*
- **show crypto ipsec security-associations summary**
- **show crypto statistics**
- **clear crypto ike-all** — Clear IKEv1 SA / IKEv2 SA of a map based on given criteria.
- **clear crypto managers** — Clear crypto managers.
- **clear crypto statistics** — Clear crypto statistics for this context.
- **clear crypto ikev2 { local-gateway | peer | tag }**
- **clear crypto security-associations { all | counters | local-gateway | peer | tag }**



CHAPTER 24

LTE - Wi-Fi Seamless Handover

- [Feature Summary and Revision History, on page 245](#)
- [Feature Description, on page 245](#)
- [How It Works, on page 246](#)

Feature Summary and Revision History

Summary Data

Applicable Product(s) or Functional Area	5G-UPF
Applicable Platform(s)	VPC-SI SMI
Feature Default Setting	Enabled - Always-on
Related Changes in this Release	Not Applicable
Related Documentation	Not Applicable

Revision History

Revision Details	Release
First introduced.	2021.02.0

Feature Description

Seamless handovers between LTE and Wi-Fi (S2b), for UEs that need continuity with their ongoing data session, is supported in the 5G UPF architecture.

When handover is initiated from LTE to Wi-Fi, the Delete Bearer Request (DBR) is sent over the LTE tunnel immediately when the Create Session Response (CSR) is sent on the Wi-Fi tunnel. This causes some packet loss because of the IPsec tunnel establishment delay at the ePDG. To address the issue of packet loss, a Delete

Bearer Request is sent on LTE tunnel only on expiry of the configured handover timer. If the LTE tunnel is active, uplink and downlink data is exchanged on the LTE tunnel. When handover is complete, uplink and downlink data is exchanged on the Wi-Fi tunnel. This prevents packet loss. During Wi-Fi to LTE handover, if the Modify Bearer Request is received with HI=1, it initiates a tunnel switch from Wi-Fi to LTE as per the specification.

With this feature, the following benefits are seen:

- Minimum packet loss during LTE to Wi-Fi (S2bGTP) handover and making the handover seamless (that is, MAKE before BREAK).
- LTE procedures are handled gracefully over the LTE tunnel when both tunnels are established with the P-GW.
- Wi-Fi procedures are handled gracefully over the Wi-Fi tunnel when both tunnels are established with the P-GW.



Important

- In an LTE to Wi-Fi or Wi-Fi to LTE handover, a tunnel identifier is allocated for new access traffic type for experiencing seamless handover.
-

How It Works

EPC to Non-3GPP Untrusted Wi-Fi Handover Call Flow

This section describes the EPC to non-3GPP untrusted Wi-Fi handover call flow.

Figure 15: EPC to Non-3GPP Untrusted Wi-Fi Handover Call Flow

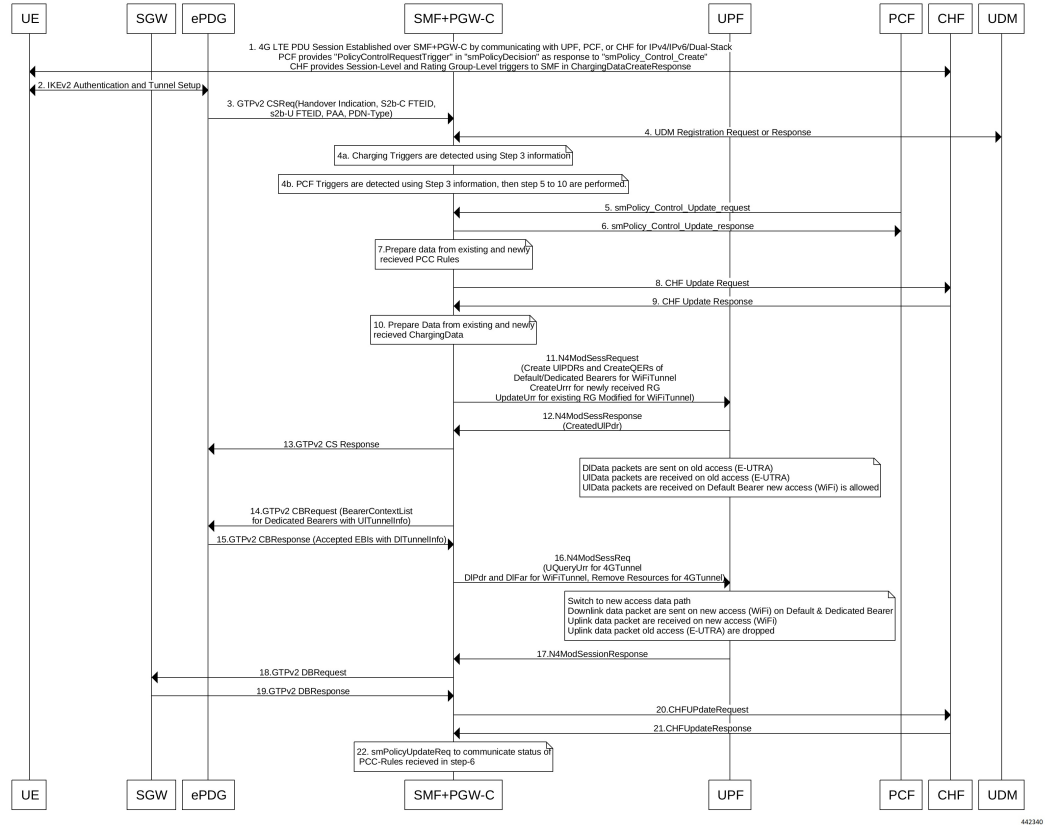

Table 56: EPC to Non-3GPP Untrusted Wi-Fi Handover Call Flow Description

Step	Description
1	The UE is attached to the 3GPP access network. The SMF+PGW-C communicates with UPF, PCF, and CHF for IPv4, IPv6, or dual-stack to establish 4G LTE PDU session. The PCF sends the Policy Control Request trigger, which is the SM policy decision, in response to SM policy control create. The CHF provides session-level or rating-group-level triggers to the SMF in Charging Data Create response.
2	The UE connects to an untrusted non-3GPP access and an ePDG is selected through the ePDG selection process. Then, the UE initiates the handover attach procedure as defined in 3GPP TS 23.402, section 8.6.2.1. After the IKE tunnel is established between the UE and ePDG and after the UE is authenticated over SWm interface with AAA server, the UE initiates IKE authentication (IKE_AUTH). The IKE_AUTH includes configuration parameters of the earlier assigned IPv4 or IPv6 addresses in the EPC and P-CSCF and the DNS options.

Step	Description
3	<p>The ePDG sends a Create Session Request to the P-GW. This request includes the following details:</p> <ul style="list-style-type: none"> • IMSI • APN • Handover indication • RAT type • ePDG TEID of the Control Plane • ePDG address for the User Plane • ePDG TEID of the User Plane • EPS bearer identity • User location <p>The RAT type indicates the non-3GPP access technology type. If the UE supports the IP address preservation and is included in the port analyzer adapter (PAA), then the ePDG configures the handover indication in the Create Session Request to allow the PDN gateway to reallocate the same IP address or the prefix assigned to the UE. This IP address or prefix is assigned while UE is connected to the 3GPP IP access and initiates the policy modification procedure with PCF.</p>
4a	<p>The SMF performs UDM registration by updating the PGW-C FQDN with UDM.</p> <p>The UDM registration does not occur during the session establishment with EPC.</p>
4b	<p>The SMF detects the charging triggers with the information available in Step 3 against the charging triggers that are received during EPC session establishment.</p>
4c	<p>The SMF detects the PCF triggers with the information available in Step 3 against the Request Policy Control triggers that are received in the communication with PCF during EPC session establishment.</p>
5	<p>Based on the detected armed Policy Control Triggers that are received in Step 4b, the SMF sends the SM Policy Control Update request with the detected access parameters in Step 3 to the PCF.</p>
6	<p>The PCF includes new or updated PCC rules and sends the SM Policy Control Update response. The Update response includes information on the SM policy decision.</p>
7	<p>Based on the information received in Step 6 and existing policy data of EPC session, SMF prepares the information for the new or updated PCC rules.</p>
8	<p>If new PCC rules are received in Step 6 with new Rating Group that requires quota information, SMF sends the Charging Update request to CHF. SMF also includes new access parameters for the PDU session information.</p>
9	<p>CHF sends the Charging Update Response with multi-unit information that contains quota information for the requested rating-group in Step 8 to SMF. CHF may also send the new quota information for the existing rating-group of EPC session.</p>
10	<p>SMF processes the information that is received as Charging Update response from CHF.</p>

Step	Description
11	SMF sends the N4 session modification request to UPF for Wi-Fi tunnel. This request includes details on creation of uplink PDR, creation of QER, creation of URR for received new rating-group quota information, and update on URR for modified quota information.
12	UPF sends the UL tunnel information that is in created PDR as the N4 session modification response to SMF.
13	SMF sends the GTPv2 Create Session response to S-GW. This response details on request accepted or request accepted partially, P-GW S2b F-TEID, PAA, APN-AMBR, bearer context creation, charging gateway address, and APCO.
14	SMF sends the GTPv2 Create Bearer request to S-GW. This request includes information on bearer context list, which contains DL tunnel information to end-user, to be created.
15	S-GW sends the GTPv2 Create Bearer response to SMF. The response includes details on request accepted or request accepted partially and bearer contexts.
16	SMF processes the Create Bearer response and derives the DL tunnel information for the established bearer and the failed EBI list, if any. SMF sends the N4 session modification request to UPF for Wi-Fi tunnel. This request is to create the DL PDR and DL FAR with DL tunnel information for each bearer, RAT modification information, and to delete resources for the 4G tunnel. SMF also deletes the N4 resources of Wi-Fi tunnel for the received failed EBI list or the failed QFI list.
17	UPF sends the usage report as N4 Session Modification response to SMF.
18	SMF+PGW-C sends the GTPv2 DB request to S-GW. This request includes EBI or list of EBIs.
19	S-GW sends the GTPv2 DB response to SMF+PGW-C.
20	SMF sends the Charging Update request to CHF. This request includes the PDU session information with the new access params and multi-usage report containing details on the access params and usage report that is received in Step 8
21	CHF sends the multi-unit information as Charging Update response to SMF. The multi-unit information may include new quota information for the existing rating-groups.
22	SMF sends the SM Policy Control Update request to UPF. This request includes the new access params and rule report for failed QFI list that is received from AMF as part of Create Bearer response. PCF sends the SM policy decision as SM Policy Control Update response. SMF processes the SM policy decision and handles it as PCF Initiation Modify procedure as defined in <i>3GPP 23.502, section 4.3.3.2</i> .

Non-3GPP Untrusted Wi-Fi to EPC Handover Call Flow

This section describes the non-3GPP untrusted Wi-Fi to EPC handover call flow.

Figure 16: Non-3GPP Untrusted Wi-Fi to EPC Handover Call Flow

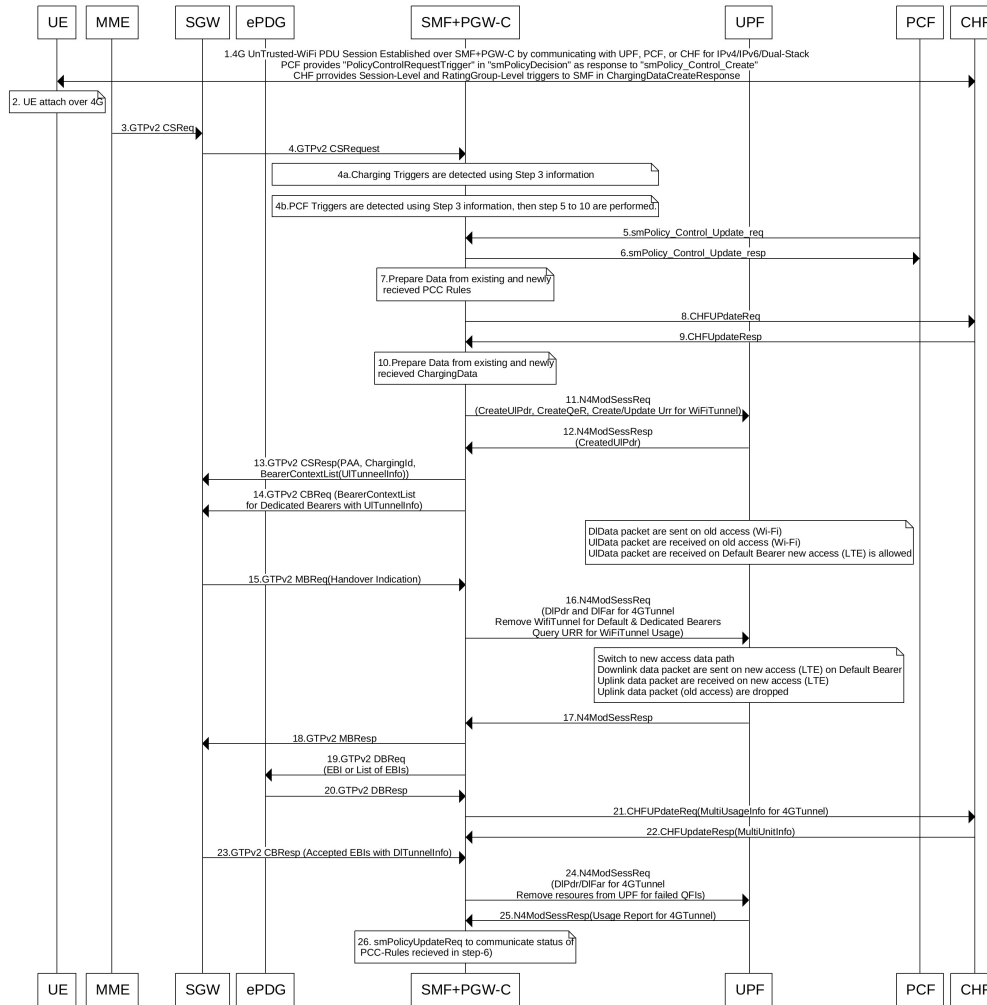

442341

Table 57: Non-3GPP Untrusted Wi-Fi to EPC Handover Call Flow Description

Step	Description
1	One or more PDU sessions are established between UE and ePDG through untrusted non-3GPP access. With the 5G NAS capability of UE, ePDG selects a combined PGW+SMF. UE sends the PDU session ID to the PGW+SMF.
2	<p>UE discovers the E-UTRAN access and hands over the sessions from the currently used non-3GPP access system to E-UTRAN. For details on UE discovery of the 3GPP access system, see <i>3GPP TS 23.401</i>, section 4.8.</p> <p>UE sends an Attach request to MME for the Handover Attach request type. E-UTRAN routes the messages received from UE to MME as defined in <i>3GPP TS 23.401</i>. UE includes the one of the APNs which are corresponding to the PDN connections in the source non-3GPP access. The APN is provided as defined in <i>3GPP TS 23.401</i>.</p>

Step	Description
3	<p>MME and HSS perform authentication, which is followed by location update procedure and subscriber data retrieval to receive the APN information.</p> <p>The MME selects an APN, an SGW and PDN gateway as defined in <i>3GPP TS 23.401</i>. MME sends a Create Session Request message to SGW. This request includes information on IMSI, MME context ID, PDN-GW address, handover indication for the “handover” request type, and APN.</p>
4	<p>SGW sends a Create Session Request, which is handover indication, message to PDN-GW in the HPLMN as described in <i>3GPP TS 23.401</i>. As the MME includes the handover indication information in the Create Session Request message, the SGW sends the GTPv2 Create Session Request message to PDN GW. This message includes details on IMSI, APN, handover indication, RAT type, S5-C TEID, S5-U TEID of the user plane, EBI, and user location information. The RAT type indicates the 3GPP IP access E-UTRAN technology type. If the UE supports IP address preservation and is included in PAA, the SGW configures the handover indication in the Creation Session Request. With this configuration, the PDN GW re-allocates the same IP address or prefix that was assigned to the UE while it was connected to the 3GPP IP access. With this configuration, SGW initiates the Policy Modification Procedure to the PCF.</p> <p>As the handover indication is includes, the PDN GW does not switch the tunnel from non-3GPP IP access to 3GPP access system at this point.</p> <p>SMF does not perform the UDM Registration as the registration happens during the Wi-Fi session establishment.</p>
4a	SMF detects the charging triggers with the information available in Step 3 against the charging triggers that are received during EPC session establishment.
4b	SMF detects the PCF triggers with the information available in Step 3 against the Request Policy Control triggers that are received in the communication with PCF during EPC session establishment.
5	Based on the detected armed Policy Control Triggers that are received in Step 4b, SMF sends the SM Policy Control Update request with the detected access parameters in Step 3 to PCF.
6	PCF sends the SM Policy Control Update response, which is the SM policy decision, by including new or updated PCC rules.
7	Based on the information received in Step 6 and existing policy data of EPC session, SMF prepares the information for the new or updated PCC rules.
8	If SMF receives new PCC rules in Step 6, the SMF sends the Charging Update request, with the new rating-group having quota information, to CHF. This request includes the PDU session information with the new access params.
9	CHF sends the multi-unit information as Charging Update response to SMF. The multi-unit information includes new quota information for the rating-group and the existing rating-group of EPC session, if any.
10	SMF prepares the charging data of the received Charging Update Response that CHF sent.
11	SMF sends the N4 Session Modification Request to UPF. This request includes the details on creation of UL and DL PDR, creation of QER, creation of URR for received new rating-group quota information, updated URR for modified quota information, and creation of FAR.
12	UPF sends the UL tunnel information in the created PDR as N4 Session Modification response to SMF.

Step	Description
13	SMF sends the GTPv2 Create Session response to S-GW. This response details on request accepted or request accepted partially, P-GW S2b F-TEID, PAA, APN-AMBR, bearer context creation, charging gateway address, and APCO.
14	SGW sends the Modification Bearer request with handover indication to PGW for data path switching from Wi-Fi tunnel to 4G tunnel.
15	PGW sends the N4 Session Modification request to delete the Wi-Fi tunnel and to configure DL tunnel information that is received in GTPv2 Create Session request for 4G tunnel in Step 4.
16	UPF sends the N4 Session Modification response to SMF.
17	SMF sends the GTPv2 Create Session request, which includes the bearer context list, to SGW. This list includes the DL Tunnel information for the end-user.
18	SGW sends the GTPv2 Create Session response to SMF. This response includes details on request accepted or request accepted partially and bearer contexts.
19	ePDG sends the GTPv2 Create Bearer resp (accepted EBIs with DL tunnel info to SMF)
20	SMF processes the Create Bearer response and derives the DL tunnel Information for the established bearer and the failed EBI list, if any. SMF sends the N4 session modification request to UPF for Wi-Fi tunnel. This request is to update the DL FAR with the DL tunnel information, RAT modification information, and to delete resources for the 4G tunnel. SMF also deletes the N4 resources of Wi-Fi tunnel for the received failed EBI list or the failed QFI list.
21	UPF sends the N4 Session Modification Response with usage report to SMF.
22	SMF sends the Charging Update request to CHF. This request includes the PDU session information with new access params and multi-usage report consisting of access-params and usage report that is received in Step 8.
23	CHF sends the Charging Update Response with multi-unit information that contains quota information for the existing rating-groups to SMF.
24	SMF+PGW-C initiates the GTPv2 DB Request toward SGW by including EBI or EBI list.
25	SGW sends the GTPv2 DB Response toward SMF+PGW-C.
26	SMF sends the SM Policy Control Update request to UPF. This request includes the new access params and rule report for failed QFI list that is received from AMF as part of Create Bearer response. PCF sends the SM policy decision as SM Policy Control Update response. SMF processes the SM policy decision and handles it as PCF Initiation Modify procedure as defined in 3GPP 23.502 section 4.3.3.2.

ICSR and Session Recovery

- At Session Management Function, during transition, the most recent is considered as the stable state and a full checkpoint is triggered once handover is complete from LTE to Wi-Fi (S2BGTP) or vice-versa. This is applicable to Session Recovery and ICSR. User Plane has individual session recovery and ICSR check pointing on every message received.

- During handover failure, that is, when SMF and UPF are out of sync, the SMF session is recovered on the most recently accessed state and UPF is recovered in the new transition state. This behavior is applicable during UPF failure.

Limitations

The LTE - Wi-Fi Seamless Handover feature does not support LTE to eHRPD and Wi-Fi to eHRPD handover and hand back.

Standards Compliance

The LTE – Wi-Fi Seamless Handover feature is compliant with the following standards:

- 3GPP TS 23.214
- 3GPP TS 29.244
- 3GPP TS 23.401
- 3GPP TS 23.402



CHAPTER 25

Monitor Subscriber

- [Feature Summary and Revision History, on page 255](#)
- [Feature Description, on page 256](#)
- [How It Works, on page 257](#)
- [Configuring the Hexdump Module for MonSub in UPF, on page 270](#)
- [Monitoring and Troubleshooting, on page 272](#)

Feature Summary and Revision History

Summary Data

Table 58: Summary Data

Applicable Product (s) or Functional Area	5G-UPF
Applicable Platforms	VPC-SI SMI
Feature Default Setting	Disabled – Configuration Required
Related Changes in this Release	Not Applicable
Related Documentation	<i>UCC 5G UPF Configuration and Administration Guide</i>

Revision History

Revision Details	Release
Added support for subscriber tracing from SMF.	2023.02.0
In this release, enhancement related to MonSub CLI, subscriber tracing limits, packet processing throughput, PCAP success and, error code notifications are added to this feature. The CP and UP session manager functionality is also added for this release.	21.22.x

Revision Details	Release
First introduced.	21.16.1

Feature Description

The Monitor Subscriber (MonSub) feature enables tracing of subscriber-related information which includes user and control traffic, and events such as charging and internal events that are useful for debugging. By default, this information is displayed on the Session Management Function (SMF) console, where the user executes MonSub tracing CLI command and captured in a Packet Capture (PCAP) file on the UPF.

User traffic is carried on slowpath when packets traverse to the application, or fastpath when packets don't have to traverse up to the application and are offloaded to fastpath processing (VPP). Slowpath mode was the default mode until fastpath offload (VPP) into SAEGW was introduced.

Monitor Subscriber provides the following functionality:

- Continuous capture of user traffic from fastpath in PCAP files in the UPF.
- UPF captures both Control and Data packets.
- The control event traffic and other related information are captured in separate PCAP files in the UPF.
- New option, UP PCAP trace [W - UP PCAP Trace (ON)], is introduced for SMF and UPF in MonSub CLI. The slow-path and fast-path PCAP generates only when this option is ON.
- Maximum of 4 MonSub sessions can be enabled per UPF.
- By default, UPF supports the following MonSub options:
 - PFCP Data (Option 49)
 - CSS Data (Option 34)
 - L3 Data (Option 19)
 - GTPU (Option 26)
 - EDR (Option 77)
 - Subscriber summary after call disconnect
- CSS data now additionally captures Flow Termination due to FLOW IDLE TIMEOUT.

Following are some of the important definitions related to this feature:

- **Chassis Traffic Volume:** The total volume of packet throughput on the chassis.
- **Monitored Traffic Volume:** Monitoring of the total throughput of all the subscribers through MonSub across all the MonSub sessions.
- **PCAP Success:** The percentage of the MonSub traffic capture request and the successful capture in the PCAP files.

PCAP Success

The PCAP success depends on the following factors:

- The level of PCAP success depends on several factors, including monitored traffic volume, VPP utilization, MonSub monitor priority, and background disk I/O.
- In general, the PCAP success rates are greater for the following cases:
 - When the VPP utilization is low and/or MonSub monitor priority is above best-effort.
 - When the monitored traffic volume is less than 10% of the chassis traffic volume.

Example: When VPP is running at 80% utilization and handling approximately 10Gbps chassis traffic volume, then monitored traffic volume up to 1Gbps is likely to yield high PCAP success percentages.

How It Works

The Monitor Subscriber feature is discussed in detail in the following sections:

SMF and UPF Interactions

UPF supports subscriber monitoring using CLI configurations to enable monitor subscriber per UE. However, when there are multiple UPFs in the network, it requires the users to enable monitor subscriber for a UE in all the UPFs, or wait for the UE to attach and identify the UPF, which is handling it and enable monitor subscriber on that UPF.

This feature enables monitor subscriber on UPF based on the configurations on SMF, thereby, eliminates the risk of missing captures.

Subscriber Tracing from SMF

MON SUB IE for Subscriber Tracing from SMF

SMF sends a proprietary MON SUB IE to the UPF to start or stop a subscriber tracing session for a given IMSI. The MON SUB IE is a private Information Element (IE), which can be included only when the tracing options selected require U-Plane participation.

PCFP_IE_MONITOR_SUBSCRIBER_INFO

Figure 17: Subscriber Tracing

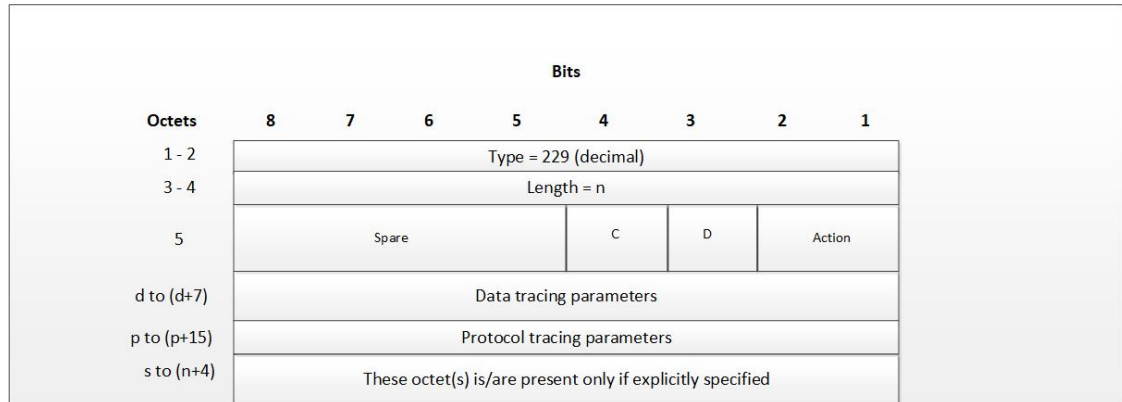

440625

Action: STOP / START monitor subscriber tracing. STOP =1, START =2.



Note D = DATA events tracing is ON when D=1. The 8 octets (d to d+7) contain data events tracing (fastpath) information should be present only when, D=1.

C = CONTROL events tracing is ON when C=1.

Data Tracing (fastpath) Information (8 octets): It contains the data filter parameters like Packet capture, Packet capture size, and MEH header.

• **Octet 1:**

- Bit 1: VPP enable/disable
- Bit 2: FCAP - Packet capture
- Bit 3: MEH present
- Bit 4 to 6: Priority

• **Octet 2 to 3:** Packet size

• **Octet 4 – 8:** Reserved for future use. Currently, all set to 0.

Protocol Tracing Information (16 octets/128 bits): The 16 octets, p-to-(p+15), contain protocol tracing information. It is present only when either the control flag (C) or the data flag (D) is enabled. Each bit represents a unique protocol to monitor. For example, if the 49th bit is 1, PFCP events tracing is ON. The control event flag controls the Protocol Tracing *Rulematch Events (Option 34)*, *L3 Data (Option 19)*, *GTPU (Option 26)*, *EDR (Option 77)*, and *Subscriber Summary After Call Disconnect*.

Enabling Subscriber Tracing from SMF

The SMF sends the MON SUB IE in either of two situations:

1. Session Establishment Request (for a new session), or
2. Session Modification Request (for ongoing session)

Enabling subscriber tracing on SMF is done through a new CLI. For more details, see SMF Monitor Subscriber Configuration.



Note Enabling of session tracing is not piggybacked on any PFCP message. Session Tracing is enabled on UPF via a separate Sx Modification Request from SMF.

Disabling Subscriber Tracing from SMF

To disable the subscriber tracing from SMF, the MON SUB IE with Action = STOP, is sent in a Session Modification Request.

PCAP Generation

UPF generates the slowpath and fastpath PCAPs in the following 3 situations:

1. When subscriber tracing is stopped from SMF via the N4 interface.
2. When a subscriber session is deleted gracefully.
3. When a subscriber session is locally purged on UPF.

Subscriber Trace Status Report IE (Private IE)

The Subscriber Trace Status Report IE is sent corresponding to all monsub START request received from SMF.

Figure 18: Subscriber Trace Status Report

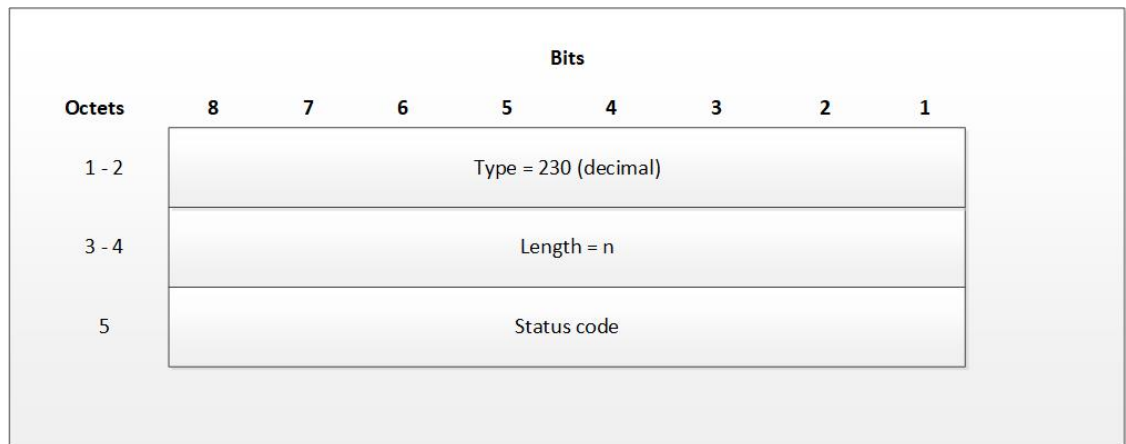

440627

The status code indicates the acceptance or the rejection of the subscriber trace at UP. Status code = 0 means, a success. Values 1-255 uniquely specifies a specific error code or a notification. The list of error codes and notifications are defined post development.

Table 59: Error Code and Notification Table

Status Code	Status Description
MONSUB_SM_SUCCESS (0)	
MONSUB_SM_ERROR_FAILURE (1)	MonSub: Generic Failure status received
MONSUB_SM_ERROR_UNSUPPORTED (2)	MonSub: Unsupported Failure!
MONSUB_SM_ERROR_SESSION_EXIST_NONE (3)	MonSub: Session not Found!");
MONSUB_SM_ERROR_SESSION_LIMIT_EXCEED (4)	MonSub: Max Connections reached!
MONSUB_SM_ERROR_SESSION_INVALID_PARAM (5)	MonSub: Connect Message Failed!
MONSUB_SM_ERROR_SESSION_ALLOC_FAIL (6)	MonSub: Could not allocate monsub session at NPU!
MONSUB_SM_ERROR_CONFIG_INVALID_PARAM (7)	MonSub: Config Message Failed!
MONSUB_SM_ERROR_MONITOR_LIMIT_EXCEED (8)	MonSub: Max Stream Limit reached!
MONSUB_SM_ERROR_MONITOR_INVALID_PARAM (9)	MonSub: Monitor Message Failed!
MONSUB_SM_ERROR_MAX (10)	MonSub: Max Error!
MONSUB_COPROCDATA_CORRUPTED (11)	MonSub: File Handling Process Failed!
MONSUB_MAX_TRACING_SESSIONS_REACHED (12)	MonSub: Maximum Number of Tracing Sessions reached!
MONSUB_STOP_RECVD_WAIT_POLL_TIMEOUT (13)	MonSub: STOP notification is Successful. Wait till the poll-timeout configuration to start the next tracing!
MONSUB_FILECOPY_SOURCE_DIR_NOT_EXIST (14)	MonSub: Source Directory does not exist!
MONSUB_FILECOPY_DEST_DIR_NOT_EXIST (15)	MonSub: Destination Directory does not exist!
MONSUB_FILECOPY_SOURCE_DIR_OPEN_FAILURE (16)	MonSub: Unable to open Source Directory!
MONSUB_FILECOPY_DEST_DIR_OPEN_FAILURE (17)	MonSub: Unable to open Destination Directory!
MONSUB_FILECOPY_SOURCE_OPEN_FAILED (18)	MonSub: Unable to open Source File!
MONSUB_FILECOPY_DESTINATION_OPEN_FAILED (19)	MonSub: Unable to open Destination File!
MONSUB_FILECOPY_DONE_FILE_DELETION_FAILED (20)	MonSub: Unable to delete .done file in Source Path!

Status Code	Status Description
MONSUB_FILECOPY_PCAP_FILE_DELETION_FAILED (21)	MonSub: Unable to delete .pcap file in Destination Path!
MONSUB_RESPONSE_NPUMGR_MONSUB_SESS_FAILED (23)	MonSub: Messenger Failure during Session Notification to NPUMGR!
MONSUB_RESPONSE_NPUMGR_MONSUB_CFG_FAILED (24)	MonSub-Config push to NPUMGR!
MONSUB_RESPONSE_NPUMGR_MONSUB_MONITOR_FAILED (25)	MonSub-Monitor Notification to NPUMGR!
MONSUB_RESPONSE_COPROC_FAILED (27)	MonSub: File Handling Process Failed!
MONSUB_RESPONSE_FILE_TRANSFER_SUCCESS (28)	MonSub: File Transfer successful.
MONSUB_RESPONSE_FILE_TRANSFER_FAILED (29)	MonSub: File Transfer failed!
MONSUB_ADMINISTRATIVE_DISCONNECT (30)	MonSub: Administrative Disconnect!
MONSUB_FILECOPY_DESTINATION_DISK_FULL (31)	MonSub: No space left in Destination Path!
MONSUB_FILECOPY_COPROC_ABRUPTLY_KILLED (32)	MonSub: File copy co-proc terminated abruptly!
MONSUB_LOGGING_COPROC_ABRUPTLY_KILLED (33)	MonSub: Logging co-proc terminated abruptly!
MONSUB_SM_DISCONNECT (34)	
MONSUB_FILECOPY_STATUS_MAX (35)	
Other	Internal Error adding protocol monitor trace - aborting...

Fastpath and Slowpath Packet Captures

The packet capture in MonSub takes place in Slowpath and Fastpath.

Slowpath

- Slowpath PCAP captures the packets going through slowpath (application).
When option PFCP(49), GTPU(26), L3(19), and CSS(34) is enabled, N4 messages/data packets are shown from the time MonSub is enabled.
- Uplink data packet is shown as incoming GTPU, rulematch, outgoing L3.
- Downlink data packet is shown as incoming L3, rulematch, outgoing L3.

Fastpath

- Fastpath PCAP will capture the packets going through fastpath.
- For pure Fastpath packets, the uplink data packet is shown as incoming GTPU, outgoing L3.

- Downlink data packet is shown as incoming L3, outgoing GTPU.
- Slowpath packets are also shown in Fastpath PCAP, while egressing the UPF in both directions.

UPF SessMgr Functionality

Following are the modifications done in the UPF session manager to support this feature:

- Provide services to the CLI for enabling or disabling the MonSub tracing.
- Control NPUMgr to connect/start/stop/add/delete MonSub sessions.
- Based on the instructions from the CLI, configures panopticon (through NPUMgr) for changes, such as packet size and priority.
- Read the "hex dump module" configurations to manage the storage of generated pcap files.
- If the file copy fails or there are problems with session manager MonSub instantiation, raises the SNMP alarms.
- Capture the control or slowpath packets as a separate slowpath PCAP.
- This feature supports a maximum of four monitor subscriber tracing sessions for a UPF instance. The NPUMgr enforces the tracing limit.
- The MonSub tracing session terminates in the absence of no space on hard disk or no hard disk.
- Flow termination due to flow idle timeout is also captured in option 34 CSS Data.
- N4/Sx Establishment Request/Response is also captured.

Multi PDN Multi-trace

For a multi-PDN call, when you start the MonSub with Multi-trace=OFF, then it traces the only one PDN as a part of that MonSub session. When a new PDN is initiated, then existing PDN tracing stops and new PDN tracing starts. For it to happen, first the new PDN tracing is started and then the existing PDN tracing is stopped. Hence, new PSN and session manager sub-session ID is allocated.

For a multi-PDN call, when you start the MonSub with Multi-trace=ON, it traces the new PDN as part of new fastpath tracing session (that is MonSub session). Hence, after tracing the four PDN, MonSub CLI shows max tracing session reached. Tracing each PDN takes place as a separate MonSub session.

MonSub Statistics

A new mechanism is added to publish the statistics regarding the quality of FASTPATH PCAP capture on MonSub CLI. The new mechanism publishes the statistics whenever it receives the buffer full MEH indication at session manager, throttled at every five seconds. The feature supports a maximum of four buffers for a FASTPATH PCAP corresponding to MonSub session. The feature does not publish the statistics by default, and needs to be enabled through debug CLI on UPF.

- **debug uplane monsub-stats disabled**
- **debug uplane monsub-stats enabled**

The stats contains the following informations:

```
Packet accepted: 14250000      Packet rejected: 62297
Congestion Short Term: 0      Congestion Longer Term: 0
Throttled: 0                  PCAP File Transfer Rate: 9.91 mbps
```

The PCAP file transfer rate is the rate at which copy Co-Proc writes the PCAP from RAM-FS to HD-RAID.

X-Header

This feature supports the X-Header capture in slowpath PCAP. When UPF inserts the X-Header for Uplink packet, the UPF captures the packet at entry and exit interfaces. So, the exit packet sent to N6 contains the inserted X-header.

When UPF inserts the X-header for Downlink packet, the UPF captures the packet at entry and exit interfaces. So, the exit packet sent to N3 contains the inserted x-header.

Configuration Procedure for Monitor Subscriber on UPF

The protocol monitor can be used to display information for a specific subscriber session that is currently being processed. Depending on the number of protocols monitored, and the number of sessions in progress, a significant amount of data is generated. It is highly recommended that logging be enabled on your terminal client in order to capture all of the information that is generated.

MonSub can also be initiated from UPF console. Monitoring for a given IMSI should not be enabled from both SMF and UP console.

Follow the instructions in this section to invoke and configure the protocol monitoring tool for a specific subscriber session.

Step 1 Invoke the monitor subscriber command from the Exec mode by entering the **monitor subscriber** CLI command.

```
[local]host_name# monitor subscriber { callid | imei | imsi | ipaddr | ipv6addr |
msid | msisdn | next-call | pcf | peer-fa | peer-lac | sgsn-address | type |
username }
```

An output listing all the currently available protocols, each with an assigned number, is displayed. Specify the method the monitor should use by entering the appropriate keyword.

Step 2 Specify the method the monitor should use by entering the appropriate keyword.

Select other options and/or enter the appropriate information for the selected keyword.

Step 3 Select other options and/or enter the appropriate information for the selected keyword.

If no session matching the specified criteria was being processed when the monitor was invoked, a screen of available monitoring options appears.

Step 4 Configure the amount of information that is displayed by the monitor. To enable or disable options, enter the letter or 2-digit number associated with that option (C, D, E, 11, 12, etc.). To increase or decrease the verbosity, use the plus (+) or minus (-) keys.

The current state, ON (enabled) or OFF (disabled), is shown to the right of each option.

Option **Y** for performing multi-call traces is only supported for use with the GGSN.

```
WARNING!!! You have selected options that can DISRUPT USER SERVICE
Existing CALLS MAY BE DROPPED and/or new CALLS MAY FAIL!!!
(Under heavy call load, some debugging output may not be displayed)
Proceed? - Select (Y)es or (N)o
```

Step 5 Repeat step 6 as needed to enable or disable multiple protocols.

Step 6 Press the **Enter** key to refresh the screen and begin monitoring.

The monitor remains active until disabled. To quit the protocol monitor and return to the prompt, press **q**.

Monsub CLI Options

Monitor Subscriber CLI – New Options

The following options with their default value are the additions to existing **monitor subscriber** command:

UPF Monitor Subscriber CLI

Following are the options:

- **W - UP PCAP Trace (ON)**: This parameter creates PCAP trace for slowpath and fastpath and is only applicable for CUPS.
- **U - Mon Display (ON)**: The non-protocol events (such as statistics, charging information from ECS, etc.) are also captured in slowpath PCAP files and are displayed on U-PLANE monitor console.
- **V - PCAP Hexdump (ON)**: This flag must be set to ON to capture the protocol packets in a text file in hexdump format on U-PLANE.



Note Currently, UP PCAP Trace flag must be set to ON to capture fastpath and slowpath PCAP files on CUPS.

Monitor Subscriber CLI – New Options

The following options with their default value are the additions to existing **monitor subscriber** command:

- **F - Packet Capture (Full Pkt)**: Captures all packets from fastpath.

Using this option, operators can choose between full and partial packet captures. By entering **F**, the packet capture type can be changed to either full or partial. With partial packet capture, users can enter packet sizes from 1 to 16384 bytes. For example, if input is 20, only the first 20 bytes of fastpath packets will be captured and the remaining packets will be dropped.



Note When opening the PCAP file, the summary view displays full length of the packet, but the detailed view shows only the truncated packet.

- **/ - Priority (0)**: The value is in the range from "0 – Best Effort" to "7 – Guaranteed"
 - 0 - Best Effort

- 1 - Low
- 2 - Med-Low
- 3 - Medium
- 4 - Med-High
- 5 - High
- 6 - Critical
- 7 - Guaranteed



Caution It is strongly recommended not to change the default value. It can adversely affect the system performance.

- **N - MEH Header (OFF):** The MEH header is stripped from the IP packet, when this option is configured

Show Monitor Subscriber Sessions

Following is the new CLI to show the ongoing MonSub session.

You can trigger the CLI **show monitor subscriber fastpath session all** from UPF.

- **SessId:** This is the local session id for MonSub session on UP session manager.
- **CallID:** Call id on Userplane.
- **PSN:** This is panopticon sequence number. There is a maximum of four MonSub fastpath tracing sessions on one UP with PSN ranging from 0-3.
- **Start time:** Time at which MonSub tracing session starts.
- **Interface Type:** This is to identify the call type, for which MonSub fastpath tracing session is started, whether it is Sxa, Sxb or Sxab.

Disconnect Monitor Subscriber Sessions

Following is the new CLI to disconnect the ongoing MonSub session. You can trigger the CLI from UPF.

monitor subscriber fastpath disconnect sessmgr-instance <UP SMGR Instance ID> session-id <Local Monitor subscriber Session ID at SMGR instance level>

If the MonSub session disconnect is successful, the following message displays on console.

```
Session Disconnected Successfully
```

If the MonSub session disconnect fails, the following message displays on console.

```
Monitor Subscriber session does not exist
```



Note Only security administrator can execute the monitor disconnect CLI.

Context, CDRMOD, and Hexdump Interaction for Monitor Subscriber

Hexdump module must be configured to provide operators the provision to configure Files names and Poll timers. The Hexdump module is one of the modules such as—EDR, UDR, and so on, that are part of the CDRMOD functionality. Configure the hexdump in a non-local context such as the ECS context. The local context does not support Hexdump modules.

For more information on Hexdump module and its configuration, refer to the [Configuring the Hexdump Module for MonSub in UPF](#) section.

PCAP File Name Convention

Following section discusses the naming conventions for PCAP files:



Note Only **monitor-subscriber-file-name** and **rotation** options are used in naming PCAP files.

Slowpath File Name Convention

The slowpath file names appear in the following format:

```
curr_slowpath_{SMGR Mon Sub Session
Id}_{monsub_file_name_option_val}_{Timestamp}_{RotationCount}.pcap
```

or

```
slowpath_{SMGR Mon Sub Session
Id}_{monsub_file_name_option_val}_{Timestamp}_{RotationCount}.pcap
```

File with 'curr_' prefix is the file, that is currently being written to, which is still not closed. When files are to be rotated (depending on the file rotation parameters), file without the 'curr_' prefix are copied to hard disk.

The SMGR MonSub Session Id – This is the session Id for MonSub session created on Uplane SMGR instance ID, which created this PCAP. This Id is local to SMGR instance, so there could be two SLOWPATH pcap captured with same ID.

When files are to be copied to hard disk, the monsub_file_name_option_val is replaced by:

- IMSI value if **monitor-subscriber-file-name** is set to "imsi".
- Call ID value if **monitor-subscriber-file-name** is set to "call-id"
- Username value if **monitor-subscriber-file-name** is set to 'username'

Timestamp is in the following format "MMDDYYYYHHMMSS", where:

- MM - Month, DD - Date and YYYY - Year.
- HH -Hour, MM - Minutes and SS - Seconds.

RotationCount is a 9-digit value that is incremented every time an old file is rotated, and a new file is generated. 00000000 for the first file, 00000001 for the second file and so on.

Rotation of slowpath files is determined by following option in **hexdump-module file** configuration:

rotation { **num-records** *number* | **time** *seconds* | **volume** *bytes* }

- **num-records:** num-records specifies the number of packets after which, a new file is generated and 'RotationCount' in the filename is incremented. The range of number is between 100 to 10240, and the default value is 1024.
- **time:** time specifies the time to wait in seconds before a new file is generated and 'RotationCount' in the filename is incremented. seconds must be an integer from 30 through 86400. The default value is 3600.
- **volume:** volume specifies the number of bytes after which a new file is generated and 'RotationCount' in the filename is incremented. bytes must be an integer from 51200 through 62914560. The default value is 102400.



Note The **tarriff-time** parameter under rotation is ignored as it is not suitable for PCAP file capture.

The following are examples of the file naming conventions for slowpath PCAP files:

- For the 'imsi' option where IMSI is '112233445566778', slowpath files are named as:

```
slowpath_S0_112233445566778_07152019050907_000000000.pcap
```

- For 'call_id' option where Call Id is '01317b22', slowpath files are named as:

```
slowpath_S0_01317b22_07152019050907_000000000.pcap
```



Note The parameter **tarrif-time** is not applicable for PCAP file capture.

Fastpath File Name Convention

The fastpath file names appear in the following format:

```
vpp_{S}_{B}_{encap}_{monsub_file_name_option}_{Timestamp}_{FileCount}.pcap
```

- S is replaced by either 'S1', 'S2', 'S3', or 'S4'.
- B is replaced by either 'B0', 'B1', 'B2', or 'B3' depending on the bundle generated by Panopticon.
- monsub_file_name_option is replaced by:
 - IMSI value if **monitor-subscriber-file-name** is set to "imsi".
 - Call ID value if **monitor-subscriber-file-name** is set to "call-id"
 - Username value if **monitor-subscriber-file-name** is set to 'username'

Timestamp is in the following format "MMDDYYYYHHMMSS", where:

- MM - Month, DD - Date and YYYY - Year.
- HH -Hour, MM - Minutes and SS - Seconds.

RotationCount is a 9-digit value that is incremented every time an old file is rotated, and a new file is generated.

00000000 for the first file, 00000001 for the second file and so on.

Fast path "FileCount" is not the same as the slowpath "RotationCount" parameters and hence 'hexdump-module file rotation' parameters are ignored while naming fastpath files.

In Phases 1 of the feature, fastpath generated file names are like 'vpp_S1_B0_ip.pcap' or 'vpp_S1_B1_ip.pcap', they are renamed to following when being copied over to non-volatile storage:

- vpp_S1_B0_ip_01317b22_07152019050907_000000000.pcap
- vpp_S1_B1_ip_01317b22_07152019050908_000000001.pcap
- vpp_S1_B0_ip_01317b22_07152019050908_000000002.pcap

In MonSub phase 3, a PCAP "bundle" is replaced with a single PCAP file that uses Ethernet encapsulation.

In Phase 3, each fastpath session file is captured in the Ethernet PCAP file that is 'vpp_S0_B0_eth.pcap' and they are renamed to following when being copied to a non-volatile storage:

```
vpp_S0_B0_eth_01317b22_07152019050907_000000000.pcap
```

For 'callid' option where Call Id is '12345678ef':

- slowpath_S0_12345678ef_07152019050907_000000000.pcap
- vpp_S1_B0_eth_12345678ef_07152019050907_000000000.pcap

For 'username' option where username is '9890098900':

- slowpath_S0_07152019050907_000000000_9890098900.pcap
- vpp_S1_B0_eth_07152019050907_000000000_9890098900.pcap

PCAP File Location

Fastpath PCAP files are written to the `/records/pcap` directory in same card and CPU complex where the session manager owns the subscriber session resides.

`/records` directory is mapped to the "tmpfs" filesystem that is mapped to RAM. In this state, the files are suffixed with a ".pending" extension. For example:

```
-rw-rw-r-- 1 root root 268599296 Sep 23 14:04 vpp_S1_B0_eth.pending
```



Note The files size at this stage is not the actual file size when it is written to a persistent storage.

Once the fastpath tracing mechanism has written the files, they are converted to '.pcap' files and renamed as given below. Additionally, there is a file that ends with a ".done" extension:

```
-rw-rw-r-- 1 root root 8689188 Oct 16 22:06 vpp_S0_B0_eth.pcap
```

After the PCAP files are written by fastpath tracing mechanism, the Co-Proc functionality instantiates and copies the files to a hard disk or a persistent storage.

The aforementioned file location process for Fastpath is also applicable to Slowpath.

The target file location in all cases is: `/hd_raid/records/hexdump`, except for the case in the hexdump module configuration where **use-harddisk** is enabled and the **directory** option under the **hexdump file** is to a custom

value. For example, if the **directory** option is set to a value "abc" then the target location for the PCAP file will be: `/hd_raid/records/hexdump/abc/`.

In this feature implementation, a predefined location is set for PCAP files.

- To make sure that `/records/pcap` directory is not populated when issues are encountered with the use of **use-harddisk** and **hexdump module** configurations.
- For regular cleanup from `/hd_raid/records/hexdump` directory.

File Transfer to External Location

Once the files have been copied to the hard disk, they can be copied over to an external server using the command: **transfer-mode** option under the **hexdump** command in the **hexdump-module** configuration.

Apart from **transfer-mode**, other relevant options under **hexdump** can be used for external file transfer. Operators can use these commands to avoid excessive storage during fastpath processing.

Limitations

Some of the known limitations of the monitor subscriber feature are:

- This feature does not support SR/ICSR.
- Max of 4 mon sub sessions can be enabled per UPF.
- Monitoring for a given IMSI should not be enabled from both the SMF and the UP console.
- A combo call consists of 2 mon sub-sessions since it involves monitoring 2 PDNs (SXA and N4 legs with same IMSI but unique Call IDs).
- Incoming uplink packets (with GTPU) are not captured in VPP ingress in this phase.
- Restarting a trace immediately after quitting may result in fastpath files in `/records/pcap` the directory to be overwritten. Therefore, restart the session after a few seconds.
- When a MonSub trace stops, the tear down process may take a few seconds, so it is recommended to wait. It takes a maximum of (5 seconds, hexdump poll timer value in sec) before toggling the MonSub trace to start. Else, the operators may observe MAX TRACING SESSIONS REACHED momentarily.
- Monitor Subscriber fastpath sessions show CLI does not display the sessions that are being stopped. Hence, there is a transient period, where the new MonSub sessions can be rejected due to maximum sessions reached. However, show CLI shows fewer sessions. Therefore, wait for some time before starting a new MonSub trace session.
- Changing fastpath configuration options is only possible when **UP Pcap Trace** is set to OFF.
- When MT=ON in the Multi-PDN, then once MT=OFF, new PDN tracing is not started due to MAX TRACING REACHED, and then all other tracing is STOPPED. It happens because the first new PDN tracing starts and then all previous PDNs were STOPPED for MT=OFF case.
- Do not launch the same UE MonSub sessions from different CLIs.
- In slowpath PCAP, the egress DL packets do not show the GTP-U header, because the functionality to add GTP-U is available in fastpath. Hence, the ingress and egress DL packets show the duplicates, unless there are some packet modifications like HTTP X-headers applied over the ingress packets.

- Toggling C and D options does not impact the PCAP captures in UPF.
- For Multi-PDN, the fastpath file names do not use the Call ID. As by definition, the multi-PDN case has more than one call ID and hence a higher-level configuration such as IMSI is more suitable for naming the files.
- Only the named options that are explicitly mentioned in this document are supported from the *hexdump-module* configuration.
- Number of streams that can be traced in fastpath is limited to 5000. A stream is defined as a TCP or UDP flow. It includes source IP address, destination IP address, source port, and destination port, transport protocol such as, TCP or UDP.
- Fastpath packets cannot be streamed to an external server. They are stored on the hard-disk and transferred either manually or by using **transfer-mode** options.
- The UP PCAP trace must be set to ON to capture fastpath and slowpath PCAP files.
- MonSub CLI option '`<SPACE> Pause`' is only to pause console events. There is no impact on other tracing events (slowpath PCAP, fastpath PCAP, and protocol packets tracing in a text file in hexdump format) with this option.
- The UP trace PCAP file does not contain the initial PFCP Sx Request/Response, due to race condition.
- The ICMP Packets and first packets of TCP and UDP streams flow through both slowpath and fastpath. Default values of GTPU (option 26) and User L3 (Option 19) are set to OFF. As a result, these packets are not captured in slowpath captures. If Option 26 is set to ON, then these packets are captured in slowpath PCAP captures. Option 19 has no effect on slowpath PCAP capture.
- Data Events flag must be set to ON, to capture fastpath and slowpath PCAP files.
- The MonSub tracing is not supported for option **Next-SAEGW Call** on UP.
- The MonSub tracing is not supported for option **Next call by APN** for Pure-S call type.
- On an ASR-5500 setup with the default value of poll-timer, all the packets may not be captured due to a known issue. To avoid rejection for a large number of packets, change the poll-timer value to the lowest possible (10 ms).
- If context replacement occurs (if the same subscriber reattaches without a detach), then the slowpath captures for the new call remain in the old slowpath files.

Configuring the Hexdump Module for MonSub in UPF

Configuring MonSub Poll Timer

Use this configuration to set the frequency of PCAP file capture check.

```
configure
  context context_name
    hexdump-module
      hexdump monitor-subscriber-poll-timeout poll_timer_value
    end
```

NOTES:

- **hexdump monitor-subscriber-poll-timeout** : This option specifies how frequently the check for newly captured PCAP files in the volatile storage must be done before they are copied to persistent storage.
- *poll_timer_value*: Specifies the poll timer value in milliseconds. It must be an integer in the range of 10 ms to 60 seconds. Default: 30 seconds.



Note The timer should not be configured with a value less than 5 seconds.

- This option is only applicable when MonSub is enabled for the products that have fastpath functionality - PGW, SAEGW on ASR-5500 and VPC-SI.

Configuring MonSub File Name

Use the following configuration to specify the file name of the PCAP file which contains IMSI, Call ID, or Username.

configure

```

context context_name
  hexdump-module
    file rotation { num-records number | tariff-time minute minutes hour
hours | time seconds | volume bytes | monitor-subscriber-file-name { imsi |
username | call-id }
    end

```

NOTES:

- **monitor-subscriber-file-name { imsi | username | call-id }**: This option specifies if the name of the captured PCAP files will contain IMSI, Call Id or Username. This option is only applicable on products that have fastpath functionality (PGW, SAEGW on ASR 5500 and VPC-SI) AND only when Monitor Subscriber functionality is enabled. Default: IMSI.
- **rotation { num-records number | tariff-time minute minutes hour hours | time seconds | volume bytes }**: Specifies when to close a hexdump file and create a new one.
 - **num-records number** : Specifies the maximum number of records that should be added to a hexdump file. When the number of records in the file reaches this value, the file is complete.
number must be an integer from 100 through 10240. Default: 1024
 - **tariff-time minute minutes hour hours** : Specifies to close the current hexdump file and create a new one based on the tariff time (in minutes and hours).
minutes must be an integer from 0 through 59.
hours must be an integer from 0 through 23.
 - **time seconds** : Specifies the period of time to wait (in seconds) before closing the current hexdump file and creating a new one.
seconds must be an integer from 30 through 86400. Default: 3600



Important Set the rotation time to 30 seconds.

- **volume bytes** : Specifies the maximum size of the hexdump file (in bytes) before closing it and creating a new one.

bytes must be an integer from 51200 through 62914560. Note that a higher setting may improve the compression ratio when the compression keyword is set to `gzip`. Default: 102400

Monitoring and Troubleshooting

This section provides information regarding monitoring and troubleshooting the Monitor Subscriber feature.

SNMP Traps

The following SNMP trap(s) are added in support of the Monitor Subscriber feature:

- **MonSubProcessInitFailure**: This trap is triggered when MonSub handler process has failed for a particular process and service.



CHAPTER 26

MPLS Support on UPF

- [Feature Summary and Revision History, on page 273](#)
- [Feature Description, on page 274](#)
- [How it Works, on page 274](#)
- [Monitoring and Troubleshooting, on page 281](#)

Feature Summary and Revision History

Summary Data

Table 60: Summary Data

Applicable Product (s) or Functional Area	5G-UPF
Applicable Platforms	VPC-SI
Feature Default Setting	Disabled – Configuration Required
Related Changes in this Release	Not Applicable
Related Documentation	<i>UCC 5G UPF Configuration and Administration Guide</i>

Revision History

Revision Details	Release
Added MPLS support over the N9 interface.	2023.02.0
Added MPLS support over the N6 interface.	2023.01.0
First introduced.	2022.04.0

Feature Description

Multiprotocol Label Switching (MPLS) is a protocol that uses labels to route packets instead of using IP addresses. UPF supports MPLS to switch MPLS traffic using VPP as the data plane forwarder.

On ASR 5500, the NP4c network processor generates and processes MPLS traffic. On VPC-DI, IFTask generates and processes MPLS traffic.

VPC-SI uses VPP as the data plane forwarder. VPP encapsulates and decapsulates subscriber traffic with MPLS labels. VPP provides support for multiple data plane features that include the MPLS stack as a separate graph node. This feature helps to differentiate between different customer VRFs and support corporate APNs having different addressing models and requirements.

UPF supports MPLS encapsulation over the following interfaces for 5G deployments using VPP:

- N6—N6 is the interface between UPF and data network (DN).
- N9—The N9 interface connects two UPFs. It is the interface between Intermediate I-UPF (Visited) and UPF Session Anchor (Home).

The following figure depicts the different interfaces used for MPLS encapsulation in UPF.

Figure 19: MPLS Interfaces

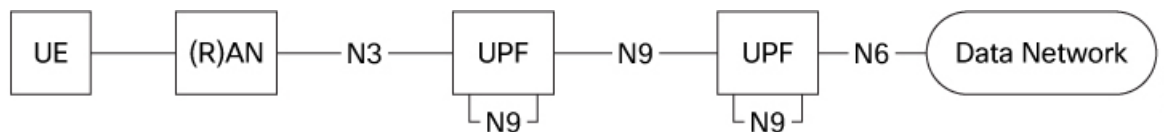

523196

UPF supports the following functionalities for MPLS:

- Uses VPP MPLS stack to send the MPLS labeled packet.
- Uses VPP MPLS stack to process the incoming labeled MPLS packet.
- Uses only MP-BGP as the label distribution protocol.
- VPPCTL CLI commands display the FTN, FIB, and ILM tables that are in VPP, for debugging and comparing values with boxer configuration.

How it Works

This section briefly describes how the MPLS feature works on UPF.

The VPP forwarder supports all existing functionalities for MPLS packet processing with its own MPLS stack. The VPP MPLS stack is configured with the appropriate FTN (FEC To NHLFE), forwarding information base (FIB) table, and incoming label map (ILM) table. The egress generates the MPLS packet with the correct MPLS header. It also processes the incoming MPLS packet and switches the packet to the appropriate VRF table based on the incoming label.

VPC-SI also supports VPNv6 as described in RFC 4659 – *BGP-MPLS IP Virtual Private Network (VPN) Extension for IPv6 VPN*.

Deploying UPFs using the N9 Interface

The 5G Core UPF can deploy two UPFs in series through the N9 interface. The N9 interface connects two UPFs between Intermediate I-UPF and UPF Session Anchor. To provide complete mobility with a stable IP anchor across the whole network, the two UPFs are connected depending on the operator network configuration.

Both upstream and downstream traffic between the UPFs is in the form of GTP-U packets. To support MPLS over the N9 interface, the L3 routers present between the two UPFs are capable of advertising BGP routes and labels to the UPFs.

In the upstream direction, I-UPF receives the GTP-U packets from gNodeB and modifies the content of the GTP-U header based on the destination (anchor) UPF. Based on the lookup of the IP header, MPLS encapsulation occurs to encapsulate the GTP-U packet. The MPLS label that needs to be inserted will be received through BGP from the intermediate L3 devices between UPFs. At the anchor UPF, the MPLS header gets decapsulated and transmitted as an IP packet towards the PDN.

In the downstream direction, MPLS encapsulation occurs in the anchor UPF after the IP packet received from PDN is encapsulated by a GTP-U header. This MPLS header is then decapsulated in I-UPF and the corresponding GTP-U packet is then transmitted to gNodeB.

In the following scenarios, UPF moves the N9 interface to a VRF and establishes a VPNv4 or VPNv6 AF BGP neighborhood:

- When the N3 and N9 interfaces share the same physical interface.
- When the N3 and N9 interfaces are separated.

MPLS-CE Connected to PE

The VPC-SI functions as an MPLS-CE (Customer Edge) network element connected to a Provider Edge (PE) Label Edge Router (LER), which in turn connects to the MPLS core as per RFC 4364.

The following figure illustrates the MPLS-CE to PE connection:

Figure 20: VPC-SI MPLS-CE to PE

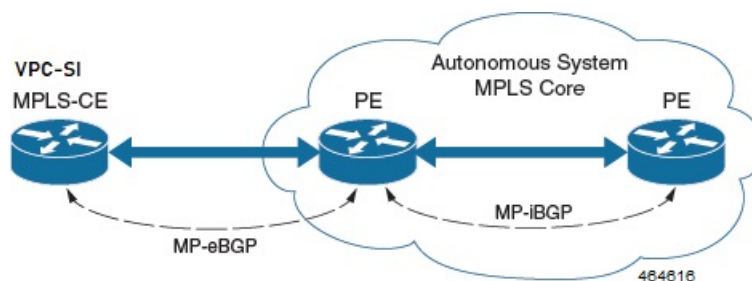

The MPLS-CE functions like a PE router within its own Autonomous System (AS). It maintains Virtual Routing and Forwarding (VRF) routes and exchanges VPN route information with the PE through an MP-eBGP (Multi Protocol external BGP) session.

The PE is also configured with VRFs and exchanges VPN routes with other PE in its AS through MP-iBGP (Multi Protocol internal BGP) connection and MPLS-CE through an MP-eBGP connection.

The EBGP connection allows the PE to change next-hop IP addresses and labels in the routes learnt from IBGP peers before advertising them to the MPLS-CE. The MPLS-CE uses only MP-eBGP to advertise and learn routes. Label Distribution Protocol (LDP) and Resource Reservation Protocol (RSVP) are not required

because of direct-connect EBGP peering. The MPLS-CE pushes or pops a single label (learnt over the MP-eBGP connection) to or from the PE.

Sample Configuration

MPLS N6 Configuration

The following is a sample configuration to configure the basic MPLS feature with N6 interface on UPF:

```
context egress
  ip vrf MPN00001
    ip maximum-routes 100
  #exit
mpls bgp forwarding
router bgp 64455
  neighbor 172.31.35.29 remote-as 65200
  neighbor 172.31.35.29 timers keepalive-interval 60 holdtime-interval 300
  neighbor 172.31.35.29 update-source 172.31.35.4
  neighbor 172.31.35.29 fall-over bfd
  neighbor 172.31.35.29 srp-activated-soft-clear
  address-family ipv4
    redistribute connected
    redistribute static
  #exit
  address-family vpv4
    neighbor 172.31.35.29 activate
    neighbor 172.31.35.29 send-community extended
  #exit
  address-family vpv6
    neighbor 172.31.35.29 activate
    neighbor 172.31.35.29 send-community extended
  #exit
  address-family ipv6
    redistribute connected
    redistribute static
  #exit
  ip vrf MPN00001
    route-distinguisher 64455 11100001
    route-target both 64455 11100001
  #exit
  address-family ipv4 vrf MPN00001
    redistribute connected
  #exit
  address-family ipv6 vrf MPN00001
    redistribute connected
  #exit
interface N6-11
  ip address 172.31.35.4 255.255.255.224
  ip mtu 1504
  bfd interval 999 min_rx 999 multiplier 3
#exit
interface N6-12
  ip address 172.31.35.35 255.255.255.224
  ip mtu 1504
  bfd interval 999 min_rx 999 multiplier 3
#exit
interface loop_MPN00001 loopback
  ip vrf forwarding MPN00001
  ip address 2.2.4.2 255.255.255.255
#exit
```

MPLS N9 Configuration

The following is a sample configuration to configure the MPLS feature with N9 interface on UPF:

```

context SAEGW
  ip vrf mpls-vrf-1
  #exit
  ip vrf mpls-vrf-2
  #exit
  mpls bgp forwarding
    bfd-protocol
    #exit
  ip prefix-list name up seq 15 permit 50.50.41.4/32
  ip prefix-list name up seq 20 permit 50.50.41.5/32
  ip prefix-list name up seq 25 permit 50.50.41.6/32
  ip prefix-list name up seq 40 permit 50.50.41.7/32
  ip prefix-list name n9-up1 seq 50 permit 60.60.41.5/32
  ip prefix-list name n9-up1 seq 55 permit 60.60.41.6/32
  route-map up_routes1 permit 10
    match ip address prefix-list n9-up1
    #exit
  route-map up_routes permit 10
    match ip address prefix-list up
    #exit
  ip vrf mpls-vrf-1
  route-distinguisher 61601 11100001
  route-target export 61601 11100001
  route-target import 61606 11100001
  route-target import 65200 11100001
  #exit
  address-family ipv4 vrf mpls-vrf-1
    redistribute connected
    redistribute static
    #exit
  address-family ipv6 vrf mpls-vrf-1
    redistribute connected
    redistribute static
    #exit
  ip vrf mpls-vrf-2
  route-distinguisher 61601 11100002
  route-target export 61601 11100002
  route-target import 61606 11100002
  route-target import 65200 11100002
  #exit
  address-family ipv4 vrf mpls-vrf-2
    redistribute connected
    redistribute static
    #exit
  address-family ipv6 vrf mpls-vrf-2
    redistribute connected
    redistribute static
    #exit
  #exit
  interface gn-mpls-n9-ingress
    ip address 172.31.40.5 255.255.255.224
    ip mtu 1504
    bfd interval 999 min_rx 999 multiplier 3
    #exit
  interface n9-ingress-hupf loopback
    ip vrf forwarding mpls-vrf-1
    ip address 60.60.41.5 255.255.255.255
    #exit
  user-plane-service user_plane_svc
    associate gtpu-service pgw-gtpu upf-ingress
    associate gtpu-service n9-ingress upf-ingress interface-type n9

```

```

associate gtpu-service sgw-gtpu-ingress-phazr sgw-ingress
associate gtpu-service sgw-gtpu-egress sgw-egress
associate gtpu-service SxC cp-tunnel
associate sx-service sx-svc
associate fast-path service
associate control-plane-group SAEGW
associate userplane-load-control-profile LCP
associate userplane-overload-control-profile OLCP
#exit

```

VPN-related CLI Commands

UPF supports the VPN-related features and functions across several CLI command modes. The following tables identify commands associated with configuration and monitoring of VPN-related functions.

Table 61: VPN-Related Configuration Commands

CLI Mode	Command	Description
BGP Address-Family (IPv4/IPv6) Configuration Mode	neighbor ip_address activate	Enables the exchange of routing information with a peer router.
BGP Address-Family (IPv4/IPv6) Configuration Mode	neighbor ip_address send community { both extended standard }	Sends the community attributes to a peer router (neighbor).
BGP Address-Family (IPv4/IPv6) Configuration Mode	redistribute connected	Redistributes routes into BGP from another protocol as BGP neighbors.
BGP Address-Family (VPNv4) Configuration Mode	neighbor ip_address activate	Enables the exchange of routing information with a peer router.
BGP Address-Family (VPNv4) Configuration Mode	neighbor ip_address send community { both extended standard }	Sends the extended-community attribute to a peer router. In VPN, route-distinguisher and route-target are encoded in the BGP extended-community. This command sends BGP routes with the extended community to a neighbor.
BGP Address-Family (VRF) Configuration Mode	neighbor ip_address activate	Enables the exchange of routing information with a peer router.
BGP Address-Family (VRF) Configuration Mode	neighbor ip_address send community { both extended standard }	Sends the extended-community attribute to a peer router. In VPN, route-distinguisher and route-target are encoded in the BGP extended-community. This command sends BGP routes with the extended community to a neighbor.
BGP Address-Family (VRF) Configuration Mode	redistribute connected	Redistributes routes into BGP from another protocol as BGP neighbors.

CLI Mode	Command	Description
BGP Configuration Mode	address-family { ipv4 vrf <i>vrf_name</i> vpn4 }	Enables the exchange of IPv4 VRF routing information. There is a different mode for each address-family.
BGP Configuration Mode	address-family { ipv6 vrf <i>vrf_name</i> vpn6 }	Configures a VPNv6 address family and IPv6 VRF routing in BGP.
BGP Configuration Mode	ip vrf <i>vrf_name</i>	Adds a VRF to BGP and switches to the VRF Configuration mode to allow configuration of BGP attributes for the VRF.
BGP IP VRF Configuration Mode	route-distinguisher { <i>as_value</i> <i>ip_address</i> } <i>rd_value</i>	Assigns a Route Distinguisher (RD) for the VRF. The RD value must be a unique value on the router for each VRF.
BGP IP VRF Configuration Mode	route-target { both import export } { <i>as_value</i> <i>ip_address</i> } <i>rd_value</i>	Adds a list of import and export route-target extended communities to the VRF.
Context Configuration Mode	ip pool <i>pool_name</i> <i>addr_range</i> vrf <i>vrf_name</i> [mpls-label input <i>inlabel1</i> output <i>outlabel1</i> <i>outlabel2</i>]	Configures a pool into the specified VRF. Specify this command with the Next-Hop parameter. <i>inlabel1</i> is the MPLS label that identifies inbound traffic destined for this pool. <i>outlabel1</i> and <i>outlabel2</i> specify the MPLS labels to be added to packets sent for subscribers from this pool.
Context Configuration Mode	ip vrf <i>vrf_name</i>	Creates a VRF and assigns a VRF-ID. A VRF is created in the router.
Context Configuration Mode	ipv6 pool <i>pool_name</i> vrf <i>vrf_name</i>	Associates the pool with that VRF. Note: By default the configured IPv6 pool is associated with the global routing domain.
Context Configuration Mode	mpls bgp forwarding	Globally enables MPLS Border Gateway Protocol (BGP) forwarding.

CLI Mode	Command	Description
Context Configuration Mode	mpls exp <i>value</i>	Sets the default behavior as Best Effort using a zero value in the 3-bit MPLS EXP header. This value applies to all the VRFs in the context. The default behavior is to copy the DSCP value of mobile subscriber traffic to the EXP header, if there is no explicit configuration for DSCP to EXP (via the mpls map-dscp-to-exp dscp n exp m command). mpls exp disables the default behavior and sets the EXP value to the configured <i>value</i> .
Context Configuration Mode	mpls ip	Globally enables the MPLS forwarding of IPv4 packets along normally routed paths.
Context Configuration Mode	radius change-authorize-nas-ip <i>ip_address</i> { encrypted key } <i>value</i> port <i>port_num</i> mpls input <i>inlabel</i> output <i>outlabel1 outlabel2</i>	Configures COA traffic to use the specified MPLS labels. <i>inlabel</i> identifies the inbound COA traffic. <i>outlabel1</i> and <i>outlabel2</i> specify the MPLS labels to add to the COA response. <i>outlabel1</i> is the inner output label and <i>outlabel2</i> is the outer output label.
Ethernet Interface Configuration Mode	mpls ip	Enables dynamic MPLS forwarding of IP packets on this interface.
Exec Mode	clear ip bgp peer	Clears BGP sessions.

Table 62: VPN-Related Monitoring Commands

CLI Mode	Command	Description
Exec Mode show Commands	show ip bgp neighbors	Displays information regarding BGP neighbors.
Exec Mode show Commands	show ip bgp vpnv4 { all route-distinguisher vrf }	Displays all VPNv4 routing data, routing data for a VRF or a route-distinguisher.
Exec Mode show Commands	show ip bgp vpnv6	Displays contents of VPNv6 routing table.
Exec Mode show Commands	show ip bgp vpnv6 { all route-distinguisher vrf }	Displays all VPNv6 routing data, routing data for a VRF or a route-distinguisher.
Exec Mode show Commands	show ip fib table-id <i>table_id</i>	Displays information for FIB table.

CLI Mode	Command	Description
Exec Mode show Commands	show ip pool	Displays pool details including the configured VRF.
Exec Mode show Commands	show mpls cross-connect	Displays MPLS cross-connect information. MPLS tunnel cross-connects between interfaces and Label-Switched Paths (LSPs). LSP connects two distant interface circuits of the same type through MPLS tunnels.
Exec Mode show Commands	show mpls fib table <i>table_id</i>	Displays MPLS forwarding information base (FIB) table information.
Exec Mode show Commands	show mpls ftn [vrf <i>vrf_name</i>]	Displays MPLS FEC-to-NHLFE (FTN) table information.
Exec Mode show Commands	show mpls ftn [vrf <i>vrf_name</i>]	Displays the contents of the MPLS FTN table for a specified VRF.
Exec Mode show Commands	show mpls ilm [all label <i>label_value</i>]	Displays MPLS Incoming Label Map (ILM) table information.
Exec Mode show Commands	show mpls nexthop-label-forwarding-entry	Displays MPLS Next-Hop Label Forwarding Entry (NHLFE) table information.

Monitoring and Troubleshooting

This section provides information regarding the CLI command to monitor and troubleshoot the feature.

Show Commands and Outputs

This section provides information regarding show commands and their outputs in support of this feature.

show mpls ftn vpp

The output of this command contains the "vpp" field that displays the configured VPP dataplane values in the VPP dataplane forwarder. Use this command for debugging purposes.

- vpp
 - all-vrf
 - summary
 - vrf

■ show mpls ftn vpp



CHAPTER 27

Multiple cnSGW Support

- [Feature Summary and Revision History, on page 283](#)
- [Feature Description, on page 284](#)
- [How it Works, on page 284](#)
- [Configuring Multiple SMF/cnSGWs, on page 284](#)
- [Monitoring and Troubleshooting, on page 285](#)

Feature Summary and Revision History

Summary Data

Table 63: Summary Data

Applicable Product (s) or Functional Area	5G-UPF
Applicable Platforms	VPC-SI SMI
Feature Default Setting	Disabled – Configuration Required
Related Changes in this Release	Not Applicable
Related Documentation	<i>UCC 5G UPF Configuration and Administration Guide</i>

Revision History

Revision Details	Release
First introduced.	2021.02.0

Feature Description

The Multiple SMF/cnSGW Support feature enables a single UPF to establish multiple N4/Sx interfaces with cnSGWs and their paired SMFs. Integration of multiple SMF and cnSGW combinations with a single UPF results in optimal usage of resources.

Architecture

The following illustration depicts the architecture of multiple cnSGWs/SMFs.

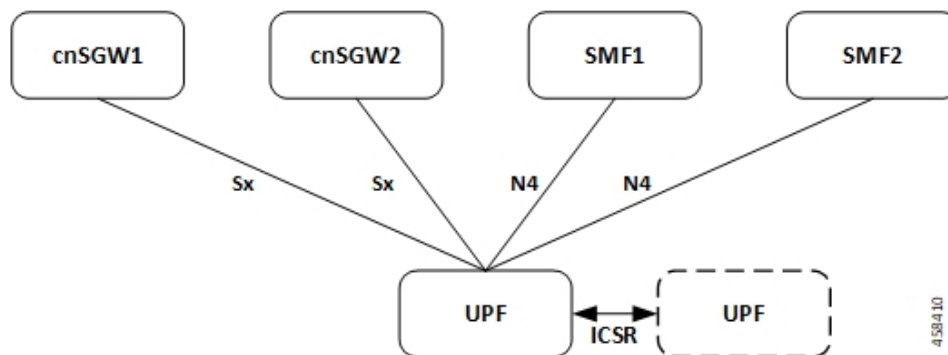

Relationship to Other Features

The Multiple cnSGW Support feature is related to *Multiple N4/Sx Interface* feature.

How it Works

The functionality of Multiple cnSGW feature involves:

- Single UPF has multiple N4/Sx interface associations with SMF/cnSGWs.
- There's no slicing of configuration in UPF per individual SMF.
- Cumulatively, a maximum of four peers—combination of cnSGW/SMF or individual cnSGW/SMF as per the need—are connected to a single UPF.
- Individual N4/Sx association release purges sessions of the impacted peer.
- UPF redundancy works seamlessly.
- All cnSGWs paired with a UPF is associated with a single user plane service.

Configuring Multiple SMF/cnSGWs

This section provides information about CLI commands that are available in support of this feature.

Configuring Multiple SMF/cnSGWs on UPF

Use the following CLI commands to configure multiple SMF/cnSGWs on UPF by adding multiple peer node under Control Plane Group Configuration mode.

```
configure
  user-plane-service service_name
    associate control-plane-group group_name
  control-plane-group group_name
    peer-node-id ipv4-address ipv4_address interface n4
    peer-node-id ipv4-address ipv4_address interface n4
    peer-node-id ipv4-address ipv4_address
    peer-node-id ipv4-address ipv4_address
  end
```

Monitoring and Troubleshooting

This section provides information about monitoring and troubleshooting the Multiple cnSGW feature.

Show Commands and/or Outputs

This section describes the show commands that are available in support of this feature.

show subscribers user-plane-only full all

The output of this CLI command is enhanced to display the corresponding Control Plane address.

show sx peers

The output of this CLI command is enhanced to display the peer ID with corresponding number of sessions.

show sx peers



CHAPTER 28

Multiple N4/Sx Interfaces

- [Feature Summary and Revision History, on page 287](#)
- [Feature Description, on page 288](#)
- [How it Works, on page 288](#)
- [Configuring Multiple N4/Sx Interfaces, on page 289](#)
- [Monitoring and Troubleshooting, on page 290](#)

Feature Summary and Revision History

Summary Data

Table 64: Summary Data

Applicable Product (s) or Functional Area	5G-UPF
Applicable Platforms	VPC-SI SMI
Feature Default Setting	Disabled – Configuration Required
Related Changes in this Release	Not Applicable
Related Documentation	<i>UCC 5G UPF Configuration and Administration Guide</i>

Revision History

Revision Details	Release
UPF supports the following functionality: <ul style="list-style-type: none">• Multiple N4/Sx interfaces with any number of control plane NFs• Maximum configuration of 18 Nx/Sx peer nodes	2023.04.0

Revision Details	Release
First introduced.	2021.01.0

Feature Description

Table 65: Feature History

Feature Name	Release Information	Description
Support for Multiple N4/Sx Interfaces	2023.04	A single UPF can establish multiple N4 or Sx interfaces with any number of control plane network functions such as SMF, cnSGWc, SAEGW-C, PGW-C, and SGW-C. The maximum number of supported N4/Sx peer nodes has been increased from 16 nodes to 18 nodes in this release.

The Multiple N4/Sx Interfaces feature enables a single UPF to establish multiple N4 or Sx interfaces with any number of control plane NFs. The control plane NFs include SMF, SAEGW-C, PGW-C, SGW-C, and cnSGWc.

The integration of multiple control plane nodes with a single UPF results in optimal usage of resources. UPF supports a maximum configuration of 18 N4 or Sx peer nodes per control-plane-group.

Architecture

The following figure illustrates the architecture of multiple N4 interfaces with a single UPF.

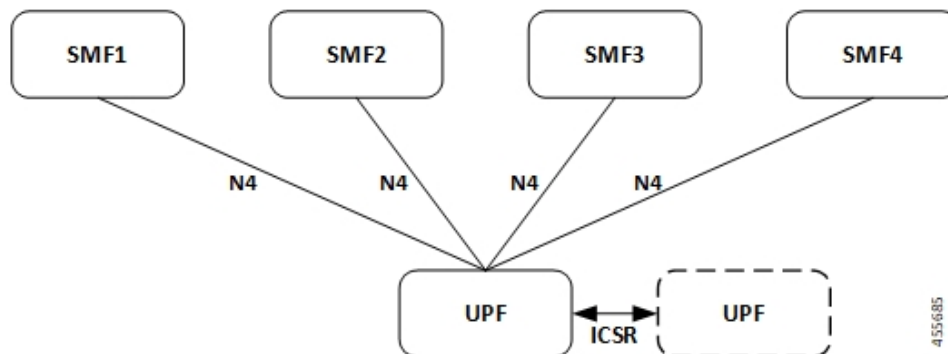

How it Works

The functionality of the Multiple N4/Sx Interfaces feature involves:

- The ECS/ACS configuration at UPF is a union of all individual control plane specific configurations.

For example:

SMF1 has rulebase *RB1* and no *RB2*

SMF2 has rulebase *RB2* and no *RB1*

The UPF has both rulebase, *RB1* and *RB2* to cater the sessions from *RB1* and *RB2*.

- There is no slicing of configuration in UPF per individual SMF.
- A maximum number of four SMF peers are connected to a single UPF.
- Overlapping IP pools from multiple SMFs are segregated based on the VRF ID.
- Individual N4 association release purges sessions of the impacted SMF peer.
- UPF redundancy works seamlessly.
- During any conflict with different SMF configurations, it will be installed in the sequence of configured CLIs and not resolved at UPF.

Configuring Multiple N4/Sx Interfaces

This section provides information about CLI commands that are available in support of this feature.

Configuring Multiple Peer Nodes

To configure multiple peer nodes on UPF, use the following sample configuration:

```
configure
  user-plane-service service_name
    associate control-plane-group group_name
  control-plane-group group_name
    peer-node-id ipv4-address ipv4_address interface n4
    peer-node-id ipv4-address ipv4_address interface n4
    peer-node-id ipv4-address ipv4_address
    . . .
    . . .
    . . .
  end
```

NOTES:

- **peer-node-id ipv4-address *ipv4_address***—Specify the IPv4 address of the peer node.
- **interface n4**—Identify the N4 interface.
- A maximum number of 18 peer nodes can be configured per control plane group.

When the limit exceeds beyond 18 peer nodes, the following error message displays:

Failure: Maximum Control Plane Group Nodes Limit exceeded!

Monitoring and Troubleshooting

This section provides information about monitoring and troubleshooting the Multiple N4/Sx Interface feature.

Show Commands and/or Outputs

This section describes the show commands that are available in support of this feature.

show ip chunks

The output of this CLI command is enhanced to display the IP pools pushed to the UPF from multiple SMFs in Gi context.

show ipv6 chunks

The output of this CLI command is enhanced to display the IPv6 pools pushed to the UPF from multiple SMFs in Gi context.

show subscribers user-plane-only full all

The output of this CLI command is enhanced to display the corresponding Control Plane address.

show sx peers

The output of this CLI command is enhanced to display the peer ID with corresponding number of sessions.

show user-plane-service statistics peer-address <address>

The output of this CLI command is enhanced to display per peer statistics in SMF.



CHAPTER 29

Nexthop Forwarding Support

- [Revision History](#), on page 291
- [Feature Description](#), on page 291
- [How It Works](#), on page 291
- [Configuring Next Hop Forwarding Support](#), on page 296
- [VLAN Segmentation Using Next Hop Forwarding](#), on page 300
- [Monitoring and Troubleshooting](#), on page 304

Revision History

Table 66: Revision History

Revision Details	Release
First introduced.	2022.01.0

Feature Description

The next hop forwarding is the process of forwarding the packets to an adjacent router or device. The next hop router is the next closest or optimal IP for a packet in the destination path.

In the uplink direction, the UE and the GI IP can be in a different subnet. The routing path in UPF is defined to allow the uplink packet to be forwarded accordingly.

How It Works

Architecture

The following illustration provides an overview of Next hop forwarding feature.

Figure 21: Next hop forwarding

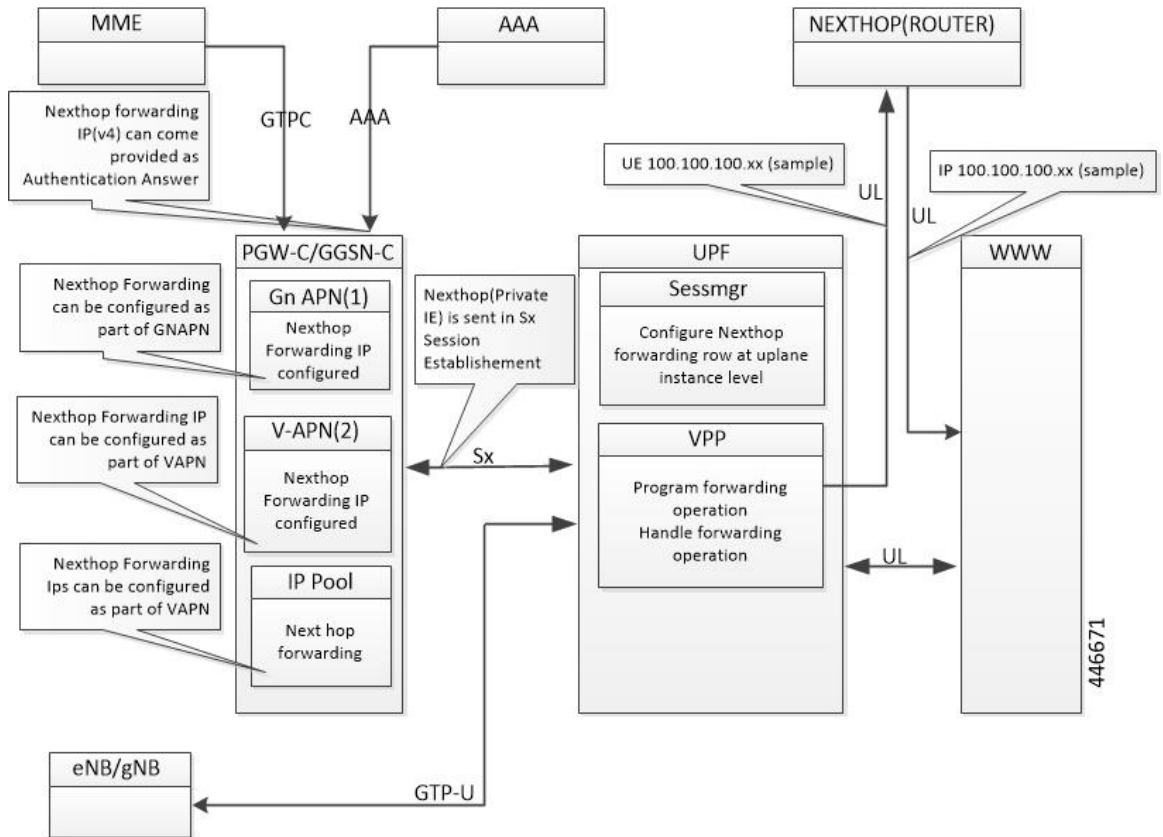

You can configure Next hop IP address at the SMF under DNN profile or IPAM profile. During PDU Establishment, the SMF relays the IPv4/IPv6 address over the N4 interface in the NEXT HOP IP private IE in a PFCP Session Establishment Request.

You can also configure the Next hop IP address at the UPF through Charging-Action.



Note When Next hop address is provided by both SMF and UPF Charging-Action, the UPF Charging-Action Next hop address takes precedence.

Configuration Priority

S. No.	Configuration	Priority
1.	UPF (Charging Action)	1
2.	DNN profile	2
3.	IP Pool	3

Configuration Use Cases

Case	IP Type	DNN	IP Pool	UPF (Charging Action)	Next hop IP Selection
Next hop supplied only in DNN	IPv4	209.165.201.18	Not configured	Not configured	Next hop Address is selected from DNN: IPv4: 209.165.201.18 IPv6: 8001::10
	IPv6	8001::10	Not configured		
Next hop supplied only in IP pool	IPv4	Not configured	209.165.201.19	Not configured	Next hop Address is selected from IP Pool: IPv4: 209.165.201.19 IPv6: 8001::10
	IPv6	Not configured	8001::10		
IPv4 and IPv6 configured in DNN and IP pool	IPv4	209.165.201.18	209.165.201.19	Not configured	Next hop Address is selected from DNN: IPv4: 209.165.201.18 IPv6: 9001::3
	IPv6	9001::3	8001::10		
IPv6 configured in DNN and IPv4 in IP pool	IPv4	Not configured	209.165.201.19	Not configured	Next hop IPv4 is selected from IP pool: 209.165.201.19 Next hop IPv6 selected from DNN : 8001::10
	IPv6	8001::10	Not configured		
IPv6 configured in DNN, IPv4 in IP pool, and IPv4 in UPF Charging Action	IPv4	209.165.201.18	209.165.201.19	209.165.201.20	Next hop Address is selected from UPF (CA): 209.165.201.20
	IPv6	8001::10	Not configured	Not configured	
IPv6 configured in DNN, IPv4 in IP pool, and IPv6 in UPF Charging Action	IPv4	209.165.201.18	209.165.201.19	Not configured	Next hop Address is selected from UPF(CA) : 9001::10
	IPv6	8001::10	Not configured	9001::10	

Interface

The following Private IEs are introduced in Sx/N4 Session Establishment message.

2 3 8	PFCP _IE_ NEXT HOP	PFCP_IE_NEXTHOP							Sx/N4 Session Establish ment Request	Private IE: UPF: nexthop forward ing support- IPv4 /IPv6 address	
		BITS									
		Octets	7	6	5	4	3	2	1		
		1 to 2	Type = 238 (decimal)								
		3 to 4	Length = n								
		5 to 10	PFCP_IE_NEXTHOP_ID								
		11-14	PFCP_IE_NEXTHOP_IP								

2 3 9	PFCP _IE_ NEXIHOP _ID	PFCP_IE_NEXTHOP_ID							1. Inside Create FAR IE of Sx Session Establish ment Request	Private IE : UPF: nexthop forward ing support- IPv4 /IPv6 address	
		BITS							2. Inside PFCP _IE_ NEXIHOP IE of Sx/N4 Session Establish ment Request		
		Octets	7	6	5	4	3	2	1		
		1 to 2	Type = 239 (decimal)								
		3 to 4	Length = 5								
		5 to 10									
									PFCP _IE_ NEXIHOP of Sx/N4 Session Establish ment Request		

2 4 0	PFCP_IE_NEXTHOP_IP	PFCP_IE_NEXTHOP_IP										
		Bits								PFCP_IE_NEXTHOP of Sx/N4 Session Establishment Request	Private IE : UPF: nexthop forwarding support- IPv4/ IPv6 address	
		Octets	7	6	5	4	3	2	1			
		1 to 2	Type = 240 (decimal)									
		3 to 4	Length = n									
		5	spare				V4	V6				
		m to m+3	IPv4 Address									
		p to p+15	IPv6 Address									

The following is a sample output of SX_SESSION_ESTABLISHMENT_REQUEST in which the SMF relays the Next hop IP to the UPF.

```

CREATE FAR:
  Type: 3
  Value:
    FAR ID:
      Type: 108
      Value: 0x80000002
  APPLY ACTION:
    Type: 44
    Value:
      DROP: 0
      FORW: 1
      BUFF: 0
      NOCP: 0
      DUPL: 0
  FORWARDING PARAMETERS:
    Type: 4
    Value:
      DESTINATION INTERFACE:
        Type: 42
        Value: CORE (1)
      PDN INSTANCE:
        Type: 22
        Value: intershat
      INNER PACKET MARKING:
        Type: 220
        TOS/TRAFFIC CLASS: 0xB8 0xFC

```

NextHop ID:
Value: 0x0001

```

CREATE TRAFFIC ENDPOINT:
  Type: 127 Length: 20
  Value:
    Traffic Endpoint ID:
      Type: 131 Length: 1
      Value: 0x0004
      Hex: 0083 0001 04

```

```

Local F-TEID:
  Type: 21 Length: 1
  Value:
    CH: 1
    IPv4: 0
    IPv6: 0
    CHID: 0
    Hex: 0015 0001 04
Bearer Info:
  Type: 225 Length: 6
  QCI: 5
  ARP: 84
  Charging ID: 5592407
  Hex: 00E1 0006 0554 0055 5557
Hex: 007F 0014 0083 0001 0400 1500 0104 00E1
    0006 0554 0055 5557

```

NEXT HOP IP:**Type: 237 Length: 14****Value:****NextHop ID:****Type: 238 Length: 1****Value: 0x0001****Hex: 00EE 0001 01****IP ADDR:****Type: 239 Length: 5****Value:****IPv4: 1****IPv6: 0****IPv4: 209.165.202.150****IPv6:****Hex: 00EF 0005 020F 0F0F 0F****Hex: 00ED 000E 00EE 0001 0100 EF00 0502 0F0F
0F0F**

Limitations

The following are the known limitations of this feature:

- Configuring next hop forwarding through AAA is not supported.
- Next hop address sent on RADIUS and Diameter (Redirect information from PCF) interfaces is not qualified.
- When you configure next hop forwarding in DNN profile and IPAM, the next hop is only seen in Sx Establishment, and not in Create FAR IE of Sx Session Modification Request.

Configuring Next Hop Forwarding Support

Configuring Next Hop Forwarding Through Charging Action

At the UPF, use the following CLI commands to configure Next hop forwarding through Charging Action.

```

configure
  active-charging service service_name
    charging-action charging_action_name
      nexthop-forwarding-address ipv4_address/ipv6_address

```

NOTES:

- **charging-action** *charging_action_name*: Specifies the name of a charging action. *charging_action_name* must be an alphanumeric string of 1–63 characters and can contain punctuation characters. Each charging action must have a unique name.
- **nexthop-forwarding-address** *ipv4_address/ipv6_address*: Configures the next hop forwarding address.

Configuring Next Hop Forwarding Through DNN Profile

At the SMF, use the following CLI commands to configure Next hop forwarding through the DNN profile.

```

configure
  profile dnn intershat
    nexthop-forwarding-address { ipv4 ipv4_address | ipv6 ipv6_address }
  end

```

NOTES:

- **nexthop-forwarding-address** { **ipv4** *ipv4_address* | **ipv6** *ipv6_address* }: Configures the Next hop forwarding address.
 - *ipv4_address*: Configures IPv4 address.
 - *ipv6_address*: Configures IPv6 address (supports colon-separated hexadecimal notation).

Configuring Next Hop Forwarding at IP Pool Through IPAM Profile for IPv4 Addresses

At the SMF, use the following CLI command to configure Next hop forwarding at the IP pool through the IPAM profile for IPv4 addresses.

```

configure
  ipam
    instance instance_id
      address-pool pool_name
        ipv4
          address-ranges
            address-range start_ipv4_address end_ipv4_address
          nexthop-forwarding-address nexthop_forwarding_address
            prefix-range prefix_value length prefix_length
          nexthop-forwarding-address nexthop_forwarding_address
            split-size per-cache number_of_addresses
            split-size per-dp number_of_addresses
          commit

```

NOTES:

- **address-pool** *pool_name*: Specify the name of the address pool. *pool_name* must be a string.
- **ipv4**: Enter the IPv4 mode of the pool.
- **address-ranges**: Specify the starting address of the IPv4 address range. Enter the IPv4 address range and prefix range addresses with the next hop forwarding address.
 - **address-range** *start_ipv4_address end_ipv4_address* **nexthop-forwarding-address** *nexthop_forwarding_address*: Specify the starting and the ending addresses of the IPv4 address range with the next hop forwarding address.
 - **prefix-range** *prefix_value length prefix_length*: Specify the prefix value and the length within the IPv4 address.
 - **nexthop-forwarding-address** *nexthop_forwarding_address*: Specify the next hop forwarding address.
- **split-size per-cache** *number_of_addresses*: Specify the number of IPv4 addresses per chunk for IPAM cache allocation. Specify in the power of 2. The IPAM server consumes this configuration. *number_of_addresses* must be an integer in the range of 2-262144.
- **split-size-per-dp** *number_of_addresses*: Specify the number of IPv4 addresses per chunk for data plane allocation. Specify in the power of 2. The IPAM cache consumes this configuration. *number_of_addresses* must be an integer in the range of 2-262144.

Configuring Next Hop Forwarding at IP Pool Through IPAM Profile for IPv6 Addresses

To configure the IPv6 address with the next hop configuration for IPv6 pools and address ranges, use the following sample configuration:

```
configure
 ipam
   instance instance_id
     address-pool pool_name
       ipv6
         address-ranges
           address-range start_ipv6_address end_ipv6_address
         nexthop-forwarding-address nexthop_forwarding_address
           prefix-range prefix_value length prefix_length
         nexthop-forwarding-address nexthop_forwarding_address
           split-size per-cache number_of_addresses
           split-size per-dp number_of_addresses
         exit
           prefix-range prefix_value length prefix_length
         nexthop-forwarding-address nexthop_forwarding_address
       commit
```

NOTES:

- **address-pool** *pool_name*: Specify the name of the address pool. *pool_name* must be a string.
- **ipv6**: Enter the IPv6 mode of the pool.

- **address-ranges**: Specify the IPv6 address ranges and prefix range addresses with the next hop forwarding address.



Note IANA IPv6 configuration is used by BNG.

- **address-range** *start_ipv6_address end_ipv6_address* : Specify the starting and the ending addresses of the IPv6 address range.
 - **nexthop-forwarding-address** *nexthop_forwarding_address*: Specify the next hop forwarding address.
 - **prefix-range** *prefix_value length prefix_length*: Specify the prefix value and length within the IPv6 address.
 - **nexthop-forwarding-address** *nexthop_forwarding_address*: Specify the next hop forwarding address.
-
- **prefix-ranges** : Specify the prefix ranges of an IPv6 address.



Note SMF supports only IAPD IPv6 configuration.

- **split-size per-cache** *number_of_addresses*: Specify the number of IPv6 addresses per chunk for IPAM cache allocation.
- **split-size-per-dp** *number_of_addresses*: Specify the number of IPv6 addresses per chunk for the data plane allocation.
- **prefix-range** *prefix_value length prefix_length nexthop-forwarding-address nexthop_forwarding_address*: Specify the prefix value and the length within the IPv6 address with the next hop forwarding address.

Configuration Example

The following is an example configuration to configure next hop forwarding at IP pool through IPAM profile for IPv4 addresses:

```
config
  ipam
    instance 1
      address-pool p1
        ipv4
          split-size per-cache 1024
          split-size per-dp 256
        end
```

Following is an example configuration to configure next hop forwarding at IP pool through IPAM profile for IPv6 addresses:

```
ipam
  instance 1
    address-pool ISE-Pool1
    vrf-name ISP
    tags
```

```

dnn cisco_vlan400.com
exit
ipv6
address-ranges
  address-range 1000::1 1000::ffff nexthop-forwarding-address :9001::3
  prefix-range 2607:fc20:1010:: length 98 nexthop-forwarding-address :9001::3
prefix-ranges
  split-size
    per-cache 32768
    per-dp 32768
  exit
  prefix-range 2607:fc20:1010:: length 44 nexthop-forwarding-address :9001::3
exit
exit

```

VLAN Segmentation Using Next Hop Forwarding

Table 67: Feature History

Feature Name	Release Information	Description
VLAN Segmentation of Traffic Using Next Hop Forwarding	2024.01	UPF allows VLAN segmentation using Next Hop Forwarding. UPF sends packets to the VLAN from where the next hop IP is most reachable instead of sending packets to the destination IP. Default Setting: Disabled-Configuration required to enable

Feature Description

UPF supports segmenting the enterprise traffic using Virtual LAN (VLAN). VLANs enable a single physical LAN segment to be further segmented into smaller virtual networks so that the groups of ports are isolated from one another, as if they were on physically different segments. In VLAN segmentation, the UEs belonging to different classes are assigned to different VLANs for traffic isolation.

VLAN Segmentation can be achieved using two methods:

1. Next Hop Forwarding
2. [VLAN Segmentation Using VRF](#)

In the VLAN segmentation using next hop forwarding, the IP pool is mapped with the VLAN tags. This mapping takes place at the SMF. The IP pool is associated with the next hop forwarding address on the N6 interface, which is reachable through the VLAN associated with the IP pool as configured on the Control Center.



Note This feature is supported on both 1-Rack Unit and 3-Rack Unit architectures and can support up to 16 VLANs on the N6 interface.

How it Works

Achieving VLAN segmentation using next hop forwarding follows the given process:

- The SMF sends a N4 Session Establishment Request with the next hop forwarding address to the UPF.
- The UPF associates the next hop forwarding address with the session. This association allows the session management layer on the UPF to program the VPP to perform next hop forwarding of the uplink packets belonging to that session.
- The session manager on the UPF creates the uplink streams in the VPP Fastpath conduit with next hop forwarding operation with appropriate next hop IP. Therefore, the UPF does not look at the actual IP destination route to forward the packets. Rather, it relates the UE's IP address with the next hop IP and forwards the uplink packet on the VLAN from where the next hop IP is reachable.

Enabling VLAN Segmentation Using Next Hop Forwarding

To configure VLAN segmentation on UPF using next hop forwarding, use the following configuration:

```
config
port ethernet slot/port
  no shutdown
  vlan vlan_tag_ID
  no shutdown
  bind interface interface_name context_name
end
context context_name
  { ip | ipv6 } address address subnetmask [ secondary ]
end
```

NOTES:

- **port ethernet slot/port**—Ethernet port or slot that will contain the VLAN tag.
- **no shutdown**—It enables or disables the traffic over a specified VLAN.
- **vlan vlan_tag_ID**—Enters the VLAN configuration mode.
- **no shutdown**—Enables or disables traffic over the current VLAN.
- **bind interface interface_name context_name**—It binds a virtual interface and context to support VLAN service.
- **context context_name**—Configures the context to in which the interface is created.
- **{ ip | ipv6 } address address subnetmask [secondary]**—Maps the IP pools with the configured VLANs. The [secondary] keyword assigns multiple IP addresses to the interface.

Configuration Example

To enable the VLAN segmentation using next hop forwarding on UPF, use the following sample configuration:

```
config
port ethernet 1/10
  no shutdown
```

```

vlan 400
  no shutdown
  bind interface N6_interface1 ISP
#exit
vlan 401
  no shutdown
  bind interface N6_interface2 ISP
#exit

context ISP
  interface N6_interface1
    ip address 209.165.200.225 209.165.200.254
    ip address 209.165.201.1 209.165.200.254 secondary
    ipv6 address 2001:DB8::1/32 secondary

  interface N6_interface2
    ip address 209.165.202.129 209.165.200.254
    ip address 209.165.201.30 209.165.200.254 secondary
    ipv6 address 2001:DB8:1::1/32 secondary

```

Configuring Network Reachability Server on UPF

In order to forward the packets to the next hop IP, it requires the UPF to perform source-based routing and also learn the MAC address of the next hop IP by sending an ARP request to the next hop.

Configuring network reachability allows the UPF to test the network device by sending the ping packets to the destination.

To test and detect network reachability or failure on UPF for IPv4 addresses, use following configuration:

```

config
  context context_name
  nw-reachability server server_name [ remote-addr ip_addr ] [ local-addr
ip_addr ]

```

NOTES:

- **nw-reachability server** *server_name* [**remote-addr** *ip_addr*] [**local-addr** *ip_addr*] —This CLI adds or deletes a reachability-detect server. The [**local-addr** *ip_addr*] specifies the source IP from which the packets are sent and the [**remote-addr** *ip_addr*] specifies the destination IP to send the ping packets for detecting network failure or reachability.



Note UPF supports a maximum of 2000 IPv4 pools and 256 IPv6 pools per VPN network reachability configurations per context.

To test and detect network reachability or failure on UPF for IPv6 addresses, use the following configuration:

```

config
  context context_name
  ip access-list acl_name
  { deny | permit } [ log ] any
  exit
  nw-reachability server server_name [ remote-addr ip_addr ] [ local-addr
ip_addr ]
  end if_name

```

```

interface if_name
  ipv6 address ipv6_address ipv6_mask
    bfd interval interval_value min_rx rx_value multiplier multiplier_value
  exit
  port ethernet slot/port
    no shutdown
    vlan vlan_tag_ID
    no shutdown
  bind interface interface_name context_name
end

```

NOTES:

- **ip access-list** *acl_name*: **ip access-list** specifies the type of subscriber traffic and the direction (uplink, downlink, or both) traffic is redirected. The **ip access-list** must be specified in the context in which the subscriber authentication is performed.
- **{ deny | permit } [log] any**: Indicates the rule, when matched, drops or allows the corresponding packets. **[log]** indicates that all the packets which match the filter are to be logged.
any indicates that all the packets will match the filter regardless of the source and/or the destination.
- **interface** *if_name*: Specifies the interface in which the to enable BFD.
- **ipv6 address** *ipv6_address* *ipv6_mask*: Specifies the IPv6 address for configuring the static routes.
- **bfd interval** *interval_value* **min_rx** *rx_value* **multiplier** *multiplier_value*: **bfd interval** *interval_value* specifies the transmit interval of control packets in milliseconds as an integer from 50 through 10000. **min_rx** *rx_value* specifies the minimum receive interval for control packets in milliseconds as an integer from 50 through 10000. **multiplier** *multiplier_value* specifies the value used to compute hold-down time as an integer from 3 through 50.

Configuration Example

Following is the sample configuration of network reachability to learn the MAC address of the next hop IP:

```

(config-ctx)# nw-reachability server test remote-addr 209.165.200.225 local-addr
209.165.202.129

```

OAM Support

This section describes the operations, administration, and maintenance support for this feature.

Monitoring Support

This section describes feature-level monitoring support information.

show ip arp vpp

This show command displays the correct MAC address associated with the next hop IP addresses:

```

# show ip arp vpp
Wednesday November 22 13:03:40 EST 2023
  Time      IP          Flags    Ethernet          Interface          slot/port
3460.6250  10.1.105.254 D        00:fd:22:53:01:81 VirtualFunctionEthernet0/6/0.1105  1/10
3446.2276  10.2.105.254 D        00:fd:22:52:ff:5f VirtualFunctionEthernet0/7/0.2105  1/11

```

show configuration context

To verify the configured ACL lists, use the following show command:

```
[ISP]Hertz-UPF-A# show configuration context ISP
context ISP
  ip access-list ecs-v4.acl
    permit any
  #exit
  nw-reachability server NHFWDVlan1 remote-addr 192.11.55.100 local-addr 192.11.55.51
  nw-reachability server NHFWDVlan1_ipv6 remote-addr 2001:4888:192:1155::100 local-addr
2001:4888:192:1155::51
  #exit
interface isp-1155
  ip address 192.11.55.51 255.255.255.0
  ipv6 address 2001:4888:192:1155::51/64 secondary
  bfd interval 50 min_rx 50 multiplier 3

port ethernet 1/10
  no shutdown
  vlan 1155
  no shutdown
  bind interface isp-1155 ISP
  #exit
```

show nw-reachability server

This show command displays the reachability status of both the next hop IPs (remote-addr). If the next hop IP is reachable, it is displayed as **Up**.

```
[ISP]upf01# show nw-reachability server all
Server          remote-addr          local-addr          Vrf          state
-----
vlan2645        10.28.45.1          10.28.45.2         n/a          Up
vlan2646        10.28.46.1          10.28.46.2         n/a          Up
NHFWDVlan1_ipv6 2001:4888:192:1155::100 2001:4888:192:1155::51 n/a          Up

Total Network Reachability Servers: 3 Up: 3
```

show ipv6 interface summary

This show command displays the interface summary for VLAN configuration with IPv6 configuration:

```
[ISP]Hertz-UPF-A# show ipv6 interface summary
Interface Name          Address/Mask          Port          Status
=====
isp                     2001:4888:192:1153::51/64  1/10 vlan 1153  UP
[sec]
isp-1155                2001:4888:192:1155::51/64  1/10 vlan 1155  UP
[sec]
```

Monitoring and Troubleshooting

This section provides information about CLI commands available for monitoring and troubleshooting the feature.

Show Commands and Outputs

This section provides information about show commands and their outputs in support of this feature.

show subscriber user-plane-only full all

The output of this show command is enhanced to include the following fields introduced in support of this feature.

- **Next Hop Ip Address** - Displays the configured Nexthop IP address.



Note **Next Hop Ip Address** field is displayed only if the Nexthop IP address is relayed from the SMF. This field is not displayed if Nexthop IP address is configured only at the UPF using Charging-Action.



CHAPTER 30

N:M Redundancy and Redundancy Configuration Manager

- [Feature Summary and Revision History, on page 307](#)
- [Feature Description, on page 308](#)

Feature Summary and Revision History

Summary Data

Table 68: Summary Data

Applicable Product(s) or Functional Area	5G-UPF
Applicable Platform(s)	VPC-SI
Feature Default Setting	Disabled – Configuration Required
Related Changes in this Release	Not Applicable
Related Documentation	<i>UCC 5G RCM Configuration and Administration Guide</i>

Revision History

Table 69: Revision History

Revision Details	Release
Support has been added to defer SSH IP installation.	2021.02.2
Support has been added for configuring the RCM through Network Services Orchestrator (NSO).	2021.02.0
First introduced.	2021.01.0

Feature Description

The Redundancy Configuration Manager (RCM) is a Cisco proprietary node/network function (NF) that provides redundancy of StarOS-based UP/UPFs. The RCM provides N:M redundancy of UP/UPFs wherein “N” is the number of Active UPs/UPFs and is less than 10, and “M” is the number of Standby UP/UPF in the redundancy group.

For details, refer the [Redundancy Configuration Manager - Configuration and Administration Guide](#).



CHAPTER 31

N3 Transfer of PDU Session Information

- [Feature Summary and Revision History, on page 309](#)
- [Feature Description, on page 309](#)

Feature Summary and Revision History

Summary Data

Applicable Product(s) or Functional Area	5G-UPF
Applicable Platform(s)	VPC-SI SMI
Feature Default Setting	Enabled – Always-on
Related Changes in this Release	Not Applicable
Related Documentation	Not Applicable

Revision History

Revision Details	Release
First introduced.	2020.02.0

Feature Description

The N3 transfer of PDU session information involves the inclusion of QoS Field Identifier (QFI) IE in the GTP-U extension header while performing GTP-U encapsulation toward gNodeB on the N3 interface, and removal of the GTP-U extension header while performing GTP-U decapsulation when packets are received from the gNodeB.

The QFI IE detects traffic pertaining to specific QoS sessions. It is used to send control information between the gNodeB and the UPF.

How it Works

This section describes the transfer of PDU session Information procedures between the gNodeB and UPF for Uplink and Downlink packets.

Transfer of PDU Session Information for Downlink Data Packets

The Transfer of PDU Session Information for downlink data packets involves transfer of control information elements related to the PDU Session from UPF/NG-RAN to NG-RAN.

A PDU session user plane instance that makes use of this transfer procedure is associated to a single PDU Session. The procedure is invoked whenever packets for that particular PDU Session must be transferred across the related interface instance.

The DL PDU SESSION INFORMATION frame includes a QoS Flow Identifier (QFI) field that is associated with the transferred packet. The NG-RAN uses the received QFI to determine the QoS flow and QoS profile which are associated with the received packet.

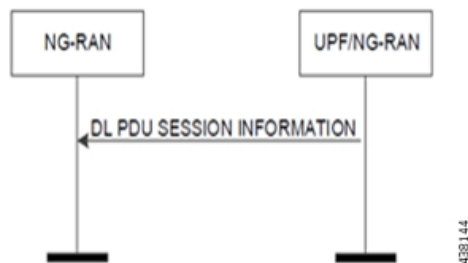

The following frame shows the respective DL PDU SESSION INFORMATION.

Bits								Num ber of Octet s
7	6	5	4	3	2	1	0	
PDU Type (=0)				Spare				1
PPP		RQI		QoS Flow Identifier				1
PPI			Spare					0 or 1
Padding								0-3

438145

NOTE: In current implementation, the Reflective QoS Indicator (RQI) and Paging Policy Presence (PPP) in DL PDU SESSION INFORMATION frame is not supported.

Transfer of PDU Session Information for Uplink Data Packets

The Transfer of PDU Session Information for uplink data packets involves transfer of control information elements related to the PDU Session from NG-RAN to UPF.

An UL PDU Session user plane instance that makes use of the transfer procedure is associated to a single PDU Session. This procedure is invoked whenever packets for that particular PDU Session need to be transferred across the related interface instance.

The UL PDU SESSION INFORMATION frame includes a QoS Flow Identifier (QFI) field associated with the transferred packet.



The following frame shows the respective UL PDU SESSION INFORMATION.

Bits								Num ber of Octet s
7	6	5	4	3	2	1	0	
PDU Type (=1)				Spare				1
Spare		QoS Flow Identifier						1
Padding								0-3

PDU Session Information Frame IEs

The following table describes the Information Elements present in the PDU Session Information frame.

Information Element	Description
PDU Type	The PDU Type indicates the structure of the PDU session UP frame. The field takes the value of the PDU Type it identifies: "0" for PDU Type 0. The PDU type is in bit 4 to bit 7 in the first octet of the frame. Value range: {0= DL PDU SESSION INFORMATION, 1=UL PDU SESSION INFORMATION, 2-15=reserved for future PDU type extensions} Field length: 4 bits
Spare	The spare field is set to "0" by the sender and should not be interpreted by the receiver. This field is reserved for later versions. Value Range: (0-2n-1) Field Length: n bits
QoS Flow Identifier	When this IE is present, this parameter indicates the QoS Flow Identifier of the QoS flow to which the transferred packet belongs. Value range: {0 to 2 ⁶ -1} Field length: 6 bits
Padding	The padding is included at the end of the frame to ensure that the PDU Session user plane protocol PDU length (including padding and the future extension) is (n*4- 2) octets, where n is a positive integer. Field Length: 0-3 octets.

Standards Compliance

The feature complies with the following standard: 3GPP TS 38.415 V15.2.0 (NG-RAN; PDU Session User Plane Protocol).

Limitations

The following are the known limitations to this feature in this release:

- Reflective QoS Indicator (RQI) is not supported in this release.



CHAPTER 32

N4 Interface Compliance with 3GPP Specification

This chapter covers the following topics:

- [Feature Summary and Revision History, on page 313](#)
- [Feature Description, on page 314](#)

Feature Summary and Revision History

Summary Data

Table 70: Summary Data

Applicable Product(s) or Functional Area	5G-UPF
Applicable Platform(s)	VPC-SI SMI
Feature Default Setting	Enabled - Always-on
Related Changes in this Release	Not Applicable
Related Documentation	Not Applicable

Revision History

Table 71: Revision History

Revision Details	Release
Support is added for Outer Header Removal IE.	2021.04.0
In this release, PFCP library is upgraded to support the latest version of Outer Header IE.	2020.02.5
First introduced.	2020.02.0

Feature Description

In compliance with 3GPP TS 29.244, the User Plane Function (UPF) supports the following IEs:

- Averaging Window
- Paging Policy Indicator (PPI)
- Outer Header Creation
- Outer Header Removal

Averaging Window

Averaging window IE contains the duration over which the GBR and MBR is calculated. It is sent from SMF to UPF with Create QER or Update QER parent IE, if the default pre-configured value under UPF needs to be overridden.

The following format is used for encoding and decoding of the IE:

	Bits							
Octets	8	7	6	5	4	3	2	1
1 to 2	Type = 157 (decimal)							
3 to 4	Length = n							
5 to 8	Averaging Window							
9 to (n+4)	These octet(s) is/are present only if explicitly specified							

NOTE: The value should be in milliseconds.

Paging Policy Indicator

The SMF sends PPI value in Create QER or Update QER, if UPF requires to set Paging Policy Indicator in outgoing packets.

In the case of Network Triggered Service Request and UPF buffering downlink data packet, the UPF includes the DSCP in ToS (IPv4) / TC (IPv6) value from the IP header of the downlink data packet. It also sends an indication of the corresponding QoS Flow in the data notification message to the SMF. When PPD applies, the SMF determines the Paging Policy Indicator (PPI) based on the DSCP received from the UPF.

In the case of Network Triggered Service Request and SMF buffering downlink data packet, when PPD applies, the SMF determines the PPI based on the DSCP in ToS (IPv4) / TC (IPv6) value from the IP header of the received downlink data packet and identifies the corresponding QoS Flow from the QFI of the received downlink data packet.

The following format is used for encoding and decoding of the IE:

	Bits							
Octets	8	7	6	5	4	3	2	1

1 to 2	Type = 158 (decimal)	
3 to 4	Length = n	
5	Spare	PPI value
6 to (n+4)	These octet(s) is/are present only if explicitly specified	

NOTE: The PPI should be encoded as a 3-bit value from 0 through 7.

Outer Header Creation

Per 3GPP TS 29.244 v16.4.0, the Outer Header Creation Description field, when present, is encoded as specified in following table. It takes the form of a bitmask where each bit indicates the outer header to be created in the outgoing packet. Spare bits are ignored by the receiver.

Octet / Bit	Outer Header Created in the Outgoing Packet
5/1	GTP-U/UDP/IPv4
5/2	GTP-U/UDP/IPv6
5/3	UDP/IPv4
5/4	UDP/IPv6
5/5	IPv4
5/6	IPv6
5/7	C-TAG
5/8	S-TAG
6/1	N19 Indication
6/2	N6 Indication
6/3	TCP/IPv4
6/4	TCP/IPv6

NOTE:

- Currently, the UP/UPF doesn't support the following values of Outer Header Creation Description:
 - IPv4
 - IPv6
 - C-TAG
 - S-TAG
 - N19 Indication
 - N6 Indication
- Third and fourth bits of sixth Octet (that is, 6/3 and 6/4) are spare bits (that is, not part of 3GPP TS) used for LI over TCP.

- When the Outer Header Creation IE is received with the Outer Header Creation description field set to both GTP-U/UDP/IPv4 and GTP-U/UDP/IPv6, then the length of the Outer Header Creation IE, which is 26 bytes, is validated. If the length is not 26 bytes, then the Sx message is responded with the PFCP_CAUSE_MANDATORY_IE_INCORRECT with Offending IE: OUTER_HDR_CREATION cause code.



Important If SMF/CP uses older version for Outer Header Creation, then undefined behavior (including crashes) can be seen.

Outer Header Removal

Outer Header Removal feature is used to remove the GPRS Tunneling Protocol User Plane (GTP-U) header from the uplink GTP-U packets.

The following format is used for encoding Outer Header Removal Information Element (IE):

	Bits							
Octets	8	7	6	5	4	3	2	1
1–2	Type = 95 (decimal)							
3–4	Length = n							
5	Outer Header Removal Description							
6	GTP-U Extension Header Deletion							
7 to (n+4)	These octets are present only if explicitly specified							

Per 3GPP TS 29.244, the Outer Header Removal Description field, when present, is encoded as specified in the following table.

Table 72: Outer Header Removal Description

Outer Header to be Removed from the Incoming Packet	Value (Decimal)
GTP-U/UDP/IPv4 (See Notes 1, 2),	0
GTP-U/UDP/IPv6 (See Notes 1, 2)	1
UDP/IPv4 (See Notes 3, 6)	2
UDP/IPv6 (See Notes 3, 6)	3
IPv4 (See Note 6)	4
IPv6 (See Note 6)	5
GTP-U/UDP/IP (See Note 4)	6
VLAN S-TAG (See Note 5)	7
S-TAG and C-TAG (See Note 5)	8

Outer Header to be Removed from the Incoming Packet	Value (Decimal)
For future use. Not sent. If received, it's interpreted as the value "1".	9–255

NOTES:

- The SGW-U/I-UPF stores GTP-U extension headers. These headers are forwarded for the packets that aren't requested to be deleted by the GTP-U Extension Header Deletion field.
- The SGW-U/I-UPF stores the GTP-U message type for a GTP-U signaling message, which must be forwarded. For example, an End Marker message
- This value applies to DL packets received by a PGW-U for non-IP PDN connections. These connections use SGi tunneling based on UDP/IP encapsulation.
- The CP function uses this value for instructing the UP function to remove the GTP-U/UDP/IP header regardless of the IP version (IPv4 or IPv6).
- This value applies to DL packets received by a UPF over N6 for Ethernet PDU sessions.
- This value applies to DL packets received by a UPF (PDU Session Anchor) over N6, when explicit N6 traffic routing information is provided to the SMF.
- The Local F-TEID in the Created PDR or Traffic Endpoint IE is populated with the local GTP-U endpoint. This endpoint is allocated based on the configuration irrespective of the Outer Header Removal received in the Created PDR IE. For example, if the GTP-U service configuration supports both the IPv4 and IPv6 addresses, then both these addresses are allocated and advertised in the Created PDR and Traffic Endpoint IEs.

In addition to the Local F-TEID allocation process, the User Plane advertises the allocated F-TEID to the Control Plane through the Created PDR or Traffic Endpoint IE with the following scenarios:

- The Outer Header Removal that is received in the Create PDR IE is also considered while populating the Created PDR or Traffic Endpoint IE.
- If Outer Header Removal is received as GTP-U, UDP, or IP, then the local GTP-U endpoint is advertised as allocated, which implies that if both the IPv4 and IPv6 addresses are configured in the GTP-U service, then both these addresses are allocated and advertised. If an IPv4 or IPv6 address is configured, then only the required address is allocated and advertised through the Created PDR or Traffic Endpoint IE.
- If Outer Header Removal is received as GTP-U, UDP, or IPv4, then only the IPv4 address is advertised even if both these addresses are configured.
- If Outer Header Removal is received as GTP-U, UDP, or IPv6, then only the IPv6 address is advertised even if both these addresses are configured.

Software Requirements

The software requirements are as follows:

- The feature requires UPF support to identify, encode, and decode the wildcard tunnel type "GTP-U/UDP/IP-6" on the N4 interface.
- If IPv4 and IPv6 addresses are received as part of Outer Header Creation (OHC), priority is given to the IPv6 endpoint, and hence the IPv6 Outer Header Removal (OHR) endpoint is retained by the UPF.

- GTP-U/UDP/IP-6 on the N4 interface, can be received over Sx Establishment or Sx Modification request messages. UPF must support type-6 on both cases.
- In Handoff scenarios, for all the PDRs with OHR value- 6, uplink packets are buffered until an appropriate OHC IE is received for PDRs corresponding to the downlink FAR.
- The uplink packets are forwarded only after the appropriate OHR type is set at UPF.

Limitations

- When the Outer Header Removal value as 6 is received for uplink PDR, the UPF maintains only IPv6 Outer Header Removal IE for uplink PDR. The UPF maintains it until an appropriate Outer Header Creation IE is received for downlink FAR.
- This feature is applicable to the N4 interface only.



CHAPTER 33

N4 Interface Configuration

This chapter covers the following topics:

- [Feature Summary and Revision History, on page 319](#)
- [Feature Description, on page 320](#)
- [Configuring N4 Interface, on page 320](#)

Feature Summary and Revision History

Summary Data

Table 73: Summary Data

Applicable Product(s) or Functional Area	5G-UPF
Applicable Platform(s)	VPC-SI SMI
Feature Default Setting	Disabled - Configuration Required
Related Changes in this Release	Not Applicable
Related Documentation	<i>UCC 5G UPF Configuration and Administration Guide</i>

Revision History

Table 74: Revision History

Revision Details	Release
New IEs are supported in UPF in compliance with 3GPP TS 29.244.	2021.01.0
First introduced.	2020.02.0

Feature Description

This chapter provides the configuration information to identify a peer node to be an N4 interface, and the configuration to modify N4 parameters in an Sx-Service.

Configuring N4 Interface

This section describes the following configurations:

- Identifying N4 Interface
- Adding N4-type and Modification of N4 Parameters in Sx Service

Identifying an N4 Interface

Use the following configuration to identify if a peer node is an N4 interface type.

```
configure
  control-plane-group group_name
    peer-node-id [ ipv4-address ipv4_address | ipv6-address ipv6_address ]
  interface n4
  end
```

NOTES:

- To enable the **n4 interface** CLI command, you need the **require upf** CLI command on the UPF, which depends on the UPF license.
- [**ipv4-address** *ipv4_address* | **ipv6-address** *ipv6_address*] :
 - ipv4-address** *ipv4_address*: Specifies the IPv4 address of the peer node.
 - ipv6-address** *ipv6_address*: Specifies the IPv6 address of the peer node.
- **interface n4**: Identifies the N4 interface.

Modification of N4-type Parameters in an Sx Service

Use the following configuration to modify N4-type parameters in an Sx Service.

```
configure
  context context_name
    sx-service service_name
      n4 [ max-retransmissions max_retransmission_value |
      retransmission-timeout-ms timeout_value ]
    end
```

NOTES:

- **n4**: Allows modifications to N4 parameters.

- [**max-retransmissions** *max_retransmission_value* | **retransmission-timeout-ms** *timeout_value*]:
max-retransmissions *max_retransmission_value* Configures maximum retries for Sx control packets. *max_retransmission_value* must be an integer in the range of 0 to 15. The default value is 4.
retransmission-timeout-ms: Configures the control packet retransmission timeout in Sx in milliseconds. *timeout_value* must be an integer in the range of 1000 to 20000 milliseconds. The timeout value must be configured in steps of 100; for example: 1000, 1100, 1200, and so on. The default value is 5000 milliseconds.

Statistics

This section provides information on show commands and their output available in support of this feature.

show control-plane-group

The output of this command displays the following fields for this feature:

- Interface Type – This field indicates if the peer interface is N4. It is not displayed for non-N4 interfaces.

show sx-service all

The output of this command displays the following fields for this feature:

- N4
 - N4 Retransmission Timeout
 - N4 Maximum Request Retransmission

show subscribers user-plane-only all

The output of this command displays the following fields for this feature:

- Interface
 - N4

show user-plane-service statistics all

The output of this command displays the following fields for this feature:

- N4 interface-type PDNs
 - Active
 - Setup
 - Released

show subscribers user-plane-only seid number pdr all

The output of this command displays the following fields for this feature:

show subscribers user-plane-only callid number pdr full all

- Associated-QFIs

show subscribers user-plane-only callid number pdr full all

The output of this command displays the following fields for this feature:

- QoS Flow Identifier



CHAPTER 34

N4/Sx over IPsec

- [Feature Summary and Revision History, on page 323](#)
- [Feature Description, on page 324](#)
- [Recommended Timers, on page 325](#)
- [Sample Configurations, on page 332](#)
- [Monitoring and Troubleshooting, on page 335](#)

Feature Summary and Revision History

Summary Data

Table 75: Summary Data

Applicable Product(s) or Functional Area	5G-UPF
Applicable Platform(s)	VPC-SI SMI
Feature Default Setting	Enabled – Always-on
Related Changes in this Release	Not Applicable
Related Documentation	<i>UCC 5G UPF Configuration and Administration Guide</i>

Revision History

Revision Details	Release
First introduced.	2022.04.0

Feature Description

Internet Protocol Security (IPSec) is a suite of protocols that interact with one another to provide secure private communication across IP networks. These protocols allow the system to establish and maintain secure tunnels with peer security gateways. IPSec provides confidentiality, data integrity, access control, and data source authentication to IP datagrams.

In Cisco Cloud Native 5G, the IPSec functionality is available in Tunnel mode both on Session Management Function (SMF) and User Plane Function (UPF). The IPSec crypto-maps are associated under the appropriate interface on respective nodes. The IPSec tunnel is created between each SMF or UPF pair explicitly. This feature supports the IPv4 and IPv6 tunneling mode. There is no change on the N4/Sx service configuration.

The IPSec tunnel mode encapsulates the entire IP packet to provide a virtual secure hop between two gateways. It forms VPN kind of functionality, where entire IP packets are encapsulated inside another and delivered to the destination. It encapsulates the full IP header as well as the payload.

Figure 22: N4/Sx Over IPSec Tunnel

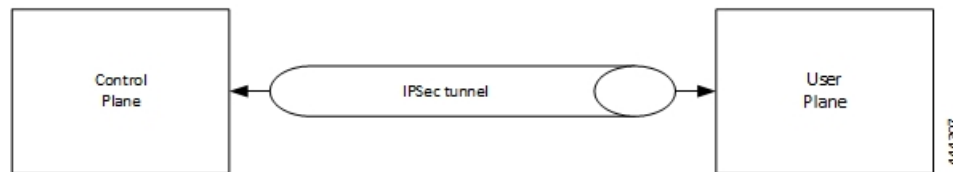

When N4/Sx over IPSec is enabled on UPF NF running VPP, then the following parameter must be used under "VPP Param" for the N4/Sx Over IPSec feature to work.

```
VPP_DPDK_DATA_SIZE=5120
```

The VPP Param is stored in the **staros_para.cfg** file on a CD-ROM and this configuration is read and applied to VPP by UPF during its boot.



Note This parameter is supported until VPP version 19.08. This parameter introduces a memory overhead of about 800 MB. You must consider this condition before using the feature. If the UPF has less RAM, then VM must be allocated with extra 1 GB of RAM memory for the feature to work properly.

For more information on IPSec support, see the StarOS *IPSec Reference*.

IKEv2 Keep-Alive Messages (Dead Peer Detection)

IPSec for N4/Sx interface supports IKEv2 keep-alive messages, also known as Dead Peer Detection (DPD), originating from both ends of an IPSec tunnel. As per RFC 3706, DPD is used to simplify the messaging required to verify communication between peers and tunnel availability.

IPSec DPD is an optional configuration. If its disabled, the IPSec node does not initiate DPD request. However, the node always responds to DPD availability messages initiated by peer node regardless of its DPD configuration.

The following method can be used to calculate the keep-alive interval value when N4/Sx over IPSec feature is configured:

```
((max-retransmissions + 1) * retransmission-timeout-ms) * 2
```

The keep-alive interval value specifies the time that the IPsec tunnel will remain up till DPD is triggered.

Example:

The following is a sample output of the **show configuration context** *context_name* **verbose** CLI command under N4/Sx service:

```
sx-service sx
  instance-type userplane
  bind ipv4-address 192.168.1.1 ipv6-address bbbb:abcd::11
  sxa max-retransmissions 4
  sxa retransmission-timeout-ms 5000
```

Here, the value of **max-retransmissions** is 4 and **retransmission-timeout-ms** is 5000. Therefore, the keep-alive interval value will be 50:

$$((\text{max-retransmissions} + 1) * \text{retransmission-timeout-ms}) * 2 = \text{Keep-alive interval}$$

$$((4+1) * 5000) * 2 = 50$$

IKESA Rekey

UPF supports both IKESA Rekey and IPsec Rekey.

For IKESA Rekey, the **lifetime interval** CLI must be configured under **ikev2-ikesa transform-set transform_set**. You must also configure **ikev2-ikesa rekey** under **crypto map** configuration. Following is a configuration example:

```
ikev2-ikesa transform-set ikesa-foo
  encryption aes-cbc-256
  group 14
  hmac sha2-256-128
  lifetime 28800
  prf sha2-256
...
...
...
crypto map foo0 ikev2-ipv4
  match address foo0
  authentication local pre-shared-key encrypted key secret_key
  authentication remote pre-shared-key encrypted key secret_key
  ikev2-ikesa max-retransmission 3
  ikev2-ikesa retransmission-timeout 15000
  ikev2-ikesa transform-set list ikesa-foo
  ikev2-ikesa rekey
  keepalive interval 50
  control-dont-fragment clear-bit
  payload foo-sa0 match ipv4
    ipsec transform-set list A-foo
      lifetime 600
      rekey keepalive
  #exit
  peer 172.19.222.2
  ikev2-ikesa policy error-notification
```

Recommended Timers

The following table provides the recommended timer values for CLI commands related to IPsec, N4/Sx, and SRP.

IPSec	SMF	UPF
ikev2-ikesa max-retransmission	<i>3</i>	<i>3</i>
ikev2-ikesa retransmission-timeout	<i>1000</i>	<i>1000</i>
keepalive	interval <i>4</i> timeout <i>1</i> num-retry <i>4</i>	interval <i>5</i> timeout <i>2</i> num-retry <i>4</i>
N4/Sx	SMF	UPF
sx-protocol heartbeat interval	<i>10</i>	<i>10</i>
sx-protocol heartbeat retransmission-timeout	<i>5</i>	<i>5</i>
sx-protocol heartbeat max-retransmissions	<i>4</i>	<i>4</i>
sxa max-retransmissions	<i>4</i>	<i>4</i>
sxa retransmission-timeout-ms	<i>5000</i>	<i>5000</i>
sxb max-retransmissions	<i>4</i>	<i>4</i>
sxb retransmission-timeout-ms	<i>5000</i>	<i>5000</i>
sxab max-retransmissions	<i>4</i>	<i>4</i>
sxab retransmission-timeout-ms	<i>5000</i>	<i>5000</i>
sx-protocol association reattempt-timeout	<i>60</i>	<i>60</i>
SRP	SMF	UPF
hello-interval	<i>3</i>	<i>3</i>
dead-interval	<i>15</i>	<i>15</i>

Recommended Configurations

Following are the recommended configurations and restrictions related to N4/Sx and SRP over IPSec:

- The multihop BFD timer between SMF and UPF must be seven seconds (for Data UPFs).
- The singlehop BFD must be enabled on all the contexts (SMF GW/Billing and UPF Gn/Gi).
- Inter-chassis multihop BFD must be enabled for SMF-SMF ICSR and UPF-UPF ICSR (IMS UPF).
- The SRP-IPSec ACL must be configured for TCP protocol instead of IP protocol.
- The N4/Sx-IPSec ACL must be configured for UDP protocol instead of IP protocol.

Example Configurations in SMF

Multihop BFD Configuration VPC-DI

The following is an example of multihop BFD configuration with seven seconds timer.

```
bfd-protocol
  bfd multihop-peer 209.165.200.226 interval 350 min_rx 350 multiplier 20
  bfd multihop-peer 209.165.200.227 interval 350 min_rx 350 multiplier 20
  bfd multihop-peer 209.165.200.225 interval 350 min_rx 350 multiplier 20
  bfd multihop-peer 209.165.200.230 interval 350 min_rx 350 multiplier 20
  bfd multihop-peer 209.165.200.228 interval 350 min_rx 350 multiplier 20
  bfd multihop-peer 209.165.200.229 interval 350 min_rx 350 multiplier 20
#exit
```

Multihop BFD Configuration VPC-SI

The following is an example of multihop BFD configuration with three seconds timer.

```
bfd-protocol
  bfd multihop-peer 209.165.200.226 interval 150 min_rx 150 multiplier 20
  bfd multihop-peer 209.165.200.227 interval 150 min_rx 150 multiplier 20
  bfd multihop-peer 209.165.200.225 interval 150 min_rx 150 multiplier 20
  bfd multihop-peer 209.165.200.230 interval 150 min_rx 150 multiplier 20
  bfd multihop-peer 209.165.200.228 interval 150 min_rx 150 multiplier 20
  bfd multihop-peer 209.165.200.229 interval 150 min_rx 150 multiplier 20
#exit
```

BGP Configuration

The following is an example of BGP configuration with recommended timers.

```
router bgp 1111
  router-id 209.165.200.225
  maximum-paths ebgp 15
  neighbor 209.165.200.250 remote-as 1000
  neighbor 209.165.200.250 ebgp-multihop
  neighbor 209.165.200.250 update-source 209.165.200.225
  neighbor 1111:2222::101 remote-as 1000
  neighbor 1111:2222::101 ebgp-multihop
  neighbor 1111:2222::101 update-source 1111:2222::1
  bgp graceful-restart restart-time 120
  bgp graceful-restart stalepath-time 300
  timers bgp keepalive-interval 30 holdtime-interval 90 min-peer-holdtime-interval 0
server-sock-open-delay-period 10
  address-family ipv4
    redistribute connected
  #exit
  address-family ipv6
    neighbor 1111:2222::101 activate
    redistribute connected
  #exit
#exit
```

Singlehop BFD Configuration

The following is an example of singlehop BFD configuration with three seconds timer.

```
interface bgp-sw1-2161-10
  ip address 209.165.200.233 209.165.200.255
  ipv6 address 1111:222::9/112 secondary
  bfd interval 999 min_rx 999 multiplier 3
#exit
interface bgp-sw1-2161-11
```

```

        ip address 209.165.200.234 209.165.200.255
        ipv6 address 1111:222::10/112 secondary
        bfd interval 999 min_rx 999 multiplier 3
    #exit
interface bgp-sw1-2161-12
    ip address 209.165.200.235 209.165.200.255
    ipv6 address 1111:222::11/112 secondary
    bfd interval 999 min_rx 999 multiplier 3
#exit
interface bgp-sw1-2161-3
    ip address 209.165.200.226 209.165.200.255
    ipv6 address 1111:222::2/112 secondary
    bfd interval 999 min_rx 999 multiplier 3
#exit
interface bgp-sw1-2161-4
    ip address 209.165.200.227 209.165.200.255
    ipv6 address 1111:222::3/112 secondary
    bfd interval 999 min_rx 999 multiplier 3
#exit
interface bgp-sw1-2161-5
    ip address 209.165.200.228 209.165.200.255
    ipv6 address 1111:222::4/112 secondary
    bfd interval 999 min_rx 999 multiplier 3
#exit
interface bgp-sw1-2161-6
    ip address 209.165.200.229 209.165.200.255
    ipv6 address 1111:222::5/112 secondary
    bfd interval 999 min_rx 999 multiplier 3
#exit
interface bgp-sw1-2161-7
    ip address 209.165.200.230 209.165.200.255
    ipv6 address 1111:222::6/112 secondary
    bfd interval 999 min_rx 999 multiplier 3
#exit
interface bgp-sw1-2161-8
    ip address 209.165.200.231 209.165.200.255
    ipv6 address 1111:222::7/112 secondary
    bfd interval 999 min_rx 999 multiplier 3
#exit
interface bgp-sw1-2161-9
    ip address 209.165.200.232 209.165.200.255
    ipv6 address 1111:222::8/112 secondary
    bfd interval 999 min_rx 999 multiplier 3
#exit

```

Static Route for Multihop BFD Configuration

The following is an example of static route multihop BFD configuration.

```

ip route static multihop bfd UP-5 209.165.200.240 209.165.200.245
ip route static multihop bfd UP-6 209.165.200.240 209.165.200.246
ip route static multihop bfd UP-9 209.165.200.240 209.165.200.247
ip route static multihop bfd UP-10 209.165.200.240 209.165.200.248
ip route static multihop bfd UP-7 209.165.200.240 209.165.200.249
ip route static multihop bfd UP-8 209.165.200.240 209.165.200.250

```

Static Route for Singlehop BFD Configuration

The following is an example of static route singlehop BFD configuration.

```

ip route static bfd bgp-sw1-2161-3 209.165.200.230
ip route static bfd bgp-sw1-2161-4 209.165.200.230
ip route static bfd bgp-sw1-2161-5 209.165.200.230
ip route static bfd bgp-sw1-2161-6 209.165.200.230

```

```

ip route static bfd bgp-sw1-2161-7 209.165.200.230
ip route static bfd bgp-sw1-2161-8 209.165.200.230
ip route static bfd bgp-sw1-2161-9 209.165.200.230
ip route static bfd bgp-sw1-2161-10 209.165.200.230
ip route static bfd bgp-sw1-2161-11 209.165.200.230
ip route static bfd bgp-sw1-2161-12 209.165.200.230

```

IPSec ACL Configuration

The following is an example IPSec ACL configuration in SMF.

```

ip access-list UP-1
    permit udp host 209.165.200.225 host 209.165.200.226
#exit

```

IPSec Transform Set Configuration

The following is an example of IPSec Transform Set configuration in SMF.

```

ikev2-ikesa transform-set ikesa-UP-1
    encryption aes-cbc-256
    group 14
    hmac sha2-256-128
    lifetime 28800
    prf sha2-256

ipsec transform-set A-UP-1
    encryption aes-cbc-256
    hmac sha2-256-128
    group 14

```

IPSec Crypto Map Configuration

The following is an example of IPSec Crypto Map configuration in SMF.

```

crypto map UP-1 ikev2-ipv4
    match address UP-1
    authentication local pre-shared-key encrypted key secretkey
    authentication remote pre-shared-key encrypted key secretkey
    ikev2-ikesa max-retransmission 3
    ikev2-ikesa retransmission-timeout 1000
    ikev2-ikesa transform-set list ikesa-UP-1
    ikev2-ikesa rekey
    keepalive interval 4 timeout 1 num-retry 4
    control-dont-fragment clear-bit
    payload foo-sa0 match ipv4
    ipsec transform-set list A-UP-1
    lifetime 300
    rekey keepalive
#exit
peer 209.165.200.224
ikev2-ikesa policy error-notification
#exit

```

N4/Sx Configuration

The following is an example of N4/Sx configuration in SMF.

```

sx-service SX-1
    instance-type controlplane
    sxa max-retransmissions 4
    sxa retransmission-timeout-ms 5000
    sxb max-retransmissions 4
    sxb retransmission-timeout-ms 5000

```

```

    sxab max-retransmissions 4
    sxab retransmission-timeout-ms 5000
    n4 max-retransmissions 4
    n4 retransmission-timeout-ms 5000
    sx-protocol heartbeat interval 10
    sx-protocol heartbeat retransmission-timeout 5
    sx-protocol heartbeat max-retransmissions 4
    sx-protocol compression
    sx-protocol supported-features load-control
    sx-protocol supported-features overload-control
  exit
end

```

Example Router Configurations

Static Routes for Interface

The following is an example configuration of static route for interface.

```

ip route 209.165.200.224/27 Vlan1111 209.165.200.225
ip route 209.165.200.224/27 Vlan1111 209.165.200.226
ip route 209.165.200.224/27 Vlan1111 209.165.200.227
ip route 209.165.200.224/27 Vlan1111 209.165.200.228
ip route 209.165.200.224/27 Vlan1111 209.165.200.229
ip route 209.165.200.224/27 Vlan1111 209.165.200.230
ip route 209.165.200.224/27 Vlan1111 209.165.200.231
ip route 209.165.200.224/27 Vlan1111 209.165.200.232
ip route 209.165.200.224/27 Vlan1111 209.165.200.233
ip route 209.165.200.224/27 Vlan1111 209.165.200.234

```

Static Routes for Singlehop BFD

The following is an example configuration of static route for singlehop BFD.

```

ip route static bfd Vlan1111 209.165.200.225
ip route static bfd Vlan1111 209.165.200.226
ip route static bfd Vlan1111 209.165.200.227
ip route static bfd Vlan1111 209.165.200.228
ip route static bfd Vlan1111 209.165.200.229
ip route static bfd Vlan1111 209.165.200.230
ip route static bfd Vlan1111 209.165.200.231
ip route static bfd Vlan1111 209.165.200.232
ip route static bfd Vlan1111 209.165.200.233
ip route static bfd Vlan1111 209.165.200.234

```

Interface for Singlehop BFD

The following is an example configuration of interface for singlehop BFD.

```

interface Vlan1111
  no shutdown
  bandwidth 10000000
  bfd interval 999 min_rx 999 multiplier 3
  no bfd echo
  ip address 209.165.200.224/27
  ipv6 address 1111:222::1/112

```

BGP Configuration

The following is an example of BGP configuration with recommended timers.

```

router bgp 1000
  router-id 209.165.200.226

```



```

timers bgp 30 90
timers bestpath-limit 300
timers prefix-peer-timeout 30
timers prefix-peer-wait 90
graceful-restart
graceful-restart restart-time 120
graceful-restart stalepath-time 300

```

Example Configurations in UPF

IPSec ACL Configuration

The following is an example of IPSec ACL configuration in UPF.

```

ip access-list CP-1
    permit udp host 209.165.200.225 host 209.165.200.226
#exit

```

IPSec Transform Set Configuration

The following is an example of IPSec Transform Set configuration in UPF.

```

ipsec transform-set A-CP-1
    encryption aes-cbc-256
    hmac sha2-256-128
    group 14

ikev2-ikesa transform-set ikesa-CP-1
    encryption aes-cbc-256
    group 14
    hmac sha2-256-128
    lifetime 28800
    prf sha2-256

```

IPSec Crypto Map Configuration

The following is an example of IPSec Crypto Map configuration in UPF.

```

crypto map CP-1 ikev2-ipv4
    match address CP-1
    authentication local pre-shared-key encrypted key secretkey
    authentication remote pre-shared-key encrypted key secretkey
    ikev2-ikesa max-retransmission 3
    ikev2-ikesa retransmission-timeout 1000
    ikev2-ikesa transform-set list ikesa-CP-1
    ikev2-ikesa rekey
    keepalive interval 5 timeout 2 num-retry 4
    control-dont-fragment clear-bit
    payload foo-sa0 match ipv4
    ipsec transform-set list A-CP-1
#exit
peer 209.165.200.230
ikev2-ikesa policy error-notification
#exit

```

N4/Sx Configuration

The following is an example of N4/Sx configuration in UPF.

```

sx-service SX-1
    instance-type userplane
    sxa max-retransmissions 4
    sxa retransmission-timeout-ms 5000

```

```

    sxb max-retransmissions 4
    sxb retransmission-timeout-ms 5000
    sxab max-retransmissions 4
    sxab retransmission-timeout-ms 5000
    n4 max-retransmissions 4
    n4 retransmission-timeout-ms 5000
    sx-protocol heartbeat interval 10
    sx-protocol heartbeat retransmission-timeout 5
    sx-protocol heartbeat max-retransmissions 4
    sx-protocol compression
  exit

```

Example SRP Configurations

IPSec ACL Configuration

The following is an example of IPSec ACL configuration for SRP.

```

ip access-list SRP
  permit tcp host 209.165.200.227 host 209.165.200.228
#exit

```

SRP Configuration

The following is an example of SRP configuration.

```

configure
  context srp
    bfd-protocol
      bfd multihop-peer 209.165.200.225 interval 999 min_rx 999 multiplier 3
    #exit
configure
  context srp
    service-redundancy-protocol
      chassis-mode primary
      hello-interval 3
      dead-interval 15
      monitor bfd context srp 209.165.200.226 chassis-to-chassis
      monitor bgp context gi-pgw 209.165.200.245
      monitor bgp context gi-pgw 3333:888::1
      monitor bgp context saegw 209.165.200.245
      monitor bgp context saegw 3333:888::2
      peer-ip-address 209.165.200.227
      bind address 209.165.200.228
    #exit
  ip route static multihop bfd srp 209.165.200.229 209.165.200.245
  ip route 209.165.201.1 209.165.202.129 209.165.200.230 SRP-Physical-2102
  ip route 209.165.201.2 209.165.202.130 209.165.200.231 SRP-Physical-2102
  ip route 209.165.201.3 209.165.202.131 209.165.200.232 SRP-Physical-2102
  ip igmp profile default
  #exit
#exit
end

```

Sample Configurations

In following sample configuration, the N4/Sx and IPSec interface IP Addresses are defined as:

```

SMF N4/Sx - 192.0.2.1
UPF N4/Sx - 192.0.2.7

```

```
SMF IPSec - 198.51.100.1
UPF IPSec - 198.51.100.2
```



- Note**
- For this release, following are the recommended timer values on UPF:

```
sx-protocol heartbeat retransmission-timeout 20
sx-protocol heartbeat max-retransmissions 3
```
 - For this release, following are the recommended timer values on SMF:

```
sx-protocol heartbeat retransmission-timeout 20
sx-protocol heartbeat max-retransmissions 5
```

Control Plane

IPSec Configuration

```
config
context EPC-CP
  ip access-list foo0
    permit ip host 192.0.2.1 host 192.0.2.7
  #exit
  ipsec transform-set A-foo
  #exit
  ikev2-ikesa transform-set ikesa-foo
  #exit
  crypto map foo0 ikev2-ipv4
    match address foo0
    authentication local pre-shared-key key secret
    authentication remote pre-shared-key key secret
    ikev2-ikesa max-retransmission 3
    ikev2-ikesa retransmission-timeout 15000
    ikev2-ikesa notify-msg-error no-apn-subscription backoff-timer 0
    ikev2-ikesa notify-msg-error network-failure backoff-timer 0
    ikev2-ikesa transform-set list ikesa-foo
    ikev2-ikesa configuration-attribute p-cscf-v6 private length 0
    ikev2-ikesa configuration-attribute p-cscf-v6 iana length 0
    keepalive interval 50
    payload foo-sa0 match ipv4
      ipsec transform-set list A-foo
      lifetime 300
      rekey keepalive
    #exit
    peer 198.51.100.2
      ikev2-ikesa policy error-notification
      notify-payload error-message-type ue base 0
      notify-payload error-message-type network-transient-minor base 0
      notify-payload error-message-type network-transient-major base 0
      notify-payload error-message-type network-permanent base 0
    #exit
  interface CP_IPSEC loopback
    ip address 198.51.100.1 255.255.255.0
  crypto-map foo0
  #exit
end
```

N4/Sx Configuration

```
sx-service SX-1
  instance-type controlplane
  bind ipv4-address 192.0.2.1
```

```

    sx-protocol heartbeat retransmission-timeout 20
    sx-protocol heartbeat max-retransmissions 5
  exit

```

User Plane

IPSec Configuration

```

config
  context EPC-UP
    ip access-list foo0
      permit ip host 192.0.2.7 host 192.0.2.1
    #exit
    ipsec transform-set A-foo
    #exit
    ikev2-ikesa transform-set ikesa-foo
    #exit
    crypto map foo0 ikev2-ipv4
      match address foo0
      authentication local pre-shared-key key secret
      authentication remote pre-shared-key key secret
      ikev2-ikesa max-retransmission 3
      ikev2-ikesa retransmission-timeout 15000
      ikev2-ikesa notify-msg-error no-apn-subscription backoff-timer 0
      ikev2-ikesa notify-msg-error network-failure backoff-timer 0
      ikev2-ikesa transform-set list ikesa-foo
      ikev2-ikesa configuration-attribute p-cscf-v6 private length 0
      ikev2-ikesa configuration-attribute p-cscf-v6 iana length 0
      keepalive interval 50
      payload foo-sa0 match ipv4
        ipsec transform-set list A-foo
      #exit
    peer 198.51.100.1
      ikev2-ikesa policy error-notification
      notify-payload error-message-type ue base 0
      notify-payload error-message-type network-transient-minor base 0
      notify-payload error-message-type network-transient-major base 0
      notify-payload error-message-type network-permanent base 0
    #exit
    interface UP_IPSEC loopback
      ip address 198.51.100.2 255.255.255.0
    crypto-map foo0
    #exit
end

```

N4/Sx Configuration

```

sx-service SX-1
  instance-type userplane
  bind ipv4-address 192.0.2.7 ipv6-address dddd:51:31:1:209::
  sxa max-retransmissions 12
  sxb max-retransmissions 12
  sxab max-retransmissions 12
  sx-protocol heartbeat interval 30
  sx-protocol heartbeat retransmission-timeout 20
  sx-protocol heartbeat max-retransmissions 3
exit

```

To validate the IPSec tunnel CLI on the SMF protocol pod and validate the *ipsec.yaml* file on SMF, see the *Interfaces Support > N4 Interface* chapter for sample SMI strongSwan configuration.

For the latest strongSwan configurations, see the *Ultra Cloud Core Subscriber Microservices Infrastructure Operations Guide*.

Monitoring and Troubleshooting

This section contains the sample CLI command output of show commands for the N4/Sx over IPsec feature in both SMF and UPF.

show crypto ikev2-ikesa security-associations summary

```
I - Initiator
R - Responder
Mgr
ID  VPN  Local IPsec GW:Port  Remote IPsec GW:Port  State  Lifetime
===  ===  =====  =====  =====  =====  =====
54  2     192.168.170.55 :500  192.168.196.55 :500  AUTH_COMPLETE(I)  86400/16448

1 IKEv2 Security Association found in this context.
```

show crypto ipsec security-associations summary

```
+----- SA state:          (E) - Established
|                          (P) - Partially Established
|                          (N) - No SAs
|
|+----- Rekey/Keepalive:  (D) - Rekey Disabled
||                          (E) - Rekey Enabled/No Keepalive
||                          (K) - Rekey Enabled/Keepalive
||
||+----- Crypto Type:    (D) - Dynamic Map
|||                          (I) - IKEv1 Map
|||                          (J) - IKEv2 Map
|||                          (M) - Manual Map
|||                          (C) - CSCF Map
|||
|||
VVV          Map Name          Rekeys En Pkts
De Pkts
=====
1     EDJ foo0          0          3496
3496
```

```
1 Crypto Map Found.
1 Crypto Map Established.
```

To validate the IPsec tunnel CLI on the SMF protocol pod and validate the *ipsec.yaml* file on SMF, see the *Interfaces Support > N4 Interface* chapter for sample SMI strongSwan configuration.

For the latest strongSwan configurations, see the *Ultra Cloud Core Subscriber Microservices Infrastructure Operations Guide*.



CHAPTER 35

N4 Session Management, Node Level, and Reporting Procedures

This chapter covers the following topics:

- [Feature Summary and Revision History, on page 337](#)
- [Feature Description, on page 338](#)
- [How it Works, on page 339](#)
- [Configuring the N4 Session/Node Level Reporting Procedures, on page 349](#)

Feature Summary and Revision History

Summary Data

Table 76: Summary Data

Applicable Product(s) or Functional Area	5G-UPF
Applicable Platform(s)	VPC-SI SMI
Feature Default Setting	Enabled – Always-on
Related Changes in this Release	Not Applicable
Related Documentation	Not Applicable

Revision History

Revision Details	Release
The show user-plane-service statistics all command has been enhanced to display PFCP IEs received in Sx Establishment or Modification messages over N4 interface.	2023.01 2021.02.2
PDN Update procedure is introduced in this release.	2021.02.0

Revision Details	Release
First introduced.	2020.02.0

Feature Description

N4 Session Management, Node Level, and Reporting Procedures

N4 Node-level Procedures

The N4 Node-level procedures in User Plane Function (UPF) involves the following processes:

- N4 Association Setup Procedure – The procedure used for setting up an N4 association between the Session Management Function (SMF) and UPF.
- N4 Association Update Procedure – The procedure used for modifying an existing N4 association between the SMF and UPF.
- N4 Association Release Procedure – The procedure used for terminating the N4 association between the SMF and UPF.
- N4 Heartbeat Procedure – The procedure used for sending and receiving the Heartbeat request and response.
- N4 Reporting Procedure – The procedure used for reporting echo request and response for the GTP-u path failure.

N4 Session Management

N4 session management procedures are used to control the functionality of the UPF. SMF can create, update, and remove the N4 session context in the UPF, which is described in 3GPP TS 23.501, clause 5.8.2.

The following procedures are performed in N4 Session Management:

- N4 Session Establishment
- N4 Session Modification
- N4 Session Deletion

NOTE: The SMF initiates all the above procedures.

N4 Session/Node-level Reporting Procedures

Whenever the data path between UPF and gNB is down, it is detected and reported to the SMF for corrective actions. The mechanism to detect and report it to SMF is clearly defined in 3GPP specifications. The reporting happens per GTP-u Tunnel level or per GTP-u endpoint level.

Relationships

The following features support the N4 session management, node level, and reporting procedures.

End Marker Support

The UPF sends the End Marker packets to support the reordering function in the target Radio Access Network (RAN). The UPF constructs the End Marker packets that are required for the reordering function.

Constructing the End Marker Packets through UPF

At the time of the handover procedure, the PDU session for the UE – which comprises of an UPF node – acts as a PDU session anchor and an intermediate UPF terminating N3 reference point. The SMF sends an N4 Session Modification Request message with the new AN Tunnel Info of NG RAN to specify the UPF to switch to the N3 paths. In addition, the SMF also specifies the UPF to send the End Marker packets on the old N3 user plane path.

After the UPF receives the indication, the End Markers are constructed and sent to each N3 GTP-U tunnel toward the source NG RAN, after sending the last PDU on the old path.

UEs IPv4, IPv6, and IPv4v6 Support

The UPF supports UE's IPv4, IPv6, and IPv4v6 sessions.

The N4 Session Establishment and Modification procedure for IPv6 sessions is the same as for IPv4 sessions. After the session is established, the SMF sends Router Advertisement (RA) message to UE announcing the IPv6 prefix to be used for traffic. Optionally, to get the IPv6 parameter from SMF faster, the UE can also initiate IPv6 Router Solicitation (RS).

The N4 Session Establishment and Modification procedure for IPv4v6 Session are similar to the IPv4 or IPv6 sessions except for the allocation of two UE IP addresses - one for IPv4 and the other for IPv6. The SMF sends the Router Advertisement message to the UE announcing the IPv6 prefix used for traffic after the session is established. Optionally, the UE can also initiate the IPv6 Router Solicitation to receive the IPv6 parameter from the SMF quickly.

How it Works

This section describes the N4 node-level, session management, and reporting procedures and associated call flows.

N4 Node-level Procedure Call Flows

N4 Association Setup Procedure Call Flow

The N4 Association Setup procedure creates the N4 association between the SMF and the UPF, which enables the SMF to use the UPF resources to establish N4 sessions. The N4 association setup procedure involves the following steps:

1. The UPF initiates the procedure by sending N4 Association Setup Request to the SMF.
2. The SMF sends an N4 Association Setup Response after it receives the request from the UPF.

The following call flow describes the UPF-initiated N4 Association Setup procedure:

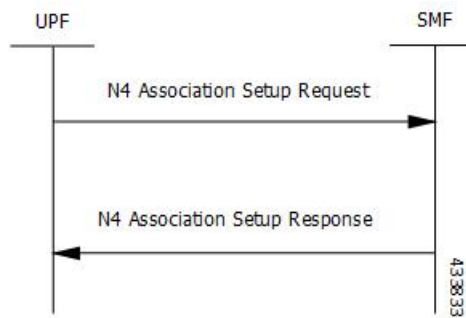

The UPF sends the following PFCP Association Setup Request:

- Node ID (UPF).
- Supported optional features in UPF. The UPF supports F-TEID allocation and release, sending of End Marker, and so on.

N4 Association Update Procedure Call Flow

The N4 Association Update procedure modifies an existing N4 association between the SMF and the UPF. It can be initiated either by the UPF or by the SMF to update the supported features or available UPF resources.

The following call flow depicts the SMF-initiated N4 Association Update procedure:

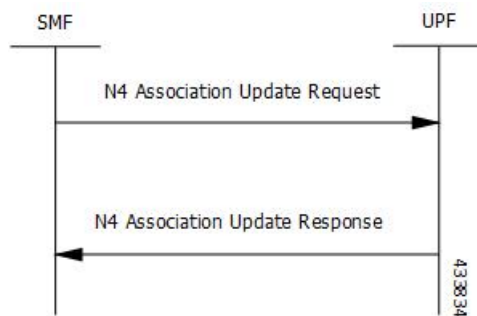

The following call flow depicts the UPF-initiated N4 Association Update procedure:

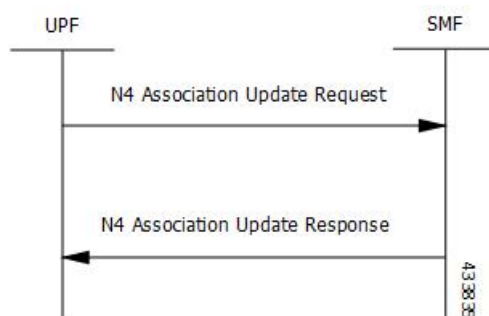

N4 Association Release Procedure Call Flow

The N4 Association Release procedure terminates the N4 association between the SMF and the UPF. It can be initiated either by the SMF or by the UPF. The UPF requests the SMF to perform the release of PFCP

association by sending a PFCP Association Update Request. The SMF then initiates a PFCP Association Release Request to release the PFCP association.

The following call flow depicts the SMF-initiated N4 Association Release procedure:

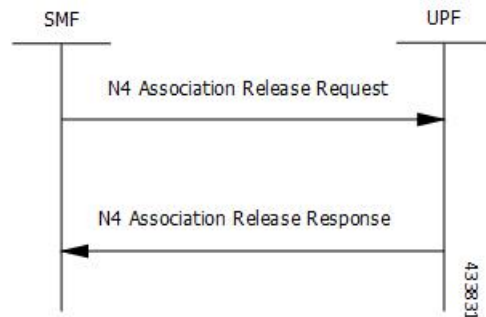

The following call flow depicts the UPF-initiated N4 Association Release procedure:

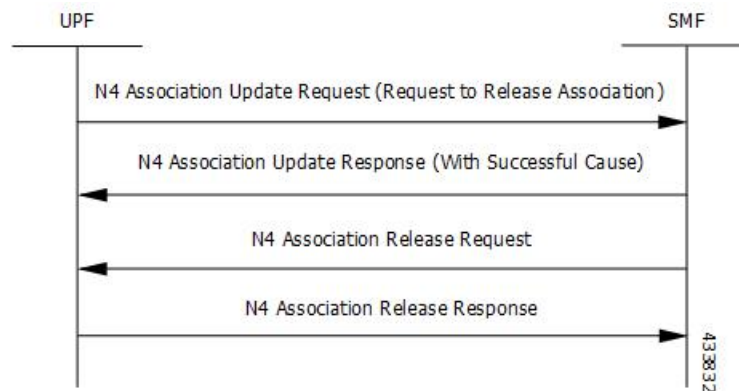

N4 Heartbeat Procedure

The PFCP Heartbeat procedure includes the following messages:

- Heartbeat Request
- Heartbeat Response

N4 Session Management Procedures Call Flows

The following section describes the N4 Session Management procedures.

N4 Session Establishment Call Flow

N4 Session Establishment is used to create the initial N4 session context for a PDU session at the UPF. SMF assigns a new N4 session ID and provides it to the UPF. The N4 session ID is stored by both entities and used to identify the N4 session context during their interaction. SMF also stores the relation between the N4 session ID and PDU session for a UE.

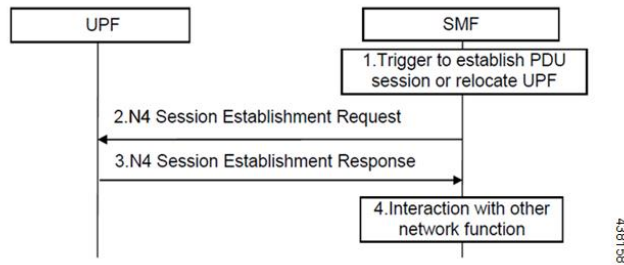

Step	Description
1	SMF receives the trigger to establish a new PDU session or change the UPF for an established PDU session.
2	SMF sends an N4 session establishment request message to the UPF that contains the structured control information which defines how the UPF needs to behave.
3	UPF responds with an N4 session establishment response message containing any information that the UPF has to provide to the SMF in response to the control information received.
4	SMF interacts with the network function which triggered this procedure. For example, AMF or PCF.

N4 Session Modification Call Flow

N4 Session Modification is used to update the N4 session context of an existing PDU session at the UPF, which is executed between SMF and UPF whenever PDU session-related parameters have to be modified.

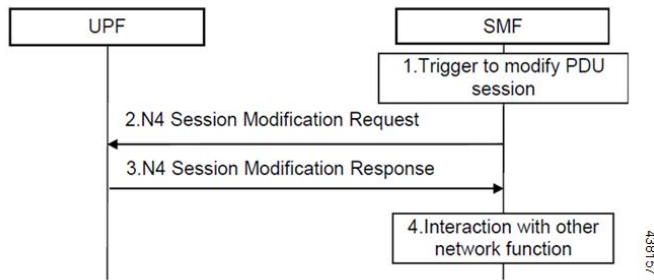

Step	Description
1	SMF receives the trigger to modify the existing PDU session.
2	SMF sends an N4 session modification request message to the UPF which contains the update for the structured control information that defines how the UPF needs to behave.
3	UPF identifies the N4 session context to be modified by the N4 session ID and updates the parameters of this N4 session context according to the list of parameters that are sent by the SMF. UPF responds with an N4 session modification response message containing any information that the UPF has to provide to the SMF in response to the control information received.

Step	Description
4	SMF interacts with the network entity which triggered this procedure. For example, AMF or PCF.

N4 Session Delete Call Flow

N4 Session Delete is used to remove the N4 session context of an existing PDU session at the UPF.

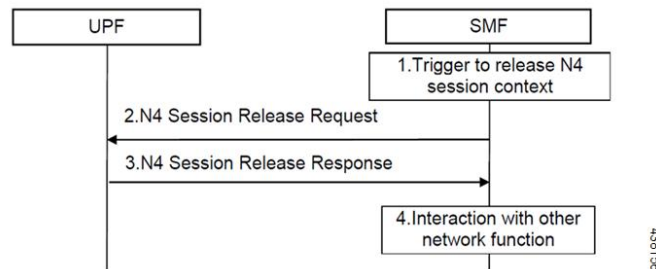

Step	Description
1	SMF receives the trigger to remove the N4 session context for the PDU session.
2	SMF sends an N4 session delete request message to the UPF.
3	UPF identifies the N4 session context to be removed by the N4 Session ID and removes the whole session context. UPF responds with an N4 session delete response message containing any information that the UPF has to provide to the SMF.
4	SMF interacts with the network entity which triggered this procedure. For example, AMF or PCF.

N4 Session/Node Level Reporting Procedure Call Flows

Session Level Reporting Due to the GTP-u Error Indication Call Flow

When the UPF receives the GTP-u Error Indication from gNB, it detects the PFCP session and sends the PFCP Session Report request to the SMF handling that session along with the Error Indication Report IE. The Error Indication IE also includes the remote F-TEID IE, which contains the GTP-u peer address and the TEID received from the GTP-u Error Indication IE.

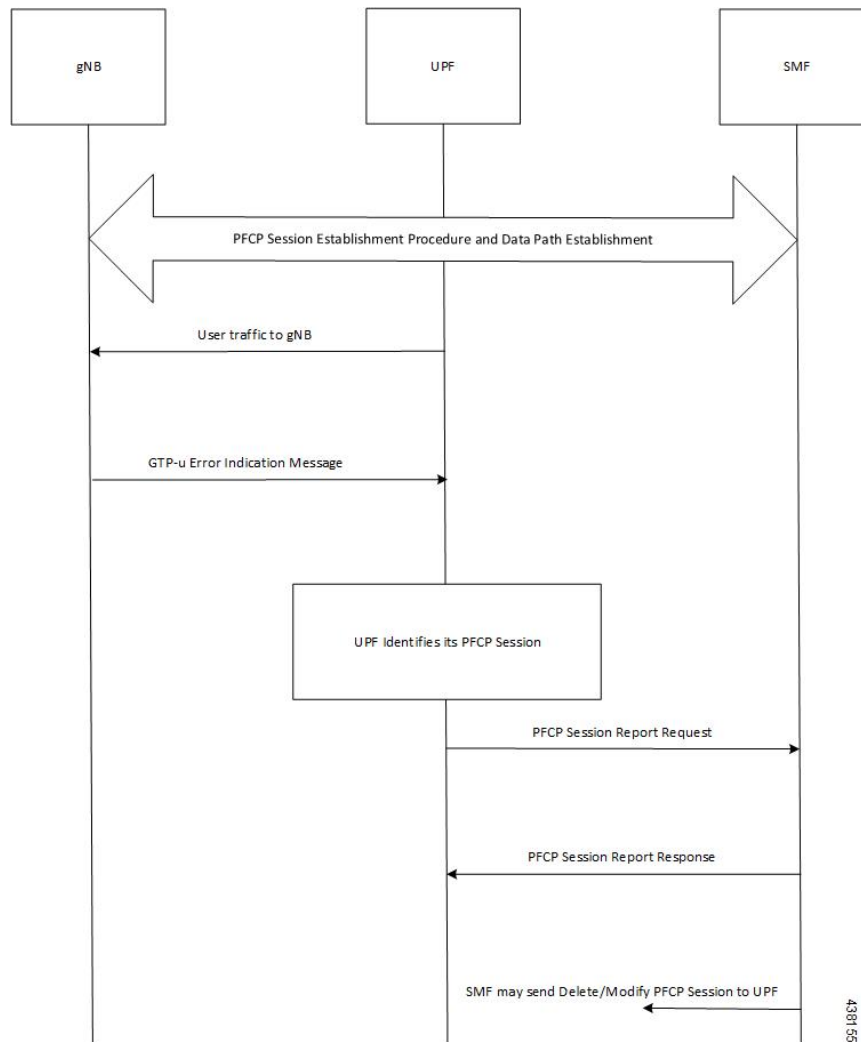

Step	Description
1	A PCFP session is established and the data traffic starts running.
2	When gNB clears up the TEID details locally for some reason, it sends the GTP-u Error Indication to UPF for unknown TEID.
3	Once the Error Indication is received, the UPF identifies the PCFP session and sends the PCFP session report request to the SMF.
4	The session report request contains the TEID and the remote IP address from where the Error Indication is received.

Node-level Reporting Procedure due to GTP-u Path Failure Call Flow

When the UPF enables GTP-u Echo procedure for GTP-u endpoints and identifies a data path failure because of no response, it sends a PCFP Node Report Request to the SMF. The Node Report Type in the PCFP Node Report Request is set to User Plane Path Failure Report when it is sent to the SMF. The Node Report procedure

includes only the peer IP address in Remote GTP-u Peer IE – the child IE of the User Plane Path Failure IE – since it is not specific to any PFCP session.

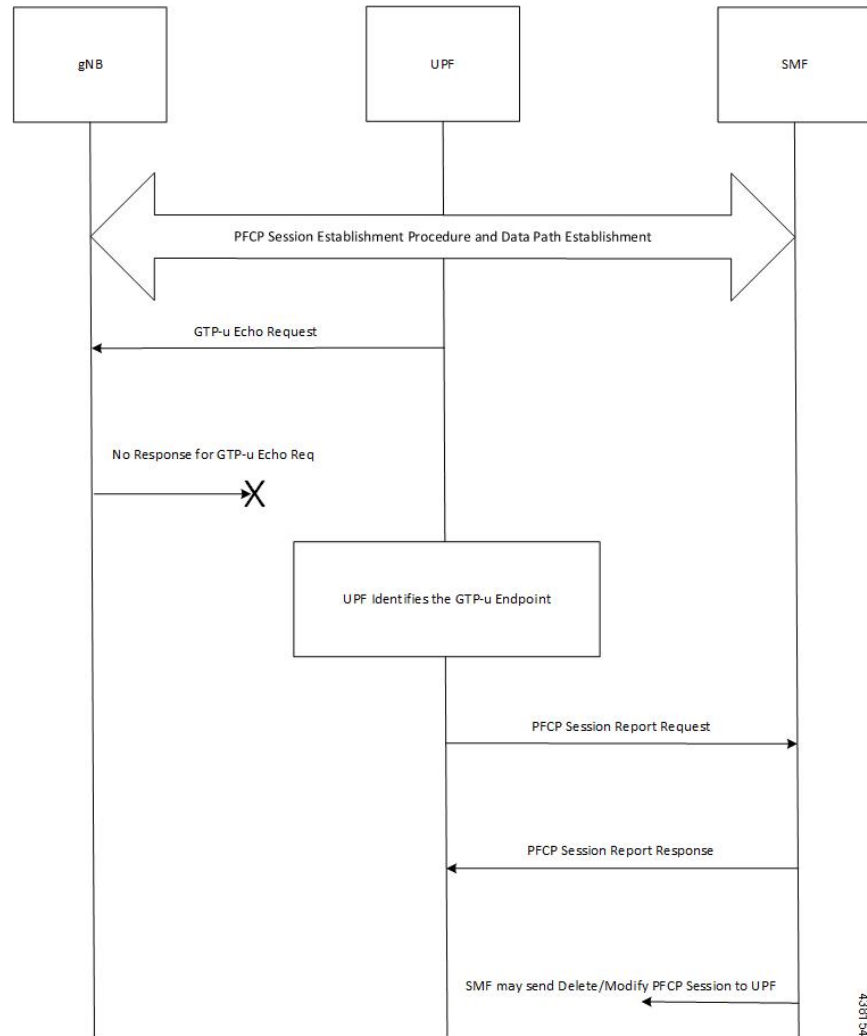

Step	Description
1	Once the PFCP session is established and GTP-u Echo procedure is configured, UPF initiates the GTP-u Echo Request for each peer with at least one GTP-u Tunnel.
2	If there is no GTP-u Echo Response received after a specified number of retries, then the UPF sends the PFCP Node Report Request to the SMF.
3	Only the peer IP address is sent in the Node Report request since it is not a GTP-u tunnel-specific failure.
4	Once the message is received, the SMF sends a Delete and Modify request for all the PFCP Sessions for that gNB to UPF.

PDN Update Procedure - eNodeB F-TEIDu

Feature Description

For S-GW or SAEGW, a procedure to initiate an N4/Sx Modification Request is implemented for:

- eNodeB F-TEIDu update
- Release Access Bearer (RAB) Request for an eNodeB release

How it Works

The PDN update procedure includes the following events for an eNodeB F-TEIDu Update/Release:

- For eNodeB F-TEIDu Update:
 1. The SGW-C initiates N4/Sx Session Modification Request toward SGW-U on receiving a Modify Bearer Request for eNodeB F-TEIDu Update from the MME.
 2. The N4/Sx Modification Request for eNodeB F-TEIDu update contains Update FAR with Apply Action as “Forward” and the updated eNodeB IPv4/IPv6 address in Outer Header Creation, which is a part of the Update Forwarding Parameters IE.
- For eNodeB F-TEIDu Release:
 1. The SGW-C initiates N4/Sx Modification Request toward SGW-U on receiving a RAB Request from the MME.
 2. RAB is a UE-level message. If the UE has multiple PDN connections, then the N4/Sx Modification Request is sent to each PDN connection separately.
 3. SGW-C initiates N4/Sx Session Modification Request toward SGW-U for the N4/Sx session with Update FAR with destination interface as ACCESS. Update FAR contains: FAR ID and Apply Action as Drop. FAR with the destination interface as CORE is not updated.

Standards Compliance

The PDN Update procedure complies with the following standards:

- 3GPP TS 23.401: "General Packet Radio Service (GPRS) enhancements for Evolved Universal Terrestrial Radio Access Network (E-UTRAN) access".
- 3GPP TS 29.274: "3GPP Evolved Packet System (EPS); Evolved General Packet Radio Service (GPRS) Tunneling Protocol for control plane (GTPv2-C); Stage 3".
- 3GPP TS 29.244: "Interface between the Control Plane and the User Plane of EPC".
- 3GPP TS 23.214: "Architecture enhancements for control and user plane separation of EPC nodes; Stage 2".
- 3GPP TS 23.714: "Study on control and user plane separation of EPC nodes"

UEs IPv4, IPv6, and IPv4v6 Support Call Flows

N4 Session Establishment and Modification Procedure for IPv6 Call Flow

The following call flow provides a high-level description of the N4 session establishment and modification procedure for IPv6.

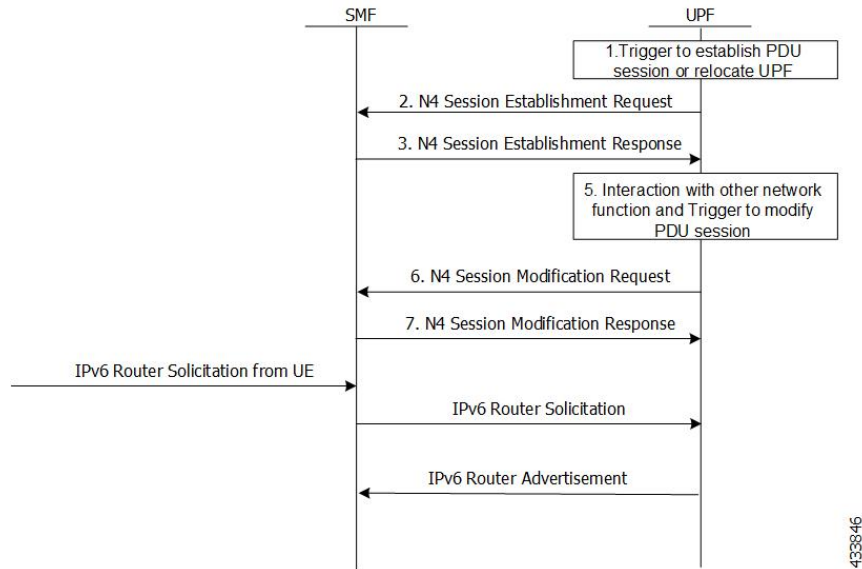

Step	Description
1	The SMF receives the trigger to establish a new PDU session or change the UPF for an established PDU session.
2	The SMF sends N4 Session Establishment Request message to the UPF, in which Create PDR IE has IPv6 UE address, and SDF filter has IPv6 filters to select the PDRs.
3	The UPF responds with an N4 Session Establishment Response message containing any information that the UPF must provide to the SMF in response to the control information received.
4	The SMF interacts with the network function and triggers to modify the PDU session.
5	The SMF sends an N4 Session Modification Request message to the UPF that contains the update for the structured control information which defines how the UPF needs to behave.
6	The UPF identifies the N4 session context to be modified by the N4 Session ID. Then, the UPF updates the parameters of this N4 session context according to the list of parameters sent by the SMF. The UPF responds with an N4 session modification response message containing any information that the UPF must provide to the SMF in response to the control information received.
7	An extra procedure is required for IPv6 sessions, which is Router Solicitation (RS) and Router Advertisement (RA). After the session is established, UE sends the RS message to network to get the link layer address. The UPF forwards this message to SMF. The SMF sends RA message with required parameters to configure the IPv6 address of UE.

Step	Description
8	The RS and RA between UPF and SMF is GTP-u encapsulated and SMF sends an extra pair of PDRs during session establishment and modification procedure, in which GTP-u Tunnel IDs are exchanged for GTP-u tunneling.
9	The additional pair of PDRs that are sent from the SMF are as follows: <ul style="list-style-type: none"> • One PDR has Source interface as Access, and Destination Interface as CP-Function, to forward IPv6 RS from UE to SMF. The SDF filter is present so that UPF can select this PDR for IPv6 RS from UE • Example: Permit in 58 from any to ff01::2 any • Another PDR has source interface as CP-Function, and Destination Interface as Access, to forward the IPv6 RA from SMF to UE. The SDF filter is present so that UPF can select this PDR for all the IPv6 RAs from SMF. • Example: Permit out 58 from any to ff01::2 any
10	After RS and RA procedure is completed, the UE sends IPv6 traffic to PDN.

N4 Session Establishment and Modification Procedure for IPv4v6 Call Flow

The following call flow provides a high-level description of the N4 session establishment and modification procedure for IPv4v6.

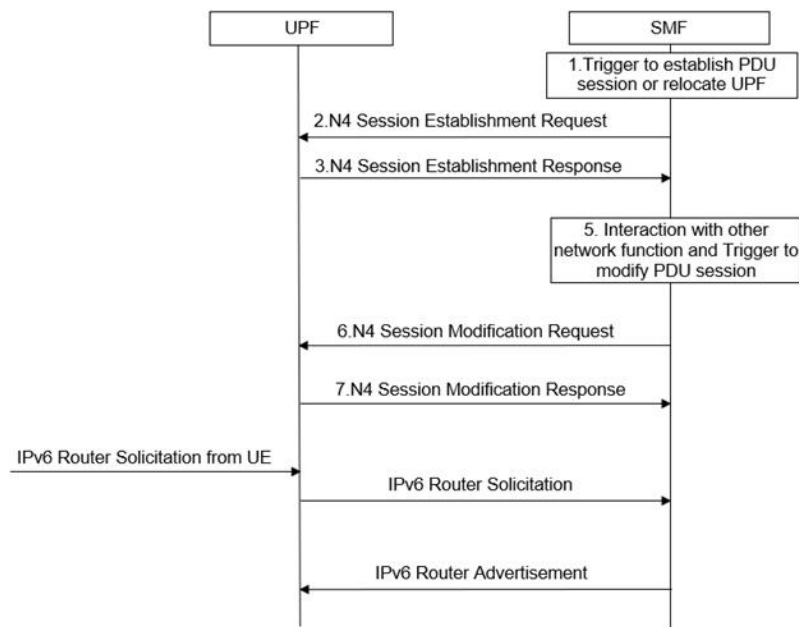

The IPv4v6 session establishment and modification procedure are similar to the IPv6 session establishment and modification procedure, except for the following procedures:

Step	Description
1	In the session establishment request, a PDR IE is created to include both IPv4 and IPv6 UE addresses. The SDF filter also includes the IPv4 and IPv6 filters for selecting the PDRs.
2	When the IPv6 address is assigned to the UE, an extra procedure – Router Solicitation and Router Advertisement – is required. The UE sends the Router Solicitation message to the network to receive the link layer address, once the session is established. The UPF forwards this message to the SMF and the SMF sends the Router Advertisement Message with the required parameters for configuring the IPv6 address of the UE.
3	The RS/RA between UPF and SMF is GTP-u encapsulated. In addition, the SMF sends an extra pair of PDRs during session establishment and modification procedure, in which the GTP-u tunnel IDs are exchanged for GTP-u tunneling.
4	The additional pair of PDRs that are sent from the SMF are as follows: <ul style="list-style-type: none"> • For forwarding IPv6 Router Solicitation from UE to SMF, one PDR's source interface is set to access, and its destination interface is set to CP-Function. The SDF filter is present in such a way that the UPF selects this specific PDR for the IPv6 Router Solicitation from the UE. • For instance, permit in 58 from any to ff01::2 any.
5	The UE sends the IPv6 traffic to PDN once the RS/RA procedure is complete.
6	No additional procedures are required for the IPv4 traffic for this PFCP session.

Configuring the N4 Session/Node Level Reporting Procedures

This section describes how to configure the N4 Session/Node Level Reporting procedures.

Enabling the GTP-u Echo Request Procedure

The existing CLI (Command Line Interface) in **gtpu-service** is used to enable the GTP-u Echo request procedure.

```

configure
  gtpu-service service_name
    echo-interval seconds
    echo-retransmission-timeout seconds
    max-retransmissions num
    path-failure detection-policy gtp echo
  end

```

NOTES:

- **gtpu-service service_name**: Creates a GTP-u service enters the GTP-u Service Configuration Mode for the current context. *service_name* specifies the name of the GTP-u service.

- **echo-interval** *seconds*: Configures the rate at which GTP v1-u echo packets are sent. *seconds* specifies the number of seconds between the sending of a GTP-uv1 echo packet. It must be an integer in the range of 60–3600.
- **echo-retransmission-timeout** *seconds*: Configures the timeout for GTP-u echo message retransmissions for this service. *seconds* specifies the echo retransmission timeout, in seconds, for the GTP-u service. It must be an integer in the range of 1–20. The default value is 5.
- **max-retransmissions** *num*: Configures the maximum retry limit for GTP-u echo retransmissions. *num* specifies the number of GTP-u echo message retransmissions allowed before triggering a path failure error condition. It must be an integer in the range of 0–15.
- **path-failure detection-policy gtp echo**: Configures a path failure detection policy on GTP-u echo messages that have been retransmitted the maximum number of retry times. **gtp echo** sets the detection policy to detect a failure upon reaching the maximum number of GTP-u echo message retransmissions.

The following is a sample configuration for enabling GTP-u Echo request procedure.

```
configure
  gtpu-service n3-gtpu-service
  echo-interval 60
  echo-retransmission-timeout 5
  max-retransmissions 5
  path-failure detection-policy gtp echo
end
```

Verifying the N4 Session/Node Level Reporting Procedure Configuration

This section describes how to verify the N4 Session/Node Level Reporting Procedure configuration.

N4 Session Node Level Reporting Procedure OA and M Support

Use the **show gtpu statistics** command to display the GTP-u statistics for Error Indication and GTP-u Echo Request and Response. The following is a sample output from the **show gtpu statistics** command.

```
show gtpu statistics
Path Management Messages:
  Echo Request Rx:                0 Echo Response Rx:                7
  Echo Request Tx:                19 Echo Response Tx:                0
  SuppExtnHdr Tx:                0 SuppExtnHdr Rx:                0

Peer Stats:
  Total GTPU Peers:                1
  Total GTPU Peers with Stats:    1

Tunnel Management Messages:
  Error Indication Tx:              0
  Error Indication Rx:              0
  Error Indication Rx Discarded:
```

Use the **show sx-service statistics all** command to display the Node report request and response statistics. The following is a sample output of the **show sx-service statistics all** command.

```
show sx-service statistics all
Node Report Request:
  Total TX:                1 Total RX:                0
  Initial TX:              1 Initial RX:                0
  Retrans TX:              0 Retrans RX:                0
  No Rsp received TX:      0 Discarded:                0
```

```

Node Report Response:
  Total TX:          0   Total RX:          1
  Initial TX:       0   Initial RX:       1
  Accepted:         0   Accepted:         1
  Denied:           0   Denied:           0
  Retrans TX:      0   Discarded:       0

```

Use the **show user-plane-service statistics all** command to display the statistics of N4 PFCP message parameters. The following is a sample output of the **show user-plane-service statistics all** command.

```

show user-plane-service statistics all
N4 Statistics:
  URR : Created      :          0
        Deleted     :          0
        Queried by ID :          0
        Queried by all :          0
        Total Queried :          0
  FAR : Created      :          0
        Updated     :          0
        Removed     :          0
  PDR : Predef rule  :          0

```



Note Statistics are cumulative, and are displayed as a total of all session managers.

The descriptions of the fields are as follows:

- URR Created: Displays the total number of URRs created either locally or as requested by the SMF.
- URR Deleted: Displays the total number of URRs removed either locally or as requested by the SMF.
- URR Queried by ID: Displays the total messages received to query a subset of URRs with their specific IDs.
- URR Queried by all: Displays the total messages received to query all the URRs of a session.
- URR Total Queried: Displays the total number of URRs reported to the SMF in response to "Queried by ID" and "Queried by all".
- FAR Created: Displays the total number of FARs created.
- FAR Updated: Displays the total number of FARs updated.
- FAR Removed: Displays the total number of FARs removed.
- PDR Predef rule: Displays the total number of CREATE PDRs that have predefined rules set. For one predefined rule two PDRs are received, and so the counter is updated as 2.



Note Total Predef counter isn't updated when a predefined rule is removed. SMF only sends Remove PDR message, which doesn't contain predefined rule name. Also, during HO, for exiting predef rule, PDRs are removed and created again, so it's counted twice for the same session.

SNMP Traps

The following traps are available to track status and conditions GTP-u path failure.

- **EGTPUPathFailure**: This trap is generated when no response is received for GTP-U ECHO requests and data path failure is detected toward a peer EPC Node.
- **EGTPUPathFailureClear**: This trap is generated when the data path toward the peer node is available.



CHAPTER 36

NRF Support

- [Feature Summary and Revision History, on page 353](#)
- [Feature Description, on page 354](#)
- [How it Works, on page 355](#)
- [Configuring NRF Management Services, on page 355](#)
- [Monitoring and Troubleshooting, on page 357](#)

Feature Summary and Revision History

Summary Data

Table 77: Summary Data

Applicable Product(s) or Functional Area	5G-UPF
Applicable Platform(s)	VPC-SI SMI
Feature Default Setting	Disabled - Configuration Required
Related Changes in this Release	Not Applicable
Related Documentation	Not Applicable

Revision History

Table 78: Revision History

Revision Details	Release
First introduced.	2022.04.0

Feature Description

In the 5G service-based architecture, the Network Repository Function (NRF) maintains an updated repository of all the 5G Network Functions (NFs) available in the operator's network. NRF also contains the details of the services provided by the 5G NFs, and allows the 5G NFs to instantiate, scale, and terminate without or minimal manual intervention.

NRF interacts with all NFs in the 5G core network, and provides the following services:

- Management Services
- Discovery Services
- OAuth2 Authorization
- Bootstrapping

The UPF supports only NRF Management Services.

NRF Management Services

The NRF Management (Nnrf_NFManagement) service enables the NF instances in the serving PLMN to register, update, or deregister their profiles in the NRF. The NF instance described here is the UPF StarOS based instance.

Figure 23: NRF Management

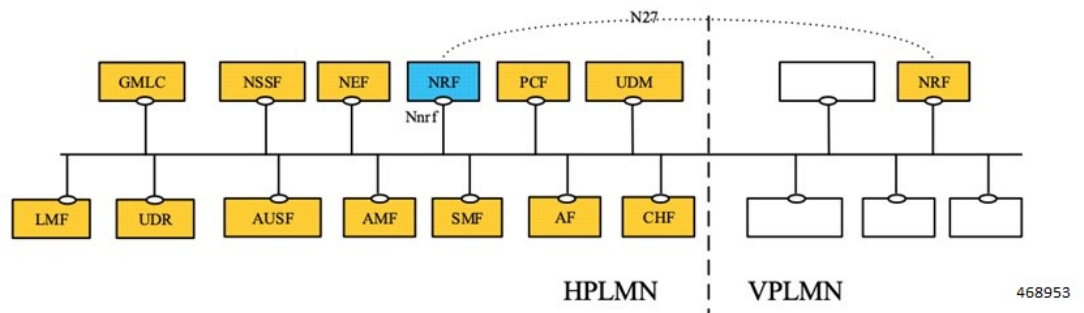

Presently, the Nnrf_NFManagement service provides the following operations:

- **Register NF instance (NFRegister)**—An NF instance registers its profile in the NRF along with the list of services that it provides.
- **Update NF instance (NFUpdate)**—An NF instance partially updates or replaces the NF profile parameters in the NRF. It also adds or deletes the services that it provides.

Currently, NFUpdate supports the following operations:

- Update of NF profile attributes
- Heartbeat of NF
- **De-register NF instance (NFDeregister)**—An NF instance deregisters its NF profile and the services that it provides in the 5G network.

How it Works

This feature enables management services between UPF and NRF.

UPF Registration

Once the minimal configuration is done, the UPF triggers the registration procedure toward the NRF. The Nrfmgr procllet receives the configuration from the SessCtrl, and selects the endpoint with the lowest priority-number. If Nrfmgr does not receive response from the NRF for a retry, then Nrfmgr selects the endpoint with the next lowest priority-number. This process continues with all the endpoints endlessly. To stop this process, you must delete the configuration.

UPF Heartbeat

Once the registration is complete, Nrfmgr checks if the "nr hb-enable" option is configured. If "nr hb-enable" is configured already, Nrfmgr builds or sends the Heartbeat Request message. Nrfmgr then starts the timer using the heartbeat timer-value received from peer NRF. If no heartbeat response is received until the heartbeat timer-value, Nrfmgr picks the endpoint with the next lowest priority-number. This process continues with all the endpoints in a round-robin fashion endlessly. To stop this process, you must delete the configuration.

UPF DeRegistration

Once the configuration is deleted, UPF sends an NRF Deregistration message to NRF from Nrfmgr, and thus NRF deregisters UPF.

Standards Compliance

The NRF Support feature complies with *3GPP TS 29.510 "5G System; Network function repository services; Stage 3"*.

Configuring NRF Management Services

NRF Profile Configuration

The NRF Profile configuration provides UPF the flexibility or control to define the optional parameters that must be sent toward the NRF. For example, if you configure locality in the NNRF Mgmt profile, and the NF profile is associated with the NNRF service, locality is sent to the NRF.

To configure the NRF profile in the UPF, use the following CLI commands:

```
configure
  context context_name
  user-plane-nnrf
    nrf-mgmt-format profile_name
    priority number
    locality string
```

```

    sst sst_number [ sd sd_number ]
    smf-serving-area area_n
  exit
exit

```

NOTES:

- **user-plane-nnrf**: Configures the UPF NRF profile.
- **nnrf-mgmt-format** *profile_name*: Configures the NNRF management profile to control the parameters that are sent to NRF.
- **priority** *number*: Specifies the priority of the UPF. If configured, the value is sent to NRF.
number must be an from integer from 1 to 100. Default: No value is sent to NRF.
- **locality** *string*: Specifies the locality of the UPF. If configured, this value is sent to NRF. The maximum length of *string* must be 63 bytes.
- **sst** *sst_number* [**sd** *sd_number*]: Specifies the Slice information of the UPF. If configured, this value is sent to NRF.
sst sst_number must be an integer from 0 to 255. Default: Slice/SST is not sent to NRF.
sd sd_number must be an integer from 0 to 16777215. If not configured, SD is not sent to NRF.
- **smf-serving-area** *area_n*: Specifies the SMF serving area of the UPF. You can configure up to five SMF areas.
The maximum length of *area_n* must be 63 bytes. If configured, the value is sent to NRF.

NRF Service Configuration

To configure NRF services in the UPF, use the following CLI commands:

configure

```

context context_name
  nnrf-nfm-service service_name
    associate nnrf-mgmt-format profile_name
    uri-scheme { http | https }
    hb-enable
    retransmission-timeout timeout_value
    max-retransmissions max_retries
    certificate path [ key path ] [ ca-certificate path ]
    endpoint-name endpoint_name
    priority number
    ipv4-address ipv4_address [ portv4 port_number ] [ ipv6-address
ipv6_address ] [ portv6 port_number ]
    exit
    bind ipv4-address ipv4_address [ portv4 port_number ] [ ipv6-address
ipv6_address ] [ portv6 port_number ]
    exit
  user-plane-service userplane_service
    associate nnrf-nfm-service service_name
    nf-instance-id number
  exit

```

exit
exit

NOTES:

- **nnrf-nfm-service** *service_name*: Configures the NRF service.
- **associate nnrf-mgmt-format** *profile_name*: Associates the NNRF management profile configuration. If not associated, the profile configurations such as *priority/slice/smfarea* are not sent in NFMgmt messages to the NRF.
- **uri-scheme** { **http** | **https** }: Specifies the URI Scheme that is used to send messages to NRF (HTTP or HTTPS). Default value: HTTP.
- [**no**] **hb-enable**: Enables or disables heartbeat messages to NRF.
- **retransmission-timeout** *timeout_value*: Specifies the retry timer-interval, in seconds, for an endpoint to send messages to NRF. *timeout_value* must be an integer from 1 to 100. Default value: 15 seconds.
- **max-retransmissions** *max_retries*: Specifies the maximum retries for sending messages to NRF. *max_retries* must be an integer from 1 to 20. Default value: three retries.
- **certificate** *path* [**key path**] [**ca-certificate path**]: Specifies the path to certificate or CA certificate, and key URLs.
- **endpoint-name** *endpoint_name*: Specifies the NRF endpoint. You must configure at least one endpoint to trigger messages from UPF to NRF.
- **priority** *number*: Specifies the NRF endpoint priority.
number must be an integer from 1 to 100. Default value: 50.
- **bind ipv4-address** *ipv4_address* [**portv4** *port_number*] [**ipv6-address** *ipv6_address*] [**portv6** *port_number*]: Binds an IPv4 or IPv6 address to NRF. This configuration is required to trigger messages from UPF to NRF. If configured, IPv6 is prioritized over IPv4.
- **user-plane-service** *userplane_service*: Defines the **user-plane-service** to **nnrf-nfm-service** association and the NF instance. This configuration is required to trigger messages from UPF to NRF.
- **associate nnrf-nfm-service** *service_name*: Specifies the associated **nnrf-nfm-service** service.
- **nf-instance-id** *number*: Specifies the NF instance ID in UUID format.

Monitoring and Troubleshooting

This section provides information about the CLI commands available for monitoring and troubleshooting this feature.

Show Commands and/or Outputs

This section describes the clear and show CLI commands for this feature.

- **clear nrf statistics**
- **show nrf statistics**

- **show nrf nrf-nfm-service all**
- **show nrf nrf-nfm-service name *service_name***

The following is a sample output of this command:

```

Service name:          nrf-svc1
VPN Name / Id:        ingress / 2
State :               Started
Timer Value :         15
Max Retries :         3
Heartbeat :           Enabled
Bind IPv4Addr:        209.165.201.2
Bind IPv4Port:        0
Bind IPv6Port:        0
URI Scheme :          HTTPS
NRF profile:          prof1

```

- **show nrf nrf-nfm-service name *service_name* statistics**

The following is a sample output of this command:

```

Service name:          nrf-svc1
Curr Endpoint:        end1
Curr State :           NRFMGMT_STATE_PENDING_REG

Statistics for endpoint name end1
=====

Num PUT Req          : 3
Num PATCH Req        : 0
Num PUT Success      : 0
Num PATCH Success    : 0
Num PUT Failed       : 3
Num PATCH Failed     : 0
Num DEL Req          : 0
Last Conn Req Time   : 2022-08-05+19:11:14
Num DEL Success      : 0
Last Conn Resp Time  : NA
Num DEL Failed       : 0

```

- **mon-pro support 18**



CHAPTER 37

Password Expiration Notification

- [Feature Summary and Revision History, on page 359](#)
- [Feature Description, on page 360](#)
- [Upgrading and Downgrading Procedures using Save Configuration Command, on page 361](#)

Feature Summary and Revision History

Summary Data

Table 79: Summary Data

Applicable Product(s) or Functional Area	5G-UPF
Applicable Platform(s)	VPC-SI SMI
Feature Default Setting	Disabled – Configuration Required
Related Changes in This Release:	Not Applicable
Related Documentation	<i>UCC 5G UPF Configuration and Administration Guide</i>

Revision History

Table 80: Revision History

Revision Details	Release
First introduced.	2022.01.0

Feature Description

If the password isn't reset before the expiration date, you get locked from the UPF. You're allowed to log in back only when the password is reset by the administrators manually.

UPF provides password expiration notification to Context/AAA/Radius users. UPF supports configuration and expiration of passwords for Administrators, Config Administrators, Inspectors, and Operators. Following provisions are supported:

- Specify the password warning interval. It warns you about password expiry.
- Specify the password grace interval. During this grace interval, you can change the password by yourself rather than approaching the Administrator every time.
- Warning interval and Grace interval have a global configuration under a context. If the user level configuration doesn't specify either of these values, global values under the context take effect.

The default values of the parameters are according to the Security Guidelines.

- Expiry Interval—Maximum age of the password (default: 90 days)
- Warn Interval—Warning period before password expiry (default: 30 days). You get a warning about approaching password expiry. You can continue without changing the password.
- Grace Interval—Days after password expiry you can use the old password. Beyond the grace period, you may not be able to log in with the old password. Admin has to reset the password for you.

For example:

```
login: xxx
password: xxx
```

```
Case 1: [Normal]
# {you are logged in}
```

```
Case 2: [When in warning period]
Warning: Your password is about to expire in 0 days.
We recommend you to change password after login.
Logins are not allowed without acknowledging this.
Do you wish to continue [y/n] (times out in 30 seconds) :
```

```
Case 3: [when in grace period]
Your password has expired
Current password:
New password:
Repeat new password:
```

```
Case 4: [after the grace period]
Password Expired (even beyond grace period, if configured). Contact Security Administrator
to reset password
```

Upgrade and Downgrade Enhancement for Password Expiration Notification

Password Expiry Notification feature has introduced many new keywords in Subscriber configuration such as **max-age**, **exp-grace-interval**, and **exp-warn-interval**. These new parameters are configured at the Context Global level. Context Global level parameters are used when per user level configuration isn't configured with a default value. For example, for the **max-age** of the password, the default value is 90 days.

For the user profiles with no "expiry-date" at per user level, startup config takes an expiry date of 90 days for that user. This problem can be solved by manually editing the startup configuration file, but this solution leads to issues when users are distributed across locations.

In case if downgrade is needed, user profiles are lost as new keywords aren't valid for older releases.

With the password expiration notification enhancement, the upgrade procedure is updated, and the downgrade process is changed with the help of new **save config** CLI option, **legacy-password-expiry**.

Upgrading and Downgrading Procedures using Save Configuration Command

Use the following upgrade process:

- Before upgrade, add **no password max-age** command at context level, in all contexts where users are configured, in the startup configuration.
- When reloading with image using the updated startup config, all users that are configured without an expiry date pick up the context level configuration by default and set the user level **no-max-age** keyword automatically.

Use the following downgrade process:

Use the new CLI option, **legacy-password-expiry** in the save config command, based on which new keywords aren't saved. Configuration is stored in a format which the previous release recognizes.

The following prompt is displayed in the Exec mode:

```
configure
  context host_name
    save configuration url [ confd | ignore-locks | obsolete-encryption
| showsecrets | verbose ] [ -redundant ] [ -noconfirm ] [
legacy-password-expiry ]
```

Notes:

- **save configuration** *config-file-path* **legacy-password-expiry**:

Generates a backward compatible file by removing new Expiry Notification keywords. The **save config** CLI option makes the configuration compatible with older UPF versions.

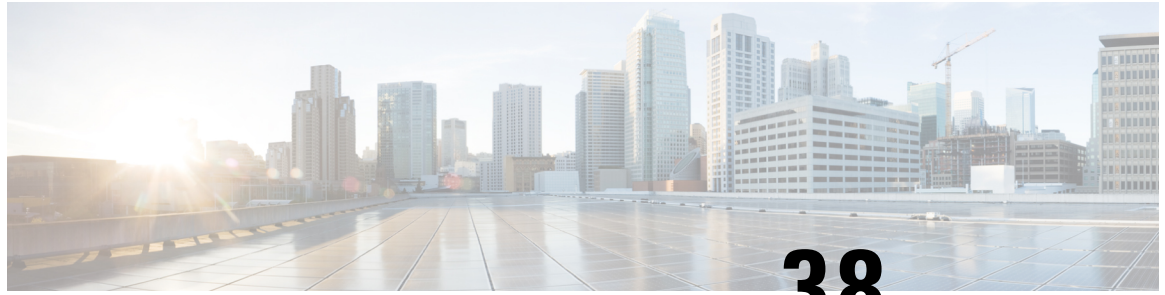

CHAPTER 38

QCI 80 Support on UPF

- [Feature Summary and Revision History, on page 363](#)
- [Feature Description, on page 364](#)
- [How it Works, on page 364](#)
- [Configuring ADC Rule, on page 366](#)
- [Monitoring and Troubleshooting, on page 367](#)

Feature Summary and Revision History

Summary Data

Table 81: Summary Data

Applicable Product(s) or Functional Area	5G-UPF
Applicable Platform(s)	VPC-SI SMI
Feature Default Setting	Enabled – Always-on
Related Changes in this Release	Not Applicable
Related Documentation	<i>UCC 5G UPF Configuration and Administration Guide</i>

Revision History

Table 82: Revision History

Revision Details	Release
First introduced.	2022.01.1

Feature Description

The 5G-UPF supports new standard QoS Class Index (QCI) 80 based on 3GPP TS 23.203, for establishing a non-GBR QoS flow when an application sends traffic to the specific destination.

How it Works

Dynamic QoS Flow Establishment based on Detected Traffic

To establish a dynamic QoS flow when traffic is detected, UPF uses the Application Detection and Control (ADC) over Gx feature.

On receiving a PCC predefined rule over default 5G QoS Identifier (5QI) for application detection and control, the SMF instructs the UPF to detect application traffic. The UPF installs the Gx ADC PDR with default QFI, and the rule name is considered as Application ID for reporting to the SMF.

On detecting a new flow hitting the Gx ADC predefined rule, the UPF triggers an Application Start event. When the application traffic is identified by an application identifier, the SMF reports the start of application to the PCF.

The PCF then makes policy decisions based on the information received and sends the corresponding updated PCC rules (with QCI-80) to the SMF.

Call Flow

The following figure shows the call flow details and the message exchanges in a 5G core system.

ADC Rule Activation and Functioning

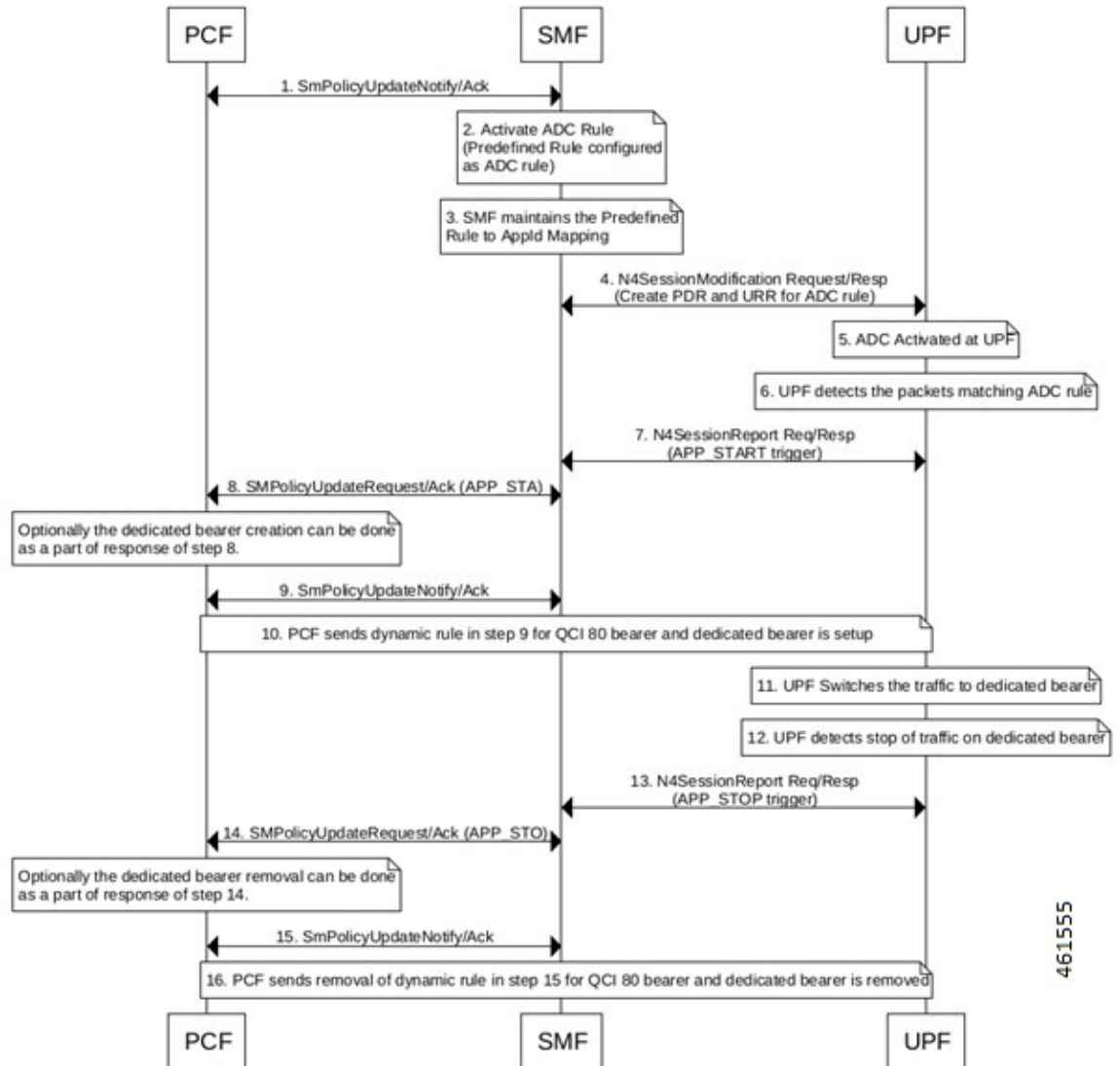

461555

Step	Description
1	The PCF sends SmPolicyUpdateNotify to SMF, and receives an acknowledgment.
2	SMF activates the ADC rule (Predefined rule).
3	SMF maintains the predefined rule for Application ID mapping.
4	SMF sends the N4 Session Modification Request to UPF, and receives a response from UPF.
5	ADC is activated at the UPF.
6	UPF detects the packets matching ADC rule.

Step	Description
7	UPF sends the N4SessionUpdate request to the SMF, and receives a response from the SMF. UPF triggers Application Start.
8	SMF sends the SmPolicyUpdate Request to PCF, and receives an acknowledgment from the PCF. Optionally, the dedicated bearer is created as part of response.
9	PCF sends SmPolicyUpdateNotify to SMF, and receives an acknowledgment from SMF.
10	PCF sends dynamic rule for QCI 80 bearer, and a dedicated bearer is setup.
11	UPF switches the traffic to dedicated bearer.
12	UPF detects stop of traffic on dedicated bearer.
13	UPF sends the N4SessionUpdate request to the SMF, and receives a response from the SMF. UPF triggers Application Stop.
14	SMF sends the SmPolicyUpdate Request to PCF, and receives an acknowledgment from the PCF. Optionally, the dedicated bearer is removed as part of response.
15	PCF sends SmPolicyUpdateNotify to SMF, and receives an acknowledgment from SMF.
16	PCF sends removal of dynamic rule for QCI 80 bearer, and the dedicated bearer is removed.

Limitations

The following is the known limitation to this feature in this release:

- Gx ADC predefined rule is installed only with default bearer 5QI.

Configuring ADC Rule

To support activation of predefined ADC rules, you must configure the ADC rule in SMF with appropriate action priority, and **adc** keyword. The following is a sample configuration:

```

active-charging service service_name
    rulebase rulebase_name
        action priority action_priority dynamic-only adc ruledef ruledef_name
    charging-action charging_action_name
    exit
ruledef ruledef_name
    ip server-ip-address ipv4/ipv6_address/mask
    ip server-ip-address ipv4/ipv6_address/mask
    exit
exit

```

To mute the reporting, use the following CLI command under rulebase configuration:

```
action priority action_priority dynamic-only adc mute ruledef ruledef_name
charging-action charging_action_name
```

To optimize the application reporting once per application, use the following CLI command under rulebase configuration:

```
adc app-notification once-per-app
```

To optimize the application reporting once per application per flow, use the following CLI command under rulebase configuration:

```
adc app-notification once-per-ipflow
```

NOTES:

- **rulebase** *rulebase_name*: Enables the Active Charging Service Rulebase configuration
- **action priority** *action_priority*: Assigns priority to a ruledef in the rulebase. Priority must be a unique integer value ranging 1–65535.
- **dynamic-only**: Enables matching of dynamic rules with static rules for this action priority on a flow.
- **adc**: Specifies the ruledef to-be given as ADC rule.
- **ruledef** *ruledef_name* : Adds the specified ruledef to the current rulebase.
- **charging-action** *charging_action_name*: Specifies the charging action.
- **description** *description*: Adds specified text to the rule and action.
- **ip server-ip-address** *ipv4/ipv6_address/mask*: Specifies the server IP address with subnet mask bit. For uplink packets (subscriber to network), this field matches the destination IP address in the IP header. For downlink packets (network to subscriber), this field matches the source IP address in the IP header.
- **once-per-app**: Notifies APP_START or APP_STOP notification once per App ID.

Whenever traffic for an application is detected, the UPF sends APP-START notification to the SMF with an Application Instance Identifier as the Flow-Id of the first data flow of an application. This application instance Id gets cached in the User Plane. When the last data flow of an application is terminated, the cached application instance Id is sent in APP-STOP notification so that PCF can better correlate APP-START and APP-STOP.

- **once-per-ipflow**: Notifies APP_START or APP_STOP notifications per App ID per IP flow.

Monitoring and Troubleshooting

This section provides information on CLI commands that are available for monitoring and troubleshooting the feature.

Show Commands to Display PDR and URR

Use the following command on UPF to display the PDR for which ADC is enabled:

```
show subscribers user-plane-only callid callid_value pdr full all
```

Use the following command on UPF to display the URR for which ADC is enabled:

```
show subscribers user-plane-only callid callid_value urr full all
```

Show Commands to Display ADC Statistics

Use the following command on UPF to display the ADC statistics:

```
show subscribers user-plane-only callid callid_value adc statistics
```



CHAPTER 39

QoS Group of Ruledefs Support

- [Feature Summary and Revision History, on page 369](#)
- [Feature Description, on page 370](#)
- [How it Works, on page 370](#)
- [OAM Support, on page 372](#)

Feature Summary and Revision History

Summary Data

Table 83: Summary Data

Applicable Product (s) or Functional Area	5G-UPF
Applicable Platforms	VPC-SI SMI
Feature Default Setting	Disabled – Configuration Required
Related Changes in this Release	Not Applicable
Related Documentation	<i>UCC 5G UPF Configuration and Administration Guide</i>

Revision History

Revision Details	Release
First introduced.	2023.01.0

Feature Description

The QoS Group of Ruledefs feature helps in enforcing fair usage policy (FUP) per subscriber. QoS Group of Ruledefs is also referred to as QGR or SGQ.

The QGR feature sets different QoS parameters for different subscribers for a named QGR, therefore ensuring fair usage policing for a subscriber.

How it Works

The QGR feature performs flow status and bandwidth limiting under the charging-action configuration. UPF applies the static configuration for QGR using RCM.

When a packet matches a ruledef, UPF performs a QGR match to check if a QGR is present with the matched ruledef or group. UPF returns the highest priority QGR.

- If a QGR matches, UPF applies flow-action enforcement at charging-action, and then at QGR if charging-action allows the packet. If the packet drops, UPF skips the QGR-level flow-action enforcement.
- If flow-action at QGR allows the packet, UPF enforces the QoS Enforcement Rule (QER) limiting on a packet. If the packet drops at QGR, UPF skips QER limiting.
- UPF performs QER limiting at charging-action and then at QGR if the packet is allowed at charging-action.

UPF supports QoS-group-of-ruledefs configuration under the ACS service.

The following is a sample QGR configuration under ACS:

```
configure
  active-charging service acs
    qos-group-of-ruledefs QGR1
      add-group-of-ruledef group
      add-ruledef http
      #exit
  rulebase test
    action priority 2 ruledef http charging-action standard
    action priority 5 ruledef catchall charging-action standard
    route priority 1 ruledef http-rule analyzer http
  end
```

The following configuration is an example of QoS Group "QGR1" received over PCRF:

```
-qos-group-rule-install
--qgr-name QGR1
--qgr-mon-key 1
--qgr-flow-status 2
--qgr-precedence 1
--qgr-eqos-information
--qgr-eqos-mbr 1000 2000
--qgr-eqos-mbr-burst-size 1000 2000
--qgr-eqos-mbr-limit-conform-action 0 -1 0 -1
--qgr-eqos-mbr-limit-exceed-action 1 -1 1 -1
```

IE Support

UPF pushes the QGR in Session Establishment Request or Session Modification Request using the private IE—QGR-INFO-LIST. If there are changes to the QGR dynamic parameters, UPF triggers an Update FAR or QER. UPF sends the updated value in Session Establishment Request or Session Modification Request.

Currently, UPF does not support the monitoring-key parameter in QGR. Hence, UPF does not send URR associated with QGR in Session Establishment Request or Session Modification Request.

The following is the name and format of the private IE:

```
QGR-INFO-LIST:
Value:
Number of QGRs: 2
QGR INFO:
NAME: qgr-gor
PRECEDENCE: 3
OPERATION: QGR ADD
FAR ID: 0x8005
QER ID: 0x0004
QGR INFO:
NAME: qgr2
PRECEDENCE: 9
OPERATION: QGR ADD
FAR ID: 0x8006
QER ID: 0x0005
```

The following table describes the FAR format:

Table 84: FAR Format

FAR ID	Unique ID
Apply Action	Flow-action defined in QGR.
Extended Apply Action	Private IE to communicate to QGR FAR. This IE includes Flow-Action—Discard Uplink, Discard Downlink, and Terminate Flow.
Forwarding Parameters	Contains the destination interface and redirect information if any.

The following table describes the QER format:

Table 85: QER Format

QER ID	Unique ID
Maximum Bitrate	The maximum bit rate of QGR in Kbps. UL MBR DL MBR
Burst Size	Private IE to configure the burst size. UL Burst DL Burst
Conform Action	Private IE to configure the conform action. Uplink ToS Downlink ToS

QER ID	Unique ID
Exceed Action	Private IE to configure the exceed action. Uplink Action Uplink ToS Downlink Action Downlink ToS

Use the **show subscribers user-plane-only callid *call_id* { far | qer } full all** command to view the FAR and QER values.

Limitations

The QGR feature has the following limitations:

- The monitoring key associated with QGR is not usage monitored, that is, UPF does not support URR creation and enforcement.
- UPF does not support the inclusion of dynamic rules in the static QGR definition.
- UPF does not support flow-Status redirect and kill flow.
- UPF does not support QoS Group Conform action as Drop and Exceed action as ALLOW or MARK_DSCP.
- UPF supports a maximum configuration of 64 QGRs statically.
- UPF supports a maximum of 64 QGRs received from SMF.

OAM Support

This section describes the operations, administration, and maintenance information for this feature.

Show Commands Support

This section provides information regarding show commands and their outputs in support of the QGR feature.

show subscribers user-plane-only callid *call_id* far full all

This command displays the Extended Apply Action IE information on UPF.

```
[local]qvpcc-si# show subscribers user-plane-only callid 00004e21 far full all
FAR-ID          : 0x8004
  Destination Interface      : Core
  Apply Action               : FORWARD
  Outer Header Creation     :
  Remote TEID               : 0x0
  Transport Level Marking    : N/A
  Transport Level Marking Options :
    Copy Inner:              No
    Copy Outer:              No
  Inner Packet Marking      : N/A
  Remote IP Address         :
  Remote Port               : N/A
```

```

Number of Associated PDRs: 0
Associated with QGR      : Yes
Extended Apply Action   : ULDROP DLDROP

```

show subscribers user-plane-only callid call_id qer full all

This command displays the bandwidth parameters associated with QGR on UPF.

```
[local]qvpc-si# show subscribers user-plane-only callid 00004e21 qer full all
```

```

QER-id          : 0x00000003          Correlation-id      : n/a
GBR uplink (bps) : 0                  GBR downlink (bps)  : 0

UL Gate Status   : OPEN                DL Gate Status      : OPEN
Number of Associated PDRs : 0
Associated with QGR : Yes
MBR uplink (bps) : 1000                MBR downlink (bps)  : 2000
UL Burst      : 1000                DL Burst      : 1000

Action      : ALLOW                DL Conform
                UL Conform Action      : ALLOW
                UL DSCP Value         : NA                DL DSCP Value
                : NA
                UL Exceed Action      : DROP              DL Exceed Action
: DROP
                UL DSCP Value         : NA                DL DSCP Value
                : NA

```

show subscribers user-plane-only callid call_id qos-group all

This command displays the QGR information from QGR-INFO-LIST IE on UPF.

```
[local]qvpc-si# show subscribers user-plane-only callid call_id qos-group
all name statistics
[local]qvpc-si# show subscribers user-plane-only callid 00004e21 qos-group all
```

```

Callid: 00004e21
Interface Type: Sxb
  QGR-Name:      Priority:      FAR-ID:      QER-ID:      URR-ID:
  -----      -
  QGR1          5          0x8003      0x0002      0x0000
  QGR2          1          0x8004      0x0003      0x0000

```

```
Total Number of QGRs found: 2
```

show subscribers user-plane-only callid call_id qos-group statistics

This command displays QoS-group statistics on UPF.

```
[local]qvpc-si# show subscribers user-plane-only callid 00004e21 qos-group statistics
all name | <cr>
QoS-Group-of-Ruledef:
  Total Uplink Pkts:          0      Total Dnlink Pkts:          0
  Total Uplink Bytes:         0      Total Dnlink Bytes:         0
  Uplink Pkts Allowed:        0      Dnlink Pkts Allowed:        0
  Uplink Bytes Allowed:       0      Dnlink Bytes Allowed:       0
  Uplink FP Pkts:             0      Dnlink FP Pkts:             0
  Uplink FP Bytes:            0      Dnlink FP Bytes:            0
  Flow-Status Statistics:
    Total Uplink Packets:      0      Total Downlink Packets:      0

```

show subscribers user-plane-only full all

```

Total Uplink Bytes:          0      Total Downlink Bytes:          0
Uplink Packets Redirected:  0      Downlink Packets Redirected:  0
Uplink Bytes Redirected:    0      Downlink Bytes Redirected:    0
Uplink Packets Dropped:     0      Downlink Packets Dropped:     0
Uplink Bytes Dropped:       0      Downlink Bytes Dropped:       0
Uplink Packets Term-Flow:   0      Downlink Packets Term-Flow:   0
Uplink Bytes Term-Flow:     0      Downlink Bytes Term-Flow:     0
Bandwidth-Control Statistics:
Total Uplink Packets:        0      Total Downlink Packets:        0
Total Uplink Bytes:          0      Total Downlink Bytes:          0
Uplink Packets QoS-Exceed:   0      Downlink Packets QoS-Exceed:   0
Uplink Bytes QoS-Exceed:     0      Downlink Bytes QoS-Exceed:     0
Uplink Packets QoS-Conform:  0      Downlink Packets QoS-Conform:  0
Uplink Bytes QoS-Conform:    0      Downlink Bytes QoS-Conform:    0
Uplink Packets Dropped:     0      Downlink Packets Dropped:     0
Uplink Bytes Dropped:       0      Downlink Bytes Dropped:       0
Uplink Packets Marked:      0      Downlink Packets Marked:      0
Uplink Bytes Marked:        0      Downlink Bytes Marked:        0

Total qos-group-of-ruledefs matched: 2

Total subscribers matching specified criteria: 1

```

show subscribers user-plane-only full all

This command displays the number of per subscriber QoS-groups that UPF has successfully activated and the QoS-group statistics matched for data packets.

```

[local]qvpcc-si# show subscribers user-plane-only full all

Local SEID      : [0x0004000000000000] 1125899906842624
Remote SEID     : [0x0004000000000000] 1125899906842624
State          : Connected
Connect Time    : Wed Mar 18 07:53:57 2020
Idle time       : 18h53m24s
Access Type: uplane-ipv4          Network Type: IP
user-plane-service-name: user-plane-service
Callid: 00004e21
Rulebase: prepaid
Interface Type: Sxb
Card/Cpu: 1/0                    Sessmgr Instance: 1
IP address: 10.0.0.1
Source context: ingress          Destination context: egress
PDN-Instance: intershat
User-plane-Sx-addr: 192.60.182.1
Control-plane-Sx-addr: 192.60.181.1
Number of associated PDRs : 0
Number of associated ADC PDRs : 0
Number of associated FARS : 1
Number of associated QERs : 2
Number of associated URRs : 3
....
....
....
CC Dropped Uplink bytes: 0      CC Dropped Downlink Bytes: 0
Uplink Inflight Pkts: 0      Downlink Inflight Pkts: 0
Total QoS-Group(s) Active: 1

Flow information:
Current Active Flows:
TCP: 0
UDP: 0
Total Flows:

```

```
TCP: 2
UDP: 0
FP: 0
```

Static & Predef Rule Match stats:

Rule Name	Pkts-Down	Bytes-Down	Pkts-Up	Bytes-Up	Hits	Match-Bypassed
FP-Down (Pkts/Bytes)	FP-Up (Pkts/Bytes)					
http	2	1352	2	250	4	0
0/0	0/0					
catchall	4	160	8	320	12	0
0/0	0/0					

Dynamic Rule Match stats:

PDR Id	Pkts-Down	Bytes-Down	Pkts-Up	Bytes-Up	Hits	Match-Bypassed
FP-Down (Pkts/Bytes)	FP-Up (Pkts/Bytes)					

Post-Processing Rule Match stats:

Rule Name	Pkts-Down	Bytes-Down	Pkts-Up	Bytes-Up	Hits	Match-Bypassed
FP-Down (Pkts/Bytes)	FP-Up (Pkts/Bytes)					

QoS-Group Statistics:

QGR Name	Pkts-Down	Bytes-Down	Pkts-Up	Bytes-Up	Hits	Match-Bypassed
	FP-Down (Pkts/Bytes)	FP-Up (Pkts/Bytes)				
QGR1	3	756	5	285	8	0
	0/0		0/0			

show user-plane-service qos-group-of-ruledefs

This command displays the static QoS-groups configuration received on UPF through PFD.

```
[local]qnpc-si# show user-plane-service qos-group-of-ruledefs
all name
[local]qnpc-si# show user-plane-service qos-group-of-ruledefs all
QoS-Group-of-Ruledefs Name: QGR1
Ruledef Name
=====
group
```

Total QoS group(s) of ruledefs found: 1

show user-plane-service statistics qos-group sessmgr

This command displays cumulative statistics across all QoS-Groups.

```
[local]laas-si-setup# show user-plane-service statistics qos-group sessmgr
1..1152 all

Sessmgr Instance: 1
Total Uplink Pkts: 5 Total Dnlink Pkts: 3
Total Uplink Bytes: 274 Total Dnlink Bytes: 756
Uplink FP Pkts: 0 Dnlink FP Pkts: 0
Uplink FP Bytes: 0 Dnlink FP Bytes: 0
Flow-Status Statistics:
Total Uplink Packets: 5 Total Downlink Packets: 3
Total Uplink Bytes: 274 Total Downlink Bytes: 756
```

```
show user-plane-service statistics qos-group sessmgr
```

```
Uplink Packets Redirected:      0      Downlink Packets Redirected:      0
Uplink Bytes Redirected:       0      Downlink Bytes Redirected:       0
Uplink Packets Dropped:        0      Downlink Packets Dropped:        0
Uplink Bytes Dropped:          0      Downlink Bytes Dropped:          0
Uplink Packets Term-Flow:      0      Downlink Packets Term-Flow:      0
Uplink Bytes Term-Flow:        0      Downlink Bytes Term-Flow:        0
Bandwidth-Control Statistics:
Total Uplink Packets:          5      Total Downlink Packets:          3
Total Uplink Bytes:           274     Total Downlink Bytes:            756
Uplink Packets QoS-Exceed:     0      Downlink Packets QoS-Exceed:     0
Uplink Bytes QoS-Exceed:       0      Downlink Bytes QoS-Exceed:       0
Uplink Packets QoS-Conform:    5      Downlink Packets QoS-Conform:    3
Uplink Bytes QoS-Conform:     274     Downlink Bytes QoS-Conform:     756
Uplink Packets Dropped:        0      Downlink Packets Dropped:        0
Uplink Bytes Dropped:          0      Downlink Bytes Dropped:          0
Uplink Packets Marked:         0      Downlink Packets Marked:         0
Uplink Bytes Marked:           0      Downlink Bytes Marked:           0
```



CHAPTER 40

Roaming Support

- [Feature Summary](#) , on page 377
- [Feature Description](#), on page 378
- [How it Works](#), on page 381
- [Configuring the HR Roaming Support for UPF](#), on page 398
- [Monitoring and Troubleshooting](#), on page 400

Feature Summary

Summary Data

Table 86: Summary Data

Applicable Product(s) or Functional Area	5G-UPF
Applicable Platform(s)	VPC-SI SMI
Feature Default Setting	Enabled – Always-on
Related Changes in this Release	Not Applicable
Related Documentation	Not Applicable

Revision History

Table 87: Revision History

Revision Details	Release
UPF supports inter-PLMN roaming mobility and secondary PDR for 5G sessions.	2023.03.0

Revision Details	Release
UPF supports the following roaming functionalities: <ul style="list-style-type: none"> • Source Interface Type IE indicates the 3GPP Interface Type • Subscriber Params IE indicates the roaming status 	2023.02.0
First introduced.	2021.02.0

Feature Description

The mobile network operators form roaming partnerships to provide seamless services to their subscribers in geographies beyond their network reach. Operator network boundaries are designated by public land mobile networks (PLMN). The home network for a subscriber is called an HPLMN and the visited network, which renders the mobile service is termed as the VPLMN.

The VPLMN provides access network services and packet routing to the packet core, whereas the HPLMN provides data network access to the subscriber. This feature enables the UPF to support the flavor of routing that is termed as the Home Routed (HR) roaming.

Visited UPF (vUPF) supports the following functionalities:

- Handle the dummy PDRs with associated FAR action as buffer
- Buffer the incoming packets before rule matching
- Handle the QoS and FAR updates from the SMF for debuffering of packets
- Send the buffered packets after matching with the PDR
- Send vUPF traffic over Fast Path
- Send N9 interface GTP-U tunnel
- UPF LI support is extended for roaming
- MonSub CLI command and PCAP file support

vUPF and Home UPF (hUPF) support the following functionalities:

- QoS flow Based Charging (QBC) on the UPF
- Source Interface Type IE in PDR indicates the 3GPP Interface Type in UPF
- Selection of the GTP-U service by receiving 3GPP Interface Type received in PDI IE of create PDR.
- Subscriber Params IE indicates the roaming status in UPF

Relationships

The roaming status functionality relates to the UPF Ingress Interfaces feature that indicates the following types of roaming:

- Homer
- Roamer
- Visited LBO
- Visited HR

The UPF supports different GTP-U ingress interfaces. It allows a separate network for the N3 interface and N9, S5u, and S8u interfaces.

The GTP-U ingress interfaces to handle roaming and outbound calls include:

- N3—N3 is the interface between gNodeB and UPF. To handle 5G home calls, the N3 interface must be a private IP address.
- N9—The N9 interface connects two UPFs. It is the interface between intermediate I-UPF and UPF session anchor connecting different PLMN. To handle 5G outbound roaming calls, the N9 interface must be a public IP address.
- S5u—S5u is similar to the N9 interface that connects two UPFs. The interface connects the intermediate I-UPF and UPF session anchor. To handle 4G inbound calls, the S5u is set to a public IP since the SGW-U is public for enabling the S-GW.
- S8u—S8u is an inter-PLMN variant of the S5u interface. To handle 4G outbound roaming calls, the S8u interface must be a public IP address.

For more information, refer to the *UPF Ingress Interfaces* chapter.

Architecture

This section describes the architecture for the home routing roaming support feature.

Buffering and Debuffering on the vUPF

The buffering and debuffering procedure on the vUPF for the UPF HR roaming, are as follows:

1. Two dummy PDRs (UL or DL) is created initially at vUPF by vSMF with default value as QFI and the buffering as an FAR action.
2. The packets coming from the N3 and N9 interfaces get buffered based on the FAR action before doing a packet classification and application of policy.
3. If buffered packet count exceeds the configured limits then the subsequent packets are dropped.
4. The buffered packets are sent for classification and policy application after the update FAR is received with action as forward and updated TEID in modify request from vSMF.
5. The vSMF initiates the removal of default QER and URR while sending the update FAR with action forward and sends a new PDR with the required QER and URR.
6. The packets are sent on the required interface that is based on the QFI defined in the new QER.
7. If there is no matching PDR with TEID and QFI installed then the debuffered packets is dropped.

Charging — Predef and Dynamic Rules on the hUPF

The charging predef and dynamic rules on the hUPF, are as follows:

1. The SMF associates FBC URRs + QBC URRs + Session URRs with dynamic PDRs.
2. The SMF associates QBC URRs + Session URRs with predef PDRs.
3. The UPF associates the URRs created by installed global PDRs to the received predef PDRs QBC URRs + Sess URRs.
4. The QBC URRs have no Linked URRs.
5. The QBC URRs include no FBC URRs or Session URRs usage reporting.
6. The UPF links the Session URRs to FBC URRs as Linked URRs.
7. The Session URRs include FBC URRs and QBC URRs usage reporting.
8. The UPF relies on the SMF for the update or removal of each of the QBC and Sess URRs.

Charging — Static Rules on the hUPF

The charging static rules on the hUPF, are as follows:

1. The SMF associates FBC URRs + QBC URRs + Session URRs with RB PDRs.
2. The UPF associates the URRs created by installed global PDRs to the received RB PDRs QBC URRs + Sess URRs.
3. The UPF does not link QBC URRs with any URRs.
4. The UPF links the static FBC URRs with the Session URRs.
5. The UPF links the Session URRs to the FBC URRs as linked URRs for usage reporting.
6. The UPF relies on the SMF for the update or removal of each of the QBC and the SMF URRs.

Inter-PLMN Mobility Support

The Inter-Public Land Mobile Network (Inter-PLMN) mobility feature allows the PLMN to change from home-PLMN to visited-PLMN when a User Equipment (UE) moves from its home network to a visited network and vice-versa. This feature provides support for various types of Inter-PLMN mobility cases.

For information on the call flows related to inter-PLMN handover, see the *How it Works* section.

H-UPF Data Path specifications:

- Secondary PDR optimization for Homer calls
- Inter-PLMN and Intra-PLMN handover support with optimization
- Supports GTPU services for Homer calls
- KPI support for Secondary PDR info in PDR
- Handover statistics

UPF supports the following scenarios for various Inter-PLMN mobility:

- 5G homer to 5G roamer
- 5G homer to 4G roamer
- 4G homer to 5G roamer
- 4G homer to 4G roamer
- 5G roamer to 5G homer
- 5G roamer to 4G homer
- 4G roamer to 5G homer
- 4G roamer to 4G homer

UPF supports the following scenarios for various Intra-PLMN mobility:

- 5G homer to 4G homer
- 4G homer to 5G homer
- 5G roamer to 4G roamer
- 4G roamer to 5G roamer
- EUTRAN to WiFi and vice-versa handover

How it Works

This section describes the call flows related to the roaming feature in UPF.

PDU Session Establishment Procedure

This call flow describes the PDU Session Establishment procedure for the UPF.

Figure 24: PDU Session Establishment Call Flow

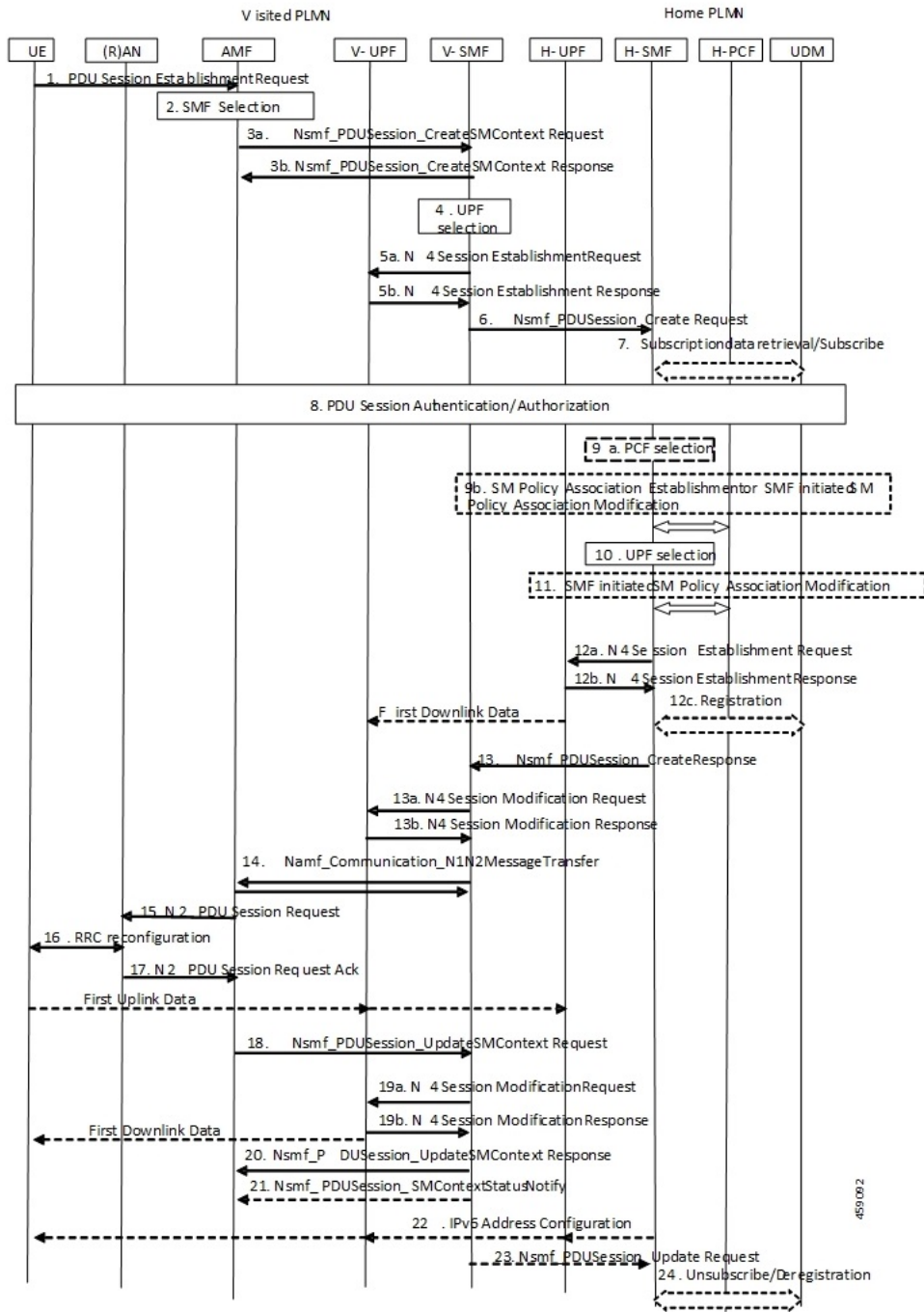

Table 88: PDU Session Establishment Call Flow Description

Step	Description
1	The UE initiates a PDU Session Establishment Request to the AMF.

Step	Description
2	The AMF selects an SMF.
3a	The AMF invokes the Nsmf_PDUSession_CreateSMContext Request and sends it to the vSMF.
3b	The vSMF sends a Nsmf_PDUSession_CreateSMContext Response to the AMF.
4	The vSMF selects a UPF in VPLMN.
5a	The vSMF sends an N4 Session Establishment Request with dummy PDRs, FARs, QERs, or URRs to the vUPF. In this request, the vSMF informs the vUPF to allocate the CN Tunnel information for the N3 and N9 interfaces. The vSMF sends Source Interface Type IE in Access PDR as N3 3GPP Access (11), and in Core PDR as N9 (21) for roaming.
5b	The vUPF creates the N3 and N9 CN tunnel information and acknowledges by sending this information in an N4 Session Establishment Response.
6	The vSMF sends an Nsmf_PDUSession_Create Request to the hSMF.
7	The hSMF registers with the UDM for a given PDU session.
8	The SMF performs a secondary authorization or authentication during the establishment of the PDU session by a DN-AAA server.
9a	The hSMF selects the PCF.
9b	The SMF performs an SM Policy Association Establishment procedure to establish an SM Policy Association with the PCF and get the default PCC rules for the PDU session.
10	The hSMF selects the UPF.
11	The hSMF initiates an SM Policy Association Modification procedure.
12a	The hSMF initiates an N4 Session Establishment procedure with the selected UPF. The N9 CN tunnel information from the vUPF is transferred to hUPF in FAR. The hSMF sends Source Interface Type in Access PDR as N9(21) or N3 3GPP ACCESS (11) or S5u interface depending on the RAT and roaming status where it registers the call.
12b	The UPF acknowledges by sending an N4 Session Establishment Response. The hUPF provides the N9 CN tunnel information to the vUPF.
12c	The downlink path is established between the hUPF and vUPF and data packets are sent to the vUPF where it gets buffered.
13	The hSMF sends an Nsmf_PDUSession_Create Response message to the vSMF.
14	The vSMF sends an Namf_Communication_N1N2MessageTransfer message to the AMF.
15	The AMF sends the NAS message containing PDU Session ID and PDU Session Establishment Accept targeted to the UE and the N2 SM information received from the SMF within the N2 PDU Session Request to the RAN.
16	The RAN issues AN specific signalling exchange with the UE that is related with the information received from SMF.

Step	Description
17	The RAN sends an N2 PDU Session Response message to the AMF.
18	The AMF sends the Nsmf_PDUSession_UpdateSMContext Request message to the vSMF. The AMF forwards the N2 SM information received from RAN to the vSMF.
19a	The vSMF initiates an N4 Session Modification procedure with the vUPF. The vSMF provides packet detection, enforcement, and reporting rules to be installed on the vUPF for this PDU session, including AN Tunnel Information, H-CN Tunnel Information and V-CN Tunnel Information.
19b	The vUPF provides an N4 Session Modification Response to the vSMF. After this step, the vUPF delivers any down-link packets to the UE that might have been buffered for this PDU Session.
20	The vSMF sends an Nsmf_PDUSession_UpdateSMContext Response message to the AMF.
21	The vSMF sends an Nsmf_PDUSession_SMContextStatusNotify message to the AMF.
22	If it's a PDU session of type IPv6 or IPv4v6, the hSMF generates an IPv6 Router Advertisement and sends it to the UE through the N4 interface, hUPF, and vUPF.
23	If the vSMF received in step 18 is an indication that the RAN has rejected some QFIs the vSMF notifies the hSMF through an Nsmf_PDUSession_Update Request. The hSMF is responsible for updating the QoS rules and QoS Flow level QoS parameters for the QoS Flow(s) associated with the QoS rule(s) in the UE accordingly.
24	<p>If the PDU Session establishment failed after step 4, the hSMF performs the following steps:</p> <ul style="list-style-type: none"> • If the SMF is no more handling a PDU Session of the UE for this (DNN, S-NSSAI), the hSMF unsubscribes to the modifications of Session Management Subscription data for the corresponding (SUPI, DNN, S-NSSAI), by using Nudm_SDM_Unsubscribe. • The hSMF deregisters for the given PDU Session by using Nudm_UECM_Deregistration (SUPI, DNN, PDU Session ID).

PDU Session Modification Procedure

This call flow describes the PDU Session Modification procedure for the UPF.

Figure 25: PDU Session Modification Call Flow

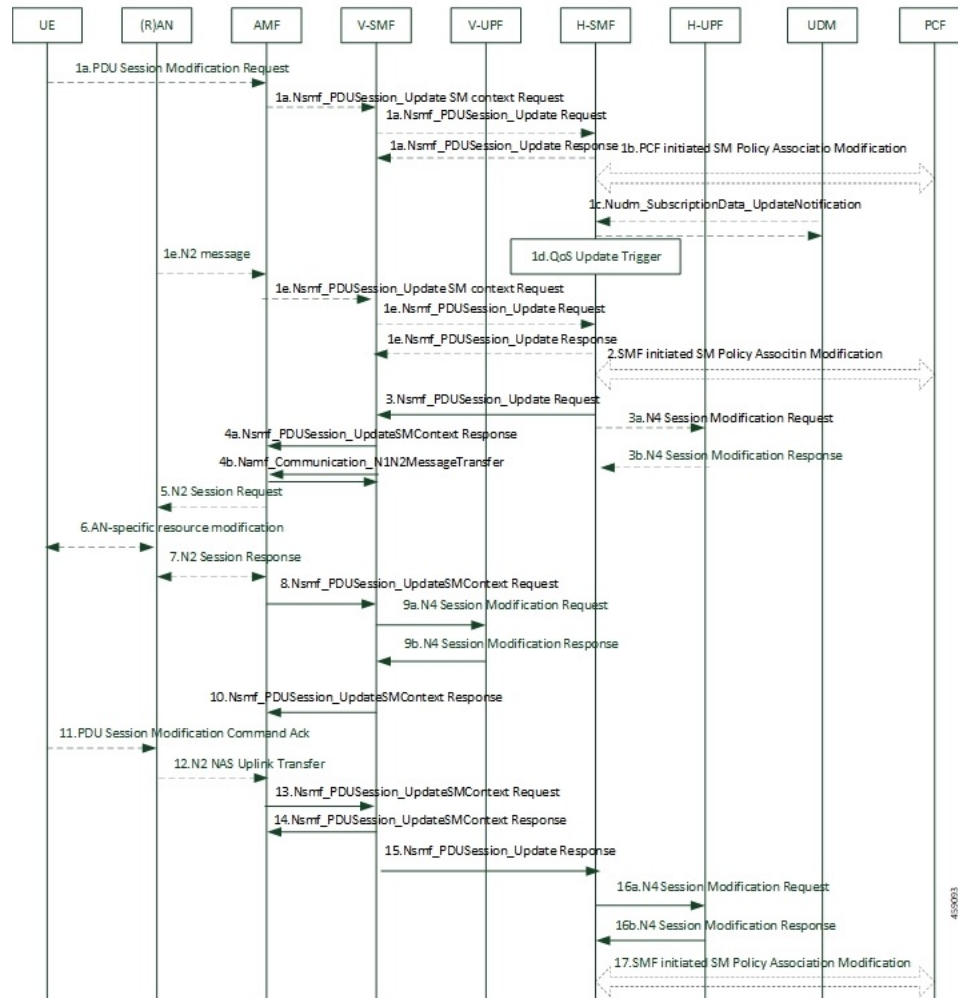

Table 89: PDU Session Modification Call Flow Description

Step	Description
1a	<ul style="list-style-type: none"> The UE initiates the PDU Session Modification procedure by the transmission of an NAS message to the AMF. The AMF initiates the Nsmf_PDUSession_UpdateSMContext message. The vSMF sends an Nsmf_PDUSession_Update Request message to the hSMF. The hSMF acknowledges and sends an Nsmf_PDUSession_Update Response message to the vSMF.
1b	The PCF performs a PCF initiated SM Policy Association Modification procedure to notify SMF about the modification of policies.

Step	Description
1c	The UDM updates the subscription data of hSMF by Nudm_SDM_Notification (SUPI, Session Management Subscription Data). The hSMF updates the Session Management Subscription Data and acknowledges the UDM by returning an Ack with (SUPI).
1d	The SMF might modify the PDU session. This procedure can also be triggered based on locally configured policy or triggered from the RAN.
1e	RAN indicates to the SMF when the AN resources onto which a QoS Flow is mapped are released irrespective of whether notification control is configured. RAN sends the N2 message to the AMF. The AMF invokes Nsmf_PDUSession_UpdateSMContext procedure. The vSMF sends an Nsmf_PDUSession_Update Request message to the hSMF. The hSMF acknowledges and sends an Nsmf_PDUSession_Update Response message to the vSMF.
2	The SMF reports some subscribed event to the PCF by performing an SMF initiated SM Policy Association Modification procedure.
3	The hSMF invokes the Nsmf_PDUSession_Update Request service operation to the vSMF.
3a	The hSMF initiates an N4 Session Modification procedure with the selected hUPF.
3b	The hUPF acknowledges and sends an N4 Session Modification Response message to the hSMF.
4a	The vSMF sends an Nsmf_PDUSession_UpdateSMContext Response message to the AMF.
4b	The vSMF sends an Nsmf_PDUSession_SMContextStatusNotify message to the AMF.
5	The AMF sends the NAS message containing PDU Session ID and PDU Session Establishment Accept targeted to the UE and the N2 SM information received from the SMF within the N2 PDU Session Request to the RAN.
6	The RAN issues AN specific signalling exchange with the UE that is related with the information received from SMF.
7	The AMF sends the Nsmf_PDUSession_UpdateSMContext Request message to the vSMF. The AMF forwards the N2 SM information received from RAN to the vSMF.
8	The AMF sends the Nsmf_PDUSession_UpdateSMContext Request message to the vSMF. The AMF forwards the N2 SM information received from RAN to the vSMF.
9a	The vSMF initiates an N4 Session Modification procedure with the vUPF. The vSMF provides packet detection, enforcement, and reporting rules to be installed on the vUPF for this PDU session, including AN Tunnel Information, H-CN Tunnel Information and V-CN Tunnel Information.
9b	The vUPF provides an N4 Session Modification Response to the vSMF. After this step, the vUPF delivers any down-link packets to the UE that might have been buffered for this PDU Session.
10	The vSMF sends an Nsmf_PDUSession_UpdateSMContext Response message to the AMF.
11	The UE sends a PDU Session Modification Command Ack message to the RAN.
12	The RAN initiates an N2 NAS Uplink Transfer with the AMF.

Step	Description
13	The vSMF sends an Nsmf_PDUSession_UpdateSMContext Response message to the AMF.
14	The vSMF sends an Nsmf_PDUSession_SMContextStatusNotify message to the AMF.
15	The vSMF responds to the hSMF with an Nsmf_PDUSession_Update response carrying the information like PCO provided by the UE in the SM PDU Session Modification Command Ack message from the UE to the vSMF. The hSMF modifies the PDU session context.
16a	The vSMF initiates an N4 Session Modification procedure with the vUPF. The vSMF provides packet detection, enforcement, and reporting rules to be installed on the vUPF for this PDU session, including AN Tunnel Information, H-CN Tunnel Information and V-CN Tunnel Information.
16b	The vUPF provides an N4 Session Modification Response to the vSMF. After this step, the vUPF delivers any down-link packets to the UE that might have been buffered for this PDU Session.
17	The hSMF initiates an SM Policy Association Modification procedure.

PDU Session Release Procedure

This call flow describes the PDU Session Release procedure for the UPF.

Figure 26: PDU Session Release Call Flow

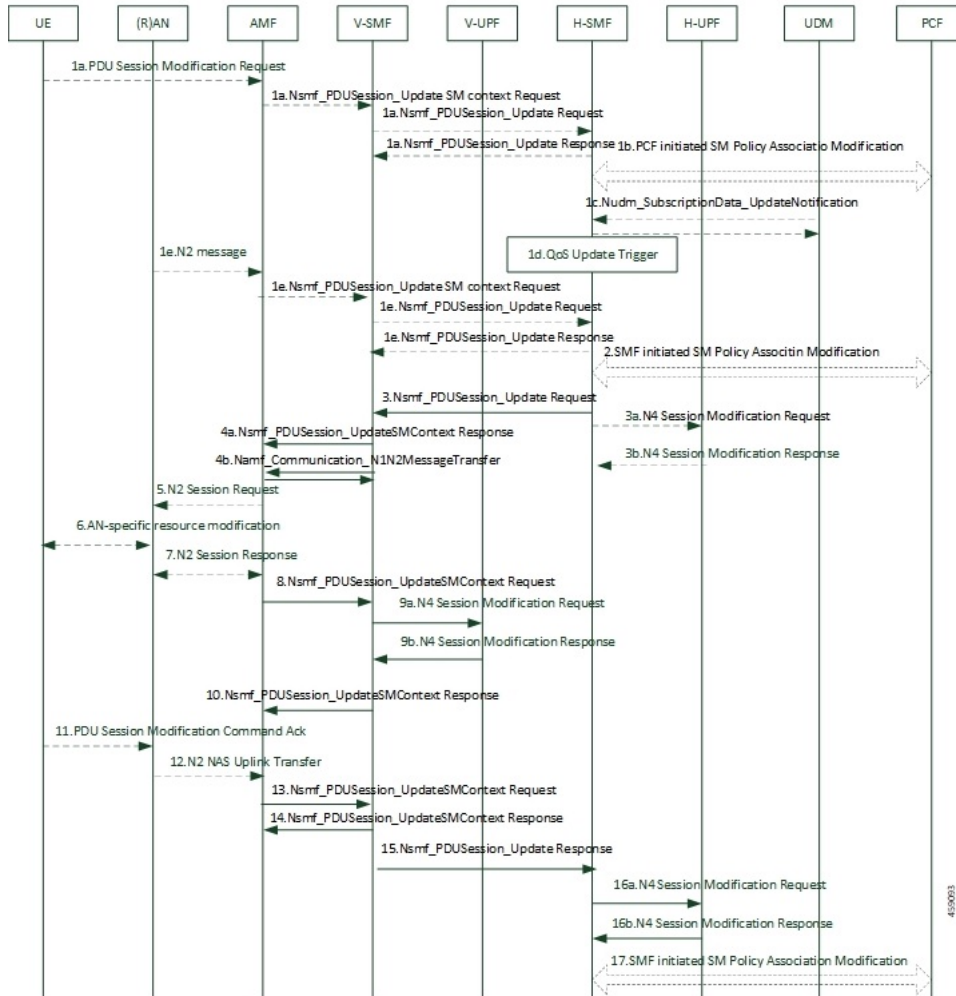

Table 90: PDU Session Release Call Flow Description

Step	Description
1a	<ul style="list-style-type: none"> The UE initiates the UE Requested PDU Session Release procedure by the transmission of an NAS message to the AMF. The AMF invokes the Nsmf_PDUSession_UpdateSMContext service operation and provides the N1 SM container to the SMF together with User Location Information (ULI) received from the RAN. The vSMF initiates N4 Session Modification to instruct the vUPF to stop forwarding uplink traffic. The vSMF invokes the Nsmf_PDUSession_Update Request service operation to request the hSMF to release the PDU Session. The hSMF responds to the request immediately.

Step	Description
1b	<ul style="list-style-type: none"> • The AMF invokes the Nsmf_PDUSession_ReleaseSMContext service operation to request the release of the PDU Session. • The vSMF initiates N4 Session Modification to instruct the vUPF to stop forwarding uplink traffic. • The vSMF initiates the release of the PDU Session at the hSMF by invoking the Nsmf_PDUSession_Release request.
1c	<ul style="list-style-type: none"> • The PCF invokes an SM Policy Association Termination procedure to request the release of the PDU Session. • The hSMF initiates N4 Session Modification to instruct the hUPF to stop forwarding downlink traffic.
1d	<ul style="list-style-type: none"> • RAN indicates to the vSMF that the PDU Session-related resource is released when all the QoS Flow(s) of the PDU Session are released. • The vSMF initiates N4 Session Modification to instruct the vUPF to stop forwarding uplink traffic. • The vSMF initiates the Nsmf_PDUSession_Update Request toward the hSMF and the hSMF acknowledges with a response.
1e	The SMF decides to release a PDU session. The hSMF initiates N4 Session Modification to instruct the hUPF to stop forwarding downlink traffic.
1f	<p>The AMF invokes the Nsmf_PDUSession_UpdateSMContext service operation with a release indication to request the release of the PDU session.</p> <p>The vSMF initiates N4 Session Modification to instruct the vUPF to stop forwarding uplink traffic. The vSMF invokes the Nsmf_PDUSession_Update Request toward the hSMF.</p>
2a	The hSMF sends an N4 Session Release Request (N4 Session ID) message to the hUPFs of the PDU session. The hUPFs drop any remaining packets of the PDU session and release all tunnel resource and contexts associated with the N4 Session.
2b	The hUPF(s) acknowledges the N4 Session Release Request by the transmission of an N4 Session Release Response message to the hSMF.
3a	The SMF responds to the AMF with the Nsmf_PDUSession_UpdateSMContext response.
4a	The vSMF sends an N4 Session Release request to the vUPF.
4b	The vUPF acknowledges and sends an N4 Session Release response to the hSMF.
5a	The vSMF sends an Nsmf_PDUSession_ReleaseSMContext Response message to the AMF.
5b	The vSMF sends an Nsmf_PDUSession_UpdateSMContext Response message to the AMF.
5c	The N1N2 Message Transfer procedure occurs between the AMF and vSMF.

Step	Description
6	The hSMF includes the N2 SM Resource Release request in the message sent to the AMF, then the AMF transmits the NAS message to the UE.
7	When the RAN receives an N2 SM request to release the AN resources associated with the PDU session, it issues AN specific signalling exchanges with the UE to release the corresponding AN resources.
8	If the RAN receives an N2 SM request to release the AN resources, it acknowledges the N2 SM Resource Release Request by sending an N2 SM Resource Release Ack message to the AMF.
9	The AMF sends an Nsmf_PDUSession_UpdateSMContext Response message to the vSMF.
10	The vSMF responds to the AMF with an Nsmf_PDUSession_UpdateSMContext response.
11	The UE acknowledges the PDU Session Release Command by sending a NAS message over the RAN.
12	The AMF invokes the Nsmf_PDUSession_UpdateSMContext to the vSMF.
13	The SMF responds to the AMF with an Nsmf_PDUSession_UpdateSMContext response.
14	The vSMF responds to the hSMF with an Nsmf_PDUSession_Update Request invoked at step 3a and confirms the PDU session release.
15	The vSMF initiates an N4 Session Modification procedure with the vUPF. The vSMF provides packet detection, enforcement, and reporting rules to be installed on the vUPF for this PDU session, including AN Tunnel Information, H-CN Tunnel Information and V-CN Tunnel Information.
15a	The hSMF releases the SM policy control association with the PCF by invoking the SM Policy Association Termination procedure.
15b - 15c	In case the PDU Session Release is HPLMN-initiated, the hSMF releases the corresponding User Plane resources.
15d	The hSMF invokes the Nudm_UECM_Deregistration service operation.
16a	The hSMF requests the vSMF to release all contexts associated with the PDU session by invoking the Nsmf_PDUSession_StatusNotify (Release) operation.
16b	The vSMF requests the AMF to release all contexts associated with the PDU Session by invoking the Nsmf_PDUSession_SMCContextStatusNotify (Release). The AMF releases the association between the vSMF ID and the PDU Session ID.

5G to 4G Handover

This call flow describes the 5G to 4G handover.

Figure 27: 5G to 4G Handover Call Flow

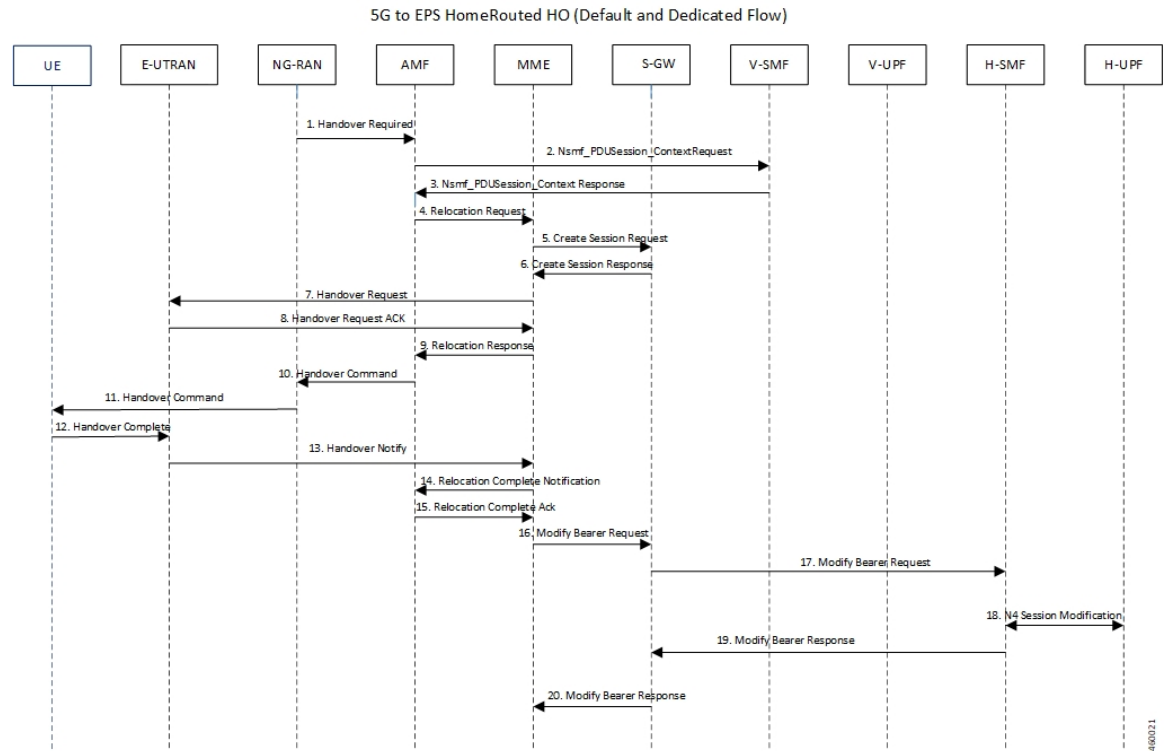

Table 91: 5G to 4G Handover Call Flow Description

Step	Description
1	After the 5G session is established, the NG-RAN initiates the handover process by sending the Handover Required message to the AMF.
2	The AMF invokes the Nsmf_PDUSession_Context Request and sends it to the vSMF.
3	The vSMF sends a Nsmf_PDUSession_Context Response to the AMF.
4	The AMF sends a Relocation Request to the MME.
5	The MME sends Create Session Request to the S-GW.
6	The S-GW sends a Create Session Response message back to the MME.
7	The MME sends a Handover Request message to E-UTRAN.
8	The E-UTRAN acknowledges and sends a Handover Request ACK message back to the MME.
9	The MME sends the Relocation Response message to the AMF.
10	The AMF sends a Handover Command message to the NG-RAN.

Step	Description
11	The NG-RAN commands the UE to handover to the target access network by sending the Handover Command.
12	The UE responds to the E-UTRAN with a Handover Complete message, and the uplink data path is established.
13	The E-UTRAN notifies the MME that the UE is handed over to the NG-RAN.
14	The MME sends a Relocation Complete Notification message to the AMF.
15	The AMF acknowledges and sends a Relocation Complete Ack message to the MME.
16	The MME sends a Modify Bearer Request message to the S-GW.
17	The S-GW forwards the Modify Bearer Request message to the hSMF.
18	The hSMF initiates an N4 Session Modification procedure with the hUPF.
19	The hSMF responds to the S-GW with a Modify Bearer Response message, and the downlink data path is established.
20	The S-GW sends the Modify Bearer Response message to the MME.

4G to 5G Handover

This call flow describes the 4G to 5G handover.

Figure 28: 4G to 5G Handover Call Flow

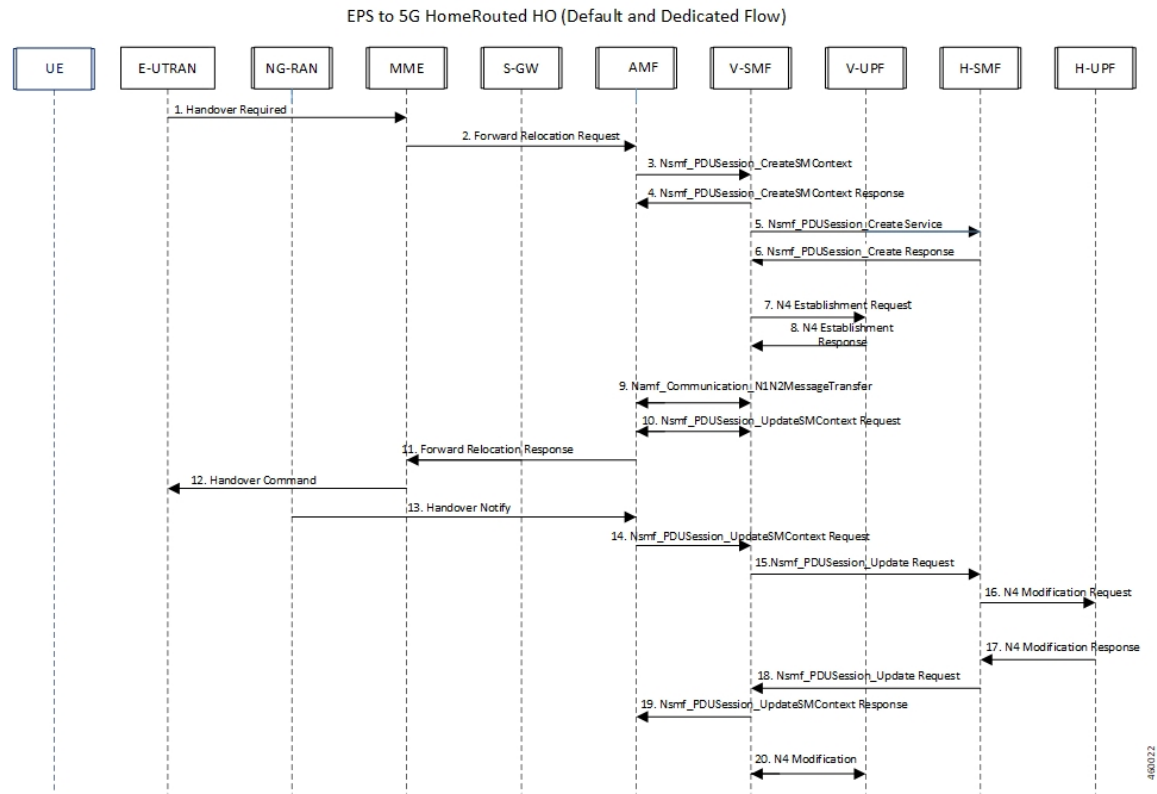

Table 92: 4G to 5G Handover Call Flow Description

Steps	Description
1	After the 4G session is established, the E-UTRAN initiates the handover process by sending the Handover Required message to the MME.
2	The MME sends a Forward Relocation Request to the AMF.
3	The AMF invokes the Nsmf_PDUSession_CreateSMContext Request and sends it to the vSMF.
4	The vSMF sends a Nsmf_PDUSession_CreateSMContext Response to the AMF.
5	The vSMF sends a Nsmf_PDUSession_Create Service message to create a new PDU Session in the hSMF.
6	The hSMF responds with a Nsmf_PDUSession_Create Response message.
7	The vSMF sends an N4 Establishment Request to the vUPF.
8	The vUPF acknowledges by sending an N4 Establishment Response.
9	The vSMF sends an Namf_Communication_N1N2MessageTransfer message to the AMF.
10	The AMF sends the Nsmf_PDUSession_UpdateSMContext Request message to the vSMF.

Steps	Description
11	The AMF sends a Forward Relocation Response message to the MME.
12	The MME sends the Handover Command to the E-UTRAN.
13	The NG-RAN notifies the AMF that the UE is handed over to the NG-RAN.
14	The AMF sends the Nsmf_PDUSession_UpdateSMContext Request message to the vSMF.
15	The vSMF initiates the Nsmf_PDUSession_Update Request toward the hSMF.
16	The hSMF sends an N4 Modification Request with PDRs, FARs, QERs, or URRs to the hUPF.
17	The hUPF responds with an N4 Modification Response message.
18	The hSMF invokes the Nsmf_PDUSession_Update Request service operation to the vSMF.
19	The vSMF sends an Nsmf_PDUSession_UpdateSMContext Response message to the AMF.
20	The vSMF initiates an N4 Modification procedure with the vUPF.



Note To support the roaming status functionality, the Roaming Status IE is sent in Subscriber Params during PDU Session Establishment or during handover.

Inter-PLMN 5G HO from Homer to Roamer

This call flow describes the inter-PLMN 5G handover (HO) procedure with v-SMF insertion.

The UE moves from a homer in H-PLMN to a roamer in V-PLMN. When V-SMF is newly inserted, SMF transitions to H-SMF.

Figure 29: Inter-PLMN 5G HO from Homer to Roamer Call Flow

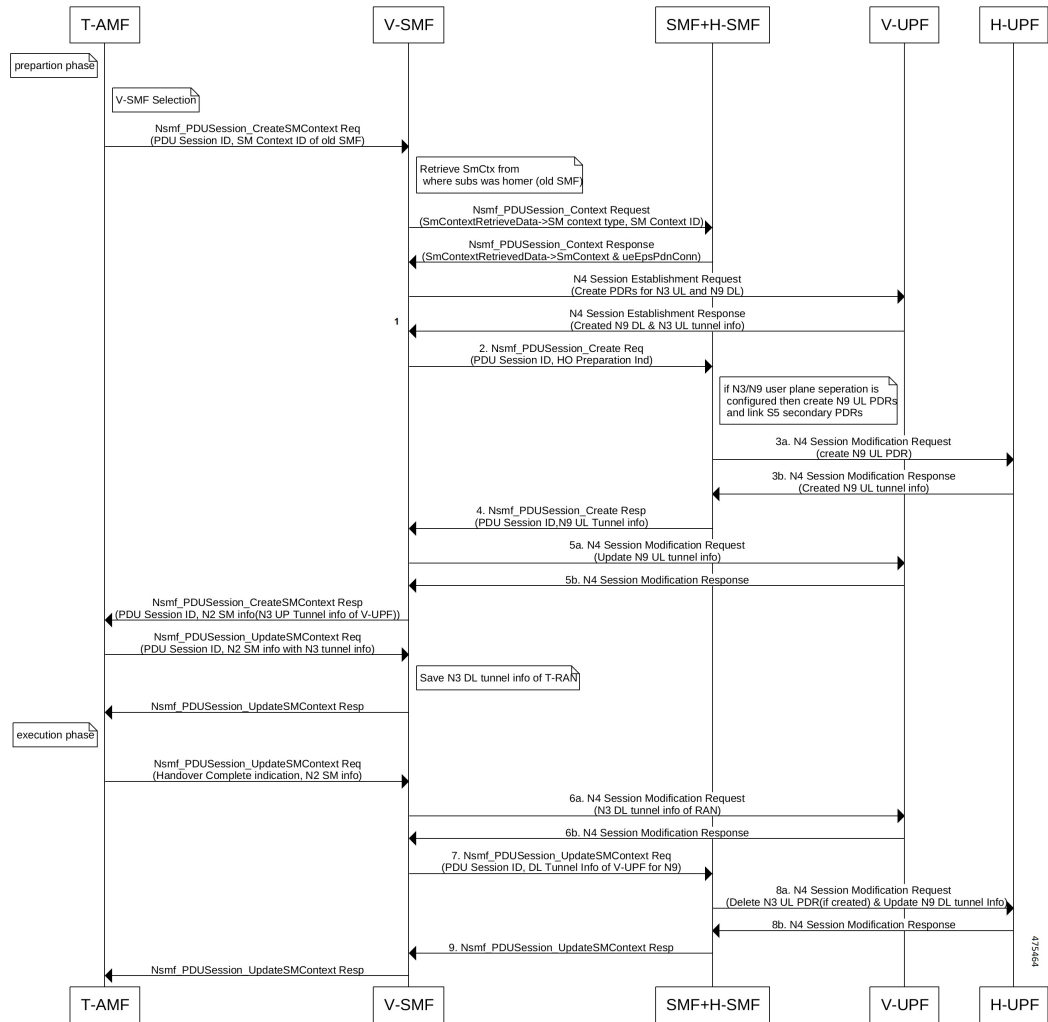

Table 93: Inter-PLMN 5G HO from Homer to Roamer Call Flow Description

Steps	Description
1	UE moves from H-PLMN (5G Homer) to V-PLMN (5G Roamer).
2	V-SMF sends Nsmf_PDUSession_Create Request with HO Preparation Ind info to the H-SMF.
3a	H-SMF sends the following Create PDRs in an N4 Session Modification Request to the H-UPF: <ul style="list-style-type: none"> • Primary Create PDR with Source Interface Type as N9, Local FTEID having the same FTEID as assigned in S5U Create PDR. • Secondary Create PDR with Source Interface Type as S5-U, Local FTEID having the same FTEID as assigned in S5U Create PDR.
3b	H-UPF sends N4 Session Modification Response with created N9 UL Tunnel info to the H-SMF.

Steps	Description
4	H-SMF sends Nsmf_PDUSession_Create Response with N9 UL Tunnel info to the V-SMF.
5a	V-SMF sends N4 Session Modification Request with N9 UL Tunnel info to the V-UPF.
5b	V-UPF sends N4 Session Modification Response back to the V-SMF.
6a	V-SMF sends N4 Session Modification Request with N3 DL Tunnel Info of RAN to the V-UPF.
6b	V-UPF sends N4 Session Modification Response back to the V-SMF.
7	V-SMF sends Nsmf_PDUSession_UpdateSMContext Request with DL Tunnel info of V-UPF for N9 to the H-SMF.
8a	H-SMF deletes N3 UL PDR (if created), updates N9 DL tunnel Info in an N4 Session Modification Request and sends to the H-UPF. H-SMF sends Create N9 DL FAR, Remove old N3 PDR, Remove old S5 PDR, Remove FAR, Create Core QER, and Update Core PDR in Sx-Modify.
8b	H-UPF sends N4 Session Modification Response back to the H-SMF.
9	H-SMF sends Nsmf_PDUSession_UpdateSMContext Response back to the V-SMF.

Inter-PLMN HO from 5G Roamer to 4G Homer

This call flow describes the inter-PLMN HO from 5G roamer to 4G homer.

Figure 30: Inter-PLMN HO from 5G Roamer to 4G Homer Call Flow

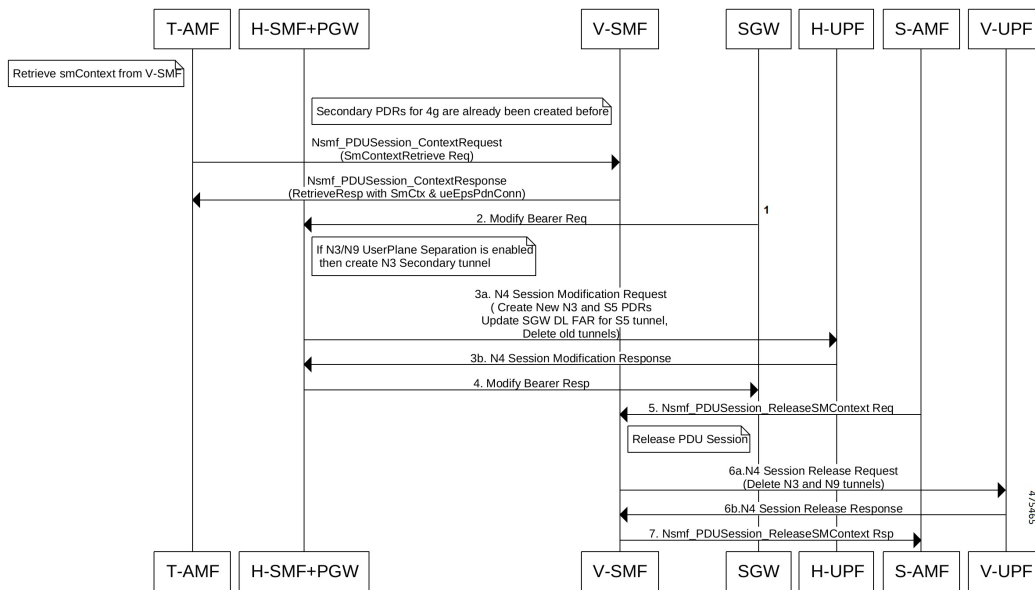

Table 94: Inter-PLMN HO from 5G Roamer to 4G Homer Call Flow Description

Steps	Description
1	UE moves from H-PLMN (5G Roamer) to V-PLMN (4G Homer).

Steps	Description
2	S-GW sends Modify Bearer Request to the H-SMF. Here, if N3/N9 UserPlane Separation is enabled then create N3 secondary tunnel.
3a	H-SMF sends N4 Session Modification Request to H-UPF with the following IEs: Create S5 PDR (old S5-U FTEID), Create N3 PDR (CH bit set for New FTEID), Create S5 DL FAR, Remove old N9 PDR, Remove old S5 PDR, Remove FAR, and Update Core QER.
3b	H-UPF sends N4 Session Modification Response back to the H-SMF.
4	H-SMF sends Modify Bearer Response back to the S-GW.
5	S-AMF sends Nsmf_PDUSession_ReleaseSMContext Request with Release PDU Session to the V-SMF.
6a	V-SMF sends N4 Session Release Request with Delete N3,N9 tunnels to the V-UPF.
6b	V-UPF sends N4 Session Release Response back to the V-SMF.
7	V-SMF sends Nsmf_PDUSession_ReleaseSMContext Response back to the S-AMF.

Standards Compliance

The HR roaming support feature complies with the following standards:

- 3GPP TS 23.502 "Procedures for the 5G System"
- 3GPP TS 29.061 "Interworking between the Public Land Mobile Network (PLMN) supporting packet based services and Packet Data Networks (PDN)"
- 3GPP TS 29.244 16.5.0 "Interface between the Control Plane and the User Plane nodes"

Limitations

The HR roaming support feature has the following limitations:

- Router Advertisement (RA) or Router Solicitation (RS) packets are charged and counted in default QFI PDR on the vUPF.
- No support for QER enforcement policing on the vUPF.
- No support for LI on the vUPF.
- UPF supports two GTPU endpoints at the ingress interface.
- Secondary PDR Optimization support will not be enabled in-between, for an existing call.
- After the upgrade, if the source interface type is not available in Create PDR. Then for existing calls, service selection will not happen based on interface type.
- N9, S5U, and S8U interface types are supported only on the same public IP and not on different IPs.
- Inter-PLMN handover works only with Secondary PDR optimization.

- If any Access-side PDR handling fails, then UPF reports only the failed PDR ID and not both PDRs (primary and secondary).

Configuring the HR Roaming Support for UPF

This section describes how to configure the HR roaming support feature for UPF.

Configure Buffering Support of Visitors Calls on vUPF

To configure the buffering support of visitors calls on the vUPF, use the following CLI commands:

```
config
  user-plane [converged mode | buffered-packet-count [ instance-limit
instance_limit_value { session-limit session_limit_value} | { session-limit
session_limit_value { instance-limit instance_limit_value} ] ]
  exit
```

NOTES:

- **buffering-packet-count**: Configure max session and instance limit for buffering the packets.
- **instance-limit** *instance_limit_value*: Configures maximum number of packets to buffer for all session per SessMgr instance. The default range is 1 to 10000.
- **session-limit** *session_limit_value*: Configures maximum number of packets to buffer per session. The default range is 1 to 255.

Verify the Buffering Support of Visitors Calls on vUPF

To verify the support of buffering limit for traffic on visitor calls on the vUPF, use the **show configuration** CLI command.

The following code is a sample output of the CLI command.

```
[local]qvpc-si# show configuration
...
...
#exit
user-plane buffered-packet-count session-limit 5 instance-limit 10
context ingress
...
...
```

Configure the GTP-U Service and N9 Interface Association

To configure the association of GTP-U Service and N9 Interface, use the following CLI commands:

```
config
  context ingress
    user-plane-service user-plane-service
      associate gtpu-service service_name [ cp-tunnel | pgw-ingress |
sgw-egress | sgw-ingress | upf-egress | upf-ingress | interface-type [
n9 | s5u | s8u | n3 | n9-s5u-s8u ] ]
      no associate gtpu-service upf-egress
    exit
```

```
exit
exit
```

NOTES:

- **upf-egress**: Configure the interface type as UPF egress used for N9 interface.
- **interface-type [n9 | s5u | s8u | n3 | n9-s5u-s8u]**: Configure the desired GTP-U ingress interface type. Use the **n9-s5u-s8u** interface type a when single public IP address is used for N9, S5u and S8u interface types.
- **no associate gtpu-service upf-egress**: Configure to remove the GTP-U service and N9 interface association.

Verify the GTP-U Service and N9 Interface Association

To verify the association of GTP-U Service and N9 Interface, use the **show user-plane-service all** CLI command.

The following code is a sample output of the CLI command.

```
[local]qvpc-si# show user-plane-service all

Service name                : user-plane-service
Service-Id                  : 6
Context                      : ingress
Status                       : STARTED
UPF Ingress GTPU Service    : sx-gtpu-service
UPF Egress GTPU Service     : sx-upf_egress_gtpu
SGW Ingress GTPU Service    : sx-sgw_ingress_gtpu
SGW Egress GTPU Service     : sx-sgw_egress_gtpu
...
[local]qvpc-si# show configuration context ingress
config
context ingress
....
...
user-plane-service user-plane-service
  associate gtpu-service sx-gtpu-service upf-ingress
  associate gtpu-service sx-upf_egress_gtpu upf-egress
  associate gtpu-service sx-sgw_ingress_gtpu sgw-ingress
  associate gtpu-service sx-sgw_egress_gtpu sgw-egress
  associate gtpu-service up-gtpu cp-tunnel
  associate sx-service sxu
  associate control-plane-group gl
exit
...
```

Roaming Status in Sub-Params IE

The following is an example of the Sub-Params IE that displays the roaming status:

```
SUBSCRIBER PARAMS:
Type: 226
Rat-Type: 3
SGSN-Address: 20.20.20.17
ULI: ECGI=216354001234c800
GGSN-Address: 20.20.20.3
Roaming-Status: Homer/Roamer/Visitor-hr/Visitor-LBO
```

Source Interface Type IE

The Source Interface Type IE indicates the 3GPP interface type of the source interface.

The 3GPP Interface Type IE indicates the 3GPP interface type of the source interface within the PDR IE, or the 3GPP interface type of the Destination Interface within the FAR IE.

The following is an example of Create PDR that displays Source Interface Type:

```
CREATE PDR:
  Type: 1
  Value:
PDR ID:
  Type: 56
  Value:
    RULE ID: 0x0002
PRECEDENCE:
  Type: 29
  Value: 0x00000001

PDI:
Type: 2
Value:
SOURCE INTERFACE:
  Type: 20
  Value: CORE (1)
Traffic Endpoint ID:
  Type: 131
  Value: 0x0001
SOURCE INTERFACE TYPE:
  Type: 160
  Value: N9 (0x0F)
FAR ID:
  Type: 108
  Value: 0x8002
RULEBASE:
  Type: 207
  Value:
QER ID:
  Type: 109
  Value: 0x80000001
```

Monitoring and Troubleshooting

This section provides troubleshooting information for this feature.

show user-plane-service statistics all

To monitor the statistics for the user plane service, use the following CLI command:

```
show user-plane-service statistics all
```

The following is a sample output:

```
[local]qvmc-si# show user-plane-service statistics all

...
PDNs By PLMN-Type:
Homer Subscriber PDNs:
  Active:                                0      Setup:                                0
```

```

Released: 0
Roamer Subscriber PDNs:
Active: 0 Setup: 0
Released: 0
Visited-Home-Routed Subscriber PDNs:
Active: 0 Setup: 0
Released: 0
Visited-Local-Breakout Subscriber PDNs:
Active: 0 Setup: 0
Released: 0
...
Inter-PLMN Handover Statistics:
Attempted : 0 Succeeded : 0
Failed. : 0

Intra-PLMN Handover Statistics:
Attempted : 0 Succeeded : 0
Failed. : 0
...
PDNs Rejected By Reason:
...
...
Data Statistics Related To Paging:
Packets Buffered: 5 Bytes Buffered: 420
Packets Discarded: 1 Bytes Discarded: 84

Total Data Statistics:

```

show subscribers user-plane-only full all

To see all the subscribers using the user plane service, use the following CLI command:

```
show subscribers user-plane-only full all
```

The following is a sample output:

```

...
Converged Session: No Converged Peer Callid: n/a
Visited Call: Yes
Subscriber Parameters:
...
Interface Type: N4
...
Subscriber Parameters:
IMSI: 123456789012345
...
Old Rat Type: 6
...
Session-ID: 1414146500000001
Roaming Status: Homer
Old Roaming Status: Homer
...

```

show subscribers user-plane-only callid pdr full all

The **show subscribers user-plane-only callid *call_id* pdr full all** command displays all PDR information.

The Source Interface Type field displays the Source Interface Type IE received from SMF.

The following is a sample output of this command:

```
show subscribers user-plane-only callid call_id pdr full all
```

show user-plane-service gtpu statistics gtpu-service n9-egress

```

show subscribers user-plane-only callid 0098e4b0 pdr full all
Callid: 0098e4b0
Interface Type: N4
...
Matched Bytes:          0
Matched Packets:       0
Precedence:            0
Source Interface:      Access
Source Interface Type: N9
Local F-TEID:          0x16001
Local F-TEID IP Addr:
  IPv4:                 20.20.20.15
  IPv6:                 N/A
...
Bearer Level Info-id:  N/A
Secondary Pdr Info:
  Pdr ID :              2 / NA
  Local F-TEID:         0x1a001
  Local F-TEID IP Addr:
    IPv4:                20.20.20.15
    IPv6:                N/A
  QoS Flow Identifier:  1 / NA
  Source Interface Type: S5U

```

show user-plane-service gtpu statistics gtpu-service n9-egress

The following is a sample output of this command for visiting UPF:

```

[local]Test-UPF4# show user-plane-service gtpu statistics gtpu-service n9-egress

Total Data Stats:
Uplink Packets: 10 Uplink Bytes: 2400
Downlink Packets: 10 Downlink Bytes: 2400
Packets Discarded: 0 Bytes Discarded: 0

QoS Stats:

QCI 1:
Uplink Packets: 0 Uplink Bytes: 0
Downlink Packets: 0 Downlink Bytes: 0
Packets Discarded: 0 Bytes Discarded: 0

QCI 2:
Uplink Packets: 8 Uplink Bytes: 1920
Downlink Packets: 8 Downlink Bytes: 1920
Packets Discarded: 0 Bytes Discarded: 0

QCI 3:
Uplink Packets: 0 Uplink Bytes: 0
Downlink Packets: 0 Downlink Bytes: 0
Packets Discarded: 0 Bytes Discarded: 0

QCI 4:
Uplink Packets: 0 Uplink Bytes: 0
Downlink Packets: 0 Downlink Bytes: 0
Packets Discarded: 0 Bytes Discarded: 0

QCI 5:
Uplink Packets: 0 Uplink Bytes: 0
Downlink Packets: 0 Downlink Bytes: 0
Packets Discarded: 0 Bytes Discarded: 0

QCI 6:

```



```
Uplink Packets: 0 Uplink Bytes: 0
Downlink Packets: 0 Downlink Bytes: 0
Packets Discarded: 0 Bytes Discarded: 0

QCI 7:
Uplink Packets: 0 Uplink Bytes: 0
Downlink Packets: 0 Downlink Bytes: 0
Packets Discarded: 0 Bytes Discarded: 0

QCI 8:
Uplink Packets: 0 Uplink Bytes: 0
Downlink Packets: 0 Downlink Bytes: 0
Packets Discarded: 0 Bytes Discarded: 0

QCI 9:
Uplink Packets: 2 Uplink Bytes: 480
Downlink Packets: 2 Downlink Bytes: 480
Packets Discarded: 0 Bytes Discarded: 0

QCI 65:
Uplink Packets: 0 Uplink Bytes: 0
Downlink Packets: 0 Downlink Bytes: 0
Packets Discarded: 0 Bytes Discarded: 0

QCI 66:
Uplink Packets: 0 Uplink Bytes: 0
Downlink Packets: 0 Downlink Bytes: 0
Packets Discarded: 0 Bytes Discarded: 0

QCI 69:
Uplink Packets: 0 Uplink Bytes: 0
Downlink Packets: 0 Downlink Bytes: 0
Packets Discarded: 0 Bytes Discarded: 0

QCI 70:
Uplink Packets: 0 Uplink Bytes: 0
Downlink Packets: 0 Downlink Bytes: 0
Packets Discarded: 0 Bytes Discarded: 0

QCI 80:
Uplink Packets: 0 Uplink Bytes: 0
Downlink Packets: 0 Downlink Bytes: 0
Packets Discarded: 0 Bytes Discarded: 0

QCI 82:
Uplink Packets: 0 Uplink Bytes: 0
Downlink Packets: 0 Downlink Bytes: 0
Packets Discarded: 0 Bytes Discarded: 0

QCI 83:
Uplink Packets: 0 Uplink Bytes: 0
Downlink Packets: 0 Downlink Bytes: 0
Packets Discarded: 0 Bytes Discarded: 0

Non-Std QCI(Non-GBR):
Uplink Packets: 0 Uplink Bytes: 0
Downlink Packets: 0 Downlink Bytes: 0
Packets Discarded: 0 Bytes Discarded: 0
Uplink Packets: 0 Uplink Bytes: 0
Downlink Packets: 0 Downlink Bytes: 0
Packets Discarded: 0 Bytes Discarded: 0

Total uplink packets GBR QCI's: 8
Total uplink Bytes GBR QCI's: 1920
```

show user-plane-service gtpu statistics gtpu-service n9-ingress

```

Total Downlink packets GBR QCI's: 8
Total Downlink Bytes GBR QCI's: 1920
Total uplink packets Non-GBR QCI's: 2
Total uplink Bytes Non-GBR QCI's: 480
Total Downlink packets Non-GBR QCI's: 2
Total Downlink Bytes Non-GBR QCI's: 480

Path Management Messages:
Echo Request Rx: 29 Echo Response Rx: 10
Echo Request Tx: 10 Echo Response Tx: 29
SuppExtnHdr Tx: 0 SuppExtnHdr Rx: 0

Peer Stats:
Total GTPU Peers: 1
Total GTPU Peers with Stats: 1

Tunnel Management Messages:
Error Indication Tx: 0
Error Indication Rx: 0
Error Indication Rx Discarded: 0

```

show user-plane-service gtpu statistics gtpu-service n9-ingress

The following is a sample output of this command for roaming UPF:

```

[local]Test-UPF3# show user-plane-service gtpu statistics gtpu-service n9-ingress

Total Data Stats:
Uplink Packets: 25 Uplink Bytes: 6000
Downlink Packets: 24 Downlink Bytes: 5760
Packets Discarded: 0 Bytes Discarded: 0

QoS Stats:

QCI 1:
Uplink Packets: 0 Uplink Bytes: 0
Downlink Packets: 0 Downlink Bytes: 0
Packets Discarded: 0 Bytes Discarded: 0

QCI 2:
Uplink Packets: 19 Uplink Bytes: 4560
Downlink Packets: 18 Downlink Bytes: 4320
Packets Discarded: 0 Bytes Discarded: 0

QCI 3:
Uplink Packets: 0 Uplink Bytes: 0
Downlink Packets: 0 Downlink Bytes: 0
Packets Discarded: 0 Bytes Discarded: 0

QCI 4:
Uplink Packets: 0 Uplink Bytes: 0
Downlink Packets: 0 Downlink Bytes: 0
Packets Discarded: 0 Bytes Discarded: 0

QCI 5:
Uplink Packets: 0 Uplink Bytes: 0
Downlink Packets: 0 Downlink Bytes: 0
Packets Discarded: 0 Bytes Discarded: 0

QCI 6:
Uplink Packets: 0 Uplink Bytes: 0
Downlink Packets: 0 Downlink Bytes: 0
Packets Discarded: 0 Bytes Discarded: 0

```

```
QCI 7:
Uplink Packets: 0 Uplink Bytes: 0
Downlink Packets: 0 Downlink Bytes: 0
Packets Discarded: 0 Bytes Discarded: 0

QCI 8:
Uplink Packets: 0 Uplink Bytes: 0
Downlink Packets: 0 Downlink Bytes: 0
Packets Discarded: 0 Bytes Discarded: 0

QCI 9:
Uplink Packets: 6 Uplink Bytes: 1440
Downlink Packets: 6 Downlink Bytes: 1440
Packets Discarded: 0 Bytes Discarded: 0

QCI 65:
Uplink Packets: 0 Uplink Bytes: 0
Downlink Packets: 0 Downlink Bytes: 0
Packets Discarded: 0 Bytes Discarded: 0

QCI 66:
Uplink Packets: 0 Uplink Bytes: 0
Downlink Packets: 0 Downlink Bytes: 0
Packets Discarded: 0 Bytes Discarded: 0

QCI 69:
Uplink Packets: 0 Uplink Bytes: 0
Downlink Packets: 0 Downlink Bytes: 0
Packets Discarded: 0 Bytes Discarded: 0

QCI 70:
Uplink Packets: 0 Uplink Bytes: 0
Downlink Packets: 0 Downlink Bytes: 0
Packets Discarded: 0 Bytes Discarded: 0

QCI 80:
Uplink Packets: 0 Uplink Bytes: 0
Downlink Packets: 0 Downlink Bytes: 0
Packets Discarded: 0 Bytes Discarded: 0

QCI 82:
Uplink Packets: 0 Uplink Bytes: 0
Downlink Packets: 0 Downlink Bytes: 0
Packets Discarded: 0 Bytes Discarded: 0

QCI 83:
Uplink Packets: 0 Uplink Bytes: 0
Downlink Packets: 0 Downlink Bytes: 0
Packets Discarded: 0 Bytes Discarded: 0

Non-Std QCI(Non-GBR):
Uplink Packets: 0 Uplink Bytes: 0
Downlink Packets: 0 Downlink Bytes: 0
Packets Discarded: 0 Bytes Discarded: 0
Uplink Packets: 0 Uplink Bytes: 0
Downlink Packets: 0 Downlink Bytes: 0
Packets Discarded: 0 Bytes Discarded: 0

Total uplink packets GBR QCI's: 19
Total uplink Bytes GBR QCI's: 4560
Total Downlink packets GBR QCI's: 18
Total Downlink Bytes GBR QCI's: 4320
Total uplink packets Non-GBR QCI's: 6
```

```
show user-plane-service gtpu statistics gtpu-service n9-ingress
```

```
Total uplink Bytes Non-GBR QCI's: 1440  
Total Downlink packets Non-GBR QCI's: 6  
Total Downlink Bytes Non-GBR QCI's: 1440
```

```
Path Management Messages:  
Echo Request Rx: 10 Echo Response Rx: 31  
Echo Request Tx: 31 Echo Response Tx: 10  
SuppExtnHdr Tx: 0 SuppExtnHdr Rx: 0
```

```
Peer Stats:  
Total GTPU Peers: 1  
Total GTPU Peers with Stats: 1
```

```
Tunnel Management Messages:  
Error Indication Tx: 0  
Error Indication Rx: 0  
Error Indication Rx Discarded: 0
```



CHAPTER 41

Security Group Tag Support

- [Feature Summary and Revision History, on page 407](#)
- [Feature Description, on page 408](#)
- [How it Works, on page 408](#)
- [Monitoring and Troubleshooting, on page 409](#)

Feature Summary and Revision History

Summary Data

Table 95: Summary Data

Applicable Product (s) or Functional Area	5G-UPF
Applicable Platforms	VPC-SI
Feature Default Setting	Enabled – Always-on
Related Changes in this Release	Not Applicable
Related Documentation	<i>UCC 5G UPF Configuration and Administration Guide</i>

Revision History

Revision Details	Release
First introduced.	2023.03.0 2023.02.0

Feature Description

The Security Group Tag (SGT) specifies the privileges of a traffic source within a trusted network. Security Group Access (a feature of both Cisco TrustSec and Cisco ISE) automatically generates the SGT when a user adds a security group in TrustSec or ISE.



Note Security Group Tag (SGT) is also referred to as Scalable Group Tag.

The Identity Services Engine (ISE) sends SGT values over the RADIUS interface, that are propagated over the N6 interface. The SGT value needs to be checkpointed for both session recovery and ICSR/GR scenarios for availability to the peer session manager.

How it Works

Call Flow

The following figure illustrates ISE handling.

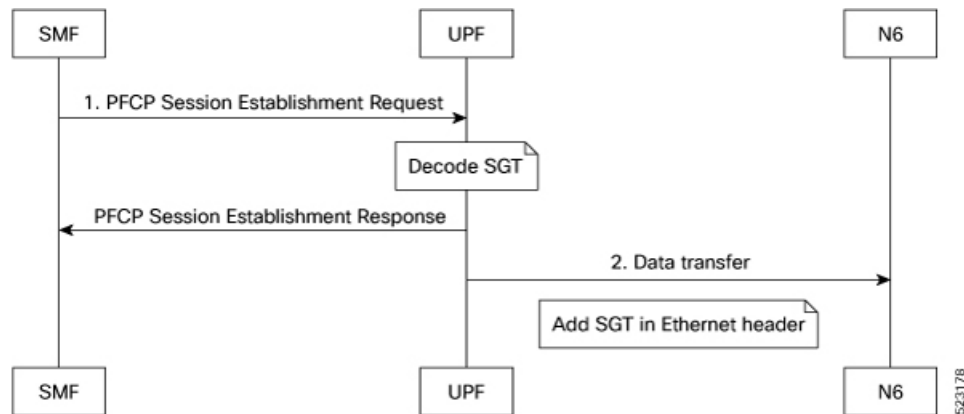

Step	Description
1	SMF sends the SGT value in PFCP Session Establishment Request to UPF.
2	UPF decodes the SGT value and adds this value as part of the Cisco Meta Data (CMD) in Ethernet header for all packets sent over the N6 interface.

Limitations

This feature has the following known limitation:

- The PFCP Session Establishment Request must send the SGT value over the N4 interface. The SGT value will not be modified or removed during the life of the session.

- UPF does not support SGT traffic in the downlink direction.

Monitoring and Troubleshooting

Show Commands and Outputs

This section provides information about show commands and their outputs in support of this feature.

show subscriber user-plane-only full all

The output of this command is enhanced to include the following field:

- **SGT Value:** Displays the SGT value.

Fastpath Stream

The SGT value received in Establishment Request is carried with OHR (Outer Header Removal) option for the Uplink stream. This operation enables VPP to add SGT in the corresponding Uplink packets towards N6. The per stream SGT is provisioned in fastpath as part of the remove-outer-header operation.

The following is a sample output of the **fastpath stream** command:

```
vpp# fastpath stream list allinfo

p ~odc qta teid immediate=0xd, 2817:r104354:d14069, 2831:r51892:d51892) Policer,
(Next: V6:254, V4254), (2829:r753755:d753755, 2828:r753755:d753755) Policer,
(Next: V6: 24, V4 25), (2829:r753758:d753758, 2828:r753758:d753758) hcfUL,
(Next: V6: 22, V4 23), (2827:r9964:d9964, 2830:r189893:d189893,
2831:r51892:d51892) remOuterHdr, (Next: V6: 7, V4 7),
(2817:r104354:d14069, immediate=0x2d000120) L1:Sx35b93
holding queue: Empty x3-index: 0 dep-id: 0 dup-x3-index: 0 dup-dep-id: 0
```



CHAPTER 42

Session Recovery

- [Feature Summary and Revision History, on page 411](#)
- [Feature Description, on page 411](#)
- [How it Works, on page 412](#)
- [Configuring the System to Support Session Recovery, on page 412](#)

Feature Summary and Revision History

Summary Data

Applicable Product(s) or Functional Area	5G-UPF
Applicable Platform(s)	VPC-SI SMI
Feature Default Setting	Disabled – License Required
Related Changes in this Release	Not Applicable
Related Documentation	Not Applicable

Revision History

Revision Details	Release
First introduced.	2020.02.0

Feature Description

With robust hardware failover and redundancy protection, any hardware or software failures on the system can quickly be corrected. However, software failures can occur for numerous reasons, often without prior indication.

This chapter describes the Session Recovery feature that provides seamless failover and reconstruction of subscriber session information in the event of a hardware or software fault.



Important Session Recovery is a licensed Cisco feature. A separate feature license may be required. Contact your Cisco Account representative for detailed information on specific licensing requirements.

How it Works

This section provides an overview of how this feature is implemented and the recovery process.

The Session Recovery feature provides seamless failover and reconstruction of subscriber session information in the event of a hardware or software fault within the system preventing a fully connected user session from being disconnected.

Session recovery is performed by mirroring key software processes (for example, session manager and AAA manager) within the system. These mirrored processes remain in an idle state (standby-mode) wherein they perform no processing, until they may be needed in the event of a software failure (for example, a session manager task aborts).

There are some situations wherein session recovery may not operate properly. More software or hardware failures occur during the session recovery operation. For example, an AAA manager fails while the state information it contained was being used to populate the newly activated session manager task.



Important After a session recovery operation, some statistics, such as those collected and maintained on a per manager basis (AAA Manager, Session Manager, and so on) are in general not recovered, only accounting and billing related information is checkpointed and recovered.

Configuring the System to Support Session Recovery

The following procedures allow you to configure the session recovery feature for either an operational system that is currently in-service (able to accept incoming calls) or a system that is out-of-service (not part of your production network and, therefore, not processing any live subscriber/customer data).



Important The session recovery feature, even when the feature use key is present, is disabled by default on the system.

Enabling Session Recovery

As noted earlier, session recovery can be enabled on a system that is out-of-service (OOS) and does not yet have any contexts configured, or on an in-service system that is currently capable of processing calls. However, if the system is in-service, it must be restarted before the session recovery feature takes effect.

Enabling Session Recovery on an Out-of-Service System

The following procedure is for a system that does not have any contexts configured.

To enable the session recovery feature on an Out-of-Service system, perform the following procedure. This procedure assumes that you begin at the EXEC mode prompt.

Step 1 At the EXEC mode prompt, verify that the session recovery feature is enabled through the session and feature use licenses on the system by running the **show license info** command.

If the current status of the Session Recovery feature is Disabled, you cannot enable this feature until a license key is installed in the system.

Step 2 Use the following configuration example to enable session recovery.

```
configure
  require session recovery
end
```

Note After you configure this command, you must save the configuration and then reload the chassis for the command to take effect. For information on saving the configuration file and reloading the chassis, refer to the System Administration Guide for your deployment.

Step 3 Save your configuration as described in *Verifying and Saving Your Configuration*.

The system, when started, enables session recovery, creates all mirrored "standby-mode" tasks, and performs packet processing card reservations and other operations automatically.

Step 4 After the system has been configured and placed in-service, you must verify the preparedness of the system to support this feature as described in *Viewing Session Recovery Status* section.

Enabling Session Recovery on an In-Service System

When enabling session recovery on a system that already has a saved configuration, the session recovery commands are automatically placed before any service configuration commands in the configuration file.

To enable the session recovery feature on an in-service system, perform the following procedure. This procedure assumes that you begin at the EXEC mode prompt.

Step 1 At the EXEC mode prompt, verify that the session recovery feature is enabled through the session and feature use licenses on the system by running the **show license info** command:

If the current status of the Session Recovery feature is Disabled, You cannot enable this feature until a license key is installed in the system.

Step 2 Use the following configuration example to enable session recovery.

```
configure
  require session recovery
end
```

This feature does not take effect until after the system has been restarted.

Step 3 Save your configuration as described in *Verifying and Saving Your Configuration*.

Step 4 Perform a system restart by entering the **reload** command:

The following prompt appears:

Are you sure? [Yes|No]:

Confirm your desire to perform a system restart by entering **yes**.

The system, when restarted, enables session recovery and creates all mirrored "standby-mode" tasks, performs packet processing card reservations, and other operations automatically.

Step 5 After the system has been restarted, you must verify the preparedness of the system to support this feature as described in *Viewing Session Recovery Status* section.

More advanced users may opt to simply insert the **require session recovery** command syntax into an existing configuration file using a text editor or other means, and then applying the configuration file manually. Exercise caution when doing this to ensure that this command is placed among the first few lines of any existing configuration file; it must appear before the creation of any nonlocal context.

Disabling the Session Recovery Feature

To disable the session recovery feature on a system, enter the **no require session recovery** command from the Global Configuration mode prompt.



Important If this command is issued on an in-service system, then the system must be restarted by issuing the **reload** command.

Viewing Session Recovery Status

To determine if the system is capable of performing session recovery, when enabled, enter the **show session recovery status verbose** command from the Exec mode prompt.

The output of this command should be similar to the examples shown below.

```
[local]host_name# show session recovery status
Session Recovery Status:
  Overall Status           : SESSMGR Not Ready For Recovery
  Last Status Update      : 1 second ago
```

```
[local]host_name# show session recovery status
Session Recovery Status:
  Overall Status           : Ready For Recovery
  Last Status Update      : 8 seconds ago
```

```
[local]host_name# show session recovery status verbose
Session Recovery Status:
  Overall Status           : Ready For Recovery
  Last Status Update      : 2 seconds ago
```

```

-----sessmgr-----      -----aaamgr-----      demux
cpu state   active   standby   active   standby   active   status
-----
1/0 Active   7         1         7         1         7         Good
[local]host_name#
```

Viewing Recreated Session Information

To view session state information and any session recreation status, enter the following command:

```
show subscriber debug-info callid id
```

The following example shows the output of this command both before and after a session recovery operation has been performed. The "Redundancy Status" fields in this example have been bold-faced for clarity.

```
username: user1                callid: 01callb1                msid: 0000100003
Card/Cpu: 4/2
Sessmgr Instance: 7
Primary callline:
Redundancy Status: Original Session
  Checkpoints      Attempts      Success      Last-Attempt      Last-Success
  Full:            69           68           29800ms           29800ms
  Micro:           206          206          20100ms           20100ms
Current state: SMGR_STATE_CONNECTED
FSM Event trace:
  State              Event
  SMGR_STATE_OPEN    SMGR_EVT_NEWCALL
  SMGR_STATE_NEWCALL_ARRIVED SMGR_EVT_ANSWER_CALL
  SMGR_STATE_NEWCALL_ANSWERED SMGR_EVT_LINE_CONNECTED
  SMGR_STATE_LINE_CONNECTED SMGR_EVT_LINK_CONTROL_UP
  SMGR_STATE_LINE_CONNECTED SMGR_EVT_AUTH_REQ
  SMGR_STATE_LINE_CONNECTED SMGR_EVT_IPADDR_ALLOC_SUCCESS
  SMGR_STATE_LINE_CONNECTED SMGR_EVT_AUTH_SUCCESS
  SMGR_STATE_LINE_CONNECTED SMGR_EVT_UPDATE_SESS_CONFIG
  SMGR_STATE_LINE_CONNECTED SMGR_EVT_LOWER_LAYER_UP
Data Reorder statistics
Total timer expiry: 0          Total flush (tmr expiry): 0
Total no buffers: 0          Total flush (no buffers): 0
Total flush (queue full): 0  Total flush (out of range): 0
Total flush (svc change): 0  Total out-of-seq pkt drop: 0
Total out-of-seq arrived: 0
IPv4 Reassembly Statistics:
  Success: 0          In Progress: 0
  Failure (timeout): 0      Failure (no buffers): 0
  Failure (other reasons): 0
Redirected Session Entries:      Allowed:
2000      Current: 0
          Added: 0          Deleted:
          0
          Revoked for use by different subscriber: 0
Peer callline:
Redundancy Status: Recreated Session
  Checkpoints      Attempts      Success      Last-Attempt      Last-Success
  Full:            0            0            0ms               0ms
  Micro:           0            0            0ms               0ms
Current state: SMGR_STATE_CONNECTED
FSM Event trace:
  State              Event
  SMGR_STATE_LINE_CONNECTED SMGR_EVT_LOWER_LAYER_UP
  SMGR_STATE_CONNECTED    SMGR_EVT_AUTH_REQ
  SMGR_STATE_CONNECTED    SMGR_EVT_AUTH_SUCCESS
  SMGR_STATE_CONNECTED    SMGR_EVT_REQ_SUB_SESSION
  SMGR_STATE_CONNECTED    SMGR_EVT_RSP_SUB_SESSION
  SMGR_STATE_CONNECTED    SMGR_EVT_ADD_SUB_SESSION
  SMGR_STATE_CONNECTED    SMGR_EVT_AUTH_REQ
  SMGR_STATE_CONNECTED    SMGR_EVT_AUTH_SUCCESS
  SMGR_STATE_CONNECTED    SMGR_EVT_AUTH_REQ
  SMGR_STATE_CONNECTED    SMGR_EVT_AUTH_SUCCESS
  SMGR_STATE_CONNECTED    SMGR_EVT_AUTH_REQ
```

```

SMGR_STATE_CONNECTED          SMGR_EVT_AUTH_SUCCESS
SMGR_STATE_CONNECTED          SMGR_EVT_AUTH_REQ
SMGR_STATE_CONNECTED          SMGR_EVT_AUTH_SUCCESS
SMGR_STATE_CONNECTED          SMGR_EVT_AUTH_REQ
SMGR_STATE_CONNECTED          SMGR_EVT_AUTH_SUCCESS
Data Reorder statistics
  Total timer expiry:          0          Total flush (tmr expiry): 0
  Total no buffers:            0          Total flush (no buffers): 0
  Total flush (queue full):    0          Total flush (out of range):0
  Total flush (svc change):    0          Total out-of-seq pkt drop: 0
  Total out-of-seq arrived:    0
IPv4 Reassembly Statistics:
  Success:                     0          In Progress:                0
  Failure (timeout):           0          Failure (no buffers):       0
  Failure (other reasons):     0
Redirected Session Entries:
  Allowed:                     2000        Current:                     0
  Added:                       0          Deleted:                     0
  Revoked for use by different subscriber: 0

```



CHAPTER 43

Session Report Rejection Procedure

- [Feature Summary and Revision History, on page 417](#)
- [Feature Description, on page 417](#)
- [OAM Support, on page 419](#)

Feature Summary and Revision History

Summary Data

Applicable Product(s) or Functional Area	5G-UPF
Applicable Platform(s)	VPC-SI SMI
Feature Default Setting	Enabled – Always-on
Related Changes in this Release	Not Applicable
Related Documentation	<i>UCC 5G SMF Configuration and Administration Guide</i>

Revision History

Revision Details	Release
First introduced.	2021.02.0

Feature Description

The SMF rejects the UPF-originated Session Report Request with a specific cause code during any mismatch in the charging configuration of SMF and UPF.

For any session report rejection by the SMF, the UPF locally purges the sessions. The SMF is unaware of the purging operation and continues to send the N4 message to the UPF. This action triggers the UPF to send “context not found” message to the SMF for the locally purged sessions.

This behavior impacts the UE experience and results in the loss of charging data. So, the current implementation of handling the session report errors is modified to avoid local purging of sessions on the UPF and also to support graceful clearing of sessions.

With this modification, the UPF ignores the Session Report Error Response. The SMF triggers the Session Deletion Request followed by the rejection of Session Report. The UPF responds to the delete request and clears the session gracefully.

Relationships to Other Features

This feature involves implementing some behavioral changes to the SMF and the UPF. The new CLI configuration in SMF aids in controlling this behavior. For details on the SMF behavioral changes, see the *Support for Session Report Rejection Procedure* chapter in the *UCC 5G SMF Configuration and Administration Guide*.

Call Flow

The following figure explains the flow of Session Report rejection procedure.

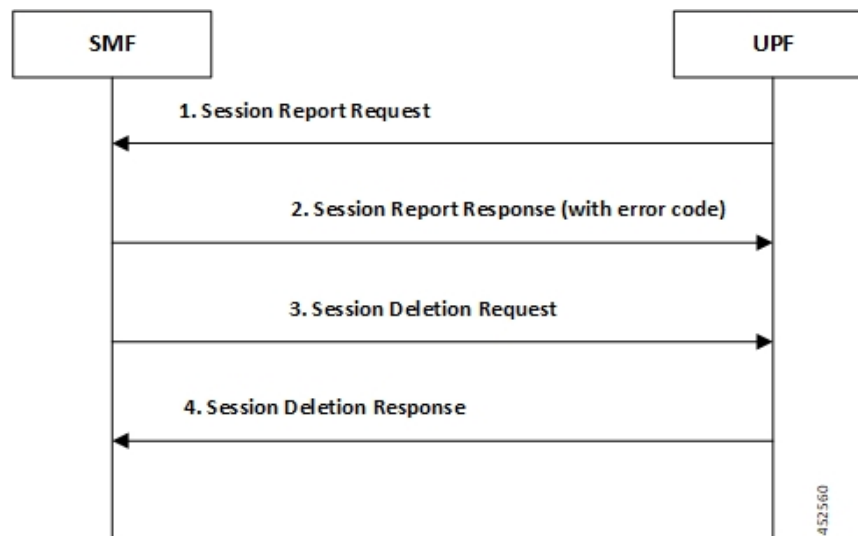

Table 96: Session Report Rejection Procedure Call Flow

Step	Description
1	UPF sends Session Report message to SMF. (SX_SESSION_REPORT_REQUEST)
2	SMF rejects the message with some error code. (SX_SESSION_REPORT_RESPONSE with error code)
3	UPF ignores the Session Report error response. SMF initiates Session Delete Request to tear down the session gracefully. (SX_SESSION_DELETION_REQUEST)

Step	Description
4	UPF responds to the delete request and clears the session gracefully. (SX_SESSION_DELETION_RESPONSE)

OAM Support

This section describes operations, administration, and maintenance information for this feature.

Show Command(s) and/or Output(s)

show user-plane-service statistics all

The counter, "Skipped Local Purge", is added to the **show user-plane-service statistics all** CLI command under the section "PDNs Released By Reason".

- **Skipped Local Purge:** Increments whenever Session Report error is triggered from SMF/CP to UPF/UP.

■ Show Command(s) and/or Output(s)



CHAPTER 44

Smart Licensing

- [Feature Summary and Revision History, on page 421](#)
- [Overview, on page 422](#)
- [Configuring Smart Licensing, on page 426](#)
- [Monitoring and Troubleshooting Smart Licensing, on page 428](#)

Feature Summary and Revision History

Summary Data

Table 97: Summary Data

Applicable Product (s) or Functional Area	5G-UPF
Applicable Platforms	VPC-SI SMI
Feature Default Setting	Disabled – Configuration Required
Related Changes in this Release	Not Applicable
Related Documentation	<i>UCC 5G UPF Configuration and Administration Guide</i>

Revision History

Revision Details	Release
First introduced.	2021.01.0

Overview

Ultra Cloud Core 5G User Plane Function (UPF) supports Smart Licensing. Smart Licensing is a cloud-based approach to licensing that simplifies the purchase, deployment, and management of Cisco software assets. Entitlements are purchased through your Cisco account via Cisco Commerce Workspace (CCW) and immediately deposited into your Virtual Account for usage. This eliminates the need to install license files on every device. Products that are smart-enabled, communicate directly to Cisco to report consumption. A single location is available to customers to manage Cisco software licenses - the Cisco Smart Software Manager (CSSM). License ownership and consumption are readily available to help make better purchase decision based on consumption or business need.

See <https://www.cisco.com/c/en/us/buy/smart-accounts/software-licensing.html> for more information about Cisco Smart Licensing.

Comparison Between Legacy Licensing and Smart Licensing

Cisco employs two types of license models - Legacy Licensing and Smart Software Licensing. **Legacy Licensing** consists of software activation by installing Product Activation Keys (PAK) on to the Cisco product. A Product Activation Key is a purchasable item, ordered in the same manner as other Cisco equipment and used to obtain license files for feature set on Cisco Products. **Smart Software Licensing** is a cloud-based licensing of the end-to-end platform leveraging few tools that authorize and deliver license reporting. Smart Software Licensing functionality incorporated into Network Functions (NFs) completes the product registration, authorization resulting in reporting services available to the end customer.

Evaluation Period

A 90-day evaluation period is granted for all licenses in use. During this period, feature licenses can be used without limitation, and up to one counting license each can be used. The evaluation period ends when the system registers successfully with the CSSM or Cisco.com. Licensed functionality is blocked when this 90-day period expires.

UPF performs license enforcement for on/off feature licenses. Each on/off feature license is tied to service licenses, which potentially use those on/off features. When an Out of Compliance (OOC) is detected for an on/off license, new calls for the corresponding services are dropped, subject to the following conditions:

- Each on/off feature license is given a 90-day grace (evaluation) period. During this period, the system generates SNMP traps to inform of the unavailability of valid licenses. To resolve the OOC, corrective action is needed such as purchasing and registering licenses for this feature, or disabling the feature.
- If the feature is still OOC after the 90-day grace period, UPF enforces the OOC state based on a predefined policy for each license. If enforcement is required, new calls for the services corresponding to the on/off licenses are dropped.

The following CLI commands can be used to display details about the enforcement of Smart Licenses in use:

```
show license enforcement policy
show license enforcement status [ allowed | blocked ] [ feature | service
]
```

Cisco Smart Software Manager

Cisco Smart Software Manager (CSSM) enables the management of software licenses and Smart Account from a single portal. The interface allows you to activate your product, manage entitlements, and renew and upgrade software. A functioning Smart Account is required to complete the registration process. To access the Cisco Smart Software Manager, see <https://software.cisco.com>.

Smart Accounts/Virtual Accounts

A Smart Account provides a single location for all Smart-enabled products and entitlements. It helps speed procurement, deployment, and maintenance of Cisco Software. When creating a Smart Account, you must have the authority to represent the requesting organization. After submitting, the request goes through a brief approval process.

A Virtual Account exists as a sub-account within the Smart Account. Virtual Accounts are a customer-defined structure based on organizational layout, business function, geography or any defined hierarchy. They are created and maintained by the Smart Account administrator.

See <https://software.cisco.com> to learn about, set up, or manage Smart Accounts.

Smart Licensing Mode

The Smart Licensing Mode is categorized as follows:

- **Reporting Licenses (Parent Licenses):** The Parent Licenses are reported to backend license server (CSSM) and accounted for usage of licenses. For each Parent Licenses, the entitlement tags are created and the same is used to identify the type service or feature.
- **Non-Reporting Licenses (Child Licenses):** The Child Licenses are not reported to backend license server (CSSM) and these licenses are enabled by default with the Parent Licenses. For Child Licenses, the entitlement tags are not created.

That is to say, Smart License enables all Parent and Child Licenses based on the Product Type that is configured. However, the reporting is done only for Parent Licenses.

The state of Smart Licensing Agent is persistent across reboot and crashes.

Request a Cisco Smart Account

A Cisco Smart Account is an account where all products enabled for Smart Licensing are deposited. A Cisco Smart Account allows you to manage and activate your licenses to devices, monitor license use, and track Cisco license purchases. Through transparent access, you have a real-time view into your Smart Licensing products. IT administrators can manage licenses and account users within your organization's Smart Account through the Smart Software Manager.

Step 1 In a browser window, enter the following URL:

`https://software.cisco.com`

Step 2 Log in using your credentials, and then click **Request a Smart Account** in the **Administration** area. The **Smart Account Request** window is displayed.

Step 3 Under **Create Account**, select one of the following options:

- **Yes, I have authority to represent my company and want to create the Smart Account** – If you select this option, you agree to authorization to create and manage product and service entitlements, users, and roles on behalf of your organization.
- **No, the person specified below will create the account** – If you select this option, you must enter the email address of the person who will create the Smart Account.

Step 4 Under **Account Information**:

- Click **Edit** beside **Account Domain Identifier**.
- In the **Edit Account Identifier** dialog box, enter the domain, and click **OK**. By default, the domain is based on the email address of the person creating the account and must belong to the company that will own this account.
- Enter the **Account Name** (typically, the company name).

Step 5 Click **Continue**.

The Smart Account request will be in pending status until it has been approved by the Account Domain Identifier. After approval, you will receive an email confirmation with instructions for completing the setup process.

Software Tags and Entitlement Tags

Tags for the following software and entitlements have been created to identify, report, and enforce licenses.

Software Tags

Software tags uniquely identify each licenseable software product or product suite on a device. The following software tags exist for UPF.

Product Type / Description	Software Tag
UPF Ultra Cloud Core - User Plane Function (UPF)	regid.2020-04.com.cisco.UPF, 1.0_bc18a9ff-e0ea-4476-a250-04ebf7839c4c

Reporting (Parent) Entitlement Tags for UPF

The following entitlement tags identify licenses in use for UPF.

License Display Name/Description	Entitlement Tag	Tag Name
UCC 5G UPF Base Lic Ultra Cloud Core - User Plane Function (UPF), Base Minimum	regid.2020-08.com.cisco.F_UPF_BASE, 1.0_776395f3-8b8d-46e1-ac6e-0bd2306ef3b6	F_UPF_BASE
UCC 5G UPF Instance Ultra Cloud Core - User Plane Function (UPF) Instance	regid.2020-08.com.cisco.F_UPF_INS, 1.0_5cd68c07-152a-48c6-b143-4dc60eb111e5	F_UPF_INS

License Display Name/Description	Entitlement Tag	Tag Name
UCC 5G UPF 1K Sess Ultra Cloud Core - User Plane Function (UPF), 1K Sessions	regid.2020-08.com.cisco.L_UPF_SAE_1K, 1.0_5d16e2f6-808a-45ff-8691-f215d5ba2bea	L_UPF_SAE_1K

Non-reporting (Child) License List

In this release, the following Child Licenses are enabled by default when the Parent Licenses are enabled.

License Description	License Type
PGW 1k Sessions	Counting
SGW 1k Sessions	Counting
GGSN 1k Sessions	Counting
Per Subscriber Stateful Firewall 1k Sessions	Counting
ENAT 1k Sessions	Counting
Enhanced Charging Bundle 1	Counting
Enhanced charging bundle 2	On/Off
Dynamic policy interface	On/Off
Enhanced LI service	On/Off
Lawful intercept	On/Off
Session recover	On/Off
Radius AAA server group	On/Off
IPv6	On/Off
Intelligent Traffic Control	On/Off
DIAMETER Closed-Loop Charging Interface	On/Off
Per-Subscriber Traffic Policing/Shaping	On/Off
Dynamic Radius extensions (CoA and PoD)	On/Off
Proxy MIP	On/Off
FA	On/Off
IPSec	On/Off
Inter-Chassis Session Recovery	On/Off
ICSR/SR Performance Improvements	On/Off
ICSR Enhanced Recovery for Data and Control Plane, 1K Sessions	On/Off
MPLS	On/Off

License Description	License Type
TACACS+	On/Off
NAT/PAT With DPI	On/Off
Rate Limiting Function (Throttling)	On/Off
Overcharging Protection for EPC-GW	On/Off
Overcharging Protection Upgrade for EPC-GW	On/Off
ADC Trigger Over Gx, 1K Sessions	On/Off
Gx Based Virtual APN Selection, 1K Sessions	On/Off
EPC-GW Support for Wi-Fi Integration, 1K Sessions	On/Off
EPC-GW Non-Standard QCI Support, 1K Sessions	On/Off
Local Policy Decision Engine	On/Off
Header Enrichment	On/Off
HTTP Header Encryption	On/Off
HTTP Header Enrichment and Encryption	On/Off
Broadcast & Multicast Services	On/Off
Integrated Content Filtering Provisioned Service	On/Off
Application Detection and Control 1k Sessions	Counting
5G NSA Feature Set 100K Sess VPCSW Active 1k Sessions	Counting
5G NSA Enablement Fee, Network Wide	On/Off
Multimedia Priority Service Feature Set, 1K Sessions	On/Off
EPC Gw VoLTE enhancements	On/Off
DNS Snooping	On/Off

Configuring Smart Licensing

Before you begin, ensure you have:

- Created a Smart Licensing account on <https://software.cisco.com>.
- Registered your products on <https://software.cisco.com> using the Product Instance Registration tokens created as part of a Smart Account or Virtual Account.
- Enabled a communication path between the UPF system to the CSSM server or Cisco.com.

Enable Smart Licensing

By default, Smart Licensing is disabled in UPF. To enable Smart Licensing, enter the following Global Configuration mode commands:

```
configure
  license smart product upf
  license smart enable
end
```

NOTE: Before enabling Smart Licensing, Product Type must be configured to enable default licenses that are based on product type.

Enter the following command to verify the configuration:

```
show configuration | grep license
```

Register the Device with Cisco

Using the Product Instance Registration token ID provided when you registered the products on <https://software.cisco.com>, register the system using the following EXEC mode command:

```
license smart register idtoken token
```

The system now automatically reports an entitlement usage count to the CSSM server and receives a compliance status. This also removes the system from "Evaluation Mode".

To show the compliance status, enter any of the following EXEC mode commands:

```
show license status
show license summary
show license statistics
```

The registration for the system is renewed automatically every 180 days. If needed, use the following EXEC mode command to renew the registration information manually:

```
license smart renew id
```

The license authorization for the system is renewed automatically every 30 days. If needed, use the following EXEC mode command to renew the license authorization manually:

```
license smart renew auth
```

To unregister a device, enter the following EXEC mode command:

```
license smart deregister
```

Changing Smart Transport URL

Smart Agent uses Smart Transport to communicate to Cisco CSSM server. Smart Transport uses the configured URL to identify the destination URL where CSSM is reachable. This will not initiate any communication with Cisco. If needed, enter the following configuration mode commands:

```
configure
  license smart transport smart
  license smart url https_link
```

Handling Out of Compliance

If there are not enough licenses in the virtual account for a given SKU, CSSM sends an Out Of Compliance (OOC) message to the device. The system stops allowing extra sessions until the OOC state is cleared. The OOC state is cleared when the device receives an authorized response.

Monitoring and Troubleshooting Smart Licensing

Enter the following EXEC mode command to verify the Smart Licensing configuration:

```
show configuration | grep license
```

The following EXEC mode commands display information about Smart Licensing:

```
show license { all | enforcement | smart-tags | statistics | status |  
summary | tech-support | udi | usage }
```

NOTES:

- **all** - Shows a superset of information that includes show status, show usage, show UDI, as well as the Smart Licensing agent version.
- **enforcement { policy | status [allowed | blocked] [feature | service] }** - Shows the enforcement policy applied or current enforcement status of Smart Licenses. Status information can be filtered to show only the licenses which are currently allowed or blocked, or by type (feature license or service license).
- **smart-tags [feature | service]** - Shows the features and services that are currently supported and the corresponding Smart Entitlement Tag.
- **statistics [verbose]** - Shows individual feature license status.
- **status** - Shows overall Smart Licensing status information.
- **summary** - Shows summary of Smart Licensing status.
- **tech-support** - Shows information useful for debugging issues with Smart Licensing.
- **udi** - Shows details for all Unique Device Identifiers (UDI).
- **usage** - Shows the usage information for all entitlements that are currently in use.



CHAPTER 45

Software Management Operations

- [Feature Summary and Revision History, on page 429](#)
- [Overview, on page 430](#)
- [SNMP Traps, on page 431](#)
- [Limitations, on page 431](#)
- [Health Checks, on page 431](#)
- [Build Upgrade, on page 433](#)
- [UPF Upgrade, on page 435](#)
- [UPF Downgrade, on page 435](#)

Feature Summary and Revision History

Summary Data

Table 98: Summary Data

Applicable Product(s) or Functional Area	5G-UPF
Applicable Platform(s)	VPC-SI SMI
Feature Default Setting	Enabled – Always-on
Related Changes in This Release:	Not Applicable
Related Documentation	Not Applicable

Revision History

Table 99: Revision History

Revision Details	Release
First introduced.	2022.01.2

Overview

5G UPF supports backward compatibility of software releases on the SMF and the UPF. The feature allows seamless upgrade/downgrade of the software from/to one previous release (N-1). The functionality includes support for the following:

- N-1 compatibility of software releases on two UPFs in ICSR mode—allows seamless upgrade of UPFs from one version to another in UPF 1:1 redundancy scenario.
- N-1 compatibility of software releases between SMF and UPF—allows seamless upgrade of the associated SMF or UPF from one version to another.
- N-1 compatibility of software releases between SMF and UPF with multi-Sx—allows seamless upgrade of the associated SMF or UPF from one version to another in multi-Sx scenario.



Important Contact your Cisco Account representative for procedural assistance prior to upgrading or downgrading your software versions.

Version Exchange between SMF and UPF

Version/release information is exchanged when SMF and UPF pairs. The release information exchange also occurs when the UPF pairs with a Standby UPF (in 1:1 redundancy scenario) through the heart beat message exchanged between Active and Standby.

When incompatible releases are paired, an Alarm (SNMP trap) is raised. For details, see [SNMP Traps](#) section.

To indicate the peer version during the exchange of release information, the following new IE is included in the association request and heartbeat request messages.

Information Elements	P	Condition / Comment						IE Length		IE ID
Peer Version	O	Used to specify the peer GR/PFCP version and StarOS version						4 bytes		245
		Bits								
	Octets	8	7	6	5	4	3	2	1	
	1 to 2	Peer Version IE Type = 245 (decimal)								
	3 to 4	Length = n bytes								
	5 to 8	Peer GR/PFCP Version								
	9 to 12	StarOS GR Version								
	13 to 13	StarOS Version String Length								
	Variable Length	StarOS Version String Value								

SNMP Traps

The following SNMP traps are raised when pairing is done with an incompatible release.

SNMP Trap	Description
SRPPeerUnsupportedVersion	The Active/Standby UPF in higher version raises the SNMP trap when the peer is in a version lower than N-1.
SRPPeerUnsupportedVersionClear	The Active/Standby UPF in higher version raises the SNMP trap to clear the SRPPeerUnsupportedVersion.
SxPeerUnsupportedVersion	The UPF in higher version raises the SNMP trap when the peer is in a version lower than N-1.
SxPeerUnsupportedVersionClear	The UPF in higher version raises an SNMP trap to clear the SxPeerUnsupportedVersion.

Limitations

The following are the known limitations of the feature:

- When the peer version is determined to be lower than the supported N-1 version, the association/pairing is allowed. However, functional aspect of the same isn't guaranteed.



Caution Don't attempt to upgrade from incompatible versions. Contact your Cisco Account representative for the upgrade path and steps.

- Few CLI commands may not be supported in N+1 version.
- The SMF version must be compatible with the UPF version.
- The hardware configuration must be similar in both Active and Standby UPFs.
- SNMP traps are raised by the node on the latest version with respect to the StarOS version. For details, see the [SNMP Traps](#) section of this chapter.
- From release 2022.01.2, RCM is checkpoint agnostic to enable support for future UPF releases. Currently RCM supports only N-1 compatibility.

Health Checks

Perform the following health checks after every operation of upgrade, downgrade, or reload of chassis.

1. Check the Service Redundancy Protocol (SRP) information on the Active chassis to avoid issues during an SRP switchover and decide if proactive analysis must be done before the SRP switchover. Use the following CLI commands:

- **srp validate-configuration**

- **srp validate-switchover**
- **show srp info**

The following is a sample output.

```
Peer Configuration Validation: Complete
Last Peer Configuration Error: None
Last Peer Configuration Event: Wed Mar 18 15:34:02 2022 (1602 seconds ago)
Last Validate Switchover Status: None
Connection State: Connected
```

Check the following parameters:

- **Peer Configuration Validation: Complete**—If it shows "In Progress," you must wait and then execute the **show srp info** CLI command again after 15 seconds (approximately).
- **Last Peer Configuration Error: None**—If you see "Peer Checksum Validation Failure," then it indicates that there are configuration differences between Active and Standby chassis that must be fixed.



Note If you see any error in **Last Peer Configuration Error**, validate the configuration using the **show configuration srp** CLI command on both the Active and Standby UPFs.

- **Last Validate Switchover Status: None**—The output must show as "None." Also, the output must be *Remote Chassis - Ready for Switchover (XX seconds ago)* when the **srp validate-configuration** and **srp validate-switchover** CLI commands are triggered.
- **Connection State: Connected**—The output must show as "Connected."

2. Check subscriber count on both Active and Standby chassis.

After sessions are up, execute the **show subscribers summary | grep Total** CLI command in the Active chassis. The following is a sample output.

```
show subscribers summary | grep Total
Total Subscribers: 100
```

On the Standby chassis, execute the **show srp checkpoint statistics | grep allocated** CLI command. The following is a sample output.

```
show srp checkpoint statistics | grep allocated
Current pre-allocated calls: 100
```

3. Check the status of the license by executing the **show license information** CLI command. It must be in "Good (Redundant)" and not in "Expired" state.
4. Check the Session Recovery Status by executing the **show session recovery status verbose** CLI command. The following is a sample output.

```
Session Recovery Status:
Overall Status      : Ready For Recovery
Last Status Update  : 7 seconds ago

      ----sessmgr---  ----aaamgr----  demux
cpu state  active standby  active standby  active  status
1/0 Active    8      1      8      1      17    Good
```

5. Verify if all the SessMgrs are in Standby-Connected state on the Standby chassis by executing the **show srp checkpoint statistics | grep Sessmgrs** CLI command. The following is a sample output.

```
Number of Sessmgrs:          1
Sessmgrs in Active-Connected state:  0
Sessmgrs in Standby-Connected state:  8
Sessmgrs in Pending-Active state:    0
```

6. Verify the status of all the cards to see if they are in Active or Standby state. The following is a sample output.

```
show card table
```

Slot	Card Type	Oper State	SPOF	Attach
1: VC	5-Port Virtual Card	Active	-	

7. Execute the **show task resources | grep -v good** CLI command, and its output must only display the total number of SessMgrs and sessions.
8. Execute the **show crash list** CLI command to check if there are any new crashes.
9. Execute the **show service all** CLI command to verify that the state is displayed as "Started" and not "Initialized."

Build Upgrade

Backup Configuration

1. Back up the current configuration—Save the current configuration that is used in case of downgrade/upgrade, which probably has all the features and configuration present until now.
2. Collect the **show support details** on both Active and Standby chassis before making any changes or upgrade.
3. Perform Health Checks.

Upgrade Procedure

1. Perform chassis Health Checks on both the nodes.
2. On the secondary chassis (ICSR), which is in Standby state, change boot priority with N+1 build.
3. Reload to the latest build version.
4. Do the new configuration change on Standby chassis (For example, any new CLI, license, or configuration changes).
5. Perform Health Check on the reloaded chassis. Check for any crashes or errors.

Perform Switchover

1. Before SRP switchover from Active to Standby on both chassis, check:
 - a. On Active chassis: **show subscriber summary | grep Total**

- b. On Standby chassis: **show srp checkpoint statistics | grep allocated**



Note The count must be same for both chassis.

- c. On Active and Standby chassis: **show sx peer**

For example:

```

||||| Sx Service                               No of
||||| ID                                       Restart
||||| |                                       Recovery |
Current      Max      Peer
vvvvv v      Group Name  Node ID      Peer ID      Timestamp      v
Sessions    Sessions  State
-----
CAAXD 22    CPGROUP21  209.165.200.225  50331649    2021-03-17:02:33:55    0
      0      0      NONE

Total Peers:    1

```



Note Peer state must be Active and associated. Peer ID must match on both the chassis.

- d. On Standby chassis: **show srp checkpoint statistics | grep Sessmgrs**



Note "Number of Sessmgrs" must be equal to the "Sessmgrs in Standby-Connected state".

- e. On Active chassis:

1. **srp validate-configuration**: This CLI command initiates a configuration validation check in the Active chassis. If the validation doesn't have any error, the output of this CLI command is blank.
2. **srp validate-switchover**: Validates if both Active and Standby chassis are ready for a planned SRP switchover. If the chassis is ready for switchover, then the output of this CLI command is blank.
3. **show srp info | grep "Last Validate Switchover Status"** : Output of this CLI command must be as follows.

```
Last Validate Switchover Status: Remote Chassis - Ready for Switchover
```

4. **show srp info debug**: Active and Standby chassis must have the same output.

2. On Active chassis: **srp initiate-switchover**

- a. Perform chassis Health Checks on both the nodes. Also check Step 1a and Step 1c under the *Perform Switchover* section. There can be a difference of 5%.
- b. Perform call testing since new sessions are serviced on the new Active chassis.
- c. Upgrade the old Active as mentioned in Step 2 through Step 5 under the *Upgrade Procedure* section.

UPF Upgrade

This section describes the procedure for UPF upgrade.

1. Perform Health Check procedure on both the UPF nodes as mentioned in the [Health Checks, on page 431](#) section.
2. Perform Upgrade on Standby UPF as mentioned in the [Build Upgrade, on page 433](#) section.
3. Do "sx-peer configuration" on the upgraded Standby chassis.
4. Perform Health Check on both the UPF nodes, and then do UPF switchover.
5. Upgrade the new Standby UPF as mentioned in the [Build Upgrade, on page 433](#) section.

UPF Downgrade

Perform the following steps to downgrade the UPF:

1. Perform Health Check on the UPF.
2. Change boot priority to the N-1 build on the Standby UPF. Reload the Standby UPF.
3. Do "sx-peer configuration" on the downgraded Standby UPF.
4. Perform Health Check on both the UPF nodes and then do UPF switchover.
5. Perform Step 1 to Step 3 on the new Standby UPF.



CHAPTER 46

Standard QCI Support

- [Feature Summary and Revision History, on page 437](#)
- [Feature Description, on page 437](#)
- [Configurations, on page 438](#)

Feature Summary and Revision History

Summary Data

Table 100: Summary Data

Applicable Product(s) or Functional Area	5G-UPF
Applicable Platform(s)	VPC-SI SMI
Feature Default Setting	Enabled – Always-on
Related Changes in this Release	Not Applicable
Related Documentation	<i>UCC 5G UPF Configuration and Administration Guide</i>

Revision History

Revision Details	Release
First introduced.	2021.02.0

Feature Description

The 5G-UPF supports new standard QoS Class Index (QCIs) based on 3GPP TS 23.203 Release 12, for Mission Critical and Push-to-Talk (MC/PTT) applications.

As part of this feature, the following functionalities are supported:

- Establishing a LTE/WiFi/5G-NR call with default bearer QCI/QFI with new standard non-GBR QCIs (69, 70 and 80). These are MC-PTT and 5G-NSA QCIs.
- Establishment of dynamic rule with new standard GBR/non-GBR QCI (65, 66, 69, 70, 80, 82, 83).
- Support for Extended QoS Bit Rates for DCNR-enabled UEs with new standard QCIs (80, 82, and 83).
- LTE to 5G and 5G to LTE HO, WiFi to 5G and 5G to WiFi HO, and LTE to WiFi and WiFi to LTE HO are supported.
- DSCP Marking in UL and DL direction based on new standard QCIs.

Limitations

In this release, predefined rules with the new standard QCIs aren't supported.

Configurations

There is no configuration (or License) required at SMF or UPF to enable new standard QCIs.

At SMF, the following configuration is required to enable Extended QoS Bit Rates.

```
configure
  profile dnn name
    dcnr { true | false }
  end
```

- **dcnr**: Specifies to enable dual connectivity with new radio (DCNR).



CHAPTER 47

System Logs

This chapter describes how to configure parameters related to the various types of logging and how to viewing their content. It includes the following sections:

- [Feature Summary and Revision History, on page 439](#)
- [System Log Types, on page 440](#)
- [Configuring Event Logging Parameters, on page 441](#)
- [Configuring Active Logs, on page 446](#)
- [Specifying Facilities, on page 447](#)
- [Configuring Trace Logging, on page 455](#)
- [Configuring Monitor Logs, on page 456](#)
- [Viewing Logging Configuration and Statistics, on page 456](#)
- [Viewing Event Logs Using the CLI, on page 457](#)
- [Configuring and Viewing Crash Logs, on page 458](#)
- [Reducing Excessive Event Logging, on page 460](#)
- [Checkpointing Logs, on page 462](#)
- [Saving Log Files, on page 462](#)
- [Event ID Overview, on page 464](#)

Feature Summary and Revision History

Summary Data

Table 101: Summary Data

Applicable Product(s) or Functional Area	5G-UPF
Applicable Platform(s)	VPC-SI SMI
Feature Default Setting	Disabled – Configuration Required
Related Changes in This Release:	Not Applicable

Related Documentation	<i>UCC 5G UPF Configuration and Administration Guide</i>
-----------------------	--

Revision History

Table 102: Revision History

Revision Details	Release
First introduced.	2020.02.0

System Log Types

There are five types of logs that can be configured and viewed on the system:



Important Not all Event Logs can be configured on all products. Configurability depends on the hardware platform and licenses in use.

- **Event:** Event logging can be used to determine system status and capture important information pertaining to protocols and tasks in use by the system. This is a global function that will be applied to all contexts, sessions, and processes.
- **Active:** Active logs are operator configurable on a CLI instance-by-CLI instance basis. Active logs that are configured by an administrative user in one CLI instance cannot be viewed by an administrative user in a different CLI instance. Each active log can be configured with filter and display properties that are independent of those configured globally for the system. Active logs are displayed in real time as events are generated.
- **Trace:** Trace logging can be used to quickly isolate issues that may arise for a particular connected subscriber session. Traces can be taken for a specific call identification (callid) number, IP address, mobile station identification (MSID) number, or username.
- **Monitor:** Monitor logging records all activity associated with a particular session. This functionality is available in order to comply with law enforcement agency requirements for monitoring capabilities of particular subscribers. Monitors can be performed based on a subscriber's MSID or username.
- **Crash:** Crash logging stores useful information pertaining to system software crashes. This information is useful in determining the cause of the crash.



Important Stateful Firewall and NAT supports logging of various messages on screen if logging is enabled for firewall. These logs provide detailed messages at various levels, like critical, error, warning, and debug. Stateful Firewall and NAT attack logs also provide information on the source IP address, destination IP address, protocol, or attack type for any packet dropped due to an attack and are also sent to a syslog server if configured in the system. For more information on logging support for Stateful Firewall and NAT, see the *Logging Support* chapter of *PSF Administration Guide* or *NAT Administration Guide*.

Configuring Event Logging Parameters

The system can be configured to generate logs based on user-defined filters. The filters specify the facilities (system tasks or protocols) that the system is to monitor and severity levels at which to trigger the generation of the event entries.

Event logs are stored in system memory and can be viewed via the CLI. There are two memory buffers that store event logging information. The first buffer stores the active log information. The second buffer stores inactive logging information. The inactive buffer is used as a temporary repository to allow you to view logs without having data be overwritten. Logs are copied to the inactive buffer only through manual intervention.

Each buffer can store up to 50,000 events. Once these buffers reach their capacity, the oldest information is removed to make room for the newest.

To prevent the loss of log data, the system can be configured to transmit logs to a syslog server over a network interface.

Configuring Event Log Filters

You can filter the contents of event logs at the Exec mode and Global Configuration mode levels.

Exec Mode Filtering

These commands allow you to limit the amount of data contained in logs without changing global logging parameters.

Follow the examples below to filter logs via Exec mode commands.

Active Filtering

```
logging active [ copy runtime filters ] [ event-verbosity event_level ] [ pdu-data format ] [ pdu-verbosity pdu_level ]
```

Notes:

- **copy runtime filters** – Copies the runtime filters and uses that copy to filter the current logging session.
- **event-verbosity event_level** – Specifies the level of verbosity to use in logging of events as one of:
 - *min* – Displays minimal information about the event. Information includes event name, facility, event ID, severity level, date, and time.
 - *concise* – Displays detailed information about the event, but does not provide the event source within the system.
 - *full* – Displays detailed information about event, including source information, identifying where within the system the event was generated.
- **pdu-data format** – Specifies output format for packet data units when logged as one of:
 - *none* – raw format (unformatted).
 - *hex* – hexadecimal format
 - *hex-ascii* – hexadecimal and ASCII similar to a main-frame dump

- **pdu-verbosity** *pdu_level* – Specifies the level of verbosity to use in logging of packet data units as an integer from 1 through 5, where 5 is the most detailed.

Disable or Enable Filtering by Instance(s)

```
logging filter active facility facility level severity_level [ critical-info |
no-critical-info ]
```

```
logging filter { disable | enable } facility facility { all | instance
instance_number }
```

Notes:

- **active** – Indicates that only active processes are to have logging options set.
- **disable** – Disables logging for a specific instance or all instances. This keyword is only supported for aaamgr, hamgr and sessmgr facilities.
- **enable** – Enables logging for a specific instance or all instances. This keyword is only supported for aaamgr, hamgr and sessmgr facilities. By default logging is enabled for all instances of aaamgr, hamgr and sessmgr.
- **facility** *facility* and **level** *severity_level* – Configure the logging filter that determines which system facilities should be logged and at what levels.
- **all** | **instance** *instance_number* – Specifies whether logging will be disabled or enabled for all instances or a specific instance of aaamgr, hamgr or sessmgr. Run the **show session subsystem facility** *facility* command to identify specific instance numbers.



Note These keywords are only supported with the **disable** and **enable** keywords.

- **level** *severity_level* – Specifies the level of information to be logged from the following list which is ordered from highest to lowest:
 - critical - display critical events
 - error - display error events and all events with a higher severity level
 - warning - display warning events and all events with a higher severity level
 - unusual - display unusual events and all events with a higher severity level
 - info - display info events and all events with a higher severity level
 - trace - display trace events and all events with a higher severity level
 - debug - display all events



Note This keyword is only supported in conjunction with the **active** keyword.

- **critical-info** – Specifies that events with a category attribute of critical information are to be displayed. Examples of these types of events can be seen at bootup when system processes and tasks are being initiated. This is the default setting.

no-critical-info – Specifies that events with a category attribute of critical information are not to be displayed.



Note These keywords are only supported in conjunction with the **active** keyword.



Important To enable logging of a single instance of a facility, you must first disable all instances of the facility (**logging filter disable facility *facility* all**) and then enable logging of the specific instance (**logging filter enable facility *facility* instance *instance_number***). To restore default behavior you must re-enable logging of all instances (**logging filter enable facility *facility* all**).

You can display the instance numbers for enabled instances per facility using the Exec mode **show instance-logging** command.

Global Configuration Mode Filtering

You can filter the contents of event logs at the Exec mode and Global Configuration mode levels.

Follow the example below to configure run time event logging parameters for the system:

```
configure
logging filter runtime facility facility level report_level
logging display { event-verbosity | pdu-data | pdu-verbosity }
end
```

Notes:

- **facility *facility*** and **level *severity_level*** – Configure the logging filter that determines which system facilities should be logged and at what levels.
- Repeat for every facility that you would like to log.
- *Optional:* Configure event ID restrictions by adding the **logging disable eventid** command. The system provides the ability to restrict the sending of a specific event ID or a range of event IDs to minimize the amount of data logged to that which is most useful. Repeat to disable logging for additional event IDs or event ID ranges.
- If an administrator restricts event logging for an Event ID or Event ID range using the above command (**logging disable eventid**), the system will generate a Critical Event log "cli 30999 critical" as well as an SNMP trap "1361 (DisabledEventIDs)" with the specific Event IDs or Event ID range that was disabled. These event logs and traps are enabled by default in this release, and cannot be disabled.
- If an administrator lowers the logging level (using the **logging filter runtime facility *facility* level *report_level*** command below the default level of "error", the system will generate a Critical Event log "cli 30998 critical" as well as an SNMP trap "1362 (LogLevelChanged)" with the specific Event IDs or Event ID range that was disabled.

These event logs and traps are enabled by default in this release, and cannot be disabled.

The following examples show the CLI output of the traps generated when event logging or logging levels are changed.

```
show snmp trap statistics
SNMP Notification Statistics:
...
Trap Name                               #Gen #Disc  Disable Last Generated
-----
...
DisabledEventIDs                         1     0     0 2021:05:11:15:35:25
LogLevelChanged                          2     0     0 2021:05:11:15:28:03

show snmp trap history
There are x historical trap records (5000 maximum)

Timestamp                               Trap Information
-----
...
Thu May 11 15:28:03 2021 Internal trap notification 1362 (LogLevelChanged) Logging level
of facility resmgr is changed to critical by user #initial-config# context local privilege
level Security Administrator ttyname /dev/pts/0 address type IPV4 remote ip address
209.165.202.129
...
Thu May 11 15:35:25 2021 Internal trap notification 1361 (DisabledEventIDs) Event IDs from
100 to 1000 have been disabled by user adminuser context context privilege level security
administrator ttyname tty address type IPV4 remote ip address 209.165.202.134
...
Mon May 15 10:14:56 2021 Internal trap notification 1362 (LogLevelChanged) Logging level
of facility sitmain is changed to critical by user staradmin context local privilege level
Security Administrator ttyname /dev/pts/1 address type IPV4 remote ip address 209.165.202.120
```

Configuring Syslog Servers

Syslog Architecture

System Logging (syslog) is the architecture which produces and sends event information from the UPF over the UDP transport layer to a centralized Event Message Collector. Syslog uses a client/server architecture:

- **Syslog Client:** A set of processes running on UPF, which operate as the sending device for event messages.
- **Syslog Server:** An external server configured to receive the event messages sent from the UPF.

UPF transports event messages using the Syslog Protocol without expecting acknowledgment of receipt. The system forwards event messages regardless if a Syslog Server is available to receive the messages.

Configuring the System to Sent Event Messages to an External Syslog Server

Information that is generated by the run time event logging filters can be transmitted to a syslog server for permanent storage.



Important

The data transmitted to the Syslog server is meant to be used for informational purposes. Functions such as billing and performance monitoring should not be based on syslogs.



Important Although the system provides the flexibility to configure syslog servers on a context-by-context basis, it is recommended that all servers be configured in the *local* context in order to isolate the log traffic from the network traffic.

Use the following example to configure syslog servers:

```
configure
  context context_name
  logging syslog ip_address [ event-verbosity { min | concise | full } |
  facility facilities | msg-format { rfc3164 | rfc5424 } | pdu-data { none
  | hex | hex-ascii } | pdu-verbosity pdu_level | port number | rate value
  ]
  end
```

NOTES:

- **syslog ip_address**: Specifies the IP address of a system log server on the network in IPv4 dotted-decimal or IPv6 colon-separated-hexadecimal notation.
- **event-verbosity { min | concise | full }**: Specifies the level of detail to use in logging of events. Detail level must be one of the following:
 - **min**: Displays minimal detail.
 - **concise**: Displays summary detail.
 - **full**: Displays full detail.
- **facility facilities**: Specifies the local facility for which the system logging server's logging options are applied. Local facility must be one of the following:
 - **local0**—Pertains to syslog severity level of 0, Emergency
 - **local1**—Pertains to syslog severity level of 1, Alert
 - **local2**—Pertains to syslog severity level of 2, Critical
 - **local3**—Pertains to syslog severity level of 3, Error
 - **local4**—Pertains to syslog severity level of 4, Warning
 - **local5**—Pertains to syslog severity level of 5, Notice
 - **local6**—Pertains to syslog severity level of 6, Informational
 - **local7**—Pertains to syslog severity level of 7, Debug

Default: **local7**

If local facility is not specified, then **local7** is applied by default.

Multiple system log servers can share the logging options of a given local facility. This allows for the logical grouping of system log servers and the options which affect all of those associated with the same local facility.

- **msg-format { rfc3164 | rfc5424 }**: Configures the message format for each system log server as per RFC3164 or RFC5424. Default: rfc3164.

- **pdu-data { none | hex | hex-ascii }**: Specifies output format for packet data units when logged. Format must be one of the following:
 - **none**: Displays data in raw format.
 - **hex**: Displays data in hexadecimal format.
 - **hex-ascii**: Displays data in hexadecimal and ASCII format (similar to a mainframe dump).
- **pdu-verbosity pdu_level**: Specifies the level of verbosity to use in logging of packet data units as a value from 1 through 5, where 5 is the most detailed.
- **port number**: Specifies an alternate port number for the system log server. Default: 514.
number must be an integer value from 1 through 65535.
- **rate value**: Specifies the rate at which log entries are allowed to be sent to the system log server. No more than the number specified by *value* is sent to a system log server within any given one-second interval.
value must be an integer from 0 through 100000. Default: 1000
- Repeat as necessary to configure extra syslog servers. There is no limit to the number of syslog servers that can be configured.

Configuring Active Logs

Active logs are event logs that are operator configurable on a CLI instance-by-CLI instance basis. Active logs configured by an administrative user in one CLI instance are not displayed to an administrative user in a different CLI instance. Each active log can be configured with filter and display properties that are independent of those configured globally for the system. Active logs are displayed in real time as they are generated.

Active logs are not written to the active memory buffer by default. To write active logs to the active memory buffer execute the following command in the Global Configuration mode:

```
logging runtime buffer store all-events
```

When active logs are written to the active memory buffer, they are available to all users in all CLI instances.

Use the following example to configure active logging in Global Configuration mode:

```
logging filter runtime facility facility level report_level
```

NOTES:

- Configure the logging filter that determines which system facilities should be logged and at what levels.
- Repeat for every facility that you want to log.
- *Optional*: Configure event ID restrictions by adding the **logging disable eventid** command. The system provides the ability to restrict the sending of a specific event ID or a range of event IDs to minimize the amount of data logged to that which is most useful. Repeat to disable logging for more event IDs or event ID ranges.

Once all the necessary information has been gathered, the Active log display can be stopped by entering the following command in the EXEC mode:

no logging active

Specifying Facilities

The following facilities can be configured for logging event data:

- **a10**: A10 interface facility
- **a11**: A11 interface facility
- **a11mgr**: A11 Manager facility
- **aaa-client**: Authentication, Authorization and Accounting (AAA) client facility
- **aaamgr**: AAA manager logging facility
- **aaaproxy**: AAA Proxy facility
- **aal2**: ATM Adaptation Layer 2 (AAL2) protocol logging facility
- **acl-log**: Access Control List (ACL) logging facility
- **acsctrl**: Active Charging Service (ACS) Controller facility
- **acsmgr**: ACS Manager facility
- **afctrl**: Fabric Controller facility [ASR 5500 only]
- **afmgr**: Fabric Manager logging facility [ASR 5500 only]
- **alarmctrl**: Alarm Controller facility
- **alcap**: Access Link Control Application Part (ALCAP) protocol logging facility
- **alcapmgr**: ALCAP manager logging facility
- **all**: All facilities
- **bfd**: Bidirectional Forwarding Detection (BFD) protocol logging facility
- **bgp**: Border Gateway Protocol (BGP) facility
- **bindmux**: IPCF BindMux-Demux Manager logging facility
- **bngmgr**: Broadband Network Gateway (BNG) Demux Manager logging facility
- **bssap+**: Base Station Sub-system Application Part+ protocol facility for the login interface between the SGSN and the MSC/VLR (2.5G and 3G)
- **bssgp**: Base Station Sub-system GPRS Protocol logging facility handles exchange information between the SGSN and the BSS (2.5G only)
- **callhome**: Call Home application logging facility
- **cap**: CAMEL Application Part (CAP) logging facility for protocol used in prepaid applications (2.5G and 3G)
- **cbsmgr**: Cell Broadcasting Service (CBS) logging facility [HNBGW]
- **cdf**: Charging Data Function (CDF) logging facility

- **cfctrl**: Content filtering controller logging facility
- **cfmgr**: Content filtering manager logging facility
- **cgw**: Converged Access Gateway (CGW) logging facility
- **cli**: Command Line Interface (CLI) logging facility
- **cmp**: Certificate Management Protocol (IPSec) logging facility
- **confdmgr**: ConfD Manager proctlet (NETCONF) logging facility
- **connectedapps**: SecGW ASR 9000 oneP communication proctlet
- **connproxy**: Controller Proxy logging facility
- **credit-control**: Credit Control (CC) facility
- **csp**: Card/Slot/Port controller facility
- **css**: Content Service Selection (CSS) facility
- **css-sig**: CSS RADIUS Signaling facility
- **cx-diameter**: Cx Diameter Messages facility [CSCF <--> HSS]
- **data-mgr**: Data Manager Framework logging facility
- **dcardctrl**: IPSec Daughter Card Controller logging facility
- **dcardmgr**: IPSec Daughter Card Manager logging facility
- **demuxmgr**: Demux Manager API facility
- **dgmbmgr**: Diameter Gmb Application Manager logging facility
- **dhcp**: Dynamic Host Configuration Protocol (DHCP) logging facility
- **dhcpv6**: DHCPv6
- **dhost**: Distributed Host logging facility
- **diabase**: Diabase messages facility
- **diactrl**: Diameter Controller proctlet logging facility
- **diameter**: Diameter endpoint logging facility
- **diameter-acct**: Diameter Accounting
- **diameter-auth**: Diameter Authentication
- **diameter-dns**: Diameter DNS subsystem
- **diameter-ecs**: ACS Diameter signaling facility
- **diameter-engine**: Diameter version2 engine logging facility
- **diameter-hdd**: Diameter Horizontal Directional Drilling (HDD) Interface facility
- **diameter-svc**: Diameter Service
- **diamproxy**: DiamProxy logging facility

- **doulosuemgr**: Doulos (IMS-IPSec-Tool) user equipment manager
- **dpath**: IPSec Data Path logging facility
- **drvctrl**: Driver Controller logging facility
- **eap-diameter**: Extensible Authentication Protocol (EAP) IP Sec urity facility
- **eap-ipsec**: Extensible Authentication Protocol (EAP) IPSec facility
- **eap-sta-s6a-s13-s6b-diameter**: EAP/STA/S6A/S13/S6B Diameter messages facility
- **ecs-css**: ACSMGR <-> Session Manager Signalling Interface facility
- **egtpc**: eGTP-C logging facility
- **egtpmgr**: enhanced GPRS Tunneling Protocol (eGTP) manager logging facility
- **egtpu**: eGTP-U logging facility
- **embms**: evolved Multimedia Broadcast Multicast Services Gateway facility
- **embms**: eMBMS Gateway Demux facility
- **epdg**: evolved Packet Data (ePDG) gateway logging facility
- **event-notif**: Event Notification Interface logging facility
- **evlog**: Event log facility
- **famgr**: Foreign Agent manager logging facility
- **firewall**: Firewall logging facility
- **fng**: Femto Network Gateway (FNG) logging facility
- **gbmgr**: SGSN Gb Interface Manager facility
- **gmm**:
 - For 2.5G: Logs the GPRS Mobility Management (GMM) layer (above LLC layer)
 - For 3G: Logs the access application layer (above the RANAP layer)
- **gprs-app**: GPRS Application logging facility
- **gprs-ns**: GPRS Network Service Protocol (layer between SGSN and the BSS) logging facility
- **gq-rx-tx-diameter**: Gq/Rx/Tx Diameter messages facility
- **gss-gcdr**: GTP Storage Server GCDR facility
- **gtpc**: GTP-C protocol logging facility
- **gtpcmgr**: GTP-C protocol manager logging facility
- **gtp**: GTP-prime protocol logging facility
- **gtpu**: GTP-U protocol logging facility
- **gtpumgr**: GTP-U Demux manager

- **gx-ty-diameter**: Gx/Ty Diameter messages facility
- **gy-diameter**: Gy Diameter messages facility
- **h248prt**: H.248 port manager facility
- **hamgr**: Home Agent manager logging facility
- **hat**: High Availability Task (HAT) process facility
- **hdctrl**: HD Controller logging facility
- **henbapp**: Home Evolved NodeB (HENB) App facility
- **henbgw**: HENB-GW facility
- **henbgw-pws**: HENB-GW Public Warning System logging facility
- **henbgw-sctp-acs**: HENB-GW access Stream Control Transmission Protocol (SCTP) facility
- **henbgw-sctp-nw**: HENBGW network SCTP facility
- **henbgwdemux**: HENB-GW Demux facility
- **henbgwmgr**: HENB-GW Manager facility
- **hnb-gw**: HNB-GW (3G Femto GW) logging facility
- **hnbmgr**: HNB-GW Demux Manager logging facility
- **hss-peer-service**: Home Subscriber Server (HSS) Peer Service facility
- **iftask**: Internal Forwarder Task (Intel DPDK) used on VPC-SI and VPC-DI platforms
- **igmp**: Internet Group Management Protocol (IGMP)
- **ikev2**: Internet Key Exchange version 2 (IKEv2)
- **ims-authorizatn**: IP Multimedia Subsystem (IMS) Authorization Service facility
- **ims-sh**: HSS Diameter Sh Interface Service facility
- **imsimgr**: SGSN IMSI Manager facility
- **imsue**: IMS User Equipment (IMSUE) facility
- **ip-arp**: IP Address Resolution Protocol facility
- **ip-interface**: IP interface facility
- **ip-route**: IP route facility
- **ipms**: Intelligent Packet Monitoring System (IPMS) logging facility
- **ipne**: IP Network Enabler (IPNE) facility
- **ipsec**: IP Security logging facility
- **ipsecdemux**: IPSec demux logging facility
- **ipsg**: IP Service Gateway interface logging facility
- **ipsgmgr**: IP Services Gateway facility

- **ipsp**: IP Pool Sharing Protocol logging facility
- **kvstore**: Key/Value Store (KVSTORE) Store facility
- **l2tp-control**: Layer 2 Tunneling Protocol (L2TP) control logging facility
- **l2tp-data**: L2TP data logging facility
- **l2tpdemux**: L2TP Demux Manager logging facility
- **l2tpmgr**: L2TP Manager logging facility
- **lagmgr**: Link Aggregation Group (LAG) manager logging facility
- **lcs**: Location Services (LCS) logging facility
- **ldap**: Lightweight Directory Access Protocol (LDAP) messages logging facility
- **li**: Refer to the *Lawful Intercept Configuration Guide* for a description of this command.
- **linkmgr**: SGSN/BSS SS7 Link Manager logging facility (2.5G only)
- **llc**: Logical Link Control (LLC) Protocol logging facility; for SGSN: logs the LLC layer between the GMM and the BSSGP layers for logical links between the MS and the SGSN
- **local-policy**: Local Policy Service facility
- **location-service**: Location Services facility
- **m3ap**: M3 Application Protocol facility
- **m3ua**: M3UA Protocol logging facility
- **magmgr**: Mobile Access Gateway manager logging facility
- **map**: Mobile Application Part (MAP) protocol logging facility
- **megadiammgr**: MegaDiameter Manager (SLF Service) logging facility
- **mme-app**: Mobility Management Entity (MME) Application logging facility
- **mme-embms**: MME evolved Multimedia Broadcast Multicast Service facility
- **mme-misc**: MME miscellaneous logging facility
- **mmedemux**: MME Demux Manager logging facility
- **mmemgr**: MME Manager facility
- **mmgr**: Master Manager logging facility
- **mobile-ip**: Mobile IP processes
- **mobile-ip-data**: Mobile IP data facility
- **mobile-ipv6**: Mobile IPv6 logging facility
- **mpls**: Multiprotocol Label Switching (MPLS) protocol logging facility
- **mrme**: Multi Radio Mobility Entity (MRME) logging facility
- **mseg-app**: Mobile Services Edge Gateway (MSEG) application logging facility

- **mseg-gtpc**: MSEG GTP-C application logging facility
- **mseg-gtpu**: MSEG GTP-U application logging facility
- **msegmgr**: MSEG Demux Manager logging facility
- **mtp2**: Message Transfer Part 2 (MTP2) Service logging facility
- **mtp3**: Message Transfer Part 3 (MTP3) Protocol logging facility
- **multicast-proxy**: Multicast Proxy logging facility
- **nas**: Non-Access Stratum (NAS) protocol logging facility [MME 4G]
- **netwstrg**: Network Storage facility
- **npuctrl**: Network Processor Unit Control facility
- **npudrv**: Network Processor Unit Driver facility [ASR 5500 only]
- **npumgr**: Network Processor Unit Manager facility
- **npumgr-acl**: NPUMGR ACL logging facility
- **npumgr-drv**: NPUMGR DRV logging facility
- **npumgr-flow**: NPUMGR FLOW logging facility
- **npumgr-fwd**: NPUMGR FWD logging facility
- **npumgr-init**: NPUMGR INIT logging facility
- **npumgr-lc**: NPUMGR LC logging facility
- **npumgr-port**: NPUMGR PORT logging facility
- **npumgr-recovery**: NPUMGR RECOVERY logging facility
- **npumgr-rri**: NPUMGR RRI (Reverse Route Injection) logging facility
- **npumgr-vpn**: NPUMGR VPN logging facility
- **npusim**: NPUSIM logging facility [ASR 5500 only]
- **ocsp**: Online Certificate Status Protocol logging facility.
- **orbs**: Object Request Broker System logging facility
- **ospf**: OSPF protocol logging facility
- **ospfv3**: OSPFv3 protocol logging facility
- **p2p**: Peer-to-Peer Detection logging facility
- **pagingmgr**: PAGINGMGR logging facility
- **pccmgr**: Intelligent Policy Control Function (IPCF) Policy Charging and Control (PCC) Manager library
- **pdg**: Packet Data Gateway (PDG) logging facility
- **pdgdmgr**: PDG Demux Manager logging facility
- **pdif**: Packet Data Interworking Function (PDIF) logging facility

- **pgw**: Packet Data Network Gateway (PGW) logging facility
- **pmm-app**: Packet Mobility Management (PMM) application logging facility
- **ppp**: Point-To-Point Protocol (PPP) link and packet facilities
- **pppoe**: PPP over Ethernet logging facility
- **proclet-map-frwk**: Proclet mapping framework logging facility
- **push**: VPNMGR CDR push logging facility
- **radius-acct**: RADIUS accounting logging facility
- **radius-auth**: RADIUS authentication logging facility
- **radius-coa**: RADIUS change of authorization and radius disconnect
- **ranap**: Radio Access Network Application Part (RANAP) Protocol facility logging info flow between SGSN and RNS (3G)
- **rct**: Recovery Control Task logging facility
- **rdt**: Redirect Task logging facility
- **resmgr**: Resource Manager logging facility
- **rf-diameter**: Diameter Rf interface messages facility
- **rip**: Routing Information Protocol (RIP) logging facility [RIP is not supported at this time.]
- **rlf**: Rate Limiting Function (RLF) logging facility
- **rohc**: Robust Header Compression (RoHC) facility
- **rsvp**: Reservation Protocol logging facility
- **rua**: RANAP User Adaptation (RUA) [3G Femto GW - RUA messages] logging facility
- **s102**: S102 protocol logging facility
- **s102mgr**: S102Mgr logging facility
- **s1ap**: S1 Application Protocol (S1AP) Protocol logging facility
- **sabp**: Service Area Broadcast Protocol (SABP) logging facility
- **saegw**: System Architecture Evolution (SAE) Gateway facility
- **sbc**: SBc protocol logging facility
- **sccp**: Signalling Connection Control Part (SCCP) Protocol logging (connection-oriented messages between RANAP and TCAP layers).
- **set**: Shared Configuration Task logging facility
- **setp**: Stream Control Transmission Protocol (SCTP) Protocol logging facility
- **sef_ees**: Severely Errored Frames (SEF) APIs printing facility
- **sess-gr**: SM GR facility

- **sessctrl**: Session Controller logging facility
- **sessmgr**: Session Manager logging facility
- **sesstrc**: session trace logging facility
- **sft**: Switch Fabric Task logging facility
- **sgs**: SGs interface protocol logging facility
- **sgsn-app**: SGSN-APP logging various SGSN "glue" interfaces (for example, between PMM, MAP, GPRS-FSM, SMS).
- **sgsn-failures**: SGSN call failures (attach/activate rejects) logging facility (2.5G)
- **sgsn-gtpc**: SGSN GTP-C Protocol logging control messages between the SGSN and the GGSN
- **sgsn-gtpu**: SGSN GTP-U Protocol logging user data messages between the SGSN and GGSN
- **sgsn-mbms-bearer**: SGSN Multimedia Broadcast/Multicast Service (MBMS) Bearer app (SMGR) logging facility
- **sgsn-misc**: Used by stack manager to log binding and removing between layers
- **sgsn-system**: SGSN System Components logging facility (used infrequently)
- **sgsn-test**: SGSN Tests logging facility; used infrequently
- **sgtpcmgr**: SGSN GTP-C Manager logging information exchange through SGTPC and the GGSN
- **sgw**: Serving Gateway facility
- **sh-diameter**: Sh Diameter messages facility
- **sitmain**: System Initialization Task main logging facility
- **slmgr**: Smart Licensing manager logging facility
- **sls**: Service Level Specification (SLS) protocol logging facility
- **sm-app**: SM Protocol logging facility
- **sms**: Short Message Service (SMS) logging messages between the MS and the SMSC
- **sndcp**: Sub Network Dependent Convergence Protocol (SNDCP) logging facility
- **snmp**: SNMP logging facility
- **sprmgr**: IPCF Subscriber Policy Register (SPR) manager logging facility
- **srdp**: Static Rating Database
- **srp**: Service Redundancy Protocol (SRP) logging facility
- **sscfnni**: Service-Specific Coordination Function for Signaling at the Network Node Interface (SSCF-NNI) logging facility
- **sscopol**: Service-Specific Connection-Oriented Protocol (SSCOP) logging facility
- **ssh-ipsec**: Secure Shell (SSH) IP Security logging facility
- **ssl**: Secure Socket Layer (SSL) message logging facility

- **stat**: Statistics logging facility
- **supserv**: Supplementary Services logging facility [H.323]
- **system**: System logging facility
- **tacacsplus**: TACACS+ Protocol logging facility
- **tcap**: TCAP Protocol logging facility
- **testctrl**: Test Controller logging facility
- **testmgr**: Test Manager logging facility
- **threshold**: threshold logging facility
- **ttg**: Tunnel Termination Gateway (TTG) logging facility
- **tucl**: TCP/UDP Convergence Layer (TUCL) logging facility
- **udr**: User Data Record (UDR) facility (used with the Charging Service)
- **user-data**: User data logging facility
- **user-l3tunnel**: User Layer 3 tunnel logging facility
- **usertcp-stack**: User TCP Stack
- **vim**: Voice Instant Messaging (VIM) logging facility
- **vinfo**: VINFO logging facility
- **vmgctrl**: Virtual Media Gateway (VMG) controller facility
- **vmgctrl**: VMG Content Manager facility
- **vpn**: Virtual Private Network logging facility
- **vpp**: Vector Packet Processing (VPP) logging facility
- **wimax-data**: WiMAX DATA
- **wimax-r6**: WiMAX R6
- **wsg**: Wireless Security Gateway (ASR 9000 Security Gateway)
- **x2gw-app**: X2GW (X2 proxy Gateway, eNodeB) application logging facility
- **x2gw-demux**: X2GW demux task logging facility

Configuring Trace Logging

Trace logging is useful for quickly resolving issues for specific sessions that are currently active. They are temporary filters that are generated based on a qualifier that is independent of the global event log filter configured using the **logging filter** command in the Exec mode. Like event logs, however, the information generated by the logs is stored in the active memory buffer.

All debug level events associated with the selected call are stored.



Important Trace logs impact session processing. They should be implemented for debug purposes only.

Use the following example to configure trace logs in the Exec mode:

```
logging trace { callid call_id | ipaddr ip_address | msid ms_id | username
username }
```

Once all of the necessary information has been gathered, the trace log can be deleted by entering the following command:

```
no logging trace { callid call_id | ipaddr ip_address | msid ms_id | username
username }
```

Configuring Monitor Logs

Monitor logging records all activity associated with all of a particular subscriber's sessions. This functionality is available in compliance with law enforcement agency requirements for monitoring capabilities of particular subscribers.

Monitors can be performed based on a subscriber's MSID or username, and are only intended to be used for finite periods of time as dictated by the law enforcement agency. Therefore, they should be terminated immediately after the required monitoring period.

This section provides instructions for enabling and disabling monitor logs.

Enabling Monitor Logs

Use the following example to configure monitor log targets:

```
configure
logging monitor { ip_addr | ipv6_addr | msid id | username name }
end
```

Repeat to configure additional monitor log targets.

Disabling Monitor Logs

Use the following example to disable monitor logs:

```
configure
no logging monitor { ip_addr | ipv6_addr | msid id | username name }
end
```

Viewing Logging Configuration and Statistics

Logging configuration and statistics can be verified by entering the following command from the Exec mode:

```
show logging [ active | verbose ]
```

When no keyword is specified, the global filter configuration is displayed as well as information about any other type of logging that is enabled.

The following table provides information and descriptions of the statistics that are displayed when the **verbose** keyword is used.

Table 103: Logging Configuration and Statistics Commands

Field	Description
General Logging Statistics	
Total events received	Displays the total number of events generated by the system.
Number of applications receiving events	Displays the number of applications receiving the events.
Logging Source Statistics	
Event sequence ids by process	Displays a list of system processes that have generated events and the reference identification number of the event that was generated.
Msg backlog stat with total cnt	Displays the number of event messages that have been back logged in comparison to the total number of events generated.
LS L2 filter drop rate	Displays the percentage of logging source (LS) layer 2 (L2) event drops.
Abnormal Log Source Statistics	Displays abnormal logging source (LS) statistics, if any.
Runtime Logging Buffer Statistics	
Active buffer	Displays the number of events currently logged in the active memory buffer and a timestamp for the oldest and most recent entries in the buffer.
Inactive buffer	Displays the number of events currently logged in the inactive memory buffer.

Viewing Event Logs Using the CLI

Event logs generated by the system can be viewed in one of the following ways:

- **From the syslog server:** If the system is configured to send logs to a syslog server, the logs can be viewed directly on the syslog server.
- **From the system CLI:** Logs stored in the system memory buffers can be viewed directly from the CLI.
- **From the console port:** By default, the system automatically displays events over the console interface to a terminal provided that there is no CLI session active.

This section provides instructions for viewing event logs using the CLI. These instructions assume that you are at the root prompt for the Exec mode.

Step 1 Copy the active log memory buffer to the inactive log memory buffer.

When the active log memory buffer is copied to the inactive log memory buffer existing information in the inactive log memory buffer is deleted.

Both active and inactive event log memory buffers can be viewed using the CLI in Exec mode. However, it is preferable to view the inactive log in order to prevent any data from being over-written. The information from the active log buffer can be copied to the inactive log buffer by entering the following command:

```
logs checkpoint
```

Step 2 View the logs by entering the following command:

```
show logs
```

Configuring and Viewing Crash Logs

In the unlikely even of a software crash, the system stores information that could be useful in determining the reason for the crash. This information can be maintained in system memory or it can be transferred and stored on a network server.

The system supports the generation of the following two types of logs:

- **Crash log:** Crash logs record all possible information pertaining to a software crash (full core dump). Due to their size, they can not be stored in system memory. Therefore, these logs are only generated if the system is configured with a Universal Resource Locator (URL) pointing to a local device or a network server where the log can be stored.
- **Abridged crash log:** Crash event records are automatically generated when a software crash occurs and are stored in flash memory on management cards. The abridged crash log contains a list crash event records along with associated dump files. This log allows you to view event records and dump files via CLI commands.

Crash Logging Architecture

The crash log is a persistent repository of crash event information. Each event is numbered and contains text associated with a CPU (minicore), NPU, or kernel crash. The logged events are recorded into fixed-length records and stored in /flash/crashlog2.

Whenever a crash occurs, the following crash information is stored:

1. The event record is stored in /flash/crashlog2 file (the crash log).
2. The associated minicore, NPU, or kernel dump file is stored in the /flash/crsh2 directory.
3. A full core dump is stored in a user-configured directory.



Important

The crashlog2 file along with associated minicore, NPU, and kernel dumps are automatically synchronized across redundant management cards (SMC, MIO/UMIO). Full core dumps are not synchronized across management cards.

The following behaviors apply to the crash logging process.

- When a crash event arrives on an active management card, the event record is stored in its `crashlog2` file along with the minicore, NPU, or kernel dump file in `/flash/crsh2`. The crash event and dump file are also automatically stored in the same locations on the standby management card.
- When a crash log entry is deleted through CLI command, it is deleted on both the active and standby management cards.
- When a management card is added or replaced, active and standby cards automatically synchronize crash logs and dump files.
- When a crash event is received and the crash log file is full, the oldest entry in the crash log and its related dump file will be replaced with the latest arrived event and dump file on both management cards. Information for a maximum of 120 crash events can be stored on management cards.
- Duplicate crash events bump the count of hits in the existing record and update the new record with the old crash record. Additions to the count use the timestamp for the first time the event happened.

Configuring Software Crash Log Destinations

The system can be configured to store software crash log information to any of the following locations:

- On VPC
 - **Flash memory:** Accessible by the virtual machine
 - **USB memory stick:** Installed in the USB slot of the platform (USB slot has been enabled via the hypervisor)
 - **Network Server:** Any workstation or server on the network that the system can access using the Trivial File Transfer Protocol (TFTP), the File Transfer Protocol (FTP), the Secure File Transfer Protocol (SFTP), or the Hyper-Text Transfer Protocol (HTTP); this is recommended for large network deployments in which multiple systems require the same configuration

Crash log files (full core dumps) are written with unique names as they occur to the specified location. The name format is `crash-card-cpu-time-core`. Where `card` is the card slot, `cpu` is the number of the CPU on the card, and `time` is the Portable Operating System Interface (POSIX) timestamp in hexadecimal notation.

Use the following example to configure a software crash log destination in the Global Configuration mode:

```
configure
  crash enable [ encrypted ] url crash_url
end
```

NOTES:

- Repeat to configure additional software crash log destinations. There is no limit to the number of destinations that can be configured.

Viewing Abridged Crash Log Information Using the CLI

You can view abridged crash information that is stored as a set of event records in flash memory on management cards (`/flash/crashlog2`). Each crash event record has an associated dump file (minicore, NPU or kernel) that can also be displayed (`/flash/crsh2`)

Follow the instructions in this section to view software crash events that have occurred on the system. These instructions assume that you are at the root prompt for the Exec mode.

Step 1 View a list of software crash events by entering the following Exec mode command:

```
show crash { all | list | number crash_num }
```

NOTES:

- Run **show crash list** to obtain the number for a specific crash event.
- Run **show crash number *crash_num*** to display the output for the target crash event.

The resulting output may not be the same for all platforms:

Information about similar crash events is suppressed in the output of this command.

Step 2 View the dump file associated with a specific crash event.

The information contained in the dump file helps identify and diagnose any internal or external factors causing the software to crash.

- Crash # – unique number assigned by StarOS when logging the crash event
- SW Version – StarOS build release in format: RR.n(bbbbb)
- Similar Crash Count – number of similar crashes
- Time of first crash – timestamp when first crash occurred in format: YYYY-MMM-DD+hh:mm:ss
- Failure message – text of event message
- Function – code identifier
- Process – where the crash occurred (Card, CPU, PID, etc.)
- Crash time – timestamp for when the crash occurred in the format: YYYY-MMM-DD+hh:mm:ss time zone
- Recent errno – text of most recent error number.
- Stack – memory stack information
- Last Bounce – information about the messaging received prior to the crash
- Registers – memory register contents
- Current inbound message – hexadecimal information for the current inbound message
- Address Map
- Recent heap activity (oldest first)
- Recent events (oldest first)
- Profile depth

Reducing Excessive Event Logging

Event logging (evlogd) is a shared medium that captures event messages sent by StarOS facilities. When one or more facilities continuously and overwhelmingly keep sending a high volume of event messages, the

remaining non-offender facilities are impacted. This scenario degrades system performance, especially as the number of facilities generating logs increases.

Rate-control of event message logging is handled in the Log Source path. Essentially, every second a counter is set to zero and is incremented for each log event that is sent to evlogd. If the count reaches a threshold before the second is up, the event is sent, queued, or dropped (if the evlogd messenger queue is full).

When any facility exceeds the upper threshold set with this command for the rate of message logging and remains in the same state for prolonged interval, StarOS notifies the user through an SNMP trap or alarm.

A new threshold command allows you to specify the percentage of facility event queue full. When this threshold is exceeded, an SNMP trap and alarm are generated that specifies the offending facility.

The formats for the SNMP traps that are associated with this command are as follows:

- **ThreshLSLogsVolume**

```
<timestamp> Internal trap notification <trap_id> (ThreshLSLogsVolume) threshold
<upper_percent>%
measured value <actual_percent>% for facility <facility_name> instance <instance_id>
```

- **ThreshClearLSLogsVolume**

```
<timestamp> Internal trap notification <trap_id> (ThreshClearLSLogsVolume) threshold
<upper_percent>%
measured value <actual_percent>% for facility <facility_name> instance <instance_id>
```

If a trigger condition occurs within the polling interval, the alert or alarm is not generated until the end of the polling interval.

Both traps can be enabled or suppressed through the Global Configuration mode **snmp trap** command.

Configuring Log Source Thresholds

There are three Global Configuration mode commands associated with configuring and implementing Log Source thresholds.

1. **threshold ls-logs-volume** – sets the parameters for the upper and lower thresholds for generating and clearing traps/alarms respectively.
2. **threshold poll ls-logs-volume interval** – establishes the polling interval for this threshold.
3. **threshold monitoring ls-logs-volume** – turns monitoring of this threshold on and off.

Use the following example to configure syslog servers:

configure

```
[ default ] threshold ls-logs-volume upper_percent [ clear lower_percent ]
[ default ] threshold poll ls-logs-volume interval duration
[ no ] threshold monitoring ls-logs-volume
end
```

Notes:

- *upper_percent* and *lower_percent* are expressed as integers from 0 to 100. Default value for *upper_percent* is 90%. If *lower_percent* is not specified, the default clear value is *upper_percent*.
- **threshold poll ls-logs-volume interval** sets the polling interval in seconds. The default interval is 300 seconds (5 minutes).

- **threshold monitoring ls-logs-volume** enables or disables this feature.

You can verify the configuration of this threshold by running the Exec mode **show threshold** command.

Save the configuration as described in the *Verifying and Saving Your Configuration* chapter.

Checkpointing Logs

Checkpointing identifies logged data as previously viewed or marked. Checkpointing allows you to only display log information since the last checkpoint.

Individual logs may have up to 50,000 events in the active log. Checkpointing the logs results in at most 50,000 events being in the inactive log files. This gives a maximum of 100,000 events in total which are available for each facility logged.

Checkpoint log data through the EXEC mode logs checkpoint command to set the log contents to a well-known point prior to special activities taking place. This command may also be a part of periodic regular maintenance to manage log data.

Checkpointing logs moves the current log data to the inactive logs. Only the most recently check pointed data is retained in the inactive logs. A subsequent check pointing of the logs results in the prior check pointed inactive log data being cleared and replaced with the newly check pointed data. Checkpointed log data is not available for viewing.



Important Checkpointing logs should be done periodically to prevent the log files becoming full. Logs which have 50,000 events logged discard the oldest events first as new events are logged.



Important An Inspector-level administrative user cannot execute this command.

Saving Log Files

Log files can be saved to a file in a local or remote location specified by a URL. Use the following EXEC mode command to save log files:

```
save logs { url } [ active ] [ inactive ] [ callid call_id ]
[event-verbosity evt_verbosity ] [ facility facility ] [level severity_level ]
[ pdu-data pdu_format ] [ pdu-verbosity pdu_verbosity ] [ since from_date_time
[ until to_date_time ] ] [ | { grep grep_options | more } ]
```

OPTIONS:

- **url**: Specifies the location to store the log file(s). *url* may refer to a local or a remote file and must be entered in the following format.
- **active**: Saves data from active logs.
- **inactive**: Saves data from inactive logs.

- **callid** *call_id*: Specifies a call ID for which log information is to be saved as a 4-byte hexadecimal number.
- **event-verbosity** *evt_verbosity*: Specifies the level of verbosity to use in the displaying of event data as one of:
 - *min*: Logs minimal information about the event. Information includes event name, facility, event ID, severity level, date, and time.
 - *concise*: Logs detailed information about the event, but does not provide the event source within the system.
 - *full*: Logs detailed information about event, including source information, identifying where within the system the event was generated.
- **facility** *facility*: Specifies the facility to modify the filtering of logged information.
- **level** *severity_level*: Specifies the level of information to be logged in the following list which is ordered from highest to lowest:
 - *critical*: Logs critical events
 - *error*: Logs error events and all events with a higher severity level
 - *warning*: Logs warning events and all events with a higher severity level
 - *unusual*: Logs unusual events and all events with a higher severity level
 - *info*: Logs info events and all events with a higher severity level
 - *trace*: Logs trace events and all events with a higher severity level
 - *debug*: Logs all events
- **pdu-data** *pdu_format*: Specifies output format for the display of packet data units as one of:
 - *none* - raw format (unformatted).
 - *hex* - hexadecimal format.
 - *hex-ascii* - hexadecimal and ASCII similar to a main-frame dump.
- **pdu-verbosity** *pdu_verbosity* : Specifies the level of verbosity to use in the displaying of packet data units as a value from 1 to 5, where 5 is the most detailed.
- **since** *from_date_time*: Saves only the log information which has been collected more recently than *from_date_time*
- **until** *to_date_time*: Saves no log information more recent than *to_date_time*. Defaults to current time when omitted.
- *from_date_time* and *to_date_time* must be formatted as YYYY:MM:DD:HH:mm or YYYY:MM:DD:HH:mm:ss. Where:
 - YYYY = 4-digit year
 - MM = 2-digit month in the range 01 through 12
 - DD = 2-digit day in the range 01 through 31

- HH = 2-digit hour in the range 00 through 23
- mm = 2-digit minute in the range 00 through 59
- ss = 2 digit second in the range 00 through 59

to_date_time must be a time which is more recent than *from_date_time*.

Using the **until** keyword allows for a time range of log information; using only the **since** keyword will display all information up to the current time.

- **grep** *grep_options* | **more**: Pipes (sends) the output of this command to the specified command. You must specify a command to which the output of this command is sent.

Event ID Overview



Important The use of event IDs depends on the platform type and the licenses running on the platform.

Identification numbers (IDs) are used to reference events as they occur when logging is enabled on the system. As described previously, logs are collected on a per facility basis. Each facility possesses its own range of event IDs as indicated in the following table.

Table 104: System Facilities and Event ID Ranges

Facility	Description	Event ID Range
a10	A10 Protocol Facility	28000-28999
a11	A11 Protocol Facility	29000-29999
a11mgr	A11 Manager Facility	9000-9999
aaa-client	AAA Client Facility	6000-6999
aaaMgr	AAA Manager Facility	36000-36999
aaaproxy	AAA Proxy Facility	64000-64999
aal2	AAL2 Protocol Facility	173200-173299
acl-log	IP Access Control List (ACL) Facility	21000-21999
acsctrl	Active Charging Service Controller (ACSCtrl) Facility	90000-90999
acsmgr	Active Charging Service Manager (ACSMgr) Facility	91000-91999
afctrl	Ares Fabric Controller (ASR 5500 only)	186000-186999
afmgr	Ares Fabric Manager (ASR 5500 only)	187000-187999
alarmctrl	Alarm Controller Facility	65000-65999
alcap	Access Link Control Application Part (ALCAP) Protocol Facility	160900-161399
alcapmgr	ALCAP Manager Facility	160500-160899

Facility	Description	Event ID Range
asf	ASF Facility	73000-73999
asfprt	ASFPRT Facility	59000-59999
asngwmgr	Access Service Network (ASN) Gateway Manager Facility	100000-100499
asnpcmgr	ASN Paging/Location-Registry Manager Facility	100500-100999
bcmcs	Broadcast/Multicast Service (BCMCS) Facility	109000-109999
bfd	Bidirectional Forwarding Detection (BFD) Protocol Facility	170500-170999
bgp	Border Gateway Protocol (BGP) Facility	85000-85999
bindmux	BindMux Manager Facility [Intelligent Policy Control Function (IPCF)]	158200-158999
bngmgr	Broadband Network Gateway (BNG) Manager Facility	182000-182999
bssap	Base Station System Application Part+ (BSSAP+) Service Facilities	131000-131199
bssgp	Base Station System GPRS Protocol (BSSGP) Facility	115050-115099
callhome	Call Home Facility	173600-173999
cap	CAMEL Application Part (CAP) Facility	87900-88099
chatconf	CHATCONF Facility	74000-74999
cli	Command Line Interface (CLI) Facility	30000-30999
connproxy	Connection Proxy Facility	190000-190999
crdt-ctl	Credit Control Facility	127000-127999
csg	Closed Subscriber Groups (CSG) Facility	188000-188999
csg-acl	CSG Access Control List (ACL) Facility	189000-189999
csp	Card/Slot/Port (CSP) Facility	7000-7999
css	Content Steering Service (CSS) Facility [ESC]	77000-77499
css-sig	Content Service Selection (CSS) RADIUS Signaling Facility	77500-77599
cx-diameter	Cx Diameter Message Facility	92840-92849
dcardctrl	Daughter Card Controller Facility	62000-62999
dcardmgr	Daughter Card Manager Facility	57000-57999
demuxmgr	Demux Manager Facility	110000-110999
dgmbmgr	Diameter Gmb (DGMB) Application Manager Facility	126000-126999
dhcp	DHCP Facility	53000-53999
dhcpv6	DHCPv6 Protocol Facility	123000-123999
dhost	Distributed Host Manager Facility	83000-83999
diameter	Diameter Endpoint Facility	92000-92599
diabase	Diabase Message Facility	92800-92809

Facility	Description	Event ID Range
diameter-acct	Diameter Accounting Protocol Facility	112000-112999
diameter-auth	Diameter Authentication Protocol Facility	111000-111999
diameter-dns	Diameter DNS Subsystem Facility	92600-92699
diameter-ecs	ECS Diameter Signaling Facility	81990-81999
diameter-hdd	Diameter Horizontal Directional Drilling (HDD) Interface Facility	92700-92799
diameter-svc	Diameter Service Facility	121200-121999
diamproxy	Diameter Proxy Facility	119000-119999
dpath	Data Path for IPSec Facility	54000-54999
drvctrl	Driver Controller Facility	39000-39999
ds3mgr	DS3 and DS3/E Line Card Manager Facility (part of NPU Manager Controller Facility)	40000-40999
eap-diameter	Extensible Authentication Protocol (EAP) Diameter Facility	92870-92879
eap-ipsec	EAP IPSec Facility	118000-118999
ecs-css	ACS Session Manager (ACSMgr) Signalling Interface Facility	97000-97099
edr	Event Data Record (EDR) Facility	80000-80999
egtpc	eGTP-C Facility	141000-141999
egtpmgr	eGTP Manager Facility	143000-143999
egtpu	eGTP-U Facility	142000-142999
epdg	Evolved Packet Data Gateway (ePDG) Facility	178000-178999
evlog	Event Log Facility	2000-2999
famgr	Foreign Agent (FA) Manager Facility	33000-33999
firewall	Firewall Facility	96000-96999
fng	Femto Network Gateway (FNG) Facility	149000-149999
gbrmgr	Gb-Manager Facility	201900-202699
gcdr	GGSN-Charging Data Record (G-CDR) Facility	66000-66999
gmm	GPRS Mobility Management (GMM) Facility	88100-88299
gprs-app	General Packet Radio Service (GPRS) Application Facility	115100-115399
gprs-ns	GPRS-NS Protocol Facility	115000-115049
gq-rx-tx-diameter	Gq/Rx/Tx Diameter Messages Facility	92830-92839
gss-gcdr	GTPP Storage Server GCDR Facility	98000-98099
gtpc	GTPC Protocol Facility	47000-47999
gtpcmgr	GTPC Signaling Demultiplexer Manager Facility	46000-46999
gtp	GTP-PRIME Protocol Facility	52000-52999

Facility	Description	Event ID Range
gtpu	GTPU Protocol Facility	45000-45999
gtpmgr	GTPU Manager Facility	157200-157999
gx-ty-diameter	Gx/Ty Diameter Messages Facility	92820-92829
gy-diameter	Gy Diameter Messages Facility	92810-92819
h248prt	H.248 Protocol Facility	42000-42999
hamgr	Home Agent (HA) Manager Facility	34000-34999
hat	High Availability Task (HAT) Facility	3000-3999
hdctrl	Hard Disk (HD) Controller Facility	132000-132999
hddshare	HDD Share Facility	184000-184999
henb-gw	Home eNodeB-GW Facility	195000-195999
henbapp	Home eNodeB Application Facility	196000-196999
henbgwdemux	Home eNodeB-GW Demux Facility	194000-194999
henbgwmgr	Home eNodeB-GW Manager Facility	193000, 193999
hnb-gw	Home NodeB (HNB) Gateway Facility	151000-151999
hnbmgr	HNB Manager Facility	158000-158199
hss-peer-service	Home Subscriber Server (HSS) Facility [MME]	138000-138999
igmp	Internet Group Management Protocol (IGMP) Facility	113000-113999
ikev2	IKEv2 Facility	122000-122999
ims-authorization	IMS Authorization Service Library Facility	98100-98999
ims-sh	IMS SH Library Facility	124000-124999
imsimgr	International Mobile Subscriber Identity (IMSI) Manager Facility	114000-114999
imsue	IMS User Equipment (IMSUE) Facility	144000-145999
ip-arp	IP Address Resolution Protocol (ARP) Facility	19000-19999
ip-interface	IP Interface Facility	18000-18999
ip-route	IP Route Facility	20000-20999
ipms	Intelligent Packet Monitoring System (IPMS) Facility	134000-134999
ipne	IP Network Enabler (IPNE) Facility	192000-192999
ipsec	IPSec Protocol Facility	55000-56998
ipsg	IP Services Gateway (IPSG) Facility	128000-128999
ipsgmgr	IPSG Manager (IPSGMgr) Facility	99000-99999
ipsp	IP Pool Sharing Protocol (IPSP) Facility	68000-68999
kvstore	Key/Value Store (KVSTORE) Facility	125000-125999

Facility	Description	Event ID Range
l2tp-control	L2TP Control PDU Protocol Facility	50000-50999
l2tp-data	L2TP Data PDU Protocol Facility	49000-49999
l2tpdemux	L2TP Demux Facility	63000-63999
l2tpmgr	L2TP Manager Facility	48000-48999
lagmgr	Link Aggregation Group (LAG) Manager Facility	179000-179999
ldap	Lightweight Directory Access Protocol (LDAP) Request Facility	160000-160499
li	Lawful Intercept (LI) Log Facility	69000-69999
linkmgr	Link Manager Facility	89500-89999
llc	Logical Link-Control (LLC) Layer Facility (GPRS)	115700-115799
local-policy	Local Policy Configuration Facility	161400-162399
m3ap	M3 Application Protocol (M3AP) Facility	211500-211999
m3ua	MTP Level 3 (M3UA) Protocol Facility [SIGTRAN]	87500-87699
magmgr	Mobile Access Gateway (MAG) Manager Facility	137500-137999
map	Mobile Application Part (MAP) Protocol Facility [SS7]	87100-87299
megadiammgr	MegaDiameter Manager Facility	121000-121199
mme-app	Mobility Management Entity (MME) Application Facility	147000-147999
mme-embms	MME evolved Multimedia Broadcast Multicast Service (eMBMS) Facility	212000-212499
mme-misc	MME Miscellaneous Facility	155800-156199
mmedemux	MME Demux Manager Facility	154000-154999
mmemgr	MME Manager Facility	137000-137499
mmgr	Master Manager (MMGR) Facility	86000-86399
mobile-ip	Mobile IP (MIP) Protocol Facility	26000-26999
mobile-ip-data	MIP Tunneled Data Facility	27000-27999
mobile-ipv6	Mobile IPv6 Facility	129000-129999
mpls	Multiprotocol Label Switching (MPLS) Facility	163500-163999
mseg-app	Mobile Services Edge Gateway (MSEG) Application Facility Not supported in this release.	172300-172999
mseg-gtpc	MSEG GTPC Application Facility Not supported in this release.	172000-172199
mseg-gtpu	MSEG GTPU Application Facility Not supported in this release.	172200-172299

Facility	Description	Event ID Range
msegmgr	MSEG Manager Facility Not supported in this release.	171000-171999
mtp2	Message Transfer Part 2 (MTP2) Service Facility [SS7]	116900-116999
mtp3	Message Transfer Part 3 (MTP3) Service Facility [SS7]	115600-115699
multicast-proxy	Multicast Proxy Facility	94000-94999
nas	Network Access Signaling (NAS) Facility	153000-153999
netwstrg	Network Storage Facility	78000-78999
npuctrl	Network Processing Unit (NPU) Control Facility	16000-16999
npudrv	NPU Driver Facility	191000-191999
npumgr	NPU Manager (NPUMGR) Facility	17000-17999
npumgr-acl	NPUMGR ACL Facility	169000-169999
npumgr-drv	NPUMGR Driver Facility	185000-185999
npumgr-flow	NPUMGR Flow Facility	167000-167999
npumgr-fwd	NPUMGR Forwarding Facility	168000-168999
npumgr-init	NPUMGR Initialization Facility	164000-164999
npumgr-lc	NPUMGR LC Facility	180000-180999
npumgr-port	NPUMGR Port Facility	166000-166999
npumgr-recovery	NPUMGR Recovery Facility	165000-165999
npumgr-vpn	NPUMGR VPN Facility	181000-181999
npusim	NPUSIM Facility	176000-176999
ntfy-intf	Event Notification Interface Facility	170000-170499
orbs	Object Request Broker (ORB) System Facility	15000-15999
ospf	Open Shortest Path First (OSPF) Protocol Facility	38000-38999
ospfv3	OSPFv3 Protocol Facility [IPv6]	150000-150999
p2p	Peer-to-Peer (P2P) Facility	146000-146999
pccmgr	Policy Charging and Control (PCC) Manager Facility	159000-159499
pdg	Packet Data Gateway (PDG) Facility	152010-152999
pdgdmgr	PDG TCP Demux Manager (pdgdmgr) Facility (this is a customer-specific facility)	162400-162999
pdif	Packet Data Interworking Function (PDIF) Facility	120000-120999
pgw	Packet Data Network Gateway (PGW) Facility	139000-139999
pmm-app	Packet Mobility Management (PMM) Application Facility [SGSN]	89200-89499

Facility	Description	Event ID Range
ppp	Point-To-Point Protocol (PPP) Facility	25000-25999
pppoe	Point-to-Point Protocol over Ethernet (PPPoE) Facility	183000-183999
ptt	PTT Facility	76000-76999
push	PUSH (VPNMgr CDR Push) Facility	133000-133999
radius-acct	RADIUS Accounting Protocol Facility	24000-24999
radius-auth	RADIUS Authentication Protocol Facility	23000-23999
radius-coa	RADIUS Change of Authorization (CoA) and Disconnect Facility	70000-70999
ranap	Radio Access Network Application Part (RANAP) Facility	87700-87899
rct	Recovery Control Task (RCT) Facility	13000-13999
rdt	Redirector Task (RDT) Facility	67000-67999
resmgr	Resource Manager (RM) Facility	14000-14999
rf-diameter	Rf Diameter Messages Facility	92860-92869
rip	Routing Information Protocol (RIP) Facility	35000-35999
rohc	Robust Header Compression (ROHC) Protocol Facility	103000-103999
rsvp	RSVP Protocol Facility	93000-93999
rua	RANAP User Adaptation (RUA) Protocol Facility	152000-152009
s1ap	S1 Application Protocol (SIAP) Facility	155200-155799
saegw	System Architecture Evolution Gateway Facility	191000-191999
sccp	Signalling Connection Control Part (SCCP) Protocol Facility [SS7]	86700-86899
set	Shared Configuration Task (SCT) Facility	32000-32099
sctp	Stream Control Transmission Protocol (SCTP) Protocol Facility	87300-87499
sess-gr	SESS-GR Facility	77600-77999
sessctrl	Session Controller Facility	8000-8999
sessmgr	Session Manager Facility	10000-12999
sesstrc	Session Trace Facility	155000-155199
sft	Switch Fabric Task (SFT) Facility	58000-58999
sgs	SGs Interface Protocol Facility [MME]	173000-173199
sgsn-app	SGSN Application Interface Facility	115900-115999
sgsn-failures	SGSN Call Failures Facility	89100-89199
sgsn-gtpc	SGSN GTP-C Protocol Facility	116000-116599
sgsn-gtpu	SGSN GTP-U Protocol Facility	86900-87099
sgsn-mbms-bearer	SGSN MBMS Bearer Application (SMGR) Facility	116600-116799

Facility	Description	Event ID Range
sgsn-misc	SGSN Miscellaneous Facility	88800-89099
sgsn-system	SGSN System Components Facility	86400-86499
sgsn-test	SGSN Tests Facility	88700-88799
sgsn2	SGSN2 Facility	114000-117999
sgtpcmgr	SGSN GTP-C (SGTPC) Manager Facility	117000-117999
sgw	Serving Gateway (SGW) Facility	140000-140999
sh-diameter	Sh Diameter Messages Facility	92850-92859
sipcdprt	SIPCDPRT Facility	95000-95999
sitmain	System Initiation Task (SIT) Main Facility	4000-4999
sm-app	Short Message Service (SMS) Facility	88300-88499
sms	SMS Service Facility	116800-116899
sndcp	Sub Network Dependent Convergence Protocol (SNDCP) Facility	115800-115899
snmp	Simple Network Management Protocol (SNMP) Facility	22000-22999
sprmgr	Subscriber Policy Register (SPR) Manager Facility	159500-159999
srdp	Static Rating Database Facility	102000-102999
srp	Service Redundancy Protocol (SRP) Facility	84000-84999
sscfnni	SSCFNNI Protocol Facility [ATM]	115500-115599
sscop	SSCOP Protocol Facility [ATM]	115400-115499
ssh-ipsec	SSH IP Security Facility	56999-56999
ssl	SSL Facility (this is a customer-specific facility)	156200-157199
stat	Statistics Facility	31000-31999
system	System Facility	1000-1999
tacacs+	TACACS+ Protocol Facility	37000-37999
taclcp	TACLCP Facility	44000-44999
tcap	Transaction Capabilities Application Part (TCAP) Protocol Logging Facility [SS7]	86500-86699
testctrl	Test Controller Facility	174000-174999
testmgr	Test Manager Facility	175000-175999
threshold	Threshold Facility	61000-61999
ttg	Tunnel Termination Gateway (TTG) Facility	130000-130999
tucl	TCP/UDP Convergence Layer (TUCL) Facility [SS7]	88500-88699
udr	User Data Record (UDR) Facility	79000-79999
user-data	User-Data Facility	51000-51999

Facility	Description	Event ID Range
user-l3tunnel	User L3 Tunnel Facility	75000-75999
usertcp-stack	User TCP Stack Facility	173300-173499
vim	Voice Instant Message (VIM) Facility	60000, 60999
vinfo	VINFO Facility	82000, 82999
vmgctrl	Virtual Media Gateway (VMG) Controller Facility	41000, 41999
vmgctxmgr	VMG Context Manager Facility	43000, 43999
vpn	Virtual Private Network (VPN) Facility	5000-5999
wimax-data	WiMAX DATA Facility	104900-104999
wimax-r6	WiMAX R6 Protocol (Signaling) Facility	104000-104899

Event Severities

The system provides the flexibility to configure the level of information that is displayed when logging is enabled. The following levels are supported:

- **critical:** Logs only those events indicating a serious error has occurred that is causing the system or a system component to cease functioning. This is the highest severity level.
- **error:** Logs events that indicate an error has occurred that is causing the system or a system component to operate in a degraded state. This level also logs events with a higher severity level.
- **warning:** Logs events that may indicate a potential problem. This level also logs events with a higher severity level.
- **unusual:** Logs events that are very unusual and may need to be investigated. This level also logs events with a higher severity level.
- **info:** Logs informational events and events with a higher severity level.
- **trace:** Logs events useful for tracing and events with a higher severity level.
- **debug:** Logs all events regardless of the severity.

Each of the above levels correspond to the "severity" level of the event ID. Therefore, only those event IDs with a "severity" level equal to the logging level are displayed.

Understanding Event ID Information in Logged Output

This section explains the event information that is displayed when logging is enabled.

The following displays a sample output for an event that was logged.

```
2011-Dec-11+5:18:41.993 [cli 30005 info] [8/0/609 cli:8000609 _commands_cli.c:1290] [software
internal system] CLI session ended for Security Administrator admin on device /dev/pts/2
```

The following table describes the elements of contained in the sample output.

Table 105: Event Element Descriptions

Element	Description
2011-Dec-11+5:18:41.993	Date/Timestamp indicating when the event was generated
[cli 30005 info]	Information about the event including: <ul style="list-style-type: none">• The facility the event belongs to• The event ID• The event's severity level In this example, the event belongs to the CLI facility, has an ID of 3005, and a severity level of "info".
[8/0/609 cli:8000609 _commands_cli.c:1290]	Information about the specific CLI instance.
[software internal system]	Indicates that the event was generated because of system operation.
CLI session ended for Security Administrator admin on device /dev/pts/2	The event's details. Event details may, or may not include variables that are specific to the occurrence of the event.



CHAPTER 48

UPF Ingress Interfaces

- [Feature Summary and Revision History, on page 475](#)
- [Feature Description, on page 476](#)
- [UPF Ingress Interface Type Configuration, on page 476](#)
- [Multiple GTPU IP Addresses Support, on page 482](#)

Feature Summary and Revision History

Summary Data

Table 106: Summary Data

Applicable Product(s) or Functional Area	5G-UPF
Applicable Platform(s)	VPC-SI SMI
Feature Default Setting	Disabled – Configuration Required
Related Changes in this Release	Not Applicable
Related Documentation	<i>UCC 5G UPF Configuration and Administration Guide</i>

Revision History

Table 107: Revision History

Revision Details	Release
Added support for binding multiple GTPU IP addresses to ensure even distribution of traffic across the VPP worker threads on UPF.	2023.04.0

Revision Details	Release
Added support for IP separation per interface to allow separate networks for N3 and N9 interfaces.	2023.03.0 2023.02.0
First introduced.	2020.02.0

Feature Description

UPF supports GTP-U ingress interfaces to initiate the user plane service. The UPF supports different GTP-U ingress interfaces to allow a separate network for N3 interface and N9, S5u, and S8u interfaces. The N9, S5u, and S8u interfaces share the same public IP.

The supported GTP-U ingress interfaces include:

- **N3**: N3 is the interface between gNodeB and UPF.
- **N9**: The N9 interface connects two UPFs. It is the interface between intermediate I-UPF and UPF session anchor connecting different PLMN.
- **S5u**: S5u is the interface between SGW-U and PGW-U in the 4G.
- **S8u**: S8u is an inter-PLMN variant of the S5u interface.

The user plane service associates with the GTP-U service using the **associate gtpu-service** CLI command in User Plane Service configuration mode. To enable the **upf-ingress** command, you must configure the **require upf** command on the UPF. You need the UPF license to enable the **require upf** command.



Note UPF does not support multiple GTP-U service selections for a single call.

UPF Ingress Interface Type Configuration

Configuring UPF Ingress Interface Type

To configure the UPF ingress interface type, use the following configuration:

To enable the **upf-ingress** command, you must configure the **require upf** command on the UPF. You need the UPF license to enable the **require upf** command.

```

configure
  context context_name
    user-plane-service service_name
      [ no ] associate gtpu-service gtpu_service_name upf-ingress
  interface-type [ n9 | s5u | s8u | n3 | n9-s5u-s8u ]
  end

```

NOTES:

- **associate gtpu-service** *gtpu_service_name*: Associate the GTP-U service with the user plane service.
- **upf-ingress**: Configure the interface type as UPF ingress.
- **interface-type** [**n9** | **s5u** | **s8u** | **n3** | **n9-s5u-s8u**]: Configure the desired GTP-U ingress interface type.
- If the N3 GTP-U ingress service is not present, UPF uses the default interface.
- If the configuration for N9, S5u, or S8u interfaces is not present, UPF performs the following actions:
 - UPF looks to use the N9 interface first followed by the S5u and S8u interfaces.
 - If there is no GTP-U service, UPF uses the default interface.

Configuration Example

The following is an example configuration:

```
associate gtpu-service n3-ingress upf-ingress
associate gtpu-service n3-ingress upf-ingress interface-type n3
associate gtpu-service n9-ingress upf-ingress interface-type n9
associate gtpu-service s5-ingress upf-ingress interface-type s5
associate gtpu-service s8-ingress upf-ingress interface-type s8
```

Configuring Echo Response for N9 Interface

The echo response in a GTP-U service provides the availability of peer UPF.

The following is a sample echo response configuration for the N9 interface in hUPF:

```
gtpu-service n9-ingress
  echo-interval 60
  echo-retransmission-timeout 1
  bind ipv4-address 60.60.41.5 bearer-type all
  exit
```

The following is a sample echo response configuration for the N9 interface in vUPF:

```
gtpu-service n9-egress
  echo-interval 60
  echo-retransmission-timeout 1
  bind ipv4-address 60.60.42.5 bearer-type all
  exit
```

Separating N3 and N9 BGP Routes

The following is a sample configuration to separate the N3 and N9 BGP routes for hUPF.

```
config
context SAEGW
  ip vrf mpls-vrf-1
  #exit
  ip vrf mpls-vrf-2
  #exit
  mpls bgp forwarding
  bfd-protocol
  #exit
  ip prefix-list name up seq 15 permit 50.50.17.4/32
  ip prefix-list name up seq 20 permit 50.50.17.5/32
```

```

ip prefix-list name up seq 25 permit 50.50.17.6/32
ip prefix-list name up seq 40 permit 50.50.17.7/32
ip prefix-list name n9-up1 seq 50 permit 60.60.17.5/32
ip prefix-list name n9-up1 seq 55 permit 60.60.17.6/32
route-map up_routes1 permit 10
  match ip address prefix-list n9-up1
#exit
route-map up_routes permit 10
  match ip address prefix-list up
#exit
router bgp 61435
  maximum-paths ebgp 4
  neighbor 20.14.35.100 remote-as 65000
  neighbor 20.14.35.100 ebgp-multihop
  neighbor 20.14.35.100 update-source 20.14.35.98
  neighbor 2001:4888:121:1435::1 remote-as 65000
  neighbor 2001:4888:121:1435::1 ebgp-multihop
  neighbor 2001:4888:121:1435::1 update-source 2001:4888:121:1435::2
  neighbor 20.14.40.100 remote-as 65000
  neighbor 20.14.40.100 ebgp-multihop
  neighbor 20.14.40.100 update-source 20.14.40.98
  address-family ipv4
    neighbor 20.14.35.100 max-prefix 8192 threshold 50
    neighbor 20.14.35.100 route-map up_routes out
    neighbor 20.14.35.100 send-community extended
    neighbor 20.14.40.100 max-prefix 8192
    neighbor 20.14.40.100 route-map up_routes1 out
    neighbor 20.14.40.100 send-community extended
    redistribute connected
    redistribute static
  #exit
  address-family ipv6
    neighbor 2001:4888:121:1435::1 activate
    redistribute connected
    redistribute static
  #exit
#exit
interface SxC loopback
  ip address 50.50.17.4 255.255.255.255
#exit
interface SxC-ipv6 loopback
  ipv6 address 2001:4888:50:50::17/128
#exit
interface gn-1
  ip address 20.14.35.98 255.255.255.0
  ipv6 address 2001:4888:121:1435::2/64 secondary
#exit
interface gn-2
  ip address 20.14.36.98 255.255.255.0
  ipv6 address 2001:4888:121:1436::2/64 secondary
#exit
interface gn-n9-ingress
  ip address 20.14.40.98 255.255.255.0
#exit
interface n9-ingress-hupf loopback
  ip address 60.60.17.5 255.255.255.255
#exit
interface pgw-gtpu loopback
  ip address 50.50.17.5 255.255.255.255
#exit
interface sgw-gtpu-egress loopback
  ip address 50.50.17.6 255.255.255.255
#exit
interface sgw-gtpu-ingress-phazr loopback

```

```

    ip address 60.60.17.6 255.255.255.255
#exit
subscriber default
exit
aaa group default
#exit
gtpg group default
    gtpg limit-secondary-rat-usage 32
#exit
gtpu-service SxC
    echo-interval 60
    echo-retransmission-timeout 1
    bind ipv4-address 50.50.17.4 ipv6-address 2001:4888:50:50::17 bearer-type all
exit
gtpu-service n9-ingress
    bind ipv4-address 60.60.17.5 bearer-type all
exit
gtpu-service pgw-gtpu
    bind ipv4-address 50.50.17.5 bearer-type all
exit
gtpu-service sgw-gtpu-egress
    bind ipv4-address 50.50.17.6 bearer-type all
exit
gtpu-service sgw-gtpu-ingress-phazr
    echo-interval 60
    echo-retransmission-timeout 1
    bind ipv4-address 60.60.17.6 bearer-type all
exit
sx-service sx-svc
    instance-type userplane
    bind ipv4-address 50.50.17.4 ipv6-address 2001:4888:50:50::17
    sxa max-retransmissions 5
    sxa retransmission-timeout-ms 1000
    sxb max-retransmissions 5
    sxb retransmission-timeout-ms 1000
    sxab max-retransmissions 5
    sxab retransmission-timeout-ms 1000
    sx-protocol heartbeat retransmission-timeout 15
    sx-protocol heartbeat max-retransmissions 3
    sx-protocol association debug-mode debug-reattempt-timeout 1
    no sx-protocol compression
exit
user-plane-service user_plane_svc
    associate gtpu-service pgw-gtpu upf-ingress
    associate gtpu-service n9-ingress upf-ingress interface-type n9
    associate gtpu-service sgw-gtpu-ingress-phazr sgw-ingress
    associate gtpu-service sgw-gtpu-egress sgw-egress
    associate gtpu-service SxC cp-tunnel
    associate sx-service sx-svc
    associate fast-path service
    associate control-plane-group SAEGW
    associate userplane-load-control-profile LCP
    associate userplane-overload-control-profile OLCP
exit

```

The following is a sample configuration to separate the N3 and N9 BGP routes for vUPF.

```

context SAEGW
    router bgp 61441
        neighbor 20.14.41.100 remote-as 65000
        neighbor 20.14.41.100 ebgp-multihop
        neighbor 20.14.41.100 update-source 20.14.41.98
        neighbor 2001:4888:121:1441::1 remote-as 65000
        neighbor 2001:4888:121:1441::1 ebgp-multihop
        neighbor 2001:4888:121:1441::1 update-source 2001:4888:121:1441::2

```

```

address-family ipv4
  redistribute connected
  redistribute static
#exit
address-family ipv6
  neighbor 2001:4888:121:1441::1 activate
  redistribute connected
  redistribute static
#exit
#exit
interface SxC loopback
  ip address 50.50.18.4 255.255.255.255
#exit
interface SxC-ipv6 loopback
  ipv6 address 2001:4888:50:50::18/128
#exit
interface gn-1
  ip address 20.14.41.98 255.255.255.0
  ipv6 address 2001:4888:121:1441::2/64 secondary
#exit
interface gn-2
  ip address 20.14.42.98 255.255.255.0
  ipv6 address 2001:4888:121:1442::2/64 secondary
#exit
interface n9-egress loopback
  ip address 50.50.18.8 255.255.255.255
#exit
interface pgw-gtpu loopback
  ip address 50.50.18.5 255.255.255.255
#exit
interface pgw-gtpu-ipv6 loopback
  ipv6 address 2001:4888:50:50::18:5/128
#exit
interface sgw-gtpu-egress loopback
  ip address 50.50.18.6 255.255.255.255
#exit
interface sgw-gtpu-egress-ipv6 loopback
  ipv6 address 2001:4888:50:50::18:6/128
#exit
interface sgw-gtpu-ingress-phazr loopback
  ip address 50.50.18.7 255.255.255.255
#exit
interface sgw-gtpu-ingress-phazr-ipv6 loopback
  ipv6 address 2001:4888:50:50::18:7/128
#exit
subscriber default
exit
aaa group default
#exit
gtp group default
  gtp limit-secondary-rat-usage 32
#exit
gtpu-service SxC
  echo-interval 60
  echo-retransmission-timeout 1
  bind ipv4-address 50.50.18.4 ipv6-address 2001:4888:50:50::18 bearer-type all
exit
gtpu-service n9-egress
  bind ipv4-address 50.50.18.8 bearer-type all
exit
gtpu-service pgw-gtpu
  bind ipv4-address 50.50.18.5 ipv6-address 2001:4888:50:50::18:5 bearer-type all
exit
gtpu-service sgw-gtpu-egress

```

```

bind ipv4-address 50.50.18.6 ipv6-address 2001:4888:50:50::18:6 bearer-type all
exit
gtpu-service sgw-gtpu-ingress-phazr
  echo-interval 60
  echo-retransmission-timeout 1
  bind ipv4-address 50.50.18.7 ipv6-address 2001:4888:50:50::18:7 bearer-type all
exit
sx-service sx-svc
  instance-type userplane
  bind ipv4-address 50.50.18.4 ipv6-address 2001:4888:50:50::18
  sxa max-retransmissions 5
  sxa retransmission-timeout-ms 1000
  sxb max-retransmissions 5
  sxb retransmission-timeout-ms 1000
  sxab max-retransmissions 5
  sxab retransmission-timeout-ms 1000
  sx-protocol heartbeat retransmission-timeout 15
  sx-protocol heartbeat max-retransmissions 3
  sx-protocol association debug-mode debug-reattempt-timeout 1
  no sx-protocol compression
exit
user-plane-service user_plane_svc
  associate gtpu-service pgw-gtpu upf-ingress
  associate gtpu-service n9-egress upf-egress
  associate gtpu-service sgw-gtpu-ingress-phazr sgw-ingress
  associate gtpu-service sgw-gtpu-egress sgw-egress
  associate gtpu-service SxC cp-tunnel
  associate sx-service sx-svc
  associate fast-path service
  associate control-plane-group SAEGW
  associate userplane-load-control-profile LCP
  associate userplane-overload-control-profile OLCP
exit
ip route 0.0.0.0 0.0.0.0 20.14.41.100 gn-1
ip igmp profile default
#exit
#exit

```



Note For RCM UPF, add all the IP prefix-lists in day 0.5 configuration.

Verifying the UPF Ingress Interface Type Configuration

To verify the configuration, use the following command:

- [show user-plane-service all, on page 481](#)

show user-plane-service all

The **show user-plane-service all** command displays user-plane service information.

The following is a sample output of this command:

```

show user-plane-service all
Service name                : user-plane-service
Service-Id                  : 7
Context                      : EPC2-UP
Status                       : NOT STARTED
UPF Ingress GTPU Service    : sx-gtpu-service

```

```

UPF Ingress N3 Interface Type GTPU Service: n3-ingress
UPF Ingress N9 Interface Type GTPU Service: n9-ingress
UPF Ingress S5U Interface Type GTPU Service: s5u-ingress
UPF Ingress S8U Interface Type GTPU Service: s8u-ingress
UPF Egress GTPU Service           : Not defined
SGW Ingress GTPU Service          : SGW-Ingress
SGW Egress GTPU Service          : SGW-Egress
Control Plane Tunnel GTPU Service : control_gtpu
Sx Service                       : sxu
Control Plane Group              : g1
Fast-Path service                : Disabled

```

NOTES:

- The UPF configures only one of the interface types, **pgw-ingress** or **upf-ingress** in a single user plane service.

Multiple GTPU IP Addresses Support

Table 108: Feature History

Feature Name	Release Information	Feature Description
Binding Multiple GTPU IP Addresses	2023.04	UPF allows binding of multiple GTPU IP addresses to provide high uplink throughput in Private 5G deployments. UPF creates unique GTPU 3-tuple hash entries to ensure uniform distribution of ingress traffic on all VPP worker threads.

Feature Description

In the Private 5G networks, where the uplink traffic is more than the downlink traffic, the number of gNodeBs are limited. UPF achieves the optimal distribution of subscriber traffic using the Receive Side Scaling (RSS) concept. However, due to limited number of VPP worker threads on UPF, the ingress traffic does not get evenly distributed across them. It limits the UPF from optimally utilizing all the worker threads, and therefore impacts the subscriber's uplink throughput.

UPF allows utilizing the VPP worker threads in an optimal manner by creating the unique GTPU 3-tuple hash entries on the UPF's forwarding plane. It ensures an optimum distribution of ingress traffic on the N3 interface. It enables UPF to perform traffic processing to its maximum capacity ensuring high uplink throughput for Private 5G networks.

How it Works

The even distribution of ingress traffic across all the available worker threads on the UPF is ensured by creating the unique 3-tuple hash entries.

The GTPU header source IP is the gNodeB's N3 service egress IP, while the source port is the standard port in the absence of port randomization support on the gNodeB. With these two values being constants per gNodeB, the only variable that can be achieved in the GTPU header is the destination IP (N3 service ingress IP address).

The following points describe how the unique 3-tuple hash entries are created:

- GTPU addresses are assigned in FTEID in Sx Session Establish Response for a subscriber session in a round-robin manner. However, this round-robin mechanism is ensured only within the session manager.
- When a session manager is selected, the GTPU address in FTEID is allocated in a round-robin manner to all the sessions landing on the selected session manager.
- Deletion of IP address from the GTPU service or the interface does not cause the GTPU service to stop. The existing calls will be deleted. However, the uplink traffic of the subscriber to which the deleted IP address was assigned will not be received at UPF.
- If every IP address is configured under a separate interface, the interface must be configured as a loopback (multiple non-loopback interfaces cannot share the same subnet). If any interface goes down and comes alive again, the GTPU service does not stop as the interfaces are configured as loopback.
- Every address pair is one GTPU endpoint for a GTPU service. Every endpoint should belong to the same subnet.



Note

- For optimum performance, the number of GTPU bind addresses must be equal to the number of VPP worker threads.
- A maximum of 12 IP address pairs (either IPv4 or IPv6 or IPv4+IPv6) can be configured per GTPU service.

Limitations

This feature has the following known limitations::

- If the GTPU Echo is enabled and the first bind IP address is deleted, the Echo request from the remote peer will not reach the UPF causing the remote peer to detect path failure. The subsequent downlink traffic from the UPF for that subscriber results in an error indication received at UPF.

The GTPU services stop only if all the bind IP addresses are deleted. These IP addresses can be under single interface or separate interfaces.

- UPF does not allow to configure different IP address types to be configured per GTPU service i.e., IPv4 + IPv6 or IPv4 + IPv4/IPv6 combinations are not allowed. Only the combinations of IPv4 or IPv6 or IPv4+IPv6, are allowed to be configured.

Configuring Multiple Bind Addresses on N3 Interface

To configure multiple bind addresses on the N3 interface, use the following sample configuration:

```
config
  context context_name
    gtpu-service service_name
      bind { ipv4-address ipv4_address | ipv6-address ipv6_address [
bearer-type { non-ims-media | ims-media | all } ] }
    exit
```

NOTES:

- **bind { ipv4-address *ipv4_address* | ipv6-address *ipv6_address* }**—Bind the GTPU service to the IPv4 address or IPv6 address on the N3 interface.
- **[bearer-type { non-ims-media | ims-media | all }]**—Specify the type of bearer to be associated with the bind address. **bearer-type** allows three types of media traffic:
 - **non-ims-media**—Configure bind address for non-ims media only.
 - **ims-media**—Configure bind address for ims-media traffic only.
 - **all**—Configure bind address to handle all types of bearer traffic. This is the default behavior.



Note If GTPU echo is enabled in GTPU service, the Echo request will be started with the first bind address configured in GTPU service. The bind address configuration is stored in the sorted list. As a result, the GTPU echo starts with the numerically lowest bind IP address.

Configuration Example

The following is an example configuration for binding multiple GTPU IP addresses on the N3 interface:

```

config
context EPC2-UP
cups enable
interface uplane_interface
  ip address <ip_address 1> <subnet mask>
  ip address <ip_address 2> <subnet mask> secondary
  ip address <ip_address 3> <subnet mask> secondary
  ip address <ip_address 4> <subnet mask> secondary
  ip address <ip_address 5> <subnet mask> secondary
  ip address <ip_address 6> <subnet mask> secondary
  ip address <ip_address 7> <subnet mask> secondary
#exit
gtpu-service N3U-service
  bind ipv4-address <ip_address 1> bearer-type all
  bind ipv4-address <ip_address 2> bearer-type all
  bind ipv4-address <ip_address 3> bearer-type all
  bind ipv4-address <ip_address 4> bearer-type all
  bind ipv4-address <ip_address 5> bearer-type all
  bind ipv4-address <ip_address 6> bearer-type all
exit

```

Configuration Verification

To verify the configuration, use the following command:

show gtpu-service name N3U-service

The following is a sample output of this command:

```

show gtpu-service name N3U-service

Service name:          N3U-service
Context:              EPC2-UP
State:                Started
Echo Interval:        Disabled
Sequence number:      Disabled
Include UDP Port Ext Hdr: FALSE

```

```

Max-retransmissions:      4
Retransmission Timeout:  5 (secs)
IPSEC Tunnel Idle Timeout:60 (secs)
GTPU IP QOS DSCP value:10
Allow Error-Indication:  Disabled
Address List:
    <ip_address 1>      all
    <ip_address 2>      all
    <ip_address 3>      all
    <ip_address 4>      all
    <ip_address 5>      all
    <ip_address 6>      all
    <ip_address 7>      all
GTPU UDP Checksum: Enabled - Attempt Optimize Default Mode
Path Failure Detection
on gtp echo msgs:        Set
Path Failure Clear Trap : non-echo
GTPU Source-port Configuration : Use Standard Port
    GTPU Source-port Offset      : N/A
GTPU Peer Statistics Threshold : 16000
1

```

OAM Support

This section describes operations, administration, and maintenance support for this feature.

Monitoring Support

This section describes feature-level monitoring support information.

show user-plane-service gtpu local-addresses

This command displays the number of active bearers/sessions using specific bind address.

For Single Converged 4G Call:

```

show user-plane-service gtpu local-addresses
Service name:      N3U-service
Address List:
  <ip_address 1>      GTPv1 Sessions:
                        1
Service name:      SGW-Egress
Address List:
  <ip_address 2>      GTPv1 Sessions:
                        1
Service name:      SGW-Ingress
Address List:
  <ip_address 3>      GTPv1 Sessions:
                        1

```



Note

- In 4G calls, there will be one GTPU session per bearer.
- This CLI output will not display the total number of unique subscribers per GTPU address.

For 5G Call:

```

show user-plane-service gtpu local-addresses
Service name:      N3U-service
Address List:
  <ip_address 1>      GTPv1 Sessions:
                        1
Service name:      SGW-Egress

```

show user-plane-service gtpu statistics local-address

```

Address List:
No active sessions exists
Service name:          SGW-Ingress
Address List:
No active sessions exists
GTPv1 Sessions:
GTPv1 Sessions:

```

show user-plane-service gtpu statistics local-address

This command displays the statistics per GTPU bind address.

```
show user-plane-service gtpu statistics local-address < Local IPv4/IPv6 Address>
```

```

Session Stats:
  Current: 1
  Current (IMS-media): 0
  Total Setup: 2
  Total Setup (IMS-media): 0
  Current gtpu v0 sessions: 0
  Current gtpu v1 sessions: 2

Total Data Stats:
  Uplink Packets: 0 Uplink Bytes: 0
  Downlink Packets: 0 Downlink Bytes: 0
  Packets Discarded: 0 Bytes Discarded: 0
  Uplink Packets (IMS-media): 0 Uplink Bytes (IMS-media): 0
  Downlink Packets (IMS-media): 0 Downlink Bytes (IMS-media): 0
  Packets Discarded (IMS-media): 0 Bytes Discarded (IMS-media): 0

QoS Stats:

QCI 1:
  Uplink Packets: 0 Uplink Bytes: 0
  Downlink Packets: 0 Downlink Bytes: 0
  Packets Discarded: 0 Bytes Discarded: 0

QCI 2:
  Uplink Packets: 0 Uplink Bytes: 0
  Downlink Packets: 0 Downlink Bytes: 0
  Packets Discarded: 0 Bytes Discarded: 0

QCI 3:
  Uplink Packets: 0 Uplink Bytes: 0
  Downlink Packets: 0 Downlink Bytes: 0
  Packets Discarded: 0 Bytes Discarded: 0

QCI 4:
  Uplink Packets: 0 Uplink Bytes: 0
  Downlink Packets: 0 Downlink Bytes: 0
  Packets Discarded: 0 Bytes Discarded: 0

QCI 5:
  Uplink Packets: 0 Uplink Bytes: 0
  Downlink Packets: 0 Downlink Bytes: 0
  Packets Discarded: 0 Bytes Discarded: 0

QCI 6:
  Uplink Packets: 0 Uplink Bytes: 0
  Downlink Packets: 0 Downlink Bytes: 0
  Packets Discarded: 0 Bytes Discarded: 0

QCI 7:
  Uplink Packets: 0 Uplink Bytes: 0

```

```

Downlink Packets:          0 Downlink Bytes:          0
Packets Discarded:        0 Bytes Discarded:          0

QCI 8:
Uplink Packets:           0 Uplink Bytes:           0
Downlink Packets:         0 Downlink Bytes:         0
Packets Discarded:        0 Bytes Discarded:          0

QCI 9:
Uplink Packets:           0 Uplink Bytes:           0
Downlink Packets:         0 Downlink Bytes:         0
Packets Discarded:        0 Bytes Discarded:          0

QCI 65:
Uplink Packets:           0 Uplink Bytes:           0
Downlink Packets:         0 Downlink Bytes:         0
Packets Discarded:        0 Bytes Discarded:          0

QCI 66:
Uplink Packets:           0 Uplink Bytes:           0
Downlink Packets:         0 Downlink Bytes:         0
Packets Discarded:        0 Bytes Discarded:          0

QCI 69:
Uplink Packets:           0 Uplink Bytes:           0
Downlink Packets:         0 Downlink Bytes:         0
Packets Discarded:        0 Bytes Discarded:          0

QCI 70:
Uplink Packets:           0 Uplink Bytes:           0
Downlink Packets:         0 Downlink Bytes:         0
Packets Discarded:        0 Bytes Discarded:          0

QCI 80:
Uplink Packets:           0 Uplink Bytes:           0
Downlink Packets:         0 Downlink Bytes:         0
Packets Discarded:        0 Bytes Discarded:          0

QCI 82:
Uplink Packets:           0 Uplink Bytes:           0
Downlink Packets:         0 Downlink Bytes:         0
Packets Discarded:        0 Bytes Discarded:          0

QCI 83:
Uplink Packets:           0 Uplink Bytes:           0
Downlink Packets:         0 Downlink Bytes:         0
Packets Discarded:        0 Bytes Discarded:          0

Non-Std QCI (Non-GBR):
Uplink Packets:           0 Uplink Bytes:           0
Downlink Packets:         0 Downlink Bytes:           0
Packets Discarded:        0 Bytes Discarded:           0
Uplink Packets:           0 Uplink Bytes:           0
Downlink Packets:         0 Downlink Bytes:           0
Packets Discarded:        0 Bytes Discarded:           0

Total uplink packets GBR QCI's:          0
Total uplink Bytes GBR QCI's:            0
Total Downlink packets GBR QCI's:        0
Total Downlink Bytes GBR QCI's:          0
Total uplink packets Non-GBR QCI's:      0
Total uplink Bytes Non-GBR QCI's:        0
Total Downlink packets Non-GBR QCI's:    0
Total Downlink Bytes Non-GBR QCI's:      0

```

show npu utilization table

```

Path Management Messages:
  Echo Request Rx:          0 Echo Response Rx:          0
  Echo Request Tx:          0 Echo Response Tx:          0
  SuppExtnHdr Tx:          0 SuppExtnHdr Rx:          0

Peer Stats:
  Total GTPU Peers:          1
  Total GTPU Peers with Stats: 1

Tunnel Management Messages:
  Error Indication Tx:          0
  Error Indication Rx:          0
  Error Indication Rx Discarded: 0

```

show npu utilization table

This command displays the VPP worker thread CPU utilization:

```

[local]UPF1# show npu utilization table
-----vpp-----
 lcore   now   5min  15min
-----
01/0/01  15%  11%  12%
01/0/02  15%  13%  14%
01/0/03  23%  23%  24%
01/0/04  19%  21%  20%
01/0/05  22%  20%  20%
01/0/06  12%  11%  11%
01/0/07  16%  16%  16%
01/0/08  15%  17%  17%
01/0/09  11%  12%  12%

```



CHAPTER 49

UPF Local Configuration

This chapter covers the following topics:

- [Feature Summary and Revision History, on page 489](#)
- [Feature Description, on page 490](#)
- [Configuring the Local Configuration Support for UPF, on page 491](#)

Feature Summary and Revision History

Summary Data

Table 109: Summary Data

Applicable Product(s) or Functional Area	5G-UPF
Applicable Platform(s)	VPC-SI SMI
Feature Default Setting	Disabled – Configuration Required
Related Changes in this Release	Not Applicable
Related Documentation	Not Applicable

Revision History

Table 110: Revision History

Revision Details	Release
First Introduced.	2020.02.0

Feature Description

The support for processing static and predefined rules in Control and User Plane Separation of EPC nodes (CUPS) architecture is dependent on the ruledef, rulebase, and charging action. For processing L3/L4 static and predefined rules, this information is made available at the control-plane in CUPS architecture. The control plane sends all these information to the associated user-plane using the PFD management message. The UPF cannot use the PFD management message to work with CN-SNF. With this feature, the local configuration support for the User Plane Function (UPF) is enabled, which allows the UPF to work with CN-SNF.

How it Works

The Access Control System (ACS) command line interface (CLI) is configured on the user-plane and the CLI module sends it to the ACS Controller (ACSCtrl). The ACSCtrl verifies the CLI and sends it to the Session Controller (SessCtrl). The SessCtrl stores the configuration in the SCT.

The SessCtrl maintains and stores different configuration types in a skiplist. When the length of the skiplist reaches the maximum (BULK configuration length) for a particular configuration type, the entire list is pushed in BULK from the Sessctrl to the Session Manager (SessMgr). As a result, the number of messenger event/message transactions between proclcts is greatly reduced since the configurations are sent in BULK in a single message. On the expiry of the bulk configuration timeout (2 seconds), the Bulk Configuration timer – which runs constantly at the Session Controller – pushes the different types of configurations to the SessMgrs.

- The following configuration types are supported for the Bulk Configuration push:
 - Ruledef
 - Charging Action
 - Action Priority Lines
 - Group of Ruledef Configuration
 - Rule in Group of Ruledef Configuration
 - Rulebase L3/L4/L7 Info Configuration
 - APN Configuration
 - ACS service Configuration

The configurations are pushed only through the bulk push mechanism for configurations that are either added or modified. On the other hand, when configurations are deleted, it is removed immediately without waiting for any response from the Bulk configuration push timer. The deleted configuration is removed from the SCT and other SessMgrs immediately.



Note The Bulk configuration timeout function is invoked forcefully to push all the pending configurations to the SessMgrs before pushing the configuration delete to avoid any race conditions.

- The configuration changes applied to all the new and existing calls are listed in Table as follows.

Table 111: Configuration Changes on New and Existing Call Flows

Change in Configuration	Impact on Existing Calls Current Flows	Impact on Existing Calls New Flows	Impact on New Calls
Existing ruledef contents/New rule addition	Rule match is not enforced on existing flows after configuration change. TRM is not disengaged on existing flows. This may lead to billing issues if ruledef contents were changed for ongoing flows.	The configuration changes apply on new flows. For new flows, anyways fresh rule match would happen and the ruledef changes are applied on new flows for existing calls.	The configuration changes apply on new calls. For new flows, anyways fresh rule match would happen and the ruledef changes are applied on flows for new calls.
No Ruledef	Rule in use cannot be deleted.	Rule in use cannot be deleted	Rule in use cannot be deleted
New Group of Ruledefs/Changes to existing Group of Ruledefs contents (Add or Delete Rule in Group of Ruledefs)	Rule match is not enforced on existing flows after configuration change. TRM is not disengaged on existing flows. This may lead to billing issues if Group of Ruledefs contents were changed for ongoing flows.	The configuration changes apply on new flows. For new flows, anyways fresh rule match would happen and the Group of Ruledefs changes are applied on new flows for existing calls.	The configuration changes apply on new calls. For new flows, anyways fresh rule match happens and the Group of Ruledefs changes are applied on flows for new calls.
No Group of Ruledefs	Group of Ruledefs in use cannot be deleted	Group of Ruledefs in use cannot be deleted	Group of Ruledefs in use cannot be deleted
No Rule in GoR	Flows continue to match the ruledef defined in Group of Ruledefs unless the ruledef itself is deleted	New flows go through a fresh rule match and configuration change takes effect.	New flows go through a fresh rule match and configuration change takes effect.
Action Priority Changes/Action Priority addition	TRM is not disengaged for ongoing flows. configuration changes do not apply on existing flows	Configuration changes apply on new flows.	Configuration changes apply on new calls.
No Action Priority	No Impact on existing flows	Configuration changes apply on new flows.	Configuration changes apply on new calls.
Rulebase parameters change	Some parameter changes apply on existing calls	Some parameter changes apply on existing calls	Configuration changes apply on new calls
No Rulebase	No Rulebase is not supported	No Rulebase is not supported	No Rulebase is not supported
No APN	No APN is not supported	No APN is not supported	No APN is not supported
IP source violation	No impact on existing calls	No impact on existing calls	Configuration changes apply on new calls.

Configuring the Local Configuration Support for UPF

Use the following CLI commands to configure the User Plane Function (UPF) locally.

```
configure
  require upf
end
```



CHAPTER 50

UPF Reporting of Load Control Over N4 Interface

- [Feature Summary and Revision History, on page 493](#)
- [Feature Description, on page 493](#)
- [Configuring the Max Sessions, on page 495](#)

Feature Summary and Revision History

Summary Data

Applicable Product(s) or Functional Area	UPF
Applicable Platform(s)	VPC-SI SMI
Feature Default Setting	Disabled – Configuration Required
Related Changes in this Release	Not Applicable
Related Documentation	Not Applicable

Revision History

Revision Details	Release
First introduced.	2020.02.0

Feature Description

Load control enables the UPF to send its load information to the SMF in order to balance PFCP session load across the UPF according to their effective load. The load information reflects the operating status of the resources of the UPF. Load control allows for better balancing of the PFCP session load to prevent overload.

NOTE: Overload mitigation actions are not triggered even if the UPF reports high load.

Supported IE and Messages

To report Load Control Information (LCI) to the SMF, 3GPP specification has defined the following IEs:

- Load Control Information IE – The load control Information IE is as follows: It contains the sequence number IE and load metric IE. This IE is sent in Session Establishment Response, Session Modification Response, Session Deletion Response, and Session Report Request messages sent from UPF.
- Sequence Number IE – The Sequence Number IE contains an Unsigned32 binary integer value. The Load Control Sequence Number increases whenever the load control information changes.
- Load Metric IE – The Load Metric parameter indicates the current load level of the originating node. The computation of the Load Metric happens at the implementation basis. The node considers the various aspects, such as:
 - The used capacity of the UPF
 - The load in the node. For example, memory or CPU usage in relationship to the total memory or CPU available, and so on.

The Metric IE encoding is as follows: It indicates a percentage and takes binary coded integer values from and including 0 up to and including 100. Considers the other values as 0.

Reporting Load Information to SMF

The UPF sends its load control information to reflect the operating status of its resources at the node level. It allows the SMF to use this information to augment the UPF selection procedures. The load control information is piggybacked in PFCP request or response messages such that the exchange of load control information does not trigger extra signaling.

Considering the processing requirement of the receiver of the load control information, a larger variation in the Load Metric, example 5 or more units are reasonable value to send the new load control information.

The following criteria is used to send the Load Control Information IE:

- Whenever there is an increase or decrease in the load by 5% or more.
- At 95% or above, LCI is reported for any increase.
- At 5% or below, no LCI is reported.
- At 100%, LCI is reported in all messages.
- System timestamp is used as Sequence Number.

NOTES:

- Currently, only session-load is considered to calculate the Load Metric in the UPF.
- Multiple SessMgrs report the same value of Load Metric with the same sequence number.

Configuring the Max Sessions

Based on various deployment scenarios, if you do not want to load UPF to its maximum capacity in terms of the count of sessions, especially, given that in 5G a single user-session can go up to 5 Gbps. To alter the max session supported in UPF, a CLI command is available under the User Plane Service configuration. It allows the operator to configure the required number of max-sessions that are supported on the UPF so that the SMF can load balance the sessions across the UPF. The following is a sample configuration:

```
configure
  context context_name
    user-plane-service user_plane_service
      load-control capacity session_value
    end
```

NOTES:

- *session_value* must be an integer in the range of 1 through the maximum value that is allowed in the platform.
- The use of this configuration is only for the LCI reporting to SMF, and not for any other purpose, such as congestion control, and so on.

The following is an example configuration:

```
configure
  context ingress
    user-plane-service ups1
      load-control capacity 2500
    end
```

Show Command Support

The output of the show command to display the User Plane Service includes the value of configured max sessions.

show user-plane-service all

```
Service name           : user-plane-service
Service-Id             : 4
Context                : ingress
Status                 : STARTED
UPF Ingress GTPU Service : n3-gtpu-service
SGW Ingress GTPU Service : Not defined
SGW Egress GTPU Service : Not defined
Control Plane Tunnel GTPU Service : n4-gtpu-service
Sx Service              : n4-sx
Control Plane Group     : g1
Load Control Parameters
  Capacity               : 1000
```



CHAPTER 51

UPF Usage Monitoring over PCF

- [Feature Summary and Revision History, on page 497](#)
- [Feature Description, on page 498](#)

Feature Summary and Revision History

Summary Data

Table 112: Summary Data

Applicable Product(s) or Functional Area	5G-UPF
Applicable Platform(s)	VPC-SI SMI
Feature Default Setting	Enabled - Always-on
Related Changes in This Release:	Not Applicable
Related Documentation	<ul style="list-style-type: none">• <i>UCC 5G SMF Configuration and Administration Guide</i>• <i>UCC 5G UPF Configuration and Administration Guide</i>

Revision History

Revision Details	Release
First introduced.	2022.01.0

Feature Description

UPF supports usage monitoring control over the existing N4 interface to report usage thresholds that are provided from PCF over the N7 interface through SMF for both 4G and 5G sessions. UPF reports the usage threshold breach to SMF through Session Report Request and SMF sends the data to PCF. UPF supports the modification of usage monitoring parameters, such as Total Volume, Uplink Volume, or Downlink Volume thresholds and the disabling of usage monitoring based on non-reception of usage monitoring threshold or related triggers from PCF.

Usage Reporting

UPF measures the volume and the time usage of all traffic for the PDU session or the corresponding service data flows. UPF sends the accumulated usage report in either the PFCP Session Report Request or the PFCP Session Modification Response to SMF. SMF includes one or multiple accumulated usage reports in the "accuUsageReports" attribute towards PCF.



Note The *Usage Monitoring over PCF* feature is enabled from SMF.

NOTE: To know more about how SMF handles this functionality, refer to the *Usage Monitoring over PCF* section in the *Policy and User Plane Management* chapter of *UCC 5G SMF Configuration and Administration Guide*.



CHAPTER 52

Virtual Routing and Forwarding

- [Feature Summary and Revision History, on page 499](#)
- [Revision History, on page 499](#)
- [Feature Description, on page 499](#)
- [Configuring VRF, on page 502](#)
- [VLAN Segmentation Using VRF, on page 504](#)
- [Monitoring and Troubleshooting, on page 506](#)

Feature Summary and Revision History

Revision History

Table 113: Revision History

Revision Details	Release
UPF supports up to 200 VRFs for private APN/DNN.	2023.02.0
UPF supports up to 129 VRFs for private APN/DNN.	2022.04.0
Support is added for the following functionality: <ul style="list-style-type: none">• Overlapping IP Pools• Removal of mandatory VRF ordering between SMF and UPF	2021.01.0
First introduced.	2020.02.0

Feature Description

Virtual Routing and Forwarding (VRF) is a technology that allows multiple instances of a routing table to coexist within the same router at the same time. As the routing instances are independent, VRF uses the same or overlapping IP addresses without conflicting with each other.



Note In 2023.02.0 and later releases, UPF supports up to 200 VRFs for private APN or DNN. In releases prior to 2023.02.0, UPF supported up to 129 VRFs for private APN or DNN.

In UPF, this feature enables association of IP address pools with VRF. The chunks from this pool are allocated to the UPFs that are configured to use these pools. VRF-associated pools in UPF can be either Static or Private type.

When UPF comes up for registration, the chunks in the PRIVATE VRF pool are allocated similar to the normal private pools. For a Static VRF pool, SMF does chunk allocation to UPF during configuration. An Sx-Route-Update message is sent for pre-allocated static chunks during UPF registration.

Overlapping IP Pool

Overlapping pools share and use an IP address range. Overlapping pools can either be of Static or Private type. Public pools cannot be configured as overlapping pools. Each overlapping pool is part of a different VRF (routing domain) and pool-group. Since an APN can use only one pool-group, overlapping pools are part of different APNs.

Without this functionality, overlapping pools are configured at SMF. However, chunks from two overlapping pools cannot be sent to the same UPF. That is, the UPF cannot handle chunks from two different overlapping pools. Same number of UPFs and overlapping pools are required for sharing the same IP address range.

With this functionality, UPF handles chunks from two different overlapping pools. So, a single UPF can handle any number of overlapping pools sharing the same IP range.

The functionality of overlapping pools in the same UPF includes:

- When a chunk from a particular pool is installed on UPF, its corresponding vrf-name is sent along with the chunk.
- The UPFs are VRF-aware of the chunks and install chunks on the corresponding VRFs. The chunk database is populated under VRFs.
- During call allocation, release, recovery, or any communication toward VPNMgr, the corresponding SessMgr at UPF includes vrf-id. This enables VPNMgr to select the correct chunk for that IP under the provided vrf-id for processing.

UE IP VRF is a custom IE that encapsulates the VRF name of N4 SESSION ESTABLISHMENT REQUEST message.

UE IP VRF Information Element

The following is the IE format of the private UE IP VRF.

Table 114: UE IP VRF Format

	Bits							
Octets	8	7	6	5	4	3	2	1
1 to 2	Type = 242 (decimal)							
3 to 4	Length = n							

5	Spare	Identical VRF flag	IPv6 VRF Valid	IPv4 VRF Valid
m to m+1	VRF-1 Name Length = p			
m+1 to m+1+p	VRF-1 Name			
n to n+1	VRF-2 Name Length = q			
m+1 to m+1+q	VRF-2 Name			

The following table shows the possible values of the "UE IP VRF" fields.

Cases	UE IP VRF	Value (binary)		
		Bit 3	Bit 2	Bit 1
1	None of the IPv4 and IPv6 UE IP addresses are associated to VRF.	0	0	0
2	Only IPv4 UE IP address is associated to a VRF.	0	0	1
3	Only IPv6 UE IP address is associated to VRF.	0	1	0
4	Both IPv4 and IPv6 UE IP addresses are associated to different VRFs.	0	1	1
5	Both IPv4 and IPv6 UE IP addresses are associated to a common VRF.	1	1	1

VRF Name as Identifier

The communication between SMF and UPF, related to VRF, was done through vrf-id. This required the operator to have all VRFs configured in both SMF and UPF, and also in the same order.

With this feature, vrf-name is used as identifier in all the communication between SMF and UPF related to VRFs. This feature eliminates the configuration of all VRFs in UPF. Operator can configure VRFs in different order at SMF and UPF, and can identify the VRF with the same vrf-name in both the nodes.

Limitations and Restrictions

The following are the known limitations and restrictions in UPF:

- UPF supports only VRF-based overlapping pools. UPF does not support overlapping pools such as NH-based and VLAN-based pools.
- UPF does not permit PDN Type IPv4v6-based call on static IP pools with multiple UPFs in the same UPF group.
- UPF does not support dynamic update of VRF.

Configuring VRF

Use the following steps to configure VRF support in UPF.

At SMF:

1. Create the APN or DNN profile.
2. Create overlapping IP pools and associate the respective APN or DNN and VRF at context-level.
3. Associate APN or DNN to the UPF profile.

The following is an example of the SMF configuration:

```
profile dnn intershat1
.
.
.
    upf apn mpls1.com
exit
profile dnn intershat2
.
.
.
    upf apn mpls2.com
exit
profile network-element upf upf1
.
.
.
    dnn-list [ intershat1 intershat2 ]
exit
profile network-element upf upf2
.
.
.
    dnn-list [ intershat1 intershat2 ]
exit
ipam
source local
address-pool pool-intershat1
    vrf-name mpls-vrf-1@isp
    tags
        dnn intershat1
    exit
    ipv4
        address-range 209.165.201.25 255.255.255.224
    exit
exit
address-pool pool-intershat2
    vrf-name mpls-vrf-2@isp
    tags
        dnn intershat2
    exit
    ipv4
        address-range 209.165.201.25 255.255.255.224
    exit
exit
exit
```

At UPF:

It is recommended to configure VRF in UPF before a chunk is pushed from SMF. Else, it leads to failure of the complete IP pool transaction (including chunks that donot belong to the VRF). SMF retries the attempt after some time.

The following is an example of the UPF configurations:

UPF 1:

```

config
  context EPC2
    sx-service sx
      instance-type userplane
      bind ipv4-address 209.165.201.11 ipv6-address bbbb:aaaa::4
    exit
  user-plane-service up
    associate gtpu-service pgw-gtpu pgw-ingress
    associate gtpu-service sgw-ingress-gtpu sgw-ingress
    associate gtpu-service sgw-engress-gtpu sgw-egress
    associate gtpu-service saegw-sxu cp-tunnel
    associate sx-service sx
    associate fast-path service
    associate control-plane-group gl
  exit

context isp
  ip vrf mpls-vrf-1
  #exit
  ip vrf mpls-vrf-2
  #exit
  ip vrf mpls-vrf-1
    route-distinguisher 61601 11100001
    route-target export 61601 11100001
    route-target import 61606 11100001
    route-target import 65200 11100001
  #exit
  address-family ipv4 vrf mpls-vrf-1
    redistribute connected
    redistribute static
  #exit
  address-family ipv6 vrf mpls-vrf-1
    redistribute connected
    redistribute static
  #exit
  ip vrf mpls-vrf-2
    route-distinguisher 61601 11100002
    route-target export 61601 11100002
    route-target import 61606 11100002
    route-target import 65200 11100002
  #exit
  address-family ipv4 vrf mpls-vrf-2
    redistribute connected
    redistribute static
  #exit
  address-family ipv6 vrf mpls-vrf-2
    redistribute connected
    redistribute static
  #exit
  #exit
apn mpls1.com
  pdp-type ipv4 ipv6
  bearer-control-mode mixed
  selection-mode sent-by-ms
  ip context-name isp
  exit

```

```

exit
control-plane-group g1
  peer-node-id ipv4-address 209.165.201.15
#exit
  user-plane-group default

```

UPF 2:

```

config
  context EPC2
    sx-service sx
      instance-type userplane
      bind ipv4-address 209.165.201.12 ipv6-address bbbb:aaaa::5
    exit
    user-plane-service up
      associate gtpu-service pgw-gtpu pgw-ingress
      associate gtpu-service sgw-ingress-gtpu sgw-ingress
      associate gtpu-service sgw-engress-gtpu sgw-egress
      associate gtpu-service saegw-sxu cp-tunnel
      associate sx-service sx
      associate fast-path service
      associate control-plane-group g1
    exit
  exit

  context isp
    ip vrf mpls-vrf-1
    #exit
    ip vrf mpls-vrf-2
    #exit
    apn mpls2.com
    pdp-type ipv4 ipv6
    bearer-control-mode mixed
    selection-mode sent-by-ms
    ip context-name isp
  exit
exit

control-plane-group g1
  peer-node-id ipv4-address 209.165.201.15
#exit
  user-plane-group default

```

VLAN Segmentation Using VRF

Table 115: Feature History

Feature Name	Release Information	Description
Enabling VLAN Segmentation of Traffic Using Virtual Routing and Forwarding	2024.01	UPF allows VLAN segmentation using VRF. A VRF is configured for each VLAN and each VRF has a default route through which the uplink packets are sent. Default Setting: Disabled-Configuration required to enable.

Feature Description

UPF supports segmenting the enterprise traffic using Virtual LAN (VLAN). VLANs enable a single physical LAN segment to be further segmented into smaller virtual networks so that the groups of ports are isolated from one another, as if they were on physically different segments. In VLAN segmentation, the UEs belonging to different classes are assigned to different VLANs for traffic isolation.

VLAN Segmentation can be achieved using two methods:

1. [VLAN Segmentation Using Next Hop Forwarding](#)
2. Virtual Routing and Forwarding

UPF supports segmenting VLAN traffic by configuring VRF. It is a layer-3 virtualization that consists of configuring a VRF with a default route per VLAN. The VRF default route is used for sending packets.

VLAN segmentation is enabled by logically mapping the VLAN tags with the IP pools at the SMF. The UPF is informed about the mapping configuration based on which UPF forwards the uplink packets on the N6 interface through the default route configured for a VRF.

Enabling VLAN Segmentation Using VRF

To enable VLAN segmentation using VRF on UPF, use following configuration:

```
config
  port ethernet slot/port
  no shutdown
  vlan vlan_tag_ID
  no shutdown
  bind interface interface_name context_name
end
context context_name
  ip vrf vrf_name
  { ip | ipv6 } address address subnetmask [ secondary ]
end
```

NOTES:

- `ip vrf vrf_name`—Creates a VRF in the router and assigns a VRF-ID.

Configuration Example

Following is a sample configuration for enabling VLAN segmentation using VRF:

```
config
  port ethernet 1/10
  no shutdown
  vlan 400
  no shutdown
  bind interface N6_interface1 ISP
#exit
  vlan 401
  no shutdown
  bind interface N6_interface2 ISP
#exit
context ISP
```

```

ip vrf vrf1
#exit
ip vrf vrf2
#exit
interface N6_interface1
  ip vrf forwarding vrf1
  ip address 209.165.200.225 209.165.200.254
  ip address 209.165.201.1 209.165.200.254 secondary
  ipv6 address 2001:DB8::1/32 secondary
interface N6_interface2
  ip vrf forwarding vrf2
  ip address 209.165.202.129 209.165.200.254
  ip address 209.165.201.30 209.165.200.254 secondary
  ipv6 address 2001:DB8:1::1/32 secondary

```

Monitoring and Troubleshooting

This section provides information regarding the CLI commands available for monitoring and troubleshooting the feature.

Show Commands and Outputs

This section provides information regarding show commands and their outputs in support of this feature.

show ip chunks

The output of this CLI command displays all chunks in that context.

With the Overlapping IP Pools functionality, the **show ip chunks vrf *vrf_name*** CLI command displays only chunks under that VRF.

- chunk-id
- chunk-size
- vrf-name
- start-addr
- end-addr
- used-addr
- Peer Address

Following is a sample output:

```

=====
VRF Name: MPN00001
=====
|-----|-----|-----|-----|-----|-----|
| Peer Address | chunk-id | chunk-size | start-addr | end-addr | used-addr |
|-----|-----|-----|-----|-----|-----|
|          0 | 192.10.25.23 | 1074790405 | 8192 | 36.40.128.0 | 36.40.159.255 |
|          0 | 192.10.25.23 | 1074790406 | 8192 | 36.40.160.0 | 36.40.191.255 |

```

0 |

show ipv6 chunks

The output of this CLI command displays all chunks in that context.

With the Overlapping IP Pools functionality, the output of the **show ipv6 chunks vrf *vrf_name*** CLI command displays only chunks under that VRF.

- chunk-id
- chunk-size
- vrf-name
- start-prefix
- end-prefix
- used-prefixes
- Peer Address

show ip bgp vpnv4

The output of this CLI command displays all the VPN routing information.

With the Overlapping IP Pools functionality, the **show ip bgp vpnv4 vrf *vrf_name*** CLI command displays the information under that VRF.

Following is a sample output:

```

VPNv4 Routing Table:
BGP table version is 1, local router ID is 172.31.35.36
Status Codes: s suppressed, d damped, h history, * valid, > best, i - internal, S stale, m
  Multipath
Origin Codes: i - IGP, e - EGP, ? - incomplete

Network          Next Hop          Metric LocPrf Weight Path
*> 0.0.0.0/0      172.31.35.29     0      0      65200 ?
*> 2.2.2.101/32   172.31.35.29     0      0      65200 ?
*> 2.2.3.2/32     0.0.0.0          0      32768 ?
*> 36.40.0.0/19   0.0.0.0          0      32768 ?
*> 36.40.32.0/19 0.0.0.0          0      32768 ?
*> 36.40.192.0/19 0.0.0.0          0      32768 ?

Total number of prefixes 6

```

show ip bgp vpnv6

The output of this CLI command displays all the VPN routing information.

With the Overlapping IP Pools functionality, the **show ip bgp vpnv6 vrf *vrf_name*** CLI command displays the information under that VRF.

Following is a sample output:

```

VPNv6 Routing Table:
BGP table version is 1, local router ID is 172.31.35.36

```

Status Codes: s suppressed, d damped, h history, * valid, > best, i - internal, S stale, m Multipath
 Origin Codes: i - IGP, e - EGP, ? - incomplete

Network	Next Hop	Metric	LocPrf	Weight	Path
*> 0.0.0.0/0	172.31.35.29	0		0	65200 ?
*> 2036:adb0:40	172.31.35.29/51		0		32768 ?
*> 2036:adb0:40:2000	172.31.35.29/51		0		32768 ?
*> 2036:adb0:40:c000	172.31.35.29/51		0		32768 ?

Total number of prefixes 4

show mpls ilm

The output of this CLI command displays the MPLS ILM table with FEC information.

With the Overlapping IP Pools functionality, the **show mpls ilm fec verbose** and **show mpls ilm fec summary** CLI commands display the information under the VRF.

The following is a sample output for the **show mpls ilm fec summary** CLI command to display the count.

Total ILM entries: 406

The following is a sample output for the **show mpls ilm fec Verbose** CLI command to display a detailed MPLS ILM table.

In-segment entry with in label: 832, id: 99, in label-space: 0, row status: Active
 Owner: BGP, # of pops: 1 XC Index:708
 FEC: 36.40.0.0/19
 FEC: 36.40.32.0/19
 FEC: 36.40.192.0/19

In-segment entry with in label: 833, id: 100, in label-space: 0, row status: Active
 Owner: BGP, # of pops: 1 XC Index:709
 FEC: 2037:adb0:201::/51
 FEC: 2037:adb0:201::/51
 FEC: 2037:adb0:201::/51



CHAPTER 53

Voice over New Radio

This chapter covers the following topics:

- [Feature Summary and Revision History](#), on page 509
- [Feature Description](#), on page 510

Feature Summary and Revision History

Summary Data

Table 116: Summary Data

Applicable Product(s) or Functional Area	5G-UPF
Applicable Platform(s)	VPC-SI SMI
Feature Default Setting	Enabled – Always-on
Related Changes in this Release	Not Applicable
Related Documentation	Not Applicable

Revision History

Table 117: Revision History

Revision Details	Release
First Introduced.	2020.02.0

Feature Description

The UPF supports Voice over New Radio (VoNR) with the existing Session Establishment and Modification procedures. In these procedures, the SMF creates the PDR for 5QI=5 Non-GBR flow for IMS signaling and PDR for 5QI=1 GBR flow for voice traffic. The UPF does not require any special handling to support mobile-originated or mobile-terminated call flows.

How it Works

The following are the steps in the call flow in which the PDRs are created with 5QI value 5 for IMS signaling and 5QI value 1 or Voice Traffic.

VoNR Call Flow for UPF

This section describes the steps for VoNR session and respective PDR Creation on UPF.

Figure 31: VoNR Call Flow

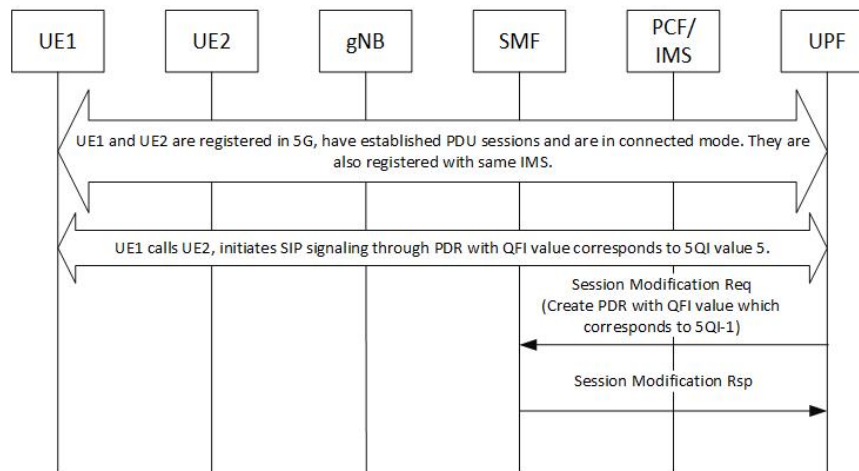

Table 118: VoNR Call Flow

Step	Description
1	UE1 and UE2 are registered on 5G network. They establish the IMS PDU session and both are registered with same IMS. Both UEs are in connected mode.
2	For IMS signaling, a non-GBR QoS PDRs (UL and DL) is created by SMF which has the QFI value that corresponds to 5QI value 5.
3	Similarly, for Conversational Voice traffic, the PDRs for GBR QoS flow is created with the QFI value that corresponds to 5QI value 1.
4	The QFI to 5QI mapping is maintained by SMF, hence the QFI does not have the values same as 5QI.

Step	Description
5	The above steps are valid for both Mobile Originated (MO) or Mobile Terminate (MT) call flows.
6	Refer to 3GPP TS 23.501, Section 5.7.4 for other types of 5QI mappings for GBR or Non-GBR flows.



CHAPTER 54

WPS Prioritization

Table 119: Feature History

Feature Name	Release Information	Description
WPS Prioritization on UPF	2023.04	<p>The Wireless Priority Services (WPS) feature provides finer control for priority handling over multiple interfaces.</p> <p>UPF supports WPS services based on the message priority indicated by SMF. The configured priority value set on SMF will be sent to UPF over N4 as part of the PFCP header.</p>

- [Feature Description, on page 513](#)
- [How it Works, on page 514](#)
- [Configuring WPS Prioritization, on page 516](#)
- [OAM Support, on page 517](#)

Feature Description

The Wireless Priority Services (WPS) feature provides finer control for priority handling over multiple interfaces. UPF supports WPS based on the message priority indicated by SMF.

The priority value set on SMF will be sent to UPF over N4 as part of the PFCP header. The message priority values from SMF/CUPS-CP are currently supported for Emergency, VoLTE, and non-VoLTE IMS sessions.



Note WPS supports only N4 (SMF) and Sxa (cnSGW) terminations on UPF. WPS does not support Sxb (PGW-C) and Sxa (SGW-C) terminations in this release.

For information on WPS prioritization support on RCM, see the *UCC 5G RCM Configuration and Administration Guide*.

For information on WPS prioritization support on SMF, see the *UCC 5G SMF Configuration and Administration Guide*.

How it Works

This section describes how WPS prioritization works in UPF.

Priority Handling

The session-priority-profile maps the session-priority values from 0 to 15 to precedence values from 1 to 4. It is used internally in modules like RCM and data-queue distribution.

SR and ICSR

When the feature is not enabled, any session with a valid session-priority received over N4/SX will be prioritized for SR/ICSR as per earlier design.

When the feature enabled, there is a change such that only the Emergency and WPS sessions will be prioritized for SR/ICSR. During UPF downgrade, the priority values are recovered with an offset of +1.

Data Queue

The following table describes the traffic distribution over data queues based on session precedence:

Queue #	Details
3 (Highest priority)	Reserved for Sx
2	Used for Precedence 1,2 sessions
1	Used for Precedence 3,4 sessions
0 (Lowest priority)	Used for Data/Non-prioritized sessions

The default precedence values will be used when:

- Only session-type is configured and precedence is not defined for session-priority
- No priority value is configured in the session-priority profile
- WPS feature is enabled with the **default** session-priority profile



Note

- If the feature is disabled, UPF uses N-1 support prioritization.
- For session recovery of combo calls, the highest priority value received on Sxa or N4 will be used for both sessions.

Mapping to Session Type

UPF maps the session priority values (WPS, Emergency, and IMS) received over N4 to the session types using the "associate session-priority-profile" CLI configuration.

For VoLTE non-active sessions, mapping is not available. For VoLTE active sessions, the priority value 'ims' will be used, while the next priority value (+1) is implicitly used for VoLTE non-active sessions. Hence, "ims+1" priority should not be configured in the session-priority profile.

Version Compatibility

1. For the latest version (X) of RCM and a prior version (X-1) of UPF:
 - a. RCM will support the previous UPF version (X-N), as the priority set is extended without affecting the previously supported set of priorities (1, 2, 3).
 - b. During switchover, the flush sequence will be completely based on the priority received from the UPF, which was not the case in earlier versions.
2. For the prior version (X-1) of RCM and latest version (X) of UPF:
 - a. RCM will not support the extended set of priorities, and the checkpoints received for priority 4 will be dropped.
 - b. During switchover, calls for priority 1, 2, and 3 can be restored.

Control-Plane Compatibility

To enable WPS prioritization, upgrade the UPF to the new configuration. Prioritization will not be guaranteed in the following scenarios when:

- SMF/CP is not upgraded
- Priority values are sent based on N-1 support
- WPS prioritization is enabled on UPF

Based on the priority values received from the Control Plane, the following combinations will work:

S. No.	SMF / cnSGW / PGW-C / SGW-C Version	UPF Version	WPS prioritization enabled on UPF	UPF Behavior
1	N-1 Or N without config	N-1	N/A	No WPS prioritization - same as previous behavior.
2	N-1 Or N without config	N	No	No WPS prioritization - same as previous behavior.
3	N-1 Or N without config	N	Yes	Session prioritization will not be guaranteed.

S. No.	SMF / cnSGW / PGW-C / SGW-C Version	UPF Version	WPS prioritization enabled on UPF	UPF Behavior
4	N (Config present)	N-1	N/A	This is not recommended as session prioritization will not be guaranteed. RCM checkpoints will be dropped for priority>3.
5	N (Config present)	N	Yes	WPS prioritization works.
6	N (Config present)	N	No	This is not recommended as session prioritization will not be guaranteed.

Limitations

The WPS Prioritization feature has the following limitations:

- In a multi-Sx/N4 scenario, all Control Plane nodes must use the same process to send MP values. This applies to SMF/cnSGW and PGW-C/SGW-C working with the same UPF.
- The sessions recovered during the UPF software upgrade will retain their prioritization values. As a result, after the UPF upgrade between N-1 and N, the prioritization for existing sessions will not work as expected, and the show CLI output will be undetermined.
- In the case of a configuration change at the SMF that changes existing priority values or a configuration change at the UPF that changes the session type, the session type and priority are not re-evaluated. As a result of such a configuration change, incorrect statistics updates may occur.
- Due to any mid-session priority changes, some of the statistics may be inconsistent.

Configuring WPS Prioritization

This section describes how to configure the WPS Prioritization feature.

Enabling WPS Prioritization

Use the following configuration to enable or disable WPS prioritization support and associate a session-priority-profile with the user-plane-service:

```

config
  context context_name
    user-plane-service up_service_name
      [ no ] associate session-priority-profile { name | default } [
name_string ]
    end

```

NOTES:

- **associate session-priority-profile { name | default } [name_string]**: Enables WPS prioritization support.

- **name**: Specify the name of the session priority profile to be associated with the User Plane service.
- **default**: Specify the default precedence value associated with the session priority.
- *name_string* : Specify the name string associated with the session priority.
- **no associate session-priority-profile** : Disables WPS prioritization support.
- On a given UPF, you can configure a total number of 16 session-priority profiles. Only one session-priority profile can be associated with a user-plane service.
- When a session does not receive any message-priority within the N4/Sx messages, it is classified as a 'Normal' session with a 'precedence' value set to 0.
- If a priority is not specified in the session-priority-profile configuration, the session-type will be shown as 'Unclassified' and uses the default1 precedence value.
- When there is no session-priority-profile association in the user-plane-service, UPF utilizes the existing (N-1) behavior with fixed priority values, including Emergency, IMS-VoLTE, and IMS-nonVoLTE.

Mapping the Session Priority Profile

Use the following configuration to configure the session priority value with a session type and precedence value.

```

config
  session-priority-profile spp_name
    priority priority_value type { wps | emergency | ims } precedence
    precedence_value
  end

```

NOTES:

- **session-priority-profile**: Specify the session priority profile name.
- **priority**: Specify the priority value as an integer in the range of 0 to 15.
- **type { wps | emergency | ims }**: Specify the session type.
- **precedence**: Specify the precedence value as an integer in the range of 1 to 4.
- The session-priority profile must not be configured with the priority value next to the one assigned for **ims**.

OAM Support

Show Commands Support

This section provides information about show commands and their outputs in support of this feature.

show subscribers user-plane-only full all

The output of this CLI command is enhanced to display the session-type value.

The following is a sample output of this command:

```
show subscribers user-plane-only full all | more

Local SEID      : [0x0004000000000000] 1125899906842624
Remote SEID     : [0x0004000000000002] 1125899906842626
State           : Connected
Connect Time    : Thu Jun  8 09:36:49 2023
Idle time       : 00h00m11s
Access Type:    uplane-ipv4           Network Type: IP
user-plane-service-name: user-plane-service
active-service-scheme-name:
Callid: 00004e21
Rulebase: prepaid
Interface Type: Sxb
eMPS Session:  Yes
eMPS Session Priority: 6
Session-Type:   wps
Precedence-Order: 1
Data Queue:     2
```

show user-plane-service all

The output of this CLI command is enhanced to display the Session Priority Profile name.

The following is a sample output of this command:

```
show user-plane-service all

Service name : user-plane-service
Service-Id : 7
Context : ingress
Status : STARTED
PGW Ingress GTPU Service : sx-gtpu-service
...
Nf-Instance-Id : Not defined
Session Priority Profile      : sp1
```

show user-plane-service session-priority-profile name | all

The output of this CLI command displays the session priority profile name, along with type and precedence value per priority.

The following is a sample output of this command:

```
show user-plane-service session-priority-profile name spp1

Session Priority Profile Name: spp1
Priority      Type           Precedence
-----
0             unclassified    1
1             wps             1
2             unclassified    1
3             emergency       2
4             unclassified    2
5             ims             3
6             ims             3
7             unclassified    2
8             unclassified    3
9             unclassified    3
10            unclassified    3
11            unclassified    3
12            unclassified    4
13            unclassified    4
```

```

14          unclassified      4
15          unclassified      4
    
```

Total session priority profile(s) found: 1

show user-plane-service statistics all

The output of this command is enhanced to display the number of WPS sessions.

The following is a sample output of this command:

```

show user-plane-service statistics all
...
eMPS PDNs Total:
Active:          0          Setup:          0
Released:       0          Rejected:     0

WPS PDNs Total:
Active:          0          Setup:          0
Released:       0          Rejected:     0
    
```

show user-plane-service statistics session-priority-profile

The output of this CLI command displays the number of prioritized and non-prioritized sessions. This command also displays prioritized sessions based on the 'type' configuration in the 'session-priority-profile'.

The following is a sample output of this command:

```

show user-plane-service statistics session-priority-profile

Total Non-Prioritized (Normal) sessions: 0

Total Prioritized sessions: 121
WPS sessions          Total: 11          Active: 11
Precedence            Config match      Default match
-----
1                     1                 0
2                     0                 10
3                     0                 0
4                     0                 0

Emergency sessions    Total: 110        Active: 110
Precedence            Config match      Default match
-----
1                     0                 10
2                     0                 0
3                     0                 100
4                     0                 0

IMS sessions          Total: 0           Active: 0
Precedence            Config match      Default match
-----
1                     0                 0
2                     0                 0
3                     0                 0
4                     0                 0

Unclassified sessions Total: 0           Active: 0
Precedence            Config match      Default match
-----
1                     0                 0
2                     0                 0
    
```

show user-plane-service statistics session-priority-profile

3
4

0
0

0
0



CHAPTER 55

X-Header Insertion and Encryption

- [Feature Summary and Revision History, on page 521](#)
- [Feature Description, on page 522](#)
- [How it Works, on page 522](#)
- [Configuring X-Header Insertion and Encryption, on page 523](#)
- [Monitoring and Troubleshooting X-Header Insertion and Encryption Configuration, on page 525](#)
- [Anti-Spoofing Support, on page 526](#)

Feature Summary and Revision History

Summary Data

Table 120: Summary Data

Applicable Product(s) or Functional Area	5G-UPF
Applicable Platform(s)	VPC-SI
Feature Default Setting	Disabled – Configuration Required
Related Changes in This Release	Not Applicable
Related Documentation	<i>UCC 5G UPF Configuration and Administration Guide</i>

Revision History

Revision Details	Release
Added support for the anti-spoofing functionality through X-header enrichment.	2023.02.0
First introduced.	2020.02.x

Feature Description

The process of X-header insertion and encryption is collectively known as Header Enrichment (HE). The UPF supports HE to allow deletion and modification of the existing X-header fields in the HTTP header of the URL requests.

This feature enables appending the headers to HTTP or WSP GET and POST Request packets, and HTTP Response packets for use by end applications, such as mobile advertisement insertion (MSISDN, IMSI, IP address, user-customizable, and so on).

How it Works

HE includes two operations:

1. [X-Header Insertion](#)
2. [X-Header Encryption](#)

X-Header Insertion

Extension header (X-header) fields are fields that are added to protocol headers for specific purposes such as user identification, device detection, etc. The X-header mechanism allows additional entity-header fields to be defined without changing the protocol. However, these fields are assumed to be unrecognizable by the recipients.

X-header insertion inserts X-headers in HTTP or WSP GET and POST Request packets and HTTP Response packets. You can configure rules to insert X-headers in HTTP or WSP Request and HTTP Response packets. The charging-action associated with the rules contain the list of X-headers to be inserted in the packets.



Note

- Flows for which the X-header is inserted in a packet are not offloaded.
 - With the X-header configuration, all TCP OOO packets irrespective of transmit order CLI, will be buffered and sent after re-ordering.
-

X-Header Encryption

X-header encryption enables encryption of X-header fields before insertion. If X-header insertion has already happened for an IP flow (because of any X-header format) and the current charging-action has the first-request-only flag set, the X-header insertion will not happen for that format. If the first-request-only flag is not set in a charging-action, the insertion for that X-header format continues happening in other suitable packets of that IP flow.

Changes to the X-header format configuration do not trigger re-encryption for existing calls. The changed configuration will however, be applicable for new calls. The changed configuration will also apply at the time of the next re-encryption, to the existing calls for which the re-encryption timeout is specified. If encryption

is enabled for a parameter while data is flowing, since its encrypted value will not be available, insertion of that parameter stops.



Note This feature does not support flow recovery.

Limitations

This section highlights the limitations existing in the current release:

- X-header insertion in the Response packet is not supported.
- X-header encryption with RSA and RC4MD5 is supported, but not supported with AES.
- Monitor protocol for X-header is not supported.
- Insertion of the following X-header fields is not supported in a packet:
 - QoS
 - UIDH
 - Customer ID
 - Hash Value
 - Time of the Day
 - RADIUS String
 - Session-Id
 - Congestion Level
 - User-Profile
- Parsing and buffering of the HTTP header will be done only if the rulebase has any x-header format configured with x-header fields explicitly set to delete-existing. For operators not using x-header delete-existing, no overhead for parsing or buffering will be seen.

Configuring X-Header Insertion and Encryption

Configuring X-Header Insertion

Step 1	Create or configure a ruledef to identify the HTTP packets in which the X-headers must be inserted.
Step 2	Create or configure a rulebase and configure the charging-action that inserts the X-header fields into the HTTP packets.
Step 3	Create the X-header format as described in <i>Creating the X-Header Format</i> .

Step 4	Configure the X-header format based on the message type in the charging action, as described in <i>Configuring the X-Header Format</i> .
---------------	--

Creating the X-Header Format

To create an X-header format, use the following configuration:

```
configure
  active-charging service ecs_service_name
    xheader-format xheader_format_name
  end
```

Configuring the X-Header Format

To configure an X-header format, use the following configuration:

```
configure
  active-charging service ecs_service_name
    xheader-format xheader_format_name
      insert xheader_field_name string-constant xheader_field_value | variable
{ bearer { 3gpp { apn | charging-characteristics | charging-id | imei |
imsi | qos | rat-type | s-mcc-mnc | sgsn-address } | acr | customer-id |
ggsn-address | mdn | msisdn-no-cc | radius-string |
radius-calling-station-id | session-id | sn-rulebase |
subscriber-ip-address | username } [ encrypt ] [ delete-existing ] | http
{ host | url } }
    end
```

Configuring X-Header Encryption

Step 1	Configure the X-header insertion as described in <i>Configuring X-Header Insertion</i> .
Step 2	Create or configure a rulebase, and the encryption certificate to use and the re-encryption parameter as described in <i>Configuring X-Header Encryption</i> .
Step 3	Configure the encryption certificate to use as described in <i>Configuring Encryption Certificate</i> .

Configuring X-Header Encryption

To configure X-header encryption, use the following configuration:

```
configure
  active-charging service ecs_service_name
    rulebase rulebase_name
      xheader-encryption certificate-name certificate_name
      xheader-encryption re-encryption period re-encryption_period
    end
```

NOTES:

- This configuration enables X-header encryption for all subscribers using the specified rulebase.

- If the certificate is removed, ECS continues using the copy that it has. The copy is set free once the certificate name is removed from the rulebase.
- Changes to x-header format configuration won't trigger re-encryption for existing calls. The changed configuration will however, be applicable for new calls. The changed configuration will also apply at the next reencryption time to those existing calls for which reencryption timeout is specified. If encryption is enabled for a parameter while data is flowing, since its encrypted value won't be available, insertion of that parameter stops.

Configuring Encryption Certificate

To configure the encryption certificate, use the following configuration:

```
configure
  certificate name certificate_name pem { { data pem_certificate_data private-key
  pem [ encrypted ] data pem_pvt_key } | { url url private-key pem { [
  encrypted ] data pem_pvt_key | url url } }
  end
```

Verifying X-header Insertion and Encryption Configuration

Use the following command in the Exec Mode to verify your configuration:

```
xheader-format xheader_format_name
```

Monitoring and Troubleshooting X-Header Insertion and Encryption Configuration

show active-charging charging-action statistics name

The output of this command displays statistics for X-header information.

- X-header information:
 - XHeader Bytes Injected
 - XHeader Pkts Injected
 - IP Frags consumed by XHeader
 - XHeader Bytes Removed
 - XHeader Pkts Removed

show active-charging rulebase statistics name

The output of this command displays the header enrichment statistics.

- HTTP header buffering limit reached

Anti-Spoofing Support

Feature Description

The UPF supports spoofing detection and mitigation using header enrichment. The anti-spoofing functionality allows the operators and their subscribers from spoofing threats posed by malicious UE devices. This feature detects the fraudulent activities when an external portal is used for subscriber or content authorization.

The anti-spoofing functionality is supported only for HTTP Requests. This functionality allows deletion and modification of the existing X-header fields in the HTTP header of the URL request.

If the user-generated header name is similar to the header name used in x-header format, you can search, delete, and modify the X-header fields. The X-header field names are case-insensitive. For example, if x-MSISDN and x-msisdn fields are present in an incoming HTTP request, both fields are processed.

If the user HTTP header already has the fields to be inserted, the corresponding values for those fields are replaced with the modified values from the gateway at the end of the header. In case of multiple entries for one field, which is already present in the header, a single instance of the field is selected along with the value inserted from the gateway.

In case of multiple HTTP GET requests, the packet header replaced with X-header fields for all GET requests. If encryption is enabled, it is performed after inserting the X-header.

Limitations

The following are the known limitations of the anti-spoofing feature:

- If an HTTP GET or POST header is not complete in 3 packets, the anti-spoofing is performed only for the last packet in which the header completes. Otherwise, the packets are sent out without HE.
- Though fields without having 'x-' in the field name are allowed, we do not delete the extension header fields that do not start with x-.

Enabling Anti-Spoofing in X-Header

To enable anti-spoofing in the X-header, use the following configuration:

```
configure
  active-charging service acs_service_name
    xheader-format xheader_format_name
      insert xheader_field_name variable { bearer subscriber-ip-address } [
encrypt ] [ delete-existing ]
    exit
```

NOTES:

- **delete-existing**: This command enables detection of spoofing in an X-header file.
- This feature is disabled by default.
- A maximum number of 10 X-header fields can be configured with the **delete-existing** CLI keyword, which also includes fields configured only for X-header insertion.

OAM Support

This section provides information regarding show commands and their outputs for the anti-spoofing feature.

show user-plane-service statistics charging-action [name | all]

The output of this command displays the user plane statistics for charging action.

- X-header information:
 - XHeader Bytes Injected
 - XHeader Pkts Injected
 - XHeader Bytes Removed
 - XHeader Pkts Removed

show user-plane-service statistics rulebase [name | all]

The output of this command displays user plane statistics for rulebase.

- Header Enrichment stats:
 - HTTP header buffering limit reached



PART II

Troubleshooting Information

- [UPF Troubleshooting Information, on page 531](#)



CHAPTER 56

UPF Troubleshooting Information

This chapter covers the following topics related to monitoring and troubleshooting the UPF features:

- [Debug Logging](#) , on page 531
- [Monitoring CLI](#), on page 532
- [Monitoring Protocol](#), on page 532
- [RAT Type-based Statistics](#), on page 532
- [Subscriber Level CLI](#), on page 537
- [VPP Statistics](#), on page 542
- [SNMP Support](#), on page 546
- [Troubleshooting UPF Features](#), on page 547

Debug Logging



Important The debug logging CLIs must be enabled with the help of System Administrator. Enabling debug logging CLIs can be resource intensive.

Use the following debug CLIs as required:

- **logg filter active facility sx level debug**
- **logg filter active facility user-data level debug**
- **logg filter active facility sessmgr level debug**
- **logg filter active facility uplane level debug**
- **logg filter active facility egtpc level debug**
- **logg filter active facility gtpu level debug**
- **logg filter active facility egtpu level debug**
- **logg filter active facility gtpumgr level debug**
- **logg filter active facility sxdemux level debug**
- **logg filter active facility user-l3tunnel level debug**

- **logg filter active facility aaamgr level debug**
- **logg filter active facility vpp level debug**
- **logg filter active facility dpath level debug**
- **logg active pdu-verbosity 5**
- **logg syslog *ip_address* facility *facilities* event-verbosity { min | concise | full }**

Monitoring CLI

Subscriber Level Message

Use the **mon sub callid** CLI command for subscriber level message.

Resource Tracking

Use the **show task resources facility *sessmgr* all** CLI command to track the CPU/Memory for PROCLET.

Service Status

Use the **show service all** CLI command to check the service status.

Sx Peer Status

Use the **show sx peers** CLI command to check the Sx peer status.

Monitoring Protocol

When using the monitor protocol command, enable option 49 for PFCP, and option 26 for GTP-U.

RAT Type-based Statistics

The RAT Type-based Statistics feature equip users to view data statistics segregated by RAT Type in UPF.

RAT Type-based data statistics in UPF maintains separate buckets. These buckets are created at Session Manager instance level. Bucket is assigned to a subscriber at the time of call-setup, based on RAT Type IE received in “Subscriber-Parameters”. If the IE is not received, “Unknown” RAT Type bucket is assigned to that subscriber. During the session, if UPF receives a new RAT Type for a subscriber, the bucket is changed accordingly.



Important Data statistics are not checkpointed and lost during Session Recovery/ICSR. Only “Current-Subscriber” statistics are recalculated after recovery (during the time of call-audit).

Show Command and Output

The following CLI command displays node-level RAT statistics for UPF: **show user-plane-service statistics rat { 5g-nr | all | eutran | unknown | wlan }**

NOTES:

- **5g-nr**: Displays the data statistics for 5G NR subscribers.
- **all**: Displays the data statistics for all RAT Type subscribers.
- **eutran**: Displays the data statistics for EUTRAN subscribers.
- **unknown**: Displays the data statistics for subscribers of unknown RAT type.
- **wlan**: Displays the data statistics for WLAN subscribers.

Statistics

The following table provides description of each field.

Table 121: show user-plane-service statistics rat all

Field	Description
Current Subscribers	
5G NR	Specifies the total number of current 5G NR subscribers.
EUTRAN	Specifies the total number of current EUTRAN subscribers.
WLAN	Specifies the total number of current WLAN subscribers.
Unknown	Specifies the total number of current subscribers of unknown RAT type.
Data Statistics	
5G NR	Specifies the data statistics for 5G NR subscribers.
Uplink	Specifies data statistics for 5G NR subscribers in uplink direction.
Total Pkts	Specifies the total number of uplink packets for 5G NR subscribers.
Total Bytes	Specifies the total number of uplink bytes for 5G NR subscribers.
Total Dropped Pkts	Specifies the total number of uplink packets dropped for 5G NR subscribers.
Total Dropped Bytes	Specifies the total number of uplink bytes dropped for 5G NR subscribers.
Downlink	Specifies data statistics for 5G NR subscribers in downlink direction.
Total Pkts	Specifies the total number of downlink packets for 5G NR subscribers.
Total Bytes	Specifies the total number of downlink bytes for 5G NR subscribers.
Total Dropped Pkts	Specifies the total number of downlink packets dropped for 5G NR subscribers.

Field	Description
Total Dropped Bytes	Specifies the total number of downlink bytes dropped for 5G NR subscribers.
EUTRAN	Specifies the data statistics for EUTRAN subscribers.
Uplink	Specifies data statistics for EUTRAN subscribers in uplink direction.
Total Pkts	Specifies the total number of uplink packets for EUTRAN subscribers.
Total Bytes	Specifies the total number of uplink bytes for EUTRAN subscribers.
Total Dropped Pkts	Specifies the total number of uplink packets dropped for EUTRAN subscribers.
Total Dropped Bytes	Specifies the total number of uplink bytes dropped for EUTRAN subscribers.
Downlink	Specifies data statistics for EUTRAN subscribers in downlink direction.
Total Pkts	Specifies the total number of downlink packets for EUTRAN subscribers.
Total Bytes	Specifies the total number of downlink bytes for EUTRAN subscribers.
Total Dropped Pkts	Specifies the total number of downlink packets dropped for EUTRAN subscribers.
Total Dropped Bytes	Specifies the total number of downlink bytes dropped for EUTRAN subscribers.
WLAN	Specifies the data statistics for WLAN subscribers.
Uplink	Specifies data statistics for WLAN subscribers in uplink direction.
Total Pkts	Specifies the total number of uplink packets for WLAN subscribers.
Total Bytes	Specifies the total number of uplink bytes for WLAN subscribers.
Total Dropped Pkts	Specifies the total number of uplink packets dropped for WLAN subscribers.
Total Dropped Bytes	Specifies the total number of uplink bytes dropped for WLAN subscribers.
Downlink	Specifies data statistics for WLAN subscribers in downlink direction.
Total Pkts	Specifies the total number of downlink packets for WLAN subscribers.
Total Bytes	Specifies the total number of downlink bytes for WLAN subscribers.
Total Dropped Pkts	Specifies the total number of downlink packets dropped for WLAN subscribers.
Total Dropped Bytes	Specifies the total number of downlink bytes dropped for WLAN subscribers.
Unknown	Specifies the data statistics for subscribers of unknown RAT type.
Uplink	Specifies data statistics for unknown RAT type subscribers in uplink direction.

Field	Description
Total Pkts	Specifies the total number of uplink packets for unknown RAT type subscribers.
Total Bytes	Specifies the total number of uplink bytes for unknown RAT type subscribers.
Total Dropped Pkts	Specifies the total number of uplink packets dropped for unknown RAT type subscribers.
Total Dropped Bytes	Specifies the total number of uplink bytes dropped for unknown RAT type subscribers.
Downlink	Specifies data statistics for unknown RAT type subscribers in downlink direction.
Total Pkts	Specifies the total number of downlink packets for unknown RAT type subscribers.
Total Bytes	Specifies the total number of downlink bytes for unknown RAT type subscribers.
Total Dropped Pkts	Specifies the total number of downlink packets dropped for unknown RAT type subscribers.
Total Dropped Bytes	Specifies the total number of downlink bytes dropped for unknown RAT type subscribers.

Bulk Statistics

The following bulk statistics are included in the User Plane Service schema to track RAT Type-based data statistics events.

Table 122: show bulkstats variables user-plane-service

Variable Name	Data Type	Key	Counter Type
vpnname	String	1	Info
vpnid	Int32	1	Info
servname	String	1	Info
servid	Int32	1	Info
curr-pdn-rat-eutran	Int64	0	Gauge
curr-pdn-rat-5g-nr	Int64	0	Gauge
curr-pdn-rat-wlan	Int64	0	Gauge
curr-pdn-rat-unknown	Int64	0	Gauge
uplink-total-pkts-pdn-rat-eutran	Int64	0	Counter
uplink-total-bytes-pdn-rat-eutran	Int64	0	Counter

Variable Name	Data Type	Key	Counter Type
uplink-total-pkts-dropped-pdn-rat-eutran	Int64	0	Counter
uplink-total-bytes-dropped-pdn-rat-eutran	Int64	0	Counter
downlink-total-pkts-pdn-rat-eutran	Int64	0	Counter
downlink-total-bytes-pdn-rat-eutran	Int64	0	Counter
downlink-total-pkts-dropped-pdn-rat-eutran	Int64	0	Counter
downlink-total-bytes-dropped-pdn-rat-eutran	Int64	0	Counter
uplink-total-pkts-pdn-rat-5g-nr	Int64	0	Counter
uplink-total-bytes-pdn-rat-5g-nr	Int64	0	Counter
uplink-total-pkts-dropped-pdn-rat-5g-nr	Int64	0	Counter
uplink-total-bytes-dropped-pdn-rat-5g-nr	Int64	0	Counter
downlink-total-pkts-pdn-rat-5g-nr	Int64	0	Counter
downlink-total-bytes-pdn-rat-5g-nr	Int64	0	Counter
downlink-total-pkts-dropped-pdn-rat-5g-nr	Int64	0	Counter
downlink-total-bytes-dropped-pdn-rat-5g-nr	Int64	0	Counter
uplink-total-pkts-pdn-rat-wlan	Int64	0	Counter
uplink-total-bytes-pdn-rat-wlan	Int64	0	Counter
uplink-total-pkts-dropped-pdn-rat-wlan	Int64	0	Counter
uplink-total-bytes-dropped-pdn-rat-wlan	Int64	0	Counter
downlink-total-pkts-pdn-rat-wlan	Int64	0	Counter
downlink-total-bytes-pdn-rat-wlan	Int64	0	Counter
downlink-total-pkts-dropped-pdn-rat-wlan	Int64	0	Counter
downlink-total-bytes-dropped-pdn-rat-wlan	Int64	0	Counter
uplink-total-pkts-pdn-rat-unknown	Int64	0	Counter
uplink-total-bytes-pdn-rat-unknown	Int64	0	Counter
uplink-total-pkts-dropped-pdn-rat-unknown	Int64	0	Counter
uplink-total-bytes-dropped-pdn-rat-unknown	Int64	0	Counter
downlink-total-pkts-pdn-rat-unknown	Int64	0	Counter
downlink-total-bytes-pdn-rat-unknown	Int64	0	Counter

Variable Name	Data Type	Key	Counter Type
downlink-total-pkts-dropped-pdn-rat-unknown	Int64	0	Counter
downlink-total-bytes-dropped-pdn-rat-unknown	Int64	0	Counter

Subscriber Level CLI

Use the following subscriber level CLIs as required:

- **show subscribers user-plane-only full all**
- **show subscribers user-plane-only full msid *msid_value***
- **show subscribers user-plane-only { seid *seid_value* | callid *callid_value* } pdr all**
- **show subscribers user-plane-only { seid *seid_value* | callid *callid_value* } far all**
- **show subscribers user-plane-only { seid *seid_value* | callid *callid_value* } qer all**
- **show subscribers user-plane-only { seid *seid_value* | callid *callid_value* } urr all**
- **show subscribers user-plane-only { seid *seid_value* | callid *callid_value* } bar all**
- **show subscribers user-plane-only { seid *seid_value* | callid *callid_value* } pdr full all**
- **show subscribers user-plane-only { seid *seid_value* | callid *callid_value* } urr full all**
- **show subscribers user-plane-only { seid *seid_value* | callid *callid_value* } far full all**
- **show subscribers user-plane-only { seid *seid_value* | callid *callid_value* } qer full all**
- **show subscribers user-plane-only { seid *seid_value* | callid *callid_value* } bar full all**
- **show subscribers user-plane-only { seid *seid_value* | callid *callid_value* } pdr id *id_value***
- **show subscribers user-plane-only { seid *seid_value* | callid *callid_value* } flows full**
- **show subscribers user-plane-only { seid *seid_value* | callid *callid_value* } bli full all**

show subscribers user-plane-only full msid *msid_value*

The **show subscribers user-plane-only full msid *msid_value*** command displays the specific user information at instance-level and session-level for data collection during troubleshooting.

The following is a sample output of this command:

```
show subscribers user-plane-only full msid 404005123456789

Local SEID      : [0x0004000000000000] 1125899906842624
Remote SEID     : [0x0004000000000000] 1125899906842631
State           : Connected
Connect Time    : Thu Sep 15 20:40:09 2022
Idle time       : 00h11m25s
Access Type:    uplane-ipv4                Network Type: IP
user-plane-service-name: UP21
active-service-scheme-name:
```

show subscribers user-plane-only full msid msid_value

```

Callid: 00004e21
Rulebase: cisco
Interface Type: Sxb
eMPS Session: No
eMPS Session Priority: 0
Card/Cpu: 1/0
IP address: 11.11.12.0
Next Hop Ip Address:
Source context: EPC2-UP
PDN-Instance: starent.com
User-plane-Sx-addr: 20.20.20.106
Control-plane-Sx-addr: 20.20.20.101
Number of associated PDRs : 0
Number of associated ADC PDRs : 0
Number of associated FARs : 0
Number of associated QERs : 1
Number of associated BARs : 0
Number of associated URRs : 0
Uplink APN AMBR (bps) : 200000
active input acl: IPV4ACL
active input ipv6 acl: n/a
Bandwidth Policy: bw_policy1
FW-and-NAT Policy: n/a
FW-and-NAT Policy ID: n/a
Firewall Policy IPv4: n/a
Firewall Policy IPv6: n/a
NAT Policy NAT44: n/a
NAT Policy NAT64: n/a
Converged Session: No
Visited Call: No
Subscriber Parameters:
IMSI: 404005123456789
IMEI: 112233445566778
MSISDN: 9890098900
Charging Characteristics: 0x3412
Rat Type: 6
MCC MNC: 123765
SGSN Address: 20.20.20.61
ULI: TAI=12546312ab00
Congestion Level: 0
GGSN Address: 20.20.20.101
User-Name: 9890098900@starent.com
Session-ID: 1414146500000008
input pkts: 0
input bytes: 0
input bytes dropped: 0
input pkts dropped: 0
CF Buffered Uplink Packets: 0

CF Buffered Uplink Bytes: 0
Uplink Packets in Buffer: 0
Buff Over-limit Uplink Pkts: 0

DDN buffered pkts : 0
DDN buffer overflow drop pkts : 0

pk rate from user(bps): 0
ave rate from user(bps): 0
sust rate from user(bps): 0
pk rate from user(pps): 0
ave rate from user(pps): 0
sust rate from user(pps): 0
ipv4 bad hdr: 0
ipv4 fragments sent: 0

Sessmgr Instance: 1
Destination context: ISPl-UP
Downlink APN AMBR (bps) : 200000
active output acl: IPV4ACL
active output ipv6 acl: n/a
Converged Peer Callid: n/a

output pkts: 0
output bytes: 0
output bytes dropped: 0
output pkts dropped: 0
CF Buffered Downlink Packets: 0

CF Buffered Downlink Bytes: 0
Downlink Packets in Buffer: 0
Buff Over-limit Downlink Pkts: 0

DDN buffered bytes : 0
DDN buffer overflow drop bytes : 0

pk rate to user(bps): 0
ave rate to user(bps): 0
sust rate to user(bps): 0
pk rate to user(pps): 0
ave rate to user(pps): 0
sust rate to user(pps): 0
ipv4 ttl exceeded: 0
ipv4 could not fragment: 0

```



```

ipv4 bad length trim: 0
input pkts dropped (0 mbr): 0
ipv4 input acl drop: 0
ipv6 input acl drop: 0
ip source violations: 0
ipv6 bad hdr: 0
ipv4 icmp packets dropped: 0
APN AMBR Uplink Pkts Drop: 0
APN AMBR Uplink Bytes Drop: 0

APN AMBR Uplink Pkts IP pref lowered: 0
0
APN AMBR Uplink Bytes IP pref lowered: 0
0
ITC Uplink Pkts Drop: 0
ITC Uplink Bytes Drop: 0
ITC Uplink Pkts IP pref lowered: 0

ITC Uplink Bytes IP pref lowered: 0

ITC Terminated Flows:: 0
Flow Action Terminated Flows: 0

ToS marked Uplink Pkts: 0
CC Dropped Uplink Pkts: 0
CC Dropped Uplink bytes: 0
Uplink Inflight Pkts: 0
QFI Mismatch Uplink Pkts Drop: 0

Total QoS-Group(s) Active: 0
DNS-to-EDNS Uplink Pkts: 0
EDNS Response Received: 0

Flow information:
  Current Active Flows:
    TCP: 0
    UDP: 0
  Total Flows:
    TCP: 0
    UDP: 0
    FP: 0

Static & Predef Rule Match stats:
Rule Name          Pkts-Down  Bytes-Down Pkts-Up   Bytes-Up   Hits      Match-Bypassed
  FP-Down (Pkts/Bytes)  FP-Up (Pkts/Bytes)
-----
Dynamic Rule Match stats:
PDR Id  Rule Name          Pkts-Down  Bytes-Down Pkts-Up   Bytes-Up   Hits
Match-Bypassed  FP-Down (Pkts/Bytes)  FP-Up (Pkts/Bytes)
-----
Post-Processing Rule Match stats:
Rule Name          Pkts-Down  Bytes-Down Pkts-Up   Bytes-Up   Hits      Match-Bypassed
  FP-Down (Pkts/Bytes)  FP-Up (Pkts/Bytes)
-----
Firewall-NAT Access Rule Match stats:
Firewall-Ruledef Name Pkts-Down  Bytes-Down  Pkts-Up   Bytes-Up  Dr-Pkts-Dn  Dr-Byts-Dn
Dr-Pkts-Up  Dr-Byts-Up      Hits
-----

```

show subscribers user-plane-only full msid msid_value

```

-----
QoS-Group Statistics:
QGR Name          Pkts-Down Bytes-Down Pkts-Up   Bytes-Up   Hits       Match-Bypassed
  FP-Down(Pkts/Bytes)  FP-Up(Pkts/Bytes)
-----
-----

CIoT APN Rate Control:
  Allowed UL Limit: 0                Allowed DL limit: 0
  Remaining UL Limit: 0              Remaining DL limit: 0
  Allowed Time unit: unrestricted    Status Validity Time: N/A

Local SEID       : [0x0004000000000002] 1125899906842626
Remote SEID      : [0x0004000000000009] 1125899906842633
State            : Connected
Connect Time     : Thu Sep 15 20:51:03 2022
Idle time        : 00h00m31s
Access Type:     uplane-ipv4           Network Type: IP
user-plane-service-name: UP21
active-service-scheme-name:
Callid: 00004e23
Rulebase: cisco
Interface Type: Sxb
eMPS Session: No
eMPS Session Priority: 0
Card/Cpu: 1/0
IP address: 11.11.12.1
Next Hop Ip Address:
Source context: EPC2-UP                Destination context: ISPL-UP
PDN-Instance: starent.com
User-plane-Sx-addr: 20.20.20.106
Control-plane-Sx-addr: 20.20.20.101
Number of associated PDRs : 0
Number of associated ADC PDRs : 0
Number of associated FARS : 0
Number of associated QERs : 1
Number of associated BARS : 0
Number of associated URRs : 0
Uplink APN AMBR (bps) : 200000        Downlink APN AMBR (bps) : 200000
active input acl: IPV4ACL              active output acl: IPV4ACL
active input ipv6 acl: n/a             active output ipv6 acl: n/a
Bandwidth Policy: bw_policy1
FW-and-NAT Policy: n/a
FW-and-NAT Policy ID: n/a
Firewall Policy IPv4: n/a
Firewall Policy IPv6: n/a
NAT Policy NAT44: n/a
NAT Policy NAT64: n/a
Converged Session: No                  Converged Peer Callid: n/a
Visited Call: No
Subscriber Parameters:
IMSI: 404005123456789
IMEI: 112233445566778
MSISDN: 9890098900
Charging Characteristics: 0x3412
Rat Type: 6
MCC MNC: 123765
SGSN Address: 20.20.20.61
ULI: TAI=12546312ab00
Congestion Level: 0
GGSN Address: 20.20.20.101
User-Name: 9890098900@starent.com
Session-ID: 1414146500000000A

```

```

input pkts: 0
input bytes: 0
input bytes dropped: 0
input pkts dropped: 0
CF Buffered Uplink Packets: 0

CF Buffered Uplink Bytes: 0
Uplink Packets in Buffer: 0
Buff Over-limit Uplink Pkts: 0

DDN buffered pkts : 0
DDN buffer overflow drop pkts : 0

pk rate from user(bps): 0
ave rate from user(bps): 0
sust rate from user(bps): 0
pk rate from user(pps): 0
ave rate from user(pps): 0
sust rate from user(pps): 0
ipv4 bad hdr: 0
ipv4 fragments sent: 0
ipv4 bad length trim: 0
input pkts dropped (0 mbr): 0
ipv4 input acl drop: 0
ipv6 input acl drop: 0
ip source violations: 0
ipv6 bad hdr: 0
ipv4 icmp packets dropped: 0
APN AMBR Uplink Pkts Drop: 0
APN AMBR Uplink Bytes Drop: 0

APN AMBR Uplink Pkts IP pref lowered: 0
0
APN AMBR Uplink Bytes IP pref lowered: 0
0
ITC Uplink Pkts Drop: 0
ITC Uplink Bytes Drop: 0
ITC Uplink Pkts IP pref lowered: 0

ITC Uplink Bytes IP pref lowered: 0

ITC Terminated Flows:: 0
Flow Action Terminated Flows: 0

ToS marked Uplink Pkts: 0
CC Dropped Uplink Pkts: 0
CC Dropped Uplink bytes: 0
Uplink Inflight Pkts: 0
QFI Mismatch Uplink Pkts Drop: 0

Total QoS-Group(s) Active: 0
DNS-to-EDNS Uplink Pkts: 0
EDNS Response Received: 0

Flow information:
  Current Active Flows:
    TCP: 0
    UDP: 0
  Total Flows:
    TCP: 0
    UDP: 0
    FP: 0

Static & Predef Rule Match stats:

output pkts: 0
output bytes: 0
output bytes dropped: 0
output pkts dropped: 0
CF Buffered Downlink Packets: 0

CF Buffered Downlink Bytes: 0
Downlink Packets in Buffer: 0
Buff Over-limit Downlink Pkts: 0

DDN buffered bytes : 0
DDN buffer overflow drop bytes : 0

pk rate to user(bps): 0
ave rate to user(bps): 0
sust rate to user(bps): 0
pk rate to user(pps): 0
ave rate to user(pps): 0
sust rate to user(pps): 0
ipv4 ttl exceeded: 0
ipv4 could not fragment: 0

output pkts dropped (0 mbr): 0
ipv4 output acl drop: 0
ipv6 output acl drop: 0
ipv4 output no-flow drop: 0
ipv6 bad length trim: 0

APN AMBR Downlink Pkts Drop: 0
APN AMBR Downlink Bytes Drop: 0

APN AMBR Downlink Pkts IP pref lowered:
APN AMBR Downlink Bytes IP pref lowered:

ITC Downlink Pkts Drop: 0
ITC Downlink Bytes Drop: 0
ITC Downlink Pkts IP pref lowered: 0

ITC Downlink Bytes IP pref lowered: 0

ITC Redirected Flows: 0
Flow Action Redirected Flows: 0

ToS marked Downlink Pkts: 0
CC Dropped Downlink Pkts: 0
CC Dropped Downlink Bytes: 0
Downlink Inflight Pkts: 0
QFI Mismatch Downlink Pkts Drop: 0

DNS-to-EDNS Uplink Bytes: 0
    
```

```

Rule Name          Pkts-Down Bytes-Down Pkts-Up   Bytes-Up   Hits       Match-Bypassed
FP-Down(Pkts/Bytes) FP-Up(Pkts/Bytes)
-----
-----

Dynamic Rule Match stats:
PDR Id   Rule Name          Pkts-Down Bytes-Down Pkts-Up   Bytes-Up   Hits
Match-Bypassed FP-Down(Pkts/Bytes) FP-Up(Pkts/Bytes)
-----
-----

Post-Processing Rule Match stats:
Rule Name          Pkts-Down Bytes-Down Pkts-Up   Bytes-Up   Hits       Match-Bypassed
FP-Down(Pkts/Bytes) FP-Up(Pkts/Bytes)
-----
-----

Firewall-NAT Access Rule Match stats:
Firewall-Ruledef Name Pkts-Down Bytes-Down   Pkts-Up   Bytes-Up Dr-Pkts-Dn Dr-Byts-Dn
Dr-Pkts-Up Dr-Byts-Up       Hits
-----
-----

QoS-Group Statistics:
QGR Name          Pkts-Down Bytes-Down Pkts-Up   Bytes-Up   Hits       Match-Bypassed
FP-Down(Pkts/Bytes) FP-Up(Pkts/Bytes)
-----
-----

CIoT APN Rate Control:
  Allowed UL Limit: 0                Allowed DL limit: 0
  Remaining UL Limit: 0              Remaining DL limit: 0
  Allowed Time unit: unrestricted    Status Validity Time: N/A

Total subscribers matching specified criteria: 1

```

VPP Statistics

To determine if the flows are offloaded to VPP, check for Fastpath statistics in the output of the following CLI commands:

- **show user-plane-service statistics all**
- **show user-plane-service statistics analyzer name ip [verbose]**
- **show user-plane-service statistics analyzer name ipv6 [verbose]**
- **show user-plane-service statistics analyzer name tcp [verbose]**
- **show user-plane-service statistics analyzer name udp [verbose]**
- **show user-plane-service statistics analyzer name http [verbose]**
- **show user-plane-service statistics analyzer name rtp [verbose]**
- **show subscribers user-plane-only full callid *call_id***
- **show subscribers user-plane-only callid *callid_value* drop-statistics**
- **show user-plane-service statistics drop-counter**

- show subscribers user-plane-only callid *callid_value* flows full
- show subscribers user-plane-only callid *callid_value* flows flow-id *flow_id*

show subscribers user-plane-only callid *callid_value* drop-statistics

The **show subscribers user-plane-only callid *callid_value* drop-statistics** command displays the packet drop statistics with the respective cause (drop reason) at instance-level and session-level.

The following is a sample output of this command:

```
[local]UPF1# show subscribers user-plane-only callid 00004e21 drop-statistics

Callid: 00004e21
Interface Type: <interface-type>

Packet Drop Data Statistics:
-----
NAT packets processing failure
  NAT on demand handling:                0
  ICMP Packet translation:                0
FIREWALL packets processing failure
  Policy not found:                       0
No Matching GX rule found:               0
Flow apply action
  Discard:                                0
  Readdress Failure:                     0
  Packet exceeds the MTU size:            0
Failure in processing FAR Buffer packets: 0
FAR Apply Action Drop:                   0
Traffic Steering Failure:                 0
QER Gate Status Closed:                  0
Content-filtering Discard Action:         0
IP Header Validation Failed:              0
ADF level failure
  DL TFT mismatch:                       0
URL Blacklisting Discard Action:          0
QGR Flow Action SGQ Discard:              0
QGR Policer Drops:                       0

Total subscribers matching specified criteria: 1
[local]UPF1#
```

show user-plane-service statistics drop-counter

The **show user-plane-service statistics drop-counter** command displays the packet drop statistics with the respective cause (drop reason) at instance-level and session-level.

The following is a sample output of this command:

```
[local]UPF1# show user-plane-service statistics drop-counter

Packet Drop Data Statistics:
-----
NAT packets processing failure
  NAT on demand handling:                0
  IP allocation is in progress:           0
  ICMP Packet translation:                0
FIREWALL packets processing failure
  Policy not found:                       0
```

show subscribers user-plane-only callid callid_value flows full

```

No Matching GX rule found: 0
Flow apply action
  Discard: 0
  Readdress Failure: 0
  Redirect-URL: 0
Packet exceeds the MTU size: 0
Failure in processing FAR Buffer packets: 0
FAR Apply Action Drop: 0
Traffic Steering Failure: 0
QER Gate Status Closed: 0
Content-filtering Discard Action: 0
IP Header Validation Failed: 0
ADF level failure
  UL TEID/QFI key mismatch: 0
  DL TFT mismatch: 0
  DL QFI mismatch: 0
URL Blacklisting Discard Action: 0
DDN buffer overflow drop packets: 0
APN AMBR Packets Drop: 0
ITC Packets Drop: 0
ACL Drop: 0
CC Dropped Packets: 0
FastPath Misc Drops
  Overload Protection: 0
  Invalid Client: 0
  Stream ID 0: 0
  Invalid Stream ID: 0

```

NOTES:

- For the **show user-plane-service statistics drop-counter** CLI command, the counters for the number of packets dropped due to various reasons are not recovered post sessmgr recovery or ICSR (Inter-Chassis Session Recovery).
- For the **show subscribers user-plane-only callid callid_value drop-statistics** CLI command, the counters for the number of packets dropped due to various reasons are recovered post sessmgr recovery or ICSR.
- The commands do not duplicate the counters that are captured at the session-level and instance-level.
- The packets dropped due to "Quota Exhaust FAR Apply Action Drop" are accumulated under "CC Dropped Packets" and not under the "FAR Apply Action Drop" counter.
- The packets dropped under "Failure in processing FAR buffered packets" can be due to "no rule match", "teid not found", or other reasons. The respective counter are incremented for such packets.
- The packets dropped due to the "redirect-url" flow action are accumulated under "Redirect-URL" in the **show user-plane-service statistics drop-counter** CLI command.

show subscribers user-plane-only callid callid_value flows full

The **show subscribers user-plane-only callid callid_value flows full** command displays the detailed information at the flow level which are required for debugging purposes.

The following is a sample output of this command:

```

[local]GVK-HUPF# show subscribers user-plane-only callid 017dc662 flows full
Tuesday November 22 18:35:35 UTC 2022

Callid: 017dc662
Interface Type: N4
IP address: n/a

```

```
Flow ID: 6:2
Uplink pkts: 0 Downlink pkts: 1
Uplink bytes: 0 Downlink bytes: 1040
Fast Path Info:
Uplink pkts: 0 Downlink pkts: 0
Uplink bytes: 0 Downlink bytes: 0
Total pkts: 0
Uplink Dropped pkts: 0 Downlink Dropped pkts: 4
Uplink Stream ID: 0x0 Downlink Stream ID: 0x1000007
Uplink Stream State: n/a Downlink Stream State: Passive
Client-ID : C6
UE IP address: 12.1.0.3 UE Port: 1001
Server IP address: 100.100.100.10 Server Port: 1001
Protocol: TCP
Service Chain Name: NA
Uplink Sfp Id: NA
Downlink Sfp Id: NA
```

```
Flow ID: 6:3
Uplink pkts: 5 Downlink pkts: 2
Uplink bytes: 200 Downlink bytes: 2080
Fast Path Info:
Uplink pkts: 0 Downlink pkts: 3
Uplink bytes: 0 Downlink bytes: 3120
Total pkts: 3
Uplink Dropped pkts: 0 Downlink Dropped pkts: 0
Uplink Stream ID: 0x0 Downlink Stream ID: 0x2000008
Uplink Stream State: n/a Downlink Stream State: Active
Client-ID : C6
UE IP address: 12.1.0.3 UE Port: 1000
Server IP address: 100.100.100.10 Server Port: 1000
Protocol: TCP
Service Chain Name: NA
Uplink Sfp Id: NA
Downlink Sfp Id: NA
```

Total Number of Active flows : 2

show subscribers user-plane-only callid *callid_value* flows flow-id *flow_id*

The **show subscribers user-plane-only callid *callid_value* flows flow-id *flow_id*** command displays the detailed information at the flow level which are required for debugging purposes.

The following is a sample output of this command:

```
# show sub user-plane-only callid 00004e22 flows flow-id 1:4

Callid: 00004e22
Interface Type: Sxb
IP address: n/a

Flow ID: 1:4
Uplink pkts: 17                               Downlink pkts: 0
Uplink bytes: 1026                             Downlink bytes: 0
Fast Path Info:
Uplink pkts: 0                               Downlink pkts: 0
Uplink bytes: 0                               Downlink bytes: 0
Total pkts: 0
Uplink Dropped pkts: 0                       Downlink Dropped pkts: 0
Uplink Stream ID: 0x00000008                 Downlink Stream ID: 0x0
Uplink Stream State: Passive                 Downlink Stream State: n/a
Client-ID : C2
```

```
UE IP address: 12.2.0.13           UE Port: 1007
Server IP address: 100.100.100.10  Server Port: 1005
Protocol: TCP
Service Chain Name: NA
Uplink Sfp Id: NA
Downlink Sfp Id: NA
```

Total Number of Active flows : 1

SNMP Support

The system uses the Simple Network Management Protocol (SNMP) to send traps or events to the EMS server or an alarm server on the network. You must configure SNMP settings to communicate with those devices.

The *SNMP MIB Reference* describes the MIBs and SNMP traps that are supported by UPF and StarOS.

The following SNMP traps are available in support of their respective feature or functionality:

N4 Session/Node Level Reporting Procedure

The following traps are available to track status and conditions GTP-U path failure:

- EGTPUPathFailure: This trap is generated when no response is received for GTP-U ECHO requests and data path failure is detected toward peer EPC Node.
- EGTPUPathFailureClear: This trap is generated when the data path toward the peer node is available.

UP Session Recovery

The following traps are available after session recovery in the User Plane node:

- ManagerFailure: This trap is generated when there is failure in the Software manager.
- TaskFailed: This trap is generated when a noncritical task has failed and the appropriate recovery steps begin.
- TaskRestart: This trap is generated when a noncritical task has restarted after an earlier failure.
- SessMgrRecoveryComplete: This trap is generated when Session Manager recovery completes. This is typically caused by the failure of Session Manager task and successful completion of recovery.
- ManagerRestart: This trap is generated when the identified manager task has been restarted.

Sx Association

The following traps are available to track the status of an Sx Association:

- SxPeerAssociated: This trap is triggered when an Sx association is detected.
- SxPeerAssociationRelease: This trap is triggered when an Sx association release is detected.

URL Blockedlisting

The following SNMP trap are available in support of URL Blockedlisting feature:

- BLDBError: Specifies the blockedlisting OPTBLDB file error that is displayed with an error code.
- BLDBErrorClear: Specifies the blockedlisting OPTBLDB file error removed.
- BLDBUpgradeError: Specifies the blockedlisting OPTBLDB file error displayed with an error code.

- **BLDBUpgradeErrorClear**: Specifies the blockedlisting OPTBLDB file error removed.

Enabling SNMP Traps

Use the following configuration to enable an SNMP trap.

```
configure
  snmp trap enable trap_name
end
```

For supplemental information about SNMP Support, see *Management Settings* chapter in the *ASR 5500 System Administration Guide*.

Troubleshooting UPF Features

N4 or Datapath

The following CLI commands are available for troubleshooting N4 or datapath related issues:

- **show gtpu statistics**
- **show user-plane-service** { **all** | **bandwidth-policy** | **charging-action** | **edr-format** | **group-of-ruledefs** | **gtp-group** | **name** | **pdn-instance** | **rulebase** | **ruledef** | **statistics** | **xheader-format** }

NOTES:

- **all**: Displays all User Plane services.
- **bandwidth-policy**: Displays information for bandwidth-policy in User Plane service.
- **charging-action**: Displays information for Charging actions in User Plane service.
- **edr-format**: Displays information for EDR format in user Plane service.
- **group-of-ruledefs**: Displays information on Group of Ruledefs configured in User Plane service.
- **gtp-group**: Displays information for bandwidth policy in User Plane service.
- **name**: Displays information for specific User Plane service name.
- **pdn-instance**: Displays information for PDN instance.
- **rulebase**: Displays information for rulebase in User Plane service.
- **ruledef**: Displays information for ruledef in User Plane service.
- **statistics**: Displays node-level statistics for User Plane.

Additionally, you can also use: **show user-plane-service statistics** { **all** | **analyzer** | **charging-action** | **fapi** | **rulebase** | **tethering-detection** }

- **xheader-format**: Displays information for X-Header format in User Plane service.
- **show user-plane-service content-filtering category policy-id** (**all** | **id id_value**)
 - **content-filtering**: Displays content filtering information.

- **category**: Displays content filtering category information.
- **policy-id**: Displays content filtering category Policy-ID and its definition.
- **all**: Displays definitions of all content filtering category policies.
- **id *id_value***: Displays content filtering category definition of a particular Policy-ID. *id_value* is an integer ranging from 1 through 4,294,967,295.

• **show sx-service { all | name | statistics }**

NOTES:

- **all**: Displays all Sx Services.
- **name**: Displays information for specific Sx Service name.
- **statistics**: Displays the total of collected information for specific protocol since last restart or clear command.

Content Filtering

Use the following CLI command for troubleshooting CF related issues:

In releases prior to 2022.01.0:

```
show user-plane-service inline-services { content-filtering | info | url-blacklisting }
```

From 2022.01.0 and later releases:

```
show user-plane-service inline-services { content-filtering | info | url-blockedlisting }
```

NOTES:

- **content-filtering**: Displays content filtering information.
- **info**: Displays information of inline services.
- **url-blockedlisting**: Displays URL Blockedlisting parameters in User Plane service.

URL Blacklisting

Use the following CLI command for troubleshooting URL Blacklisting related issues: **show user-plane-service url-blacklisting database { all | debug-only | facility | url }**

NOTES:

- **all**: Displays all URL Blacklisting database configurations.
- **debug-only**: Displays the URL Blacklisting static database debug information.
- **facility**: Displays URL Blacklisting database configuration per facility.
- **url**: Displays particular database information for URL Blacklisting.



PART **III**

UPF Sample Basic Configuration

- [Sample UPF Configuration, on page 551](#)



CHAPTER 57

Sample UPF Configuration

- [Sample Configuration, on page 551](#)

Sample Configuration

The following is only a sample configuration file provided solely for your reference. You must create and modify your own configuration file according to the specific needs of your deployment.

```
----- snip -----
  active-charging service acs
  bandwidth-policy BWP
    flow limit-for-bandwidth id 1 group-id 2
    flow limit-for-bandwidth id 2 group-id 3
    flow limit-for-bandwidth id 100 group-id 100
  group-id 2 direction uplink peak-data-rate 256000 peak-burst-size 1000 violate-action
  discard
  group-id 2 direction downlink peak-data-rate 200000 peak-burst-size 1000 violate-action
  discard
  group-id 3 direction downlink peak-data-rate 256000 peak-burst-size 1000 violate-action
  discard
  group-id 4 direction uplink peak-data-rate 300000 peak-burst-size 1200 violate-action
  lower-ip-precedence
  group-id 100 direction downlink peak-data-rate-kbps 4294967295 peak-burst-size
  4294967295 violate-action discard

  ruledef L3_SERVER
    ip server-ip-address = 209.165.202.150/27
    tcp either-port = 80
  #exit
  ruledef L4_PORT
    tcp either-port = 80
    udp either-port = 80
    multi-line-or all-lines
  #exit
  ruledef L7_HTTP
    http host contains 209.165.202.150
    multi-line-or all-lines
  #exit
  ruledef http-pkts
    http any-match = TRUE
  #exit
  ruledef http-port
    tcp either-port = 80
    rule-application routing
  #exit
```

```

ruledef ip-any-rule
    ip any-match = TRUE
#exit
urr-list urrs
    rating-group 10 urr-id 5
#exit
charging-action starent
    content-id 10
    billing-action egcdr
#exit
rulebase default
#exit
credit-control group default
    pending-traffic-treatment noquota buffer
    pending-traffic-treatment quota-exhausted pass
    usage-reporting quotas-to-report based-on-grant

rulebase starent
    billing-records egcdr
    dynamic-rule order first-if-tied
    action priority 5 ruledef http-pkts charging-action standard
    action priority 10 ruledef L7_HTTP charging-action starent
    action priority 20 ruledef L4_PORT charging-action starent
    action priority 100 ruledef L3_SERVER charging-action starent
    action priority 10000 ruledef ip-any-rule charging-action starent
    route priority 1 ruledef http-port analyzer http
    egcdr threshold interval 1000
    bandwidth default-policy BWP
#exit
traffic-optimization-policy default
#exit
#exit
context ingress
    interface N3_interface
        ip address 209.165.201.4 209.165.201.5
        ipv6 address abc0:0:0:cb::1/64 secondary
    #exit
    interface N3_interface_LOGICAL loopback
        ip address 209.165.201.4 209.165.201.5
    #exit
    interface N3_interface_LOGICAL2 loopback
        ip address 209.165.201.4 209.165.201.5
    #exit
    interface N4U_interface
        ip address 209.165.201.4 209.165.201.5
        ipv6 address abc0:0:0:cd::1/64 secondary
        ipv6 address abc0:0:0:ca::1/64 secondary
    #exit
    interface N4U_interface_LOGICAL loopback
        ip address 209.165.201.4 209.165.201.5
    #exit
    interface N4_interface
        ip address 209.165.201.4 209.165.201.5
        ipv6 address abc0:0:0:cc::1/64 secondary
    #exit
    interface N4_interface_LOGICAL loopback
        ip address 209.165.201.4 209.165.201.5
    #exit
    subscriber default
    exit
    aaa group default
    #exit
    gtpv group default
    #exit

```

```

gtpu-service N3-GNB1
  bind ipv4-address 209.165.200.225
exit
gtpu-service N3-GNB2
  bind ipv4-address 209.165.201.4
exit
gtpu-service control_gtpu
  bind ipv4-address 209.165.201.4
exit
sx-service N4
  instance-type userplane
  bind ipv4-address 209.165.201.4
  sx-protocol heartbeat interval 3600
  sx-protocol heartbeat max-retransmissions 1
  sx-protocol association reattempt-timeout 30
exit
user-plane-service user-plane-service
  associate gtpu-service N3-GNB1 upf-ingress
  associate gtpu-service control_gtpu cp-tunnel
  associate sx-service N4
  associate fast-path service
  associate control-plane-group default
  load-control capacity 900
exit
user-plane-service user-plane-service1
exit
ip route 209.165.201.4 209.165.201.5 209.165.201.6 N4_interface
ip route 209.165.201.4 209.165.201.5 209.165.201.6 N4_interface
ip route 209.165.201.4 209.165.201.5 209.165.201.6 N3_interface
ip route 209.165.201.4 209.165.201.5 209.165.201.6 N3_interface
ip route 209.165.201.4 209.165.201.5 209.165.201.6 N4_interface
ip route 209.165.201.4 209.165.201.5 209.165.201.6 N3_interface
ip route 209.165.201.4 209.165.201.5 209.165.201.6 N4_interface
ip route 209.165.201.4 209.165.201.5 209.165.201.6 N3_interface
#exit
context egress
  interface N6_interface
    ip address 209.165.201.4 209.165.201.5
    ipv6 address abc0:0:0:cf::1/64 secondary
  #exit
  subscriber default
  exit
  apn starent.com
  pdp-type ipv4 ipv6
  selection-mode subscribed sent-by-ms chosen-by-sgsn
  gtp group default accounting-context egress
  ip context-name egress
  active-charging rulebase starent
  exit
  aaa group default
  #exit
  gtp group default
  gtp attribute local-record-sequence-number
  gtp dictionary custom24
  gtp egcdr service-data-flow threshold interval 60
  gtp egcdr service-data-flow threshold volume downlink 13000
  gtp egcdr service-data-flow threshold volume uplink 17000
  gtp egcdr service-data-flow threshold volume total 22222
  #exit
  ipv6 route 2:2:2:2::/64 next-hop abc0::ab:1c:2ff:def9:1ad interface N6_interface
  ip route 209.165.201.4 209.165.201.5 209.165.201.6 N6_interface
  ip route 209.165.201.4 209.165.201.5 209.165.201.6 N6_interface
  ipv6 route 2:2:2:2::/64 next-hop abc0::ab:1c:2ff:def9:1ab interface N6_interface
  ip route 209.165.201.4 209.165.201.5 209.165.201.6 N6_interface

```

```
#exit
control-plane-group default
  sx-association initiated-by-cp
  peer-node-id ipv4-address 209.165.200.225 interface n4
#exit
user-plane-group default
#exit
port ethernet 1/11
  no shutdown
  vlan 203
    no shutdown
    bind interface N4U_interface ingress
  #exit
  vlan 204
    no shutdown
    bind interface N4_interface ingress
  #exit
  vlan 205
    no shutdown
    bind interface N3_interface ingress
  #exit
  vlan 206
    no shutdown
  #exit
  vlan 207
    no shutdown
    bind interface N6_interface egress
  #exit
#exit
end
```