



# CHAPTER 21

## Cisco Voice Messaging

---

**Revised: April 30, 2013; OL-27282-05**

This chapter describes the voice messaging solutions available in the Cisco Unified Communications System. It includes the Cisco voice messaging products Cisco Unity Connection and Cisco Unity Express, and it covers the design guidelines and best practices for deploying these products together with Cisco Unified Communications Manager (Unified CM). This chapter also covers aspects of integration with third-party voicemail systems using industry standard protocols.

Although this guide focuses on the messaging deployment scenarios with regard to Unified CM, Cisco Unified Communications Manager Express (Unified CME) is also noted where applicable, especially when used with Survivable Remote Site Telephony (SRST) fallback support in a centralized Unified CM deployment.

This chapter covers the following topics:

- [Voice Messaging Portfolio, page 21-2](#)
- [Messaging Deployment Models, page 21-4](#)
- [Messaging and Unified CM Deployment Model Combinations, page 21-6](#)
- [Voicemail Networking, page 21-26](#)
- [Best Practices for Voice Messaging, page 21-28](#)
- [Third-Party Voicemail Design, page 21-44](#)

The chapter begins with a short description of each of the products in the Cisco messaging solutions portfolio and provides a simple overview of where each product fits in an enterprise Unified Communications solution. Next, messaging deployment models form the basis of discussion for voicemail integrations, which start with a definition of the various messaging deployment models and then explain how each of the messaging deployment models fits into the various Unified CM call processing deployment models. Cisco Unity Connection is discussed in this section, while Cisco Unity Express has a dedicated section for its supported deployment models. Key design guidelines are covered for interoperability available within the Cisco Voice Messaging product portfolio. Virtualization, a new concept, is covered along with the important design factors to be considered while designing the virtual system. Many system-level design considerations and best practices, including transcoding and various integrations with Cisco Unified Communications Manager, are explained in this section. In addition, this chapter provides details on third-party voicemail integration for supported industry-standard protocols.

This chapter presents a high-level design discussion and is focused on how the voice messaging products fit into the Unified Communications System with Unified CM. For detailed design guidelines for each product as well as interoperability information for third-party messaging and telephony systems, refer to the Cisco Unity Connection design guides, available at

[http://www.cisco.com/en/US/products/ps6509/products\\_implementation\\_design\\_guides\\_list.html](http://www.cisco.com/en/US/products/ps6509/products_implementation_design_guides_list.html)

## What's New in This Chapter

Table 21-1 lists the topics that are new in this chapter or that have changed significantly from previous releases of this document.

**Table 21-1** New or Changed Information Since the Previous Release of This Document

New or Revised Topic	Described in:	Revision Date
A few minor updates	Various sections	April 30, 2013
Various updates for Cisco Unified Communications System Release 9.0	Numerous sections throughout this chapter	June 28, 2012

## Voice Messaging Portfolio

The Cisco Unified Communications messaging portfolio consists of two main messaging products: Cisco Unity Connection and Cisco Unity Express. Each product fits different requirements yet each one contains overlapping features and scalability with regard to the others. They also have the ability to interwork with one another using Voice Mail Networking to achieve voicemail interoperability as well as higher scalability, as discussed later in this chapter.

When considering these products, it helps to think of the messaging types that the products apply to in order to understand the messaging options they include and to determine which options could fit your deployment requirements. The following definitions help describe these messaging types:

- *Voicemail-only* refers to a telephony voicemail integration where there is no access to the voicemail via any messaging client.
- *Integrated messaging* refers to voicemail with telephony access as well as voicemail-only access via a messaging client.
- *Unified messaging* refers to voicemail with telephony access as well as voicemail, email, and fax access via a messaging client.

Table 21-2 shows which Cisco products support these types of messaging.

**Table 21-2** Supported Messaging Environments per Product

Messaging Type	Cisco Unity Connection	Cisco Unity Express
Voicemail-only	Yes	Yes
Integrated messaging	Yes	Yes
Unified messaging	Yes	No

**Note**

For further details on Unified Messaging with Cisco Unity Connection, see [Single Inbox with Cisco Unity Connection, page 21-40](#).

Based on the above messaging types and definitions, the two messaging product options are:

- Cisco Unity Connection

This option combines unified/integrated messaging, voice recognition, and call transfer rules into an easy-to-manage system for medium-sized businesses with up to 20,000 users, or it can network up to 10 nodes in a digital network system. (Additionally, if required, a maximum of two digital networks can be joined to support a maximum of 20 nodes.) Cisco Unity Connection can support up to 100,000 users or contacts in a digital network. For organizations with up to 500 users, Cisco Unity Connection is available as a single-server solution with Cisco Business Edition 3000 and 5000. For more information on Cisco Business Edition, see [Design Considerations for Call Processing, page 8-28](#).

- Cisco Unity Express

This option provides cost-effective voice and integrated messaging, automated attendant, and interactive voice response (IVR) capabilities in certain Cisco Integrated Services Routers for small and medium-sized businesses and enterprise branch offices with up to 500 users.

For a complete comparison of product feature, refer to the *Cisco Messaging Products: Feature Comparison*, available at

[http://www.cisco.com/en/US/products/sw/voicesw/ps2237/products\\_data\\_sheets\\_list.html](http://www.cisco.com/en/US/products/sw/voicesw/ps2237/products_data_sheets_list.html).

Table 21-3 gives a brief product comparison with regard to scalability.

**Table 21-3 Scalability of Voice Messaging Solutions**

Solutions	Users supported on a single server (or failover or clustered deployment)			Maximum number of users supported in a digital networking solution	
	500	15,000	20,000	100,000	250,000
Cisco Unity Express	Y	N	N	Y	Y
Cisco Business Edition	Y	N	N	N	N
Cisco Unity Connection (Unified/Integrated Messaging)	Y	Y	Y	Y	N

**Note**

In addition to providing an increase in the maximum number of supported users, Digital Networking provides server discovery and directory synchronization functionality.

This chapter focuses on the design aspects of integrating Cisco Unity Connection and Cisco Unity Express with Cisco Unified Communications Manager (Unified CM). Cisco Unified CM provides functionality for Session Initiation Protocol (SIP) trunks, which support integration directly to Cisco Unity Connection without the need for a SIP proxy server.

For information on earlier releases of Cisco Unity Connection, Unity Express, and Unified CM or Unified CM Express, refer to the appropriate online product documentation available at <http://www.cisco.com>.

As mentioned, the design topics covered in this chapter apply to voicemail-only, unified messaging, and integrated messaging configurations. Additionally, this chapter discusses design aspects of deploying Cisco Unity Connection with Microsoft Exchange (2003, 2007, or 2010). Cisco Unity Connection and Unity Express have no dependencies on an external message store.

For additional design information about Cisco Unity Connection, including integrations with other non-Cisco messaging systems, refer to the *Design Guide for Cisco Unity Connection*, available at <http://www.cisco.com>.

For additional design information about Cisco Unity Express, including integrations with other non-Cisco messaging systems, refer to the applicable product documentation, available at <http://www.cisco.com>.

## Messaging Deployment Models

This section summarizes the various messaging deployment models for Cisco Unity Connection and Cisco Unity Express. For a complete discussion of the deployment models and design considerations specific to Cisco Unity Connection and the various messaging components, refer to the *Design Guide for Cisco Unity Connection*, available at <http://www.cisco.com>. For Cisco Unity Express, refer to the applicable product documentation available at <http://www.cisco.com>.

Cisco Unity Connection supports three primary messaging deployment models:

- Single-site messaging
- Multisite deployment with centralized messaging
- Multisite deployment with distributed messaging

Cisco Unity Express also supports three primary messaging deployment models:

- Single-site messaging
- Multisite deployment with distributed messaging
- Multisite deployment with distributed messaging with Cisco Unified CME

**Note**

---

The Cisco Unity Express supports centralized voice messaging for up to 10 Unified CMEs. For more information, refer to the Cisco Unified Communications Manager Express documentation on <http://www.cisco.com>.

---

Although the call processing deployment models for Cisco Unified CM and Unified CME are independent of the messaging deployment models for Cisco Unity Connection and Unity Express, each has implications toward the other that must be considered.

Cisco Unity Connection messaging redundancy is available in an active/active configuration. For more information, refer to the *Design Guide for Cisco Unity Connection* available on <http://www.cisco.com>.

All messaging deployment models support voicemail, integrated messaging, and unified messaging installations.

## Single-Site Messaging

In this model, the messaging systems and messaging infrastructure components are all located at the same site, on the same highly available LAN. The site can be either a single site or a campus site interconnected via high-speed metropolitan area networks (MANs). All clients of the messaging system are also located at the single (or campus) site. The key distinguishing feature of this model is that there are no remote clients.

## Centralized Messaging

In this model, similar to the single-site model, all the messaging system and messaging infrastructure components are located at the same site. The site can be one physical site or a campus site interconnected via high-speed MANs. However, unlike the single-site model, centralized messaging clients can be located both locally and remotely.

## Distributed Messaging

A distributed messaging model consists of multiple single-site messaging systems distributed with a common messaging backbone. There can be multiple locations, each with its own messaging system and messaging infrastructure components. All client access is local to each messaging system, and the messaging systems share a messaging backbone that spans all locations. Message delivery from the distributed messaging systems occurs via the messaging backbone through a full-mesh or hub-and-spoke type of message routing infrastructure. No messaging infrastructure components should be separated by a WAN from the messaging system they service.

Distributed messaging is essentially multiple, single-site messaging models with a common messaging backbone. The exception to this rule is the PBX-IP Media Gateway (PIMG) and T1-IP Media Gateway (TIMG) integrations. PIMG and TIMG integrations are not discussed in this design document. For further information regarding PIMG or TIMG, refer to the Cisco Unity Connection integration guides available on <http://www.cisco.com>.

The distributed messaging model has the same design criteria as centralized messaging with regard to local and remote GUI clients, TRaP, and message downloads.

# Messaging and Unified CM Deployment Model Combinations

This section discusses the design considerations for integrating the various messaging deployment models with the Unified CM call processing deployment models. Table 21-4 lists the various combinations of messaging and call processing deployment models supported by Cisco Unity Connection and Unity Express.

**Table 21-4** *Supported Combinations of Messaging and Unified CM Call Processing Deployment Models*

Model Type	Cisco Unity Connection	Cisco Unity Express
Single-site messaging and single-site call processing	Yes	Yes
Centralized messaging and centralized call processing	Yes	No <sup>1</sup>
Distributed messaging and centralized call processing	Yes	Yes
Centralized messaging and distributed call processing	Yes	No <sup>1</sup>
Distributed messaging and distributed call processing	Yes	Yes
Centralized messaging with cluster over the WAN	Yes	No
Distributed messaging with cluster over the WAN	Yes	Yes

1. Support for centralized voicemail messaging with Unified CME is available starting with Cisco Unity Express 3.2; however, this is not applicable to Unified CM call processing deployment models.

This section covers the following topics:

- Cisco Unity Connection messaging and Unified CM deployment models
- Cisco Unity Express deployment models

Each topic defines a messaging and Unified CM deployment model combination and then highlights each Cisco voicemail messaging product applicable to that model as well as the design considerations for that model combination. Not all combinations are discussed for each product. Some examples are provided, with best practices and design considerations for each product. The intention is to provide an understanding of the base messaging deployment models and the interaction with Unified CM without detailing all possibilities.

Refer to the *Design Guide for Cisco Unity Connection*, available at <http://www.cisco.com>, for further details on site classification and a detailed analysis of supported combinations of messaging and call processing deployment models.

## Cisco Unity Connection Messaging and Unified CM Deployment Models

This section discusses some of the various combinations of messaging and call processing deployment models for Cisco Unity Connection.

### Centralized Messaging and Centralized Call Processing

In centralized messaging, the voice messaging server is located in the same site as the Unified CM cluster. With centralized call processing, subscribers may be located either remotely and/or locally to the cluster and messaging server(s). (See [Figure 21-1](#).) When remote users access resources at the central site (such as voice ports, IP phones, or PSTN gateways, as in Tail-End Hop-Off (TEHO)), these calls are transparent to gatekeeper call admission control. Therefore, regions and locations must be configured in Unified CM for call admission control. (See [Managing Bandwidth, page 21-28](#).) When making inter-region calls to IP phones or MGCP gateways, IP phones automatically select the inter-region codec that has been configured.

**Figure 21-1** Centralized Messaging with Centralized Call Processing

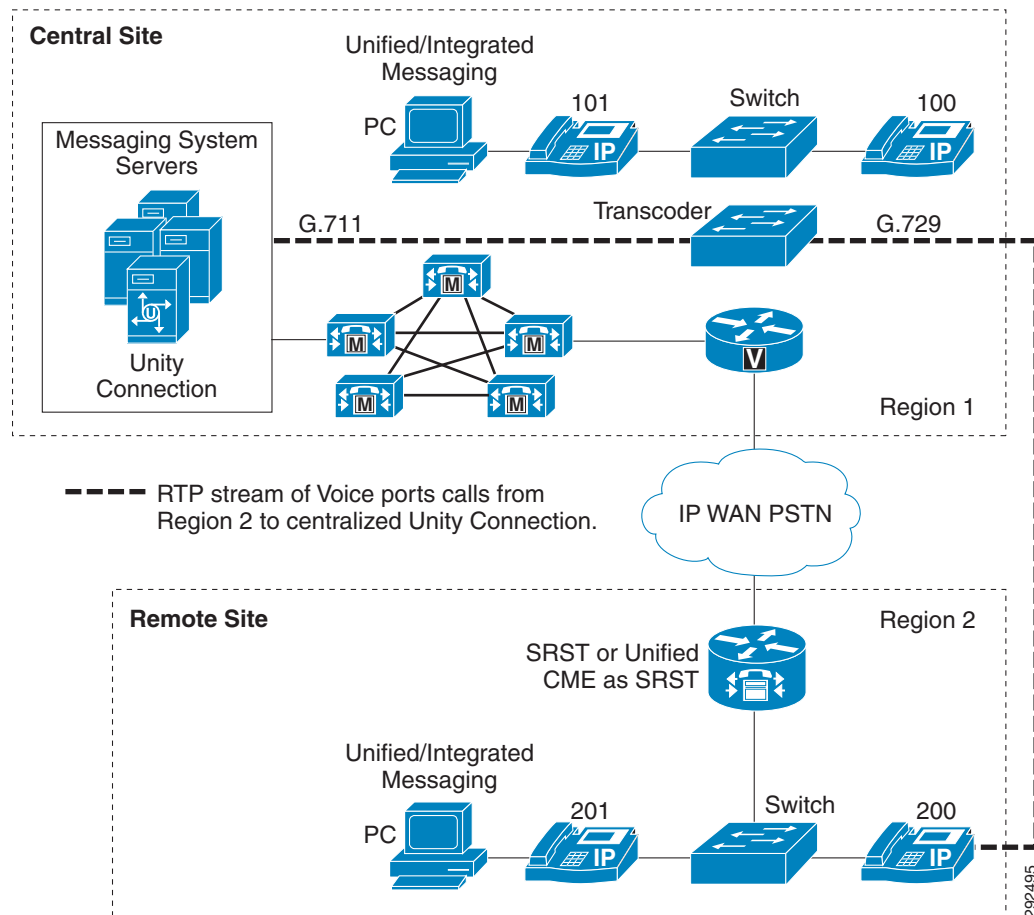

In [Figure 21-1](#), regions 1 and 2 are configured to use G.711 for intra-region calls and G.729 for inter-region calls.

As [Figure 21-1](#) shows, when a call is made from extension 200 to the voicemail ports in Region 1, the inter-region G.729 codec is used at the endpoint but the RTP stream is transcoded to use G.711 on the voice ports. Unified CM transcoding resources must be located at the same site as the voicemail system.

### Impact of Non-Delivery of RDNIS on Voicemail Calls Routed by AAR

In centralized messaging environments, automated alternate routing (AAR), a Unified CM feature, can route calls over the PSTN to the messaging store at the central site when the WAN is oversubscribed. However, when calls are rerouted over the PSTN, Redirected Dialed Number Information Service (RDNIS) can be affected. Incorrect RDNIS information can impact voicemail calls that are rerouted over the PSTN by AAR when Cisco Unity Connection is remote from its messaging clients. If the RDNIS information is not correct, the call will not reach the voicemail box of the dialed user but will instead receive the auto-attendant prompt, and the caller might be asked to re-enter the extension number of the party they wish to reach. This behavior is primarily an issue when the telephone carrier is unable to ensure RDNIS across the network. There are numerous reasons why the carrier might not be able to ensure that RDNIS is properly sent. Check with your carrier to determine if they provide guaranteed RDNIS deliver end-to-end for your circuits. The alternative to using AAR for oversubscribed WANs is simply to let callers hear reorder tone in an oversubscribed condition.

### Distributed Messaging with Centralized Call Processing

Distributed messaging means that there are multiple messaging systems distributed within the telephony environment, and each messaging system services only local messaging clients. This model differs from centralized messaging, where clients are both local and remote from the messaging system.

[Figure 21-2](#) illustrates the distributed messaging model with centralized call processing. As with other multisite call processing models, the use of regions and locations is required to manage WAN bandwidth.

Note that Cisco Unified Communications Manager Express (Unified CME) in SRST mode is used for call processing backup of both IP phones and Cisco Unity Connection voicemail ports. Deployed at the remote site (for example, Region 2 in [Figure 21-2](#)), this fallback support provides backup call processing in the event that the phones lose connectivity with Unified CM, such as during a WAN failure, while simultaneously providing users at the remote site with access to the local Cisco Unity Connection server as well as MWI support during WAN failure. For further details on Unified CME in SRST mode, refer to the Unified CME product documentation on <http://www.cisco.com>.



**Figure 21-2 Distributed Messaging with Centralized Call Processing**

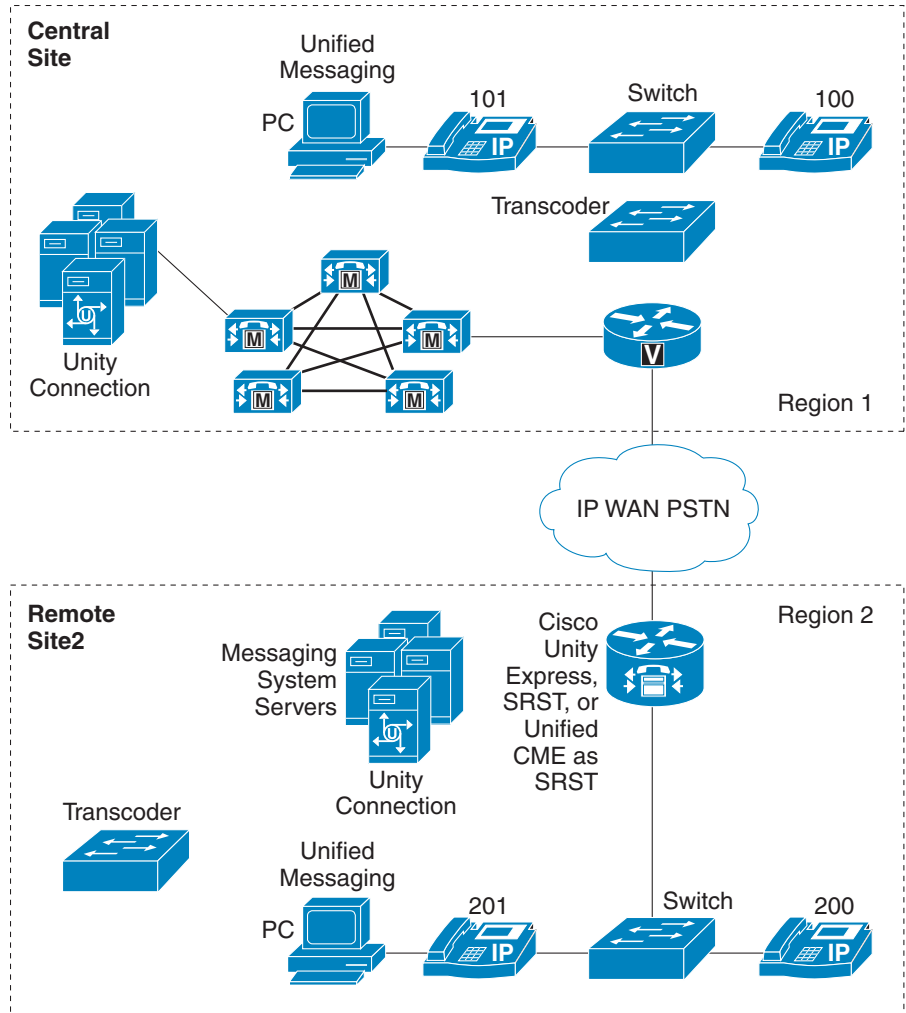

For the configuration in [Figure 21-2](#), transcoder resources must be local to each Cisco Unity Connection message system site. Regions 1 and 2 are configured to use G.711 for intra-region calls and G.729 for inter-region calls.

Voice messaging ports for both Cisco Unity Connection servers must be assigned the appropriate region and location by means of calling search spaces and device pools configured on the Unified CM server. In addition, to associate telephony users with a specific group of voicemail ports, you must configure Unified CM voicemail profiles. For details on configuring calling search spaces, device pools, and voicemail profiles, refer to the applicable version of the *Cisco Unified Communications Manager Administration Guide*, available at <http://www.cisco.com>.

Cisco Unity Connection supports digital networking, allowing multiple Cisco Unity Connection systems to be networked together. Up to 10 nodes (single or active/active pair) can be connected together in a digital network system. Additionally, if required, two digital networks can be joined to support a maximum of 20 nodes. This provides support for up to 100,000 entities in the directory. Cisco Unity Connection can integrate with a corporate directory such as Microsoft Active Directory to synchronize users and use digital networking simultaneously. In this configuration, each Cisco Unity Connection

server or server pair will be able to synchronize up to 20,000 users from the corporate directory. Refer to the *Design Guide for Cisco Unity Connection*, available at <http://www.cisco.com>, for further information regarding digital networking or directory integration in Cisco Unity Connection.

#### **Cisco Unity Connection with Unified CME in SRST Mode**

Unified CME in SRST mode offers the possibility for Cisco Unity Connection servers located in remote sites and registered with a Unified CM at the central site to fall-back to Unified CME in the remote location. When the WAN link is down and the phones fail-over to Unified CME in SRST mode, Cisco Unity Connection voicemail ports can also fail-over to Unified CME in SRST mode to provide the remote site users with access to their voicemail with MWI during the WAN outage.

This scenario requires the following:

- Cisco Unified CME 4.0 or later
- Cisco Unity Connection 2.x or later



---

**Note**

MWI has to be resynchronized from the Cisco Unity Connection server whenever a failover happens from Unified CM to Unified CME in SRST mode, or vice versa.

---

## Combined Messaging Deployment Models

It is possible to combine messaging models in the same deployment, provided that the deployment adheres to all the guidelines listed in the preceding sections. Figure 21-3 shows a user environment in which both centralized and distributed messaging are employed simultaneously.

Figure 21-3 Combined Deployment Models

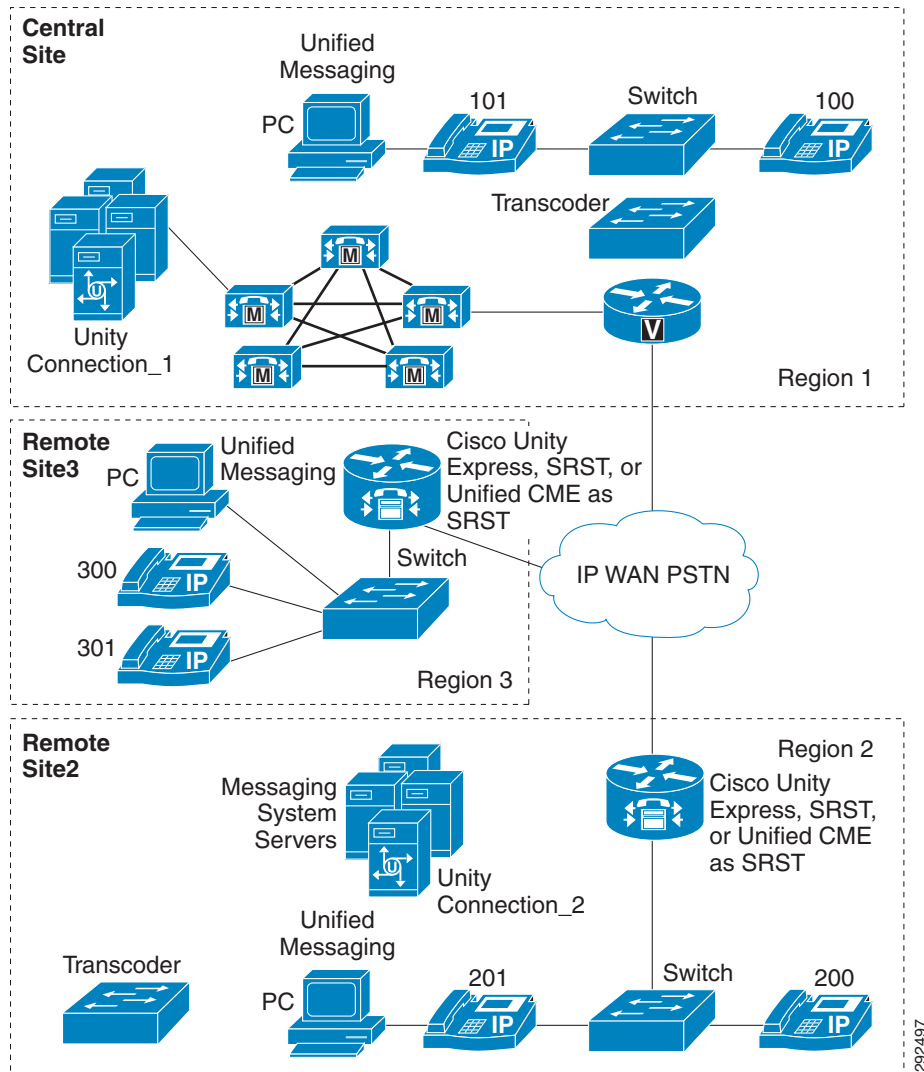

Figure 21-3 shows the combination of two messaging models. Regions 1 and 3 use centralized messaging with centralized call processing, while Region 2 uses distributed messaging with centralized call processing. All regions are configured to use G.711 for intra-region calls and G.729 for inter-region calls.

In Figure 21-3, centralized messaging and centralized call signaling are used between the Central Site and Site3. The messaging system at the Central Site provides messaging services for clients at both the Central Site and Site3. Site2 uses the distributed messaging model with centralized call processing. The messaging system (Unity Connection 2) located at Site2 provides messaging services for only those

users located within Site2. In this deployment, both models adhere to their respective design guidelines as presented in this chapter. Transcoding resources are located locally to each messaging system site, and they support clients who access messaging services from a remote site (relative to the messaging system), as in the case of a Site2 user leaving a message for a Central Site user.

In addition, Cisco Unified Communications Manager Express (Unified CME) in SRST mode is used for call processing backup of both IP phones and Cisco Unity Connection voicemail ports. Deployed at the remote site (for example, Region 2 in [Figure 21-3](#)), this fallback support provides backup call processing in the event that the phones lose connectivity with Unified CM, such as during a WAN failure, while simultaneously providing users at the remote site with access to the local Cisco Unity Connection server as well as MWI support during WAN failure. For further details on Unified CME in SRST mode, refer to the product documentation on <http://www.cisco.com>.

## Centralized Messaging with Clustering Over the WAN

This section addresses Cisco Unity Connection design issues for deploying centralized messaging with Unified CM clustering over the WAN with local failover. In the case of a WAN failure with this model, all remote messaging sites will lose voicemail capability until the WAN is restored. (See [Figure 21-4](#).)

Clustering over the WAN supports local failover. With local failover, each site has a backup subscriber server physically located at the site. This section focuses on deploying Cisco Unity Connection centralized messaging with local failover for clustering over the WAN.

For additional information, refer to the section on [Clustering Over the IP WAN](#), page 5-33.

**Figure 21-4 Cisco Unity Connection Centralized Messaging and Clustering Over the WAN with Local Failover**

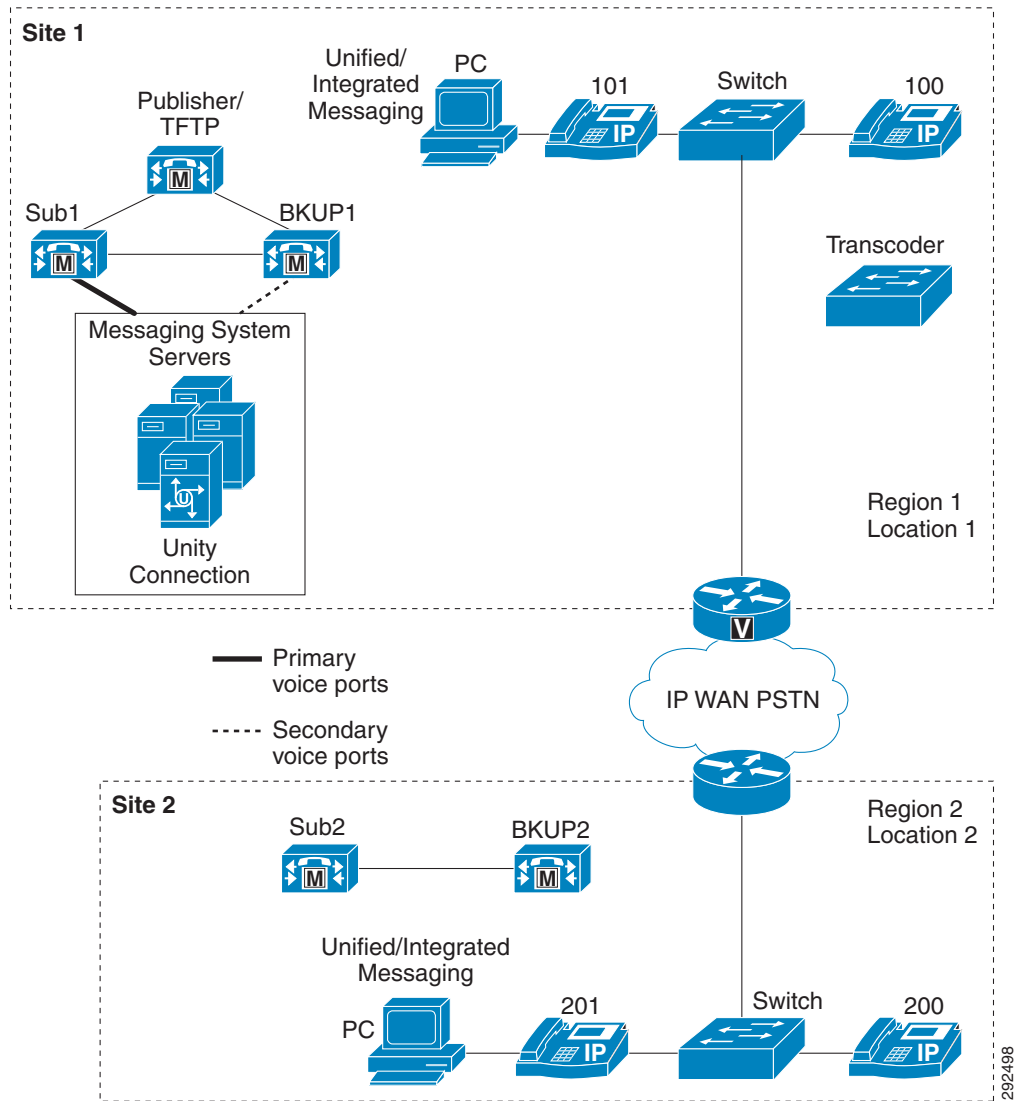

For minimum bandwidth requirements between clustered servers see the section on [Local Failover Deployment Model](#), page 5-37.

Clustering over the WAN with Unified CM supports up to eight sites, as does Cisco Unity Connection. The voicemail ports are configured only at the site where the Cisco Unity Connection messaging system is located (see [Figure 21-4](#)). Voicemail ports do not register over the WAN to the remote site(s). Messaging clients at the other site(s) access all voicemail resources from the primary site. There is no benefit to configuring voice ports over the WAN to any of the remote sites because, in the event of a WAN failure, remote sites would lose access to the centralized messaging system. Because of bandwidth consideration, the voicemail ports should have TRaP disabled and all messaging clients should download voicemail messages to their local PCs (unified messaging only).

## Distributed Messaging with Clustering Over the WAN

Local failover sites that also have Cisco Unity Connection messaging server(s) deployed would have voice ports registered to the local Unified CM subscriber server(s), similar to the centralized messaging model. For information about configuring the voice ports, see [Voice Port Integration with a Unified CM Cluster](#), page 21-36, and [Voice Port Integration with Dedicated Unified CM Backup Servers](#), page 21-38.

**Figure 21-5** Cisco Unity Connection Distributed Messaging and Clustering over the WAN

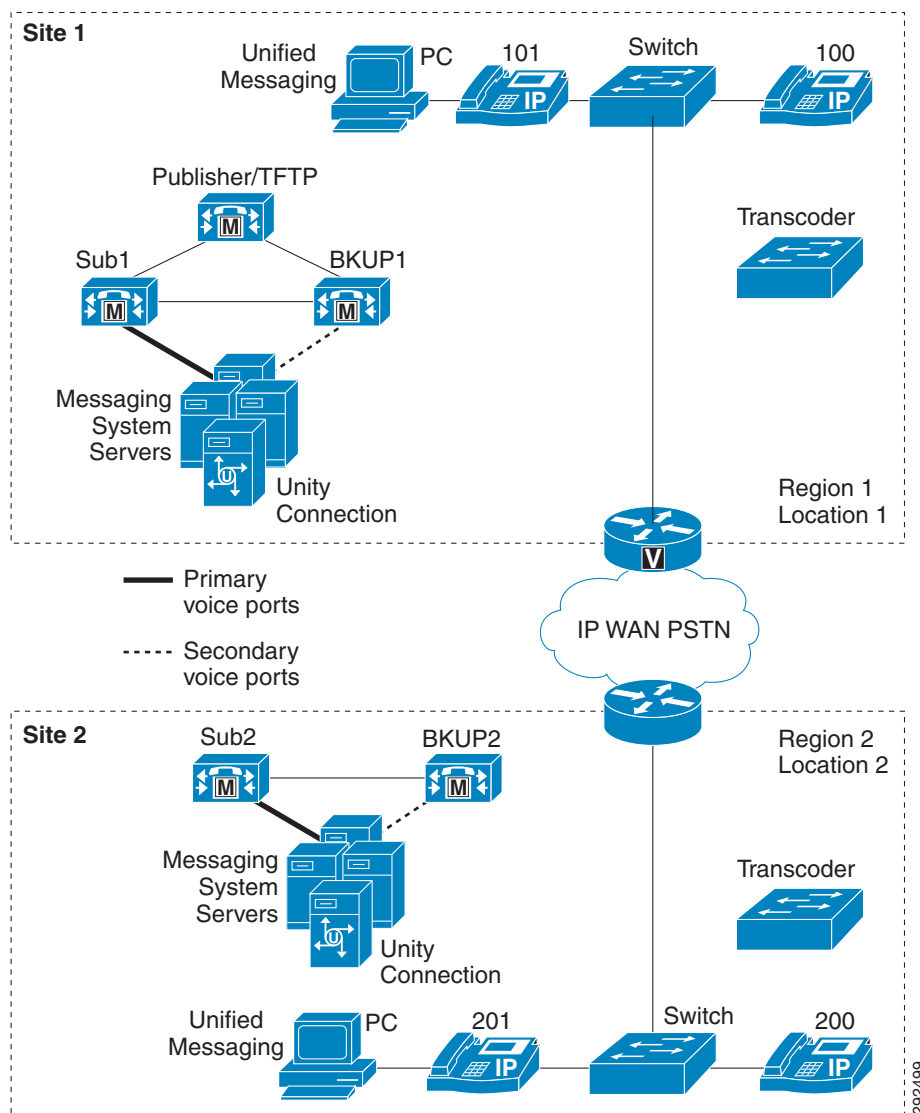

In a purely distributed messaging implementation with clustering over the WAN, each site in the cluster would have its own Cisco Unity Connection messaging server with messaging infrastructure components. If not all of the sites have local Cisco Unity Connection messaging systems but some sites have local messaging clients using a remote messaging server(s), this deployment would be a

combination model with both distributed messaging and centralized messaging. (See [Combined Messaging Deployment Models, page 21-11](#).) In the event of a WAN failure in this model, all remote sites that use centralized messaging will lose voicemail capability until the WAN is restored.

Each site that does not have a local messaging server must use a single messaging server for all of its messaging clients, but all such sites do not have to use the same messaging server. For example, suppose Site1 and Site2 each have a local messaging server. Site3 can then have all of its clients use (register with) the messaging server at Site2, while Site4 can have all of its clients use the messaging server at Site1. Transcoder resources are required at sites that have local Cisco Unity Connection messaging server(s).

As with other distributed call processing deployments, calls going between these sites are transparent to gatekeeper call admission control, therefore you must configure regions and locations in Unified CM to provide call admission control. (See [Managing Bandwidth, page 21-28](#).)

The distributed Cisco Unity Connection servers may also be networked digitally. For more information on this topic, refer to the *Cisco Unity Connection Networking Guide*, available at <http://www.cisco.com>. The networking guides are specific to the particular messaging store deployed.

## Messaging Redundancy

Messaging redundancy is discussed in this section as it refers to Cisco Unity Connection. Cisco Unity Express does not support messaging redundancy.

### Cisco Unity Connection

Cisco Unity Connection supports messaging redundancy and load balancing in an active-active redundancy model consisting of two servers, a primary and a secondary, configured as an active/active redundant pair of servers, where both the primary and secondary servers actively accept calls as well as HTTP and IMAP requests. For more information, refer to the *Design Guide for Cisco Unity Connection*, available at <http://www.cisco.com>.

[Figure 21-6](#) illustrates Cisco Unity Connection active/active messaging redundancy.

**Figure 21-6 Redundancy of Cisco Unity Connection Messaging**

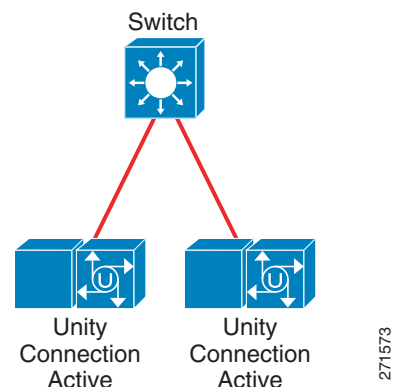

Cisco Unity Connection SIP trunk implementation requires call forking for messaging redundancy functionality. Cisco Unified Communications Manager (Unified CM) supports the multi-destination SIP trunk feature. With this multi-destination SIP trunk feature, administrators can define full-mesh trunking between Cisco Unified CM and Cisco Unity Connection to achieve redundancy. Also, two separate SIP trunks can be configured, one for each server in a pair, and they can be added to the same route group associated to the same route list. The route group should be configured in top-down order so that calls are sent to the primary Unity Connection and overflow calls are sent to secondary Unity Connection server.

**Note**

---

SIP OPTIONS Ping must be enabled on the Unified CM SIP trunk in order for Cisco Unity Connection failover to work properly.

---

## Cisco Unity Connection Failover and Clustering Over the WAN

When deploying Cisco Unity Connection local failover with clustering over the WAN, apply the same design practices described in [Centralized Messaging with Clustering Over the WAN, page 21-12](#), and [Distributed Messaging with Clustering Over the WAN, page 21-14](#). The voice ports from the primary Cisco Unity Connection server should not cross the WAN during normal operation.

[Figure 21-7](#) depicts Cisco Unity Connection local failover. Note that the primary and secondary Cisco Unity Connection servers are both physically located at the same site. Cisco Unity Connection failover supports up to the maximum number of remote sites available with clustering over the WAN for Unified CM.



**Figure 21-7 Cisco Unity Connection Local Failover and Clustering Over the WAN**

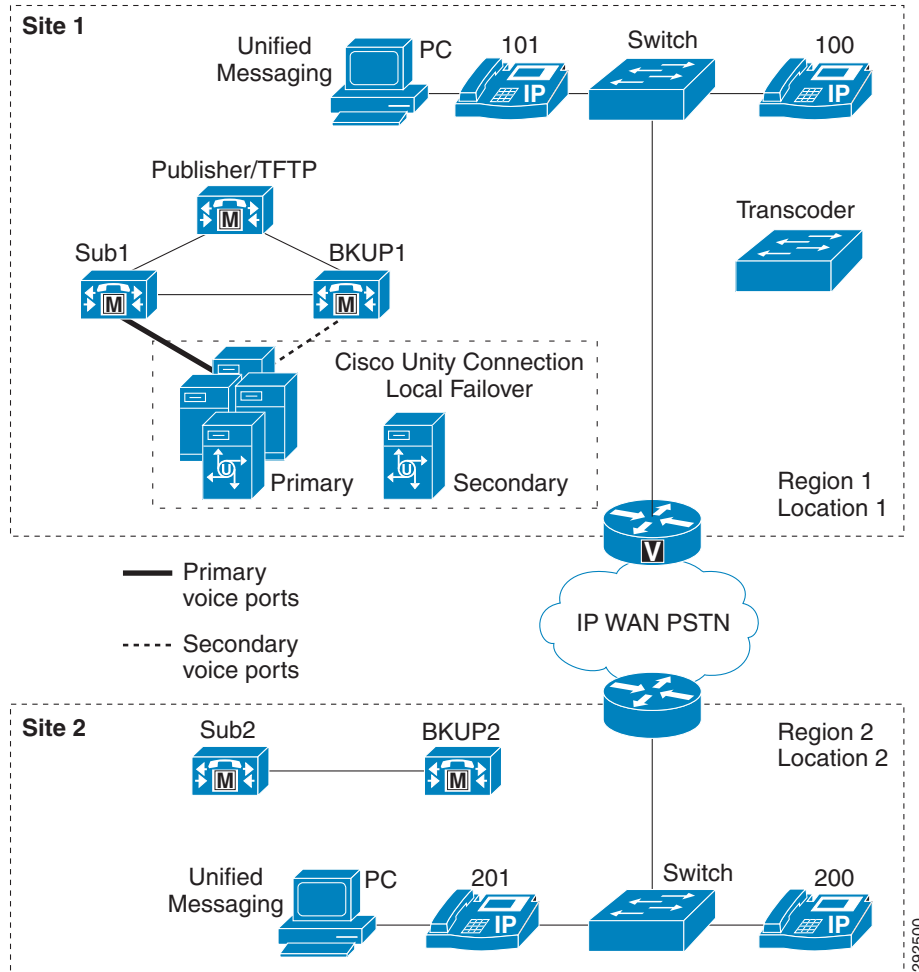

For information on configuring Cisco Unity Connection failover, refer to the *Cisco Unity Connection Failover Configuration and Administration Guide*, available at <http://www.cisco.com>.

## Cisco Unity Connection Redundancy and Clustering Over the WAN

Cisco Unity Connection supports active/active clustering for redundancy and can be deployed over the WAN. The active/active or "high availability" configuration provides both high availability and redundancy. Both servers in the active/active pair run the Cisco Unity Connection application to accept calls as well as HTTP and IMAP requests from clients. Each of the servers from the cluster can be deployed over the WAN at different sites following required design consideration. Figure 21-8 depicts a Cisco Unity Connection active/active deployment for geographically separated data centers

Figure 21-8 Cisco Unity Connection with High Availability Between Two Sites

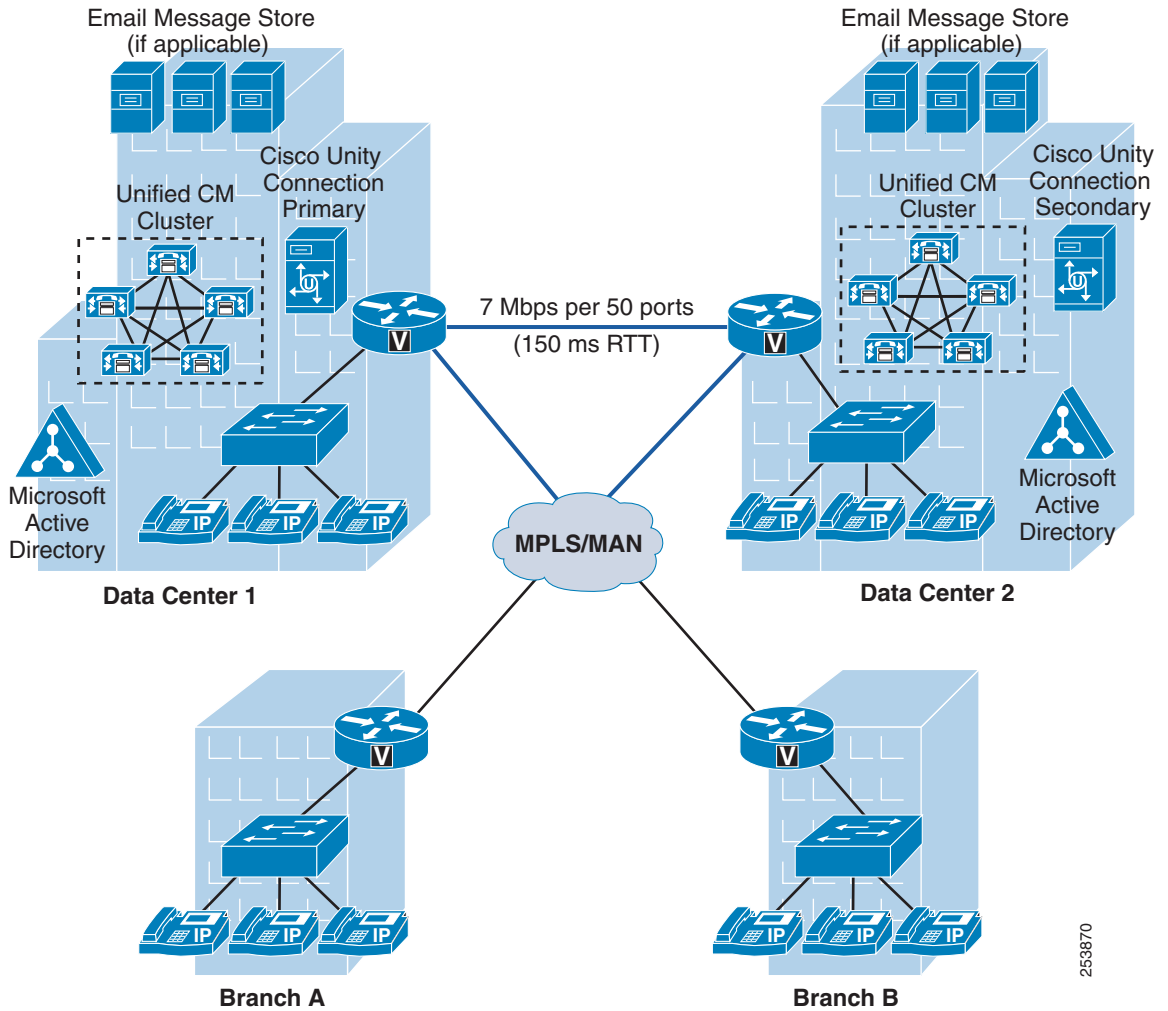

The following requirements apply to deployments of Cisco Unity Connection servers over different sites:

- Maximum of 150 ms RTT between an active/active pair at different sites.
- Minimum of 7 Mbps bandwidth is required for every 50 ports. (For example, 250 ports require 35 Mbps.)

**Note**

Bandwidth and latency requirements may differ for different versions of Cisco Unity Connection.

For a complete set of requirements, refer to the latest version of the *System Requirements for Cisco Unity Connection*, available at

[http://www.cisco.com/en/US/products/ps6509/prod\\_installation\\_guides\\_list.html](http://www.cisco.com/en/US/products/ps6509/prod_installation_guides_list.html)

**Note**

The Cisco Unity Connection cluster feature is not supported for use with Cisco Business Edition 3000 and 5000.

## Centralized Messaging with Distributed Unified CM Clusters

Cisco Unity Connection can also be deployed in a centralized messaging configuration with multiple Unified CM clusters (see Figure 21-9). See the section on [Integration with Cisco Unified CM](#), page 21-31, for details on multiple integrations and MWI considerations with multiple Unified CM clusters.

**Figure 21-9** Integrating Cisco Unity Connection with Multiple Unified CM Clusters

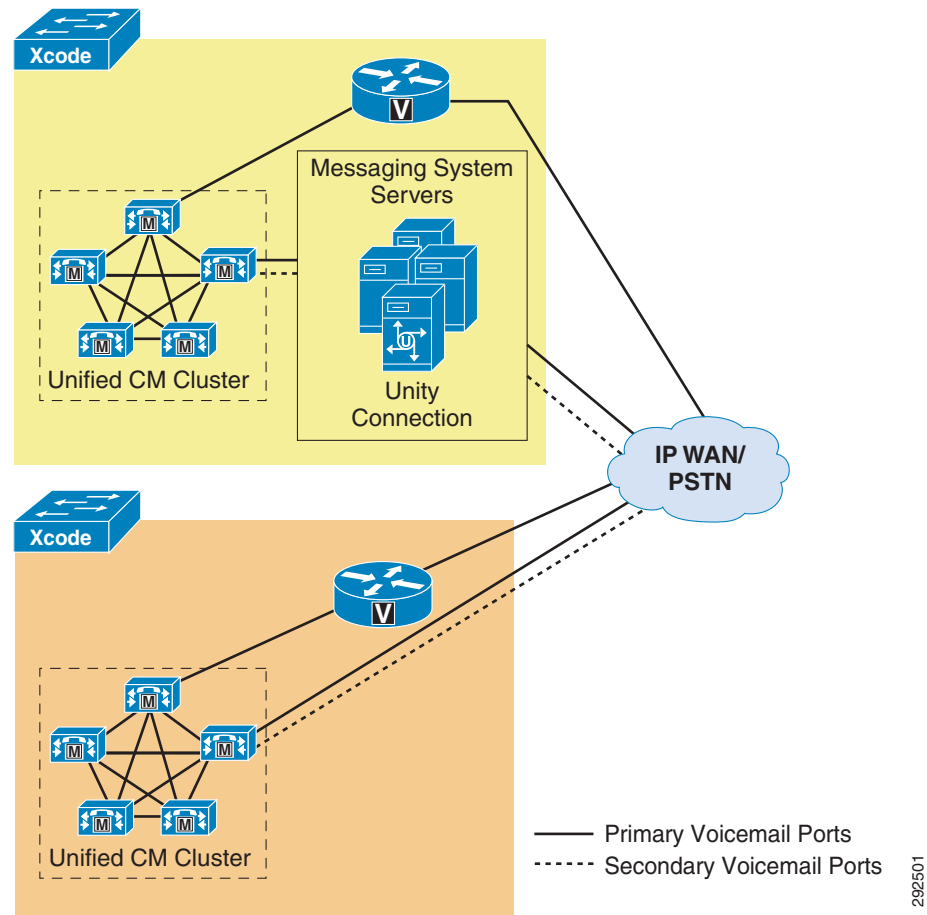

For the configuration in Figure 21-9, messaging clients at both Cluster 1 and Cluster 2 sites use the Cisco Unity Connection messaging infrastructure physically located at Cluster 1.

## Cisco Unity Express Deployment Models

This section begins with a quick overview of Cisco Unity Express, covering product related information. Next the deployment models section presents three supported deployment models with Cisco Unity Express, focusing on distributed voice messaging with both centralized and distributed call processing followed by some deployment characteristics and design guidelines. Lastly, this section discusses the signaling call flows and the various protocols used between Cisco Unity Express and Unified CM as well as between Cisco Unity Express and Unified SRST or Unified CME in SRST mode.

## Overview of Cisco Unity Express

Cisco Unity Express is Linux-based software running on a Cisco Network Module in Cisco Integrated Services Routers (ISRs). It is an entry-level auto-attendant (AA) and voicemail solution that can be deployed with Cisco Unified Communications Manager (Unified CM), Cisco Unified SRST, or Cisco Unified Communications Manager Express (Unified CME). In prior releases, Cisco Unity Express was limited to a co-resident deployment with Unified CME or a Survivable Remote Site Telephony (SRST) router. However, with the H.323-to-SIP call routing capability introduced in Cisco IOS Release 12.3(11)T, Cisco Unity Express and SRST or Unified CME can reside on two separate routers when deployed with Unified CM or Unified CME, respectively. Cisco Unity Express uses SIP to communicate with Cisco Unified Communications Manager Express (Unified CME) while Cisco Unity Express uses JTAPI to connect to Cisco Unified Communications Manager (Unified CM).

For more information on supported hardware platforms and capacity with Cisco Unity Express, refer to the product release note available at [http://www.cisco.com/en/US/products/sw/voicesw/ps5520/prod\\_release\\_notes\\_list.html](http://www.cisco.com/en/US/products/sw/voicesw/ps5520/prod_release_notes_list.html).

For details on interoperability of Unified CM and Unified CME, see [Interoperability of Unified CM and Unified CM Express, page 8-44](#).

For additional information on supported deployment models with Unified CME, refer to the appropriate Cisco Unified Communications Manager Express design documentation available at <http://www.cisco.com>.

## Deployment Models

Cisco Unity Express can be deployed as a single site or distributed voicemail and automated attendant (AA) solution for Cisco Unified Communications Manager (Unified CM) or Unified Communications Manager Express (Unified CME). However, Cisco Unity Express is supported with all of the Cisco Unified CM deployment models, including:

- Single-site deployments
- Multisite deployments with centralized call processing
- Multisite deployments with distributed call processing

[Figure 21-10](#) shows a centralized call processing deployment incorporating Cisco Unity Express, and [Figure 21-11](#) shows a distributed call processing deployment.

Cisco Unity Express sites controlled by Unified CME, as well as other sites controlled by Unified CM, can be interconnected with each other using H.323 or SIP trunking protocol. Although Cisco Unity Express can integrate with either Unified CM or Unified CME, it cannot integrate with both simultaneously.

**Note**

---

Cisco Unity Express supports a centralized deployment model with up to 10 Unified CMEs.

---

Figure 21-10 Cisco Unity Express in a Centralized Call Processing Deployment

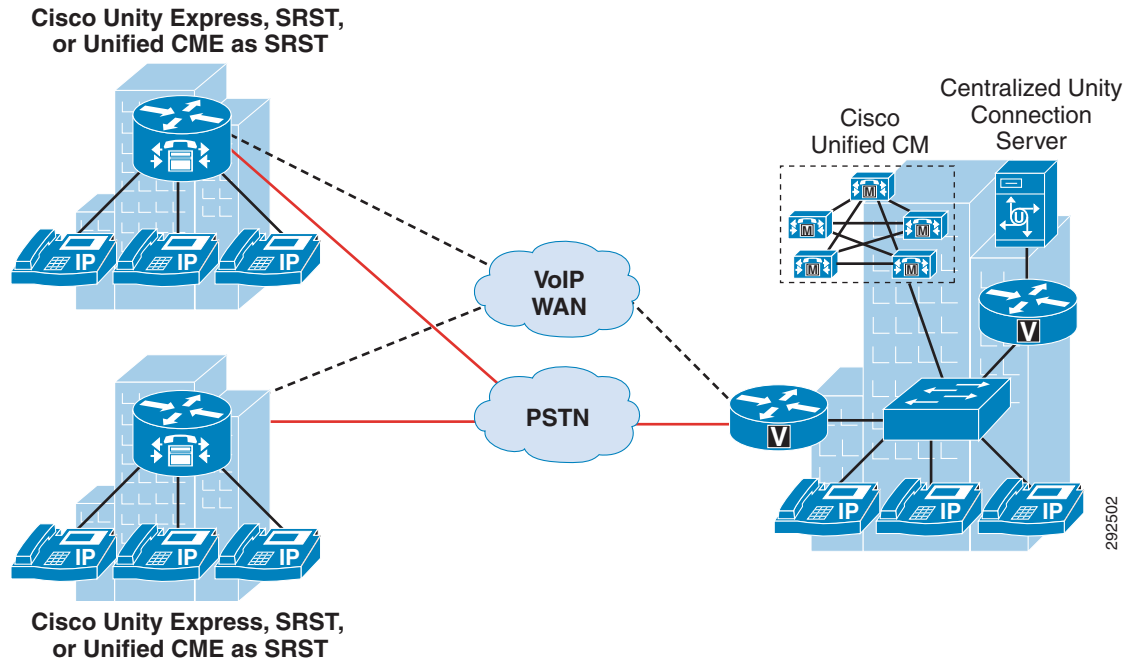
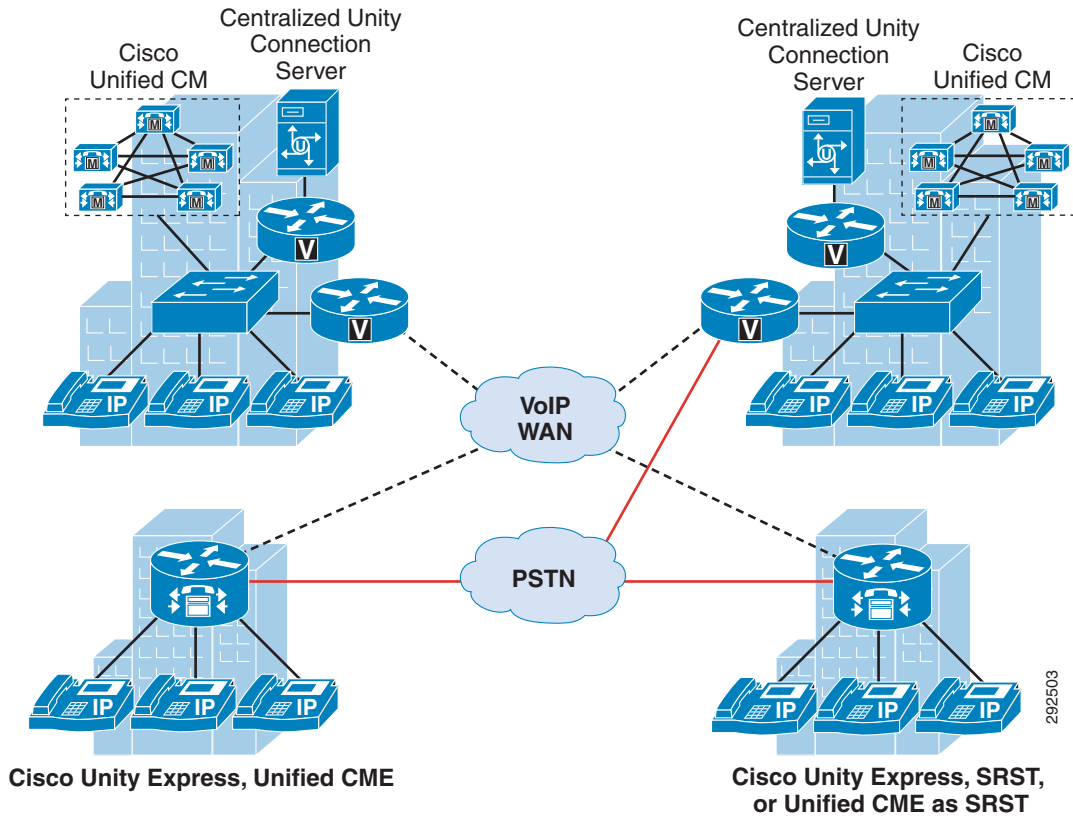

Figure 21-11 Cisco Unity Express in a Distributed Call Processing Deployment



The most likely deployment model to use Cisco Unity Express is the multisite WAN model with centralized call processing, where Cisco Unity Express provides distributed voicemail at the smaller remote offices and a central Cisco Unity Connection system provides voicemail to the main campus and larger remote sites.

Use Cisco Unity Express as a distributed voicemail solution if any of the following conditions apply to your Unified CM network deployment:

- Survivability of voicemail and AA access must be ensured regardless of WAN availability.
- Available WAN bandwidth is insufficient to support voicemail calls traversing the WAN to a central voicemail server.
- There is limited geographic coverage of the AA or branch site PSTN phone numbers published to the local community, and these numbers cannot be dialed to reach a central AA server without incurring toll charges.
- The likelihood is high that a PSTN call into a branch office will be transferred from the branch AA to a local extension in the same office.
- Management philosophy allows remote locations to select their own voicemail and AA technology.

The following characteristics and guidelines apply to Cisco Unity Express in either a centralized or distributed Unified CM deployment:

- A single Cisco Unity Express can be integrated with a single Unified CM cluster.
- Cisco Unity Express integrates with Unified CM using a JTAPI application and Computer Telephony Integration (CTI) Quick Buffer Encoding (QBE) protocol. CTI ports and CTI route points control the Cisco Unity Express voicemail and automated attendant (AA) applications.
- Cisco Unity Express provides voicemail functionality to Cisco Unified IP Phones running Skinny Client Control Protocol (SCCP). Cisco Unity Express 2.3 and later releases also provide support for Session Initiation Protocol (SIP) IP phones with Unified CM.
- The following CTI route points are defined on Unified CM for Cisco Unity Express:
  - Automated attendant entry point (Cisco Unity Express can contain up to five distinct AAs and may therefore require up to five different route points.)
  - Voicemail pilot number
  - Greeting management system (GMS) pilot number (Optional; if the GMS is not used, then this route point need not be defined.)
- The number of CTI ports and mailboxes supported for Cisco Unity Express on Unified CM depends on the hardware platform. For details, refer to the Cisco Unity Express data sheet available at:  
[http://www.cisco.com/en/US/products/sw/voicesw/ps5520/products\\_data\\_sheets\\_list.html](http://www.cisco.com/en/US/products/sw/voicesw/ps5520/products_data_sheets_list.html)
- For Cisco Unity Express deployments that require more than the maximum number of supported mailboxes, consider using Cisco Unity Connection or other voicemail solutions.
- Each Cisco Unity Express mailbox can be associated with a maximum of two different extensions, if needed.
- The automated attendant function for any office deployed with Cisco Unity Express can be local to the office (using the AA application in Cisco Unity Express) or centralized (using Cisco Unity Express for voicemail only).
- Cisco Unity Express can be networked with other Cisco Unity Expresses or with Cisco Unity Connection via Voice Profile for Internet Mail (VPIM) version 2. Thus, a Cisco Unity Express subscriber can send, receive, or forward messages to or from another remote Cisco Unity Express or Cisco Unity Connection subscriber.
- Cisco Unity Express allows you to specify up to three Unified CMs for failover. If IP connectivity to all three Unified CMs is lost, Cisco Unity Express switches to Survivable Remote Site Telephony (SRST) call signaling, thus providing AA call answering service as well as mailbox access to IP phones and PSTN calls coming into the branch office.
- Cisco Unity Express automated attendant supports dial-by-extension and dial-by-name functions. The dial-by-extension operation enables a caller to transfer a call to any user endpoint in the network. The dial-by-name operation uses the directory database internal to Cisco Unity Express and does not interact with external LDAP or Active Directory databases.
- Centralized Cisco Unity Express with Unified CM is not supported.
- Cisco Unity Express is not supported in pure SIP networks that do not have either Cisco Unified CM or Unified CME controlling the SIP phones.
- Cisco Unity Express can be deployed on a separate Unified CME or SRST router or a separate PSTN gateway.
- When Cisco Unity Express is deployed on a router separate from Unified CME or SRST, configure the command **allow-connections h323 to sip** for H.323-to-SIP routing.

Figure 21-12 shows the protocols involved in the call flow between Unified CM and Cisco Unity Express.

**Figure 21-12** Protocols Used Between Cisco Unity Express and Unified CM

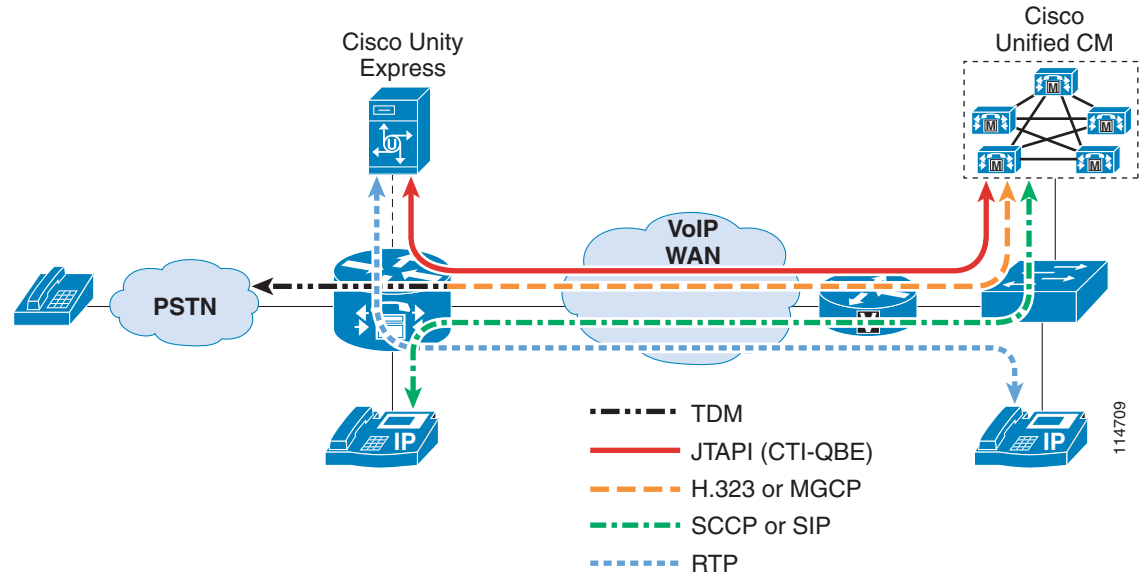

Figure 21-12 illustrates the following signaling and media flows:

- Phones are controlled via SCCP or SIP from Unified CM.
- Cisco Unity Express is controlled via JTAPI (CTI-QBE) from Unified CM.
- The Message Waiting Indicator (MWI) on the phone is affected by Cisco Unity Express communicating a change of mailbox content to Unified CM via CTI-QBE, and by Unified CM in turn sending a MWI message to the phone to change the state of the lamp.
- The voice gateway communicates via H.323, SIP, or MGCP to Unified CM.
- Real-Time Transport Protocol (RTP) stream flows carry the voice traffic between endpoints.

Figure 21-13 shows the protocols involved in the call flow between the router for SRST or Unified CME in SRST mode and Cisco Unity Express when the WAN link is down.



**Figure 21-13** Protocols Used Between Cisco Unity Express and the Router for SRST or Unified CME in SRST Mode

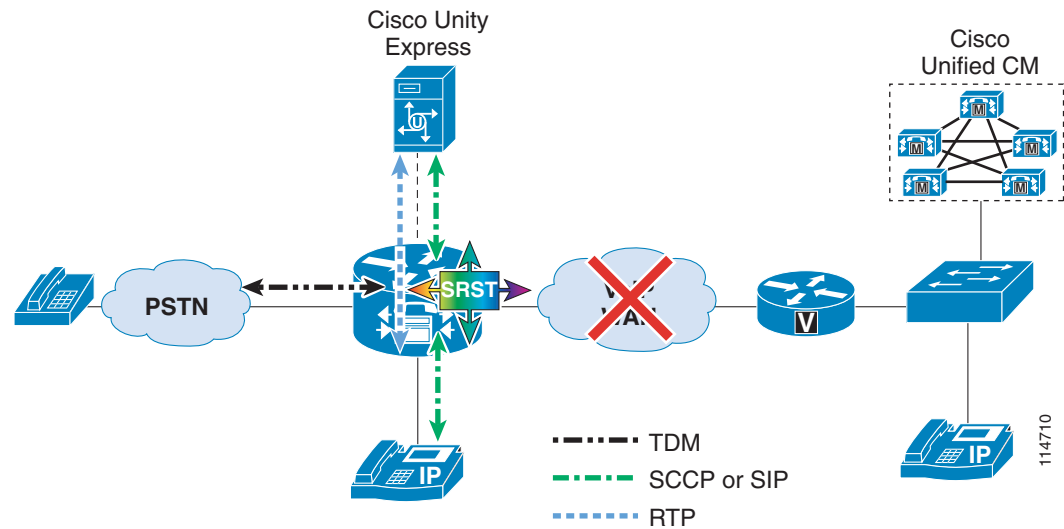

Figure 21-13 illustrates the following signaling and media flows:

- Phones are controlled via SCCP or SIP from the router for SRST or Unified CME in SRST mode.
- Cisco Unity Express communicates with the SRST router via an internal SIP interface.
- Although MWI changes are not supported in SRST mode with previous releases of Cisco Unity Express, voice messages can be sent and retrieved as during normal operation, but the MWI lamp state on the phone remains unchanged until the phone registers again with Unified CM. At that time, all MWI lamp states are automatically resynchronized with the current state of the users' Cisco Unity Express voicemail boxes. Cisco Unity Express 3.0 and later releases support MWI for SRST mode.
- Cisco Unity Express supports SIP Subscriber/Notify and Unsolicited Notify to generate MWI notifications, in both Unified CME and SRST modes.
- RTP stream flows carry the voice traffic between endpoints.
- SRST subscribes to Cisco Unity Express for MWI for each of the ephone-dns registered to receive MWI notifications.



**Note**

Unified CM MWI (JTAPI) is independent of the SIP MWI methods.

# Voicemail Networking

This section covers specific considerations for voicemail networking, including Cisco Unity Connection and Cisco Unity Express. For information specific to voicemail networking in Unity Connection, refer to the *Design Guide for Cisco Unity Connection*, available at <http://www.cisco.com>.

Voicemail networking is the ability to allow subscribers (voicemail users) to send, receive, reply to, and forward voicemail messages between systems such as Cisco Unity Connection and Cisco Unity Express using an embedded Simple Mail Transfer Protocol (SMTP) server and a subset of the Voice Profile for Internet Mail (VPIM) version 2 protocol. All three voicemail messaging products support interoperability between one another using VPIM messaging.

## Cisco Unity Express Voicemail Networking

Cisco Unity Express communicates with Cisco Unity Connection by means of VPIM for message routing and SMTP for message delivery. Cisco Unity Express voicemail networking provides the following capabilities:

- Subscribers can receive, send, and forward messages to or from another remote Cisco Unity Express or Cisco Unity Connection for locations configured on the originating system.
- Subscribers can also reply to a remote message received from a remote system.
- Subscribers can be recipients of a distribution list or individual message originating from Cisco Unity Connection.

For more information on voicemail networking with a specific product, refer to the corresponding voicemail product documentation available at <http://www.cisco.com>.

## Interoperability Between Multiple Cisco Unity Connection Clusters or Networks

Cisco Unity Connection (digital network, standalone servers, or cluster) can interoperate with another Cisco Unity Connection (digital network), thus enabling users to achieve directory sharing, easy administration, and other features, as well as expanding the total number of nodes (cluster or standalone server) up to 20. Consider the following points when deploying Cisco Unity Connection for interoperability with another Cisco Unity Connection network:

- A Cisco Unity Connection standalone server, cluster, or digital network can interoperate with another Cisco Unity Connection server or digital network.
- If any of the Cisco Unity Connection nodes in the digital network system is running Cisco Unity Connection 7.0, then the maximum number of users supported is 50,000.
- Each Cisco Unity Connection digital network can support a maximum of 10 servers.
- One Cisco Unity Connection can be a member of only one Cisco Unity Connection digital network.
- The maximum number of users and/or contacts can be 100,000 in any interoperating system, and a maximized system will allow only deletions and changes.
- Cisco Business Edition 3000 and 5000 are not supported.
- Each Cisco Unity Connection digital network must have one server defined as the bridgehead or site gateway. The site gateway is used to communicate with other digital networks.
- The Cisco Unity Connection server designated as the site gateway should be version 8.0 or higher.

For more information on these interoperability options, refer to the latest version of the *Networking Guide for Cisco Unity Connection*, available at

[http://www.cisco.com/en/US/products/ps6509/prod\\_maintenance\\_guides\\_list.html](http://www.cisco.com/en/US/products/ps6509/prod_maintenance_guides_list.html)

## Cisco Unity Connection Virtualization

The Cisco Unified Computing System (UCS) is a next-generation data center platform that unites computing, networking, storage access, and virtualization into a cohesive system designed to reduce total cost of ownership (TCO) and increase business agility. Cisco Unity Connection supports virtualization over VMware with the Cisco Unified Computing system.

The following key design considerations apply to Cisco Unity Connection virtualization:

- Supports up to 20,000 users
- The Tested Reference Configurations include selected Cisco Unified Computing System (UCS) platforms. Other platforms may be supported with the specifications-based hardware support policy.
- VMware ESXi is required for virtualization.
- Servers in an active/active cluster should be on separate blades, preferably on different chassis.



---

**Note**

One CPU core per physical server must be left idle and reserved for the ESXi scheduler.

---

For more information on deploying Cisco Unified Communications and Cisco Unity Connection in a virtualized system, refer to the documentation available at

<http://www.cisco.com/go/uc-virtualized>

General information about deploying Unified Communications on virtualized servers is also available in the section on [Deploying Unified Communications on Virtualized Servers](#), page 5-46.

For Cisco Unity Connection virtualization, also refer to the latest version of the *Design Guide for Cisco Unity Connection* available at

[http://www.cisco.com/en/US/products/ps6509/products\\_implementation\\_design\\_guides\\_list.html](http://www.cisco.com/en/US/products/ps6509/products_implementation_design_guides_list.html)

# Best Practices for Voice Messaging

This section discusses some general best practices and guidelines that were not mentioned previously yet are important aspects of the products and should be considered in the solution. They are separated into two groupings, with Cisco Unity Connection in one grouping and Cisco Unity Express in another.

## Best Practices for Deploying Cisco Unity Connection with Unified CM

This section applies to Cisco Unity Connection. For Cisco Unity Express, see [Best Practices for Deploying Cisco Unity Express, page 21-42](#).

### Managing Bandwidth

Unified CM provides a variety of features for managing bandwidth. Through the use of regions, locations, and even gatekeepers, Unified CM can ensure that the number of voice calls going over a WAN link does not oversubscribe the existing bandwidth and cause poor voice quality. Cisco Unity Connection relies on Unified CM to manage bandwidth and to route calls. If you deploy Cisco Unity Connection in an environment where calls or voice ports might cross WAN links, these calls will be transparent to gatekeeper-based call admission control. This situation occurs any time the Cisco Unity Connection server is servicing either distributed clients (distributed messaging or distributed call processing) or when Unified CM is remotely located (distributed messaging or centralized call processing). Unified CM provides regions and locations for call admission control.

[Figure 21-14](#) uses a small centralized messaging and centralized call processing site to illustrate how regions and locations work together to manage available bandwidth. For a more detailed discussion of regions and locations, refer to the chapter on [Call Admission Control, page 11-1](#).

Figure 21-14 Locations and Regions

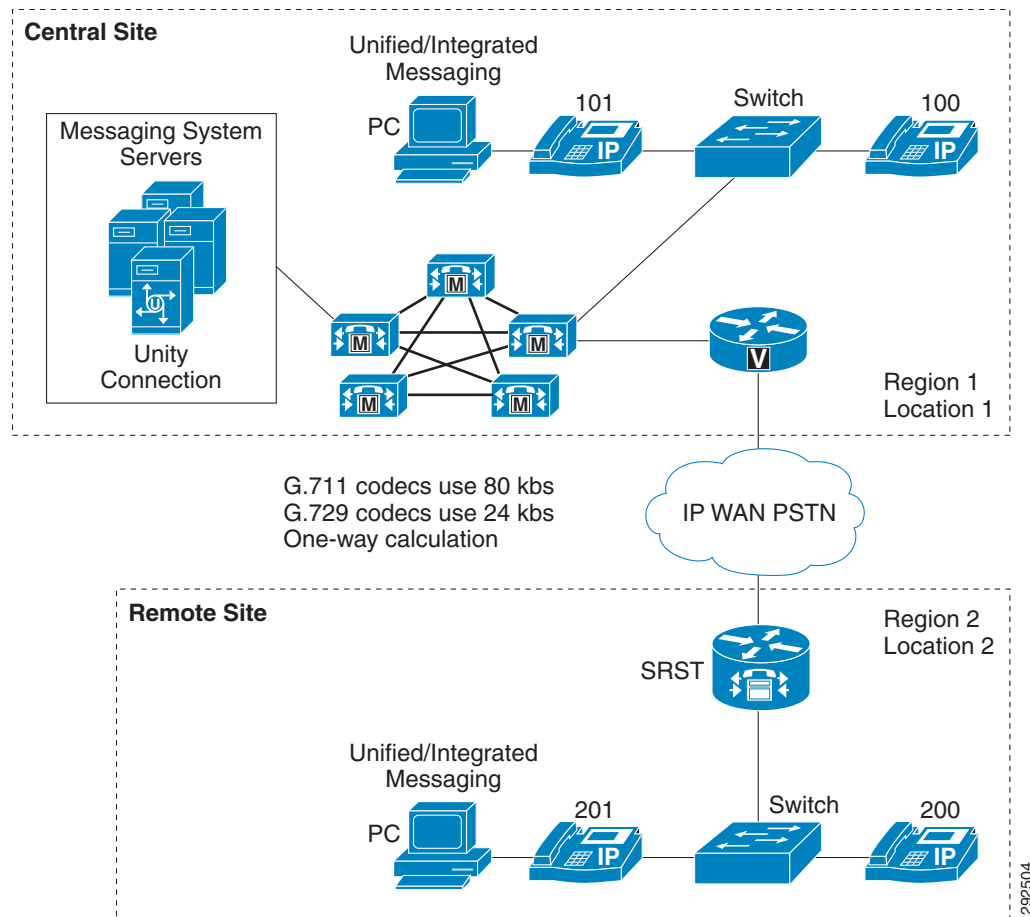

In Figure 21-14, regions 1 and 2 are configured to use G.711 for intra-region calls and G.729 for inter-region calls. Locations 1 and 2 are both set to 24 kbps. Location bandwidth is budgeted only in the case of inter-location calls.

An intra-region (G.711) call would not be budgeted against the available bandwidth for the location. For example, when extension 100 calls extension 101, this call is not budgeted against the 24 kbps of available bandwidth for Location 1. However, an inter-region call using G.729 is budgeted against both bandwidth allocations of 24 kbps for Location 1 and Location 2. For example, when extension 100 calls extension 200, this call would be connected but any additional (simultaneous) inter-region calls would receive reorder (busy) tone.

## Native Transcoding Operation

In Cisco Unity Connection, native transcoding occurs when a call is negotiated between an IP endpoint and the Cisco Unity Connection server in one codec and is recorded or played out in another codec format. If a call is negotiated in G.729 and the system-wide recording format is done in G.711, then the server has to transcode that call natively. Cisco Unity Connection native transcoding does not use external hardware transcoders but instead uses the server's main CPU. This is what is meant by native transcoding.

## Cisco Unity Connection Operation

In Cisco Unity Connection, a call in any codec format supported by Cisco Unity Connection SCCP or SIP signaling (G.711 mu-law, G.711 a-law, G.729, iLBC, and G.722) will always be transcoded to Linear PCM. From Linear PCM, the recording is encoded in the system-level recording format (Linear PCM, G.711 mu-law/a-law, G.729a, or G.726), which is set system-wide in the general configuration settings (G.711 mu-law is the default). In the rest of this chapter, we refer to the codec negotiated between the calling device and Unity Connection as the "line codec," and we refer to the codec set in the system-level recording format as the "recording codec."

Because transcoding is inherent in every connection, there is little difference in system impact when the line codec differs from the recording codec. The exception to this is when using iLBC or G.722. G.722 and iLBC require more computation to transcode, therefore they have a higher system impact. G.722 and iLBC use approximately twice the amount of resources as G.711 mu-law. The subsequent impact this has is that a system can support only half as many G.722 or iLBC connections as it can G.711 mu-law connections.

As a general rule, Cisco recommends leaving the default codec as G.711. If the configuration is constrained by disk space, then a lower bit rate codec such as G.729a or G.726 can be configured as the recording format; however, keep in mind that the audio quality will not have the fidelity of G.711 audio. Also, if G.722 is used by devices on the line, then linear pulse code modulation (PCM) is an option to improve the audio quality of the recording. This will, however, increase the disk usage and impact disk space.

There are also a few reasons to change the recording codec or to choose to advertise only specific line codecs. Consider the following factors when deciding on the system-level recording format and the advertised codecs on the SCCP or SIP integration:

- Which codecs will be negotiated between the majority of the endpoints and Cisco Unity Connection? This will help you decide on which codecs need to be advertised by Cisco Unity Connection and which do not. You can then decide on when you need Unified CM to provide hardware transcoding resources in lieu of doing computationally significant native transcoding in Cisco Unity Connection, such as when requiring a large number of clients connected to Cisco Unity Connection using G.722 or iLBC.
- Which types of graphical user interface (GUI) clients (web browsers, email clients, media players, and so forth) will be fetching the recordings, and which codecs do the GUI clients support?
- What quality of the sound is produced by the selected codec? Some codecs are higher quality than others. For example, G.711 has a higher quality than G.729a, and it is a better choice if higher audio quality is necessary.
- How much disk space does the codec use per second of recording time?

Table 21-5 summarizes the characteristics of the codec formats supported by Cisco Unity Connection.

**Table 21-5**      *Codec Characteristics*

Recording Format (Codec)	Audio Quality	Supportability	Disk Space (Bandwidth)
Linear PCM	Highest	Widely supported	16 kbps
G.711 mu-law and a-law	Moderate	Widely supported	8 kbps
G.729a	Lowest	Poorly supported	1 kbps
G.726	Moderate	Moderately supported	3 kbps
GSM 6.10	Moderate	Moderately supported	1.6 kbps

Refer to the *System Administration Guide for Cisco Unity Connection* for details on changing the codec advertised by Cisco Unity Connection. The choices for advertised codecs are G.711 mu-law, G.711 a-law, G.729, iLBC and G.722. There is also a list of preferences according to how they are ordered in the list (top-down). For SCCP integrations, the order of the codecs has no bearing because codecs are advertised and Unified CM negotiates the codec based on the location of the port and device in the negotiated call. For SIP integrations, however, the order list is significant. If the codec is preferred, then Cisco Unity Connection will advertise that it supports both protocols but will prefer to use the one specified over the other.

For information on how to change the system-level recording format in Cisco Unity Connection Administration, refer to the *System Administration Guide for Cisco Unity Connection*.

## Integration with Cisco Unified CM

Cisco Unified CM can integrate with Cisco Unity Connection via SCCP or SIP. This section discusses some specifics of that integration regarding phones, SIP trunks, and voice ports.

In Cisco Unity Connection, users are associated to a phone system that contains one or more port groups. The port groups are associated with MWI ports; thus, the MWI requests are made through the ports associated to that specific port group. Cisco Unity Connection phone systems and port groups are configured with the System Administrator.

Cisco Unity Connection supports a maximum of 90 simultaneous phone systems and port groups. Cisco recommends using a maximum of 90 port groups if you are using only the touchtone conversation (telephone user interface, or TUI) and voice recognition (voice user interface, or VUI) features of Unity Connection. If you are using all other features such as calendaring and text-to-speech (TTS), then Unity Connection supports a maximum of 60 simultaneous phone systems. These features function the same way for both SCCP and SIP integrations. For details, refer to the appropriate Cisco Unity Connection administration guides available at

<http://www.cisco.com/en/US/products/ps6509/index.html>

In addition to the option of adding multiple clusters by adding additional integrations for each new Unified CM cluster in Cisco Unity Connection, Unified CM supports Annex M.1, Message Tunneling for QSIG, which gives administrators the ability to enable QSIG on intercluster trunks (ICTs) between Unified CM clusters. When QSIG is enabled on ICTs, Cisco Unity Connection needs to integrate with only one Unified CM cluster and designate ports only in this one cluster for turning MWIs on and off, even when supporting multiple clusters. The Annex M.1 feature in Unified CM allows for propagation of the MWI requests across the ICTs to the proper Unified CM cluster and phone within that cluster. All calls originating in other clusters can be forwarded to the Cisco Unity Connection server integrated to that one cluster. There is no need to designate MWI ports on the other clusters when Annex M.1 is enabled on the ICT.

For more information on Annex M.1, refer to the protocol descriptions in the *Cisco Unified Communications Manager System Guide*, available at

[http://www.cisco.com/en/US/products/sw/voicew/ps556/prod\\_maintenance\\_guides\\_list.html](http://www.cisco.com/en/US/products/sw/voicew/ps556/prod_maintenance_guides_list.html)

## Integration with Cisco Unified CM Session Management Edition

Cisco Unity Connection can be integrated with Cisco Unified CM Session Management Edition to provide voice messaging services to the users associated with all leaf Unified Communications clusters. (See [Figure 21-15](#).)

**Figure 21-15** Cisco Unity Connection Deployment with Unified CM Session Management Edition

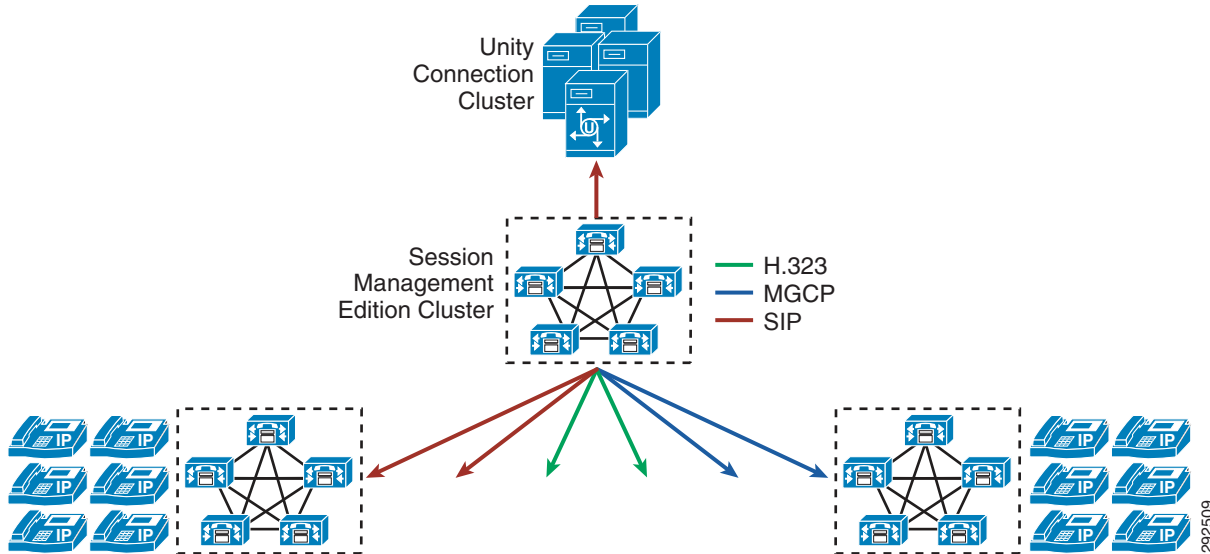

The following information must be sent on the intercluster trunks between Unified Communications leaf clusters and Unified CM Session Management Edition, and on the SIP trunk to Cisco Unity Connection:

- Original called party number or redirecting number
- Calling party number
- Reason for call forward

### Non- Q.SIG Trunk

For a non-Q.SIG trunk, the following settings should be enabled to deliver the original called party number or redirecting number:

- Inbound and outbound redirecting number information element (IE) delivery on MGCP and H.323 gateways and H.323 trunks
- Inbound and outbound redirecting diversion header delivery on SIP trunks

Diversion information that is sent on non-Q.SIG MGCP, H.323, or SIP trunks picks up only the calling party transformations that are defined by the voice mailbox mask of the voicemail profile that is assigned to the redirecting DN. Any calling party transformations that are defined in a route pattern or route list, or through outbound calling party transformation calling search spaces (CSSs), are not applied to diversion information.



## Q.SIG-Enabled Trunk

For Q.SIG-enabled SIP, MGCP and H.323 trunks, the original called party number is sent in Q.SIG diverting leg information application protocol data units (APDUs).

On Q.SIG-enabled H.323, MGCP, and SIP trunks all calling, called, and redirecting number information is always sent in the encapsulated Q.SIG message and not in the outer H.323 message or SIP headers. The sent diversion information does not pick up any calling party transformation and does not honor any voicemail mask setting. Q.SIG tunneling-enabled trunks do not support transport of the “+” character in Q.SIG APDUs. Because of this limitation, the user’s voice mailbox number should be of the same format as the directory number used in the leaf Unified Communications system. For example:

- Users with directory numbers of the format 4YYYYY should have a corresponding voice mailbox number of the same 4YYYYY format.
- Users with directory numbers of the E.164 format +XX4YYYY should have a corresponding voice mailbox number of the same E.164 +XX4YYYY format.

Cisco Unity Connection allows an alternate extension to be associated with the voice mailbox of the user. For example:

- Primary VM box number: 4YYYYY
- Alternate VM box number in +E.164: +XX4YYYY

Redirected Dialed Number Information Service (RDNIS) is not supported with Q.SIG-enabled H.323 or SIP trunks. The original called party or redirecting number is sent in a Q.SIG DivertingLegInformation2 APDU instead of via RDNIS.

## E.164 Number Support with Cisco Unity Connection

Cisco Unity Connection supports the E.164 number format for the following fields:

- End users’ primary extensions
- Transfer rule extensions for the end users
- System call handler extensions
- Directory handler extensions
- Interview handler extensions
- Notification device phone numbers for the end users
- Personal contact phone numbers for the end users
- System contact phone numbers for the Cisco Unity Connection System
- Personal call transfer rule (PCTR) phone numbers for the Cisco Unity Connection System
- Alternate extensions for the end users
- Restriction patterns for the Cisco Unity Connection System
- Message waiting indicator (MWI) extensions for the Cisco Unity Connection System

When importing users from LDAP with E.164-formatted primary phone numbers, use the regular expression and replacement pattern that together convert phone numbers into extensions. For more information on this, refer to the sections on converting phone numbers into extensions in the latest version of the *System Administration Guide for Cisco Unity Connection*, available at

[http://www.cisco.com/en/US/products/ps6509/prod\\_maintenance\\_guides\\_list.html](http://www.cisco.com/en/US/products/ps6509/prod_maintenance_guides_list.html)

If you want to import users from Cisco Unified Communications Manager (Unified CM) with E.164 formatted extensions through AXL integration, you will have to export the E.164 extensions from Unified CM into a comma-separated values (CSV) file and perform the necessary translations on the alternate extensions (in Excel, for example) prior to using the Bulk Administration Tool (BAT) to import them into Unity Connection. For more details on using the Cisco Unity Connection Bulk Administration Tool, refer to the latest version of the *User Moves, Adds, and Changes Guide for Cisco Unity Connection*, available at

[http://www.cisco.com/en/US/products/ps6509/prod\\_maintenance\\_guides\\_list.html](http://www.cisco.com/en/US/products/ps6509/prod_maintenance_guides_list.html)

## Enhanced Message Waiting Indicator (eMWI)

Enhanced Message Waiting Indicator (eMWI) is an enhancement to traditional MWI, and it provides a visual indication of the number of voice messages. Traditional MWI works in a binary format by either enabling or disabling the message lamp on the phone whenever a new voice message arrives in or is deleted from a user's voicemail box. eMWI works with Cisco Unity Connection and is supported on the Cisco Unified IP Phones 8900 and 9900 Series SIP phones.

eMWI is a visual indication of unplayed messages in the user's voicemail box, with a colored indication depicting the status of the message. An unplayed message displays a red indication on the screen of the phone. eMWI is supported on Unified CM for Cisco Unity Connection through SIP and SCCP integrations. eMWI does not function when the system is running in SRST mode. In an integration with Cisco Unity Connection, only the messages stored on the Cisco Unity Connection servers will be indicated with eMWI, and any messages stored on an external IMAP server will not be indicated.

eMWI works in distributed call processing environments with Unified CM. In a system with distributed call processing and centralized voice messaging integration, where one cluster provides the connectivity to the voice messaging server through an intercluster trunk (H.323 or SIP), eMWI updates over the intercluster trunk are supported and are displayed on the end device. (See [Figure 21-16](#).)



### Note

eMWI also works in a distributed call processing environment with centralized messaging over an intercluster trunk (H.323 or SIP).

**Figure 21-16** Enhanced Message Waiting Indicator (eMWI)

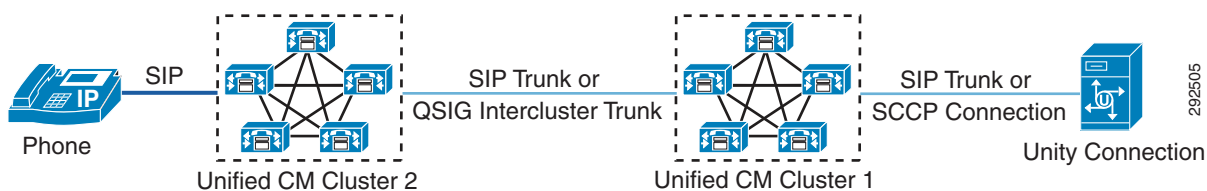

[Figure 21-17](#) illustrates eMWI over an intercluster trunk (H.323 or SIP) in a distributed call processing environment with centralized voice messaging.

**Figure 21-17 eMWI with Distributed Call Processing and Centralized Voice Messaging**

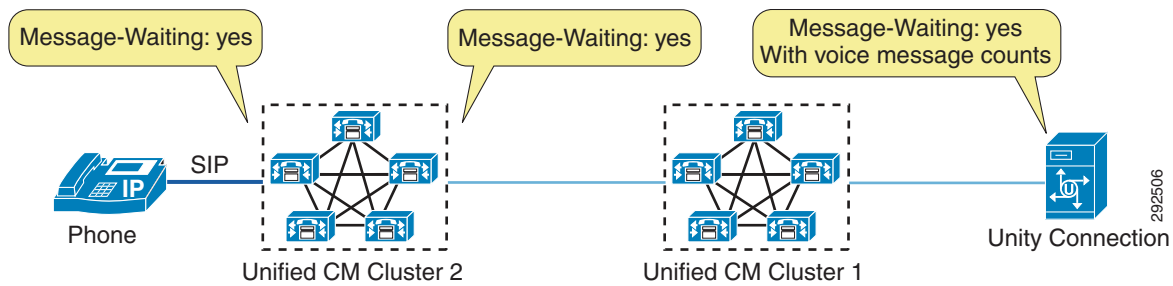

As shown in [Figure 21-17](#), Cluster 2 and its voice messaging solution support eMWI, but Cluster 1 does not. If an eMWI update with a voice message count is sent from the voice messaging solution intended for the Cluster 2 phone, Cluster 1 will forward only a standard MWI to Cluster 2 without the voice message count.

The following guidelines apply to eMWI:

- All clusters should support eMWI. If an intermediate cluster does not support eMWI, then the terminating cluster will receive a standard MWI only without voicemail counts.
- Standard MWI does not generate much traffic because it sends only a change of lamp state (ON or OFF). However, enabling eMWI can increase the amount of traffic because it also sends message counts from the messaging system. The amount of traffic depends on the number of messages and change notifications.

## Voice Port Integration with a Unified CM Cluster

When deploying Cisco Unity Connection in a single-site messaging environment, integration with the Unified CM cluster occurs through the SCCP voice ports or SIP trunks. Design considerations must include proper deployment of the voice ports among the Unified CM subscribers so that, in the event of a subscriber failure (Unified CM failover), users and outside calls can continue to access voice messaging. (See [Figure 21-18](#).)

**Figure 21-18** Cisco Unity Connection Server(s) Integrated with a Unified CM Cluster (No Dedicated Backup Servers)

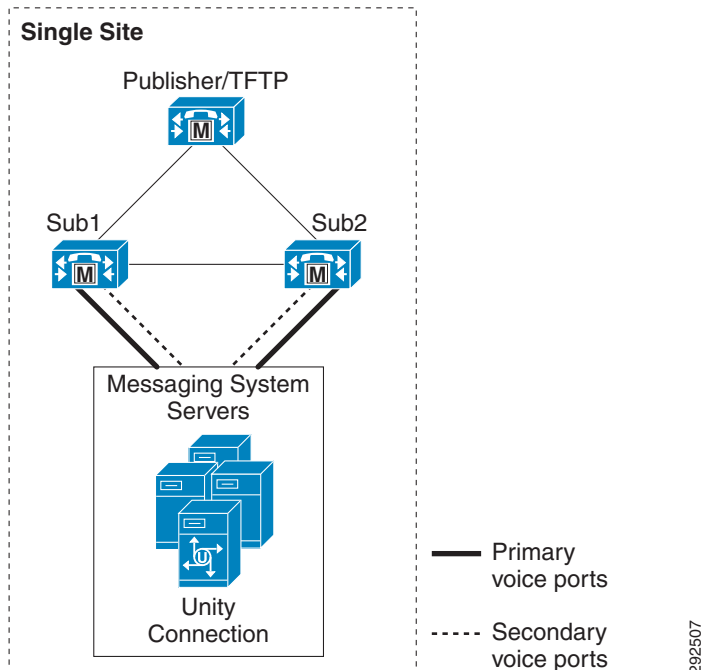

The Unified CM cluster in [Figure 21-18](#) employs 1:1 server redundancy and 50/50 load balancing. During normal operations, each subscriber server is active and handles up to 50% of the total server call processing load. In the event of a subscriber server failure, the remaining subscriber server takes up the load of the failed server.

This configuration uses two groups of voicemail ports, with each group containing one-half of the total number of licensed voice ports. One group is configured so that its primary server is Sub1 and its secondary (backup) server is Sub2. The second group is configured so that Sub2 is the primary server and Sub1 is the backup.

Make sure that MWI-only ports or any other special ports are equally distributed between the two groups. During the configuration of the voice ports, pay special attention to the naming convention. When configuring the two groups of ports in Cisco Unity Connection, make sure that the device name prefix is unique for each group and that you use the same device name when configuring the voicemail ports in Unified CM Administration. The device name prefix is unique for each group of ports in this example, with group Sub1 using CiscoUM1 as the device name prefix and Sub2 using CiscoUM2 in this example.

For additional design information on the ratio of inbound to outbound voicemail ports (for MWI, message notification, and TRaP), refer to the *Cisco Unity Connection System Administration Guide* available at <http://www.cisco.com>.

**Note**

The device name prefix is unique for each group of ports and must match the same naming convention for the voicemail ports configured in Unified CM Administration.

In Unified CM Administration, half of the ports in this example are configured to register using the unique device name prefix of CiscoUM1, and the other half are configured to register using the unique device prefix CiscoUM2. (See [Table 21-6](#).) When the ports register with Unified CM, half will be registered with subscriber server Sub1, and the other half will be registered with Sub2, as shown in [Table 21-6](#).

**Table 21-6** Voicemail Port Configuration in Unified CM Administration

Device Name	Description	Device Pool	SCCP Security Profile	Status	IP Address
CiscoUM1-VI1	Unity Connection 1	Default	Standard Profile	Registered with sub1	1.1.2.9
CiscoUM1-VI2	Unity Connection 1	Default	Standard Profile	Registered with sub1	1.1.2.9
CiscoUM1-VI3	Unity Connection 1	Default	Standard Profile	Registered with sub1	1.1.2.9
CiscoUM1-VI4	Unity Connection 1	Default	Standard Profile	Registered with sub1	1.1.2.9
CiscoUM2-VI1	Unity Connection 1	Default	Standard Profile	Registered with sub2	1.1.2.9
CiscoUM2-VI2	Unity Connection 1	Default	Standard Profile	Registered with sub2	1.1.2.9
CiscoUM2-VI3	Unity Connection 1	Default	Standard Profile	Registered with sub2	1.1.2.9
CiscoUM2-VI4	Unity Connection 1	Default	Standard Profile	Registered with sub2	1.1.2.9

**Note**

The naming convention used for the voicemail ports in Unified CM Administration must match the device name prefix used in Cisco UTIM, otherwise the ports will fail to register.

## Voice Port Integration with Dedicated Unified CM Backup Servers

This Unified CM cluster configuration allows each subscriber server to operate at a call processing load higher than 50%. Each primary subscriber server has either a dedicated or shared backup server. (See Figure 21-19.) During normal operation, the backup server processes no calls; but in the event of failure or maintenance of a Subscriber server, the backup server will then take the full load of that server.

**Figure 21-19** Cisco Unity Connection Server(s) Integrated with a Single Unified CM Cluster with Backup Subscriber Server(s)

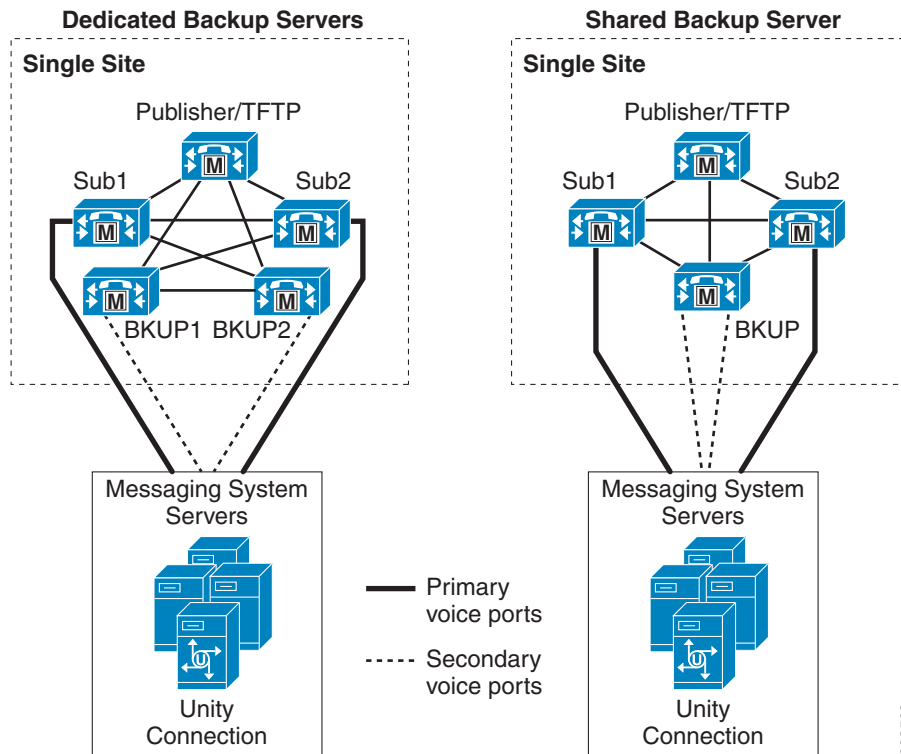

Configuration of the voicemail ports in this case is similar to the 50/50 load-balanced cluster. However, instead of configuring the voice ports to use the opposite subscriber server as the secondary server, the individual shared or dedicated backup server is used. In the Unified CM cluster with a shared backup server, both of the secondary ports for the subscriber servers are configured to use the single backup server.

The voice port names (device name prefix) must be unique for each Cisco UTIM group and must be the same as the device names used on the Unified CM server.

To configure the voicemail ports on Cisco Unity Connection, use the Telephony Integration section of the Unity Connection Administration console. For details, refer to the Cisco Unity Connection administration guides available at <http://www.cisco.com>.

## IPv6 Support with Cisco Unity Connection

The current requirements for IP addressing are surpassing the available set of IP address with IPv4, the current version of IP addressing. Therefore, most IP-based solutions are moving toward incorporating support for IPv6, which provides many more available IP addresses than IPv4. Cisco Unity Connection supports IPv6 addressing with Cisco Unified Communications Manager system integrations through SCCP or SIP. At a component level, dual-stack addressing (both IPv4 and IPv6) is supported over call control and media only.

Cisco Unity Connection supports following IPv6 address types:

- Unique Local Address
- Global Address

**Note**

---

Voice messages are stored as .wav files and are independent of IPv6 or IPv4.

---

IPv6 support is disabled by default, but system administrators can enable IPv6 and configure IPv6 address settings either in Cisco Unified Operating System Administration or in the command line interface (CLI). Cisco Unity Connection can obtain an IPv6 address either through router advertisement, through DHCP, or from addresses configured manually either in Cisco Unified Operating System Administration or through the CLI. Cisco Unity Connection Administration and Cisco Personal Communications Assistant can be accessed using IPv6 addresses.

**Note**

---

IPv6 addressing cannot be enabled during installation or upgrade of Cisco Unity Connection. Cisco Unity Connection does not support "IPv6 ONLY" server configuration. Cisco Unity Connection supports Unicast only for IPv6.

---

Cisco Unity Connection over IPv6 supports following functionality:

- Cisco Unity Connection offers auto-discovery functionality over IPv6, which allows Unity Connection to search for Microsoft Exchange servers to communicate with.
- Cisco Unity Connection can be integrated with an IPv6 Microsoft Exchange 2007 or 2010 server to enable the Single Inbox feature.
- Cisco ViewMail for Outlook (VMO) supports communication between Outlook and Cisco Unity Connection over IPv6.
- Voice messages received on Cisco Unity Connection can be accessed using any IMAP client such as Outlook over IPv6.
- Cisco Unity Connection can be integrated with LDAP over IPv6 to import the user information.
- Cisco Unity Connection also offers Telephone Record and Playback (TRaP) functionality over IPv6, which enables users to record or play back messages over an IPv6-enabled phone so that signaling can happen over IPv6.

**Note**

---

Cisco Unity Connection does not provide support for dual-stack addressing mode (both IPv4 and IPv6) in Cisco Business Edition 3000 and 5000.

---

## Single Inbox with Cisco Unity Connection

Cisco Unity Connection supports the Single Inbox feature with Microsoft Exchange 2003, 2007, and 2010 (clustered or non-clustered), thereby providing Unified Messaging for voicemail. Cisco Unity Connection can support all three of these Microsoft Exchange versions simultaneously or any one of them separately. Unity Connection also supports interoperability with the Microsoft Business Productivity Online Suite (BPOS)-Dedicated Services and Microsoft Office 365 cloud-based exchange server. Unity Connection uses Microsoft Exchange Online to enable the Single Inbox feature. For more information, refer to the latest version of the *Unified Messaging Guide for Cisco Unity Connection*, available at

[http://www.cisco.com/en/US/partner/products/ps6509/prod\\_maintenance\\_guides\\_list.html](http://www.cisco.com/en/US/partner/products/ps6509/prod_maintenance_guides_list.html)

All voice messages, including those sent from Cisco Unity Connection ViewMail for Microsoft Outlook, are first stored in Cisco Unity Connection and are immediately replicated to the Microsoft Exchange mailbox for the recipient; however, replication is optional. Also, this feature can be configured per individual user.

Cisco Unity Connection support of Unified Messaging for voicemail involves several design considerations. The user's email becomes a single container for all messages, including email and voicemail. If a message is moved to any other folder under the user's Inbox, it will continue to show up in Cisco Unity Connection. However, if the user moves voice messages into Outlook folders that are not under the Inbox folder, the messages are deleted from Cisco Unity Connection but they can still be played by using ViewMail for Outlook because a copy still exists in the Outlook folder. If the user moves the messages back into the Inbox folder or into a folder under the Inbox folder, the message is synchronized back into the Cisco Unity Connection mailbox for that user. In addition, when a user deletes a voice message from Cisco Unity Connection or when Cisco Unity Connection automatically deletes a voice message because of message aging, the message is also deleted from Microsoft Exchange. Likewise, when a voice message is deleted from Microsoft Exchange, it is also deleted from Cisco Unity Connection.

If a message is marked as secured and private, the actual message is not replicated in Microsoft Exchange; instead, a placeholder with a brief description is created for the message. The only copy of actual message stays on Cisco Unity Connection and the user retrieves the message, it is played back from Cisco Unity Connection directly instead of from a local source, unlike in the case of a normal message. This also means that there is no local access to the audio file if it is accessed through voicemail from Outlook. Movement of the secure and private message to any folder other than Inbox and folders below Inbox would result in deletion of the message permanently, thereby leaving no opportunity for retrieval.



---

**Note**

All voice messages remain on the Cisco Unity Connection Server regardless of the type of messaging deployment. Cisco Unity Connection is the authoritative source of voice messaging traffic, notifications, and synchronizations.

---

The amount of space a single voicemail message can acquire is configured on the Cisco Unity Connection server and is similar to message aging. The maximum size for a voicemail message is also configured on the Microsoft Exchange Server. Typically, the Microsoft Exchange Server maintains a larger size than Cisco Unity Connection that is synchronized to the mailbox. Hence, the minimum size of the message in Microsoft Exchange should be bigger than the maximum size in Cisco Unity Connection.

From a security aspect for communications between Cisco Unity Connection and Microsoft Exchange, HTTPS is chosen as the default option. HTTP is also supported but not recommended because it reduces security and might also need further configuration on Microsoft Exchange. At the same time, there is an option to validate the Microsoft Exchange certificate, provided that access to the certificate server is available.



Cisco Unity Connection can be integrated with IBM Lotus Domino using software from Cisco partners Esnatech and Donoma to enable the Single Inbox feature. Esnatech Office-LinX™ Cloud Connect Edition and Donoma Unify for Lotus Notes both enable integration between Unity Connection and IBM Lotus Domino. For more detail information on deployment, installation, and configuration of these products, refer to the documentation available at <http://www.esnatech.com/landing/cisco.htm> and <http://donomasoftware.com/donoma-unify-for-lotus-notes/>.

Cisco Unity Connection also supports integrated voice and fax services with cloud-based applications such as Google Apps Gmail and VMware Zimbra. Unity Connection can be integrated with these email applications using Esnatech Office-LinX™ Cloud Connect Edition. This solution allows for bidirectional synchronization of voice messages between Cisco Unity Connection and these email applications. (See Figure 21-20.)

**Figure 21-20 Cisco Unity Connection Deployment with Cloud-Based Google Email Application**

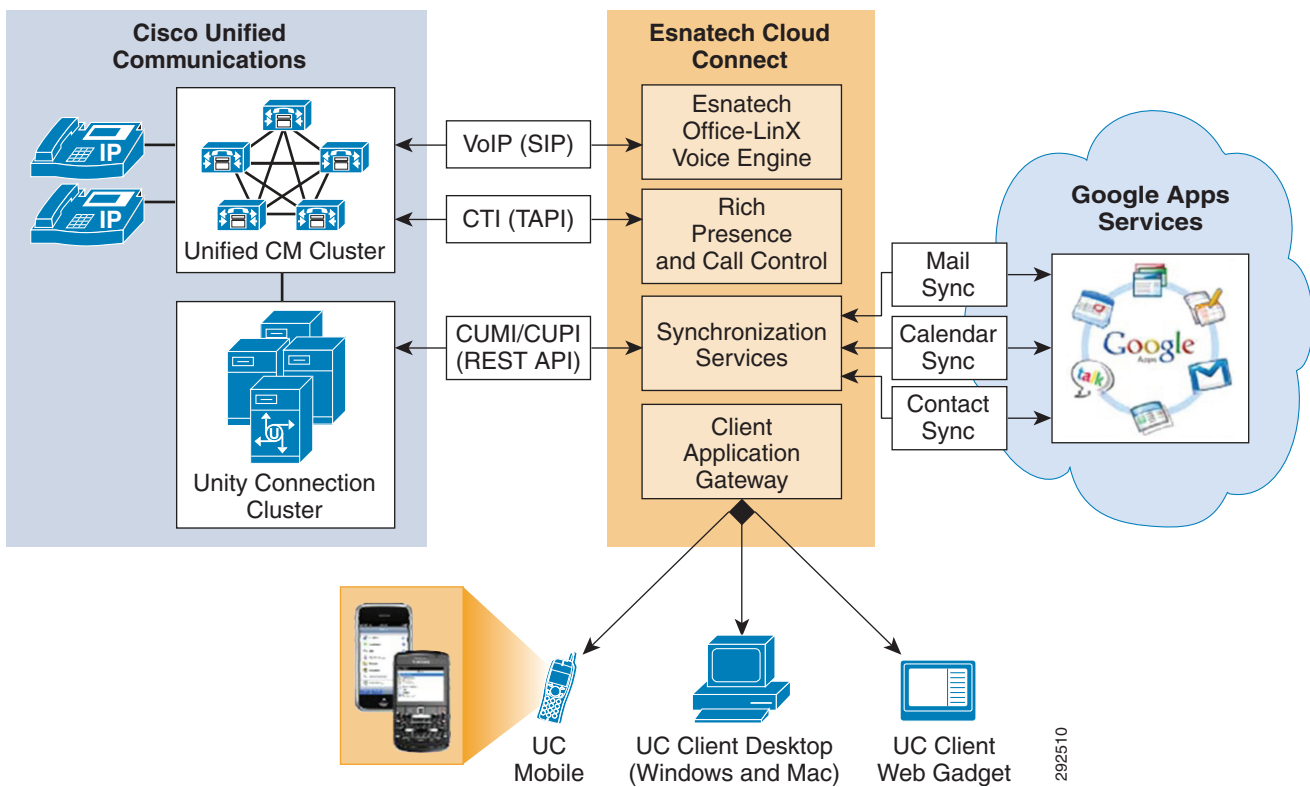

Esnatech Cloud Connect Edition uses the Cisco Unity Connection Messaging Interface (CUMI) API and the Cisco Unity Connection Provisioning Interface (CUPI) API for synchronization of subscriber and messaging information. Users can also initiate calls through Gtalk using the Click-to-Dial feature. This call control information gets exchanged with Cisco Unified Communications Manager through the CTI (TAPI) interface. For more detail information on deployment, installation and configuration, refer to the documentation available at <http://www.esnatech.com/landing/cisco.htm>.

## Best Practices for Deploying Cisco Unity Express

When deploying Cisco Unity Express, use the following guidelines and best practices:

- Ensure that the IP phones having Cisco Unity Express as their voicemail destination are located on the same LAN segment as the router hosting Cisco Unity Express.
- If uninterrupted automated attendant (AA) and voicemail access is required for a site deployed with Cisco Unity Express, ensure that Cisco Unity Express, SRST, and the PSTN voice gateway are all located at the same physical site. Hot Standby Router Protocol (HSRP) or other redundant router configurations are not currently supported with Cisco Unity Express.
- Each mailbox can be associated with a primary extension number and a primary E.164 number. Typically, this number is the direct-inward-dial (DID) number that PSTN callers use. If the primary E.164 number is configured to any other number, use Cisco IOS translation patterns to match either the primary extension number or primary E.164 number so that the correct mailbox can be reached during SRST mode.

## Voicemail Integration with Unified CM

- Each Cisco Unity Express site must be associated with a CTI route point for voicemail and one for AA (if licensed and purchased), and you must configure the same number of CTI ports as Cisco Unity Express ports licensed. Ensure that the number of sites with Cisco Unity Express does not exceed the CTI scalability guidelines presented in the chapter on [Call Processing, page 8-1](#).
- Cisco Unity Express is associated with a JTAPI user on Unified CM. Although a single JTAPI user can be associated with multiple instances of Cisco Unity Express in a system, Cisco recommends associating each dedicated JTAPI user in Unified CM with a single Cisco Unity Express.
- If Unified CM is upgraded from a previous version, the password of the JTAPI user automatically gets reset on Unified CM. Therefore, after the upgrade, the administrator must make sure that the JTAPI password is synchronized between Cisco Unity Express and Unified CM so that Cisco Unity Express can register with Unified CM.
- The CTI ports and CTI route points can be defined in specific locations. Cisco recommends using locations-based call admission control between Unified CM and Cisco Unity Express. RSVP may also be used.
- Ensure proper Quality of Service (QoS) and bandwidth for signaling traffic that traverses the WAN between Cisco Unity Express and Unified CM. Provision 20 kbps of bandwidth for CTI-QBE signaling for each Cisco Unity Express site. See the chapter on [Network Infrastructure, page 3-1](#), for more details.
- The CTI-QBE signaling packets from Unified CM to Cisco Unity Express are marked with a DSCP value of AF31 (0x68). Unified CM uses TCP port 2748 for CTI-QBE signaling.
- The Unified CM JTAPI library sets the proper IP Precedence bits in all outgoing QBE signaling packets. As a result, all signaling between Cisco Unity Express and Unified CM will have the proper QoS bits set.

## Cisco Unity Express Codec and DTMF Support

Calls into Cisco Unity Express use G.711 only. Cisco recommends using a local transcoder to convert the G.729 calls traversing the WAN into G.711 calls. You can configure Unified CM regions with the G.711 voice codec for intra-region calls and the G.729 voice codec for inter-region calls.

If transcoding facilities are not available at the Cisco Unity Express site, provision enough bandwidth for the required number of G.711 voicemail calls over the WAN. Configure the Unified CM regions with the G.711 voice codec for calls between the IP phones and Cisco Unity Express devices (CTI ports and CTI route points).

Cisco Unity Express does not support in-band DTMF tones; it supports only DTMF relay. With Cisco Unity Express, DTMF is carried out-of-band via either the SIP or JTAPI call control channels. Cisco Unity Express 2.3 supports G.711 SIP calls with RFC 2833 into Cisco Unity Express.

## JTAPI, SIP Trunk and SIP Phone Support

Cisco Unified CM supports SIP trunking protocol; however, Cisco Unity Express uses JTAPI to communicate with Unified CM. Cisco Unity Express supports both SCCP and SIP phones.

- Configure a SIP trunk for SRST and Unified CM for support of SIP phones (through JTAPI).
- Cisco Unity Express supports G.729 SIP calls via a transcoder, with the ability added in Cisco IOS Release 12.3(11)XW for RFC 2833 to pass through a transcoder.
- Cisco Unity Express supports delayed media (no SDP in the INVITE message) for call setup in case of a slow-start call from Unified CM.
- Cisco Unity Express supports both blind and consultative transfer, but the default transfer mode is consultative transfer (semi-attended) using REFER in SIP calls. Use the Cisco Unity Express command line interface to explicitly change the transfer mode to consultative transfer using REFER or blind transfer using BYE/ALSO. If REFER is not supported by the remote end, BYE/ALSO will be used.
- Cisco Unity Express supports outcall for voice message notifications. It also supports consultative transfers. During both of these call setups, Cisco Unity Express can receive 3xx responses to the INVITE. Cisco Unity Express processes only 301 (Moved Permanently) and 302 (Moved Temporarily) responses to the INVITE. This requires the URL from the Contact header from the 3xx response to be used to send a new INVITE. 305 (Use Proxy) responses are not supported.

**Note**

For compatibility between Cisco Unified CM and Cisco Unity Express, refer to the *Cisco Unity Express Compatibility Matrix*, available at

[http://www.cisco.com/en/US/docs/voice\\_ip\\_comm/unity\\_exp/compatibility/comp.html](http://www.cisco.com/en/US/docs/voice_ip_comm/unity_exp/compatibility/comp.html).

For more information about Cisco Unity Express, refer to the product documentation available at <http://www.cisco.com>.

# Third-Party Voicemail Design

This section discusses various options for deploying third-party voicemail systems with Cisco Unified Communications, and it covers both integration and messaging.



## Note

This section does not discuss how to size a third-party voicemail system for ports and/or storage. For this type of information, contact your voicemail vendor, who should be better able to discuss the individual requirements of their own system, based upon specific traffic patterns.

## Integration

*Integration* is defined as the physical connection between a voicemail system and its associated PBX or call processing agent, and it also provides for the feature set between the two.

There are many voicemail vendors, and it is not uncommon for customers to want to continue to use an existing voicemail system when deploying Cisco Unified CM. With this requirement in mind, Cisco provides support for the industry standard voicemail protocol known as Simplified Message Desk Interface (SMDI). SMDI is a serial protocol that provides all the necessary call information required for a voicemail system to answer calls appropriately and is probably the most common method deployed for voicemail integration between dissimilar systems from various vendors.



## Note

Cisco does not test or certify any third-party voicemail systems. Within the industry, it is generally considered to be the responsibility of the voicemail vendor to test and/or certify their products with various PBX systems. Cisco does, of course, test its interfaces to such equipment and will support these interfaces regardless of which third-party voicemail system is connected.

An alternative to SMDI for voicemail integration is QSIG, which also allows a third-party PBX to connect to Unified CM through a Primary Rate Interface (PRI) T1/E1 trunk. Each method has its own advantages and disadvantages, and the method you employ will largely depend on how your voicemail system is integrated to your current PBX.

There are other methods for connecting voicemail systems to Unified CM (such as PRI ISDN trunks in conjunction with SMDI), but these methods are uncommon.

Today there are other potential methods of voicemail integration, such as H.323 or SIP. However, due to the varying methods of vendor implementation, features supported, and other factors, these third-party voicemail integrations will have to be evaluated on a per-customer basis. Customers are advised to contact their Cisco Account Team and/or Cisco Partner to discuss these options further.

## Messaging

*Messaging* is defined as the exchange of messages between voicemail systems, and there are several open standards for this purpose.

The most common protocol deployed to allow messaging between dissimilar systems is Voice Profile for Internet Mail (VPIM). VPIM has seen several updates to its specification, and although Version 2 is not the latest, it still appears to be the most widely adopted. The messaging protocol prior to VPIM is Audio Messaging Interchange Specification - Analog (AMIS-A), and it is fairly rare in its adoption due mainly to its cumbersome user interface as well as the analog technology it employs and its lack of features.