



## QUICK REFERENCE GUIDE



### **Cisco Unified CallConnector for Microsoft Windows 1.5 Mobility Service Quick Reference Guide**

- 1** Overview, page 2
- 2** Single Number Reach, page 2
- 3** Personal Routing Rules, page 4
- 4** Mid-Call Feature, page 5
- 5** Dial-in Access, page 5
- 6** Using the Rules Window, page 8
- 7** Setting Up a Single Number Reach Rule, page 10
- 8** Single Number Reach Rules: Examples, page 18
- 9** Cisco UCC Mobility Service User Features, page 20
- 10** Additional Information, page 22

# 1 Overview

Cisco Unified CallConnector (Cisco UCC) Mobility Service allows you to receive your business calls at any of your contact numbers. If you are not available, then the caller is able to leave a message in your voice mailbox. The Cisco UCC Mobility Service can be personalized in some of the following ways:

- You can setup routing rules based on your availability (available, busy, away, and unavailable) and/or your location (work, home, on the road or vacation).
- You can select which calls are forwarded to you.
- You can condition the routing rules to account for workdays, weekends, and holidays and for work hours and non-work-hours.

In addition to routing your incoming calls, the Cisco UCC Mobility Service allows you to dial-in and make calls leveraging your company telephone resources and access the following features:

- Record the conversation or ask your called party to leave a voice message in your mailbox.
- Add additional parties (up to six) in to the conversation.
- Switch the call to your work, home, or mobile number.

The Cisco UCC Mobility Service is available as an optional component of the Cisco UCC Server. The call routing rules are personalized from within Microsoft Internet Explorer and Microsoft Outlook using the Cisco UCC client.

## 2 Single Number Reach

The Single Number Reach (SNR) feature routes your incoming business calls to the numbers you specify by ringing all the numbers simultaneously. If you answer at one of these numbers then you will be connected to the caller, otherwise the incoming call is sent to your Cisco Unity Express voice mailbox. Each user can customize the Single Number Reach routing of calls. You can setup rules to specify when and which call is to be routed. You can also specify the numbers where you can be reached based on your availability and location setting. The Single Number Reach feature is an intelligent user-controlled routing of business calls.

You can now give your business contacts a single number to reach you no matter where you are. You can then control which calls and the time periods in which to receive business calls. Your personal numbers are not visible to the business callers.

The Single Number Reach service can ring one or more of following phone numbers simultaneously:

- Work phone
- Home phone
- Mobile phone
- Any alternate phone number

There can be different call routing rules for:

- Holidays
- Workdays or weekends
- Working hours and after work hours

**Figure 1** Number Reach with Cisco Unified CME and Cisco Unified Mobility Connector

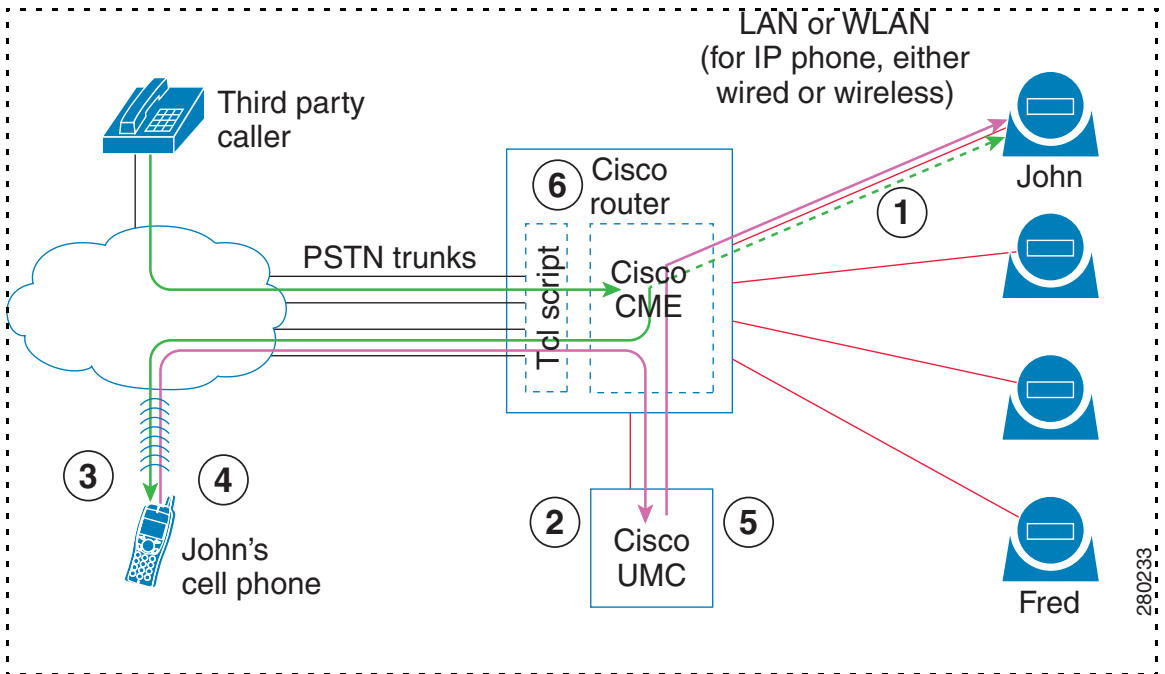

280233

## How the Single Number Reach Service Works

1. Incoming call rings your business IP phone. The IP phone rings briefly (for example, John's business IP phone).
2. The Cisco UCC Mobility Service monitors the number on your behalf and answers the call. The caller is asked hold, while other numbers are tried.
3. Based on your personal settings, one or more calls are made to your reach numbers (for example, John's mobile phone).
4. If you answer the call, the Mobility Service requests a password.
5. If you enter a valid password, then you are connected to the caller.
6. If you cannot be reached, then the caller is sent to your voice mailbox (for example, John's voice mailbox).

## 3 Personal Routing Rules

The Single Number Reach service requires you to setup rules specifying how to handle your incoming business calls.

Rules are setup from the Cisco UCC Rules window. Each rule consists of two sections - a set of conditions and a set of actions to be executed when the conditions are met. Conditions are specified values for a selected set of parameters that are constantly monitored by the Cisco UCC. Actions are the tasks that are performed automatically on your behalf when all the condition parameters are true.

You can select from some of the following rule conditions when setting up a rule:

- Whether to trigger the rule when an Incoming call rings your IP phone (This condition must be selected for Single Number Reach rules.)
- Telephone number of the caller
- Whether the caller's number is in your personal contacts, speed dial list, corporate directory, or in a list of telephone numbers
- Your current availability — Available, Away, Busy, or Unavailable
- Your current location — Home, Work, On the Road, or On Vacation
- Whether the day is a weekend, holiday, workday, or a particular day of the week
- Whether the current time is in work hours or after work hours

Tasks that can be performed automatically for you:

- Route incoming calls to your work, home, or mobile phone.
- Update your availability status to Available, Away, Busy or Unavailable.
- Update your location to Home, Work, On the road, or On vacation.

- Update your status message to Busy, Be right back, Stepped out, Away from keyboard, On the phone, or a Custom message.

Each user can setup one or more policies or rules to tell the Cisco UCC system to perform the specified tasks automatically on their behalf.

## 4 Mid-Call Feature

The Cisco UCC Mid-Call feature is an option that allows you to access Cisco Unified Communications Manager Express (Cisco CME) features such as transferring to your voice mailbox, extending the current Single Number Reach call to a multiparty conference and more.

For example, you are on a call extended through the Single Number Reach service and you must add a colleague to the call. You can enter the 'Add Number' access code and the colleague's telephone number. If available, the number is joined to your call.

You can also change your availability status and location using keypad access codes. This can not only inform colleagues of your current status but can also be used to trigger previously setup call routing rules. For example if you want to be reached on your mobile phone, then you can change your location to "On the Road" to activate the "On the Road rule". You can also use the Mid-Call feature to move the call from the current phone to another phone.

## 5 Dial-in Access

The Cisco UCC Dial-In Access feature allows you to access the Cisco Unified CME features for your business calls when you are away from the office. To place long-distance or international calls, you can call in and use your company's phone lines to place the calls. You can also access the Cisco Unified CME features such as setting up a multiparty conference call and more from your mobile or home phones. With Dial-In Access, you can establish a phone conference from your mobile phone without access to the physical IP phone.

The features available from the Dial-In Access functionality include:

- Make a business call from home or mobile phone utilizing Cisco Unified CME.
- Add additional parties in to the call or setup multiparty calls using the Cisco Unified CME conference service.
- Transfer the current call to your voice mailbox.
- Transfer the current call to work, home, mobile, or custom phone number.
- Change presence status and location.

**Figure 2 Remote PBX Call Transfer with the Cisco UCC Mobility Service**

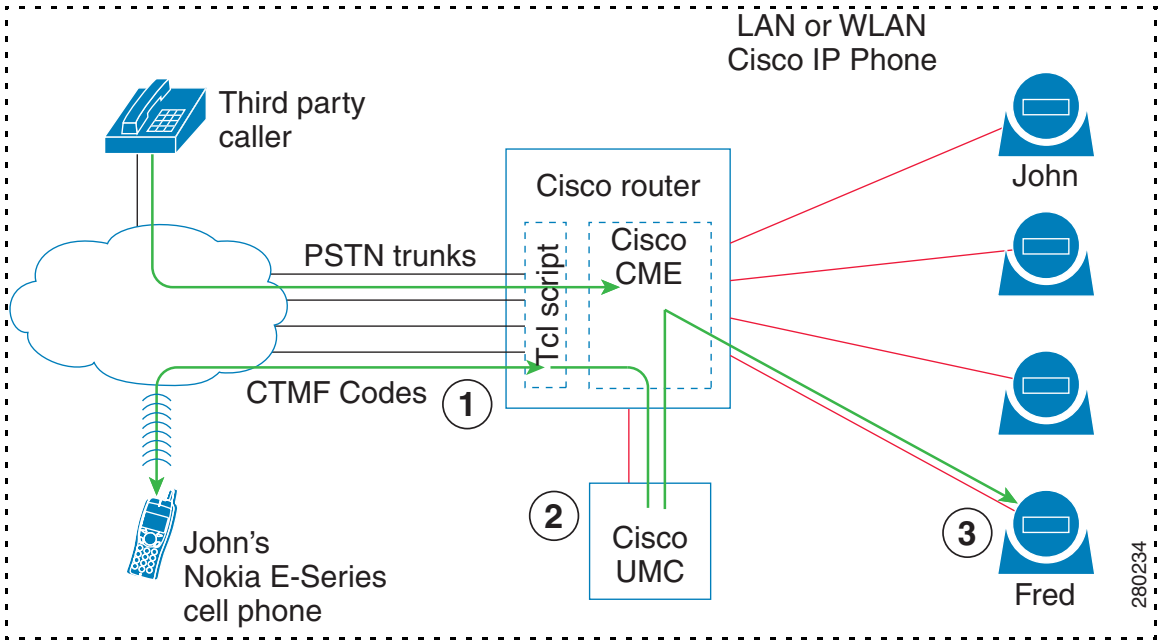

280234

## How the Dial-In Access Service Works

1. When you call in to the Dial-In Access number from your mobile phone the Cisco UCC Mobility Service answers the call (for example, John's cell phone).
2. Depending on the configuration settings, the Cisco UCC Mobility Service might prompt you for the extension number or password.
3. After being authenticated, you can place an outgoing call, for example to Fred's business phone. Fred will see the call placed from the business number, hiding your originating number.
4. When on the call, additional parties can be added to form a multiparty conference.

The default key command mappings for the Mid-Call and Dial-In Access features are listed in Table 1:

**Table 1**      **Default Key Command Mappings for the Mid-Call and Dial-In Access Features**

<b>Keys</b>	<b>Function</b>	<b>Description</b>
*0	Help menu	Describes the available options and the associated access codes.
*1	Change status	Announces your current status and then plays a menu of status change choices. You can make a selection from the key pad to update your availability status.
*2	Change location	Announces your current location setting and then plays a menu of location choices. You can select an option to update your location setting from any telephone.
*4	Transfer to a number	Asks you to enter a phone number and press # to transfer to the number. If you decide to cancel the operation after you have entered the number, you can press * to cancel.
*5	Add another party to the call	Asks you to enter a phone number and press # to add in the other party. If you decide to cancel the operation after you have entered the number, you can press *.
*6	Transfer to your mobile phone	Transfers the current call to your mobile phone as provisioned for you.
*7	Transfer to your work phone	Transfers the call to your work phone.
*8	Transfer to home phone	Transfers the call to your home phone.
*9	Leave a voice message	Transfers the call to your voice mailbox to allow the caller to leave a message.
##	End Mid-Call Features or Dial-in Access session	Terminates the Mid-Call Features or Dial-in Access session.
**	On Hold (for Share-Call Appearance only)	Puts the call on hold. You can then pick up this call from the IP phone by pressing the line button.

## 6 Using the Rules Window

The Rules Window is one of the applications included in Cisco UCC. It displays information on your call routing rules. Each rule is represented by a line in the Rules window. You can enable, disable, or expand each rule to view more details.

### Viewing Rules

Open the Cisco UCC Applications window and click the Rules icon. To view more information about the rule, expand the rule by clicking the Plus sign or the Expand button.

### Enable/Disable a Rule

A rule is 'Enabled' when a green circle with a check appears. It is 'Disabled' when a red circle with a cross appears.

### Add a New Rule

Right click in the Rule Window and select New Rule or click the Add button at the bottom of the window.



## Updating a Rule

Right click in the Rule you want to update and select Edit or click the Edit button at the bottom of the window.

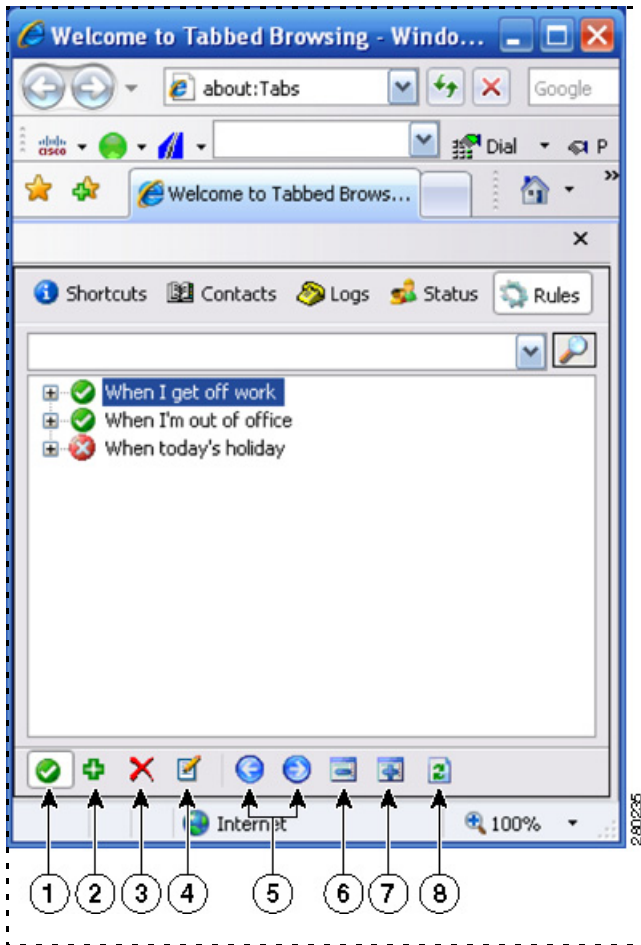

**Table 2 Rules Window Buttons**

<b>1</b>	Rule State is a green circle with a check for Enabled or a red circle with a cross to indicate disabled. The state of the currently selected rule is displayed in the button. Click the button to change the rule state.	<b>5</b>	The left and right navigation buttons allow you to move to the next or previous rule.
<b>2</b>	New Rule button is the green plus sign. This opens the Rules Wizard window.	<b>6</b>	Minimize button changes the information display in the Rules window to only show the name of the rule.
<b>3</b>	Delete button removes the currently selected rule.	<b>7</b>	Maximize button displays the details of all the rules in the Rules Window.
<b>4</b>	Edit button allows you to make changes to the selected rule. It opens the Rules Wizard to display the details of the selected rule.	<b>8</b>	Refresh button reloads the currently defined rules from the Cisco UCC Server.

## 7 Setting Up a Single Number Reach Rule

The general steps for adding a new personal custom rule include the follow steps:

1. Launch Internet Explorer or Outlook and open the CallConnector Contact window.
2. Click the **Rules** tab in the Contacts window.
3. Click the New Rule button and a “Manage Rule” window pops up for you to add a Single Number Reach rule.
4. Check the **Enable This Rule** option.
5. Enable at least one condition and set the parameters for each enabled condition.



---

**Note** For Single Number Reach rules the condition “If a call comes to this number” must be set.

---

6. Enable the Single Number Reach service and select the numbers to call.
7. Click Finish to exit.

After a rule is created, it can be enabled or disabled. Disabled rules are rules that are configured but not active.

**Figure 3** Screen for Managing Single Number Reach Rules

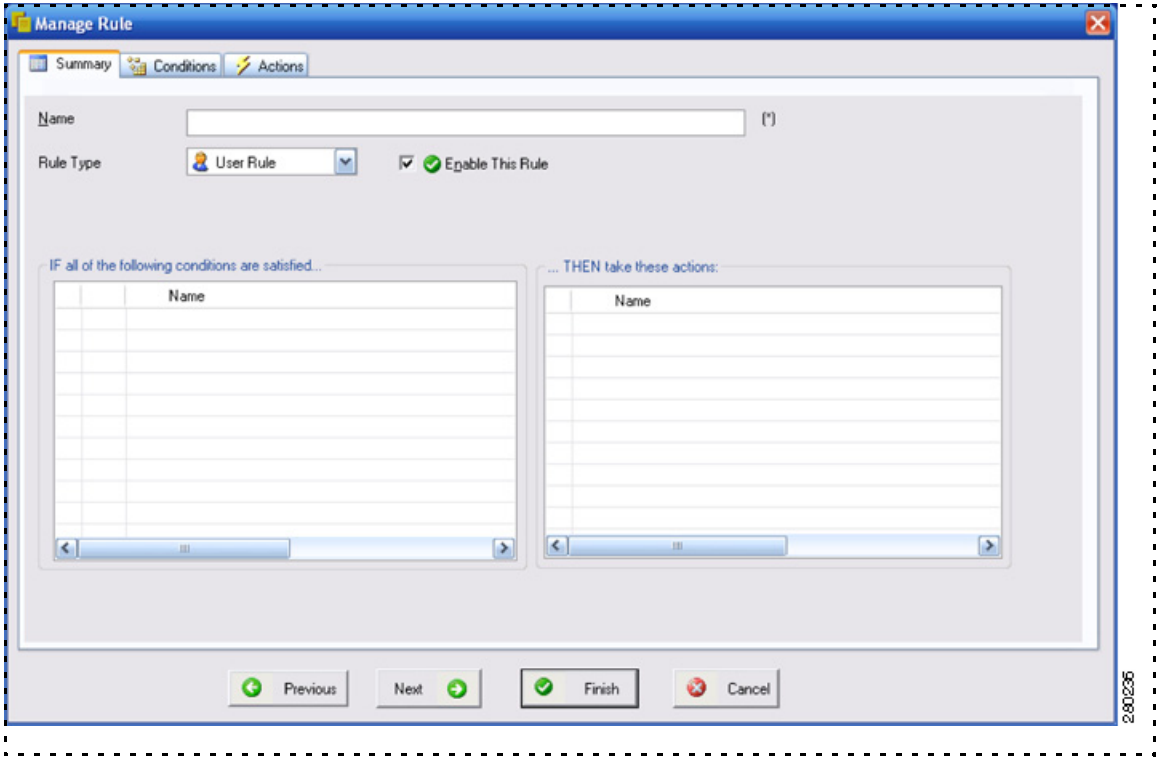







## Options for Setting Up Single Number Reach

Options	Description
Name	Assign a name to identify the rule.
Enable This Rule	Check to enable or uncheck to disable the rule.

# Conditions for Setting Up Single Number Reach

**Table 3**      *Checking Incoming Call Conditions*

<p>IF the Calls come to this number:</p> <p><input checked="" type="radio"/>  Work Phone: 4151</p> <p><input type="radio"/>  Work Phone2: 4110</p> <p><input type="radio"/> This particular number: <input type="text"/></p>	<p>You can specify the destination phone numbers of incoming calls that trigger the SNR service.</p> <p>All selected conditions for the rule have to be true.</p> <p>All the numbers have to be CME extensions that are in the CallConnector corporate directory.</p>						
<p>IF Calling Number is in the following</p> <p><input checked="" type="checkbox"/>  My Personal Contacts</p> <p><input type="checkbox"/>  My Speed Dial list</p> <p><input checked="" type="checkbox"/>  Corporate Directory</p> <p><input checked="" type="checkbox"/> List of numbers</p> <table border="1" data-bbox="262 836 705 1063"><tr><td>5085</td></tr><tr><td>5068</td></tr><tr><td> </td></tr><tr><td> </td></tr><tr><td> </td></tr><tr><td> </td></tr></table> <p>Number <input type="text"/>  </p>	5085	5068					<p>You can select one or more contact phone numbers, for which incoming calls trigger the SNR service if the phone number of the caller matches one of the contacts.</p> <p>This condition allows you to filter or select certain callers to be forwarded using the SNR service. Other calls receive Cisco CME not-available routing. The caller's number is matched against the contact's home, work, or mobile number in the specified lists.</p>
5085							
5068							

**Table 4**      **Checking Availability Conditions**

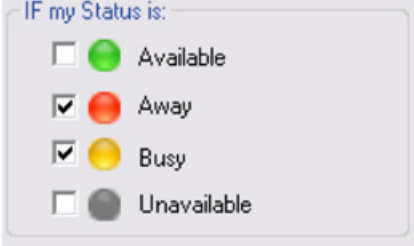
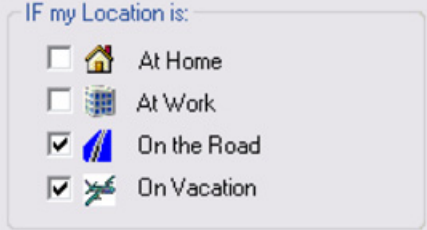
	<p>You can select one or more presence location that triggers the SNR service if it matches your presence.</p>
	<p>You can select one or more current location that triggers the SNR service if it matches your location.</p>

**Table 5**      **Checking Date/Time Conditions**



IF Today is:

 Weekday

 Weekend

 Holiday

**Between**

 Start Date       End Date

10/24/2007      10/24/2007

 **Particular day of the week**

Monday

Tuesday

Wednesday

Thursday

Friday

Saturday

Sunday

You can select one or more day that triggers the SNR service if there is a match.



Holidays and Weekday/Weekend days are configured by the administrator.

IF the Time is:

 Working Hours

 After Work Hours

**Between**

 Start Time       End Time

5:45:19 PM      5:45:19 PM

You can select one or more time that triggers the SNR service if there is a match.

## Setting Up Single Number Reach Actions

In this last step, you must specify the actions that are automatically performed by the Cisco UCC system after all the condition checks pass.

You can set a delay interval (in seconds) to allow the IP phone to ring before the Single Number Reach picks up the incoming call. The numbers at which you want to be reached for the incoming call needs to be selected. If you are not reachable on the specified numbers, the caller is transferred to your voice mailbox. The mailbox information is displayed at the bottom of the Action window. You can configure the mailbox and PIN password from the Popup-Options window.

**Figure 4** Single Number Reach Options Window

Enable this action

**Single Number Reach**

Pick up and route the incoming call that is specified in the 'Check Calls come to' condition.

Delay before pick up the incoming call: (default: 0 second)

Delay time:  seconds

The incoming call will be routed to:

Work Phone: 4110

Work Phone2: 5085

Home Phone: [No Data]

Cell Phone: [No Data]

Other

In case I couldn't be reached, the incoming call will be transferred to voice mail:

Mail box  password

(Voice mail account info is retrieved automatically from user's profile)

(Note: Some of the options for routing the incoming call will be disabled if they're already selected in the Check Calls condition)

281043

**Table 6**      **Single Number Reach Actions Parameters**

Options	Description
Delay time	Delay interval (in seconds) before the SNR picks up the call.
The call will be routed to	Phone numbers that are reached from the incoming call.
Mailbox (Read only)	If you could not be reached, the incoming call is transferred to your voice mailbox.
Password (Read only)	Your SNR password.

## Setting Up Status Update Actions

In addition to the Single Number Reach actions, you can also setup rules to automatically change your availability, location, and away messages based on user specified conditions.



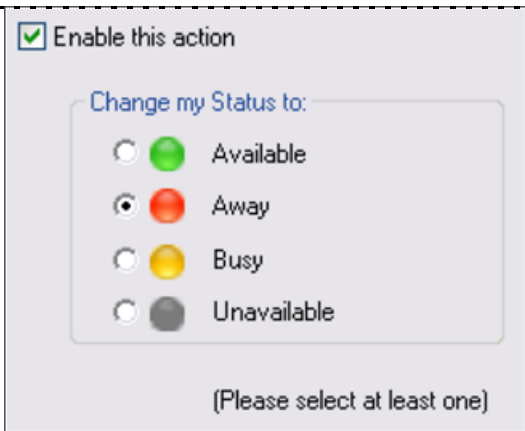

**Table 7**      **Automated Status and Location Updates**

	<p>When enabled and the conditions are met, your availability status is changed to the specified status.</p> <p>Use this in combination with the date and time conditions to automatically change your status.</p>
--	--



Enable this action

Change my Location to:

-  At Home
-  At Work
-  On the Road
-  On Vacation

(Please select at least one option)





280246

When enabled and the conditions are met, your location setting is changed to the specified location.

Use this in combination with the date/time conditions to automatically change your location.

Enable this action

Change my status Message to:

-  Busy
-  Be right back
-  Stepped out
-  Away from keyboard
-  On the phone
- Custom message:

(Please select one)

280246

When enabled and the conditions are met, your away message is changed to the specified option.

## 8 Single Number Reach Rules: Examples

This section describes some common rules that you can configure.

### Sending Your Business Calls to Your Mobile Phone

When enabled, this is a simple, unconditional rule tries to connect the incoming calls to your IP phone are sent to your mobile phone. If you are not available, the call is routed to the voice mailbox.

**Figure 5** Rules Window: Example of Rule for Forwarding Calls

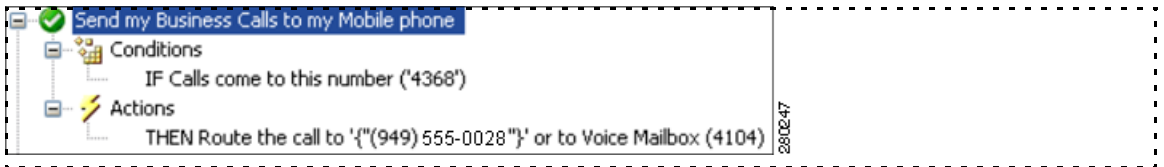

### Sending Your Business Calls to Your Home Phone

This rule enables you to receive work calls at your home number. The rule checks your availability status and your location. If your are “At Home” and the availability status is “Available,” the incoming calls to the IP phone are sent to the home number.

You can control the call flow by changing your availability status. A Busy or Unavailable setting stops the delivery of business calls.



**Note** You can use this feature without having to give out the home number.

**Figure 6** Rules Window: Example of Rule for Working from Home

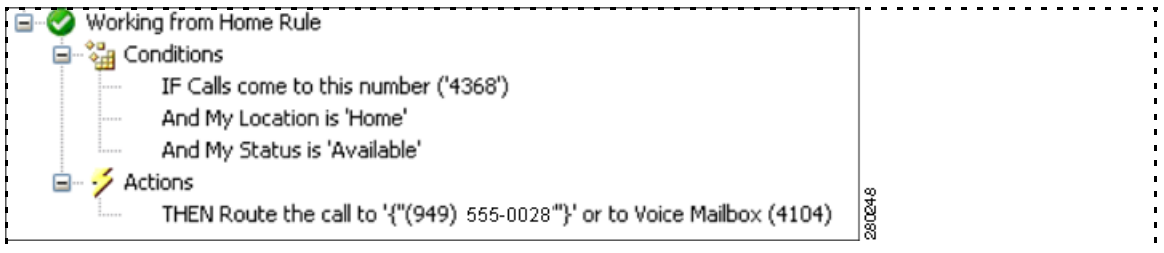

## Routing Your Business Calls Outside of Work Hours

This rule routes your business calls to your mobile phone when you are working outside of work hours.



**Note** This rule is active only on working days.

**Figure 7** Rules Window: Example of Rule for Working Outside of Business Hours

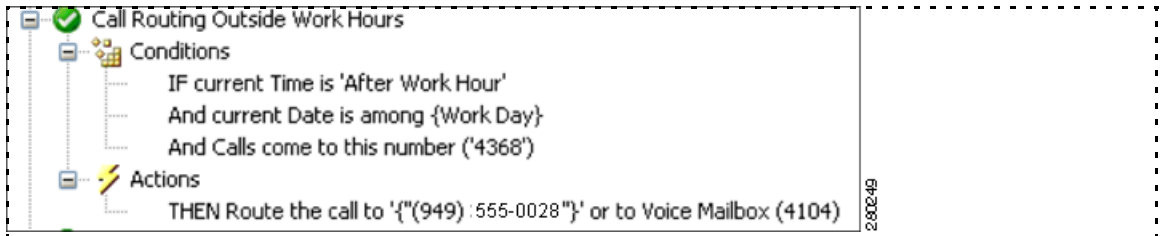

## Routing Your Business Calls When Traveling on Business

This rule routes your business calls to your mobile phone, when you are travelling.

**Figure 8** Rules Window View

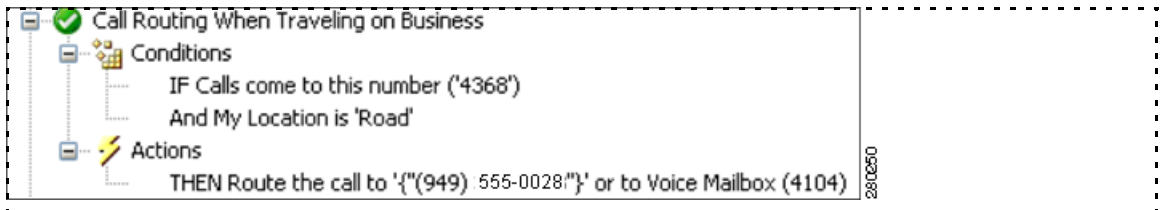

## Using Priority Interruptions When on Holiday

This rule routes only selected callers to your mobile phone, when you are on holiday.

**Figure 9** Rules Window View

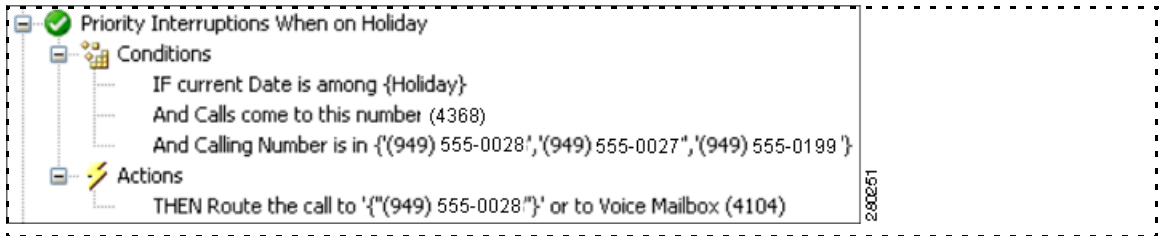

## 9 Cisco UCC Mobility Service User Features

**Table 8** Personal Routing Policies

Feature	Description
Personalized custom call routing rules for Single Number Reach	You can setup personalized call routing rules for handling business calls when away from the office.
User selectable extension numbers for SNR service	You can specify the primary or secondary extension on the IP phone for the Single Number Reach service.
User specified reach numbers	You can specify that incoming calls are routed to your work phone, second work phone, home phone, mobile phone, or custom phone number.
Multiple simultaneous reach numbers	You can setup rules to try to reach them at multiple telephone numbers including home, mobile, and an alternate phone number.
Simultaneous ringing at IP phone and alternate phone numbers	You can setup SNR to ring the IP phone and other numbers. However to ring at the IP phone, a secondary DN must be configured and the number specified as one of the reach numbers.
You can selectively route callers to you using SNR.	The Mobility Service can check if the caller's number is in your personal contacts or speed dial list or corporate directory or custom list of numbers.
Ability to enable/disable a rule	You can setup multiple rules and enable or disable them as needed.

<b>Feature</b>	<b>Description</b>
Call routing can be conditionally based on your availability status	The Mobility Service can check if your current presence status is available, away , busy, or unavailable to determine if the call is to be routed.
Call routing can be conditionally based on your location	The Mobility Service can check if your current location at home, at work, on the road, or on vacation to determine if the call is to be routed.
Different call routing rules for weekend, holiday and work-day	The Mobility Service can check if the day is a weekday, weekend, holiday, or a particular day of the week to determine if the call is to be routed.
Different call routing rules for work hours, non-work hours, or specified time	The Mobility Service can check if the current time is during work hours, after work hours or after a specified time to determine if the call is to be routed.
User specifiable SNR pickup delay time to allow the call to ring at the IP phone	This answer delay (in seconds) provides an option for you to pick-up incoming calls before SNR acquires the call.

**Table 9**      ***Personal Presence Update Policies***

<b>Feature</b>	<b>Description</b>
Update your availability status based on date/time and/or other conditions	You can setup rules to automatically update your presence status to Available, Away, Busy or Unavailable based on the condition parameters available in the rules.
Update your location based on date/time and/or other conditions	You can setup rules to automatically update your location to At Work, At Home, On the Road, or On Vacation based on the condition parameters available in the rules.
Update your status message	You can update yor status message to Busy, Be Right Back, Stepped Out, Away From Keyboard, On the Phone ,or a custom message.

**Table 10**     **Feature for Accessing Mid-Call/DISA**

<b>Feature</b>	<b>Description</b>
Add/Join another number	You can add another number when you are on a Mobility Service call, up to an additional five numbers.
Transfer to a specified number	You can transfer the current call to a specified number.
Transfer calls to any of your other phone numbers (home, mobile, work, etc)	You can transfer the current call to another one of your telephone numbers. You can move calls to your home, mobile, or work phone number for more convenient call handling.
Transfer to Voice mail	You can transfer the current call to the Cisco Unity voice mailbox.
Make an outgoing call	You can dial in to the Mobility Service and make an outgoing call using the telephone facilities of the organization. Your caller ID can be hidden or forwarded based on administrative settings.
Update Status	You can call in and change your availability setting. You can use this to turn off one set of rules and enable another set, if the rules are based on your availability status.
Update Location	You can call in and change your location setting. You can use this to turn off one set of rules and enable another set, if the rules are based on your location setting.

## 10 Additional Information

For more information about Cisco UCC for Microsoft Windows 1.5, see the following documentation available at [http://www.cisco.com/en/US/products/ps7274/tsd\\_products\\_support\\_series\\_home.html](http://www.cisco.com/en/US/products/ps7274/tsd_products_support_series_home.html):

- Cisco UCC for Microsoft Windows Personal Edition 1.5 Quick Reference Guide
- Cisco UCC for Microsoft Windows Personal Edition 1.5 Installation and User Guide
- Cisco UCC for Microsoft Windows Server and Mobile Editions 1.5 Administrator Guide
- Cisco UCC for Microsoft Windows 1.5 Mobile Edition User Guide
- Cisco UCC for Microsoft Windows 1.5 Release Notes





**Americas Headquarters**  
Cisco Systems, Inc.  
170 West Tasman Drive  
San Jose, CA 95134-1706  
USA  
[www.cisco.com](http://www.cisco.com)  
Tel: 408 526-4000  
800 553-NETS (6387)  
Fax: 408 527-0883

**Asia Pacific Headquarters**  
Cisco Systems (USA) Pte. Ltd.  
168 Robinson Road  
#28-01 Capital Tower  
Singapore 068912  
[www.cisco.com](http://www.cisco.com)  
Tel: +65 6317 7777  
Fax: +65 6317 7799

**Europe Headquarters**  
Cisco Systems International BV  
Haarlerbergpark  
Haarlerbergweg 13-19  
1101 CH Amsterdam  
The Netherlands  
[www-europe.cisco.com](http://www-europe.cisco.com)  
Tel: 31 0 800 020 0791  
Fax: 31 0 20 357 1100

**Cisco has more than 200 offices worldwide. Addresses, phone numbers, and fax numbers are listed on the  
Cisco Website at [www.cisco.com/go/offices](http://www.cisco.com/go/offices).**

CCVP, the Cisco logo, and Welcome to the Human Network are trademarks of Cisco Systems, Inc.; Changing the Way We Work, Live, Play, and Learn is a service mark of Cisco Systems, Inc.; and Access Registrar, Aironet, Catalyst, CCDA, CCDP, CCIE, CCIP, CCNA, CCNP, CCSP, Cisco, the Cisco Certified Internetwork Expert logo, Cisco IOS, Cisco Press, Cisco Systems, Cisco Systems Capital, the Cisco Systems logo, Cisco Unity, Enterprise/Solver, EtherChannel, EtherFast, EtherSwitch, Fast Step, Follow Me Browsing, FormShare, GigaDrive, HomeLink, Internet Quotient, IOS, iPhone, IP/TV, iQ Expertise, the iQ logo, iQ Net Readiness Scorecard, iQuick Study, LightStream, Linksys, MeetingPlace, MGX, Networkers, Networking Academy, Network Registrar, PIX, ProConnect, ScriptShare, SMARTnet, StackWise, The Fastest Way to Increase Your Internet Quotient, and TransPath are registered trademarks of Cisco Systems, Inc. and/or its affiliates in the United States and certain other countries.

All other trademarks mentioned in this document or Website are the property of their respective owners. The use of the word partner does not imply a partnership relationship between Cisco and any other company. (0711R)

© 2008 Cisco Systems, Inc. All rights reserved.

Printed in the USA on recycled paper containing 10% postconsumer waste.