

Cisco Catalyst 9400 Series Line Card Installation Note

Cisco Catalyst 9400 Series Line Card Installation Note

This document describes the features of all available line cards and provides information about how to correctly remove and replace a line card in the chassis.

Table 1: Product Numbers:

C9400-LC-12QC, C9400-LC-12QC=(Spare)	C9400-LC-48P, C9400-LC-48P= (Spare)
C9400-LC-24S, C9400-LC-24S= (Spare)	C9400-LC-48S, C9400-LC-48S= (Spare)
C9400-LC-24XS, C9400-LC-24XS= (Spare)	C9400-LC-48T, C9400-LC-48T= (Spare)
C9400-LC-24XY, C9400-LC-24XY=(Spare)	C9400-LC-48TX, C9400-LC-48TX=(Spare)
C9400-LC-48H, C9400-LC-48H= (Spare)	C9400-LC-48U, C9400-LC-48U= (Spare)
C9400-LC-48HN, C9400-LC-48HN= (Spare)	C9400-LC-48UX, C9400-LC-48UX= (Spare)
C9400-LC-48HX, C9400-LC-48HX= (Spare)	C9400-LC-48XS, C9400-LC-48XS= (Spare)

The following table provides an overview of the compatible and incompatible supervisor modules for each available line card.

Table 2: Overview of Supervisor Module-Line Card Compatibility

-	C9400-SUP-1	C9400-SUP-1XL	C9400-SUP-1XL-Y	C9400X-SUP-2	C9400X-SUP-2XL
C9400-LC-12QC	No	No	No	Yes	Yes
C9400-LC-24S	Yes	Yes	Yes	Yes	Yes
C9400-LC-24XS	Yes	Yes	Yes	Yes	Yes
C9400-LC-24XY	No	No	No	Yes	Yes
C9400-LC-48H	Yes	Yes	Yes	Yes	Yes
C9400-LC-48HN	Yes	Yes	Yes	Yes	Yes
C9400-LC-48HX	No	No	No	Yes	Yes
C9400-LC-48P	Yes	Yes	Yes	Yes	Yes
C9400-LC-48S	Yes	Yes	Yes	Yes	Yes
C9400-LC-48T	Yes	Yes	Yes	Yes	Yes
C9400-LC-48TX	No	No	No	Yes	Yes
C9400-LC-48U	Yes	Yes	Yes	Yes	Yes

-	C9400-SUP-1	C9400-SUP-1XL	C9400-SUP-1XL-Y	C9400X-SUP-2	C9400X-SUP-2XL
C9400-LC-48UX	Yes	Yes	Yes	Yes	Yes
C9400-LC-48XS	No	No	No	Yes	Yes



Warning **Statement 1071**—Warning Definition

IMPORTANT SAFETY INSTRUCTIONS

Before you work on any equipment, be aware of the hazards involved with electrical circuitry and be familiar with standard practices for preventing accidents. Read the installation instructions before using, installing, or connecting the system to the power source. Use the statement number at the beginning of each warning statement to locate its translation in the translated safety warnings for this device.

SAVE THESE INSTRUCTIONS



Cisco Catalyst 9400 Series Line Card Features

These tables provide a brief description of each line card module, the maximum bandwidth, minimum and maximum port densities, chassis support information, and restrictions (if any).

Gigabit and Multigigabit Ethernet Line Cards

Cisco Catalyst 9400 Series 48-Port UPOE+ 10/100/1000 Module (C9400-LC-48H)

Description	<p>48-port, 10/100/1000 BASE-T Gigabit Ethernet, IEEE 802.3bt compliant module supporting up to 90 W Cisco UPOE+ on each of its 48 RJ45 ports.</p> <ul style="list-style-type: none"> • Hardware ready for IEEE 1588/802.1as— A Precision Time Protocol (PTP) used for time synchronization across the network for video and audio applications. • Supports Cisco Phone Discovery and IEEE 802.3af, IEEE 802.3at, and IEEE 802.3bt. • Supports Energy Efficient Ethernet (EEE) • Supports PoE Cable Loss Management • Saves power with direct power delivery from backplane • Has a built-in, front-facing, non-removable, passive RFID tag that uses Ultra High Frequency (UHF) RFID technology and requires an RFID reader with compatible software. For more information, see Radio Frequency Identification (RFID) on Cisco Catalyst 9000 Family Switches. • The following line card features are configured in software. See the software configuration guide for more information: <ul style="list-style-type: none"> • Provides per port power consumption measurement • Enables you to specify maximum power consumption on every port • Supports PoE Power Configuration • The 10-slot (Catalyst 9410R Switch) chassis has a maximum of 384 1Gbps ports but can support up to 260 90W PoE ports concurrently.
Maximum Bandwidth	<p>48 Gbps, full duplex non-blocking traffic</p>
Minimum / Maximum Port Density¹	<ul style="list-style-type: none"> • Catalyst 9404R Switch—48 / 96 • Catalyst 9407R Switch—48 / 240 • Catalyst 9410R Switch—48 / 384
Supervisor Module Compatibility	<p>C9400-SUP-1, C9400-SUP-1XL, C9400-SUP-1XL-Y, C9400X-SUP-2, and C9400X-SUP-2XL. Also see Table 2: Overview of Supervisor Module-Line Card Compatibility .</p>

Support and Restrictions

- Can be installed in any non-supervisor module slot.
- Ensure that the chassis power supply configuration supports the PoE budget adequately. Use the [Cisco Power Calculator](#) for power budgeting estimates and to determine power supply requirements for a specific PoE configuration.
- Some legacy Cisco powered devices (like 7910, 7940, 7960 IP phones and AP350 wireless access points) are incompatible with Type 4 Power Supply Equipments (PSEs), as defined in the IEEE 802.3bt standard. If connected, the PSE reports a 'Tstart' or 'Imax' fault with each periodic attempt at providing power to the powered device. For continued use of these legacy Cisco powered devices, connect them to Cisco PoE+/UPOE PSEs.
- The C9400-LC-48H line card is supported starting with Cisco IOS XE Gibraltar 16.12.1.
Before inserting the line card, ensure that the device software is Cisco IOS XE Gibraltar 16.12.1 or a later release.
Before downgrading the device software from Cisco IOS XE Gibraltar 16.12.1 to an earlier release, ensure that you remove the C9400-LC-48H line card.

¹ The number of ports available on a single switch

Figure 1: Front View of the C9400-LC-48H Line Card

(Click on the image to see the details more clearly.)



1	STATUS LED	5	Ejector levers
2	LOCATE (blue beacon) LED	6	PORT LINK LED for the port in the top row
3	Model or product number	7	PORT LINK LED for the port in the bottom row
4	Captive installation screws	8	Line card Radio Frequency Identifier (RFID)

Cisco Catalyst 9400 Series 48-Port UPOE+ 100 Mbps/1G/2.5G/5G Multigigabit Module (C9400-LC-48HN)

Description	<p>48-port, 100 Mbps/1G/2.5G/5 G BASE-T Multigigabit Ethernet module supporting up to 90 W Cisco UPOE+ on each of its 48 RJ45 ports.</p> <ul style="list-style-type: none"> • Hardware ready for IEEE 1588/802.1as— A Precision Time Protocol (PTP) used for time synchronization across the network for video and audio applications. • Cisco UPOE+, PoE+ and PoE features: <ul style="list-style-type: none"> • Supplies up to 90 W per port simultaneously on all 48 ports. <p>The 4-slot (Catalyst 9404R switch) chassis provides a maximum of 96 ports and can support up to 96 90W ports concurrently.</p> <p>The 7-slot (Catalyst 9407R switch) chassis provides a maximum of 240 ports but can support up to 237 90W ports concurrently.</p> <p>The 10-slot (Catalyst 9410R switch) chassis provides a maximum of 384 ports but can support up to 233 90W ports concurrently.</p> • Supports IEEE802.3af, IEEE802.3at, and IEEE802.3bt on all 48 ports, with DC disconnect. • Supports PoE Emergency Shutdown based on priority levels from 0 (highest priority) to 7 (lowest priority). • Supports Energy Efficient Ethernet (EEE) • Supports PoE Cable Loss Management • The following line card features are configured in software. See the software configuration guide for more information: <ul style="list-style-type: none"> • Provides per port power consumption measurement • Enables you to specify maximum power consumption on every port • Supports PoE Power Configuration • Has a built-in, front-facing, passive RFID tag that uses Ultra High Frequency (UHF) RFID technology and requires an RFID reader with compatible software. For more information, see Radio Frequency Identification (RFID) on Cisco Catalyst 9000 Family Switches.
Maximum Bandwidth	<p>240 Gbps, full duplex non-blocking traffic.</p> <p>This value is the maximum bandwidth supported on this line card. The chassis and supervisor module combination that you use determines the final available bandwidth. For more information, see Cisco Catalyst 9400 Series Switch Line Cards Data Sheet .</p>
Minimum / Maximum Port Density²	<ul style="list-style-type: none"> • Catalyst 9404R Switch—48 / 96 • Catalyst 9407R Switch—48 / 240 • Catalyst 9410R Switch—48 / 384
Supervisor Module Compatibility	<p>C9400-SUP-1, C9400-SUP-1XL, C9400-SUP-1XL-Y, C9400X-SUP-2, and C9400X-SUP-2XL. Also see Table 2: Overview of Supervisor Module-Line Card Compatibility .</p>

Support and Restrictions

- Can be installed in any non-supervisor module slot.
- Ensure that the chassis power supply configuration supports the PoE budget adequately. Use the [Cisco Power Calculator](#) for power budgeting estimates and to determine power supply requirements for a specific PoE configuration.
- Some legacy Cisco powered devices (like 7910, 7940, 7960 IP phones and AP350 wireless access points) are incompatible with Type 4 Power Supply Equipments (PSEs), as defined in the IEEE 802.3bt standard. If connected, the PSE reports a 'Tstart' or 'Imax' fault with each periodic attempt at providing power to the powered device. For continued use of these legacy Cisco powered devices, connect them to Cisco PoE+/UPOE PSEs.
- The C9400-LC-48HN line card is supported starting with Cisco IOS XE Bengaluru 17.5.1
Before inserting the line card, ensure that the device software is Cisco IOS XE Bengaluru 17.5.1 or a later release.
Before downgrading the device software from Cisco IOS XE Bengaluru 17.5.1 to an earlier release, ensure that you remove the C9400-LC-48HN line card.

² The number of ports available on a single switch

Figure 2: Front View of the C9400-LC-48HN Line Card

(Click on the image to see the details more clearly.)

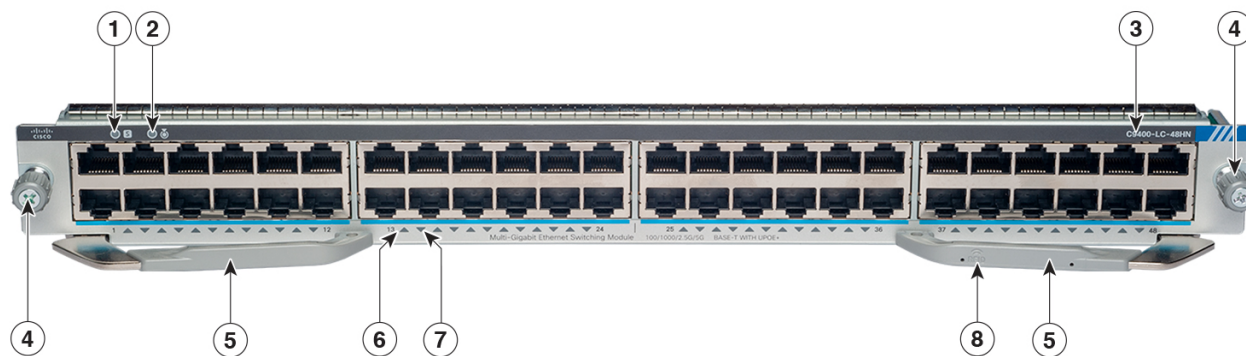

1	STATUS LED	5	Ejector levers
2	LOCATE (blue beacon) LED	6	PORT LINK LED for the port in the top row
3	Model or product number	7	PORT LINK LED for the port in the bottom row
4	Captive installation screws	8	Line card Radio Frequency Identifier (RFID)

Cisco Catalyst 9400 Series 48-Port UPOE+ 100 Mbps/1G/2.5G/5G/10G Multigigabit Module (C9400-LC-48HX)

Description	<p>48-port, 100 Mbps/1G/2.5G/5G/10G BASE-T Multigigabit Ethernet module, supporting up to 90 W Cisco UPOE+ on each of its 48 RJ45 ports.</p> <ul style="list-style-type: none"> • Hardware ready for IEEE 1588/802.1as— A Precision Time Protocol (PTP) used for time synchronization across the network for video and audio applications. • IEEE 802.1AE (MACsec-256) capability in hardware • Cisco UPoE+, PoE+ and PoE features: <ul style="list-style-type: none"> • Supplies up to 90 W per port simultaneously on all 48 ports. <p>The 4-slot (Catalyst 9404R switch) chassis provides a maximum of 96 ports and can support up to 96 90W ports concurrently.</p> <p>The 7-slot (Catalyst 9407R switch) chassis provides a maximum of 240 ports but can support up to 226 90W ports concurrently.</p> <p>The 10-slot (Catalyst 9410R switch) chassis provides a maximum of 384 ports but can support up to 224 90W ports concurrently.</p> • Supports IEEE802.3af, IEEE802.3at, and IEEE802.3bt on all 48 ports, with DC disconnect. • Supports PoE Emergency Shutdown based on priority levels from 0 (highest priority) to 7 (lowest priority). • Supports Energy Efficient Ethernet (EEE) • Supports PoE Cable Loss Management • The following line card features are configured in software. See the software configuration guide for more information: <ul style="list-style-type: none"> • Provides per port power consumption measurement • Enables you to specify maximum power consumption on every port • Supports PoE Power Configuration • Has a built-in, front-facing, non-removable, passive RFID tag that uses Ultra High Frequency (UHF) RFID technology and requires an RFID reader with compatible software. For more information, see Radio Frequency Identification (RFID) on Cisco Catalyst 9000 Family Switches.
Maximum Bandwidth	<p>480 Gbps</p> <p>This value is the maximum bandwidth supported on this line card. The chassis and supervisor module combination that you use determines the final available bandwidth. For more information, see Cisco Catalyst 9400 Series Switch Line Cards Data Sheet.</p>
Minimum / Maximum Port Density³	<ul style="list-style-type: none"> • Catalyst 9404R Switch—48 / 96 • Catalyst 9407R Switch—48 / 240 • Catalyst 9410R Switch—48 / 384

Supervisor Module Compatibility	C9400X-SUP-2 and C9400X-SUP-2XL only. Also see Table 2: Overview of Supervisor Module-Line Card Compatibility .
Support and Restrictions	<ul style="list-style-type: none"> • Can be installed in any non-supervisor module slot. • Ensure that the chassis power supply configuration supports the PoE budget adequately. Use the Cisco Power Calculator for power budgeting estimates and to determine power supply requirements for a specific PoE configuration. • Some legacy Cisco powered devices (like 7910, 7940, 7960 IP phones and AP350 wireless access points) are incompatible with Type 4 Power Supply Equipments (PSEs), as defined in the IEEE 802.3bt standard. If connected, the PSE reports a ‘Tstart’ or ‘Imax’ fault with each periodic attempt at providing power to the powered device. For continued use of these legacy Cisco powered devices, connect them to Cisco PoE+/UPOE PSEs. • The C9400-LC-48HX line card is supported starting with Cisco IOS XE Cupertino 17.8.1. Before inserting the line card, ensure that the device software is Cisco IOS XE Cupertino 17.8.1 or a later release. Before downgrading the device software from Cisco IOS XE Cupertino 17.8.1 to an earlier release, ensure that you remove the C9400-LC-48HX line card.

³ The number of ports available on a single switch

Figure 3: Front View of the C9400-LC-48HX Line Card

(Click on the image to see the details more clearly.)

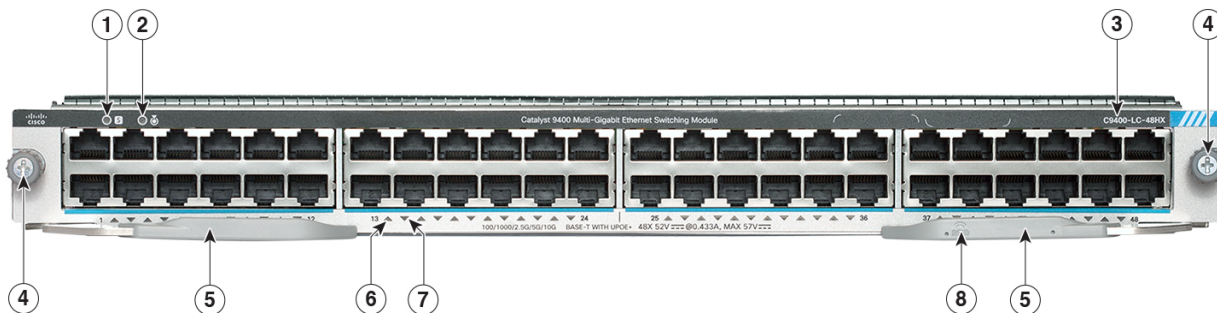

1	STATUS LED	5	Ejector levers
2	LOCATE (blue beacon) LED	6	PORT LINK LED for the port in the top row
3	Model or product number	7	PORT LINK LED for the port in the bottom row
4	Captive installation screws	8	Line card Radio Frequency Identifier (RFID)

Cisco Catalyst 9400 Series 48-Port Gigabit Ethernet POE/POE+ Module (C9400-LC-48P)

Description	<p>48-port, 10/100/1000 BASE-T Gigabit Ethernet module supporting up to 30W per port on each of its 48 ports.</p> <ul style="list-style-type: none"> • Hardware ready for IEEE 1588/802.1as— A Precision Time Protocol (PTP) used for time synchronization across the network for video and audio applications. • Supports Energy Efficient Ethernet (EEE). • You can specify maximum power consumption on every port. • Supports POE cable loss management. • Supports EnergyWise 3.0. • Has a built-in, front-facing, non-removable, passive RFID tag that uses Ultra High Frequency (UHF) RFID technology and requires an RFID reader with compatible software. For more information, see Radio Frequency Identification (RFID) on Cisco Catalyst 9000 Family Switches.
Maximum Bandwidth	48 Gbps, full duplex non-blocking traffic
Minimum / Maximum Port Density⁴	<ul style="list-style-type: none"> • Catalyst 9404R Switch—48 / 96 • Catalyst 9407R Switch—48 / 240 • Catalyst 9410R Switch—48 / 384
Supervisor Module Compatibility	C9400-SUP-1, C9400-SUP-1XL, C9400-SUP-1XL-Y, C9400X-SUP-2, and C9400X-SUP-2XL. Also see Table 2: Overview of Supervisor Module-Line Card Compatibility .
Support and Restrictions	Can be installed in any non-supervisor module slot. There are no other restrictions.

⁴ The number of ports available on a single switch

Figure 4: Front View of the C9400-LC-48P Line Card

(Click on the image to see the details more clearly.)

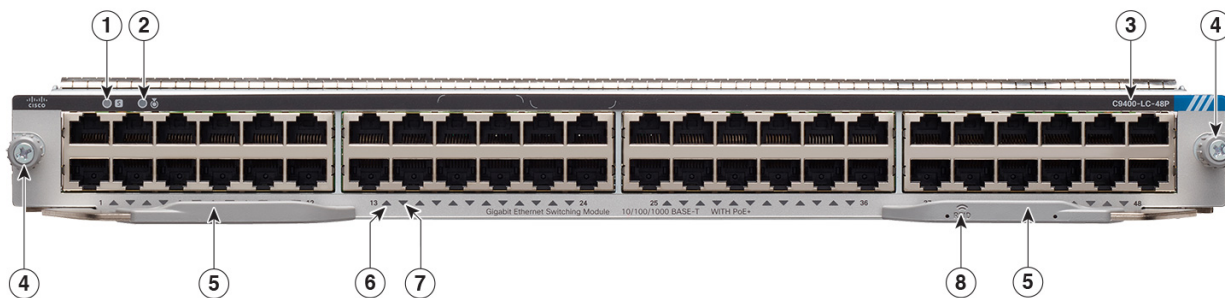

1	STATUS LED	5	Ejector levers
2	LOCATE (blue beacon) LED	6	PORT LINK LED for the port in the top row

3	Model or product number	7	PORT LINK LED for the port in the bottom row
4	Captive installation screws	8	Line card Radio Frequency Identifier (RFID)

Cisco Catalyst 9400 Series 48-Port 10/100/1000 Module (C9400-LC-48T)

Description	<p>48-port, 10/100/1000 BASE-T Gigabit Ethernet module.</p> <ul style="list-style-type: none"> • Hardware ready for IEEE 1588/802.1as— A Precision Time Protocol (PTP) used for time synchronization across the network for video and audio applications. • Supports Energy Efficient Ethernet (EEE) • Has a built-in, front-facing, non-removable, passive RFID tag that uses Ultra High Frequency (UHF) RFID technology and requires an RFID reader with compatible software. For more information, see Radio Frequency Identification (RFID) on Cisco Catalyst 9000 Family Switches.
Maximum Bandwidth	48 Gbps, full duplex non-blocking traffic.
Minimum / Maximum Port Density⁵	<ul style="list-style-type: none"> • Catalyst 9404R Switch—48 / 96 • Catalyst 9407R Switch—48 / 240 • Catalyst 9410R Switch—48 / 384
Supervisor Module Compatibility	C9400-SUP-1, C9400-SUP-1XL, C9400-SUP-1XL-Y, C9400X-SUP-2, and C9400X-SUP-2XL. Also see Table 2: Overview of Supervisor Module-Line Card Compatibility .
Support and Restrictions	Can be installed in any non-supervisor module slot. There are no other restrictions.

⁵ The number of ports available on a single switch

Figure 5: Front View of the C9400-LC-48T Line Card

(Click on the image to see the details more clearly.)

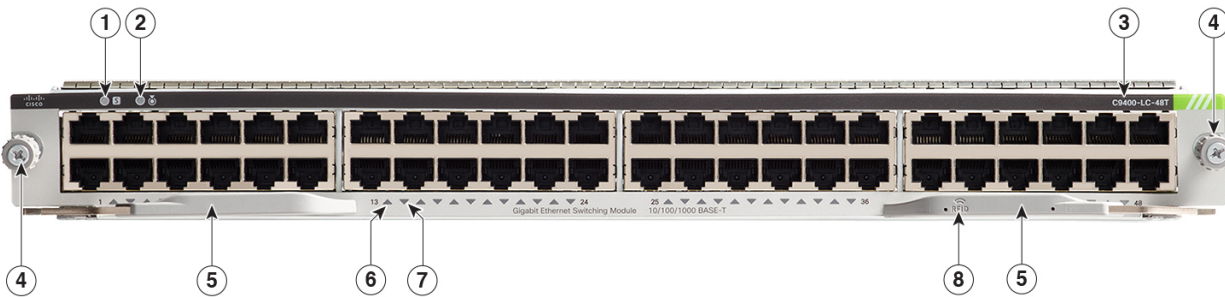

1	STATUS LED	5	Ejector levers
2	LOCATE (blue beacon) LED	6	PORT LINK LED for the port in the top row
3	Model or product number	7	PORT LINK LED for the port in the bottom row

4	Captive installation screws	8	Line card Radio Frequency Identifier (RFID)
---	-----------------------------	---	---

Cisco Catalyst 9400 Series 48-Port 100 Mbps/1G/2.5G/5G/10G Multigigabit Module (C9400-LC-48TX)

Description	<p>48-Port 100 Mbps/1G/2.5G/5G/10G BASE-T Multigigabit Ethernet module</p> <ul style="list-style-type: none"> • Hardware ready for IEEE 1588/802.1as— A Precision Time Protocol (PTP) used for time synchronization across the network for video and audio applications. • IEEE 802.1AE (MACsec-256) capability in hardware • Supports Energy Efficient Ethernet (EEE) • Has a built-in, front-facing, non-removable, passive RFID tag that uses Ultra High Frequency (UHF) RFID technology and requires an RFID reader with compatible software. For more information, see Radio Frequency Identification (RFID) on Cisco Catalyst 9000 Family Switches.
Maximum Bandwidth	<p>480 Gbps</p> <p>This value is the maximum bandwidth supported on this line card. The chassis and supervisor module combination that you use determines the final available bandwidth. For more information, see Cisco Catalyst 9400 Series Switch Line Cards Data Sheet.</p>
Minimum / Maximum Port Density⁶	<ul style="list-style-type: none"> • Catalyst 9404R Switch—48 / 96 • Catalyst 9407R Switch—48 / 240 • Catalyst 9410R Switch—48 / 384
Supervisor Module Compatibility	<p>C9400X-SUP-2 and C9400X-SUP-2XL only. Also see Table 2: Overview of Supervisor Module-Line Card Compatibility .</p>
Support and Restrictions	<ul style="list-style-type: none"> • Can be installed in any non-supervisor module slot. • The C9400-LC-48TX line card is supported starting with Cisco IOS XE 17.13.1. <p>Before inserting the line card, ensure that the device software is Cisco IOS XE 17.13.1 or a later release.</p> <p>Before downgrading the device software from Cisco IOS XE 17.13.1 to an earlier release, ensure that you remove the C9400-LC-48TX line card.</p>

⁶ The number of ports available on a single switch

Figure 6: Front View of the C9400-LC-48TX Line Card

(Click on the image to see the details more clearly.)

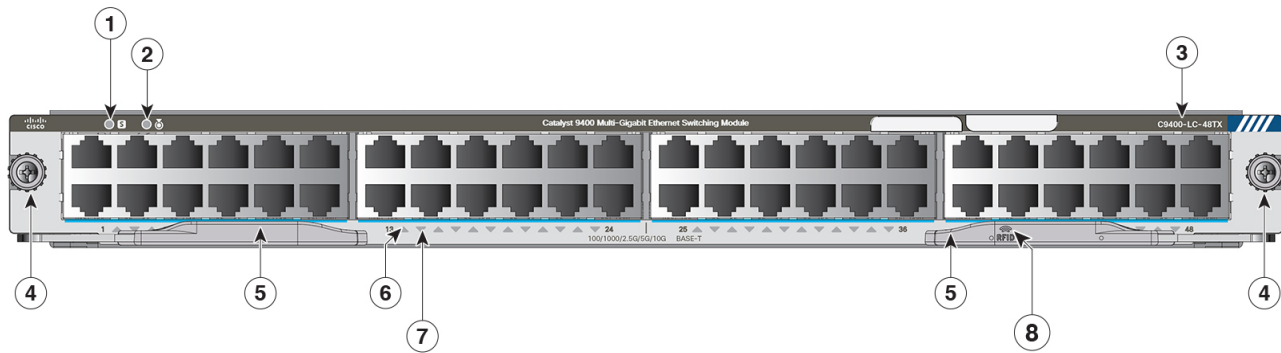

1	STATUS LED	5	Ejector levers
2	LOCATE (blue beacon) LED	6	PORT LINK LED for the port in the top row
3	Model or product number	7	PORT LINK LED for the port in the bottom row
4	Captive installation screws	8	Line card Radio Frequency Identifier (RFID)

Cisco Catalyst 9400 Series 48-Port UPOE 10/100/1000 Module (C9400-LC-48U)

Description	<p>48-port, 10/100/1000 BASE-T Gigabit Ethernet module supporting up to 60W Cisco UPOE on each of its 48 RJ45 ports.</p> <ul style="list-style-type: none"> • Hardware ready for IEEE 1588/802.1as— A Precision Time Protocol (PTP) used for time synchronization across the network for video and audio applications. • Supports Cisco Phone Discovery and IEEE802.3af and IEEE802.3at. • Supports Energy Efficient Ethernet (EEE) • Supports PoE Cable Loss Management • Saves power with direct power delivery from backplane • Has a built-in, front-facing, non-removable, passive RFID tag that uses Ultra High Frequency (UHF) RFID technology and requires an RFID reader with compatible software. For more information, see Radio Frequency Identification (RFID) on Cisco Catalyst 9000 Family Switches. • The following line card features are configured in software. See the software configuration guide for more information: <ul style="list-style-type: none"> • Provides per port power consumption measurement • Enables you to specify maximum power consumption on every port • Supports PoE Power Configuration
Maximum Bandwidth	48 Gbps, full duplex non-blocking traffic.

Minimum / Maximum Port Density⁷	<ul style="list-style-type: none"> • Catalyst 9404R Switch—48 / 96 • Catalyst 9407R Switch—48 / 240 • Catalyst 9410R Switch—48 / 384
Supervisor Module Compatibility	C9400-SUP-1, C9400-SUP-1XL, C9400-SUP-1XL-Y, C9400X-SUP-2, and C9400X-SUP-2XL. Also see Table 2: Overview of Supervisor Module-Line Card Compatibility .
Support and Restrictions	<ul style="list-style-type: none"> • Can be installed in any non-supervisor module slot. • Ensure that the chassis power supply configuration supports the PoE budget adequately. Use the Cisco Power Calculator for power budgeting estimates and to determine power supply requirements for a specific PoE configuration.

⁷ The number of ports available on a single switch

Figure 7: Front View of the C9400-LC-48U Line Card

(Click on the image to see the details more clearly.)

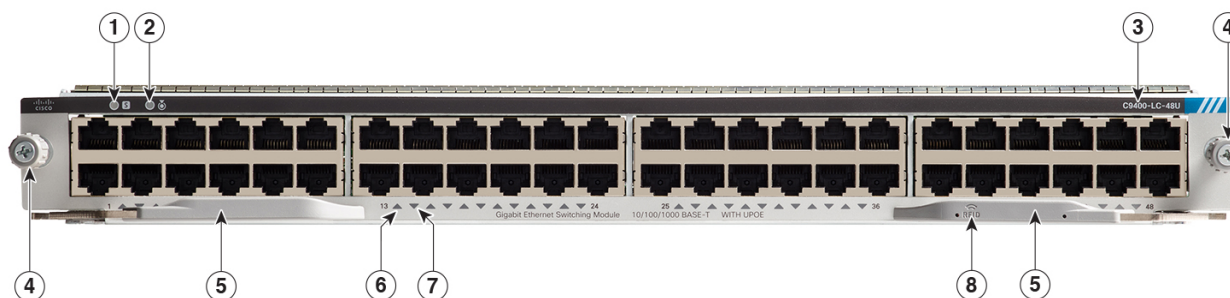

1	STATUS LED	5	Ejector levers
2	LOCATE (blue beacon) LED	6	PORT LINK LED for the port in the top row
3	Model or product number	7	PORT LINK LED for the port in the bottom row
4	Captive installation screws	8	Line card Radio Frequency Identifier (RFID)

Cisco Catalyst 9400 Series 48-Port UPOE Multigigabit Module (C9400-LC-48UX)

Description	<p>48-port, UPOE Multigigabit Ethernet Module with:</p> <ul style="list-style-type: none"> • 24 ports (Ports 1 to 24) 1G POE/POE+/UPOE • 24 ports (Ports 25 to 48) Multigigabit (mGig) POE/POE+/UPOE • Hardware ready for IEEE 1588/802.1as— A Precision Time Protocol (PTP) used for time synchronization across the network for video and audio applications. • Supports Cisco Phone Discovery and IEEE802.3af and IEEE802.3at. • Supports Energy Efficient Ethernet (EEE) • Supports PoE Cable Loss Management • Saves power with direct power delivery from backplane • Has a built-in, front-facing, non-removable, passive RFID tag that uses Ultra High Frequency (UHF) RFID technology and requires an RFID reader with compatible software. For more information, see Radio Frequency Identification (RFID) on Cisco Catalyst 9000 Family Switches. • The following line card features are configured in software. See the software configuration guide for more information: <ul style="list-style-type: none"> • Provides per port power consumption measurement • Enables you to specify maximum power consumption on every port • Supports PoE Power Configuration with up to 60W power per port on each of its 48 ports.
Maximum Bandwidth	<p>240 Gbps, full duplex non-blocking traffic.</p> <p>This value is the maximum bandwidth supported on this line card. The chassis and supervisor module combination that you use determines the final available bandwidth. For more information, see Cisco Catalyst 9400 Series Switch Line Cards Data Sheet .</p>
Minimum / Maximum Port Density⁸	<ul style="list-style-type: none"> • Catalyst 9407R Switch—48 / 96 • Catalyst 9407R Switch—48 / 240 • Catalyst 9410R Switch—48 / 384
Supervisor Module Compatibility	<p>C9400-SUP-1, C9400-SUP-1XL, C9400-SUP-1XL-Y, C9400X-SUP-2, and C9400X-SUP-2XL. Also see Table 2: Overview of Supervisor Module-Line Card Compatibility .</p>
Support and Restrictions	<ul style="list-style-type: none"> • Can be installed in any non-supervisor module slot. • Ensure that the chassis power supply configuration supports the PoE budget adequately. Use the Cisco Power Calculator for power budgeting estimates and to determine power supply requirements for a specific PoE configuration.

⁸ The number of ports available on a single switch

Figure 8: Front View of the C9400-LC-48UX Line Card

(Click on the image to see the details more clearly.)

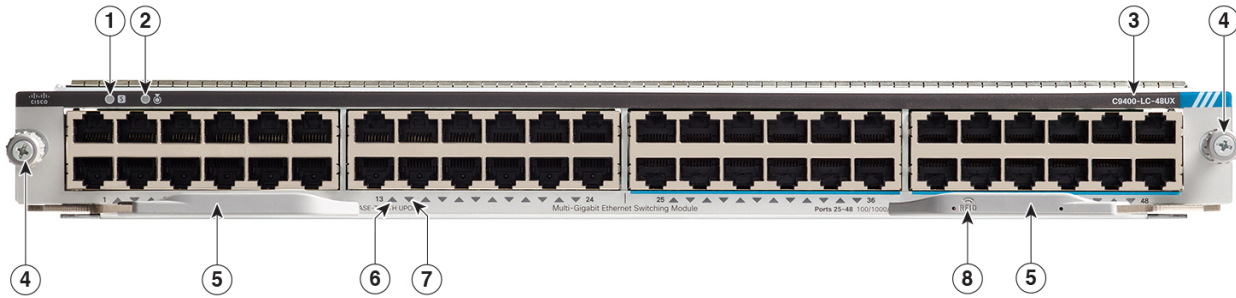

1	STATUS LED	5	Ejector levers
2	LOCATE (blue beacon) LED	6	PORT LINK LED for the port in the top row
3	Model or product number	7	PORT LINK LED for the port in the bottom row
4	Captive installation screws	8	Line card Radio Frequency Identifier (RFID)

Fiber Optic Ethernet Line Cards

Cisco Catalyst 9400 Series 12-Port 40G/100G Module (C9400-LC-12QC)

Description	<p>12-port fiber optic Ethernet switching module.</p> <ul style="list-style-type: none">Supported port speed options: <p>Port nos. 1 through 12 operate at 40 Gbps speeds, with QSFP+ transceivers installed. This is the default mode.</p> <p>Port nos. 1 through 12 can also operate at 10 Gbps speeds, with a Cisco QSFP28 to SFP28 Adapter (QSA) Module installed.</p> <p>Port nos. 9 through 12 can be <i>configured</i> to operate at 100 Gbps or 25 Gbps speeds. Note the requirements below:</p> <ul style="list-style-type: none">For 100 Gbps speeds, both a QSFP28 transceiver and configuration of the enable mode 100G interface configuration command are required.For 25 Gbps speeds, both a Cisco QSFP28 to SFP28 Adapter (QSA) Module and configuration of the enable mode 100G interface configuration command are required. <p>For each port that is enabled to operate at 100 Gbps or 25 Gbps, one port from 5 to 8 and belonging to the same port group, is disabled. For example, if port no. 9 is configured to operate at 100 Gbps speeds, port no. 5 is disabled. If port no. 10 is configured to operate at 100 Gbps speeds, port no. 6 is disabled, and so on. See Figure 10: Example: 100 Gbps and 40 Gbps Configuration on C9400-LC-12QC, on page 18.</p> <p>When operating with mixed speeds and <i>using all available ports</i>, port nos. 1 through 4 operate at 40 Gbps or 10 Gbps and port nos. 9 through 12 operate at 100 Gbps or 25 Gbps speeds. Bandwidth is allocated across four 3-port groups; providing 120 Gbps per port group.</p> <p>For more information about the software configuration, see the <i>Configuring Interface Characteristics</i> chapter of the <i>Interface and Hardware Configuration Guide</i> of the required release.</p> <ul style="list-style-type: none">Hardware ready for IEEE 1588/802.1as: A Precision Time Protocol (PTP) used for time synchronization across the network for video and audio applications.Supports full duplex traffic.Has a built-in, front-facing, non-removable, passive RFID tag that uses Ultra High Frequency (UHF) RFID technology and requires an RFID reader with compatible software. For more information, see Radio Frequency Identification (RFID) on Cisco Catalyst 9000 Family Switches.
Maximum Bandwidth	480 Gbps <p>This value is the maximum bandwidth supported on this line card. The chassis and supervisor module combination that you use determines the final available bandwidth. For more information, see Cisco Catalyst 9400 Series Switch Line Cards Data Sheet.</p>

Minimum / Maximum Port Density⁹	<ul style="list-style-type: none"> • Catalyst 9404R Switch—12 / 24 • Catalyst 9407R Switch—12 / 60 • Catalyst 9410R Switch—12 / 96
Supervisor Module Compatibility	C9400X-SUP-2 and C9400X-SUP-2XL only. Also see: Table 2: Overview of Supervisor Module-Line Card Compatibility .
Support and Restrictions	<ul style="list-style-type: none"> • Can be installed in any non-supervisor module slot. • The C9400-LC-12QC line card is supported starting with Cisco IOS XE Dublin 17.12.1. Before inserting the line card, ensure that the device software is Cisco IOS XE Cisco IOS XE Dublin 17.12.1 or a later release. Before downgrading the device software from Cisco IOS XE Dublin 17.12.1 to an earlier release, ensure that you remove the C9400-LC-12QC line card. • Simply installing a QSFP28 transceiver into one of the ports from 9 through 12 does not change the port speed to 100 Gbps. Both a suitable QSFP28 transceiver and the enable mode 100G interface configuration command are required. The same applies when installing a QSA module for 25 Gbps speeds. Installing only the module, does not change the port speed to 25 Gbps. Configuration of the enable mode 100G interface configuration command is also required. Similarly, if a port is configured to operate at 100 Gbps speeds, simply installing a QSFP+ transceiver into such a port does not change the port speed to 40 Gbps. The transceiver will not be supported and the port will not link up. Both a suitable QSFP+ transceiver and the relevant software configuration (disable 100 Gbps) are required.

⁹ The number of ports available on a single switch.

Figure 9: Front View of the C9400-LC-12QC Line Card

(Click on the image to see the details more clearly.)

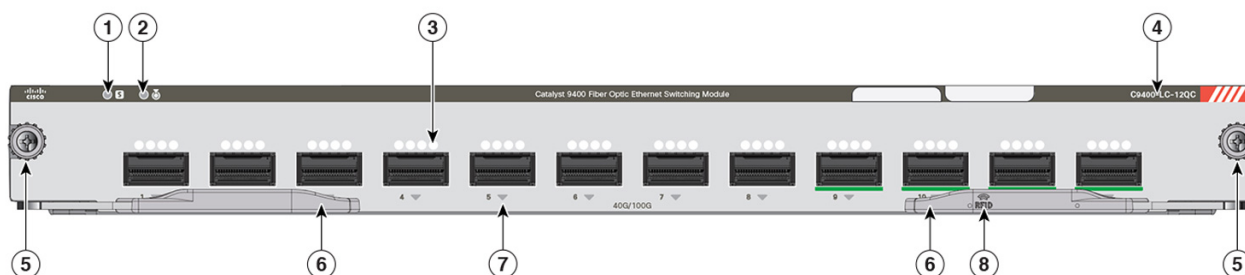

1	STATUS LED	5	Captive installation screws
2	LOCATE (blue beacon) LED	6	Ejector levers
3	Vent holes for the port cage	7	PORT LINK LED
4	Model or product number	8	Line card Radio Frequency Identifier (RFID)

Figure 10: Example: 100 Gbps and 40 Gbps Configuration on C9400-LC-12QC

The following figure of a C9400-LC-12QC line card shows that when 100 Gbps connectivity is configured on port nos 9 and 12, port nos 5 and 8 are disabled. Accordingly, the PORT LINK LEDs for the disabled ports are amber. All the remaining ports show 40 Gbps connectivity. (The remaining ports where you can configure 100 Gbps are port nos. 10 and 11. And if you do, port nos. 6 and 7 are also disabled).

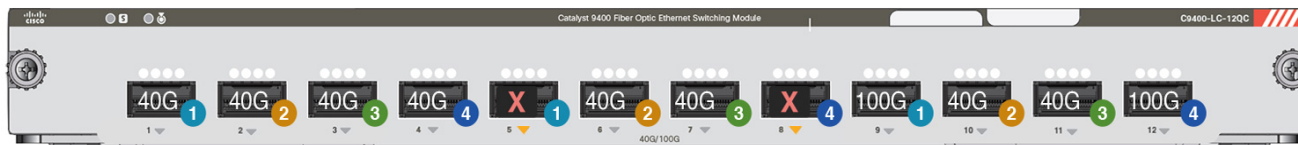

1	Port Group 1; port nos. 1,5, and 9.	40G	Port operating at 40 Gbps speeds
2	Port Group 2; port nos. 2, 6, and 10	100G	Port operating at 100 Gbps speeds
3	Port Group 3; port nos. 3, 7, and 11	X	Port disabled because 100 Gbps port is enabled.
4	Port Group 4; port nos. 4, 8, and 12	-	-

Cisco Catalyst 9400 Series 24-Port 1G SFP Module (C9400-LC-24S)

Description	<p>24-port, 1 Gigabit Ethernet SFP module.</p> <ul style="list-style-type: none"> • Hardware ready for IEEE 1588/802.1as— A Precision Time Protocol (PTP) used for time synchronization across the network for video and audio applications. • Supports 10/100/1000BASE-T with Cu-SFP module. • Supports full duplex traffic. • Has a built-in, front-facing, non-removable, passive RFID tag that uses Ultra High Frequency (UHF) RFID technology and requires an RFID reader with compatible software. For more information, see Radio Frequency Identification (RFID) on Cisco Catalyst 9000 Family Switches.
Maximum Bandwidth	24 Gbps, full duplex non-blocking traffic
Minimum / Maximum Port Density ¹⁰	<ul style="list-style-type: none"> • Catalyst 9404R Switch—24 / 48 • Catalyst 9407R Switch—24 / 120 • Catalyst 9410R Switch—24 / 192
Supervisor Module Compatibility	C9400-SUP-1, C9400-SUP-1XL, C9400-SUP-1XL-Y, C9400X-SUP-2, and C9400X-SUP-2XL. Also see Table 2: Overview of Supervisor Module-Line Card Compatibility .
Support and Restrictions	Can be installed in any non-supervisor module slot. There are no other restrictions.

¹⁰ The number of ports available on a single switch

Figure 11: Front View of the C9400-LC-24S Line Card

(Click on the image to see the details more clearly.)



1	STATUS LED	5	Ejector levers
2	LOCATE (blue beacon) LED	6	PORT LINK LED for the port in the top row
3	Model or product number	7	PORT LINK LED for the port in the bottom row
4	Captive installation screws	8	Line card Radio Frequency Identifier (RFID)

Cisco Catalyst 9400 Series 24-Port SFP/SFP+ Module (C9400-LC-24XS)

Description	<p>24 Port SFP/SFP+ 10 Gigabit Ethernet Module. These ports can be interchangeably used as 1G and 10G ports.</p> <ul style="list-style-type: none"> • Hardware ready for IEEE 1588/802.1as— A Precision Time Protocol (PTP) used for time synchronization across the network for video and audio applications. • Bandwidth is allocated across four 6-port groups, providing 20 Gbps per port group. • Has a built-in, front-facing, non-removable, passive RFID tag that uses Ultra High Frequency (UHF) RFID technology and requires an RFID reader with compatible software. For more information, see Radio Frequency Identification (RFID) on Cisco Catalyst 9000 Family Switches.
Maximum Bandwidth	<p>240 Gbps, full duplex non-blocking traffic.</p> <p>This value is the maximum bandwidth supported on this line card. The chassis and supervisor module combination that you use determines the final available bandwidth. For more information, see Cisco Catalyst 9400 Series Switch Line Cards Data Sheet .</p>
Minimum / Maximum Port Density¹¹	<ul style="list-style-type: none"> • Catalyst 9404R Switch—24/48 • Catalyst 9407R Switch—24/120 • Catalyst 9410R Switch— 24/192
Supervisor Module Compatibility	<p>C9400-SUP-1, C9400-SUP-1XL, C9400-SUP-1XL-Y, C9400X-SUP-2, and C9400X-SUP-2XL. Also see Table 2: Overview of Supervisor Module-Line Card Compatibility .</p>

Support and Restrictions	Can be installed in any non-supervisor module slot. There are no other restrictions.
---------------------------------	--

¹¹ The number of ports available on a single switch

Figure 12: Front View of the C9400-LC-24XS Line Card

(Click on the image to see the details more clearly.)



1	STATUS LED	5	Ejector levers
2	LOCATE (blue beacon) LED	6	PORT LINK LED
3	Model or product number	7	Line card Radio Frequency Identifier (RFID)
4	Captive installation screws		-

Cisco Catalyst 9400 Series 24-Port 10G/25G Module (C9400-LC-24XY)

Description	<p>24-port fiber optic Ethernet switching module.</p> <ul style="list-style-type: none"> Supported port speed options: <ul style="list-style-type: none"> Port nos. 1 through 4 operate at 10 Gbps speeds, with SFP+ transceivers installed and port nos 5 through 24 operate at 25 Gbps speeds, with SFP28 transceivers installed. This is the default mode. Port nos. 1 through 4 can also operate at 1 Gbps speeds, with SFP transceivers installed. Port nos. 5 through 24 can also operate at 10 Gbps or 1 Gbps speeds, with SFP+ transceivers or SFP transceivers, respectively. Bandwidth is allocated across four 6-port groups; providing 120 Gbps per port group. See Figure 14: Example: 25 Gbps and 10 Gbps Connectivity on C9400-LC-24XY, on page 21. Hardware ready for IEEE 1588/802.1as— A Precision Time Protocol (PTP) used for time synchronization across the network for video and audio applications. Supports full duplex traffic. Has a built-in, front-facing, non-removable, passive RFID tag that uses Ultra High Frequency (UHF) RFID technology and requires an RFID reader with compatible software. For more information, see Radio Frequency Identification (RFID) on Cisco Catalyst 9000 Family Switches.
--------------------	---

Maximum Bandwidth	480 Gbps This value is the maximum bandwidth supported on this line card. The chassis and supervisor module combination that you use determines the final available bandwidth. For more information, see Cisco Catalyst 9400 Series Switch Line Cards Data Sheet .
Minimum / Maximum Port Density¹²	<ul style="list-style-type: none"> • Catalyst 9404R Switch—24 / 48 • Catalyst 9407R Switch—24 / 120 • Catalyst 9410R Switch—24 / 192
Supervisor Module Compatibility	C9400X-SUP-2 and C9400X-SUP-2XL only. Also see: Table 2: Overview of Supervisor Module-Line Card Compatibility .
Support and Restrictions	<ul style="list-style-type: none"> • Can be installed in any non-supervisor module slot. • The C9400-LC-24XY line card is supported starting with Cisco IOS XE Dublin 17.12.1. Before inserting the line card, ensure that the device software is Cisco IOS XE Cisco IOS XE Dublin 17.12.1 or a later release. Before downgrading the device software from Cisco IOS XE Dublin 17.12.1 to an earlier release, ensure that you remove the C9400-LC-24XY line card.

¹² The number of ports available on a single switch.

Figure 13: Front View of the C9400-LC-24XY Line Card

(Click on the image to see the details more clearly.)

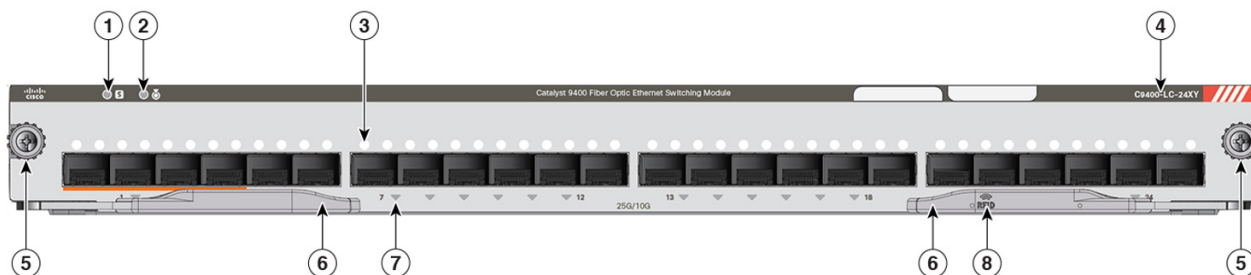

1	STATUS LED	5	Captive installation screws
2	LOCATE (blue beacon) LED	6	Ejector levers
3	Vent holes for the port cage	7	PORT LINK LED
4	Model or product number	8	Line card Radio Frequency Identifier (RFID)

Figure 14: Example: 25 Gbps and 10 Gbps Connectivity on C9400-LC-24XY

The following figure of a C9400-LC-24XY line card shows the four port groupings. It also shows the following for each port group: 4 ports with 25 Gbps connectivity and 1 port with 10 Gbps connectivity. With each port *group* providing up to 120 Gbps, one port in each port group is not used .

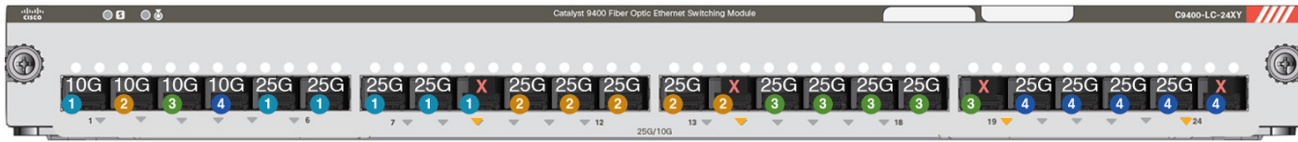

1	Port Group 1; port nos. 1,5, 6, 7, 8, and 9.	10G	Port operating at 10 Gbps speeds.
2	Port Group 2; port nos. 2, 10, 11, 12, 13 and 14.	25G	Port operating at 25 Gbps speeds.
3	Port Group 3; port nos. 3, 15, 16, 17, 18, and 19.	X	Port not used.
4	Port Group 4; port nos. 4, 20, 21, 22, 23, and 24.	-	-

Cisco Catalyst 9400 Series 48-Port 1G SFP Module (C9400-LC-48S)

Description	<p>48-port, 1 Gigabit Ethernet SFP module.</p> <ul style="list-style-type: none"> • Hardware ready for IEEE 1588/802.1as— A Precision Time Protocol (PTP) used for time synchronization across the network for video and audio applications. • Supports full duplex traffic. • Has a built-in, front-facing, non-removable, passive RFID tag that uses Ultra High Frequency (UHF) RFID technology and requires an RFID reader with compatible software. For more information, see Radio Frequency Identification (RFID) on Cisco Catalyst 9000 Family Switches.
Maximum Bandwidth	48 Gbps, full duplex non-blocking traffic.
Minimum / Maximum Port Density ¹³	<ul style="list-style-type: none"> • Catalyst 9404R Switch—48 / 96 • Catalyst 9407R Switch—48 / 240 • Catalyst 9410R Switch—48 / 384
Supervisor Module Compatibility	C9400-SUP-1, C9400-SUP-1XL, C9400-SUP-1XL-Y, C9400X-SUP-2, and C9400X-SUP-2XL. Also see Table 2: Overview of Supervisor Module-Line Card Compatibility .
Support and Restrictions	Can be installed in any non-supervisor module slot. There are no other restrictions.

¹³ The number of ports available on a single switch

Figure 15: Front View of the C9400-LC-48S Line Card

(Click on the image to see the details more clearly.)

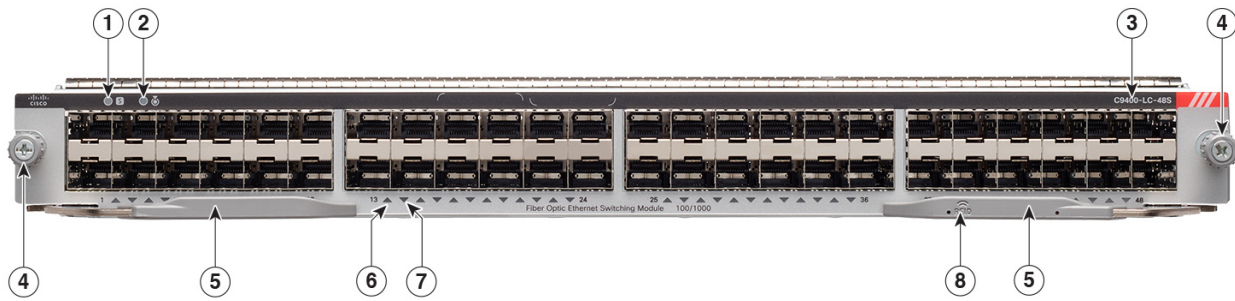

1	STATUS LED	5	Ejector levers
2	LOCATE (blue beacon) LED	6	PORT LINK LED for the port in the top row
3	Model or product number	7	PORT LINK LED for the port in the bottom row
4	Captive installation screws	8	Line card Radio Frequency Identifier (RFID)

Cisco Catalyst 9400 Series 48-Port SFP/SFP+ Module (C9400-LC-48XS)

Description	<p>48 Port SFP/SFP+ Module. These ports can be used interchangeably, as 1G or 10G ports.</p> <ul style="list-style-type: none"> • Hardware ready for IEEE 1588/802.1as— A Precision Time Protocol (PTP) used for time synchronization across the network for video and audio applications. • Supports full duplex traffic. • Has a built-in, front-facing, non-removable, passive RFID tag that uses Ultra High Frequency (UHF) RFID technology and requires an RFID reader with compatible software. For more information, see Radio Frequency Identification (RFID) on Cisco Catalyst 9000 Family Switches.
Maximum Bandwidth	<p>480 Gbps</p> <p>This value is the maximum bandwidth supported on this line card. The chassis and supervisor module combination that you use determines the final available bandwidth. For more information, see Cisco Catalyst 9400 Series Switch Line Cards Data Sheet.</p>
Minimum / Maximum Port Density¹⁴	<ul style="list-style-type: none"> • Catalyst 9404R Switch—48 / 96 • Catalyst 9407R Switch—48 / 240 • Catalyst 9410R Switch—48 / 384
Supervisor Module Compatibility	<p>C9400X-SUP-2 and C9400X-SUP-2XL only. Also see Table 2: Overview of Supervisor Module-Line Card Compatibility .</p>

Support and Restrictions	<ul style="list-style-type: none"> • Can be installed in any non-supervisor module slot. • The C9400-LC-48XS line card is supported starting with Cisco IOS XE Cupertino 17.8.1. Before inserting the line card, ensure that the device software is Cisco IOS XE Cupertino 17.8.1 or a later release. Before downgrading the device software from Cisco IOS XE Cupertino 17.8.1 to an earlier release, ensure that you remove the C9400-LC-48XS line card.
---------------------------------	--

¹⁴ The number of ports available on a single switch

Figure 16: Front View of the C9400-LC-48XS Line Card

(Click on the image to see the details more clearly.)

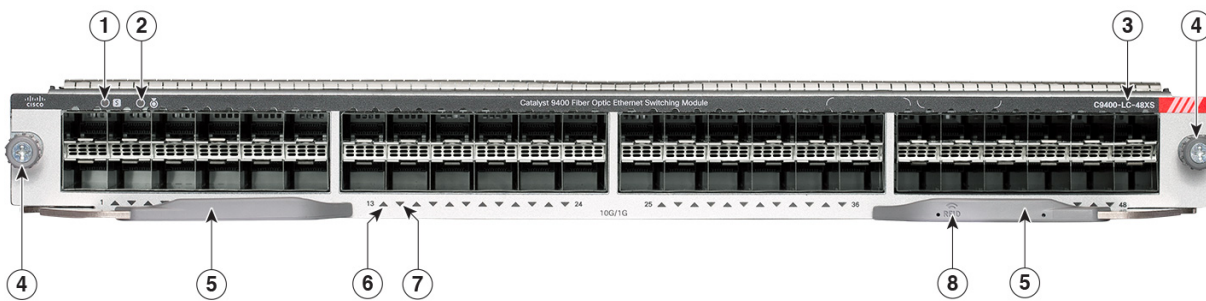



1	STATUS LED	5	Ejector levers
2	LOCATE (blue beacon) LED	6	PORT LINK LED for the port in the top row
3	Model or product number	7	PORT LINK LED for the port in the bottom row
4	Captive installation screws	8	Line card Radio Frequency Identifier (RFID)

Cisco Catalyst 9400 Series Line Card LEDs

Table 3: Cisco Catalyst 9400 Series Line Card LEDs

LED	LED Color	Meaning
 STATUS	Green	All diagnostic tests have passed and the module is operational.
	Amber	The module is booting or running diagnostics or the module is disabled.
	Red	A test other than an individual port test has failed. On some modules, this LED turns red immediately after the system is powered on, until the software boot process begins.
	Off	The module is disabled or is not powered up.

LED	LED Color	Meaning
 LOCATE	Blue	Identifies the module receiving the beacon signal.
 PORT LINK	Green	Port link is up but there is no packet activity.
	Blinking Green	Port link is up and indicating packet activity.
	Amber	Port link is disabled by the user, that is, administratively down.
	Blinking Amber	Hardware (PHY) has detected a faulty port link.
	Alternating Green and Amber	Error packets are being detected on the port link. The error packets could be bad Cyclic Redundancy Check (CRC) packets, jumbo packets, and so on.
	Off	No signal is detected, the link is down, or the port is not connected.

Removing and Replacing Line Cards

All Cisco Catalyst 9400 Series line cards support hot swapping, which lets you install, remove, replace, and rearrange line cards without powering off the system. When the system detects that a line card has been installed or removed, it runs diagnostic and discovery routines automatically, acknowledges the presence or absence of the module, and resumes the system operation with no operator intervention.



Warning **Statement 9001**—Product Disposal

Ultimate disposal of this product should be handled according to all national laws and regulations.

Identifying Line Card Slots

The slot numbers on the fan tray front panel help you easily identify the line card slots or the non-supervisor slots. Install line cards only in these slots.

Figure 17: Line Card Slot Numbers on the Fan Tray's Front Panel

The following figure shows the line card slots in a Catalyst 9407R Switch, where the fan tray model number is C9407-FAN. Fan tray assemblies are chassis-specific and other chassis fan tray front panels have similar numbering, which indicates the line card slots

available on the corresponding

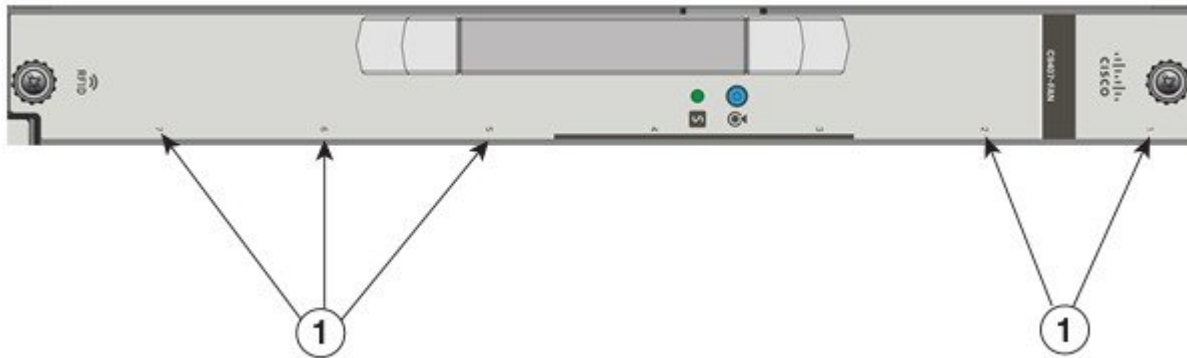

355147

chassis.

1	<p>Line card slots numbered 1, 2, 5, 6, and 7.</p> <p>Note Supervisor module slots are indicated by a vertical bar in addition to the slot number.</p>	-	-
---	---	---	---

Required Tools

You will need these tools to install or remove supervisor modules and line cards:

- Your own ESD-prevention equipment or the disposable grounding wrist strap included with all upgrade kits, field-replaceable units (FRUs), and spares.
- Antistatic mat or antistatic bag
- Number 1 and number 2 Phillips screwdrivers for the captive installation screws on most modules
- 3/16-inch flat-blade screwdriver for the captive installation screws on some modules

Removing a Line Card



Warning Statement 1051—Laser Radiation

Invisible laser radiation may be emitted from disconnected fibers or connectors. Do not stare into beams or view directly with optical instruments.

Before you begin

You will need a blank line card module filler plate (C9400-S-BLANK) if the module slot is to remain empty.

Step 1 Disconnect any network interface cables attached to the line card's ports.

- Step 2** If the module is equipped with removable optical transceivers, immediately install dust plugs into the transceiver’s optical bores. This prevents possible dust contamination, which can affect port performance.
- Step 3** With a Phillips screwdriver, completely loosen the two captive screws located at each end of the module faceplate.
- Step 4** Grasp the left and right ejector levers and simultaneously pivot the levers outward to eject the module from the backplane connector.

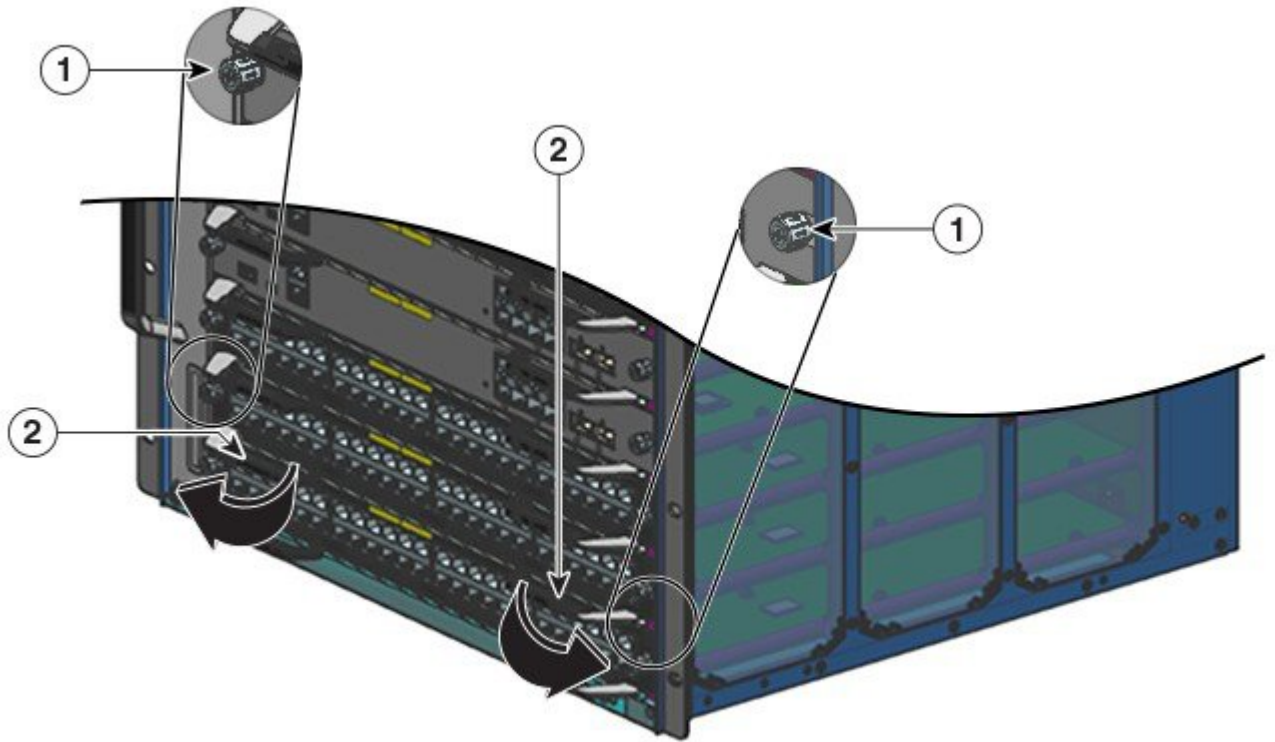

355176

1	Captive installation screws that must be loosened	2	Ejector levers that must be pivoted out
---	---	---	---

- Step 5** Grasp the module front panel with one hand, and place your other hand under the module (on the metal carrier) to support and guide it out of the slot. Do not touch the printed circuit boards or connector pins.
- Step 6** Pull the module straight out of the slot, keeping one hand under the module to support it.
- Step 7** Immediately place the removed module on an antistatic mat, in an antistatic bag, or install it in another slot.
- Step 8** If the slot is to remain empty, install a blank module filler plate to keep dust out of the chassis, maintain proper airflow through the chassis, preserve electromagnetic interference (EMI) integrity, and to prevent exposure to high current inside the chassis.

Warning Statement 1029—Blank Faceplates and Cover Panels

Blank faceplates and cover panels serve three important functions: they reduce the risk of electric shock and fire, they contain electromagnetic interference (EMI) that might disrupt other equipment, and they direct the flow of cooling air through the chassis. Do not operate the system unless all cards, faceplates, front covers, and rear covers are in place.

Installing a Line Card



Warning Statement 1051—Laser Radiation

Invisible laser radiation may be emitted from disconnected fibers or connectors. Do not stare into beams or view directly with optical instruments.



Caution To prevent electrostatic discharge (ESD) damage, handle modules by the carrier edges only.

- Step 1** Take the necessary precautions to prevent ESD damage. Wear a grounded ESD wrist strap while handling the modules, and keep them in ESD-protective bags when they are not installed in a chassis.
- Step 2** Choose a slot for the module.
Verify that you have enough clearance for any interface equipment that you are connecting directly to the line card ports.
- Step 3** Loosen the captive installation screws that secure the existing module or the blank module filler plate in the slot you want to use.
- Step 4** Remove the existing module and immediately place it on an antistatic mat or in an antistatic bag. If you are removing a blank module filler plate, set the blank module filler plate aside for future use.
- Step 5** Remove the new module from its packaging being careful to handle the module using only the module's metal tray or the front panel. Do not touch the printed circuit board or the connector pins.
- Step 6** Pivot the two module ejector levers out away from the module faceplate.
- Step 7** Position the module in front of the chassis slot and align the edges of the printed circuit board with the slot guides on the sides of the switch chassis.
- Step 8** Carefully slide the module into the slot until the notches on both ejector levers engage the chassis sides (the ejector levers start to pivot in towards the faceplate).

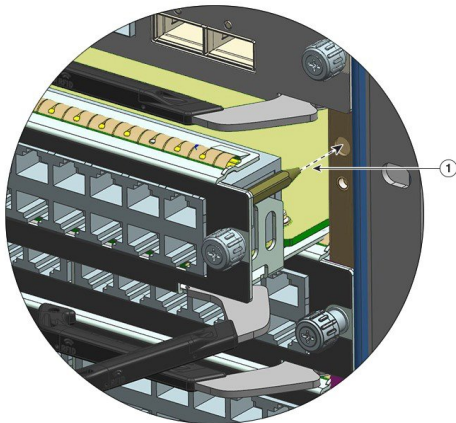

395148

1	Guide pin target indicating that this is a compatible slot for this module.	-	-
---	---	---	---

Tip The guide pin on the top, right-hand corner of a line card is designed to slide into compatible slots only. So the guide pin on a line card will not slide in all the way if you insert it into a supervisor module slot.

Step 9 Using your thumb and forefinger of each hand, simultaneously pivot in both ejector levers, to fully seat the module in the backplane connector.

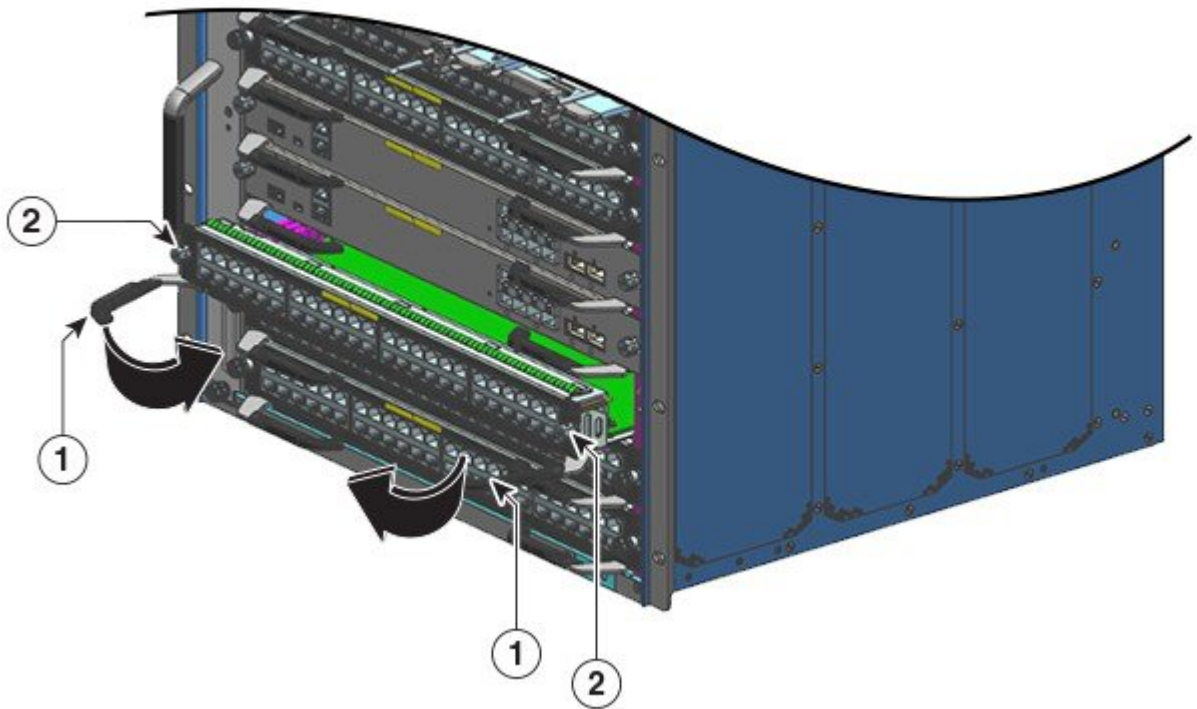

355175

1	Ejector levers that must be pivoted in	2	Captive installation screws that must be tightened
---	--	---	--

Caution Always use the ejector levers when installing or removing modules. A module that is only partially seated in the backplane causes the system to halt or subsequently crash. Further, an improperly seated module may also prevent the system from booting properly.

Note If you perform a hot swap, the console displays the message `Module <n> has been inserted`. This message also appears if you are connected to the switch through a Telnet session.

Step 10 Use a screwdriver to tighten the captive installation screw on each end of the module faceplate.

Step 11 Install any necessary transceivers in the module ports.

Installation instructions along with safety warnings for the various types of transceivers can be found at the following URL: https://www.cisco.com/en/US/products/hw/modules/ps5455/prod_installation_guides_list.html

Step 12 Attach any necessary network interface cables or other devices to the interface ports.

Step 13 Check the status of the module as follows:

- a) Ensure that the STATUS LED is green (module operational).

- b) When the switch is online, enter the **show module** command. Verify that the system acknowledges the new module and that the module status is good.

Step 14 If the module is not operational, try reseating it in the slot. If the module is still not operational, contact your customer representative.

What to do next

To ensure the proper air flow and to maintain EMI protection, make sure that there is a blank module filler plate (C9400-S-BLANK) installed in any unused chassis slot. If a chassis slots are left open, air circulation is disrupted and the fans may not be able to adequately cool the other modules in the chassis.

Related Documentation

For related installation and configuration information, refer to the following:

Release and General Information

Release Notes: <https://www.cisco.com/c/en/us/support/switches/catalyst-9400-series-switches/products-release-notes-list.html>

Provides an overview of the hardware and software features introduced in every release, unsupported features, important restrictions and limitations, and open and resolved caveats with the software.

Hardware Documentation

- Hardware Installation Guide: https://www.cisco.com/c/en/us/td/docs/switches/lan/catalyst9400/hardware/install/b_c9400_hig.html

Provides a functional overview of the switch, describes how to install and rack-mount the switch, and make connections to the switch. It describes how to install the power supplies and how to replace the fan tray assembly. It also includes technical specifications and troubleshooting guidance.

- Supervisor Module Installation Note: https://www.cisco.com/c/en/us/td/docs/switches/lan/catalyst9400/hardware/sup_install/b-c9400-sup-note.html

Provides an overview of the available supervisor modules, major features, chassis compatibility information, slot restrictions, and describes how to correctly install and uninstall a supervisor module.

- Line Card Installation Note: https://www.cisco.com/c/en/us/td/docs/switches/lan/catalyst9400/hardware/sw_mod_install/b-c9400-mod-note.html

Provides an overview of the supported line cards, major features, describes how to correctly install and uninstall a line card, and transceiver support.

- Regulatory Compliance & Safety Information Document: <https://www.cisco.com/c/dam/en/us/td/docs/switches/lan/catalyst9400/hardware/regulatory/RCSI-0315-book.pdf>

Consolidated list of safety warnings relevant to Catalyst 9400 Series Switches (all chassis models), supervisor modules, line cards and any other hardware components.

Software Documentation

- Software Configuration Guide: <https://www.cisco.com/c/en/us/support/switches/catalyst-9400-series-switches/products-installation-and-configuration-guides-list.html>

Provides detailed software configuration information for the features supported on the switch. These guides are release-specific.

- Command Reference: <https://www.cisco.com/c/en/us/support/switches/catalyst-9400-series-switches/products-command-reference-list.html>

Provides command syntax, command history and usage guidelines for the Cisco IOS commands supported on the switch. These guides are release-specific.

Notices

THE SPECIFICATIONS AND INFORMATION REGARDING THE PRODUCTS IN THIS MANUAL ARE SUBJECT TO CHANGE WITHOUT NOTICE. ALL STATEMENTS, INFORMATION, AND RECOMMENDATIONS IN THIS MANUAL ARE BELIEVED TO BE ACCURATE BUT ARE PRESENTED WITHOUT WARRANTY OF ANY KIND, EXPRESS OR IMPLIED. USERS MUST TAKE FULL RESPONSIBILITY FOR THEIR APPLICATION OF ANY PRODUCTS.

THE SOFTWARE LICENSE AND LIMITED WARRANTY FOR THE ACCOMPANYING PRODUCT ARE SET FORTH IN THE INFORMATION PACKET THAT SHIPPED WITH THE PRODUCT AND ARE INCORPORATED HEREIN BY THIS REFERENCE. IF YOU ARE UNABLE TO LOCATE THE SOFTWARE LICENSE OR LIMITED WARRANTY, CONTACT YOUR CISCO REPRESENTATIVE FOR A COPY.

The Cisco implementation of TCP header compression is an adaptation of a program developed by the University of California, Berkeley (UCB) as part of UCB's public domain version of the UNIX operating system. All rights reserved. Copyright © 1981, Regents of the University of California.

NOTWITHSTANDING ANY OTHER WARRANTY HEREIN, ALL DOCUMENT FILES AND SOFTWARE OF THESE SUPPLIERS ARE PROVIDED "AS IS" WITH ALL FAULTS. CISCO AND THE ABOVE-NAMED SUPPLIERS DISCLAIM ALL WARRANTIES, EXPRESSED OR IMPLIED, INCLUDING, WITHOUT LIMITATION, THOSE OF MERCHANTABILITY, FITNESS FOR A PARTICULAR PURPOSE AND NONINFRINGEMENT OR ARISING FROM A COURSE OF DEALING, USAGE, OR TRADE PRACTICE.

IN NO EVENT SHALL CISCO OR ITS SUPPLIERS BE LIABLE FOR ANY INDIRECT, SPECIAL, CONSEQUENTIAL, OR INCIDENTAL DAMAGES, INCLUDING, WITHOUT LIMITATION, LOST PROFITS OR LOSS OR DAMAGE TO DATA ARISING OUT OF THE USE OR INABILITY TO USE THIS MANUAL, EVEN IF CISCO OR ITS SUPPLIERS HAVE BEEN ADVISED OF THE POSSIBILITY OF SUCH DAMAGES.

Any Internet Protocol (IP) addresses and phone numbers used in this document are not intended to be actual addresses and phone numbers. Any examples, command display output, network topology diagrams, and other figures included in the document are shown for illustrative purposes only. Any use of actual IP addresses or phone numbers in illustrative content is unintentional and coincidental.

All printed copies and duplicate soft copies of this document are considered uncontrolled. See the current online version for the latest version.

Cisco has more than 200 offices worldwide. Addresses and phone numbers are listed on the Cisco website at www.cisco.com/go/offices.

Cisco and the Cisco logo are trademarks or registered trademarks of Cisco and/or its affiliates in the U.S. and other countries. To view a list of Cisco trademarks, go to this URL: <https://www.cisco.com/c/en/us/about/legal/trademarks.html>. Third-party trademarks mentioned are the property of their respective owners. The use of the word partner does not imply a partnership relationship between Cisco and any other company. (1721R)

