



Connected Utilities Virtual RTU Implementation Guide

This implementation guide includes the following major sections:

Introduction, page 1	Introduction to the Virtual RTU application and SCADA protocol matrix supported by Virtual RTU.
System Use Cases, page 4	Description of the Secondary Substation Monitoring, Distribution Automation, and Protocol translation use cases.
System Overview and Components, page 9	Overview of system topology and description of the hardware and software components used in the Virtual RTU system.
Lifecycle Management Implementation, page 11	Implementation details of the Lifecycle Management with reference to Virtual RTU and the Cisco IR 8x9 Integrated Services Router.
SCADA Protocol Translation Use Case using Virtual RTU, page 30	Implementation details of Virtual RTU protocol translation use cases.
Limitations, page 83	Description of Virtual RTU system limitations.
References, page 83	List of references that are relevant to Virtual RTU.
Glossary, page 84	Acronyms and initialisms used in this document.

Introduction

This chapter includes the following topics

- [Overview, page 1](#)
- [Audience and Scope, page 2](#)
- [Implementation Workflow, page 3](#)

Overview

This document captures implementation details of the Virtual Remote Terminal Unit (Virtual RTU) application on the Cisco IR8x9 Integrated Services Router and Cisco IR1101 Integrated Services Router Rugged, which can be deployed as a secondary substation or as a distribution automation gateway. The Virtual RTU application's lifecycle is managed using the Cisco Internet of Things (IoT) Field Network Director (FND). Eximprod, which provides our Supervisory Control and Data Acquisition (SCADA), is a Cisco Solution partner. The ES200 is Eximprod's Virtual RTU application. When we use Virtual RTU terminology in this document, we are referring to the only software we have validated—the ES200.

Use cases that have been addressed in this guide are SCADA visibility and monitoring of secondary substation intelligent end devices (IEDs), SCADA protocol translations, and life cycle management of Virtual RTU. Later, this document will be expanded to include distribution automation use cases such as Fault Location Identification and Service Restoration (FLISR) and Volt/VAR. Finally, this information will be integrated into the Secondary Substation CVD planned efforts that are under the umbrella of the Cisco Field Area Network (FAN) Solution.

Protocol translation supported matrix support by Virtual RTU is shown in [Table 1](#).

Table 1 Virtual RTU SCADA Protocol Translation Communication Mode Matrix

Communication Protocol	Type	Communication Mode Serial RS232/RS485	Communication Mode Ethernet TCP/IP
Modbus	Master/Client	Yes	Yes
	Slave/Server	No	Yes
DNP3	Master/Client	Yes	Yes
	Slave/Server		
IEC 608750-5-104	Master/Client	NA	Yes
	Slave/Server	NA	
IEC 61850 MMS	Client	NA	Yes

Virtual RTU ES200 will work as the Modbus/DNP3/IEC 61850-MMS master to Southbound SCADA clients in the secondary substation (or distribution feeder controller) and, in turn, can act as the Modbus/DNP3 Slave/T104 to Northbound Distribution System Operator (DSO) SCADA systems. Southbound of Virtual RTU can be Ethernet or RS232 and Northbound is Ethernet TCP/IP communication.

Table 2 Virtual RTU SCADA Protocol Translation Support Matrix

Southbound Protocol (Virtual RTU < > IED)	Northbound Protocol (Virtual RTU < > SCADA CC)	Virtual RTU support availability	Validated for this implementation guide
DNP3 - Serial	DNP3 - IP	Yes	Yes
DNP3 - IP	Modbus	Yes	Yes
DNP3 - IP	T104	Yes	Yes
IEC 61850 MMS	T104	Yes	Yes
IEC 61850 MMS	DNP3 - IP	Yes	Yes
Modbus	DNP3 - IP	Yes	No
Modbus	T104	Yes	No

For more details about Virtual RTU, please refer to the following:

- <http://www.epg.ro/wp-content/uploads/2017/09/ES200-Datasheet-public.pdf>
- https://en.wikipedia.org/wiki/Remote_terminal_unit

Audience and Scope

The audience of this guide comprises, but is not limited to, system architects, network/compute/system engineers, field consultants, Cisco Advanced Services specialists, and customers.

This guide describes how to deploy edge compute applications. Readers should be familiar with networking protocols, Network Address Translation (NAT), and SCADA protocols, and have exposure to Edge computing and Field Area Network Solution Architecture.

Implementation Workflow

Figure 1 provides the high-level implementation flow for deploying Virtual RTU use cases.

Figure 1 Virtual RTU Implementation Workflow

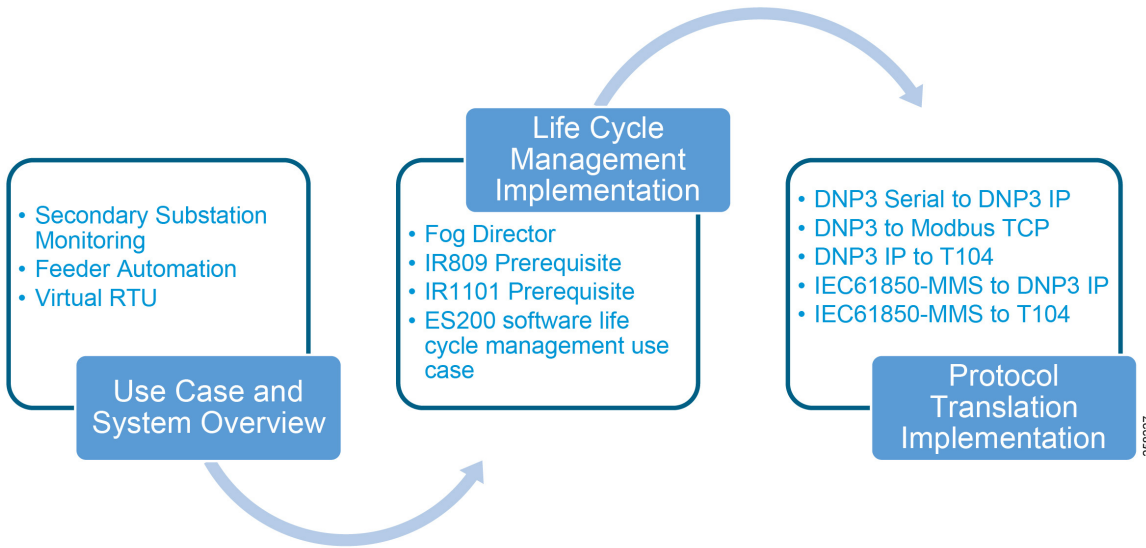

System Use Cases

This chapter, which describes secondary substation monitoring, distribution automation, and SCADA Protocol translation use cases and how the use of Virtual RTU will benefit DSOs, includes the following major topics:

- [Secondary Substation Monitoring, page 4](#)
- [Distribution \(Feeder\) Automation, page 5](#)
- [Virtual RTU and Protocol Translation, page 6](#)

Secondary Substation Monitoring

Secondary substations are used to step down the power voltage from medium (1kv - 40 kV) to low voltage (110/220 V). A secondary substation hosts a transformer and a number of devices called intelligent end devices (IEDs) such as circuit breakers, voltage sensors, reclosers, and surge protectors. IEDs are currently managed by a centralized application located at the DSO's Control Center called the SCADA. IEDs are connected to RTUs in the secondary substation. DSO SCADA software will be communicated to Remote RTUs to poll for the current register value associated with IEDs or to issue control command.

A secondary substation may also host a smart meter concentrator that collects data from the meters and performs local processing to report information back to the Control Center. Information and Communication Technology networks play a key role in connecting secondary substation RTUs to centralized SCADA systems.

Figure 2 Secondary Substation

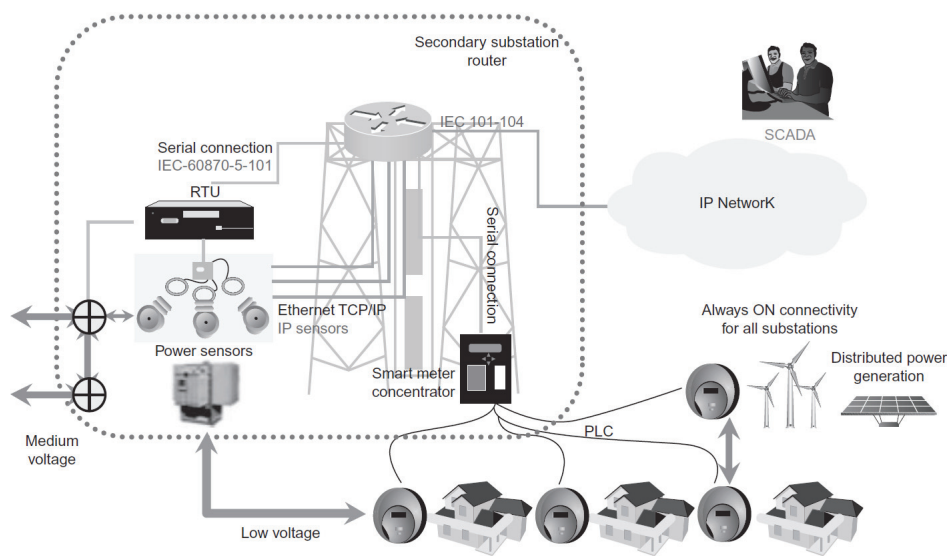

378415

In [Figure 2](#), two different physical components are depicted: RTUs and the substation router. In the Virtual RTU use case, we are combining two different functionalities into one physical component: the Virtual RTU Eximprod ES200 application, which will be hosted on the Cisco IR809/IR1101 secondary substation router as an edge compute application container.

Distribution (Feeder) Automation

Distribution Automation (DA) refers to the monitoring and control of devices located out on the feeders themselves such as line reclosers, load break switches, sectionalizers, capacitor banks, and line regulators.

Distribution Automation is the overlay network deployed in parallel to the Distribution Feeder to enable the two-way communication between controllers used in the Distribution Feeder and Intelligence Application that is residing in the Utility Control Center or Substation for improving grid reliability, availability, and control.

Figure 3 depicts a typical DA system.

Figure 3 Distribution Automation

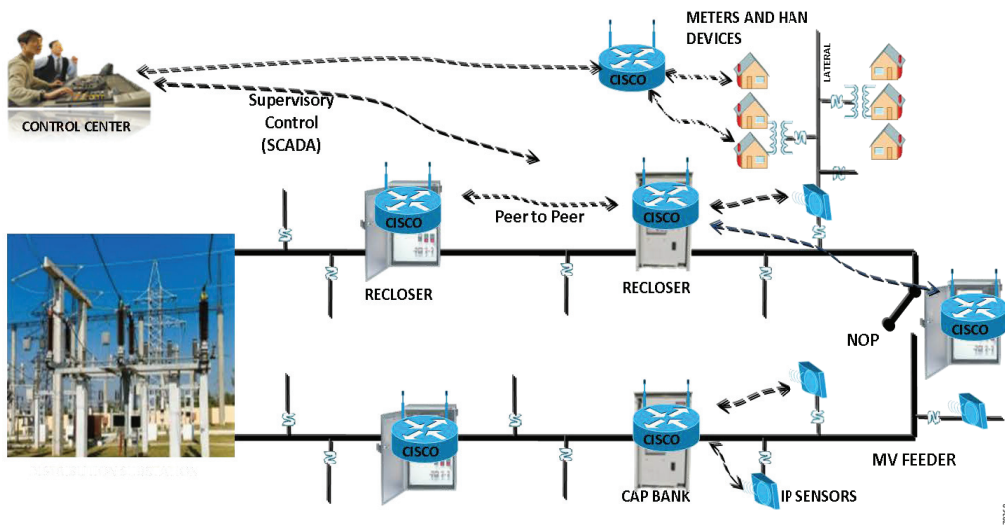

Two important use cases for Distribution Automation are:

- FLISR
- DA Volt/VAR regulation

DA Volt/VAR Regulation and FLISR use cases will be deployed globally around the world. Cisco DA gateways such as Cisco IR807, IR807, and IR1101 will be deployed 1:1 with DA controllers, including the recloser controller and capacitor bank controllers.

FLISR Use Case

Fault Location Isolation and Service Restoration (FLISR) is the process for dealing with fault conditions on the electrical grid. The following occurs as part of this process:

1. Detects (and locates) faults
2. Isolates the faults to the smallest segment of the grid possible
3. Restores as much service as possible while the fault is isolated

FLISR includes automatic sectionalizing and restoration and automatic circuit reconfiguration. These applications accomplish DA operations by coordinating operation of field devices, software, and dedicated communication networks to automatically determine the location of a fault, and then rapidly reconfigure the flow of electricity so that some or all of the customers can avoid experiencing outages.

System Use Cases

Because FLISR operations rely on rerouting power, they typically require feeder configurations that contain multiple paths to single or multiple other substations. This creates redundancies in power supply for customers located downstream or upstream of a downed power line, fault, or other grid disturbance.

Benefits of FLISR include:

- Consumers experience minimal outage.
- Utilities improve their System Average Interruption Duration Index (SAIDI) and System Average Interruption Frequency Index (SAIFI) numbers and avoid financial penalties that could be levied by the regulator.

Volt/VAR Use Case

This use case address automating dynamic and efficient delivery of power. Utilities look at achieving large savings by enhancing the efficiency of their power distribution infrastructure; in other words, improving the effectiveness of the flow of electricity. In order to evaluate the process, it is important to review the differences between what is called *real power* and *reactive power*.

Real power is what we use to run all lights, devices, and production lines. It is the power that does the work. Reactive power does not contribute anything to doing work, but it does cause conductors to heat up and takes up a certain amount of space in the wires. The more reactive power flowing on a line, the less room exists for real power and the less efficient is the distribution system.

Today, in order to eliminate or at least minimize reactive power flows, utilities have deployed on their local distribution systems devices such as capacitor banks or special transformers that are typically located at substations or on a feeder. These devices work to keep reactive power flows down, making the full capacity of the conductor available for the real power. This process is known as Volt/VAR regulation or control.

- **VAR Compensation**—Improves efficiency of energy supply by ensuring voltage and current are in phase when supplied to the customer.
- **Conservation Voltage Regulation**—During peak load, ensures the minimum required voltage level is supplied to the customer.

Most existing deployments have a centralized approach of controlling DA controllers from the DSO Control Center using SCADA applications. Utilities are moving towards distributed control approach where decisions can be made more quickly at the distribution feeder level by running customer business logic at the DA Gateway level. Cisco IR809 plays a perfect role for these deployment scenarios since we can host Virtual RTU software that allows utilities to implement customer business logic according to their requirements and needs.

Virtual RTU and Protocol Translation

Virtual RTU

Eximprod ES200 over the Cisco IR8x9 and IR1101 series, as shown in [Figure 4](#), is a fourth-generation (Internet of Things or IoT) SCADA RTU gateway for control, measurement, and supervision in power distribution systems. ES200 is designed to efficiently operate secondary distribution substations, feeders, and electrical substations using modern and secure communication and automation standards.

Virtual RTU can integrate existing multi-vendor equipment and runs SCADA software without dedicated hardware. Since it is software based, RTU time to deploy and add new features can be done more quickly than with legacy hardware RTU. Security features and customer business logic can be implemented based on customer requirements.

Figure 4 Eximprod ES200

ES200 – Combined SCADA and ITC

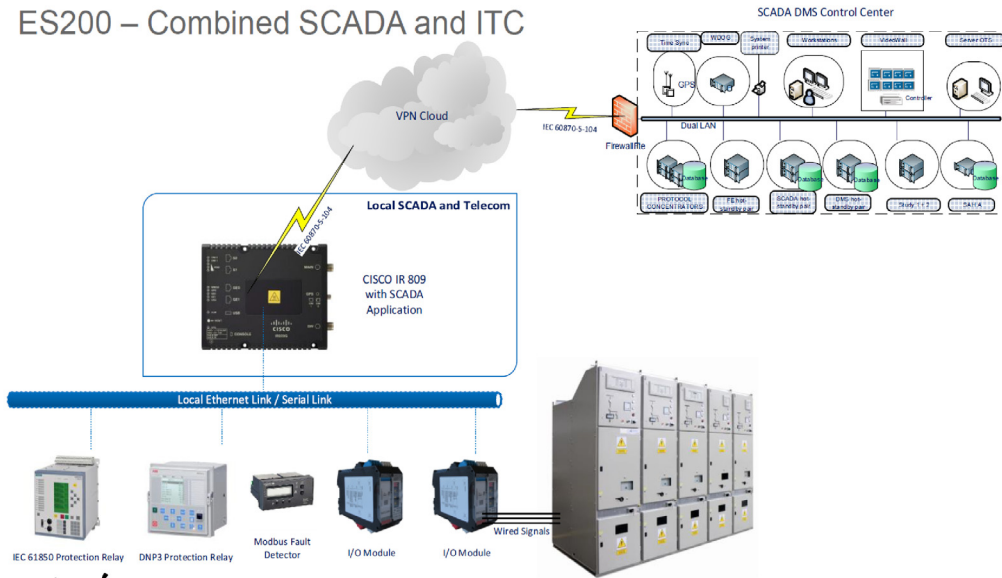

SCADA Protocol Translation

SCADA protocol translations are needed when DSO is running different (or advance) SCADA protocols as compared to field devices in secondary substation IEDs or distribution feeder controllers. Another scenario for protocol translations is when the last mile (such as between DA gateway and field devices) is connected via a legacy RS232 connection, but the DSO connections are migrated to Ethernet TCP/IP.

Figure 5 depicts a SCADA protocol translation scenario where the DSO SCADA uses the Modbus TCP Protocol, but sensors and actuators in the secondary substation are using Distributed Network Protocol 3 (DNP3).

Figure 5 SCADA Protocol Translation using Virtual RTU

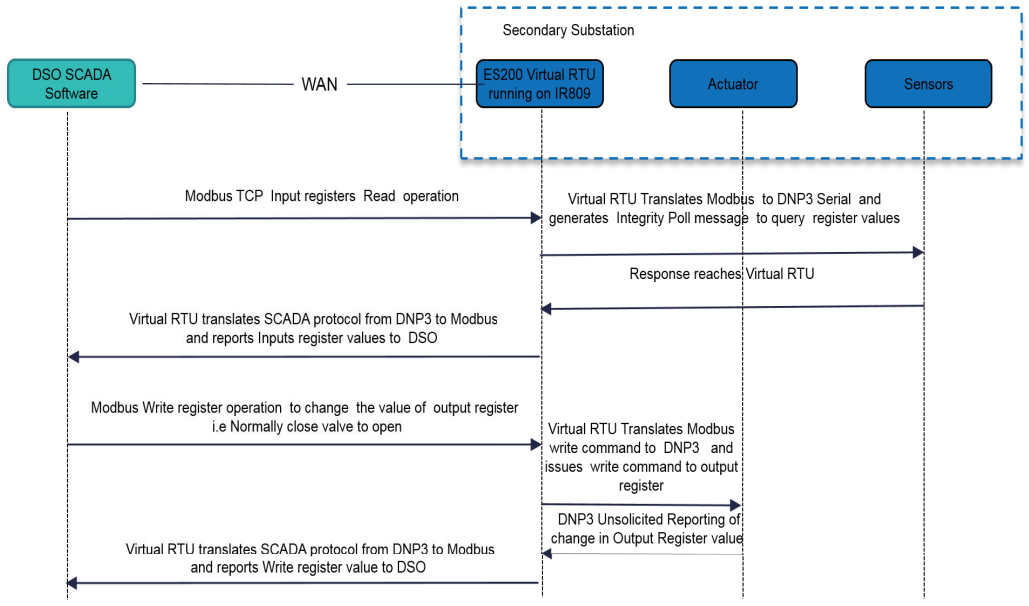

The SCADA protocol translation matrix supported by Virtual RTU is explained in [Introduction, page 1](#). The various SCADA protocol translation implementations are explained in [SCADA Protocol Translation Use Case using Virtual RTU, page 30](#).

Note: The protocol translations are not related to the implementation of Cisco IOS.

IEC 61850 SCADA Protocol Translation

This translation from IEC 61850 MMS to T104 or DNP3 and *vice versa* is achieved by using Virtual RTU running on the edge gateway.

Figure 6 IEC 61850 SCADA Protocol of IEC 61850 MMS

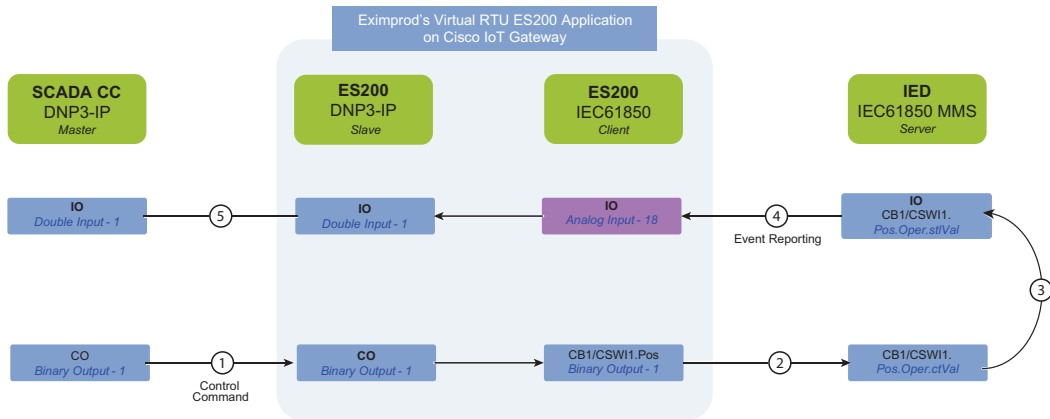

1. The Control Relay Output Blocks (CROB) Control command on the DNP3 Binary Output register is initiated from the SCADA Control Center to the ES200 application
2. The ES200 application translates the DNP3 Binary Output point to the IEC 61850 Binary point and forwards it to the IED Oper.OperVal register where actual control is required.
3. The Oper.OperVal updates the status to the Pos.Oper.ctVal register.

4. IEC 61850 then updates the ES200 IEC 61850 client about this updated value. The ES200 internally translates the Analog Input to the DNP3 Double Input point.
5. The unsolicited reporting feature of DNP3 would immediately report the updated value to the SCADA Control Center.

System Overview and Components

The solution is comprised of the Utilities Distributed System Operator Control Center block (the green cloud in the solution topology in Figure 7), the Wide Area Network (WAN) block, and the Secondary Substation block.

The Cisco IoT FND and SCADA software are installed on the DSO. The Cisco ASR 1000 series router is acting as the Headend Router (HER/Control Center router), which terminates the encrypted tunnels from different secondary substation routers. Encrypted tunnels carry SCADA traffic. HER decrypts and routes SCADA traffic to DSO SCADA systems. The Cisco IoT FND is used for lifecycle management of the Virtual RTU application. For more information about Cisco ASR 1000, please refer to Cisco ASR 1000 Series Aggregation Services Routers at the following URL:

- <https://www.cisco.com/c/en/us/products/routers/asr-1000-series-aggregation-services-routers/index.html>

Backhaul to the DSO Control Center can be Ethernet or cellular. Backhaul can be fully secured through Cisco's VPN technologies such as Cisco Dynamic Multipoint Virtual Private Network (DMVPN) and Cisco FlexVPN.

Figure 7 Virtual RTU Solution Topology

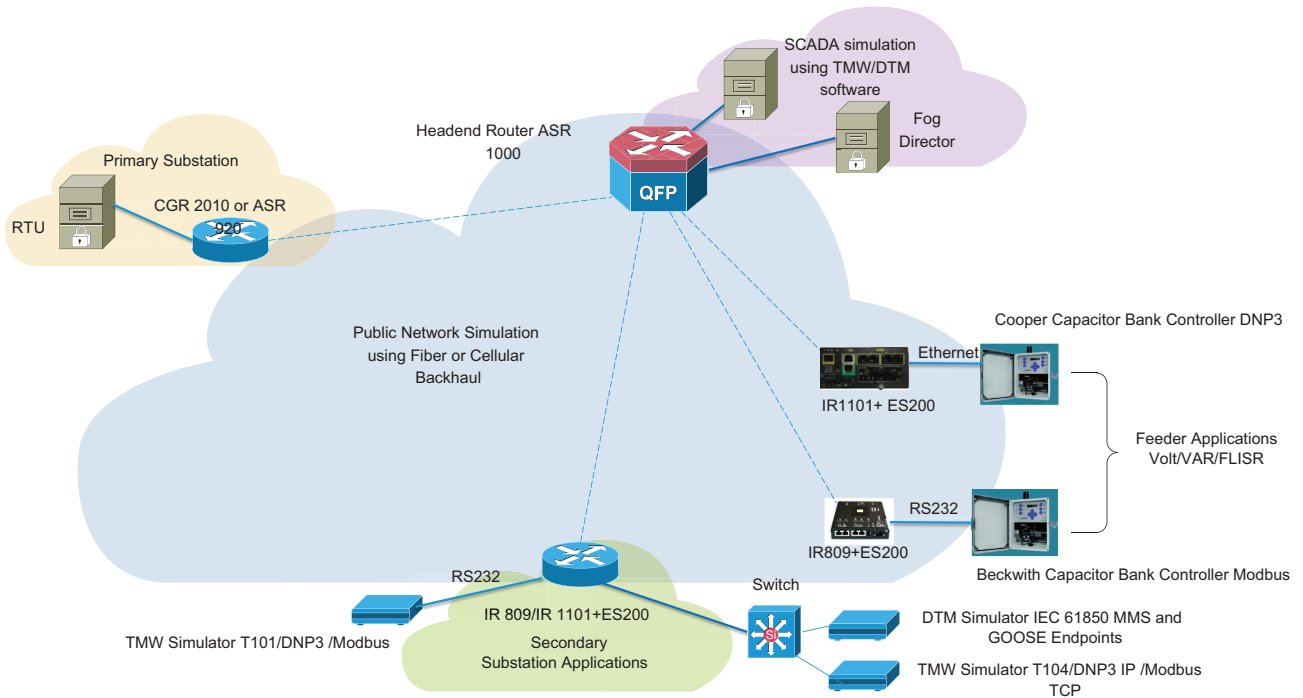

In the topology in Figure 7, the Virtual RTU ES200 software is installed on the Cisco IR809, which is acting as a secondary substation router. Sensors and actuators are simulated using a PC running the Triangle MicroWorks (TMW) Protocol Test Harness application and Distributed Test Manager (DTM). A PC running TMW is connected to the Cisco IR809/IR1101 using Ethernet and serial (RS232) interfaces. This guide will be later enhanced to include Distribution Automation use

cases. Table 3 lists the hardware and software combination used in solution validation.

Table 3 Hardware and Software Matrix

Device	Software version
Cisco IR809	Refer to the following URL: <ul style="list-style-type: none"> ■ https://software.cisco.com/download/home/286287094/type/280805680/release/15.8.3M2a
Cisco IR1101	Refer to the following URL: <ul style="list-style-type: none"> ■ https://software.cisco.com/download/home/286319772/type/282046477/release/Gibraltar-16.12.1
Cisco Fog Director	<ul style="list-style-type: none"> ■ 1.8.1 was the latest available version during validation. ■ 1.9.0 is the latest available version in CCO, released during the documentation phase.
Eximprod ES200	<p><i>Docker container</i> inovium/es200 tag: 2.1</p> <p><i>PaaS application</i> ir1101_es200_3.8.tar es200_ir809_3.8.tar</p>
Distributed Test Manager (DSO Center SCADA and IED simulators)	1.4.0.4
Protocol Test Harness (Southbound IED simulator)	3.17.3.0

Note: Contact Eximprod's team at <https://www.epg.ro/en/contact/>, to download Eximprod's Virtual RTU software and to generated to license for Eximprod's license for edge devices.

Lifecycle Management Implementation

This chapter includes the following major topics:

- [Cisco IR809 Prerequisites, page 11](#)
- [Cisco IR1101 Prerequisites, page 14](#)
- [Cisco Fog Director, page 17](#)
- [ES200 Lifecycle Management, page 26](#)

Cisco IR809 Prerequisites

Image and Upgrade Details

Note: Cisco IR809 should be running with a minimum 15.6 version to support the Docker container application. For details, please refer to the release notes at the following URL:

- <https://www.cisco.com/c/en/us/td/docs/routers/access/800/829/15-6-3M2-Release-Notes.html>

It is recommended to install the latest image version from the <https://software.cisco.com/download/home> website.

1. Download and copy the Cisco IR809 bundle image to the Cisco IR809 flash drive.
2. Stop guest OS:

```
guest-os 1 stop
```

3. Upgrade guest OS using the following command. After upgrading, restart the router.

```
bundle install flash:<bundle_image_name>
```

4. Verify the upgrade using the following command:

```
DEM01-89-250#show platform guest-os
Guest OS status:
Installation: Cisco-GOS,version-1.3.2.3
State: RUNNING
```

```
DEM01-89-250#show iox host list
Host Name          IPV4 Address      IPV6 Address      IOx Client
Version
-----
DEM01-89-250-GOS-1  192.168.1.250    fe80::1ff:fe90:8b05  0.4
-----
```

5. Make sure you have the correct licenses:

```
License UDI:
```

```
-----
Device#  PID          SN
-----
*1       IR809G-LTE-GA-K9  JMX1941X00B
```

```
Suite License Information for Module:'ir800'
```

Lifecycle Management Implementation

Suite	Suite Current	Type	Suite Next reboot
Technology Package License Information for Module:'ir800'			
Technology	Technology-package Current	Type	Technology-package Next reboot
ibase	ibasek9	Permanent	ibasek9
security	securityk9	Permanent	securityk9
data	datak9	Permanent	datak9

6. WAN interface configuration for Northbound communication towards DSO Control Center:

```
interface GigabitEthernet0
description to WAN Backhaul
ip address 10.10.70.89 255.255.255.0
ip nat outside
ip virtual-reassembly in
duplex auto
speed auto
```

Note: If Cellular is used as an underlay WAN interface, ignore the GigabitEthernet interface configuration and configure the Cellular interface. For details on the Cellular configuration, refer to the *Distribution Automation - Secondary Substation (Design Guide)* at the following URL:

- <https://www.cisco.com/c/en/us/td/docs/solutions/Verticals/Distributed-Automation/Secondary-Substation/DG/DA-SS-DG.html>

7. Internal interface to IOx:

```
interface GigabitEthernet2
description IOx
ip address 192.168.1.1 255.255.255.0
ipv6 address autoconfig
ipv6 enable
ip nat inside
ip virtual-reassembly in
duplex auto
speed auto
iox client enable interface GigabitEthernet2
```

8. IED Ethernet interface:

```
interface GigabitEthernet1
description RTU
ip address 192.168.2.1 255.255.255.0
ip nat inside
ip virtual-reassembly in
duplex auto
speed auto
```

9. Serial Interface connecting to serial devices in the substation (Southbound):

```
interface Async0
no ip address
encapsulation relay-line
media-type rs232
async mode dedicated
```

The command *encapsulation relay-line* is used to relay the serial traffic to IOx application.

Note: Validation was done using RS232 based on the configuration above. Async0 can work in RS232 DCE mode and RS485 DCE Mode. Async1 can only work in RS232 DTE mode.

10. Serial relay configuration:

```
line 1
exec-timeout 0 0
no exec
transport preferred none
transport input all
transport output none
stopbits 1
```

Note: Async0 and Async1 reserve line 1/5 and 1/6, respectively, to relay serial data to the corresponding GuestOS /dev/ttyS1 and /dev/ttyS2.

Serial Relay Line allows Serial ports to pass traffic directly to the Guest OS:

```
relay line 1 1/5 propagation
relay line 2 1/6 propagation
```

Note: Propagation options allow the baudrate, databits, stopbits, and parity propagation from Guest OS. If propagation is present, the control parameters will be passed from the Guest OS to the IOS physical port.

Figure 8 Serial Interface: IR8x9 IOx–IOxVM

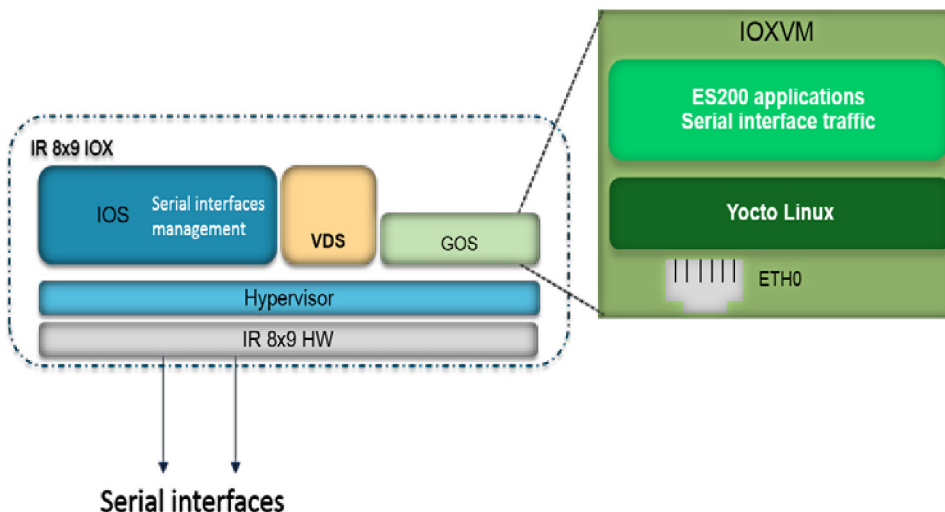

11. IOS NAT:

Static NAT or Interface overload needs to be configured:

```
ip nat inside source static 192.168.1.250 10.10.70.250
```

In this example, 192.168.1.250 is the Guest OS IP address. We are doing Static NAT to convert into a public routable IP address. Fog Director uses this public IP address to identify the device.

To preserve the public IP address interface, overload can be used.

A sample configuration is shown below:

```
ip access-list standard NAT_ACL
permit 192.168.0.0 0.0.255.255
ip nat inside source list NAT_ACL interface gigabitEthernet0 overload
```

Figure 9 NAT: IOxVM Network Interfaces

- NAT mode – each LXC gets ETH0 INET address allocated from Linux DHCP Server pool – required static NAT port mapping for server applications

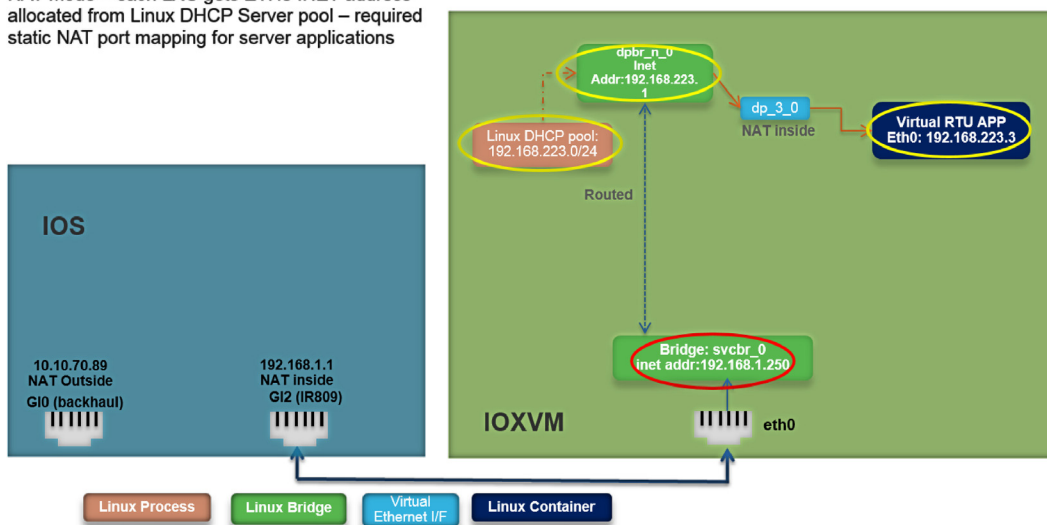

12. iOx NAT:

The app obtains the IP address from a DHCP server within iOx. iOx then assigns the outside port numbers if the application is deployed in NAT mode.

iOx should be configured in NAT mode for docker container applications.

The port required by application should be specified in the YAML file. For the ES200 Virtual RTU application, the Port 1731 needs to be opened up.

13. LTE Backhaul and Network Layer Encryption:

Please refer to the *Cisco IR800 Integrated Services Router Software Configuration Guide* at the following URL:

- <https://www.cisco.com/c/en/us/td/docs/routers/access/800/829/software/configuration/guide/IR800config.pdf>

Cisco IR1101 Prerequisites

IR1101 Virtual Port Group Mapping for IOx

The VirtualPortGroup interface connects the application hosting network to the IOS routing domain. The Layer 3 interface of the application receives routed traffic from IOS. The VirtualPortGroup interface connects through the SVC Bridge to the container/application interface.

Figure 10 helps to understand the relationship between the VirtualPortGroup and other interfaces, since it is different from IR8x9 routers.

Note: IR1101 uses VirtualPortGroup to communicate with Edge Compute application, instead of Gi2 interface as in IR8x9 routers.

Figure 10 VirtualPortGroup Mapping

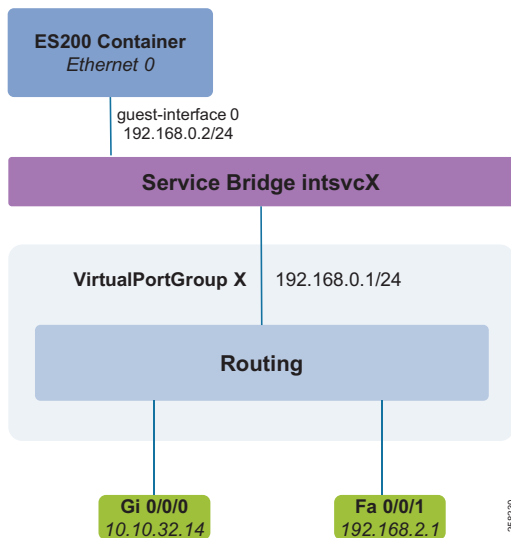

Image and Upgrade Details

Note: Cisco IR1101 should be running with a minimum 16.12.01 version to support the IOx application. For details, please refer to the *Release Notes for Cisco IR1101 Industrial Integrated Services Router, Cisco IOS XE Gibraltar 16.12.x* at the following URL:

- <https://www.cisco.com/c/en/us/td/docs/routers/access/1101/release/IR1101-release-notes-16-12-1.html>

1. Download and copy the Cisco IR1101 IOS-XE image to the Cisco IR1101 flash drive.
2. Enter global configuration:

```
IR1101- FCWxxxxxxxx # configure terminal
IR1101- FCWxxxxxxxx (config) #
```

3. Delete all entries in the bootable image list:

```
IR1101- FCWxxxxxxxx (config)# no boot system
```

4. Configure boot system variable:

```
IR1101- FCWxxxxxxxx (config)# boot system bootflash:<system-image-filename.bin>
```

5. Save the configuration:

```
IR1101- FCWxxxxxxxx # write memory
```

6. Reload the device:

```
IR1101- FCWxxxxxxxx # reload
```

7. After the device restarted with the latest image, verify the IOx service status using the following command:

```
IR1101-FCWxxxxxxxx#sh iox-service detail
```

```
IOx Infrastructure Summary:
-----
IOx service (CAF)      : Running
IOx service (HA)      : Not Supported
```

Lifecycle Management Implementation

```
IOx service (IOxman) : Running
LibvirtD             : Running
```

Verify that CAF and IOxman services are in running state.

8. Make sure you have the correct licenses:

```
IR1101-FCWxxxxxxx#show license udi
UDI: PID:IR1101-K9,SN:FCWxxxxxxx
```

9. WAN interface configuration for Northbound communication towards the DSO Control Center:

```
interface VirtualPortGroup0
 ip address 192.168.0.1 255.255.255.0
 ip nat inside
!
interface GigabitEthernet0/0/0
 ip address dhcp
 ip nbar protocol-discovery
 ip nat outside
```

10. IED Ethernet interface:

```
interfaceFastEthernet0/0/1
 switchport access vlan 2
 switchport mode access

interface Vlan2
 ip address 192.168.2.1 255.255.255.0
```

11. Serial Interface connecting to serial devices in the substation (Southbound):

```
interface Async0/2/0
 no ip address
 encapsulation relay-line
```

12. Serial relay configuration:

```
line con 0
 exec-timeout 0 0
 stopbits 1
 speed 115200
 line 0/0/0
 transport preferred none
 transport output none
 stopbits 1
 line 0/2/0
 transport preferred none
 transport input all
 transport output all
 stopbits 1
 line vty 0 4
 login local
 transport input all
 transport output all
!
relay line 0/0/0 0/2/0
```

Note: Validation was done using RS232 based on the configuration above on interface Async0. On IR1101, *line 0/2/0* is the same as *line 50*.

Cisco Fog Director

Note: Fog Director features are integrated into the latest Cisco IOT FND. For the purpose of validation, we have used Fog Director for IR8x9 and IOx Local Manager WebUI for IR1101. The Cisco IOT FND version was not available during the implementation phase of this document.

For more details on Cisco IOT FND, refer to the following URL:

- <https://www.cisco.com/c/en/us/products/cloud-systems-management/iot-field-network-director/index.html?dtdid=sscsc000283>

How to Install Cisco Fog Director

To install the Cisco Fog Director, please refer to the *Cisco Fog Director Reference Guide, Release 1.8* at the following URL:

- https://www.cisco.com/c/en/us/td/docs/routers/access/800/software/guides/iox/fog-director/reference-guide/1-8/fog_director_ref_guide.html

The recommended version is 1.3 and above.

Figure 11 Cisco Fog Director Version

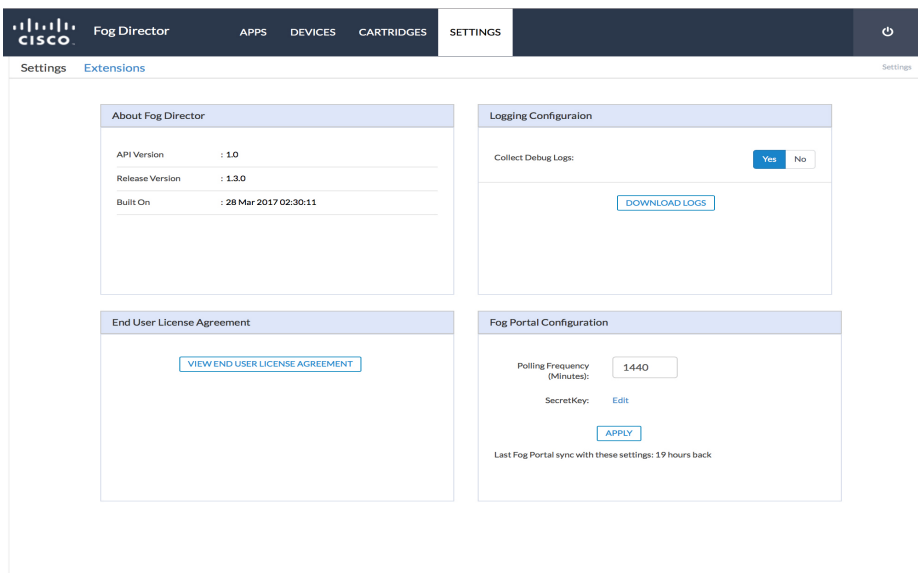

378302

Adding Cisco IR809 Secondary Substation Router into Fog Director

1. From Devices, click **Add**, as shown in [Figure 12](#), and then enter the relevant details for devices such as IP address and port:

Figure 12 Adding Cisco IR809 in Fog Director

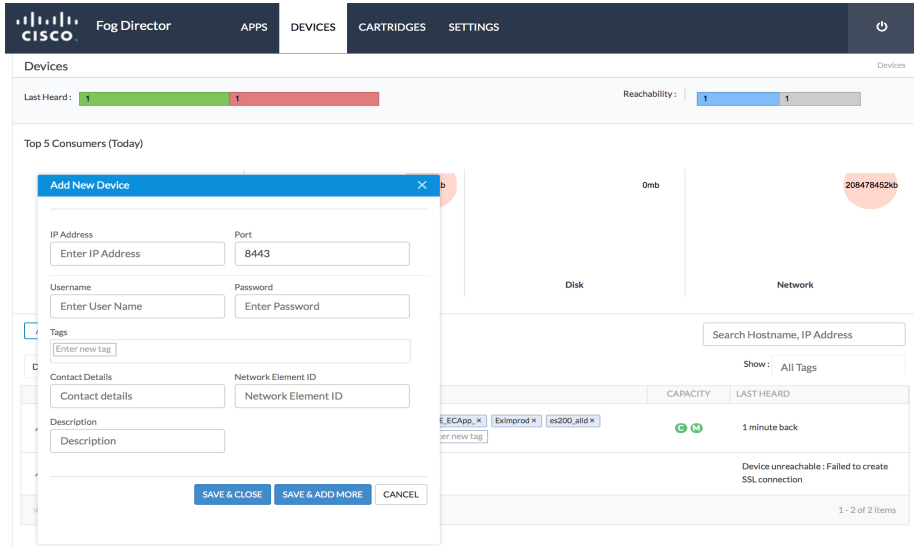

2. Once the device is added successfully, you can verify the last heard status using the option shown in [Figure 13](#).

Figure 13 Device Status

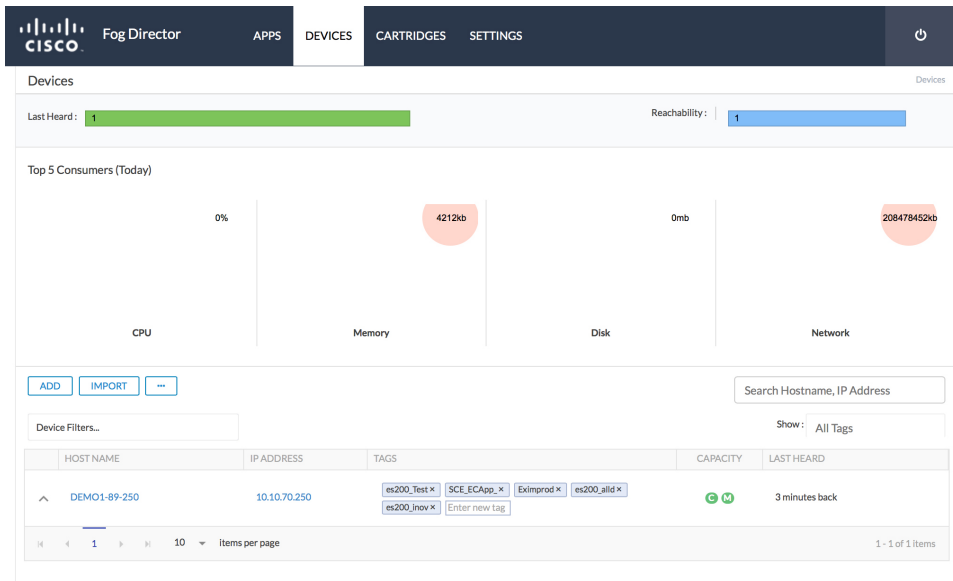

IOx Application Types

For this document's purpose, two types of IOx application are used for the two different platform architectures:

- For IR8x9 platform (x86 architecture), Docker style container application is used for validation, and
- For IR1101 platform (ARM64v8 architecture), LXC/Platform as a service (PaaS) style container application is used for validation. IR1101 is a bit different in comparison with most other IOx platforms as these are mainly x86 based. The IR1101 is based on the ARM64v8 architecture so you cannot deploy containers or IOx packages built for x86 on the platform directly.

For information on different styles of container applications, refer to the following URL:

- <https://developer.cisco.com/docs/iox/#!application-types/application-types>

Adding Docker Container ES200 Application

The Virtual RTU Docker *package.yaml* will be provided by Eximprod. Refer to the following configuration for a sample file. This file needs to be loaded on your laptop/client machine running the Cisco Fog Director client application.

Edit necessary network ports. For example, specify the Northbound ports needed by the Fog Director and device parameters (such as serial interface parameters). Port 1731 will be used by the Virtual RTU. Port 2401 is be used for Northbound communication from the Virtual RTU to Control Center communication.

```
Package.yaml file
descriptor-schema-version: "2.2"
info:
  name: es200_inovium_CC_DNP3_10
  description: "IOx Docker es200 v0.9"
  version: "1.0.9"
  author-link: "http://www.inovium.ro"
  author-name: "Inovium Digital Vision"

app:
cpuarch: "x86_64"
type: docker
resources:
  profile: c1.small
  devices:
    -
      device-id: serial
      label: HOST_DEV0
      type: serial
      usage: "Serial Adapter"

network:
  -
    interface-name: eth0
    ports:
      tcp:
        - 1731 ----- ES200 application port
        - 2401 ----- Modbus TCP
        - 20000----- DNP3 IP Port
        - 2404 ----- T104 port

# Specify runtime and startup
startup:
  rootfs: rootfs.tar
  target: ["/opt/es200/initProcess.sh"]
```

Adding a New Application

1. Click **Add New App** under the App tab in the Fog Director, as shown in [Figure 14](#):

Figure 14 Add New App

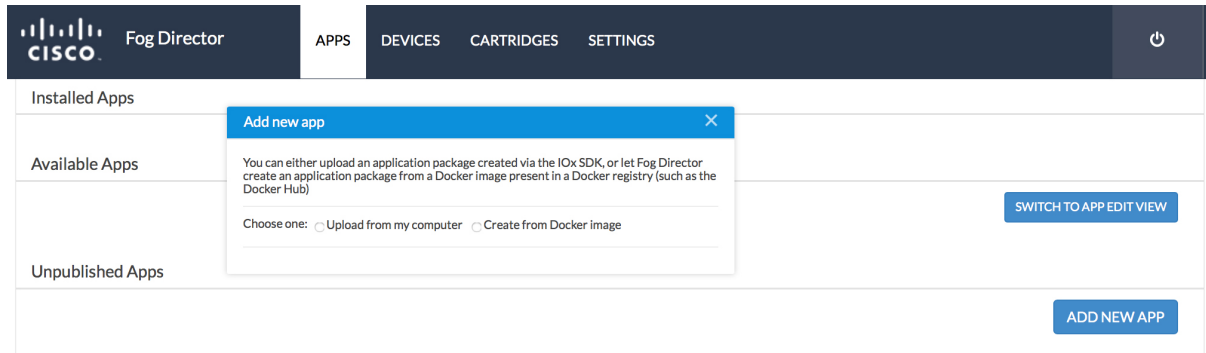

2. Click the **Create from Docker image** checkbox listed, as shown in [Figure 15](#).

Note: For applications other than Docker type, click the **Upload from my computer** checkbox from [Figure 14](#) and jump to [Publishing a Newly Added Application, page 21](#). For the purpose of this document:

- Docker style container application is used for IR809 validation
- Linux Container (LXC) style container application is used for IR1101 validation

For information on different styles of container applications, refer to the following URL:

- <https://developer.cisco.com/docs/iox/#!application-types/application-types>

Figure 15 Docker Image Option

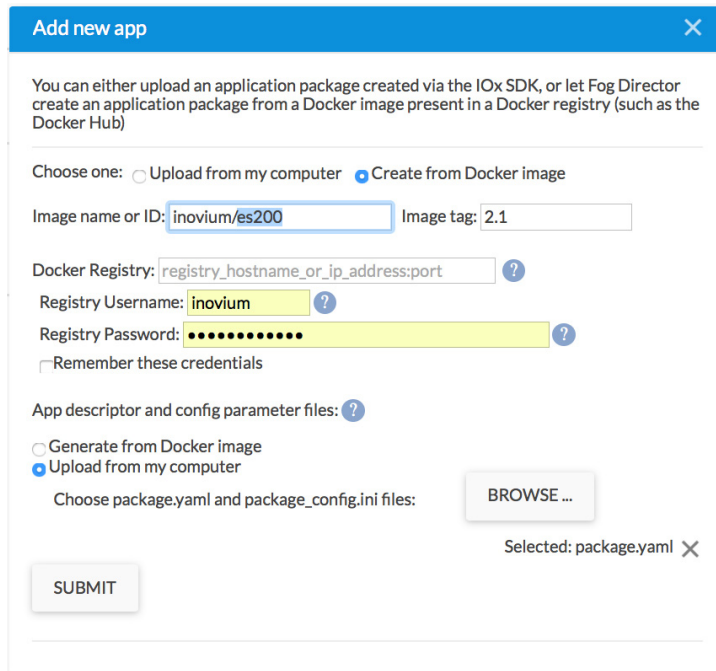

Fill in the required credentials in order to download the image from the repository and then choose the application's corresponding valid configuration file (*package. yaml*).

Click **Submit** and wait for a successful application download.

Figure 16 Docker Image Details

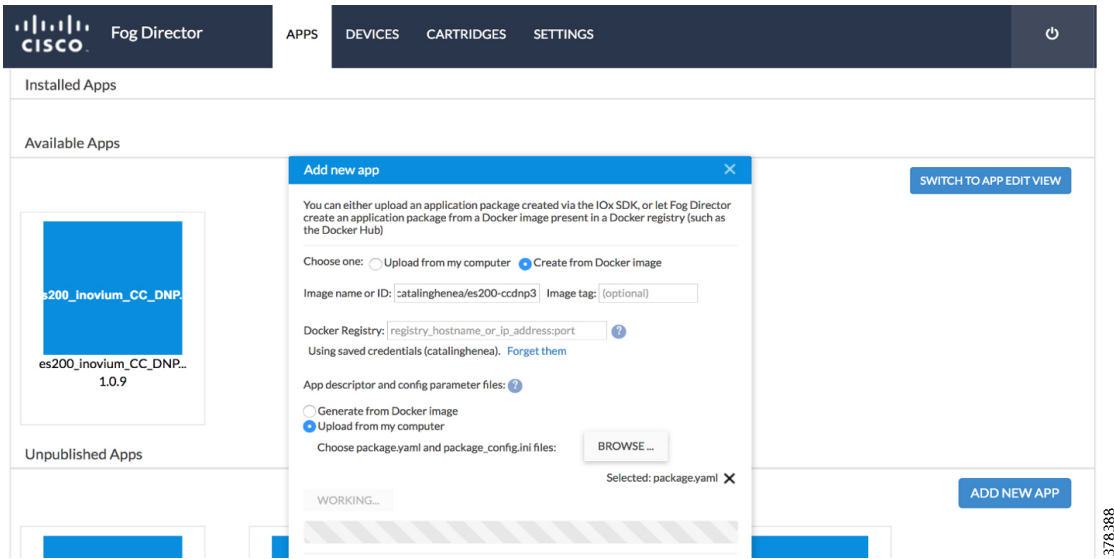

Publishing a Newly Added Application

After successful application download, the application is ready to be published, as shown in Figure 17:

Figure 17 App Publishing

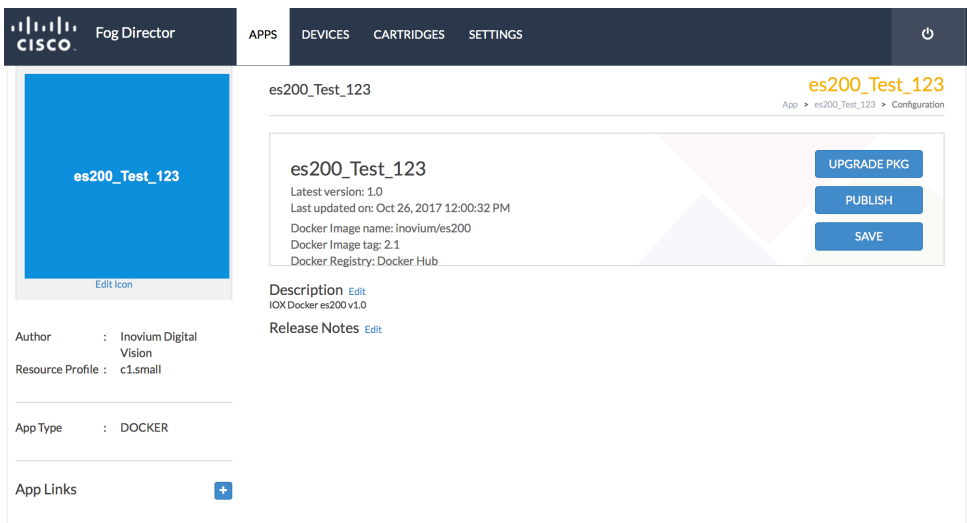

After successful publication, the application is ready for installation, as shown in [Figure 18](#):

Figure 18 App Ready to Install

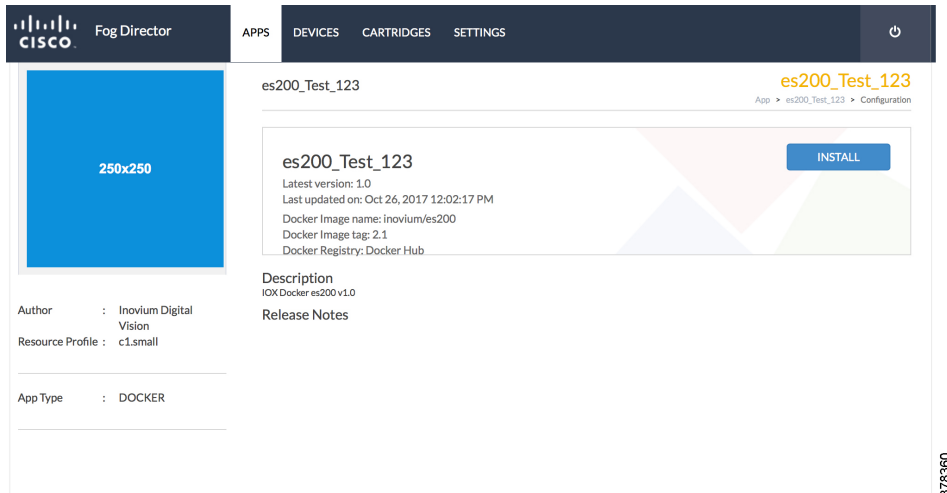

Installing a Newly Published App

The application can be installed on devices of interest. As part of the installation process, those devices are chosen and the networking parameters and interfaces of the device are configured, as shown in [Figure 19](#) and [Figure 20](#):

Figure 19 Select Device

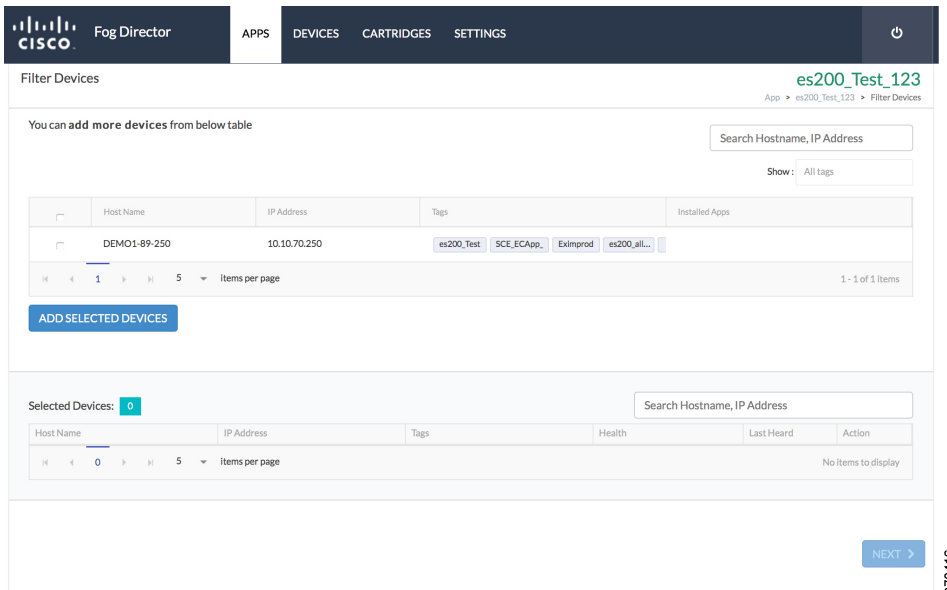
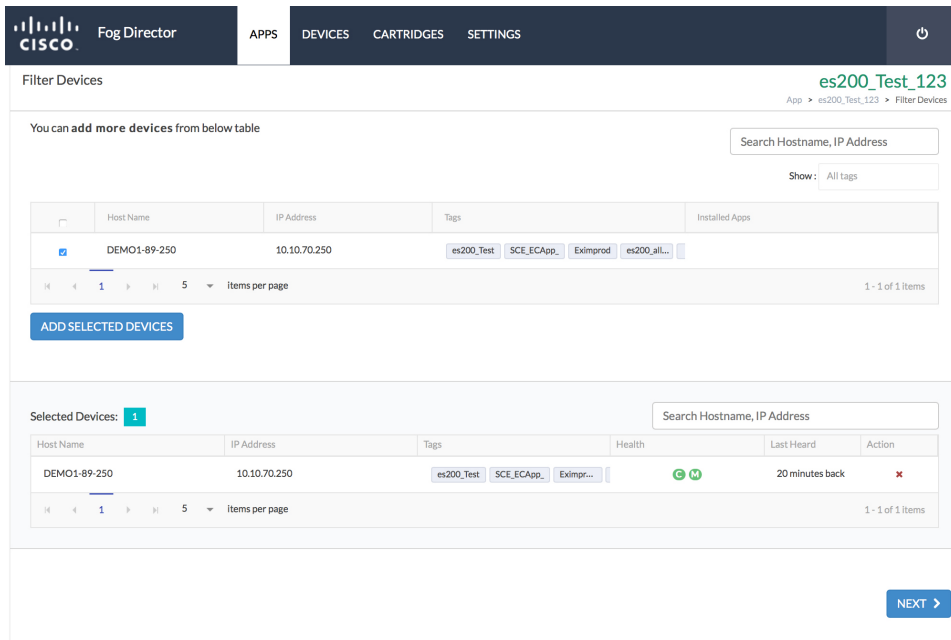

Figure 20 Add Selected Devices



376355

After clicking **Add Selected Devices**, click **Next**. Modify the **Resource Profile** if needed, as shown in [Figure 21](#):

Figure 21 Resource Profiles

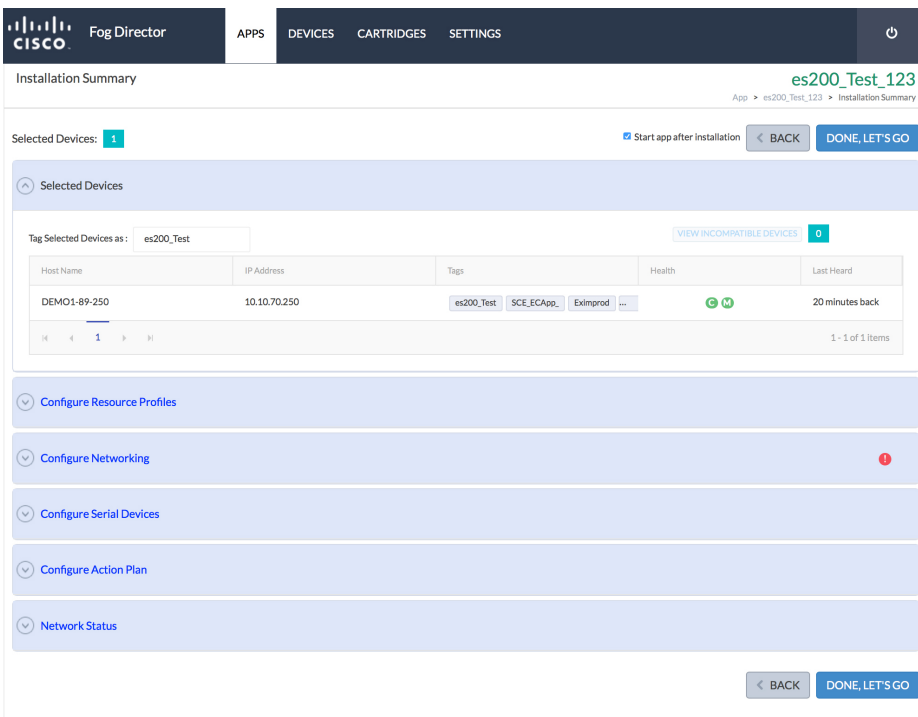

376413

Networking should be set to *nat-0*, as shown in [Figure 22](#):

Figure 22 Networking

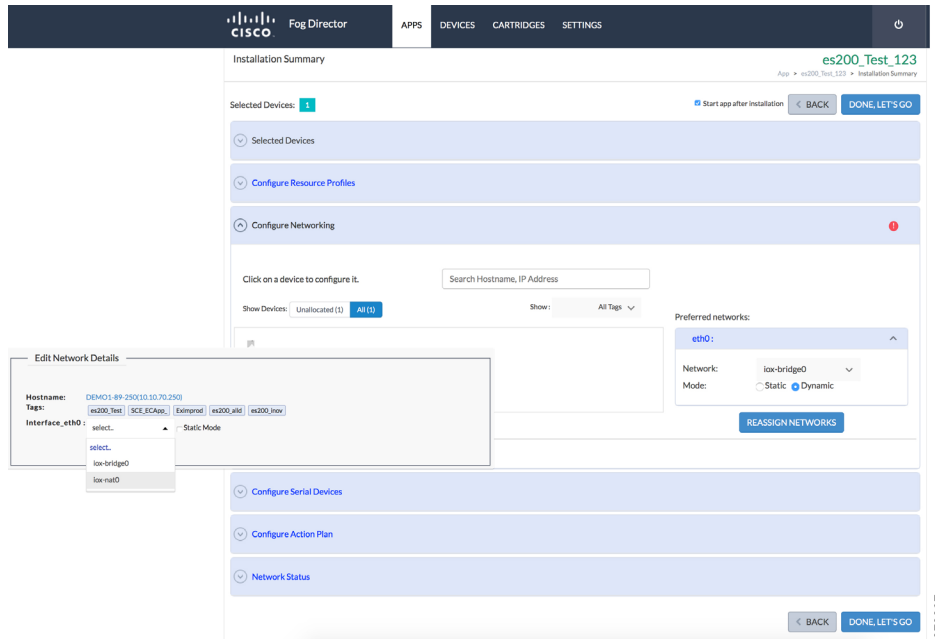

378397

By default, Serial Device would point to *async1*, but you should change it to *async0* since the Southbound IED is connected to the *async0* serial port, as shown in [Figure 23](#).

Figure 23 Serial Device Details

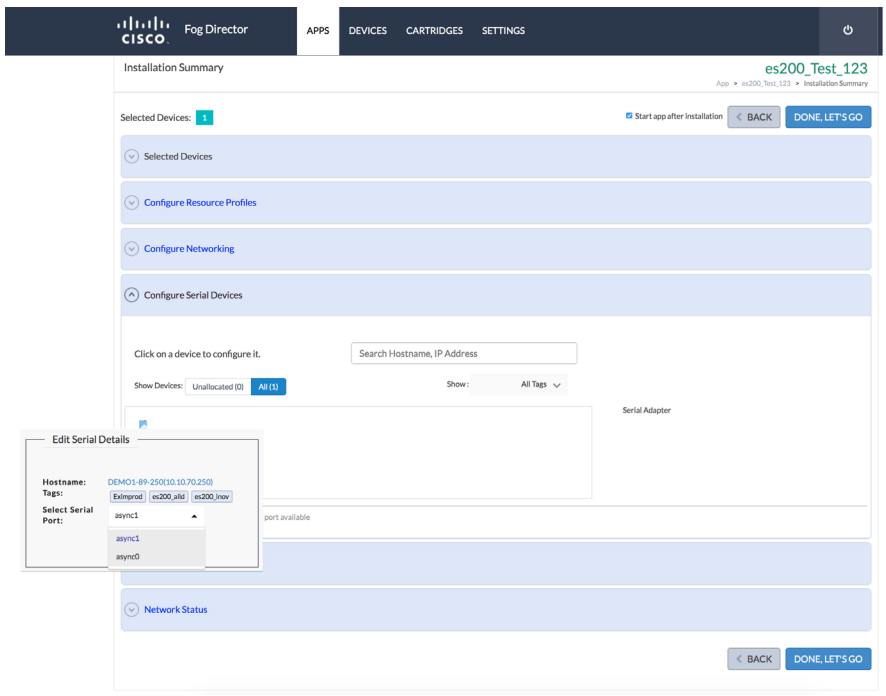

378417

A successful installation of the application will be reflected on the Cisco Fog Director portal. More details of the application will also be shown on the Cisco Fog Directory portal, as shown in [Figure 24](#):

Figure 24 App Installation Success

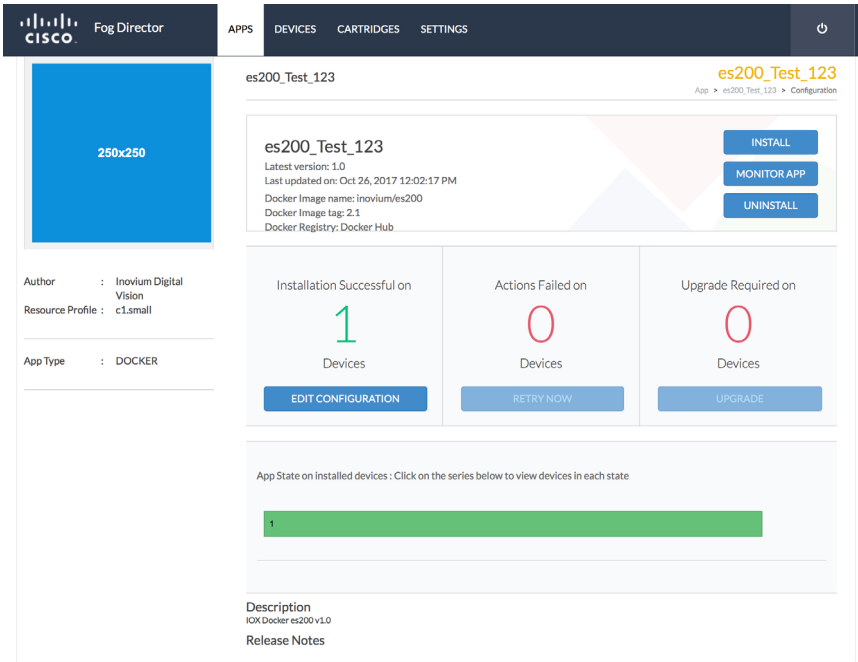

3786358

ES200 Lifecycle Management

Stopping ES200 Docker Container Application from Fog Director

Click **Devices** to see the App running status and then click the square **Stop App** button to stop the application, as shown in [Figure 25](#):

Figure 25 Stopping App

The screenshot displays the Fog Director interface for a specific device. The top navigation bar includes 'Fog Director', 'APPS', 'DEVICES', 'CARTRIDGES', and 'SETTINGS'. The main content area is titled 'Device Details - DEMO1-89-250'. It is divided into several sections:

- Host Information:** A table showing 'Last Heard: 13 seconds back', 'Version: 1.3.0.3', 'Contact Person:', and 'Installed Cartridges: Python 2.7 for IR800, Yocto 1.7.2 for IR800'.
- Troubleshooting:** A section with a 'Launch Local Manager' link, a 'Collect Debug Logs' toggle set to 'Yes', and buttons for 'VIEW DEVICE LOGS' and 'DOWNLOAD TECH SUPPORT LOGS'.
- Resource Usage:** A horizontal bar chart showing CPU, Memory, and Disk usage. CPU is at approximately 35%, Memory at 15%, and Disk at 10%. A legend indicates 'Used' (red) and 'Available' (green).
- App Name: es200_Test_123:** A section containing two sub-panels:
 - App Info:** Shows 'App Status: RUNNING', 'App Type: DOCKER', 'Installed on: 26 October 2017', 'Last Upgrade: 26 October 2017', 'Version: 1.0', and 'App Links:'.
 - App Details:** Shows 'Resource Profile: c1.small', 'App IP: 192.168.10.2 Ports', 'App mac: 52:54:99:99:00:00', 'Network Mode: NAT', 'Serial Port: async1', 'USB Port:', and 'Cartridges Used:'.
- App Downtime:** A section stating 'No downtime data available'.

378421

Restarting the ES200 Docker Container Application from the Fog Director

Click **Start App** to restart the stopped application from the Fog Director, as shown in [Figure 26](#):

Figure 26 Restarting App

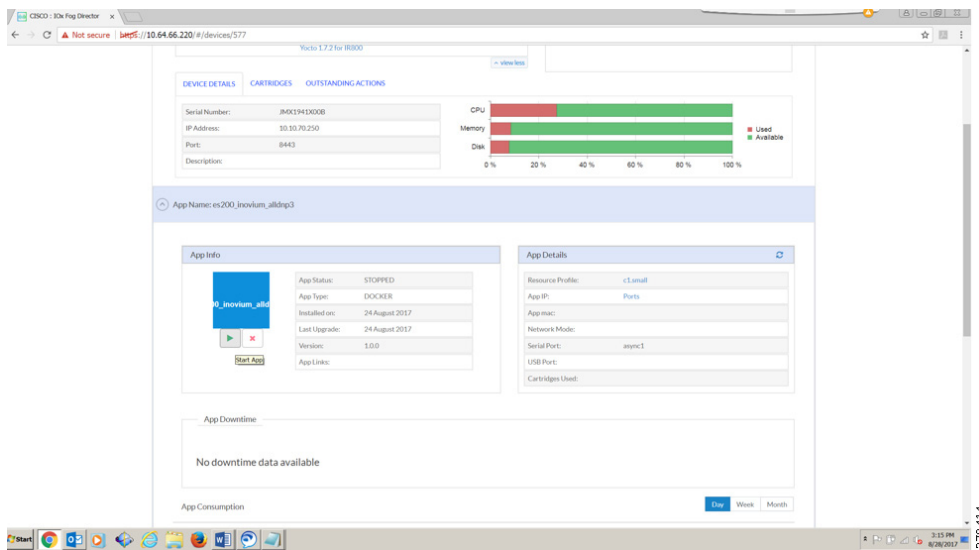

Editing Parameters from the Fog Director

Stop the App. Edit **App Settings** (Network and Serial parameters) and then click **Reconfigure Settings**, as shown in [Figure 27](#). Then, re-start the App.

Figure 27 Editing App Parameters

App Name: es200_inovium_CC_DNP3_11

App Info

App Status:	RUNNING
App Type:	DOCKER
Installed on:	21 August 2017
Last Upgrade:	21 August 2017
Version:	1.0.9
App Links:	

App Details

Resource Profile:	c1.small
App IP:	192.168.10.2 Ports
App mac:	52:54:99:99:00:00
Network Mode:	NAT
Serial Port:	async1
USB Port:	
Cartridges Used:	

App Downtime: No downtime data available

App Consumption (Day | Week | Mon)

CPU % Consumption

Memory Consumption (KB)

Disk Consumption (MB)

Network Consumption (Bytes)

WATCHDOG.LOG | EDIT CONFIGURATION | **EDIT APP SETTINGS**

Resource Profile: c1.small

Network Configuration:

Interface_eth0: iox-nat0

Serial Configuration: async0

RECONFIGURE SETTINGS

[View all App logs](#)

App Console Support

Enable Debug option: Yes No

To session into the App Console, run the following command on an SSH Client(putty, terminal). The app must be in running state. Click on the .pem link below to download the pem file.

```
ssh -p {{SSH_PORT}} -i es200_inovium_CC_DNP3_11.pem appconsole@10.10.70.250
```

378390

Uninstalling ES200 Docker Container Application from the Fog Director

Stop the App. Then click **Remove App** to remove the App, as shown in [Figure 28](#):

Figure 28 Removing App

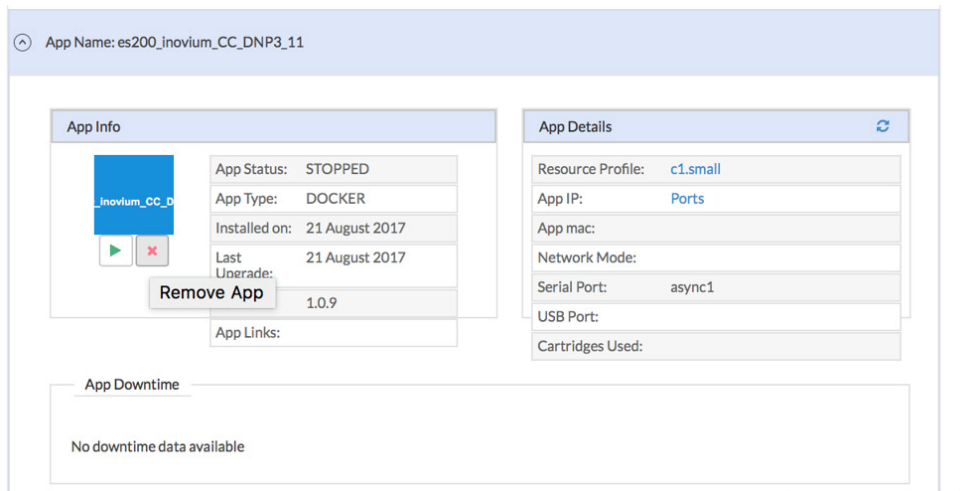

Cisco IOx Local Manager

The application management, IOx administration, and troubleshooting can also be done using the Cisco IOx Local Manager GUI when Fog Director is not available.

Cisco IOx Local Manager is a platform-specific application that is installed on a host system as part of the installation of the Cisco IOx framework on that device. It provides a web-based user interface that you can use to manage, administer, monitor, and troubleshoot apps on the host system, and to perform a variety of related activities.

For more details on IOx Local Manager, on how to configure, access the web GUI, refer to the *Cisco IOx Local Manager Reference Guide, Release 1.8* at the following URL:

- https://www.cisco.com/c/en/us/td/docs/routers/access/800/software/guides/iox/lm/reference-guide/1-8/b_iox_lm_ref_guide_1_8/b_iox_lm_ref_guide_1_8_chapter_01.html

On the IR110, the IOx Local Manager is embedded in the IR1101 Web Management. For more details on how to use Local Manager WebUI for application hosting, refer to the *IR1101 Software Configuration Guide* at the following URL:

- https://www.cisco.com/c/en/us/td/docs/routers/access/1101/software/configuration/guide/b_IR1101config/b_IR1101config_chapter_010001.html

SCADA Protocol Translation Use Case using Virtual RTU

This chapter provides details implementation details for the following SCADA protocol translation scenarios:

- [DNP3 Serial \(Southbound\) to DNP3 IP \(Northbound\) Translation Use Case, page 30](#)
- [DNP3 IP \(Southbound\) to Modbus TCP \(Northbound\) Translation Use Case, page 42](#)
- [DNP3 IP \(Southbound\) to T104 \(Northbound\) Translation Use Case, page 52](#)
- [Reading DNP3 Southbound Data from Northbound T104 Control Center, page 56](#)
- [IEC 61850-MMS \(Southbound\) to DNP3 IP \(Northbound\) Translation Use Case, page 64](#)
- [IEC 61850-MMS \(Southbound\) to T104 \(Northbound\) Translation Use Case, page 74](#)

For more details on SCADA, please refer to the *Cisco 1000 Series Connected Grid Routers SCADA Software Configuration Guide* at the following URL:

- https://www.cisco.com/c/en/us/td/docs/routers/connectedgrid/cgr1000/1_0/software/configuration/guide/scada/scada1.pdf

Virtual RTU acts as a master to Southbound IEDs and, in turn, acts as a slave to the DSO SCADA Master.

DNP3 Serial (Southbound) to DNP3 IP (Northbound) Translation Use Case

DNP3

DNP, which was specifically developed for use in electrical utility SCADA applications, is now the dominant protocol in those systems. It is also gaining popularity in other industries, including oil & gas, water, and waste water. The DNP specification defines a large number of data types. Within each type, multiple variations may be supported. These variations may describe whether the data are sent as 16-bit or 32-bit integral values; 32-bit or 64-bit floating point values; with or without timestamps; and with or without quality indicators (flags).

Reading Data (Inputs)

The DNP3 specification supports multiple methods of reading inputs individually or as a group. For example, multiple types of data can be encapsulated in a single message to improve efficiency. Time stamps and data quality information can also be included.

DNP3 also supports change events. By polling for change events, the master station can reduce overall traffic on the line, as only values that have changed are reported. This is commonly called Report by Exception (RBE). To further improve efficiency, DNP3 also supports unsolicited reporting. With unsolicited reporting, slave devices can send updates as values change, without having to wait for a poll from the Master.

The master station can easily process change event data (polled or unsolicited) because the report includes the data type and variation, point number, value, and (optionally) time stamp and quality indicators.

Control Operations (Output)

DNP3 supports control operations via output object groups (Control Relay Output Blocks or CROBs and Analog Output Blocks). DNP3 output objects are also read/write; reading the output object returns the output stats (that is, the last command that was written). The actual value of the control point can be monitored via a binary or analog input.

DNP3 also supports a variety functions commonly used on control applications, such as pulsed and paired outputs.

Implementation Details

The Cisco IR809 router is connected to an actuator or sensor in the Southbound via Ethernet and uses DNP3 as the SCADA communication protocol. Virtual RTU software does the Northbound translation to DNP3 IP since the Control Center software is running the DNP3 IP SCADA application. The Southbound DNP3 actuator is simulated using the TMW Test Harness application. The Northbound DNP3 IP SCADA software is simulated using the TMW Distributed Test Manager (DTM) application.

Southbound DNP3 TMW Configuration

Channel Configuration

The Southbound serial IED is simulated using TMW software. In this example, as shown in [Figure 29](#) and [Figure 30](#), the serial port COM62 with Baud Rate 19200 is connected to Async0 of Cisco IR809:

Figure 29 DNP3 Channel Configuration

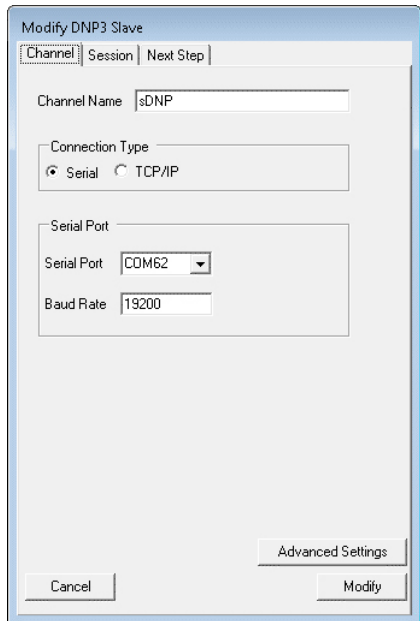

```

DEMO1-89-250#show line
  Tty Line Typ Tx/Rx A Modem Roty Acc0 AccI Uses Noise Overruns Int
    0 0 CTY - - - - - 0 0 0/0 -
* 1 1 TTY 19200/19200 - - - - - 0 0 0/0 -
* 1/5 71 TTY 19200/19200 - - - - - 0 0 0/0 -
    
```

Async0 (line 1) has the same baud rate as the serial RTU simulator and 1/5 serial relay connecting to the Guest OS /dev/ttyS1 where the Eximprod Southbound DNP3 master application is running.

Figure 30 DNP3 Advance Channel Configuration

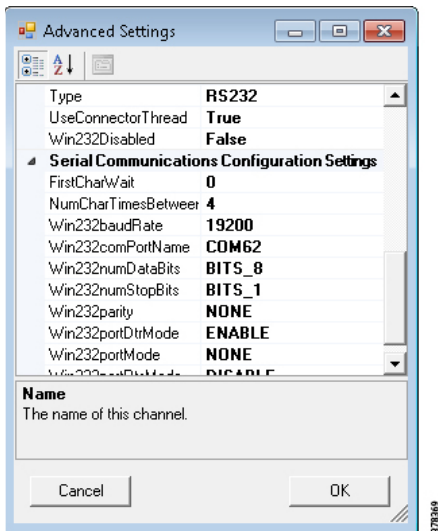

Make sure Parity is set to **None**, Port is configured in **DTR mode**, StopBits is **1**, and DataBits is **8**.

Session-related Configuration

The DNP3 Southbound serial RTU simulator is configured as slave and the source and destination layers are configured as 1 and 1. The DNP3 Master will be running on ES200. Link layer addresses needs to be communicated to the Eximprod team accordingly; they will configure the Virtual RTU database. See [Figure 31](#):

Figure 31 DNP3 Session Configuration

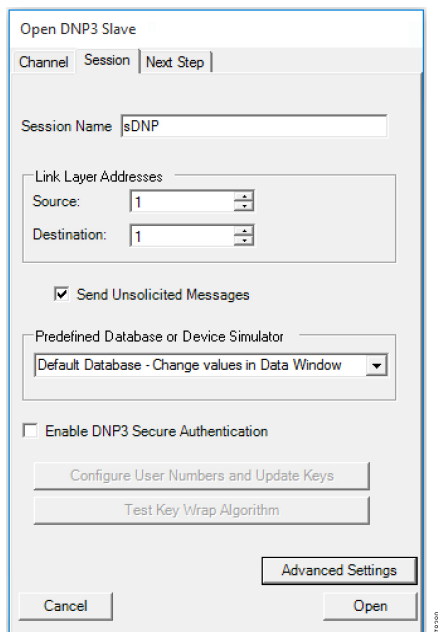

Northbound DNP3 IP TMW Configuration

DNP3 IP Channel Configuration

The TMW DTM software is configured in the DNP3 IP. Master mode is used to simulate Control Center SCADA software. Port 2401 is used to communicate between the DNP3 master and slave running in ES200. This port needs to be opened in IOx NAT mode, which will be defined in the *package.yaml* file. See [Figure 32](#):

Figure 32 DNP3 IP Channel Configuration

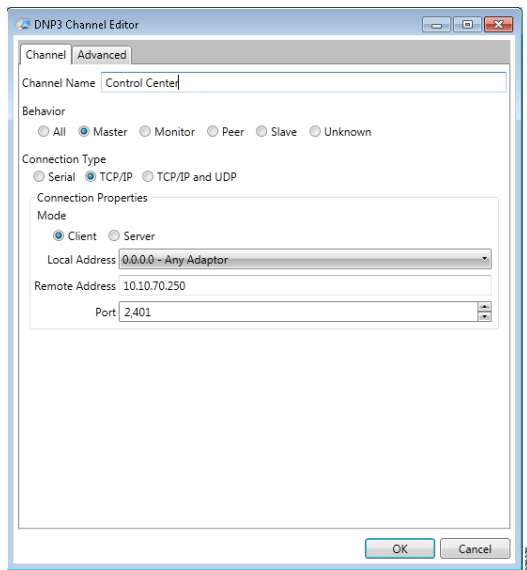

DNP3 IP Session-related Configuration

Configure the DNP3 IP Link layer address based on Virtual RTU ES200 database settings. See [Figure 33](#):

Figure 33 DNP3 IP Session Configuration

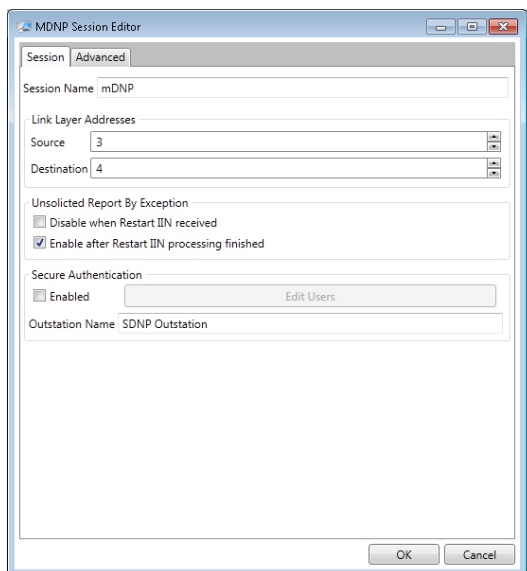

DNP3 IP Advanced Settings

AutoTimeSyncIIN and AutoEnabledUnsol are advanced DNP3 IP settings, which need to be enabled; AutoIntegrityOline and AutoIntegrityRestart settings need to be disabled. Please refer to [Figure 34](#) for details:

Figure 34 DNP3 Advance IP Session Configuration

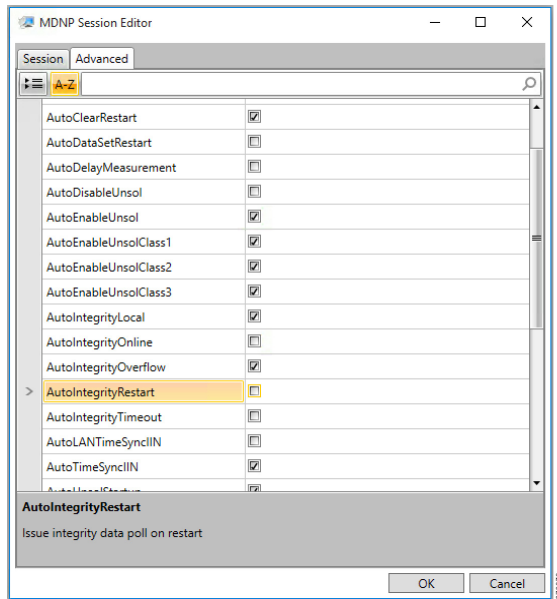

Integrity Poll Use Case

The DNP3 specification supports multiple methods of reading inputs individually or as a group. An integrity poll returns data from Class 0 (known as static data), along with data from Classes 1, 2, and 3 (which will be event data). This may or may not be everything, depending on how the slave is configured.

The integrity poll retrieves all events (Class 1, 2, and 3) and static (Class 0) data from the device. It is typically sent after device restart, loss of communication, or on a periodic basis to ensure all data is accurate. This integrity poll is executed in our case from the Northbound DTM application depicted in [Figure 35](#) and [Figure 36](#).

Figure 35 Integrity Data Poll

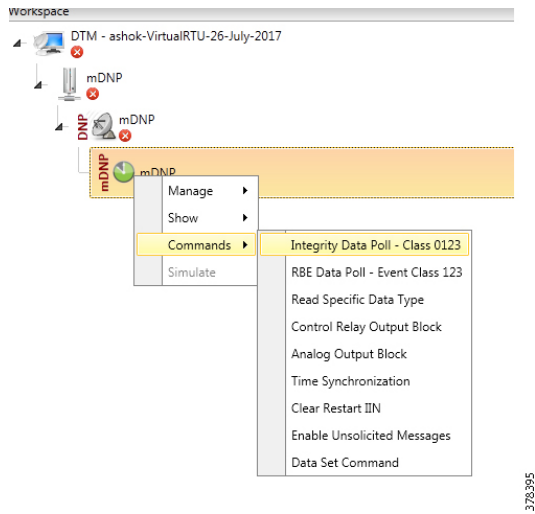
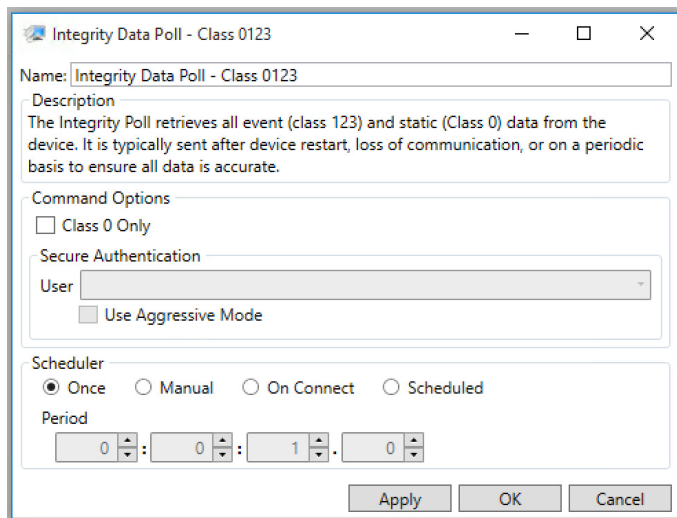

Figure 36 Integrity Data Poll Class0123



Click **Apply** and then click **OK** to initiate a poll.

Poll results for the Northbound DTM application are shown in [Figure 37](#). Click the **Show Point List** option under the DNP3 IP Session.

Figure 37 DNP3 IP Point List

Point Type	#	Name	Value	Quality	Timestamp	Description	Enabled	Host	Device	Channel	Session
[1] Binary Inputs	0		On	Online	9/1/2017 12:37:17 PM		True	DTHost	mDNP	Control Cen	mDNP
[1] Binary Inputs	1		Off	Online	9/1/2017 12:37:17 PM		True	DTHost	mDNP	Control Cen	mDNP
[1] Binary Inputs	2		Off	Online	9/1/2017 12:37:17 PM		True	DTHost	mDNP	Control Cen	mDNP
[1] Binary Inputs	3		Off	Online	9/1/2017 12:37:17 PM		True	DTHost	mDNP	Control Cen	mDNP
[1] Binary Inputs	4		Off	Online	9/1/2017 12:37:17 PM		True	DTHost	mDNP	Control Cen	mDNP
[10] Binary Output Statures:	0		On	Offline	9/1/2017 12:06:49 PM		True	DTHost	mDNP	Control Cen	mDNP
[10] Binary Output Statures:	1		On	Offline	9/1/2017 12:06:49 PM		True	DTHost	mDNP	Control Cen	mDNP
[10] Binary Output Statures:	2		On	Offline	9/1/2017 12:06:49 PM		True	DTHost	mDNP	Control Cen	mDNP
[10] Binary Output Statures:	3		On	Offline	9/1/2017 12:06:49 PM		True	DTHost	mDNP	Control Cen	mDNP
[10] Binary Output Statures:	4		On	Offline	9/1/2017 12:06:49 PM		True	DTHost	mDNP	Control Cen	mDNP
[30] Analog Inputs	0		111	Online	9/1/2017 12:11:40 PM		True	DTHost	mDNP	Control Cen	mDNP
[30] Analog Inputs	1		112	Online	9/1/2017 12:11:40 PM		True	DTHost	mDNP	Control Cen	mDNP
[30] Analog Inputs	2		105	Online	9/1/2017 12:11:40 PM		True	DTHost	mDNP	Control Cen	mDNP
[30] Analog Inputs	3		106	Online	9/1/2017 12:11:40 PM		True	DTHost	mDNP	Control Cen	mDNP
[30] Analog Inputs	4		107	Online	9/1/2017 12:11:40 PM		True	DTHost	mDNP	Control Cen	mDNP

In the poll results on the Northbound simulator that are shown above, we received four register values (0, 1, 2, and 3) of binary inputs. In the Southbound IED simulator, these are mapped to register values (6, 7, 8, and 9).

Virtual RTU does the mapping of these registers, which matches the Southbound TMW application register values. Therefore, we conclude that the integrity poll is successful. See [Figure 38](#):

Figure 38 DNP3 IP Input Registers

Channel	Session	Sector	Type	Number	Value	Flags
sDNP	sDNP	N/A	[3] Double Inputs	0	off	Online
sDNP	sDNP	N/A	[3] Double Inputs	1	off	Online
sDNP	sDNP	N/A	[3] Double Inputs	2	off	Online
sDNP	sDNP	N/A	[3] Double Inputs	3	off	Online
sDNP	sDNP	N/A	[3] Double Inputs	4	off	Online
sDNP	sDNP	N/A	[3] Double Inputs	5	off	Online
sDNP	sDNP	N/A	[3] Double Inputs	6	on	Online
sDNP	sDNP	N/A	[3] Double Inputs	7	off	Online
sDNP	sDNP	N/A	[3] Double Inputs	8	off	Online
sDNP	sDNP	N/A	[3] Double Inputs	9	off	Online
sDNP	sDNP	N/A	[3] Double Inputs	10	off	Online
sDNP	sDNP	N/A	[3] Double Inputs	11	off	Online
sDNP	sDNP	N/A	[3] Double Inputs	12	off	Online
sDNP	sDNP	N/A	[3] Double Inputs	13	off	Online
sDNP	sDNP	N/A	[3] Double Inputs	14	off	Online
sDNP	sDNP	N/A	[3] Double Inputs	15	off	Online
sDNP	sDNP	N/A	[3] Double Inputs	16	off	Online
sDNP	sDNP	N/A	[3] Double Inputs	17	off	Online

For the purposes of this document, we just discussed Binary Input register values for the Integrity poll.

Unsolicited Reporting

DNP3 supports unsolicited reporting, which means slave devices can send updates as values change without having to wait for a poll from the master.

In our earlier Integrity polling case, we observed that Southbound Input Register # 7 is off. Southbound Register #1 is mapped as Register #7 in the Northbound. If we change the state of the Southbound register, the Northbound register state will change automatically.

After checking the state check of Input Register #1 value @ Northbound DTM application; in this case, it is **OFF**. See Figure 39:

Figure 39 DNP3 IP Input Registers Current Value

Point Type	#	Name	Value	Quality	Timestamp	Description	Enabled	Host	Device	Channel	Session
[1] Binary Inputs	0		On	Online	9/1/2017 12:37:17 PM		True	DTHost	mDNP	Control Cen	mDNP
[1] Binary Inputs	1		Off	Online	9/1/2017 12:37:17 PM		True	DTHost	mDNP	Control Cen	mDNP
[1] Binary Inputs	2		Off	Online	9/1/2017 12:37:17 PM		True	DTHost	mDNP	Control Cen	mDNP
[1] Binary Inputs	3		Off	Online	9/1/2017 12:37:17 PM		True	DTHost	mDNP	Control Cen	mDNP
[1] Binary Inputs	4		Off	Online	9/1/2017 12:37:17 PM		True	DTHost	mDNP	Control Cen	mDNP
[10] Binary Output Statuses:	0		On	Offline	9/1/2017 12:06:49 PM		True	DTHost	mDNP	Control Cen	mDNP
[10] Binary Output Statuses:	1		On	Offline	9/1/2017 12:06:49 PM		True	DTHost	mDNP	Control Cen	mDNP
[10] Binary Output Statuses:	2		On	Offline	9/1/2017 12:06:49 PM		True	DTHost	mDNP	Control Cen	mDNP
[10] Binary Output Statuses:	3		On	Offline	9/1/2017 12:06:49 PM		True	DTHost	mDNP	Control Cen	mDNP
[10] Binary Output Statuses:	4		On	Offline	9/1/2017 12:06:49 PM		True	DTHost	mDNP	Control Cen	mDNP
[30] Analog Inputs	0		111	Online	9/1/2017 12:11:40 PM		True	DTHost	mDNP	Control Cen	mDNP
[30] Analog Inputs	1		112	Online	9/1/2017 12:11:40 PM		True	DTHost	mDNP	Control Cen	mDNP
[30] Analog Inputs	2		105	Online	9/1/2017 12:11:40 PM		True	DTHost	mDNP	Control Cen	mDNP
[30] Analog Inputs	3		106	Online	9/1/2017 12:11:40 PM		True	DTHost	mDNP	Control Cen	mDNP
[30] Analog Inputs	4		107	Online	9/1/2017 12:11:40 PM		True	DTHost	mDNP	Control Cen	mDNP

378373

Now change the register # 7 value to **ON** (right click and toggle) on the Southbound application, as shown in Figure 40:

Figure 40 DNP3 Southbound Binary Input Register Toggle

Channel	Session	Sector	Type	Number	Value	Flags
sDNP	sDNP	N/A	[3] Double Inputs	0	off	Online
sDNP	sDNP	N/A	[3] Double Inputs	1	off	Online
sDNP	sDNP	N/A	[3] Double Inputs	2	off	Online
sDNP	sDNP	N/A	[3] Double Inputs	3	off	Online
sDNP	sDNP	N/A	[3] Double Inputs	4	off	Online
sDNP	sDNP	N/A	[3] Double Inputs	5	off	Online
sDNP	sDNP	N/A	[3] Double Inputs	6	on	Online
sDNP	sDNP	N/A	[3] Double Inputs	7	off	Online
sDNP	sDNP	N/A	[3] Double Inputs	8	off	Online
sDNP	sDNP	N/A	[3] Double Inputs	9	off	Online
sDNP	sDNP	N/A	[3] Double Inputs	10	off	Online
sDNP	sDNP	N/A	[3] Double Inputs	11	off	Online
sDNP	sDNP	N/A	[3] Double Inputs	12	off	Online
sDNP	sDNP	N/A	[3] Double Inputs	13	off	Online
sDNP	sDNP	N/A	[3] Double Inputs	14	off	Online
sDNP	sDNP	N/A	[3] Double Inputs	15	off	Online
sDNP	sDNP	N/A	[3] Double Inputs	16	off	Online
sDNP	sDNP	N/A	[3] Double Inputs	17	off	Online
sDNP	sDNP	N/A	[3] Double Inputs	18	off	Online
sDNP	sDNP	N/A	[3] Double Inputs	19	off	Online
sDNP	sDNP	N/A	[3] Double Inputs	20	off	Online
sDNP	sDNP	N/A	[3] Double Inputs	21	off	Online
sDNP	sDNP	N/A	[3] Double Inputs	22	off	Online
sDNP	sDNP	N/A	[3] Double Inputs	23	off	Online
sDNP	sDNP	N/A	[3] Double Inputs	24	off	Online
sDNP	sDNP	N/A	[3] Double Inputs	25	off	Online
sDNP	sDNP	N/A	[3] Double Inputs	26	off	Online
sDNP	sDNP	N/A	[3] Double Inputs	27	off	Online
sDNP	sDNP	N/A	[3] Double Inputs	28	off	Online
sDNP	sDNP	N/A	[3] Double Inputs	29	off	Online
sDNP	sDNP	N/A	[3] Double Inputs	30	off	Online
sDNP	sDNP	N/A	[3] Double Inputs	31	off	Online

378381

Unsolicited reporting is observed on the Northbound application for Input register value #1. The current value is **ON**, as shown in Figure 41:

Figure 41 DNP3 Northbound Binary Inputs Register Changed Value

Point Type	#	Name	Value	Quality	Timestamp	Description	Enabled	Host	Device	Channel	Session	Sector
[1] Binary Inputs	0		On	Online	9/1/2017 1:02:56 PM		True	DTHost	mDNP	Control Cen	mDNP	
[1] Binary Inputs	1		On	Online	9/1/2017 1:02:56 PM		True	DTHost	mDNP	Control Cen	mDNP	
[1] Binary Inputs	2		Off	Online	9/1/2017 1:02:56 PM		True	DTHost	mDNP	Control Cen	mDNP	
[1] Binary Inputs	3		Off	Online	9/1/2017 1:02:56 PM		True	DTHost	mDNP	Control Cen	mDNP	
[1] Binary Inputs	4		Online	Online	9/1/2017 1:02:56 PM		True	DTHost	mDNP	Control Cen	mDNP	
[10] Binary Output Statuses	0		On	Offline	9/1/2017 12:06:49 PM		True	DTHost	mDNP	Control Cen	mDNP	
[10] Binary Output Statuses	1		On	Offline	9/1/2017 12:06:49 PM		True	DTHost	mDNP	Control Cen	mDNP	
[10] Binary Output Statuses	2		On	Offline	9/1/2017 12:06:49 PM		True	DTHost	mDNP	Control Cen	mDNP	
[10] Binary Output Statuses	3		On	Offline	9/1/2017 12:06:49 PM		True	DTHost	mDNP	Control Cen	mDNP	
[10] Binary Output Statuses	4		On	Offline	9/1/2017 12:06:49 PM		True	DTHost	mDNP	Control Cen	mDNP	
[30] Analog Inputs	0		111	Online	9/1/2017 12:37:19 PM		True	DTHost	mDNP	Control Cen	mDNP	
[30] Analog Inputs	1		112	Online	9/1/2017 12:37:19 PM		True	DTHost	mDNP	Control Cen	mDNP	
[30] Analog Inputs	2		105	Online	9/1/2017 12:37:19 PM		True	DTHost	mDNP	Control Cen	mDNP	
[30] Analog Inputs	3		106	Online	9/1/2017 12:37:19 PM		True	DTHost	mDNP	Control Cen	mDNP	
[30] Analog Inputs	4		107	Online	9/1/2017 12:37:19 PM		True	DTHost	mDNP	Control Cen	mDNP	

378379

Control Command

In DNP3, binary output statuses registers will be used for control write operations. We will try to issue a CROB command from the Northbound DTM application to Register value #1, which will then write on Register # 7 in our case. Register Value #1 on the Northbound application is mapped to Register Value #7 in the Southbound application. If we make changes on Register value #1 on the Northbound application, which is depicted in Figure 42, we will see changes reflected in the Southbound application Register value #7.

The status check on the Southbound TMW application binary output statuses Register #7 before issuing a control command from the Northbound. We can see the binary output register #7 status is **OFF** in Figure 42:

Figure 42 DNP3 Southbound Binary Output Statuses Register #7

Channel	Session	Sector	Type	Number	Value	Fl
sDNP	sDNP	N/A	[10] Binary Output Statuses	0	Off	O
sDNP	sDNP	N/A	[10] Binary Output Statuses	1	Off	O
sDNP	sDNP	N/A	[10] Binary Output Statuses	2	Off	O
sDNP	sDNP	N/A	[10] Binary Output Statuses	3	Off	O
sDNP	sDNP	N/A	[10] Binary Output Statuses	4	Off	O
sDNP	sDNP	N/A	[10] Binary Output Statuses	5	Off	O
sDNP	sDNP	N/A	[10] Binary Output Statuses	6	Off	O
sDNP	sDNP	N/A	[10] Binary Output Statuses	7	Off	O
sDNP	sDNP	N/A	[10] Binary Output Statuses	8	Off	O
sDNP	sDNP	N/A	[10] Binary Output Statuses	9	Off	O
sDNP	sDNP	N/A	[10] Binary Output Statuses	10	Off	O
sDNP	sDNP	N/A	[10] Binary Output Statuses	11	Off	O
sDNP	sDNP	N/A	[10] Binary Output Statuses	12	Off	O
sDNP	sDNP	N/A	[10] Binary Output Statuses	13	Off	O
sDNP	sDNP	N/A	[10] Binary Output Statuses	14	Off	O
sDNP	sDNP	N/A	[10] Binary Output Statuses	15	Off	O
sDNP	sDNP	N/A	[10] Binary Output Statuses	16	Off	O
sDNP	sDNP	N/A	[10] Binary Output Statuses	17	Off	O
sDNP	sDNP	N/A	[10] Binary Output Statuses	18	Off	O
sDNP	sDNP	N/A	[10] Binary Output Statuses	19	Off	O
sDNP	sDNP	N/A	[10] Binary Output Statuses	20	Off	O
sDNP	sDNP	N/A	[10] Binary Output Statuses	21	Off	O
sDNP	sDNP	N/A	[10] Binary Output Statuses	22	Off	O
sDNP	sDNP	N/A	[10] Binary Output Statuses	23	Off	O
sDNP	sDNP	N/A	[10] Binary Output Statuses	24	Off	O
sDNP	sDNP	N/A	[10] Binary Output Statuses	25	Off	O
sDNP	sDNP	N/A	[10] Binary Output Statuses	26	Off	O
sDNP	sDNP	N/A	[10] Binary Output Statuses	27	Off	O
sDNP	sDNP	N/A	[10] Binary Output Statuses	28	Off	O
sDNP	sDNP	N/A	[10] Binary Output Statuses	29	Off	O
sDNP	sDNP	N/A	[10] Binary Output Statuses	30	Off	O
sDNP	sDNP	N/A	[10] Binary Output Statuses	31	Off	O

378382

Now we will issue a command from the Northbound simulator to change the state of the register to **ON**.

Figure 43 DNP3 IP Northbound Control Command

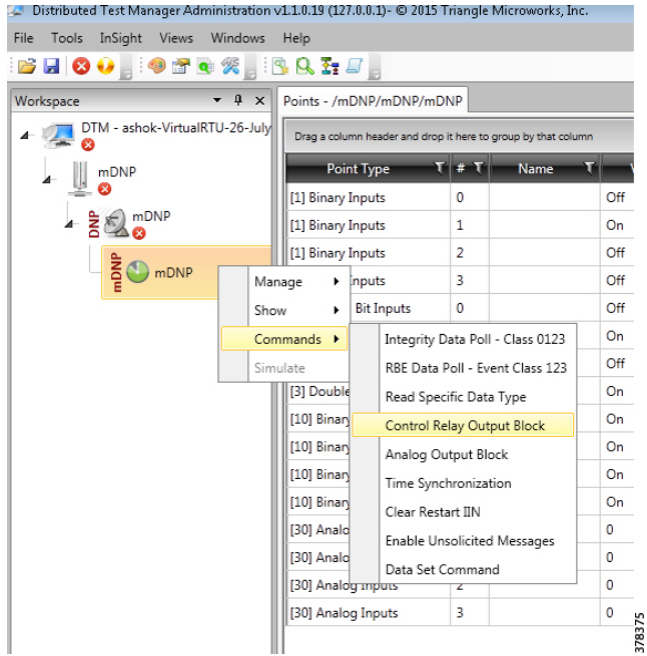
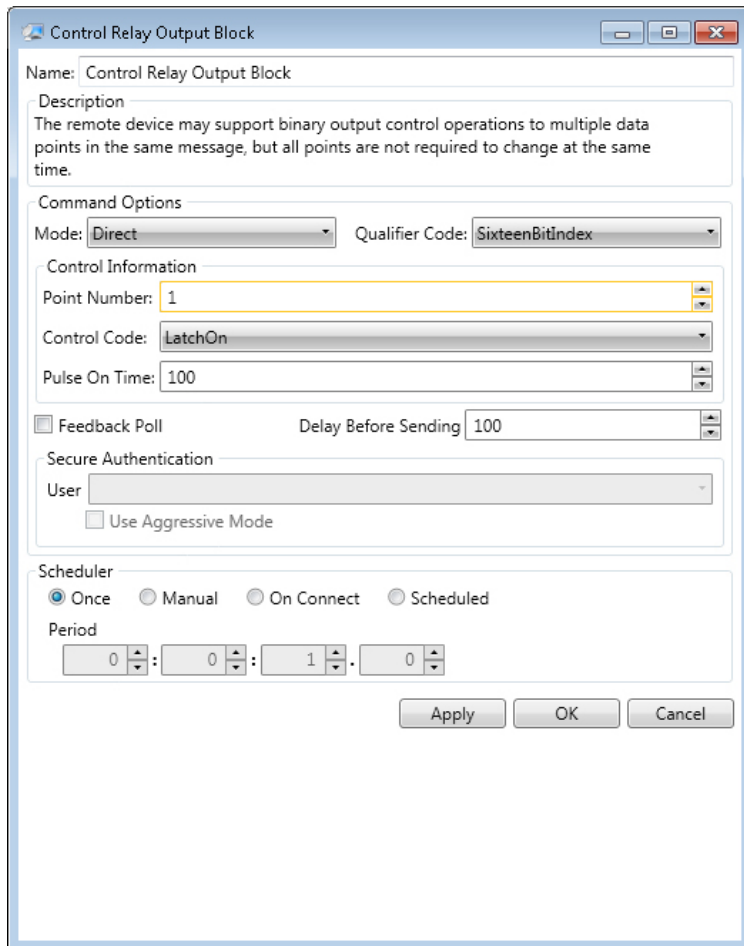

Figure 44 DNP3 IP Northbound CROB Control Command



Command LatchOn is executed on Point Number 1 in [Figure 44](#) above. Mode is direct. Control Code is **LatchOn**. Click **Apply** and then click **OK** to execute the command from the Northbound DTM application.

Binary Output Statuses Register # 7 value on the Southbound TMW application are changed from **OFF** to **ON**; this is depicted in [Figure 45](#):

Figure 45 DNP3 Southbound Register Value Changed to ON

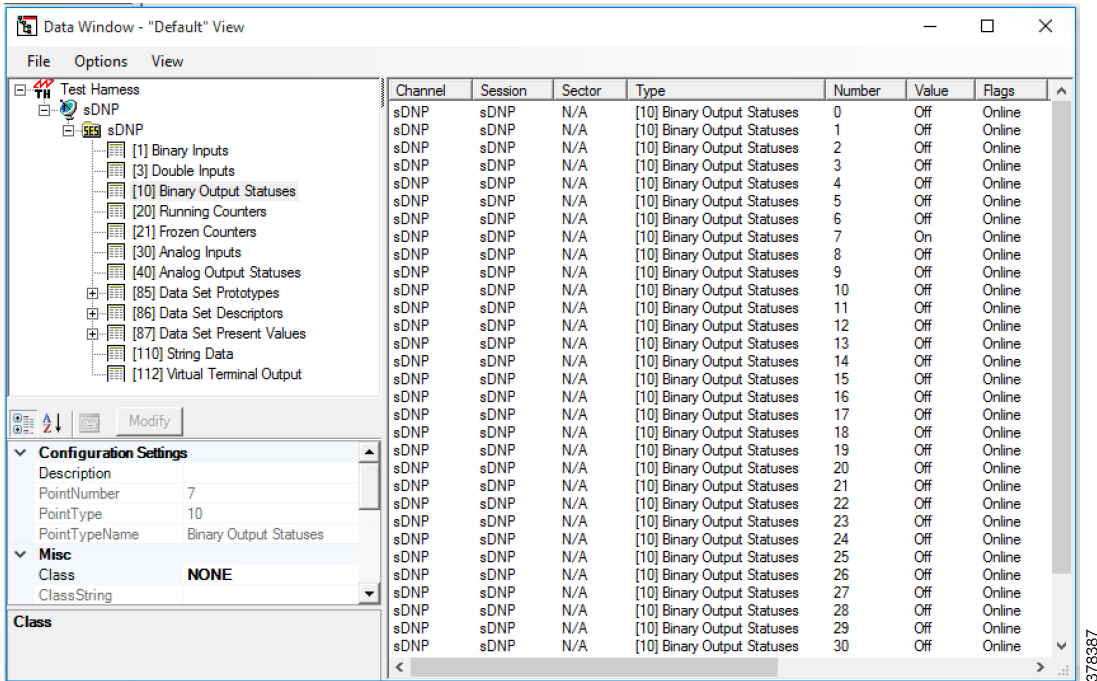

378387

DNP3 IP (Southbound) to Modbus TCP (Northbound) Translation Use Case

The Cisco IR809 router is connected to an actuator or sensor in the Southbound via Ethernet and DNP3 IP is the SCADA communication protocol. Virtual RTU software does the Northbound translation to Modbus IP since the Control Center software is running the Modbus IP SCADA application.

- The Southbound DNP3 IP actuator is simulated using the TMW Test Harness application.
- The Northbound Modbus IP SCADA software is simulated using the TMW DTM application.

Southbound DNP3 IP TMW Configuration

Channel Configuration

The Southbound Ethernet IED is simulated using the TMW Test Harness software. In this example, Port 20000 is used for communication between the Southbound IED and the Virtual RTU ES200. See [Figure 46](#):

Figure 46 DNP3 Southbound DNP3 IP Configuration 1

Modify DNP3 Slave

Channel | Session | Next Step

Channel Name: sDNP

Connection Type: Serial TCP/IP

TCP/IP Parameters

Host:

Port: 20000

Local IP: 0.0.0.0

Advanced Settings

Cancel Modify

378383

Session Configuration

The DNP3 Southbound Ethernet simulator is configured as the slave and source and destination layers are configured as **1** and **1**. The DNP3 Master will be running on ES200. The Link Layer addresses needs to be communicated to the Eximprod team and the Virtual RTU database will be configured accordingly. See [Figure 47](#):

Figure 47 DNP3 Southbound DNP3 IP Configuration 2

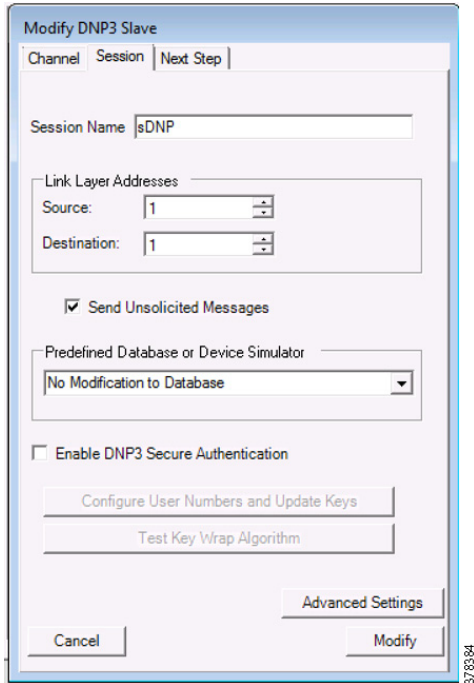

Northbound Modbus TCP TMW Configuration

Channel Configuration

The Northbound Ethernet SCADA Control Center is simulated using DTM software. In this example, Port 2401 is used for communication between the Northbound Control Center and Virtual RTU ES200. See [Figure 48](#):

Figure 48 Northbound Modbus TCP Configuration

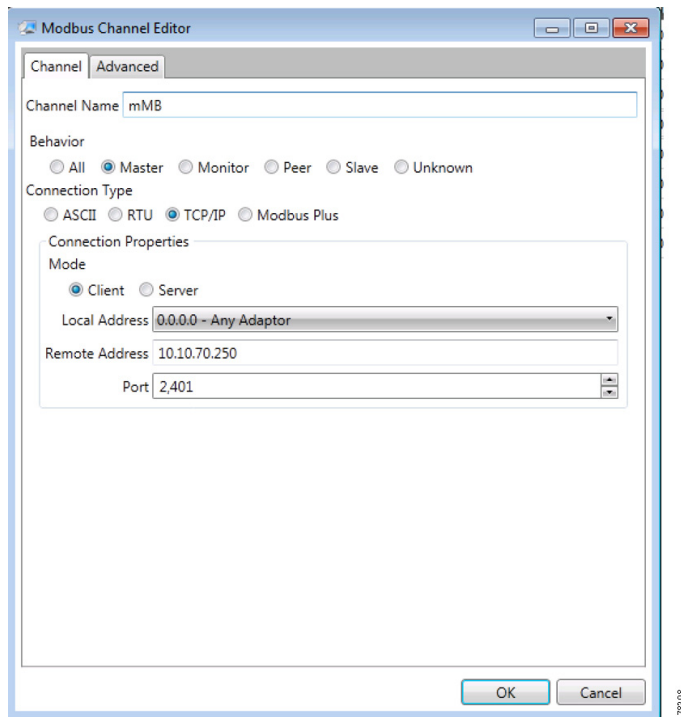

Virtual RTU ES200

Use the following command to ensure that the corresponding applications are running:

```

DEMO1-89-250-GOS-1:~# ps -aux | grep es200
root      1188  0.1  0.5 35348 5472 ?        Ss   Sep27   1:01 /opt/es200/Watchdog -d
root      1232  1.1  0.6 38416 5956 ?        Ss   Sep27  10:53 /opt/es200/ModbusSlave -c 3 -s
/opt/es200/db/racdb.db -L0 -d -11
root      1253  0.0  0.6 40916 6060 ?        Ss   Sep27   0:00 /opt/es200/ESRemote -s
/opt/es200/db/racdb.db -L2 -d -11
root      1262  0.8  0.5 34712 5324 ?        Ss   Sep27   8:37 /opt/es200/MultiDataMaster -s
/opt/es200/db/racdb.db -L2 -d -11 -i
root      1305  1.3  0.6 36876 6260 ?        Ss   Sep27  13:31 /opt/es200/ModbusMaster -c 1 -s
/opt/es200/db/racdb.db -L0 -d -11 -i
root      2924  0.5  0.6 36520 5956 ?        Ss   Sep27   5:45 /opt/es200/DNP3Master -c 2 -s
/opt/es200/db/racdb.db -L0 -d -11 -i
root      25540 0.0  0.0  4428   844 pts/0    S+   05:12   0:00 grep es200
DEMO1-89-250-GOS-1:~#

```

Modbus TCP (Control Center) to DNP3 IP (IED) Register Mapping

ES200 Virtual RTU software maps and translates different registers in the DNP3 IP-aware Southbound device to the Modbus TCP protocol-aware Northbound Control Center. The sample register mappings in use by the current version of ES200 application evaluated in the Connected Utilities Solutions lab are shown in [Figure 49](#):

Figure 49 Northbound Modbus TCP Configuration

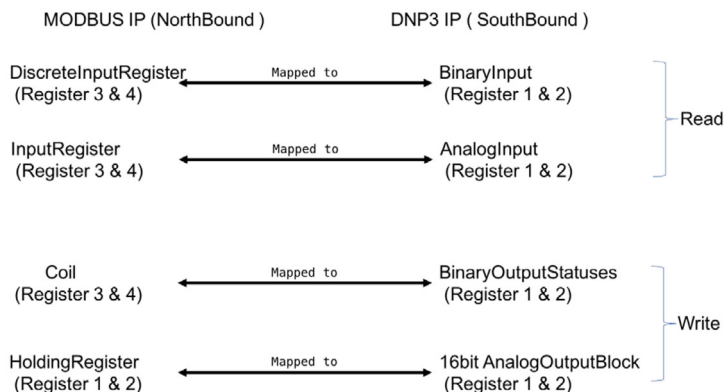

31784100

Reading DNP3 Southbound Data from Northbound Modbus Control Center

As the register mapping depicts the InputRegister in the Northbound, the Modbus Control Center is mapped to the AnalogInput Registers in the DNP3 Southbound device. The InputRegister in the Control Center should read the corresponding AnalogInputRegister values set in the DNP3 Southbound device. See [Figure 50](#) and [Figure 51](#):

Northbound Control Center InputRegister 3 and 4

Figure 50 Reading Input Registers

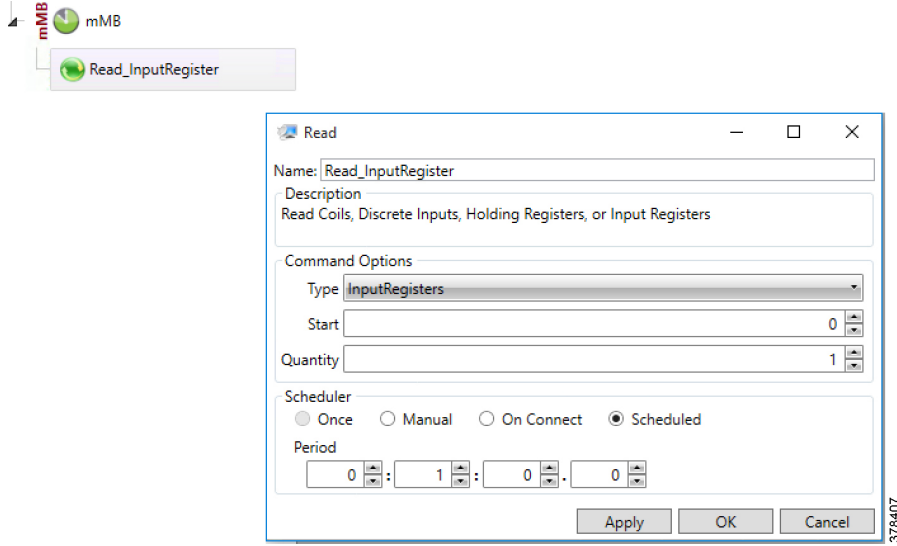

Figure 51 Southbound InputRegisters

Channel	Session	Sector	Type	Number	Value	Flags	Time Updated	Descrip
sDNP	sDNP	N/A	[30] Analog Inputs	0	0	Online	27Sep17 12:46:03.590 (invalid)	
sDNP	sDNP	N/A	[30] Analog Inputs	1	10	Online	27Sep17 12:47:54.054 (invalid)	
sDNP	sDNP	N/A	[30] Analog Inputs	2	20	Online	27Sep17 15:17:39.060 (invalid)	
sDNP	sDNP	N/A	[30] Analog Inputs	3	0	Online	27Sep17 12:46:03.590 (invalid)	
sDNP	sDNP	N/A	[30] Analog Inputs	4	0	Online	27Sep17 12:46:03.590 (invalid)	
sDNP	sDNP	N/A	[30] Analog Inputs	5	0	Online	27Sep17 12:46:03.590 (invalid)	
sDNP	sDNP	N/A	[30] Analog Inputs	6	0	Online	27Sep17 12:46:03.590 (invalid)	
sDNP	sDNP	N/A	[30] Analog Inputs	7	0	Online	27Sep17 12:46:03.590 (invalid)	
sDNP	sDNP	N/A	[30] Analog Inputs	8	0	Online	27Sep17 12:46:03.590 (invalid)	
sDNP	sDNP	N/A	[30] Analog Inputs	9	0	Online	27Sep17 12:46:03.590 (invalid)	

The Southbound DNP3 IP IED AnalogInput 1 and 2 register values are translated to Modbus TCP. We could observe that register values are matching in the Northbound Control Center application.

Unsolicited Reporting

The DNP3 protocol supports unsolicited reporting. Slave devices send updates as values change, without having to wait for a poll from the master.

In [Figure 52](#) and [Figure 53](#), we are changing the BinaryInput Register 1 and 2 in the Southbound application and checking that the state of DiscreteInputRegister 3 and 4 values at Northbound DTM application are dynamically updated.

Figure 52 Present Value at Southbound

Channel	Session	Sector	Type	Number	Value	Flags	Time Updated
sDNP	sDNP	N/A	[1] Binary Inputs	0	Off	Online	27Sep17 12:46:03.543
sDNP	sDNP	N/A	[1] Binary Inputs	1	Off	Online	27Sep17 15:16:03.697
sDNP	sDNP	N/A	[1] Binary Inputs	2	On	Online	27Sep17 15:16:38.579
sDNP	sDNP	N/A	[1] Binary Inputs	3	Off	Online	27Sep17 12:46:03.559
sDNP	sDNP	N/A	[1] Binary Inputs	4	Off	Online	27Sep17 12:46:03.559
sDNP	sDNP	N/A	[1] Binary Inputs	5	Off	Online	27Sep17 12:46:03.559
sDNP	sDNP	N/A	[1] Binary Inputs	6	Off	Online	27Sep17 12:46:03.559
sDNP	sDNP	N/A	[1] Binary Inputs	7	Off	Online	27Sep17 12:46:03.559

Figure 53 Present Value at Northbound

Point Type	#	Name	Value	Quality	Timestamp
[1] Discrete Input Registers	3		Off	N/A	9/28/2017 10:58:58 AM
[1] Discrete Input Registers	4		On	N/A	9/28/2017 10:58:58 AM
[3] Input Registers	3		10	N/A	9/28/2017 10:58:58 AM
[3] Input Registers	4		20	N/A	9/28/2017 10:58:58 AM

Changing Southbound Values

Choose BinaryInputRegister 1, right-click, and then toggle the value to **ON**, as shown in [Figure 54](#). The earlier value was set to **OFF**.

Figure 54 Change Value at Southbound

Channel	Session	Sector	Type	Number	Value	Flags	Time Updated	Descriptio
sDNP	sDNP	N/A	[1] Binary Inputs	0	Off	Online	27Sep17 12:46:03.543 (invalid)	
sDNP	sDNP	N/A	[1] Binary Inputs	1	On	Online	28Sep17 06:07:08.273 (invalid)	
sDNP	sDNP	N/A	[1] Binary Inputs	2	On	Online	27Sep17 15:16:38.579 (invalid)	

Dynamically Updated Northbound Values

See [Figure 55](#):

Figure 55 Register Value Changes at Northbound

Point Type	#	Name	Value	Quality	Timestamp	Desc
[1] Discrete Input Registers	3		On	N/A	9/28/2017 11:12:28 AM	
[1] Discrete Input Registers	4		On	N/A	9/28/2017 11:12:28 AM	
[3] Input Registers	3		10	N/A	9/28/2017 11:12:28 AM	
[3] Input Registers	4		20	N/A	9/28/2017 11:12:28 AM	

Control Command

A status check on the Southbound TMW application Binary Output Statuses Register 1 and 2 before issuing control command from the Northbound shows that the values are set to **OFF**.

Binary Output Register 1 and 2 status is **OFF**, as shown in [Figure 56](#):

Figure 56 Register Value Changes Status at Southbound

Channel	Session	Sector	Type	Number	Value	Flags	Time Updated
sDNP	sDNP	N/A	[10] Binary Output Statuses	0	Off	Online	27Sep17 12:46:03.574
sDNP	sDNP	N/A	[10] Binary Output Statuses	1	Off	Online	27Sep17 15:18:29.636
sDNP	sDNP	N/A	[10] Binary Output Statuses	2	Off	Online	27Sep17 12:46:03.574
sDNP	sDNP	N/A	[10] Binary Output Statuses	3	Off	Online	27Sep17 12:46:03.574
sDNP	sDNP	N/A	[10] Binary Output Statuses	4	Off	Online	27Sep17 12:46:03.574
sDNP	sDNP	N/A	[10] Binary Output Statuses	5	Off	Online	27Sep17 12:46:03.574
sDNP	sDNP	N/A	[10] Binary Output Statuses	6	Off	Online	27Sep17 12:46:03.574

In the example shown in [Figure 57](#), we tried to toggle the Southbound DNP3 values from the Northbound Control Center using Modbus. As per the register mapping, we toggled Coil Register 3 and checked the corresponding register value in the Southbound device. Present Coil Register 3 value is **OFF**.

Figure 57 Present Coil Register 3 Value

[3] Input Registers	4		20	N/A	9/28/2017 11:44:53 AM	
[0] Coils	3		Off	N/A	9/28/2017 11:44:52 AM	
[0] Coils	4		Off	N/A	9/28/2017 11:44:52 AM	
[4] Holding Registers	1		55	N/A	9/28/2017 11:44:51 AM	

Changing Coil Register 3 value to **ON**, as shown in Figure 58. The Modbus TCP Command is issued on the Control Center.

Figure 58 Command to Toggle Coil Register 3 Value

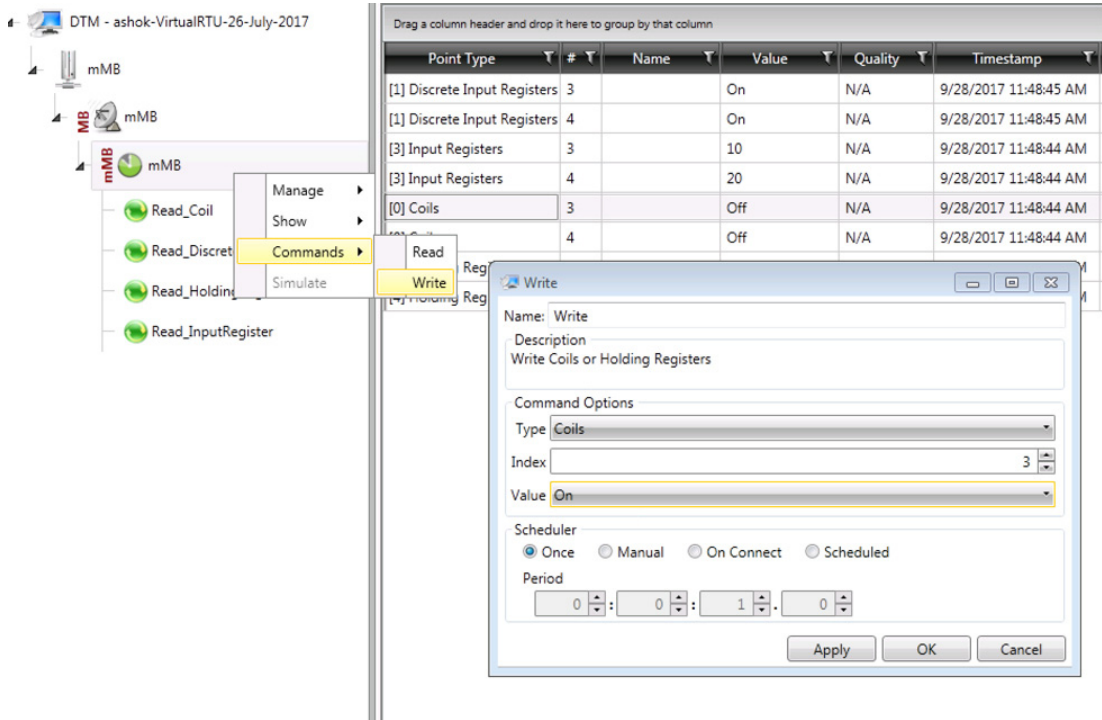

Check Southbound BinaryOutputStatuses Register 1 value. As stated earlier, the Southbound has a different SCADA Protocol DNP3 IP and different register Binary Output Statuses Register 1. See Figure 59:

Figure 59 Command to Toggle Coil Register 1 Value

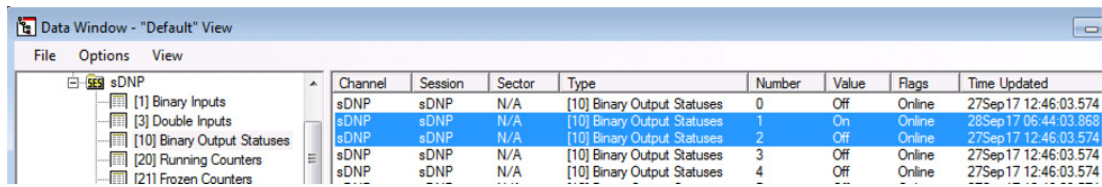

Since DNP3 supports unsolicited reporting, the Modbus command center also reflects updated data for the Coils Register 3. See Figure 60:

Figure 60 Unsolicited Reporting at Control Center

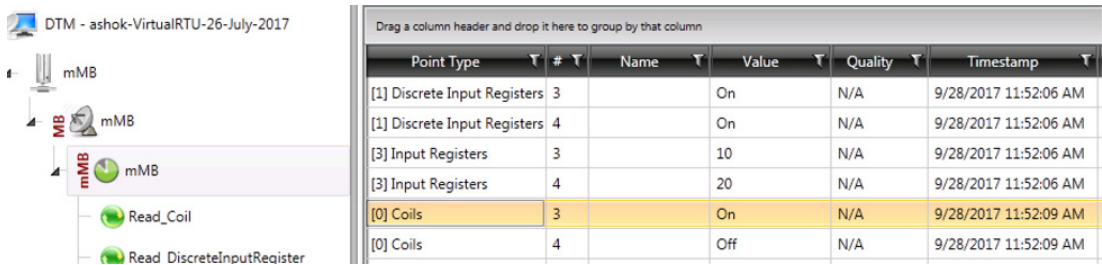

Present Analog Output Block Register 2 Value at Southbound

On a similar exercise to the previous one, you can try changing the DNP3 Southbound 16 bit Analog Output Block Register 1 and 2 statuses by changing the Modbus Northbound Holding Register 1 and 2. See [Figure 61](#):

Figure 61 Analog Output Register Present Value

Channel	Session	Sector	Type	Number	Value	Flags	Time Updated
sDNP	sDNP	N/A	[40] Analog Output Statuses	0	0	Online	27Sep17 12:46:03.606
sDNP	sDNP	N/A	[40] Analog Output Statuses	1	55	Online	27Sep17 15:20:58.507
sDNP	sDNP	N/A	[40] Analog Output Statuses	2	0	Online	27Sep17 12:46:03.606
sDNP	sDNP	N/A	[40] Analog Output Statuses	3	0	Online	27Sep17 12:46:03.606
sDNP	sDNP	N/A	[40] Analog Output Statuses	4	0	Online	27Sep17 12:46:03.606
sDNP	sDNP	N/A	[40] Analog Output Statuses	5	0	Online	27Sep17 12:46:03.606
sDNP	sDNP	N/A	[40] Analog Output Statuses	6	0	Online	27Sep17 12:46:03.606
sDNP	sDNP	N/A	[40] Analog Output Statuses	7	0	Online	27Sep17 12:46:03.606

Present HoldingRegister 2 Value at Northbound

See [Figure 62](#):

Figure 62 Holding Register Present Value

Point Type	#	Name	Value	Quality	Timestamp
[1] Discrete Input Registers	3		On	N/A	9/28/2017 12:04:09 PM
[1] Discrete Input Registers	4		On	N/A	9/28/2017 12:04:09 PM
[3] Input Registers	3		10	N/A	9/28/2017 12:04:09 PM
[3] Input Registers	4		20	N/A	9/28/2017 12:04:09 PM
[0] Coils	3		On	N/A	9/28/2017 12:04:08 PM
[0] Coils	4		Off	N/A	9/28/2017 12:04:08 PM
[4] Holding Registers	1		55	N/A	9/28/2017 12:04:07 PM
[4] Holding Registers	2		0	N/A	9/28/2017 12:04:07 PM

Changing Holding Register 2 Value

See [Figure 63](#):

Figure 63 Command to Change Holding Register Value

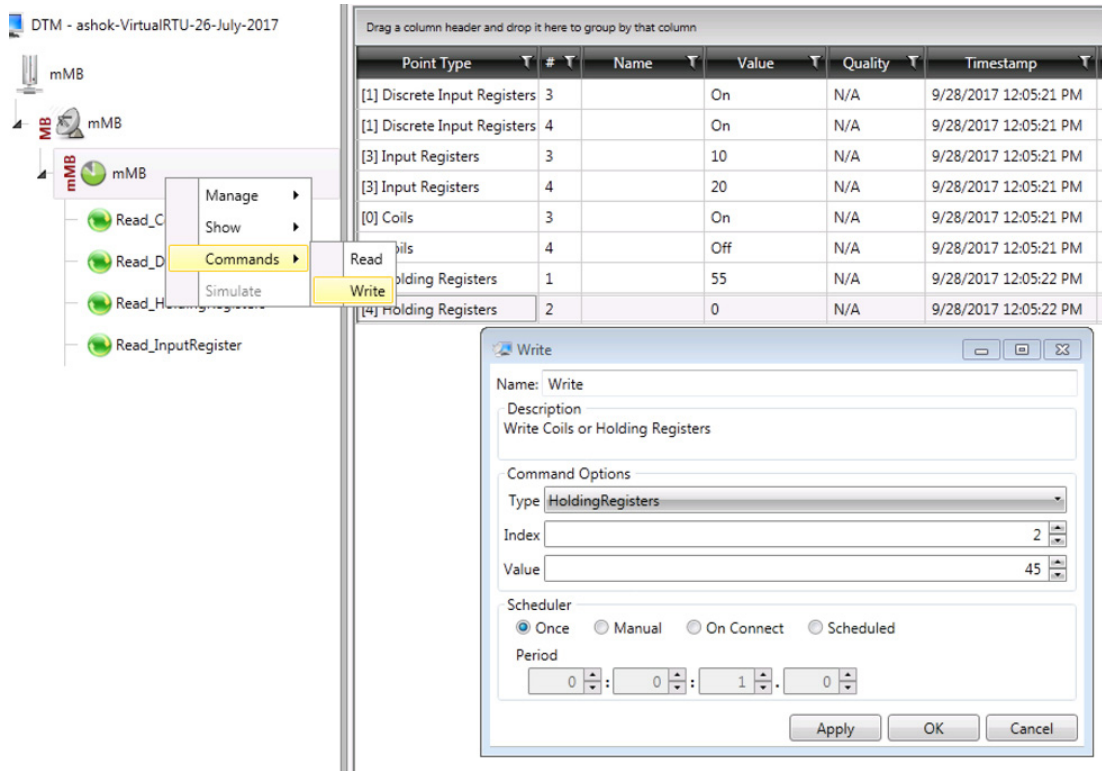

Changes reflected in the Southbound Binary Output Statuses Register 2 are shown in [Figure 64](#):

Figure 64 Changes Reflected at Southbound Output Register

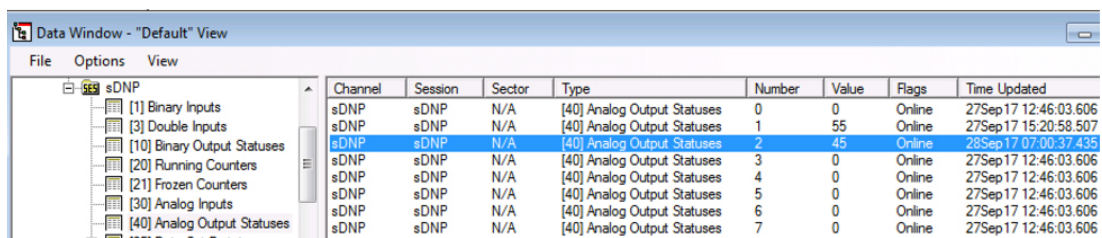

Unsolicited reporting in the Modbus Control Center is shown in [Figure 65](#):

Figure 65 Unsolicited Reporting at Modbus Control Center

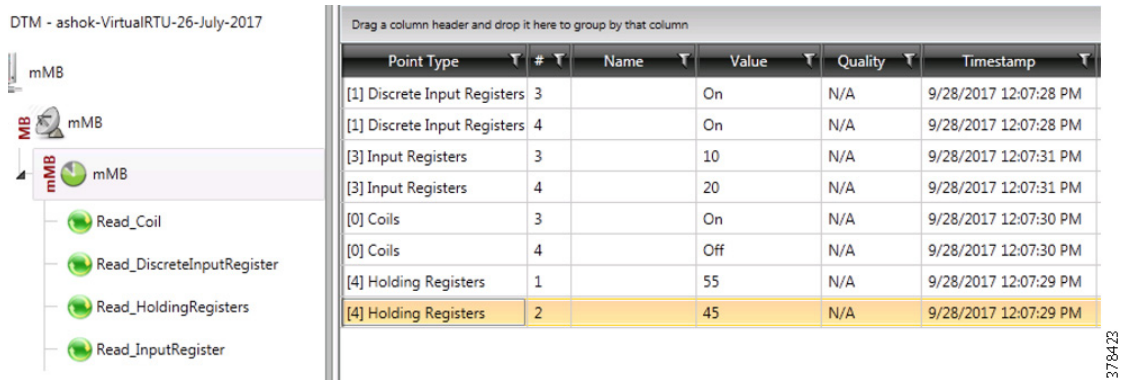

DNP3 IP (Southbound) to T104 (Northbound) Translation Use Case

The Cisco IR809 router is connected to the actuator or sensor in the Southbound via Ethernet and DNP3 IP is the SCADA communication protocol. Virtual RTU software does the Northbound translation to T104 since the Control Center software is running T104 SCADA application.

- Southbound DNP3 IP Actuator is simulated using TMW Test Harness application.
- Northbound T104 SCADA Software is simulated using TMW DTM Application.

Southbound DNP3 IP TMW Configuration

Channel Configuration

Southbound Ethernet IED is simulated using the TMW Test Harness software. In this example, Port 20000 is used for communication between the Southbound IED and Virtual RTU ES200.

Session Configuration

The DNP3 Southbound Ethernet simulator is configured as slave and the source and destination layer is configured as 1 and 1, as shown in [Figure 66](#). The DNP3 Master will be running on ES200. Link layer addresses needs to be communicated to the Eximprod Team and the Virtual RTU database will be configured accordingly.

Figure 66 DNP3 Southbound DNP3 IP Configuration

The screenshot shows the 'Modify DNP3 Slave' dialog box with the 'Channel' tab selected. The 'Channel Name' is 'sDNP'. Under 'Connection Type', 'TCP/IP' is selected. The 'TCP/IP Parameters' section includes a 'Host' field with four asterisks, a 'Port' field set to 20000, and a 'Local IP' dropdown menu set to 0.0.0.0. At the bottom, there are 'Cancel', 'Advanced Settings', and 'Modify' buttons. A vertical ID '378385' is on the right side.

Figure 67 DNP3 Southbound DNP3 Session Configuration

The screenshot shows the 'Modify DNP3 Slave' dialog box with the 'Session' tab selected. The 'Session Name' is 'sDNP'. Under 'Link Layer Addresses', both 'Source' and 'Destination' are set to 1. The 'Send Unsolicited Messages' checkbox is checked. The 'Predefined Database or Device Simulator' dropdown is set to 'No Modification to Database'. The 'Enable DNP3 Secure Authentication' checkbox is unchecked. Below it are 'Configure User Numbers and Update Keys' and 'Test Key Wrap Algorithm' buttons. At the bottom, there are 'Cancel', 'Advanced Settings', and 'Modify' buttons. A vertical ID '378386' is on the right side.

Northbound T104 TMW Configuration

Channel Configuration

The Northbound Ethernet SCADA Control Center is simulated using DTM software. In this example, Port 2404 is used for communication between the Northbound Control Center and the Virtual RTU ES200. See [Figure 68](#):

Figure 68 Northbound T104 Configuration

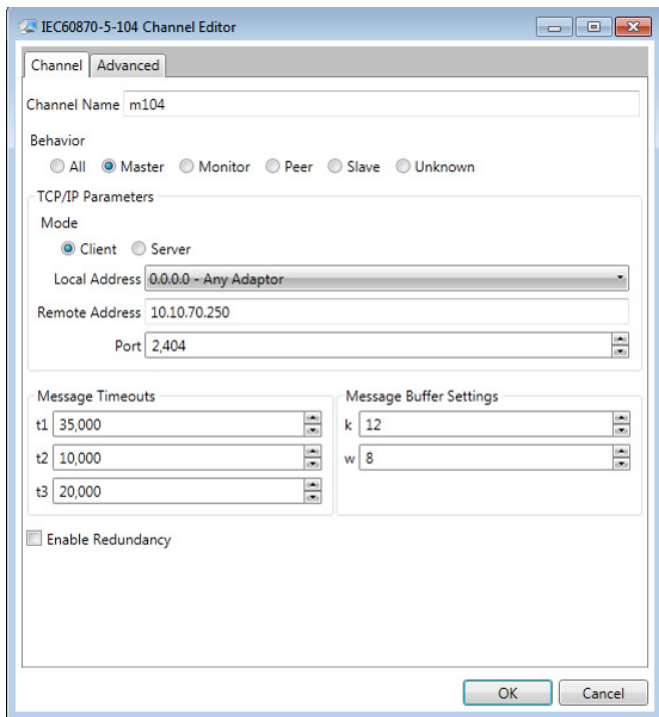

T104 (Control Center) to DNP3 IP (IED) Register Mapping

The ES200 Virtual RTU software maps and translates different registers in the DNP3 IP-aware Southbound device to the T104 protocol-aware Northbound Control Center. The sample register mappings in use by the current version of the ES200 application evaluated in Connected Utilities Solutions lab are shown in [Figure 69](#):

Figure 69 Northbound Modbus TCP Configuration

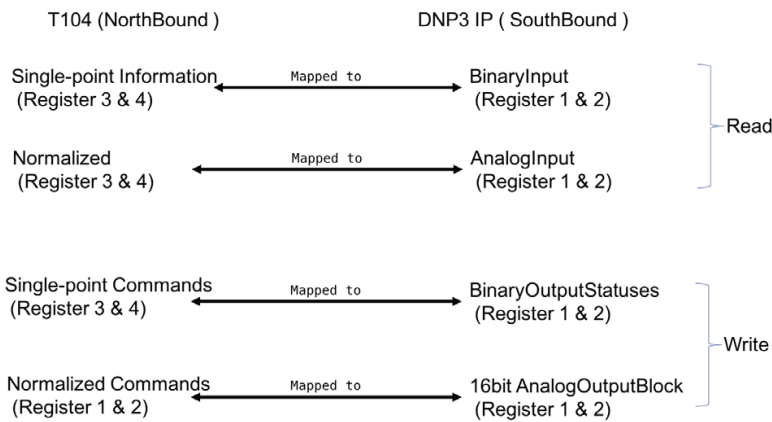

378399

Reading DNP3 Southbound Data from Northbound T104 Control Center

As the register mapping depicts Single Point Information in the Northbound T104 Control Center is mapped to the BinaryInput registers in the DNP3 Southbound device. Single Point Information in the Control Center should show the corresponding BinaryInput values set in the DNP3 Southbound device.

Northbound Control Center Single Point Information 3 and 4

See [Figure 70](#) and [Figure 71](#):

Figure 70 Reading Single Point Information

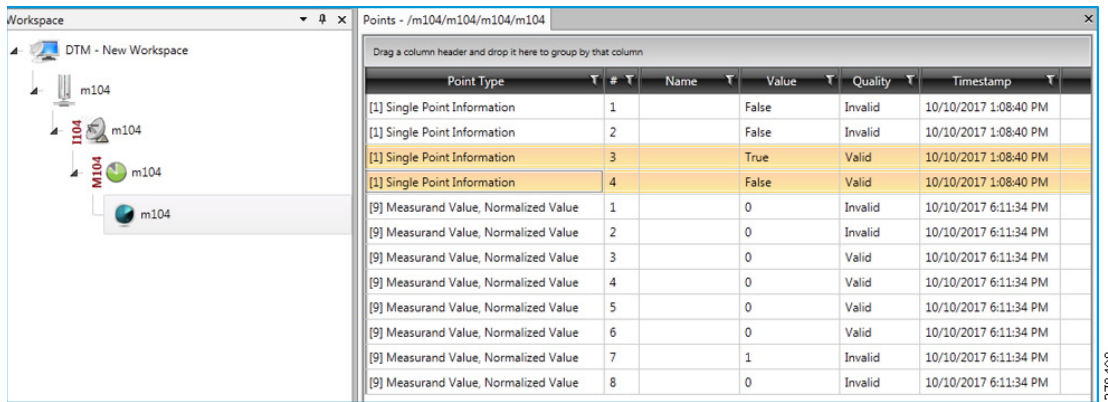
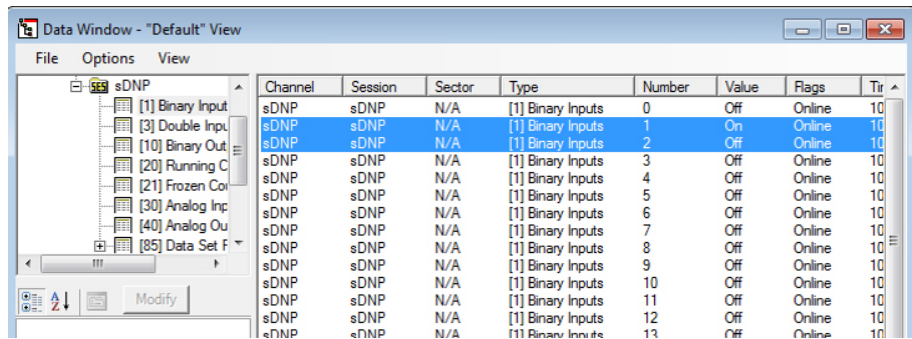

Figure 71 Southbound Binary InputRegisters



The Southbound DNP3 IP IED BinaryInput 1 and 2 register values are translated to T104 and we could observe register values are matching in the Northbound Control Center application.

Unsolicited Reporting

DNP3 supports unsolicited reporting. Slave devices send updates as values change without having to wait for a poll from the master.

In the example shown in Figure 72 and Figure 73, we are changing the AnalogInput Register 1 and 2 in the Southbound application and checking that the state of normalized 3 and 4 values in the Northbound DTM application are dynamically updated.

Figure 72 Present Value at Southbound

Channel	Session	Sector	Type	Number	Value
sDNP	sDNP	N/A	[30] Analog Inputs	0	0
sDNP	sDNP	N/A	[30] Analog Inputs	1	0
sDNP	sDNP	N/A	[30] Analog Inputs	2	0
sDNP	sDNP	N/A	[30] Analog Inputs	3	0
sDNP	sDNP	N/A	[30] Analog Inputs	4	0
sDNP	sDNP	N/A	[30] Analog Inputs	5	0
sDNP	sDNP	N/A	[30] Analog Inputs	6	0
sDNP	sDNP	N/A	[30] Analog Inputs	7	0
sDNP	sDNP	N/A	[30] Analog Inputs	8	0
sDNP	sDNP	N/A	[30] Analog Inputs	9	0

Figure 73 Present Value at Northbound

Point Type	#	Name	Value	Quality	Timestamp
[1] Single Point Information	1		False	Invalid	10/10/2017 1:08:40 PM
[1] Single Point Information	2		False	Invalid	10/10/2017 1:08:40 PM
[1] Single Point Information	3		True	Valid	10/10/2017 1:08:40 PM
[1] Single Point Information	4		False	Valid	10/10/2017 1:08:40 PM
[9] Measurand Value, Normalized Value	1		0	Invalid	10/10/2017 6:11:34 PM
[9] Measurand Value, Normalized Value	2		0	Invalid	10/10/2017 6:11:34 PM
[9] Measurand Value, Normalized Value	3		0	Valid	10/10/2017 6:11:34 PM
[9] Measurand Value, Normalized Value	4		0	Valid	10/10/2017 6:11:34 PM
[9] Measurand Value, Normalized Value	5		0	Valid	10/10/2017 6:11:34 PM
[9] Measurand Value, Normalized Value	6		0	Valid	10/10/2017 6:11:34 PM
[9] Measurand Value, Normalized Value	7		1	Invalid	10/10/2017 6:11:34 PM
[9] Measurand Value, Normalized Value	8		0	Invalid	10/10/2017 6:11:34 PM

Changing Southbound Values

Choose AnalogInput Register 1, right-click, and then change the value of the register, as shown in [Figure 74](#). The earlier value was set to 0.

Figure 74 Change Value at Southbound

Channel	Session	Sector	Type	Number	Value
sDNP	sDNP	N/A	[30] Analog Inputs	0	0
sDNP	sDNP	N/A	[30] Analog Inputs	1	20
sDNP	sDNP	N/A	[30] Analog Inputs	2	0
sDNP	sDNP	N/A	[30] Analog Inputs	3	0
sDNP	sDNP	N/A	[30] Analog Inputs	4	0
sDNP	sDNP	N/A	[30] Analog Inputs	5	0
sDNP	sDNP	N/A	[30] Analog Inputs	6	0
sDNP	sDNP	N/A	[30] Analog Inputs	7	0
sDNP	sDNP	N/A	[30] Analog Inputs	8	0
sDNP	sDNP	N/A	[30] Analog Inputs	9	0
sDNP	sDNP	N/A	[30] Analog Inputs	10	0
sDNP	sDNP	N/A	[30] Analog Inputs	11	0

Dynamically Updated Northbound Values

See [Figure 75](#):

Figure 75 Register Value Changes at Northbound

Point Type	#	Name	Value	Quality	Timestamp
[1] Single Point Information	1		False	Invalid	10/10/2017 1:08:40 PM
[1] Single Point Information	2		False	Invalid	10/10/2017 1:08:40 PM
[1] Single Point Information	3		True	Valid	10/10/2017 1:08:40 PM
[1] Single Point Information	4		False	Valid	10/10/2017 1:08:40 PM
[9] Measurand Value, Normalized Value	1		0	Invalid	10/10/2017 6:11:34 PM
[9] Measurand Value, Normalized Value	2		0	Invalid	10/10/2017 6:11:34 PM
[9] Measurand Value, Normalized Value	3		20	Valid	10/11/2017 12:10:22 PM
[9] Measurand Value, Normalized Value	4		0	Valid	10/10/2017 6:11:34 PM
[9] Measurand Value, Normalized Value	5		0	Valid	10/10/2017 6:11:34 PM
[9] Measurand Value, Normalized Value	6		0	Valid	10/10/2017 6:11:34 PM
[9] Measurand Value, Normalized Value	7		1	Invalid	10/10/2017 6:11:34 PM
[9] Measurand Value, Normalized Value	8		0	Invalid	10/10/2017 6:11:34 PM

Control Command

The status check on the Southbound TMW application Binary Output Statuses Register 1 and 2 before issuing a control command from the Northbound shows that the values are set to **OFF**. Binary output register 1 and 2 status is OFF, as shown in [Figure 76](#):

Figure 76 Register Value Changes Status at Southbound

Channel	Session	Sector	Type	Number	Value	Flags	Time Updated
sDNP	sDNP	N/A	[10] Binary Output Statuses	0	Off	Online	27Sep17 12:46:03.574
sDNP	sDNP	N/A	[10] Binary Output Statuses	1	Off	Online	27Sep17 15:18:29.636
sDNP	sDNP	N/A	[10] Binary Output Statuses	2	Off	Online	27Sep17 12:46:03.574
sDNP	sDNP	N/A	[10] Binary Output Statuses	3	Off	Online	27Sep17 12:46:03.574
sDNP	sDNP	N/A	[10] Binary Output Statuses	4	Off	Online	27Sep17 12:46:03.574
sDNP	sDNP	N/A	[10] Binary Output Statuses	5	Off	Online	27Sep17 12:46:03.574
sDNP	sDNP	N/A	[10] Binary Output Statuses	6	Off	Online	27Sep17 12:46:03.574

[Figure 77](#) shows that we tried to toggle Southbound DNP3 values from the Northbound Control Center using T104. As per the register mapping, we would toggle Single Point Commands Register 3 and check the corresponding register value in the Southbound device. The present Single Point Command Register 3 value is **OFF**.

Figure 77 Present Single Point Command Register 3 Value

[3] Input Registers	4		20	N/A	9/28/2017 11:44:53 AM
[0] Coils	3		Off	N/A	9/28/2017 11:44:52 AM
[0] Coils	4		Off	N/A	9/28/2017 11:44:52 AM
[4] Holding Registers	1		55	N/A	9/28/2017 11:44:51 AM

378437

Changing Single Point Command Register 3 value to **ON**, as shown in [Figure 78](#). T104 Command is issued on the Control Center.

Figure 78 Command to Toggle Single Point Command Register 3 Value

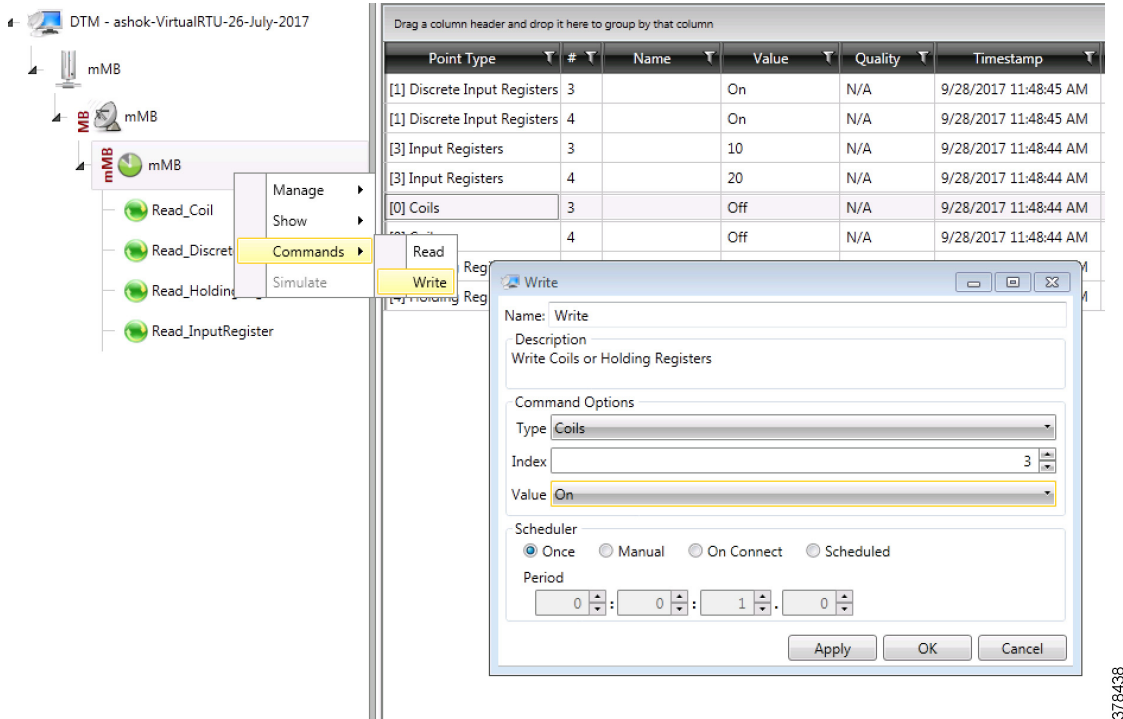

[Figure 78](#) captures the control command from the Northbound application, which is configured to work in the T104 SCADA protocol. The Southbound application is configured to work in the DNP3 IP SCADA protocol. The intermediate Virtual RTU converts the T104 command into the DNP3 IP command. In this example, the Northbound Register Value 3 is mapped to the Southbound Register Value 1. We are issuing a control command to toggle the value of register from OFF to ON, which is depicted in [Figure 79](#):

Figure 79 Command to Toggle Single Point Command Register 1

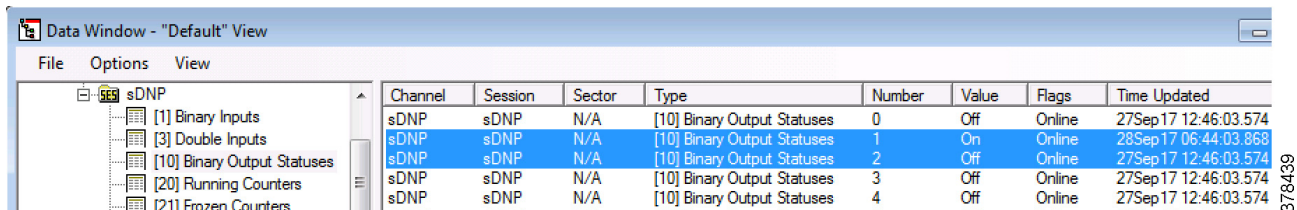

SCADA Protocol Translation Use Case using Virtual RTU

Since DNP3 supports unsolicited reporting, the T104 command center also reflects updated data for the Single Point Command Register 3. See [Figure 80](#):

Figure 80 Unsolicited Reporting at Control Center

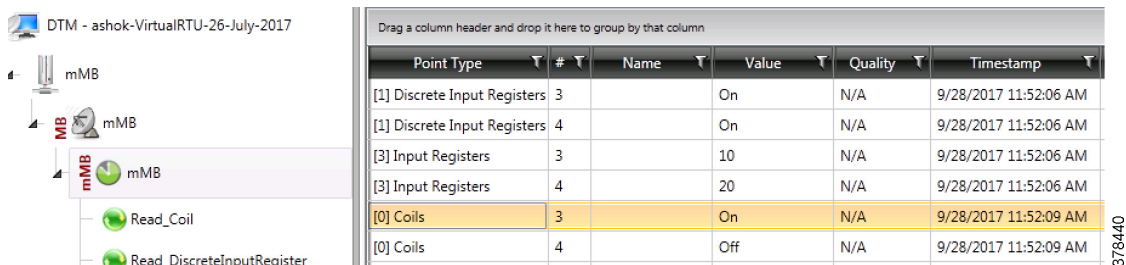

Present Analog Output Block Register 2 Value at Southbound

On a similar exercise, one can try changing the DNP3 Southbound 16 bit Analog Output Block Register 1 and 2 statuses by changing the T104 Northbound Normalized Commands Register 1 and 2. See [Figure 81](#):

Figure 81 Analog Output Register Present Value

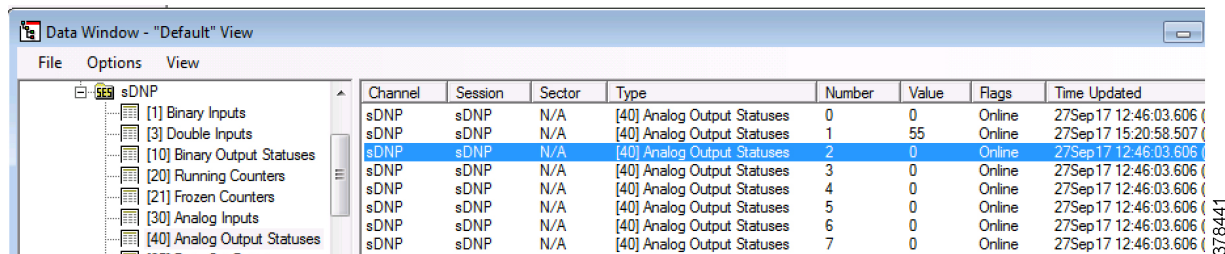

Present Normalized Commands Register 2 Value at Northbound

See [Figure 82](#):

Figure 82 Normalized Commands Register Present Value

Point Type	#	Name	Value	Quality	Timestamp
[1] Discrete Input Registers	3		On	N/A	9/28/2017 12:04:09 PM
[1] Discrete Input Registers	4		On	N/A	9/28/2017 12:04:09 PM
[3] Input Registers	3		10	N/A	9/28/2017 12:04:09 PM
[3] Input Registers	4		20	N/A	9/28/2017 12:04:09 PM
[0] Coils	3		On	N/A	9/28/2017 12:04:08 PM
[0] Coils	4		Off	N/A	9/28/2017 12:04:08 PM
[4] Holding Registers	1		55	N/A	9/28/2017 12:04:07 PM
[4] Holding Registers	2		0	N/A	9/28/2017 12:04:07 PM

378442

Changing Normalized Commands Register 2 Value

See [Figure 83](#):

Figure 83 Command to Change Normalized Commands Register Value

Name: Write

Description: Write Coils or Holding Registers

Command Options

Type: HoldingRegisters

Index: 2

Value: 45

Scheduler

Once Manual On Connect Scheduled

Period: 0 : 0 : 1 : 0

Apply OK Cancel

378443

Changes Reflecting in Southbound Binary Output Statuses Register 2

See [Figure 84](#):

Figure 84 Changes Reflected at Southbound Output Register

Channel	Session	Sector	Type	Number	Value	Flags	Time Updated
sDNP	sDNP	N/A	[40] Analog Output Statuses	0	0	Online	27Sep17 12:46:03.606
sDNP	sDNP	N/A	[40] Analog Output Statuses	1	55	Online	27Sep17 15:20:58.507
sDNP	sDNP	N/A	[40] Analog Output Statuses	2	45	Online	28Sep17 07:00:37.435
sDNP	sDNP	N/A	[40] Analog Output Statuses	3	0	Online	27Sep17 12:46:03.606
sDNP	sDNP	N/A	[40] Analog Output Statuses	4	0	Online	27Sep17 12:46:03.606
sDNP	sDNP	N/A	[40] Analog Output Statuses	5	0	Online	27Sep17 12:46:03.606
sDNP	sDNP	N/A	[40] Analog Output Statuses	6	0	Online	27Sep17 12:46:03.606
sDNP	sDNP	N/A	[40] Analog Output Statuses	7	0	Online	27Sep17 12:46:03.606

Unsolicited Reporting in T104 Control Center

See [Figure 85](#):

Figure 85 Unsolicited Reporting at Control Center

DTM - ashok-VirtualRTU-26-July-2017

Point Type	#	Name	Value	Quality	Timestamp
[1] Discrete Input Registers	3		On	N/A	9/28/2017 12:07:28 PM
[1] Discrete Input Registers	4		On	N/A	9/28/2017 12:07:28 PM
[3] Input Registers	3		10	N/A	9/28/2017 12:07:31 PM
[3] Input Registers	4		20	N/A	9/28/2017 12:07:31 PM
[0] Coils	3		On	N/A	9/28/2017 12:07:30 PM
[0] Coils	4		Off	N/A	9/28/2017 12:07:30 PM
[4] Holding Registers	1		55	N/A	9/28/2017 12:07:29 PM
[4] Holding Registers	2		45	N/A	9/28/2017 12:07:29 PM

IEC 61850-MMS (Southbound) to DNP3 IP (Northbound) Translation Use Case

Implementation Details

The Cisco IoT Gateway is connected to an actuator or sensor in the Southbound via Ethernet and uses IEC 61850-MMS as the SCADA communication protocol. Virtual RTU software does the Northbound translation to DNP3 IP since the Control Center software is running the DNP3 IP SCADA application. The Southbound IEC 61850-MMS actuator is simulated using the TMW Test Harness application. The Northbound DNP3 IP SCADA software is simulated using the TMW DTM application.

Figure 86 Implementation Details of DNP3 to IEC 61850 Translation

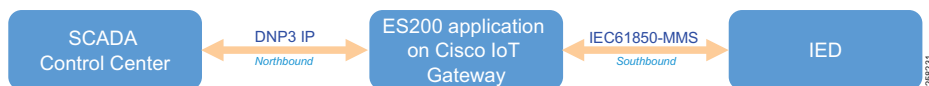

Southbound IEC 61850-MMS TMW Configuration

Channel Configuration

The Southbound IED is simulated using TMW software. In this example, the TMW-simulated IEC 61850-MMS IED is connected to GigabitEthernet1 of IR809 or FastEthernet0/0/1 of IR1101.

Figure 87 IEC 61850-MMS Channel Configuration

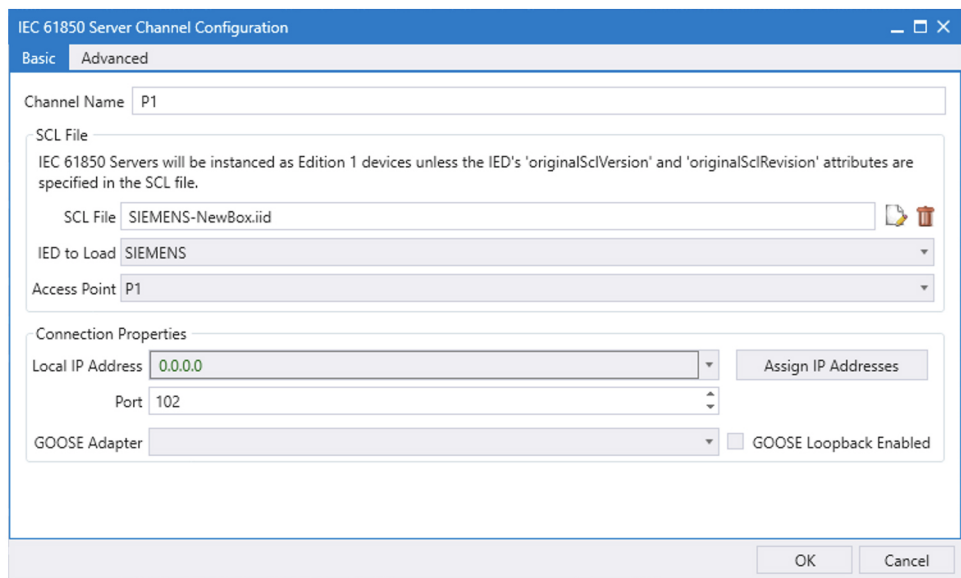

1. Choose the appropriate deployment-specific SCL file. Then select the IED.
2. In the **Advanced Configuration** tab, no changes are required. [Figure 88](#) and [Figure 89](#) are for reference.

Figure 88 IEC 61850 Advance Channel Configuration

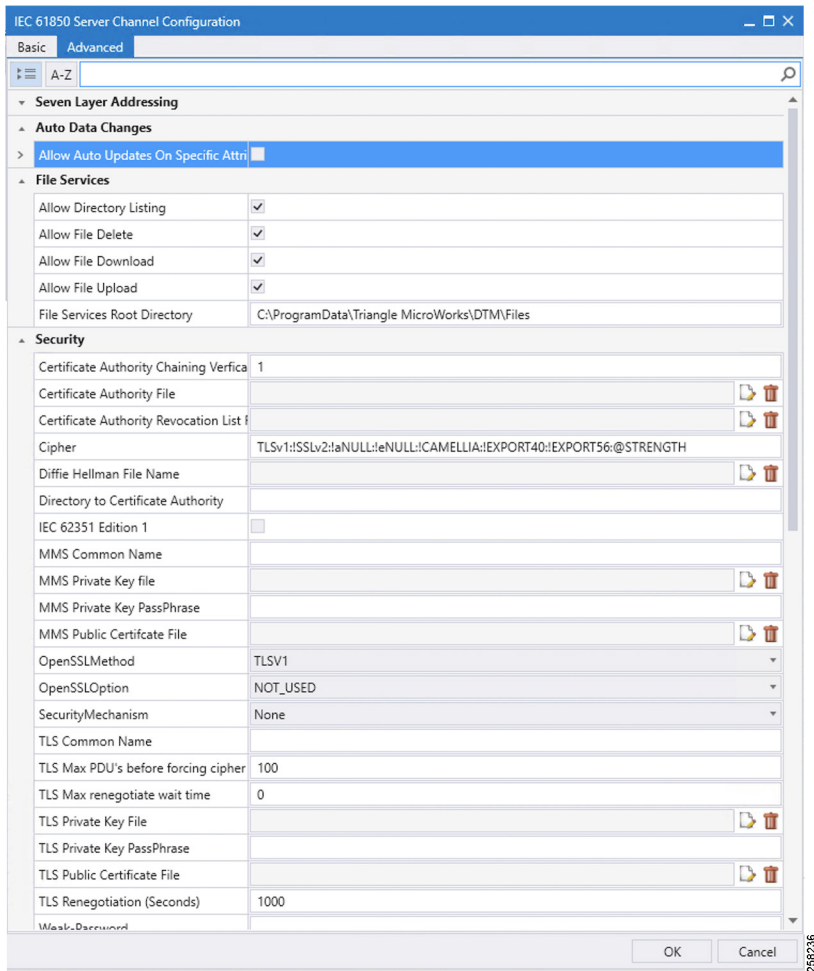

Figure 89 IEC 61850 Channel Configuration

The screenshot shows the 'IEC 61850 Server Channel Configuration' dialog box with the 'Basic' tab selected. The settings are as follows:

Section	Property	Value
Configuration	Channel Name	P1
	ConnectDelay	0
	Enabled	<input checked="" type="checkbox"/>
	ForceDisconnected	<input type="checkbox"/>
Ethernet Adapters	GOOSE Adapter	[Dropdown]
	GOOSE Loopback	Off
	Sampled Values Adapter	[Dropdown]
	Sampled Values Loopback	<input type="checkbox"/>
Basic	IED Name	[Empty]
	SCL File	SIEMENS-NewBox.iid
	Server AP	P1
	Server IED	SIEMENS
Server Specific	Ignore SCL Control Block Settings	<input type="checkbox"/>
	Ignore SCL Services	<input type="checkbox"/>
Connection	Local Address	0.0.0.0
	Maximum PDU Size	65535
	Server Port	102

Buttons: OK, Cancel

Northbound DNP3 IP TMW Configuration

DNP3 IP Channel Configuration

The TMW DTM software is configured in the DNP3 IP. Master mode is used to simulate Control Center SCADA software. Port 2401 is used to communicate between the DNP3 master and slave running in ES 200. This port needs to be opened in IOX NAT mode, which will be defined in the package.yaml file. See [Figure 90](#):

Figure 90 DNP3 IP Channel Configuration

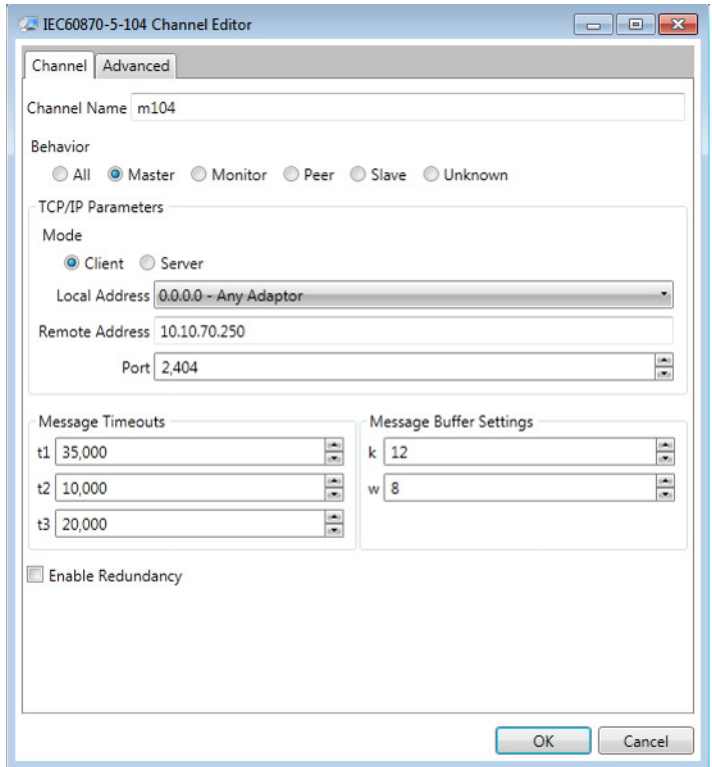

DNP3 IP Session-related Configuration

Configure the DNP3 IP Link Layer address based on Virtual RTU ES200 database settings. See [Figure 91](#):

Figure 91 DNP3 IP Session Configuration

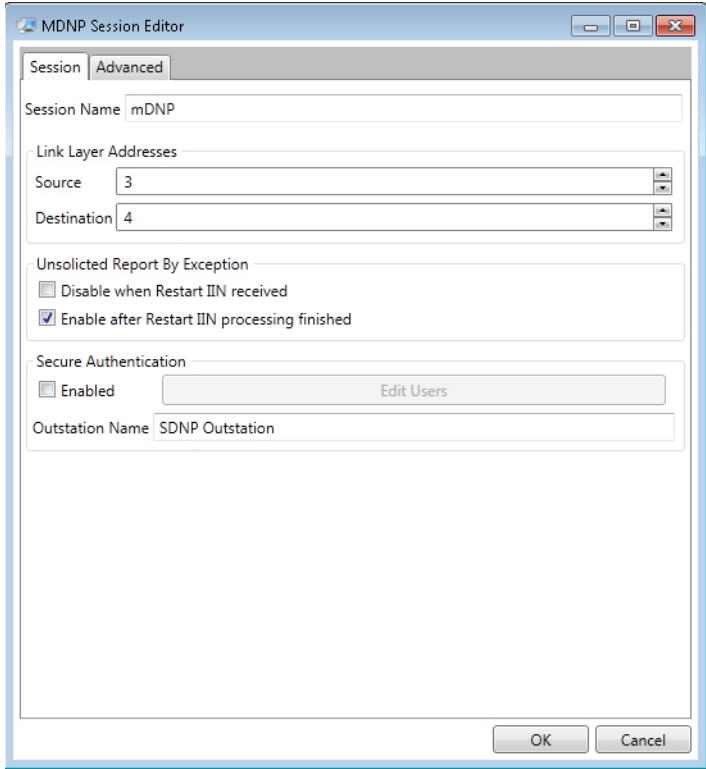

DNP3 IP Advanced Settings

AutoTimeSyncIIN and AutoEnabledUnsol are advanced DNP3 IP settings, which need to be enabled; AutoIntegrityOnline and AutoIntegrityRestart settings need to be disabled. Please refer to [Figure 92](#) for details:

Figure 92 DNP3 Advance IP Session Configuration

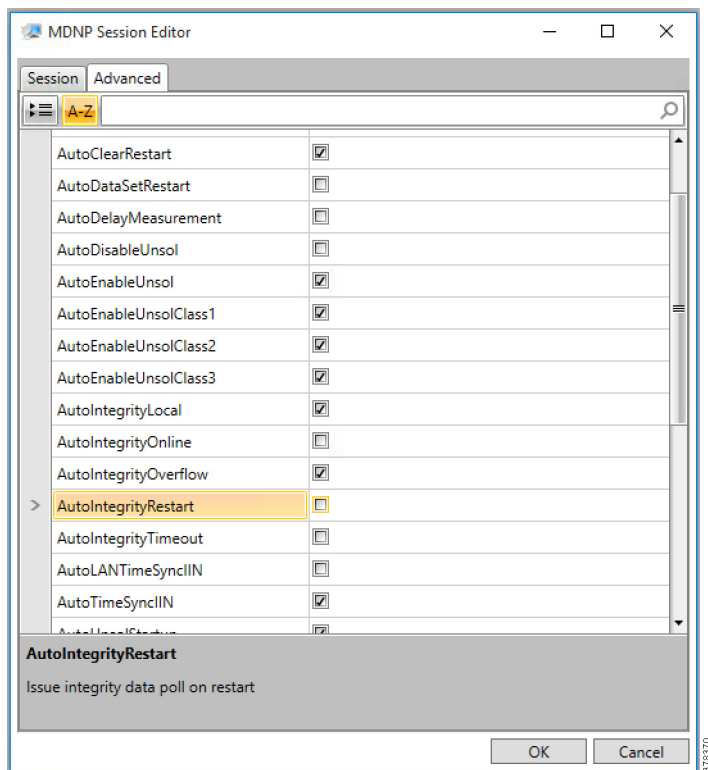

DNP3 IP (Control Center) to IEC 61850-MMS (IED) Register Mapping

The ES200 Virtual RTU software maps and translates different registers in the IEC 61850-aware Southbound device to the DNP3 protocol-aware Northbound Control Center. The sample register mappings in use by the current version of the ES200 application evaluated in the Connected Utilities Solutions lab are shown in [Figure 93](#):

Figure 93 DNP3 to IEC 61850 Point List Mapping

DNP3 IP (Northbound)	IEC61850-MMS (Southbound)	Type of Register
Binary Output	OPER - ctNum - operVal	Control Registers or Write Registers
Double Bit Input	POS - stVal - q - t	Measurement or Input Registers

Note: Contact Eximprod's team for creating/modifying the point list mapping database, at the following URL:

- <https://www.epg.ro/en/contact/>

Integrity Poll Use Case

The DNP3 specification supports multiple methods of reading inputs individually or as a group. An integrity poll returns data from Class 0 (known as static data), along with data from Classes 1, 2, and 3 (which will be event data). This may or may not be everything, depending on how the slave is configured.

The integrity poll retrieves all events (Class 1, 2, and 3) and static (Class 0) data from the device. It is typically sent after device restart, loss of communication, or on a periodic basis to ensure all data is accurate. This integrity poll is executed in our case from the Northbound DTM application depicted in [Figure 94](#) and [Figure 95](#):

Figure 94 Integrity Data Poll

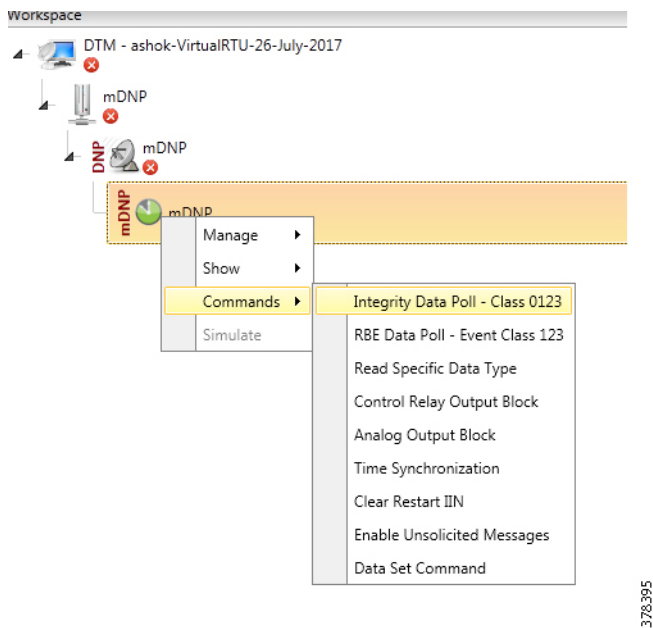
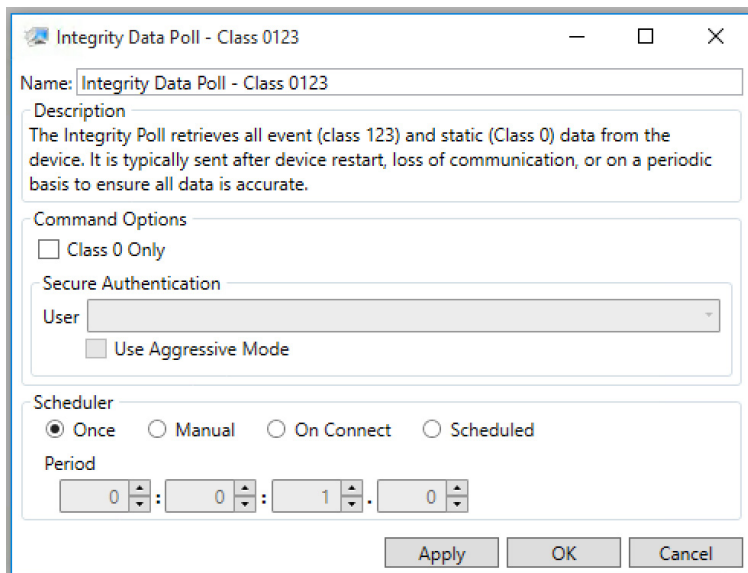
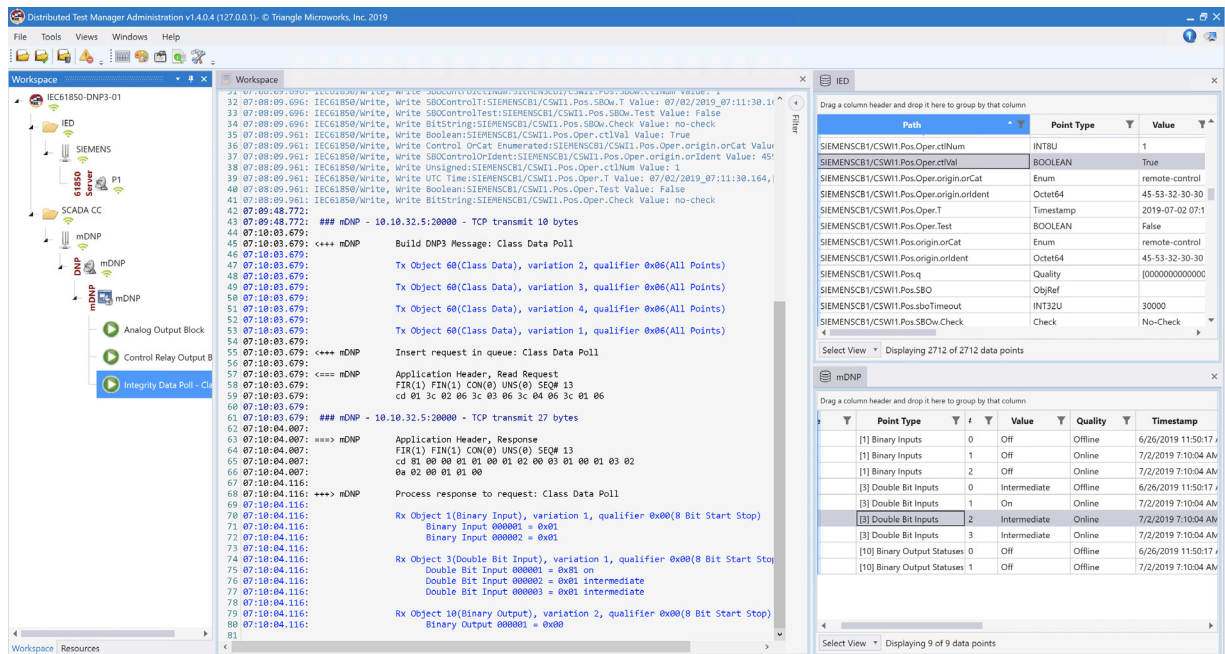

Figure 95 Integrity Data Poll Class0123



1. Click **Apply** and then click **OK** to initiate a poll. Poll results for the Northbound DTM application are shown in Figure 96.
2. Click the **Show Point List** option under the DNP3 IP Session.

Figure 96 DNP3 IP Point List



In the poll results on the Northbound simulator that are shown above, we received Double Bit input register values of DNP3. In the Southbound IED simulator, these are mapped to register Pos.Oper.stVal values.

Virtual RTU reconstruct the SCADA protocol, which matches the Southbound TMW application register values. Therefore, we conclude that the integrity poll is successful.

For the purposes of this document, we just discussed Double Bit Input register values for the Integrity poll.

Control Command

In DNP3, binary output statuses registers will be used for control write operations. We will try to issue a CROB command from the Northbound DTM application to Boolean register on IED. IF send a control command to this Boolean register Pos.Oper.ctVal it will execute the command and also update the Double Point register Pos.Oper.stVal value of IED.

The status check on the Southbound TMW before issuing a control command from the Northbound. We can see the Boolean register Pos.Oper.ctVal status is **False** in [Figure 97](#):

Figure 97 IEC 61850 Southbound Point List Status

Path	Point Type	Value
SIEMENSCB1/CSWI1.Pos.Oper.ctNum	INT8U	6
SIEMENSCB1/CSWI1.Pos.Oper.ctVal	BOOLEAN	False
SIEMENSCB1/CSWI1.Pos.Oper.origin.orCat	Enum	remote-control
SIEMENSCB1/CSWI1.Pos.Oper.origin.order	Octet64	45-53-32-30-30
SIEMENSCB1/CSWI1.Pos.Oper.T	Timestamp	2019-08-24 05:18
SIEMENSCB1/CSWI1.Pos.Oper.Test	BOOLEAN	False
SIEMENSCB1/CSWI1.Pos.origin.orCat	Enum	remote-control
SIEMENSCB1/CSWI1.Pos.origin.order	Octet64	45-53-32-30-30
SIEMENSCB1/CSWI1.Pos.q	Quality	[00000000000000]
SIEMENSCB1/CSWI1.Pos.SBO	ObjRef	
SIEMENSCB1/CSWI1.Pos.sboTimeout	INT32U	30000
SIEMENSCB1/CSWI1.Pos.SBOw.Check	Check	No-Check
SIEMENSCB1/CSWI1.Pos.SBOw.ctNum	INT8U	6
SIEMENSCB1/CSWI1.Pos.SBOw.ctVal	BOOLEAN	False
SIEMENSCB1/CSWI1.Pos.SBOw.origin.orCat	Enum	remote-control
SIEMENSCB1/CSWI1.Pos.SBOw.origin.order	Octet64	45-53-32-30-30
SIEMENSCB1/CSWI1.Pos.SBOw.T	Timestamp	2019-08-24 05:18
SIEMENSCB1/CSWI1.Pos.SBOw.Test	BOOLEAN	False
SIEMENSCB1/CSWI1.Pos.stSeld	BOOLEAN	False
SIEMENSCB1/CSWI1.Pos.stVal	Dbpos	Off
SIEMENSCB1/CSWI1.Pos.t	Timestamp	2019-08-24 05:15

Now the control command is issued from the Northbound TMW simulator to change the state of the register to **True/On**.

Figure 98 DNP3 IP Northbound CROB Control Command

The screenshot shows a configuration window titled "Control Relay Output Block". It contains several sections: "Name" (Control Relay Output Block), "Description" (The remote device may support binary output control operations to multiple data points in the same message, but all points are not required to change at the same time.), "Command Options" (Mode: DirectNoAck, Qualifier Code: SixteenBitIndex), "Control Information" (Point Number: 1, Control Code: LatchOn, Pulse On Time: 100, Pulse Off Time: 100, Count: 1), "Feedback Poll" (checked, Delay Before Sending: 100), "Secure Authentication" (User field, Use Aggressive Mode unchecked), and "Scheduler" (On Connect and Periodically options, with a time field set to 00:00:01.000). Buttons for Execute, Apply, OK, and Close are at the bottom.

Command LatchOn is executed on Point Number 1 in Figure 98 above. Mode is DirectNoAck. Control Code is LatchOn. Click **Apply** and then click **Execute** to execute the command from the Northbound DTM application.

Binary Output Statuses Pos.Oper.ctVal register value on the Southbound TMW application is changed from **False** to **True**; this is depicted in **Figure 99**.

Figure 99 IEC 61850 Southbound Register Value Changed to True

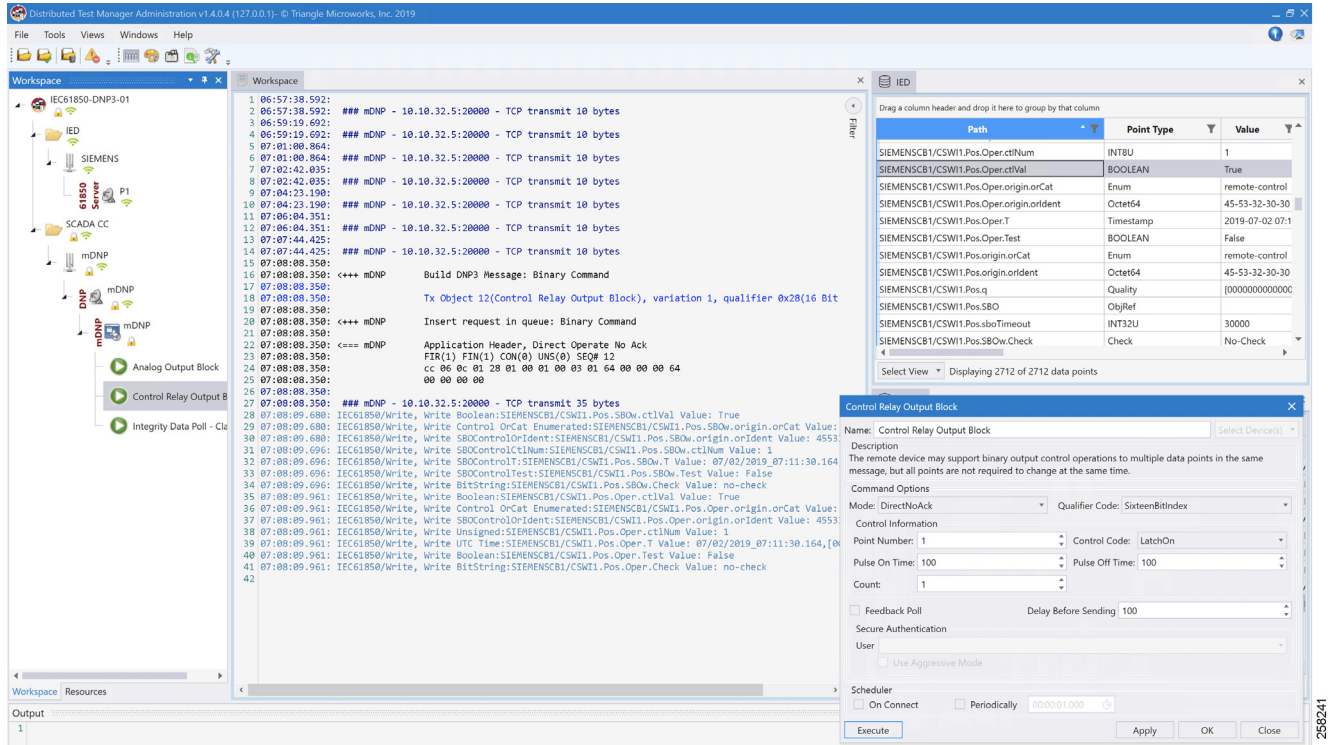

IEC 61850-MMS (Southbound) to T104 (Northbound) Translation Use Case Implementation Details

The Cisco IR809/IR1101 router is connected to an actuator or sensor in the Southbound via Ethernet and uses IEC 61850-MMS as the SCADA communication protocol. Virtual RTU software does the Northbound translation to T104 IP since the Control Center software is running the T104 IP SCADA application.

- Southbound IEC 61850-MMS Actuator is simulated using TMW Test Harness application.
- Northbound T104 SCADA Software is simulated using TMW DTM Application.

Figure 100 Implementation Details of T104 to IEC 61850 Translation - 1007

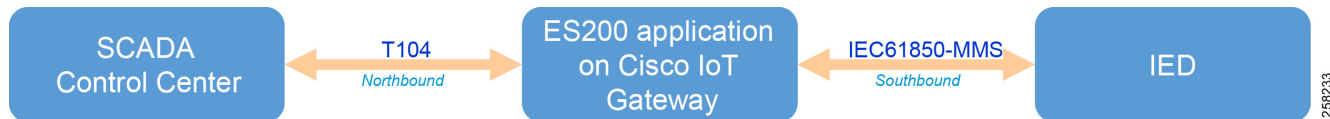

Southbound IEC 61850-MMS TMW Configuration

Channel Configuration

The Southbound IED is simulated using TMW software. In this example, the TMW simulated IEC 61850-MMS IED is connected to GigabitEthernet1 of IR809 or FastEthernet0/0/1 of IR1101.

Figure 101 IEC 61850-MMS Channel Configuration

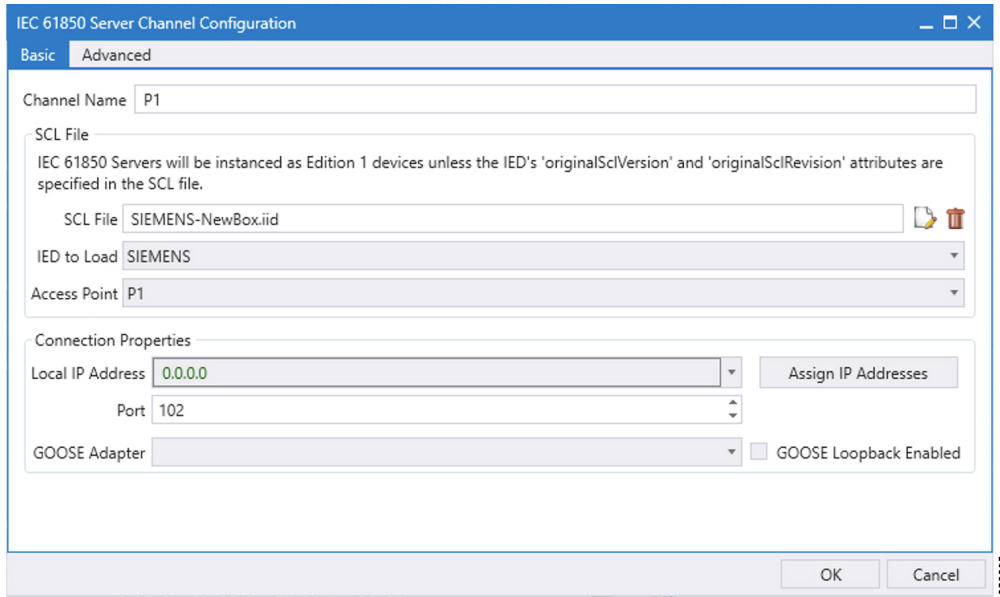

Figure 102 IEC 61850 Advanced Channel Configuration

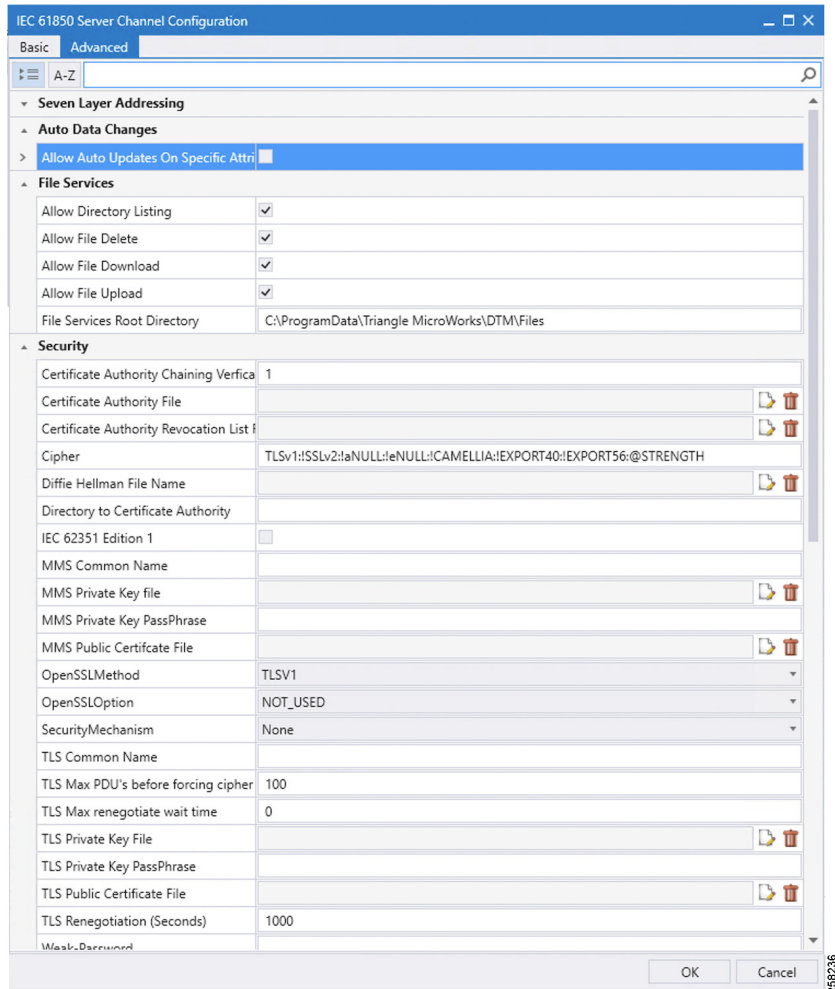
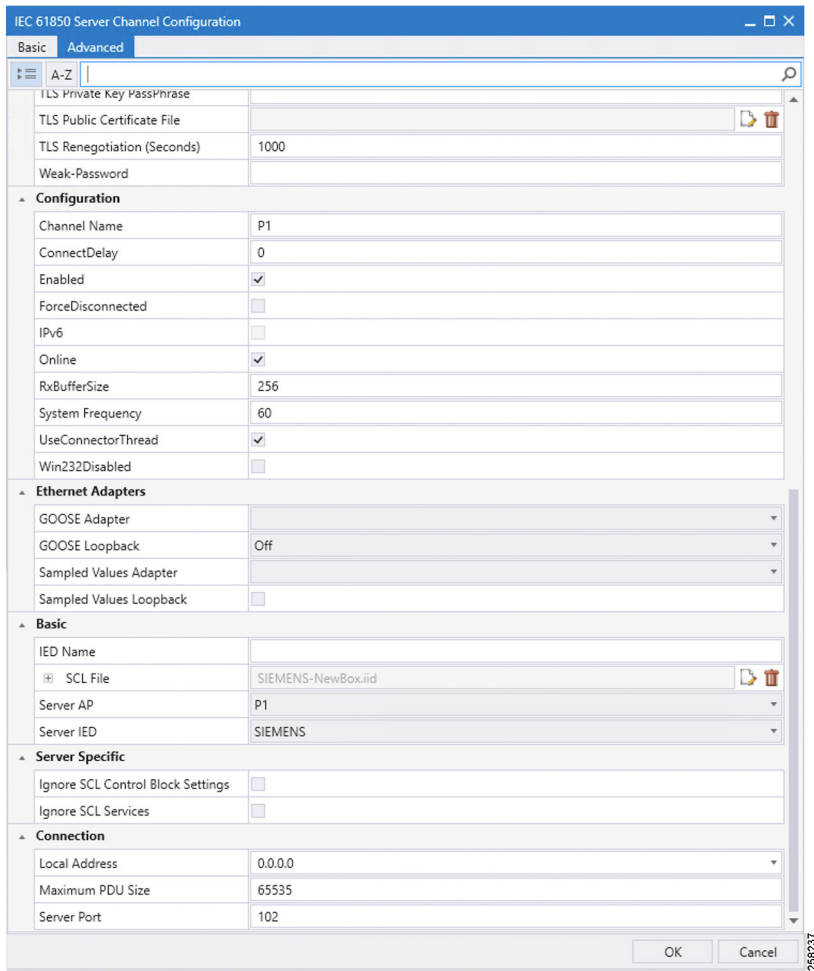

Figure 103 IEC 61850 Channel Configuration Advanced Continued



Northbound T104 TMW Configuration

Channel Configuration

The Northbound Ethernet SCADA Control Center is simulated using DTM software. In this example, Port 2404 is used for communication between the Northbound Control Center and the Virtual RTU ES200. See [Figure 104](#):

Figure 104 Northbound T104 Configuration

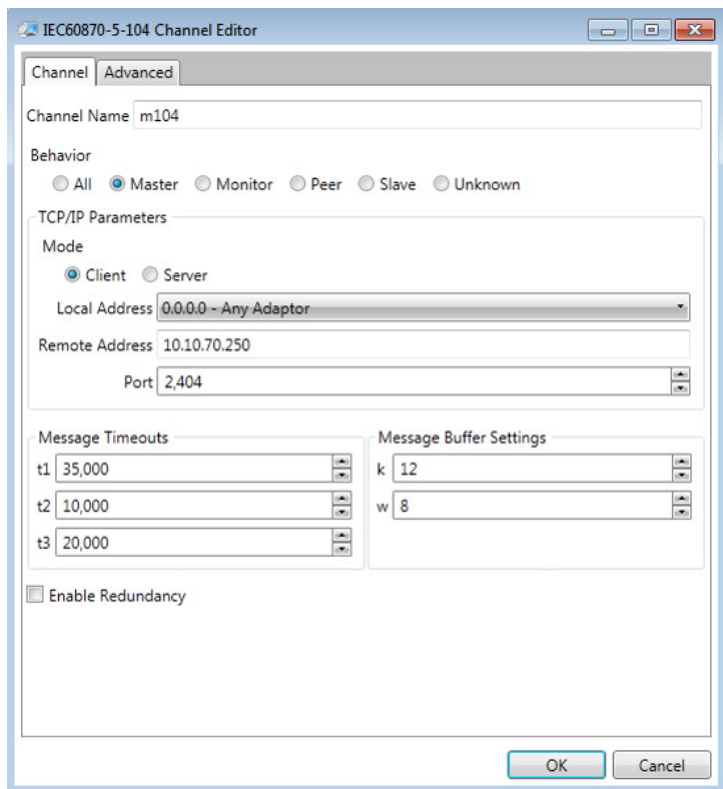

378901

T104 (Control Center) to IEC 61850-MMS (IED) Register Mapping

The ES200 Virtual RTU software maps and translates different registers in the IEC 61850-aware Southbound device to the T104 protocol-aware Northbound Control Center. The sample register mappings in use by the current version of the ES200 application evaluated in the Connected Utilities Solutions lab are shown in [Figure 105](#):

Figure 105 T104 to IEC 61850 Point List mapping - 1008

T104 IP (Northbound)	IEC61850-MMS (Southbound)	Type of Register
Single Point Commands	OPER - ctNum - operVal	Control Registers or Write Registers
Double Point Information	POS -stVal -q -t	Measurement or Input Registers

258234

Reading IEC 61850 Southbound Data from Northbound T104 Control Center

As the register mapping depicts Double Bit Information in the Northbound T104, the Control Center is mapped to the Double Point register Pos.Oper.st in IEC 61850 Southbound device. Double Point Information in the Control Center should show the corresponding Double Point Binary values set in the IEC 61850 Southbound device.

Northbound Control Center General Interrogation

See [Figure 106](#):

Figure 106 Reading Double Point Information

The screenshot shows the 'Distributed Test Manager Administration v1.4.0.4' interface. On the left, a workspace tree view shows a hierarchy starting with 'IEC61850-DNP3-02-T104', containing several 'm104' devices, an 'IED' folder, a 'SIEMENS' folder, a '61850 Server' folder, and a 'SCADA CC' folder. The 'm104' devices are further categorized into 'Double Point C_DC_NA', 'General Interrogation', and 'Single Point C_SC_NA'. On the right, two data tables are displayed. The first table, titled 'm104', shows point information with columns: Point Type, Value, #, Name, and Quality. The second table, titled 'P1', shows a detailed list of points with columns: Path, Point Typ, Value, and FC. The 'SIEMENSCB1/CSW11.Pos.stVal' point is highlighted in blue in both tables.

Point Type	Value	#	Name	Quality
[1] Single Point Information	False	1		Valid
[1] Single Point Information	False	2		Valid
[3] Double Point Information	Intermediate	0	MDPNA #0	Valid
[3] Double Point Information	On	1	MDPNA #1	Valid
[3] Double Point Information	Intermediate	2	MDPNA #2	Valid
[3] Double Point Information	Intermediate	3		Valid

Path	Point Typ	Value	FC
SIEMENSCB1/CSW11.Pos.origin.orient	Octet64	45-53-32-30-30	ST
SIEMENSCB1/CSW11.Pos.q	Quality	[00000000000000]	ST
SIEMENSCB1/CSW11.Pos.SBO	ObjRef		CO
SIEMENSCB1/CSW11.Pos.sboTimeout	INT32U	30000	CF
SIEMENSCB1/CSW11.Pos.SBOw.Check	Check	No-Check	CO
SIEMENSCB1/CSW11.Pos.SBOw.ctfNum	INT8U	3	CO
SIEMENSCB1/CSW11.Pos.SBOw.ctfVal	BOOLEAN	True	CO
SIEMENSCB1/CSW11.Pos.SBOw.origin.orient	Enum	remote-control	CO
SIEMENSCB1/CSW11.Pos.SBOw.origin.orient	Octet64	45-53-32-30-30	CO
SIEMENSCB1/CSW11.Pos.SBOw.T	Timestamp	2019-08-23 13:44	CO
SIEMENSCB1/CSW11.Pos.SBOw.Test	BOOLEAN	False	CO
SIEMENSCB1/CSW11.Pos.stSeld	BOOLEAN	False	ST
SIEMENSCB1/CSW11.Pos.stVal	Dbpos	On	ST
SIEMENSCB1/CSW11.Pos.t	Timestamp	2019-08-23 13:41	ST
SIEMENSCB1/GAPC1.Beh.q	Quality	[00000000000000]	ST
SIEMENSCB1/GAPC1.Beh.stVal	Enum	on	ST
SIEMENSCB1/GAPC1.Beh.t	Timestamp	2019-08-23 13:30	ST
SIEMENSCB1/GAPC1.Health.q	Quality	[00000000000000]	ST
SIEMENSCB1/GAPC1.Health.stVal	Enum	Ok	ST
SIEMENSCB1/GAPC1.Health.t	Timestamp	2019-08-23 13:30	ST
SIEMENSCB1/GAPC1.Mod.ctfModel	Enum	status-only	CF
SIEMENSCB1/GAPC1.Mod.q	Quality	[00000000000000]	ST
SIEMENSCB1/GAPC1.Mod.stVal	Enum	on	ST

The Double Point register Pos.Oper.stVal on IED is read by the T104 General Interrogation command and the results are updated in Double Point Information register of T104 in Control Center.

Control Command

For the Control command example, a Single Point Control Command is sent from Control Center using the T104 protocol. The ES200 application translates T104 command to the IEC 61850 command, the southbound IEC 61850 IED Boolean register Pos.Oper.ctVal is updated with the control command, and also internally IEC 61850 updates the Double Point register Pos.Oper.stVal value of IED. This Double Point register Pos.Oper.stVal is read by T104 General Interrogation command and the results are updated in Double Point Information register of T104.

Initial status of Pos.Oper.ctVal and Pos.Oper.stVal registers of IED are shown in [Figure 107](#):

Figure 107 IEC 61850 IED Initial Register Status

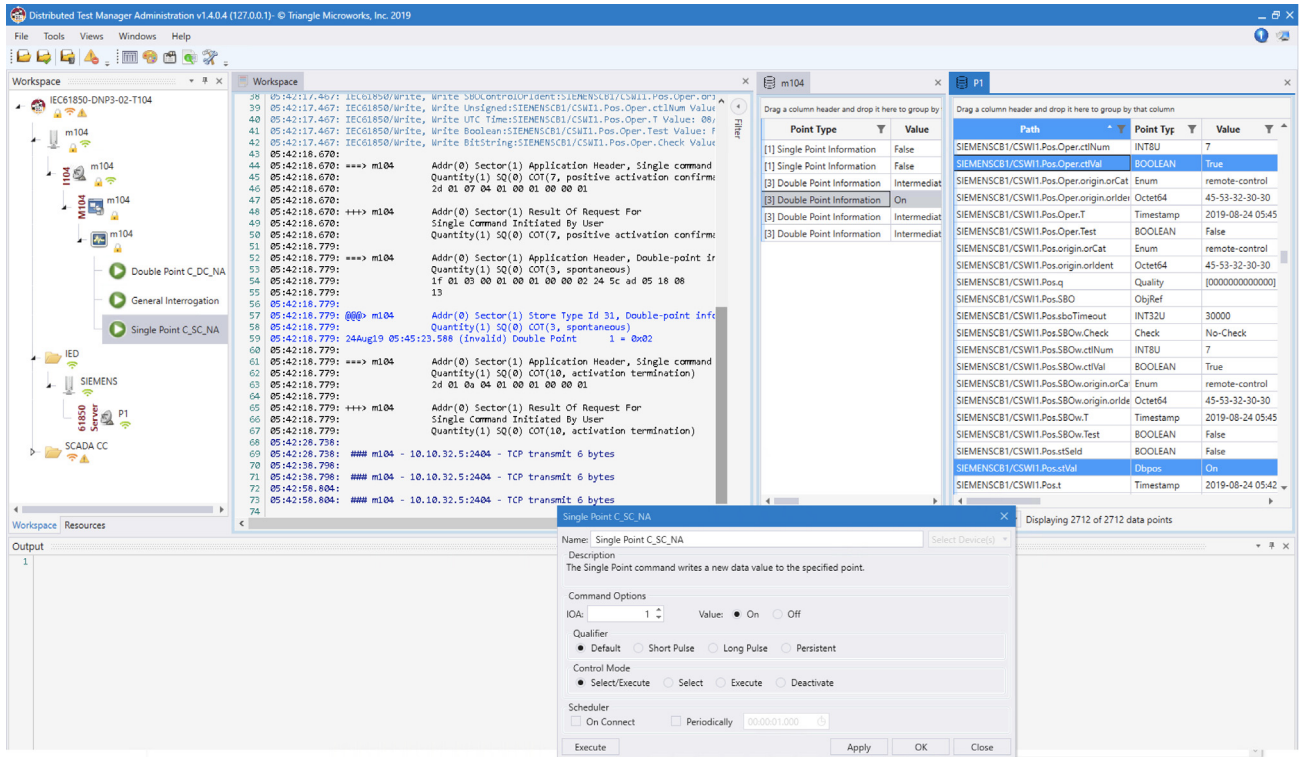

- The register value of Pos.Oper.ctVal is **False**
- The register value of Pos.Oper.stVal is **Off**

[Figure 107](#) captures the Control Command from the Northbound application, which is configured to work in the T104 SCADA protocol. The Southbound application is configured to work in the IEC 61850 SCADA protocol. The intermediate Virtual RTU converts the T104 command into the IEC 61850 command. We are issuing a control command to toggle the value of register from False to True, which is depicted in [Figure 108](#):

Figure 108 Single Point Control Command

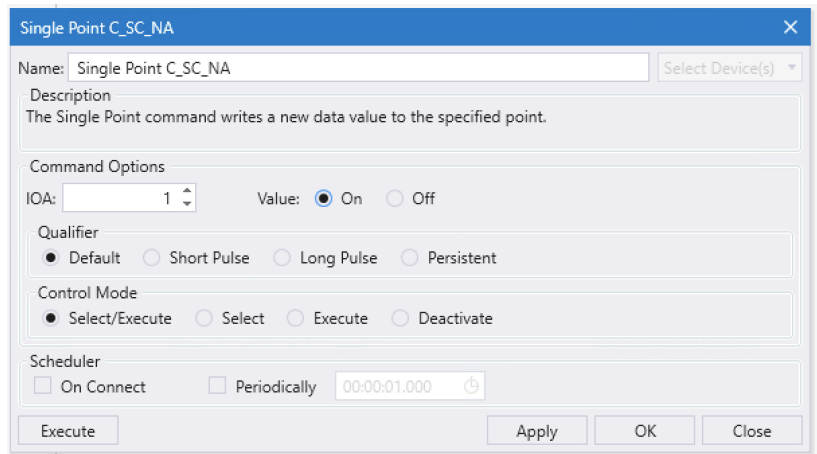

Single Point command is executed on IOA address 1 in Figure 108, with Qualified as Default and Control Mode as Select/Execute. Click **Apply** and then click **Execute** to execute the command from the Northbound DTM application.

Figure 109 IEC 61850 Double Point Status

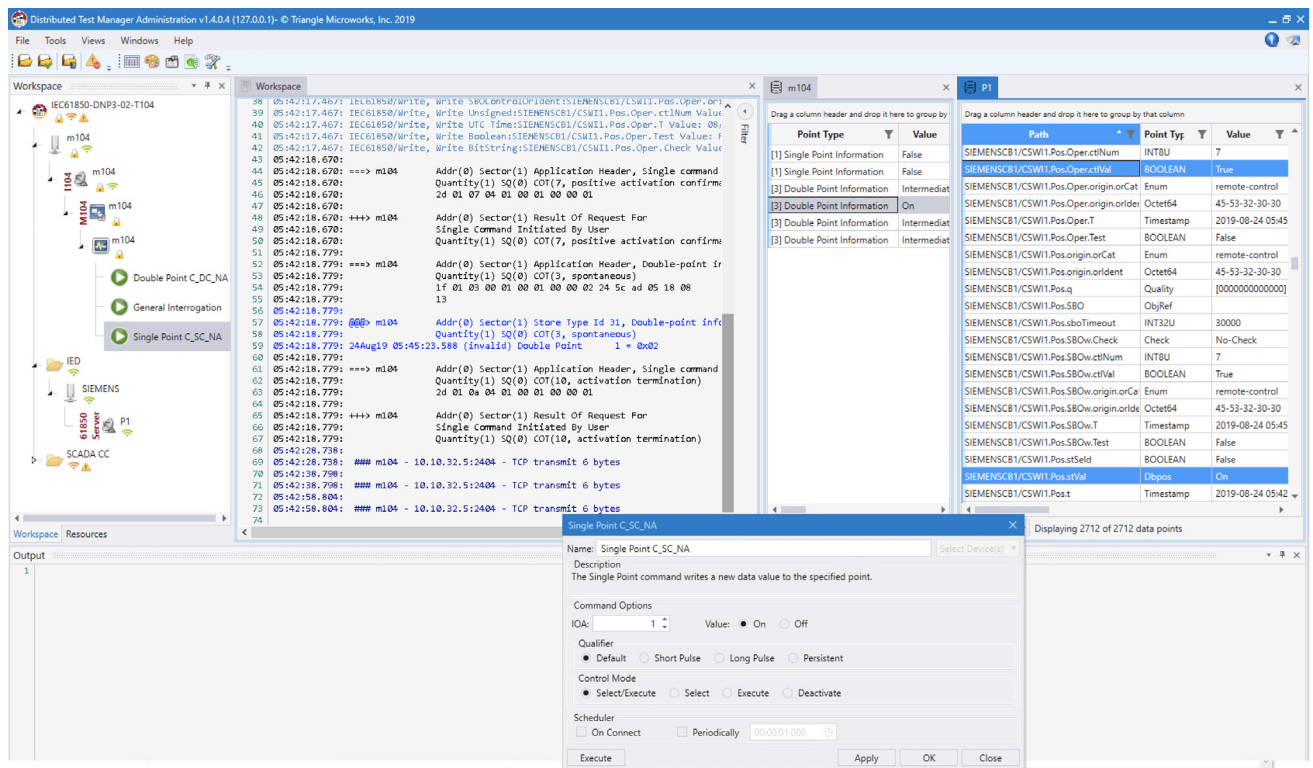

- The Double Point register value of Pos.Oper.stVal is On
- The Boolean register value of Pos.Oper.ctVal is True

The Southbound IEC 61850 IED Boolean register Pos.Oper.ctVal is updated in Double Point register Pos.Oper.stVal value of IED. This Double Point register Pos.Oper.stVal is read by T104 General Interrogation command and the results are reflected in the Double Point Information register of T104.

Limitations

This section covers the list of open limitations in the system.

The Virtual RTU ES200 database changes based on different protocol translations that need to be done manually by using the Windows-based ES200 desktop application. Then the database is exported to the Cisco IoT Gateway devices. Eximprod is working with the Cisco Fog Director Team to bring in support for editing the ES200 database from the Fog Director.

References

Cisco Documentation

Cisco IR809: *Cisco 809 Industrial Integrated Services Routers Data Sheet* at the following URL:

- <https://www.cisco.com/c/en/us/products/collateral/routers/809-industrial-router/datasheet-c78-734980.html>

Cisco IR1101: *Cisco IR1101 Industrial Integrated Services Routers Data Sheet* at the following URL:

- <https://www.cisco.com/c/en/us/products/collateral/routers/1101-industrial-integrated-services-router/datasheet-c78-741709.html>

Cisco ASR 1000: *Cisco ASR 1000 Series Aggregation Services Routers* at the following URL:

- <https://www.cisco.com/c/en/us/products/routers/asr-1000-series-aggregation-services-routers/index.html>

Cisco Fog Director at the following URL:

- https://www.cisco.com/c/en_in/products/cloud-systems-management/fog-director/index.html

Cisco IOx Data Sheet at the following URL:

- <https://www.cisco.com/c/en/us/products/collateral/cloud-systems-management/iox/datasheet-c78-736767.html>

Eximprod Documentation

ES200 Data Sheet (ES200 Supervision, Control and Communication RTU Gateway) at the following URL:

- <http://www.epg.ro/wp-content/uploads/2017/09/ES200-Datasheet-public.pdf>

Eximprod SCADA at the following URL:

- <http://www.epg.ro/en/scada/>

General Documentation

EuroElectric Power Distribution in Europe Facts & Figures at the following URL:

- https://www3.eurelectric.org/media/113155/dso_report-web_final-2013-030-0764-01-e.pdf

Glossary

The following table lists and expands the acronyms and initialisms used in this document.

Term	Expansion
ASR	Cisco Aggregation Services Routers
CROB	Control Relay Output Block
CVD	Cisco Validated Design
DA	Distribution Automation
DMVPN	Dynamic Multipoint Virtual Private Network
DNP	Distributed Network Protocol
DSO	Distribution System Operator
DTM	TMW Distributed Test Manager
FAN	Field Area Network
FLISR	Fault Location Identification and Service Restoration
FND	Field Network Director
HER	Headend Router
IED	Intelligent End Device
IoT	Internet of Things
IPv4	Internet Protocol Version 4
LAN	Local Area Network
LTE	Long Term Evolution
LXC	Linus Container
MMS	Manufacturing Message Specification
NAT	Network Address Translation
PaaS	Platform as a service
RBE	Report by Exception
RTU	Remote Terminal Unit
SAIDI	System Average Interruption Duration Index
SAIFI	System Average Interruption Frequency Index
SCADA	Supervisory Control and Data Acquisition
TCP	Transmission Control Protocol
TMW	Triangle MicroWorks