



Virtual Routers

This chapter describes underlying concepts about virtual routers and on how virtual routing behaves within the Secure Firewall Threat Defense.

- [About Virtual Routers and Virtual Routing and Forwarding \(VRF\), on page 1](#)
- [Maximum Number of Virtual Routers By Device Model, on page 7](#)
- [Requirements and Prerequisites for Virtual Routers, on page 9](#)
- [Guidelines and Limitations for Virtual Routers, on page 9](#)
- [Modifications to the Management Center Web Interface - Routing Page, on page 11](#)
- [Manage Virtual Routers, on page 11](#)
- [Create a Virtual Router, on page 12](#)
- [Monitoring Virtual Routers, on page 15](#)
- [Configuration Examples for Virtual Routers, on page 16](#)
- [History for Virtual Routers, on page 54](#)

About Virtual Routers and Virtual Routing and Forwarding (VRF)

You can create multiple virtual routers to maintain separate routing tables for groups of interfaces. Because each virtual router has its own routing table, you can provide clean separation in the traffic flowing through the device.

Thus, you can provide support to two or more distinct customers over a common set of networking equipment. You can also use virtual routers to provide more separation for elements of your own network, for example, by isolating a development network from your general purpose corporate network.

Virtual routers implement the “light” version of Virtual Routing and Forwarding, or VRF-Lite, which does not support Multiprotocol Extensions for BGP (MBGP).

When you create a virtual router, you assign interfaces to the router. You can assign a given interface to one, and only one, virtual router. You would then define static routes, and configure routing protocols such as OSPF or BGP, for each virtual router. You would also configure separate routing processes over your entire network, so that routing tables on all participating devices are using the same per-virtual-router routing process and tables. Using virtual routers, you create logically-separated networks over the same physical network to ensure the privacy of the traffic that runs through each virtual router.

Because the routing tables are separate, you can use the same, or overlapping, address spaces across the virtual routers. For example, you could use the 192.168.1.0/24 address space for two separate virtual routers, supported by two separate physical interfaces.

Note that there are separate management and data routing tables per virtual router. For example, if you assign a management-only interface to a virtual router, then the routing table for that interface is separate from the data interfaces assigned to the virtual router.

About Virtual Routers and Dynamic VTI

Virtual Routers and Dynamic VTI

You can create virtual routers, associate dynamic VTIs with these virtual routers, and extend the capabilities of dynamic VTIs in your network. You can associate dynamic VTIs either with global or user-defined virtual routers. You can assign a dynamic VTI to only one virtual router.

A virtual router associated with:

- A dynamic VTI is called an Indoor VRF (IVRF).
- A tunnel source interface is known as Front Door VRF (FVRF).

A dynamic VTI and its corresponding protected network interface must be part of the same virtual router. You must map the borrow IP interface and the dynamic VTI to the same virtual router. A tunnel source interface can be part of multiple virtual routers.

To configure virtual routers using dynamic VTI for a route-based site-to-site VPN, see [How to Configure a Virtual Router with Dynamic VTI, on page 2](#).

For more information about a configuration example, see [How to Secure Traffic from Networks with Multiple Virtual Routers over a Site-to-Site VPN with Dynamic VTI, on page 33](#)

How to Configure a Virtual Router with Dynamic VTI

To configure a virtual router with dynamic VTI for a route-based site-to-site VPN in the management center:

Step	Do This	More Information
1	Create a route-based site-to-site VPN with a dynamic VTI interface on the hub and static VTI(s) on the spoke(s).	Create a Route-based Site-to-Site VPN
2	Create a virtual router.	Create a Virtual Router, on page 12
3	Assign the interfaces to the virtual router.	Configure a Virtual Router, on page 12
4	Configure routing policies for the hub and spoke.	Configure Endpoints for a Hub and Spoke Topology
5	Configure access control policies for the hub and spoke.	Configure Endpoints for a Hub and Spoke Topology

Applications of Virtual Routers

You can use virtual routers to isolate network on shared resources and/or to isolate networks with common security policy. Thus, virtual routers help you to achieve:

- Traffic separation for customers through dedicated routing tables for each customer or for different departments.
- Common security policy management for different departments or networks.
- Shared internet access for different departments or network.

Global and User-Defined Virtual Routers

Global Virtual Routers

For a device with virtual routing capability, system creates a global virtual router by default. The system assigns all interfaces in your network to the global virtual router. A routed interface can belong to either a user-defined virtual router or a global virtual router. When you upgrade threat defense to a version which has virtual router capability, all its existing routing configuration becomes part of the global virtual router.

User-Defined Virtual Routers

A user-defined virtual router is the one defined by you. You can create more than one virtual router on a device. However, anytime, an interface can be assigned to only one user-defined virtual router. While some of the device features are supported on user-defined virtual routers, few of the features are supported only on the global virtual routers. User-defined virtual routers support route-based site-to-site VPN (static VTI) (static and dynamic VTI).

Supported Features and Monitoring Policies

You can configure the following features on the global virtual router only:

- OSPFv3
- RIP
- EIGRP
- IS-IS
- Multicast Routing
- Policy Based Routing (PBR)

ISIS and PBR are supported through Flex Config in management center (see [Predefined FlexConfig Objects](#)). Configure only global virtual router interfaces for these features.

DHCP server auto-configuration uses WINS/DNS server that is learned from an interface. This interface can only be a global virtual router interface.

You can configure the following features separately for each user-defined virtual router:

- Static routes and their SLA monitors
- OSPFv2
- BGPv4/v6
- Integrated Routing and Bridging (IRB)
- SNMP

Following features are used by the system when querying or communicating with the remote system (from-the-box traffic). These features use interfaces in the global virtual router only. That means, if you configure an interface for the feature, it must belong to the global virtual router. As a rule, anytime, if the system must look up a route to reach an external server for its own management purposes, it does the route lookup in the global virtual router.

- DNS server when used to resolve fully qualified names used in access control rules, or for resolving names for the **ping** command. If you specify **any** as the interface for a DNS server, the system considers interfaces in the global virtual router only.
- AAA server or identity realm when used with VPN. You can configure VPN on interfaces in the global virtual router only. Thus, the external AAA servers that are used for VPN, such as Active Directory, must be reachable through an interface in the global virtual router.

Configuring Policies to be Virtual-Router-Aware

When you create a virtual router, the routing table for that virtual router is automatically separated from the global virtual router or any other virtual router. However, security policies are not automatically virtual-router-aware.

For example, if you write an access control rule that applies to “any” source or destination security zone, then the rule will apply to all interfaces across all virtual routers. This might in fact be exactly what you want. For example, all of your customers might want to block access to the same list of objectionable URL categories.

But, if you need to apply a policy to one of the virtual routers but not others, you need to create security zones that contain interfaces from that single virtual router only. Then, use the virtual-router-constrained security zones in the source and destination criteria of the security policy.

By using security zones whose memberships are constrained to the interfaces assigned to a single virtual router, you can write virtual-router-aware rules in the following policies:

- Access control policy.
- Intrusion and file policies.
- SSL decryption policy.
- Identity policy and user-to-IP address mappings. If you use overlapping address spaces in virtual routers, ensure that you create separate realms for each virtual router and apply them correctly in the identity policy rules.

If you use overlapping address spaces in your virtual routers, you should use security zones to ensure that the right policies get applied. For example, if you use the 192.168.1.0/24 address space in two separate virtual routers, an access control rule that simply specifies the 192.168.1.0/24 network will apply to traffic in both virtual routers. If that is not the desired outcome, you can limit the application of the rule by also specifying the source/destination security zones for just one of the virtual routers.

Interconnecting Virtual Routers

Static and Dynamic Route Leaking

You can configure the device to route traffic between virtual routers. This process of route leaking can be done manually by setting up static routes or dynamically through BGP settings.

Static Route Leaking

You can configure static routes to route traffic between virtual routers.

For example, if you have the outside interface in the global virtual router, you can set up static default routes in each of the other virtual routers to send traffic to the outside interface. Then, any traffic that cannot be routed within a given virtual router gets sent to the global router for subsequent routing.

Static routes between virtual routers are known as route leaks, because you are leaking traffic to a different virtual router. When you are leaking routes, say, VR1 routes to VR2, you can initiate connections from VR2 to VR1 only. For traffic to flow from VR1 to VR2, you must configure the reverse route. When you create a static route to an interface in another virtual router, you do not need to specify a gateway address. Simply select the destination interface.

For inter-virtual-router routes, the system does destination interface look-up in the source virtual router. Then, it looks up the MAC address of the next hop in the destination virtual router. Thus, the destination virtual router must have either a dynamic (learned) or static route for the selected interface for the destination address.

Configuring NAT rules that use source and destination interfaces in different virtual routers can also allow traffic to route between virtual routers. If you do not select the option for NAT to do a route lookup, the rule will simply send traffic out the destination interface with a NATed address whenever destination translation happens. However, the destination virtual router should have a route for the translated destination IP address so that next-hop lookup can succeed.

Though NAT rule leaks traffic from one virtual router to another, to ensure correct routing, we recommend that you configure a static route leak between these virtual routers for the translated traffic. Without the route leak, sometimes the rule may not match the traffic you expect it to match, and the translation may not be applied.

Virtual routing does not support a cascading or chain of route leaks. For example, assume that your threat defense has VR1, VR2, and VR3 virtual routers; VR3 is directly connected to a network - 10.1.1.0/24. Now, assume you configure a route leak in VR1 for network 10.1.1.0/24 through interface in VR2 and in VR2 define a route leak for 10.1.1.0/24 through VR3. This chain of route leaks will not allow traffic to hop from VR1 to VR2 and then exit from VR3. In case of route leaks, the route lookups first determine egress interface from input Virtual Router's routing table and then looks at the output of Virtual Router's routing table for next hop lookup. From both the lookups, egress interface should match. In our example, the egress interfaces will not be the same and hence the traffic does not pass through.

Use static inter VRF route with caution when the destination network is not a direct-connected subnet of the upstream (outgoing) VR. For example, assume two VRs - VR1 and VR2. While VR1 handles the outgoing traffic which gets the default route from its external peer through BGP or any dynamic routing protocol, and VR2 handles the incoming traffic which is configured with static inter VRF default route with VR1 as the next-hop. When VR1 loses the default route from its peer, VR2 will not be able to detect that its upstream (outgoing) VR lost the default route and the traffic is still sent toward VR1 which will eventually get dropped without notifications. In this scenario, we recommend that you configure VR2 with dynamic route leak through BGP.

Dynamic Route Leaking Using BGP

You can implement an inter-virtual-router route leak by exporting routes from a source virtual router (say VR1) to the source BGP table using route target extended community and then importing the same route target extended community from the source BGP table into the destination BGP table, which in turn is used by the destination virtual router (say, VR2). You can use the route maps for filtering the routes. The routes of global virtual router can also be leaked to user-defined virtual routers and vice versa. The BGP inter-virtual-router route leaking supports both ipv4 and ipv6 prefixes.

For details on configuring BGP route leaking, see [Configure BGP Route Import/Export Settings](#).

BGP Route Leaking Guidelines

- Ensure that all the routes required for recursion are imported and present in the routing table of the ingress virtual router.
- ECMP is supported per virtual router. Hence, do not configure an ECMP across different virtual routers. The overlapping prefixes imported from different virtual routers cannot form an ECMP. That is, when you attempt to import routes with overlapping addresses from two different virtual routers to other virtual routers (a global virtual router or an user-defined virtual router), only one route (as per BGP best path algorithm, the first route that was advertised) is imported to the respective virtual routing table. For example, if a network 10.10.0.0/24, connected to VR1 is advertised through BGP to a global virtual router first, and later another network with the same address 10.10.0.0/24, connected to VR2 is also advertised through BGP to global virtual router, only the VR1 network route is imported to the global virtual routing table.
- OSPFv3 is not supported on user-defined virtual routers. Hence, do not configure BGPv6 to leak OSPFv3 user-defined virtual routers to global virtual router. However, you can configure BGPv6 to leak OSPFv3 global virtual router routes to user-defined virtual router through redistribution.
- It is recommended to keep VTI interface, protected internal interfaces (loopback interface if supported for VTI) to be part of same virtual router to prevent the need for route leak.

Overlapping IP Addresses

Virtual router creates multiple instances of routing tables that are independent, thereby, the same or overlapping IP addresses can be used without conflicts. Threat Defense allows the same network to be part of two or more virtual routers. This involves multiple policies to be applied at the interface or at the virtual router level.

Other than few exceptions, the routing functions and most of the NGFW and IPS capability does not get impacted by the overlapping IP addresses. The following section describes the features that have limitations with overlapping IP addresses and the suggestions or recommendations to overcome them.

Limitations with Overlapping IP Addresses

When using an overlapping IP address in multiple virtual routers, to ensure proper application of the policy, you have to modify policies or rules for some of the features. Such features require you to use more specific interface either by splitting existing security zone or using new interface group as the need be.

Following features need modification for its proper functioning with an overlapping IP address:

- Network Map—Modify the network discovery policy to exclude some overlapping IP segments to ensure that there is no overlapping IP address being mapped.
- Identity Policy—The identity feed source cannot differentiate among virtual routers; to overcome this limitation, map overlapping address spaces or virtual routers in different realms.

For the following features, you need to apply rules on specific interfaces to ensure that different policies are applied on overlapping IP segments:

- Access Policy
- Prefilter Policy

- QoS/Rate Limit
- SSL Policy

Unsupported Features with Overlapping IP Addresses

- ISE SGT-based Rule in AC Policy—The static security group tag (SGT) to IP address mappings downloaded from Cisco Identity Services Engine (ISE) are not virtual-router-aware. Set up separate ISE systems per virtual router if you need to create different SGT mappings per virtual router. This is not necessary if you intend to map the same IP addresses to the same SGT number in each virtual router.
- Overlapping DHCP server pools are not supported across virtual routers.
- Events and Analytics—Many of the management center analytics are dependent on network map and identity mappings which cannot differentiate if the same IP address belongs to two different end hosts. Hence, these analytics are not accurate when there are overlapping IP segments existing in same device but different virtual routers.

Configuring SNMP on User-Defined Virtual Routers

In addition to supporting SNMP on the management interface and Global virtual router data interfaces, Secure Firewall Threat Defense now allows you to configure SNMP host on user-defined virtual routers.

Configuring an SNMP host on user-defined virtual routers includes the following process:

1. [Configure device interfaces.](#)
2. [Create a Virtual Router](#)
3. [Configure SNMP hosts on a virtual router interface.](#)



Note SNMP is not virtual router-aware. Hence, while configuring SNMP server on the user-defined virtual router, ensure that the network address is not an [Overlapping IP Addresses](#).

4. [Deploy configurations to Secure Firewall Threat Defense.](#) On successful deployment, the-SNMP polling and traps are sent to the Network Management Station through the virtual router interface.

Maximum Number of Virtual Routers By Device Model

The maximum number of virtual routers you can create depends on the device model. The following table provides the maximum limits. You can double-check on your system by entering the **show vrf counters** command, which shows the maximum number of user-defined virtual routers for that platform not including the global virtual router. The numbers in the table below include user and global routers. For the Firepower 9300, these numbers apply to native mode.

For platforms that support multi-instance capability, such as the Firepower 9300, determine the maximum number of virtual routers per container instance by dividing the maximum virtual routers by the number of cores on the device, and then multiplying by the number of cores assigned to the instance, rounding down to the nearest whole number. For example, if the platform supports a maximum of 100 virtual routers, and it has

70 cores, then each core would support a maximum of 1.43 virtual routers (rounded). Thus, an instance assigned 6 cores would support 8.58 virtual routers, which rounds down to 8, and an instance assigned 10 cores would support 14.3 virtual routers (rounding down, 14).

Device Model	Maximum Virtual Routers
Firepower 1010	5
Firepower 1120	5
Firepower 1140	10
Firepower 1150	10
Secure Firewall 1210CE/1210CP	5
Secure Firewall 1220CX	10
Secure Firewall 3105	10
Secure Firewall 3110	15
Secure Firewall 3120	25
Secure Firewall 3130	50
Secure Firewall 3140	100
Firepower 4112	60
Firepower 4115	80
Firepower 4125	100
Firepower 4145	100
Secure Firewall 4215	100
Secure Firewall 4225	100
Secure Firewall 4245	100
Firepower 9300 appliance, all models	100
Threat Defense Virtual, all platforms	30
ISA 3000	10

Related Topics

[Requirements and Prerequisites for Container Instances](#)

Requirements and Prerequisites for Virtual Routers

Model Support

Threat Defense

Supported Domains

Any

User Roles

Admin

Network Admin

Security Approver

Guidelines and Limitations for Virtual Routers

Firewall Mode Guidelines

Virtual routers are supported on routed firewall mode only.

Interface Guidelines

- You can assign an interface to only one virtual router.
- A virtual router can have any number of interfaces that are assigned to it.
- You can assign only routed interfaces with logical names and VTIs to a user-defined virtual router.
- If you want to change a virtual router interface to a non-routed mode, remove the interface from the virtual router, and then change its mode.
- You can assign an interface to a virtual router, either from a global virtual router or from another user-defined virtual router.
- The following interfaces cannot be assigned to an user-defined virtual router:
 - Members of EtherChannel.
 - Members of Redundant interfaces.
 - Members of BVI.
- VTI is a route-based VPN. So, when the tunnel is established, the traffic that uses VTI for encryption must be controlled through routing. Static routing, as well as dynamic routing with BGP, OSPFv2/v3, or EIGRP is supported.
- You cannot use interfaces that belong to user-defined virtual routers in policy-based site-to-site or remote access VPNs.

- A dynamic VTI and its corresponding protected network interface must be part of the same virtual router.
- You must map the borrow IP interface and the dynamic VTI to the same virtual router.
- User-defined virtual routers support only BGPv4/v6 and OSPFv2 routing protocols.
- A tunnel source interface can be in a different user-defined virtual router than that associated with the dynamic VTI.
- If a route using the interface that is being moved or its virtual router is deleted, exist in source or destination virtual router table, remove the routes before the interface movement or virtual router deletion.
- As separate routing tables are maintained for each virtual router, when an interface is moved from one virtual router to another virtual router, be it global or user-defined, the system removes the IP address configured on the interface temporarily. All existing connections on the interface are terminated. Thus, moving interfaces between virtual routers have drastic effect on the network traffic. Hence take precautionary measures before you move interfaces.

Global Virtual Router Guidelines

- The interfaces which are named and not part of other virtual routers, are part of the global virtual router.
- You cannot remove routed interfaces from global virtual router.
- You cannot modify global virtual router.
- Generally, after configuring interfaces, if you un-register and register back to same or another management center, interface configuration is imported back from device. With virtual router support, there is a restriction—the IP address for only global virtual router interfaces is retained.

Clustering Guidelines

- When the control unit link fails due to failure of its interfaces, the unit removes all leaked routes of its interfaces from the global routing table and propagates the inactive connected and static routes to other units of the cluster. This results in removal of those leaked routes from the routing table in other units. These removal takes place prior to another unit becoming a new control unit, which takes approximately 500 ms. When another unit becomes the new control unit, these routes are learned and added back to the routing tables through BGP convergence. Thus, till the convergence time, approximately one minute, the leaked routes are not available for the routing events to take place.
- When a control role change occurs in a cluster, the leaked routes learnt through BGP is updated with the best ECMP path. However, the non-best ECMP path is removed from the cluster routing table only after the BGP reconvergence timer elapses, that is 210 seconds. Thus, till the BGP reconvergence timer elapse, the old, non-best ECMP path persist as preferred route for routing events.

Additional Guidelines

- While configuring BGP for virtual routers, you can redistribute the routes belonging to different protocols within the same virtual routers. For example, OSPF VR2 routes cannot be imported into BGP VR1. You can only redistribute OSPF VR2 into BGP VR2, and then configure a route leak between BGP VR2 and BGP VR1.
- You cannot use IPv6 ACL for filtering the routes in the route map. Only prefix list is supported.

- **Security Intelligence Policy**—The Security Intelligence policy is not virtual-router-aware. If you add an IP address, URL, or DNS name to the block list, it is blocked for all virtual routers. This limitation is applicable on the interface having security zones.
- **NAT Rules**—Do not mix interfaces in NAT rules. In virtual routing, if the specified source and destination interface objects (interface groups or security zones) have interfaces that belong to different virtual routers, the NAT rule diverts traffic from one virtual router through another virtual router. The NAT does the route lookup in the virtual router table for the inbound interface only. If necessary, define static routes in the source virtual router for the destination interface. If you leave the interface as **any**, the rule applies to all interfaces regardless of virtual router membership.
- **DHCP Relay**—Interconnecting virtual routers for DHCP relay is not supported. For example, if DHCP relay client is enabled on VR1 interface and DHCP relay server is enabled on VR2 interface, the DHCP requests will not be forwarded outside of VR2 interface.
- **Recreating a deleted virtual router**—When you recreate a virtual router that was deleted less than 10 seconds earlier, an error message appears stating that deletion of the virtual router is in progress. If you want to recreate a deleted virtual router successively, use a different name for the new virtual router.

Modifications to the Management Center Web Interface - Routing Page

Devices earlier to the threat defense 6.6 and few device models are not supported with virtual routing capability. The management center web interface displays the same Routing page of the management center 6.5 or earlier version for such non supported devices. To know the supported devices and platform for virtual routing, see [Maximum Number of Virtual Routers By Device Model](#).

You can configure virtual routers in the routing page of a supported device:

1. Navigate to **Devices > Device Management** and edit the virtual-router-aware device.
2. Click **Routing** to enter the virtual routers page.

For devices using virtual routing, the left pane of the Routing page displays the following:

- **Manage Virtual Routers**—allows you to create and manage virtual routers.
- **List of virtual routing protocols**—lists routing protocols that you can configure for the virtual routers.
- **General Settings**—allows you to configure BGP general settings that are applicable for all the virtual routers. Select the **Enable BGP** check box in order to define other BGP settings. To configure other BGP settings for a virtual router, navigate to **BGP** in the virtual routing protocols .

Manage Virtual Routers

When you click **Manage Virtual Routers** on the Virtual Routers pane, the Manage Virtual Routers page appears. This page displays the existing virtual routers on the device and the associated interfaces. In this page, you can **Add Virtual Router** (+) to the device. You can also **Edit** (✎) and **Delete** (🗑) user-defined

virtual routers. You cannot edit or remove a global virtual router. You can only **View** (👁) the details of a global virtual router.

Create a Virtual Router

Procedure

Step 1 Choose **Devices > Device Management**, and edit the threat defense device.

Step 2 Click **Routing**.

Step 3 Click **Manage Virtual Routers**.

Step 4 Click **Add Virtual Router** (+).

Step 5 In the Add Virtual Router box, enter a name and description for the virtual router.

Note If you are creating a virtual router that was deleted less than 10 seconds earlier, an error message appears stating that deletion of the virtual router is in progress. If you want to create a deleted virtual router successively, use a different name for the new virtual router.

Step 6 Click **Ok**.

The Routing page appears, displaying the newly created virtual router page.

What to do next

- [Configure a Virtual Router](#).

Configure a Virtual Router

You can assign interfaces to a user-defined virtual router and configure the routing policies for the device. Though you cannot manually add or remove interfaces for a global virtual router, you can configure the routing policies for the device interfaces.

Before you begin

- To configure routing policies for a user-defined virtual router, add a router. See [Create a Virtual Router, on page 12](#).
- All routing configuration settings of a non-virtual routing capable device are also available for a global virtual router. For information on the settings, see [Routing Settings](#).
- Only limited routing protocols are supported for a user-defined virtual router.

Procedure

- Step 1** From the **Devices > Device Management** page, edit the virtual-router supported device. Navigate to **Routing**. For information on the modifications to the routing page, see [Modifications to the Management Center Web Interface - Routing Page, on page 11](#).
- Step 2** From the drop-down list, select the desired virtual router.
- Step 3** In the **Virtual Router Properties** page, you can modify the description.
- Step 4** To add interfaces, select the interface under the **Available Interfaces** box, and then click **Add**.

Remember the following:

- Only interfaces with a logical name are listed under the **Available Interfaces** box. You can edit the interface and provide a logical name in **Interfaces**. Remember to save the changes for the settings to take effect.
- Only interfaces of global virtual routers are available for assigning; the **Available Interfaces** box lists only interfaces that are not assigned to any other user-defined virtual routers. You can assign physical interfaces, subinterfaces, redundant interfaces, bridge groups, VTIs, and EtherChannels to a virtual router, but not their member interfaces. Because the member interfaces cannot be named, they cannot be used in virtual routing.

You can assign the diagnostic interface to the global virtual router only.

- Step 5** To save the settings, click **Save**.
- Step 6** To configure the routing policy for the virtual router, click the respective names to open the corresponding settings page:
- **OSPF**—Only OSPFv2 is supported on the user-defined virtual router. All other settings for OSPFv2 are as applicable as for a non-virtual-router-aware interface, except that **Interface** allows you to select only the interfaces of the virtual router that you are configuring. You can define the OSPFv3 and OSPFv2 routing policies for a global virtual router. For information on the OSPF settings, see [OSPF](#).
 - **RIP**—You can configure RIP routing policies only for a global virtual router. For information on RIP settings, see [RIP](#).
 - **BGP**—This page displays the BGP general settings that you have configured in **Settings**:
 - You cannot modify any of those general settings on this page, except for the router ID settings. You can override the router ID settings that were defined in the **Settings** page by editing them on this page.
 - To configure other BGP IPv4 or IPv6 settings, you must enable the BGP option in **BGP** page under **General Settings**.
 - BGP configuration for both IPv4 and IPv6 address family are supported for global router and the user-defined virtual router.

For information on configuring BGP settings, see [BGP](#).

- **Static Route**—Use this setting to define where to send traffic for a specific destination network. You can also use this setting to create an inter-virtual-router static route. You can create a leak of connected or static route by using the interfaces of user-defined or global virtual routers. **FMC prefixes** to an

interface to indicate that it is belonging to another virtual router and can be used for a route leak. For the route leak to be successful, do not specify next hop gateway.

The Static Route table displays the virtual router whose interface is used for a route leak in the **Leaked from Virtual Router** column. If it is not a route leak, the column displays N/A.

Irrespective of which virtual router the static route belongs, a Null0 interface is listed along with the interfaces of the same virtual router to which the static route belongs.

For information on static route settings, see [Static and Default Routes](#).

- **Multicast**—You can configure multicast routing policies only for a global virtual router. For information on multicast settings, see [Multicast](#).

Step 7 To save the settings, click **Save**.

What to do next

- [Modify a Virtual Router](#).
- [Remove Virtual Routers](#).

Modify a Virtual Router

You can modify the description and other routing policies of a virtual router.

Procedure

Step 1 Choose **Devices > Device Management**, and edit the threat defense device.

Step 2 Click **Routing**.

Step 3 Click **Manage Virtual Routers**.

All virtual routers along with the assigned interfaces are displayed in the **Virtual Routers** page.

Step 4 To modify a virtual router, click **Edit** (✎) against the desired virtual router.

Note You cannot modify the general settings of the global virtual router. Hence, edit is not available for the global router; instead a **View** (👁) is provided to view the settings.

Step 5 To save the changes, click **Save**.

What to do next

- [Remove Virtual Routers](#).

Remove Virtual Routers

Before you begin

- You cannot delete the Global virtual router. Hence, the delete option is not available for the Global virtual router.
- You can remove multiple virtual routers at a time.
- All the routing policies of the deleted virtual router are also deleted.
- All the interfaces of the deleted virtual router move to the global virtual router.
- If there are any restrictions on the movement of interfaces, such as overlapping IPs, route conflicts, and so on, you can remove the router only after resolving the conflicts.

Procedure

Step 1 Choose **Devices > Device Management**, and edit the threat defense device.

Step 2 Click **Routing**.

Step 3 Click **Manage Virtual Routers**.

All virtual routers along with the mapped interfaces are displayed in the **Virtual Routers** page.

Step 4 To remove a virtual router, click **Delete** () against the desired virtual router.

Step 5 To remove multiple routers, holding the CTRL key, click the virtual routers that you want to delete. Right-click, and then click **Delete**.

Step 6 To save the changes, click **Save**.

Monitoring Virtual Routers

To monitor and troubleshoot virtual routers, log into the device CLI and use the following commands:

- **show vrf**: Displays the details of the virtual routers and their associated interfaces.
- **show route vrf <vrf_name>**: Displays the routing details of a virtual router.
- **show run router bgp all**: Displays the BGP routing details of all virtual router.
- **show run router bgp vrf <vrf_name>**: Displays the BGP routing details of a virtual router.
- **show crypto ipsec sa/show crypto ikev2 sa**: Displays the details of the tunnel and the associated virtual router.
- You can monitor the tunnels in the Site-to site monitoring dashboard (**Overview > Site to Site VPN**).

In the **Tunnel Status** widget, hover over a topology, click View  and click **Packet Tracer** to view and troubleshoot the threat defense VPN tunnels.

Configuration Examples for Virtual Routers

How to Route to a Distant Server through Virtual Routers

In virtual routing, you can create multiple virtual routers to maintain separate routing tables for groups of interfaces, thereby achieve network separation. In some scenarios, you may need to access a server that is reachable only through a separate virtual router. This example provides the procedure that interconnects virtual routers to reach to a host that is multiple hops away.

Consider an example, where a member of the sales department of a garment company wants to look up at the stock maintained by the warehousing department of its factory unit. In a virtual routing environment, you need to leak route between virtual routers where destination (warehousing department) is multiple hops away from sales department. This route leaking is done by adding multihop route leak, where, you configure a static route in Sales virtual router(source) to an interface in Warehouse virtual router (destination). As the destination network is multi-hop away, you also need to configure the Warehouse virtual router with the route to the destination network, namely 10.50.0.0/24.

Figure 1: Interconnecting Two Virtual Routers - An Example

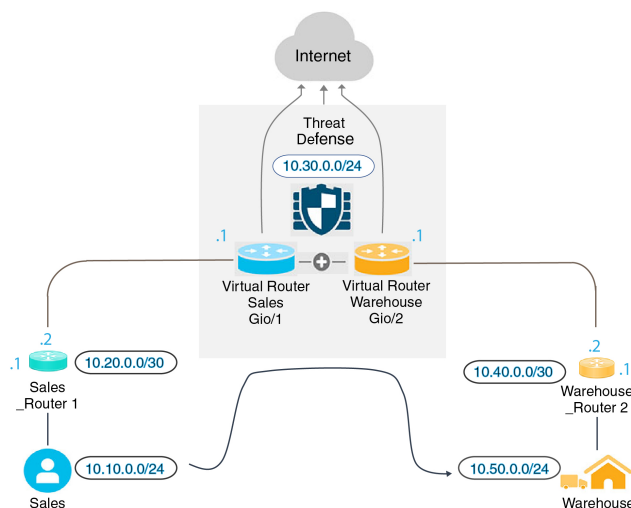

Before you begin

This example assumes that you have already configured Sales_Router1 to route traffic from 10.20.0.1/30 interface to 10.50.0.5/24.

Procedure

- Step 1** Configure the inside interface (Gi0/1) of the device to be assigned to Sales virtual router:
- Choose **Devices > Device Management > Interfaces**.
 - Edit the Gi0/1 interface:
 - Name**—For this example, VR-Sales.

- Select the **Enabled** checkbox.
- In **IPV4**, for **IP Type**, choose **Use Static IP**.
- **IP Address**—Enter 10.30.0.1/24.

- c) Click **Ok**.
- d) Click **Save**.

Step 2 Configure the inside interface (Gi0/2) of the device to be assigned to Warehouse virtual router:

- a) Choose **Devices > Device Management > Interfaces**.
- b) Edit the Gi0/2 interface:
 - **Name**—For this example, VR-Warehouse.
 - Select the **Enabled** checkbox.
 - In **IPV4**, for **IP Type**, choose **Use Static IP**.
 - **IP Address**—Leave it blank. The system does not allow you to configure interfaces with same IP address (10.30.0.1/24), as you are yet to create user-defined virtual routers.
- c) Click **Ok**.
- d) Click **Save**.

Step 3 Create Sales and Warehouse virtual routers and assign their interfaces:

- a) Choose **Devices > Device Management**, and edit the threat defense device.
- b) Choose **Routing > Manage Virtual Routers**.
- c) Click **Add Virtual Router** and create Sales.
- d) Click **Add Virtual Router** and create Warehouse.
- e) Select Sales from virtual router drop-down, in **Virtual Router Properties**, add VR-Sales as **Selected Interface** and save.
- f) Select Warehouse from virtual router drop-down, in **Virtual Router Properties**, add VR-Warehouse as **Selected Interface** and save.

Step 4 Revisit the VR-Warehouse interface configuration:

- a) Choose **Devices > Device Management > Interfaces**.
- b) Click **Edit** against VR-Warehouse interface. Specify the IP Address as 10.30.0.1/24. The system now allows you to configure with same IP address of VR-Sales, because the interfaces are separately assigned to two different virtual routers.
- c) Click **Ok**.
- d) Click **Save**.

Step 5 Create network objects for the warehouse server—10.50.0.0/24, and for the warehouse gateway— 10.40.0.2/30:

- a) Choose **Object > Object Management**.
- b) Choose **Add Network > Add Object**:
 - **Name**—For this example, Warehouse-Server.
 - **Network**—Click Network and enter 10.50.0.0/24.
- c) Click **Save**.
- d) Choose **Add Network > Add Object**:

- **Name**—For this example, Warehouse-Gateway.
- **Network**—Click Host and enter 10.40.0.2.

e) Click **Save**.

Step 6 Define the route leak in Sales that points to the VR-Warehouse interface:

- Choose **Devices > Device Management**, and edit the threat defense device.
- Choose **Routing**.
- Choose Sales virtual router from the drop-down, and then click **Static Route**.
- Click **Add Route**. In **Add Static Route Configuration**, specify the following:
 - **Interface**—Select VR-Warehouse.
 - **Network**—Select the Warehouse-Server object.
 - **Gateway**—Leave it blank. When leaking a route into another virtual router, do not select the gateway.

Add Static Route Configuration

Type: IPv4 IPv6

Interface*
VR-Warehouse

Available Network

Q Search

any-ipv4
IPv4-Benchmark-Tests
IPv4-Link-Local
IPv4-Multicast
IPv4-Private-10.0.0.0-8
IPv4-Private-172.16.0.0-12

Selected Network
Warehouse-Server

Gateway*

Metric:
1
(1 - 254)

Tunneled: (Used only for default Route)

Route Tracking:

- Click **Ok**.
- Click **Save**.

Step 7 In the Warehouse virtual router, define the route that points to the Warehouse Router 2 gateway:

- Choose Warehouse virtual router from the drop-down, and then click **Static Route**.
- Click **Add Route**. In **Add Static Route Configuration**, specify the following:
 - **Interface**—Select VR-Warehouse.

- **Network**—Select the Warehouse-Server object.
- **Gateway**—Select the Warehouse-Gateway object.

Add Static Route Configuration ?

Type: IPv4 IPv6

Interface*
 VR-Warehouse

Available Network +
 Search

- any-ipv4
- IPv4-Benchmark-Tests
- IPv4-Link-Local
- IPv4-Multicast
- IPv4-Private-10.0.0.0-8
- IPv4-Private-172.16.0.0-12

Add

Selected Network
 Warehouse-Server ✕

Ensure that egress virtualrouter has route to that destination

Gateway
 Warehouse-Gateway +

Metric:
 1
 (1 - 254)

Tunneled: (Used only for default Route)

Route Tracking:
 +

Cancel
OK

- c) Click **Ok**.
- d) Click **Save**.

Step 8 Configure access control rule that allows access to the warehouse server. For creating the access control rule, you need to create security zones. Use **Object > Object Management > Interface**. Choose **Add > Security Zone** and create security zones for VR-Sales and VR-Warehouse; for Warehouse-Server network object, create a Warehouse-Server interface group (Choose **Add > Interface Group**).

Step 9 Choose **Policies > Access Control** and configure an access control rule to allow traffic from the source interfaces in the Sales virtual router to the destination interfaces in the Warehouse virtual router for the destination Warehouse-Server network object.

For example, if the interfaces in Sales are in the Sales-Zone security zone, and those in Warehouse are in the Warehouse-Zone security zone, the access control rule would look similar to the following:

SalesWarehouse														Analyze Hit Counts	Save				
Enter Description														Inheritance Settings Policy Assign					
Rules														Prefilter Policy: Default Prefilter Policy		SSL Policy: None		Identity P	
Filter by Device														Search Rules		Show Rule Conflicts		Add Category	
Name	Source Zones	Dest Zones	Source Networks	Dest Networks	VLAN Tags	Users	Applicat...	Source Ports	Dest Ports	URLs	Source SGT	Dest SGT	Action						
Mandatory - SalesWarehouse (1-1)																			
1	Warehouse-Rule	Sales-Zone	Warehouse-Zone	Any	10.50.0.5	Any	Any	Any	Any	Any	Any	Any	Allow						

How to Provide Internet Access with Overlapping Address Spaces

When using virtual routers, you can have the same network address for interfaces that reside in separate routers. However, because the IP addresses routed in these separate virtual routers are the same, apply NAT/PAT rules for each interface with separate NAT/PAT pools to ensure that return traffic goes to the correct destination. This example provides the procedure to configure the virtual routers and NAT/PAT rules to manage the overlapping address spaces.

For example, interfaces vr1-inside and vr2-inside on threat defense is defined to use the IP address 192.168.1.1/24, managing endpoints on their segment in the 192.168.1.0/24 network. To allow Internet access from two virtual routers that use the same address space, you need to apply NAT rules separately to the interfaces within each virtual router, ideally using separate NAT or PAT pools. You could use PAT to translate the source addresses in VR1 to 10.100.10.1, and for those in VR2, to 10.100.10.2. The following illustration shows this setup, where the Internet-facing outside interface is part of the global router. You must define the NAT/PAT rules with the source interface (vr1-inside and vr2-inside) explicitly selected—using “any” as the source interface makes it impossible for the system to identify the correct source because the same IP address could exist on two different interfaces.

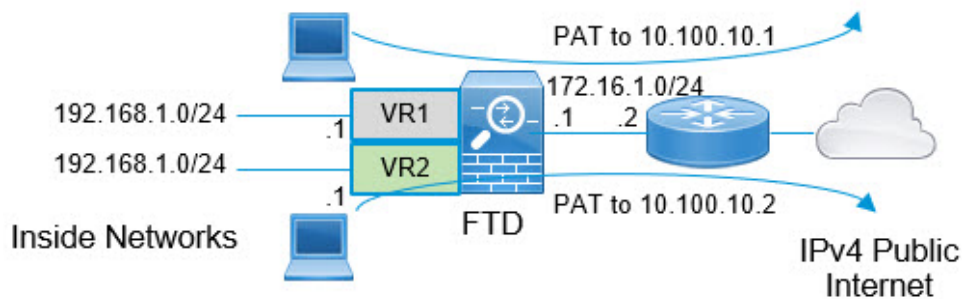

Note Even if you have some interfaces within virtual routers that does not use overlapping address spaces, define the NAT rule with the source interface to make troubleshooting easier, and to ensure a cleaner separation between traffic from the virtual routers that is Internet-bound.

Procedure

Step 1 Configure the inside interface of the device for VR1:

- a) Choose **Devices > Device Management > Interfaces**.
- b) Edit the interfaces that you want to assign to VR1:
 - **Name**—For this example, vr1-inside.
 - Select the **Enabled** checkbox.
 - In **IPv4**, for **IP Type**, choose **Use Static IP**.
 - **IP Address**—Enter 192.168.1.1/24.
- c) Click **Ok**.
- d) Click **Save**.

Step 2

Configure the inside interface of the device for VR2:

- a) Choose **Devices > Device Management > Interfaces**.
- b) Edit the interfaces that you want to assign to VR2:
 - **Name**—For this example, vr2-inside.
 - Select the **Enabled** checkbox.
 - In **IPv4**, for **IP Type**, choose **Use Static IP**.
 - **IP Address**—Leave it blank. The system does not allow you to configure interfaces with same IP address, as you are yet to create user-defined virtual routers.
- c) Click **Ok**.
- d) Click **Save**.

Step 3

Configure VR1 and the static default route leak to the outside interface:

- a) Choose **Devices > Device Management**, and edit the threat defense device.
- b) Choose **Routing > Manage Virtual Routers**. Click **Add Virtual Router** and create VR1.
- c) For VR1, in **Virtual Router Properties**, assign vr1-inside and save.
- d) Click **Static Route**.
- e) Click **Add Route**. In **Add Static Route Configuration**, specify the following:
 - **Interface**—Select the outside interface of the global router.
 - **Network**—Select the any-ipv4 object. This network is the default route for any traffic that cannot be routed within VR1.
 - **Gateway**—Leave it blank. When leaking a route into another virtual router, do not provide a Gateway.

Add Static Route Configuration ?

Type: IPv4 IPv6

Interface*

(Interface starting with this icon  signifies it is available for route leak)

Available Network Selected Network

any-ipv4 

IPv4-Benchmark-Tests

IPv4-Link-Local

IPv4-Multicast

IPv4-Private-10.0.0.0-8

IPv4-Private-172.16.0.0-12

Ensure that egress virtualrouter has route to that destination

Gateway +

Metric:

 (1 - 254)

Tunneled: (Used only for default Route)

Route Tracking:
 +

- f) Click **Ok**.
- g) Click **Save**.

Step 4

Configure VR2 and the static default route leak to the outside interface:

- a) Choose **Devices > Device Management**, and edit the threat defense device.
- b) Choose **Routing > Manage Virtual Routers**. Click **Add Virtual Router** and create VR2.
- c) For VR2, in **Virtual Router Properties**, assign vr2-inside and save.
- d) Click **Static Route**.
- e) Click **Add Route**. In **Add Static Route Configuration**, specify the following:
 - **Interface**—Select the outside interface of the global router.
 - **Network**—Select the any-ipv4 object. This network is the default route for any traffic that cannot be routed within VR2.
 - **Gateway**—Leave it blank. When leaking a route into another virtual router, do not select the Gateway.

Add Static Route Configuration

Type: IPv4 IPv6

Interface*

(Interface starting with this icon  signifies it is available for route leak)

Available Network  + Selected Network

- any-ipv4
- IPv4-Benchmark-Tests
- IPv4-Link-Local
- IPv4-Multicast
- IPv4-Private-10.0.0.0-8
- IPv4-Private-172.16.0.0-12

any-ipv4

Ensure that egress virtualrouter has route to that destination

Gateway

Metric:

(1 - 254)

Tunneled: (Used only for default Route)

Route Tracking:

- f) Click **Ok**.
- g) Click **Save**.

Step 5

Configure IPv4 static default route, namely 172.16.1.2 on the outside interface of the global router:

- a) Choose **Devices > Device Management**, and edit the threat defense device.
- b) Choose **Routing** and edit global router properties.
- c) Click **Static Route**.
- d) Click **Add Route**. In **Add Static Route Configuration**, specify the following:
 - **Interface**—Select the outside interface of the global router.
 - **Network**—Select the any-ipv4 object. This will be the default route for any IPv4 traffic.
 - **Gateway**—If already created, select the host name from the drop-down. If the object is not yet created, click **Add** and define the host object for the IP address of the gateway at the other end of the network link on the outside interface, in this example, 172.16.1.2. After you create the object, select it in the Gateway field.

Add Static Route Configuration

Type: IPv4 IPv6

Interface*

(Interface starting with this icon  signifies it is available for route leak)

Available Network  +

- any-ipv4
- IPv4-Benchmark-Tests
- IPv4-Link-Local
- IPv4-Multicast
- IPv4-Private-10.0.0.0-8
- IPv4-Private-172.16.0.0-12

Selected Network

Gateway*
 +

Metric:

 (1 - 254)

Tunneled: (Used only for default Route)

Route Tracking:

- e) Click **Ok**.
- f) Click **Save**.

Step 6

Revisit the vr2-inside interface configuration:

- a) Choose **Devices > Device Management > Interfaces**.
- b) Click **Edit** against vr2-inside interface. Specify the IP Address as 192.168.1.1/24. The system now allows you to configure with same IP address of vr1-inside, because the interfaces are separately assigned to two different virtual routers.
- c) Click **Ok**.
- d) Click **Save**.

Step 7

Create the NAT rule to PAT inside to outside traffic of VR1 to 10.100.10.1.

- a) Choose **Devices > NAT**.
- b) Click **New Policy**.
- c) Enter InsideOutsideNATRule as the NAT policy name, and select the threat defense device. Click **Save**.
- d) In InsideOutsideNATRule page, click **Add Rule** and define the following:
 - **NAT Rule**—Select Manual NAT Rule.

- **Type**—Select Dynamic.
- **Insert**—Above, if any dynamic NAT rule exists.
- Click **Enabled**.
- In **Interface Objects**, select vr1-interface object and click **Add to Source** (If the object is not available, create one in **Object > Object Management > Interface**), and select outside as **Add to Destination**.
- In **Translation**, for **Original Source**, select any-ipv4. For **Translated Source**, click **Add** and define host object VR1-PAT-Pool with 10.100.10.1. Select VR1-PAT-Pool as shown in the figure below:

NAT Rule:
Manual NAT Rule

Insert:
In Category NAT Rules Before

Type:
Static

Enable

Description:

Interface Objects Translation PAT Pool Advanced

Original Packet	Translated Packet
Original Source:* any-ipv4 +	Translated Source: Address +
Original Destination: Address +	Translated Destination: VR1-PAT-Pool +
Original Source Port: +	Translated Source Port: +
Original Destination Port: +	Translated Destination Port: +

Cancel OK

- e) Click **Ok**.
- f) Click **Save**.

Step 8

Add NAT rule to PAT inside to outside traffic of VR2 to 10.100.10.2.

- a) Choose **Devices > NAT**.
- b) Edit InsideOutsideNATRule to define the VR2 NAT rule:
 - **NAT Rule**—Select Manual NAT Rule.
 - **Type**—Select Dynamic.
 - **Insert**—Above, if any dynamic NAT rule exists.
 - Click **Enabled**.
 - In **Interface Objects**, select vr2-interface object and click **Add to Source** (If the object is not available, create one in **Object > Object Management > Interface**), and select outside as **Add to Destination**.

- In **Translation**, for **Original Source**, select any-ipv4. For **Translated Source**, click **Add** and define host object VR2-PAT-Pool with 10.100.10.2. Select VR2-PAT-Pool as shown in the figure below:

The screenshot shows the configuration for a NAT Rule. The 'NAT Rule' dropdown is set to 'Manual NAT Rule'. Under 'Insert', 'In Category' is set to 'In Category' and 'NAT Rules Before' is set to 'NAT Rules Before'. The 'Type' is set to 'Static'. The 'Enable' checkbox is checked. The 'Description' field is empty. The 'Translation' tab is selected, showing the following configuration:

Original Packet	Translated Packet
Original Source:* any-ipv4 +	Translated Source: Address +
Original Destination: Address +	Translated Destination: VR2-PAT-Pool +
Original Source Port: +	Translated Source Port: +
Original Destination Port: +	Translated Destination Port: +

At the bottom right, there are 'Cancel' and 'OK' buttons.

- Click **Ok**.
- Click **Save**.

Step 9 To configure the access control policy that allows traffic from the vr1-inside and vr2-inside interfaces to the outside interface, you need to create security zones. Use **Object > Object Management > Interface**. Choose **Add > Security Zone** and create security zones for vr1-inside, vr2-inside, and outside interfaces.

Step 10 Choose **Policies > Access Control** and configure an access control rule to allow traffic from vr1-inside-zone and vr2-inside-zone to outside-zone.

Assuming that you create zones named after the interfaces, a basic rule that allows all traffic to flow to the Internet will look like the following. You can apply other parameters to this access control policy:

Add Rule

Name: AllowInternetTraffic Enabled

Insert: into Mandatory

Action: Allow

Time Range: +

Zones Networks VLAN Tags **Users** Applications Ports URLs SGT/ISE Attributes

Available Zones

- outside-zone
- vr1-inside-zone
- vr2-inside-zone

Source Zones (2)

- vr1-inside-zone
- vr2-inside-zone

How to Allow RA VPN Access to Internal Networks in Virtual Routing

On virtual routing-enabled devices, RA VPN is supported only on global virtual router interfaces. This example provides the procedure that allows your Secure Client user to connect to user-defined virtual router networks.

In the following example, the RA VPN (Secure Client) user connects to the outside interface of threat defense at 172.16.3.1, and is given an IP address within the pool of 192.168.80.0/24. The user can access the inside network of only the global virtual router. To allow traffic flow through the network of the user-defined virtual router VR1, namely 192.168.1.0/24, leak the route by configuring the static routes on global and VR1.

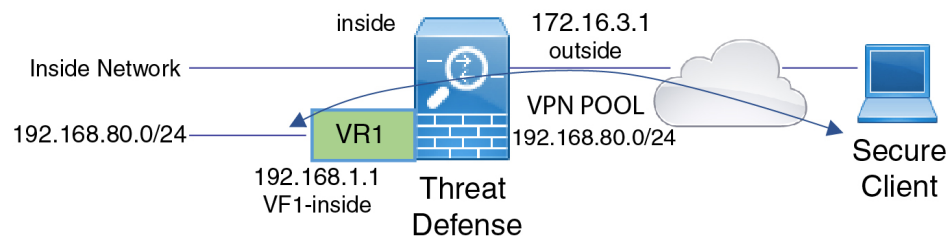

Before you begin

This example assumes that you have already configured the RA VPN, defined the virtual routers, and configured and assigned the interfaces to the appropriate virtual routers.

Procedure

Step 1

Configure route leak from Global virtual router to the user-defined VR1:

- Choose **Devices > Device Management**, and edit the threat defense device.
- Click **Routing**. By default, the Global routing properties page appears.
- Click **Static Route**.
- Click **Add Route**. In **Add Static Route Configuration**, specify the following:
 - **Interface**—Select the VR1 inside interface.
 - **Network**—Select the VR1 virtual router network object. You can create one using the **Add Object** option.
 - **Gateway**—Leave it blank. When leaking a route into another virtual router, does not select the gateway.

The screenshot shows the 'Add Static Route Configuration' dialog box. At the top, the title is 'Add Static Route Configuration' with a help icon. Below the title, there are several fields and sections:

- Type:** Radio buttons for IPv4 (selected) and IPv6.
- Interface*:** A dropdown menu showing 'vr1-inside'.
- Available Network:** A search box with a magnifying glass icon and a list of network objects. The list includes:
 - IPv4-Private-10.0.0.0-8
 - IPv4-Private-172.16.0.0-12
 - IPv4-Private-192.168.0.0-16
 - IPv4-Private-All-RFC1918
 - IPv6-to-IPv4-Relay-Anycast
 - nw-192.168.1.0** (highlighted in blue)
- Selected Network:** A box containing 'nw-192.168.1.0' with a trash icon.
- Gateway*:** A dropdown menu that is currently blank.
- Metric:** A text input field containing the number '1'. Below it, the range '(1 - 254)' is shown.
- Tunneled:** A checkbox that is unchecked, with the text '(Used only for default Route)' next to it.
- Route Tracking:** A dropdown menu that is currently blank.

At the bottom right of the dialog, there are two buttons: 'Cancel' and 'OK'.

The route leak allows Secure Client assigned IP addresses in the VPN pool to access the 192.168.1.0/24 network in the VR1 virtual router.

e) Click **Ok**.

Step 2 Configure the route leak from VR1 to the Global virtual router:

- a) Choose **Devices > Device Management**, and edit the threat defense device.
- b) Click **Routing** and from the drop-down, select VR1.
- c) Click **Static Route**.
- d) Click **Add Route**. In **Add Static Route Configuration**, specify the following:
 - **Interface**—Select the outside interface of the global router.
 - **Network**—Select the global virtual router network object.
 - **Gateway**—Leave it blank. When leaking a route into another virtual router, does not select the gateway.

Add Static Route Configuration

Type: IPv4 IPv6

Interface*
outside

Available Network +

- outside-gateway
- vpn-pool**
- vr1-inside
- VR1-PAT-Pool
- vr2-inside
- VR2-PAT-Pool

Selected Network

- vpn-pool

Gateway*
+

Metric:
1
(1 - 254)

Tunneled: (Used only for default Route)

Route Tracking:
+

Cancel OK

The configured static route allows endpoints on the 192.168.1.0/24 network (VR1) to initiate connections to Secure Client assigned IP addresses in the VPN pool.

e) Click **Ok**.

What to do next

If RA VPN address pool and the IP addresses in the user-defined virtual router overlap, you must also use static NAT rules on the IP addresses to enable proper routing. Alternatively, you can change your RA VPN address pool so that there is no overlap.

How to Secure Traffic from Networks in Multiple Virtual Routers over a Site-to-Site VPN

On virtual routing-enabled devices, Site-to-Site VPN is supported only on global virtual router interfaces. You cannot configure it on an interface that belongs to a user-defined virtual router. This example provides the procedure that allows you to secure the connections from or to networks hosted within user-defined virtual routers over the site-to-site VPN. You also need to update the site-to-site VPN connection to include the user-defined virtual routing networks.

Let us consider a scenario, where, a site-to-site VPN is configured between a branch office network to a company headquarters network; the threat defense in the branch office having virtual routers. In this case, the site-to-site VPN is defined on the outside interface of the branch office at 172.16.3.1. This VPN includes the inside network 192.168.2.0/24 without extra configuration, because the inside interface is also part of the global virtual router. But, to provide site-to-site VPN services to the 192.168.1.0/24 network, which is part of the VR1 virtual router, you must leak the route by configuring the static routes on global and VR1, and add the VR1 network to the site-to-site VPN configuration.

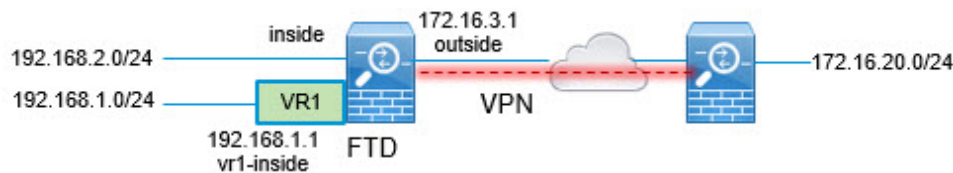

Before you begin

This example assumes that you have already configured the site-to-site VPN between the 192.168.2.0/24 local network and the 172.16.20.0/24 external network, defined the virtual routers, and configured and assigned the interfaces to the appropriate virtual routers.

Procedure

Step 1

Configure route leak from the Global virtual router to the user-defined VR1:

- Choose **Devices > Device Management**, and edit the threat defense device.
- Click **Routing**. By default, the Global routing properties page appears.
- Click **Static Route**.
- Click **Add Route**. In **Add Static Route Configuration**, specify the following:
 - **Interface**—Select the VR1 inside interface.
 - **Network**—Select the VR1 virtual router network object. You can create one using the **Add Object** option.
 - **Gateway**—Leave it blank. When leaking a route into another virtual router, do not select the gateway.

Add Static Route Configuration ?

Type: IPv4 IPv6

Interface*
vr1-inside

Available Network +

Search

IPv4-Private-10.0.0.0-8
IPv4-Private-172.16.0.0-12
IPv4-Private-192.168.0.0-16
IPv4-Private-All-RFC1918
IPv6-to-IPv4-Relay-Anycast
nw-192.168.1.0

Add

Selected Network

nw-192.168.1.0

Gateway*
+

Metric:
1
(1 - 254)

Tunneled: (Used only for default Route)

Route Tracking:
+

Cancel OK

The route leak allows endpoints protected by the external (remote) end of the site-to-site VPN to access the 192.168.1.0/24 network in the VR1 virtual router.

e) Click **Ok**.

Step 2

Configure the route leak from VR1 to the Global virtual router:

- a) Choose **Devices > Device Management**, and edit the threat defense device.
- b) Click **Routing** and from the drop-down, select VR1.
- c) Click **Static Route**.
- d) Click **Add Route**. In **Add Static Route Configuration**, specify the following:
 - **Interface**—Select the outside interface of the global router.
 - **Network**—Select the global virtual router network object.
 - **Gateway**—Leave it blank. When leaking a route into another virtual router, do not select the gateway.

Add Static Route Configuration

Type: IPv4 IPv6

Interface*
outside

Available Network  +

Search

any-ipv4
default-ipv4
external-vpn-nw
inside
IPv4-Benchmark-Tests
IPv4-Link-Local

Add

Selected Network
external-vpn-nw 

Gateway*
+

Metric:
1
(1 - 254)

Tunneled: (Used only for default Route)

Route Tracking:
+

Cancel OK

This static route allows endpoints on the 192.168.1.0/24 network (VR1) to initiate connections that will traverse the site-to-site VPN tunnel. For this example, the remote endpoint that is protecting the 172.16.20.0/24 network.

e) Click **Ok**.

Step 3

Add the 192.168.1.0/24 network to the site-to-site VPN connection profile:

- Choose **Devices > VPN > Site To Site**, and edit the VPN Topology.
- In **Endpoints**, edit Node A endpoint.
- In **Edit Endpoint**, in the **Protected Networks** field, click **Add New Network Object**.
- Add the VR1 network object with 192.168.1.0 network:

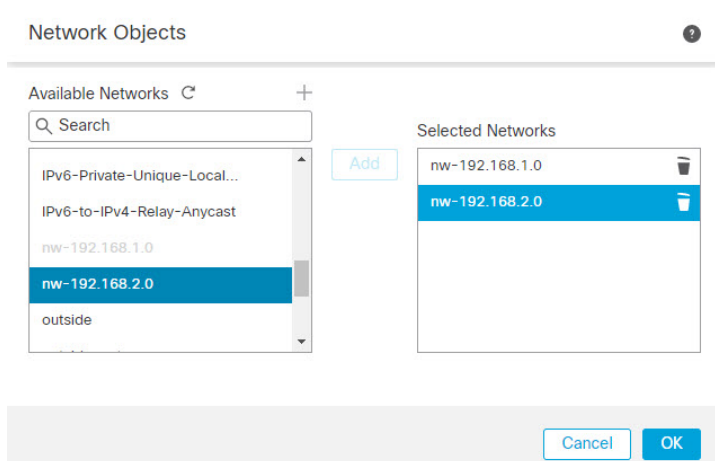

- e) Click **Ok** and save the configuration.

How to Secure Traffic from Networks with Multiple Virtual Routers over a Site-to-Site VPN with Dynamic VTI

ISPs have different segmented networks for different customers. You can create virtual routers, associate dynamic VTIs with these virtual routers, and extend the capabilities of dynamic VTIs in your network. You can associate dynamic VTIs either with global or user-defined virtual routers. A single threat defense device can act as a dynamic VTI hub with a global or one or more user-defined virtual routers. Each user-defined virtual router can be one customer network.

Let us consider an example where route-based site-to-site VPNs are configured between two company headquarter networks and their two branch office networks. The ISP's threat defense, a dynamic VTI hub, manages the two company headquarter networks with two user-defined virtual routers: VRF green and VRF red. The dynamic VTI hub establishes a site-to-site VPN between:

- Customer 1 (VRF green) and Branch 1 (SVTI spoke 1)
- Customer 2 (VRF red) and Branch 2 (SVT2 spoke 2)

Figure 2: Site-to-Site VPNs with Multiple Virtual Routers and Dynamic VTI

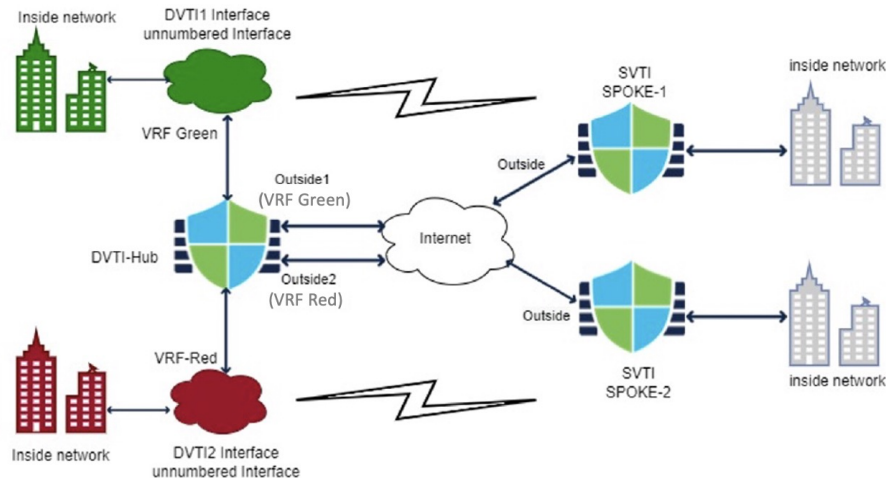

This example illustrates how to configure networks with multiple virtual routers over a site-to-site VPN with dynamic VTI.

Procedure

-
- Step 1** Configure a dynamic VTI interface on the hub.
- Choose **Devices > Device Management** and edit the threat defense device.
 - Choose **Add Interfaces > Virtual Tunnel Interface**.
 - Select the **Tunnel Type** as **Dynamic**.
 - Specify the interface name as DVTI1 and configure all the parameters for the dynamic VTI.
 - Click **Save**
 - Repeat steps 1a - e to configure the second dynamic VTI on the hub, DVTI2.
- Step 2** Configure static VTI on spoke 1.
- Choose **Devices > Device Management** and edit the threat defense device.
 - Choose **Add Interfaces > Virtual Tunnel Interface**.
 - Select the **Tunnel Type** as **Static**.
 - Specify the interface name as SVTI spoke-1 and configure all the parameters for the static VTI.
 - Click **Save**
 - Repeat steps 2a - e to configure the static VTI on spoke 2: SVTI spoke-2.
- Step 3** Configure a route-based site-to-site VPN between hub and SVTI spoke 1.
- Choose **Devices > Site To Site** and click + **Site To Site VPN**.
 - Enter a name for the VPN topology in the **Topology Name** field.
 - Choose **Route Based (VTI)** and select **Hub and Spoke** as the network topology.
 - Click the **Endpoints** tab.
 - Configure the hub and the spoke (DVTI1 and SVTI spoke-1) and their routing policies.
 - Configure the **IKE**, **IPsec**, and **Advanced** options for the VPN, if required.
 - Click **Save**.

- h) Repeat steps 3a - g to configure the second route-based site-to-site VPN topology between hub (DVTI2) and SVTI spoke 2.

Step 4 Configure the two virtual routers.

- a) Choose **Devices > Device Management** and edit the threat defense device.
- b) Click **Routing**.
- c) Click **Manage Virtual Routers**.
- d) Click **Add Virtual Router**.

Specify the name as VRF green and provide a description for the virtual router.

- e) Repeat steps 4a - d to configure VRF red.

Step 5 Assign all the interfaces to the virtual routers.

- a) From the drop-down list, select the virtual router.
- b) In the **Virtual Router Properties** page, select the interfaces listed under the **Available Interfaces** box.

Assign the dynamic VTI interface along with the other interfaces.

- c) Click **Add**.

Step 6 Repeat steps 5a - c for VRF red.

Step 7 Configure the routing policy for the virtual router.

- a) From the drop-down list, select the virtual router.
- b) Click **Static Route** or one of the dynamic routing protocols.
- c) Configure the routing parameters.
- d) Click **Save**.

What to do next

Select the hub and spoke devices and click **Deploy**. After the deployment, you can monitor the VPN tunnels in the Site-to-site monitoring dashboard (**Overview > Site to Site VPN**).

You can also use the commands listed in [Monitoring Virtual Routers, on page 15](#) to view and troubleshoot the virtual router.

How to Route Traffic between Two Overlapping Network Host in Virtual Routing

You can configure hosts on the virtual routers that have same network address. If the hosts want to communicate, you can configure twice NAT. This example provides the procedure to configure the NAT rules to manage the overlapping network host.

In the following example, two hosts Host A and Host B belong to different virtual routers: VRG (interface vrg-inside), VRB (interface vrb-inside) respectively with the same subnet 10.1.1.0/24. For both the hosts to communicate, create a NAT policy where, VRG-Host interface object would use a mapped NAT address - 20.1.1.1, and VRB-Host interface object would use a mapped NAT address - 30.1.1.1. Thus, Host A uses 30.1.1.1 to communicate to Host B; Host B uses 20.1.1.1 to reach Host A.

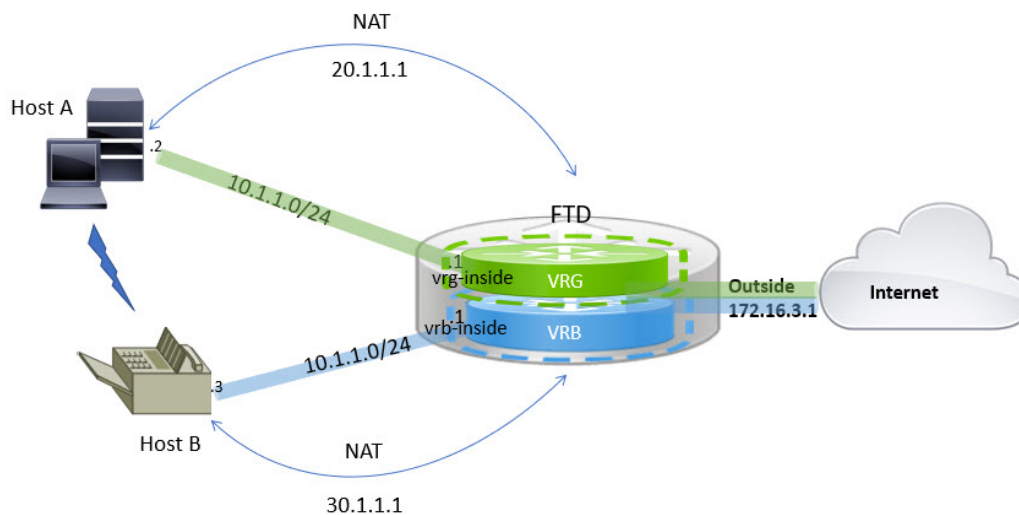

Before you begin

This example assumes that you have already configured:

- vrg-inside and vrb-inside interfaces are associated with virtual routers: VRG and VRB respectively and vrg-inside and vrb-inside interfaces configured with same subnet address (say, 10.1.1.0/24).
- Interfaces zones VRG-Inf, VRB-Inf created with vrg-inside and vrb-inside interfaces respectively.
- Host A in VRG with vrg-inside as default gateway; Host B in VRB with vrb-inside as default gateway.

Procedure

-
- Step 1** Create the NAT rule to handle traffic from Host A to Host B. Choose **Devices > NAT**.
- Step 2** Click **New Policy**.
- Step 3** Enter a NAT policy name, and select the threat defense device. Click **Save**.
- Step 4** In the NAT page, click **Add Rule** and define the following:
- **NAT Rule**—Select Manual NAT Rule.
 - **Type**—Select Static.
 - **Insert**—Select Above, if any NAT rule exists.
 - Click **Enabled**.
 - In **Interface Objects**, select VRG-Inf object and click **Add to Source** (If the object isn't available, create one in **Object > Object Management > Interface**), and select VRB-Inf object and click **Add to Destination**.
 - In **Translation**, select the following:
 - **Original Source**, select vrg-inside.
 - **Original Destination**, click **Add** and define object VRB-Mapped-Host with 30.1.1.1. Select VRB-Mapped-Host.

- **Translated Source**, click **Add** and define object, VRG-Mapped-Host with 20.1.1.1. Select VRG-Mapped-Host.
- **Translated Destination**, select vrb-inside as shown in the following figure:

Add NAT Rule ?

NAT Rule:
Manual NAT Rule

Insert:
In Category NAT Rules Before

Type:
Static

Enable
Description:

Interface Objects Translation PAT Pool Advanced

Original Packet	Translated Packet
Original Source:* vrg-inside +	Translated Source: Address +
Original Destination: Address +	Translated Destination: VRG-Mapped-Host +
Original Source Port: +	Translated Source Port: +
Original Destination Port: +	Translated Destination Port: +

Cancel OK

When you run the **show nat detail** command on the threat defense device, you will see an output similar to this:

```
firepower(config-service-object-group)# show nat detail
Manual NAT Policies (Section 1)
1 (2001) to (3001) source static vrg-inside VRG-MAPPED-HOST destination static VRB-MAPPED-HOST
  vrb-inside
translate_hits = 0, untranslate_hits = 0
Source - Origin: 10.1.1.1/24, Translated: 20.1.1.1/24
Destination - Origin: 30.1.1.1/24, Translated: 10.1.1.1/24
```

Step 5 Click **Ok**.

Step 6 Click **Save**.

The NAT rule looks like this:

Host2Host

Enter Description

Rules

Show Warnings Save Policy Assign

Filter by Device

#	Direction	Type	Source Interface Objects	Destination Interface Objects	Original Packet			Translated Packet			Options
					Original Sources	Original Destinations	Original Services	Translated Sources	Translated Destinations	Translated Services	
NAT Rules Before											
1		Static	VRG-Inf	VRB-Inf	vrg-inside	VRB-Mapped-Host		VRG-Mapped-Host	vrb-inside		Dns: false
Auto NAT Rules											
NAT Rules After											

When you deploy the configuration, a warning message appears:

Validation Messages: ✕

1 total | 0 errors | 1 warning | 0 infos

ManualNat64Rule: Host2Host

Warning: [ManualNatRule 1] The NAT rule has source and destination interfaces belonging to different Virtual Routers, the traffic will be able to leak between Virtual Routers without explicit route leak configuration whenever destination translation happens. If you intent to apply this NAT rule even when destination translation is not happening, create a static route leak explicitly. The rule involves interfaces from [VRG] to [VRB]

How to Manage Overlapping Segments in Routed Firewall Mode with BVI Interfaces

You can deploy single threat defense between multiple overlapping networks transparently and/or deploy the firewall between the hosts of same network. To achieve this deployment, configure BVI per virtual router. The procedure to configure the BVIs in virtual router is explained here.

BVI is a virtual interface within a router that acts like a normal routed interface. It does not support bridging, but represents the comparable bridge group to routed interfaces within the router. All the packets coming in or going out of these bridged interfaces, pass through the BVI interface. The interface number of the BVI is the number of the bridge group that the virtual interface represents.

In the following example, BVI-G is configured in VRG and Bridge Group 1 is the routed interface for interfaces G0/1 and G0/2. Similarly, BVI-B is configured in VRB and Bridge Group 2 is the routed interface for interfaces G0/3 and G0/4. Consider that both BVIs have the same IP subnet address, say 10.10.10.5/24. Because of virtual routers, the network is isolated on the shared resources.

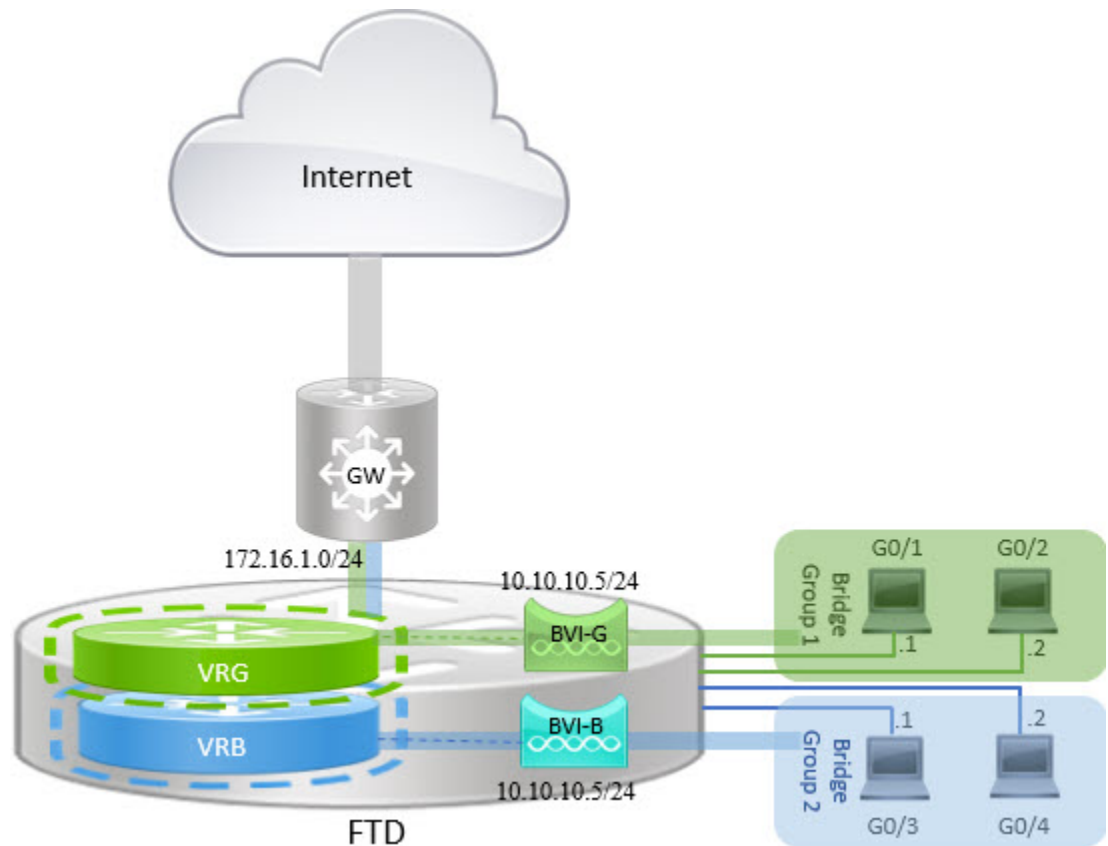

Procedure

- Step 1** Choose **Devices > Device Management**. Edit the required device.
- Step 2** In **Interfaces**, choose **Add Interfaces > Bridge Group Interface**.
- a) Enter the following details for BVI-G:
- **Name**—For this example, BVI-G.
 - **Bridge Group ID**—For this example, 1.
 - **Available Interface**—Select the interfaces.
 - In **IPv4**, for **IP Type**, choose **Use Static IP**.
 - **IP Address**—Enter 10.10.10.5/24.

Add Bridge Group Interface ?

Interfaces IPv4 IPv6

Name:

Description:

Bridge Group ID *:

(1 - 250)

Available Interfaces ⌵

- GigabitEthernet0/0
- GigabitEthernet0/1
- GigabitEthernet0/2
- GigabitEthernet0/3
- GigabitEthernet0/4
- GigabitEthernet0/5

Selected Interfaces

- GigabitEthernet0/1 ⌵
- GigabitEthernet0/2 ⌵

- b) Click **Ok**.
- c) Click **Save**.
- a) Enter the following details for BVI-B:
- **Name**—For this example, BVI-B.
 - **Bridge Group ID**—For this example, 2.
 - **Available Interface**—Select the sub interfaces.
 - In **IPv4**, for **IP Type**, choose **Use Static IP**.
 - **IP Address**—Leave this field empty as the system does not allow two interfaces to have overlapping IP address. You can revisit the Bridge Group and provide the same IP address after aligning it under a virtual router.

Add Bridge Group Interface ?

Interfaces IPv4 IPv6

Name:

Description:

Bridge Group ID *:

(1 - 250)

Available Interfaces ↻

Search

- GigabitEthernet0/0
- GigabitEthernet0/3
- GigabitEthernet0/4
- GigabitEthernet0/5
- GigabitEthernet0/6
- GigabitEthernet0/7

Selected Interfaces

- GigabitEthernet0/3 🗑
- GigabitEthernet0/4 🗑

- b) Click **Ok**.
- c) Click **Save**.

Step 3 Create virtual router, say VRG, and select BVI-G as its network:

- a) Choose **Devices > Device Management**.
- b) Edit the device, and choose **Routing > Manage Virtual Routers**.
- c) Click **Add Virtual Router**. Enter a name for the virtual router and click **Ok**.
- d) In **Virtual Routing Properties**, select **BVI-G** and click **Add**.

Device Routing Interfaces Inline Sets DHCP

Manage Virtual Routers

VRG ▼

Virtual Router Properties

OSPF

▼ BGP

IPv4

Static Route

General Settings

BGP

Virtual Router Properties

These are the basic details of this virtual router.

VRF Name:

Description:

Select Interface:

Available Interface*

- BVI-G
- BVI-B
- vrg-inside

Selected Interfaces

- BVI-G 🗑

- e) Click **Save**.

Step 4 Create virtual router, say VRB, and select BVI-B as its network:

- a) Choose **Devices > Device Management**.
- b) Edit the device, and choose **Routing > Manage Virtual Routers**.
- c) Click **Add Virtual Router**. Enter a name for the virtual router and click **Ok**.

- d) In **Virtual Routing Properties**, select **BVI-B** and click **Add**.

The screenshot shows the 'Virtual Router Properties' configuration page. The left sidebar has a 'Manage Virtual Routers' section with a dropdown menu set to 'VRB'. Below it are sections for 'Virtual Router Properties', 'OSPF', 'BGP', 'IPv4', and 'Static Route'. The 'General Settings' section includes 'BGP'. The main content area is titled 'Virtual Router Properties' and contains the following fields: 'VRF Name' (VRB), 'Description' (empty), 'Select Interface' (with a search box), 'Available Interfaces*' (listing 'BVI-B' and 'vrg-inside'), and 'Selected Interfaces' (empty).

- e) Click **Save**.

Step 5 Revisit the BVI-B configuration:

- Choose **Devices > Device Management > Interfaces**.
- Click **Edit** against BVI-B interface. Specify the IP Address as 10.10.10.5/24. The system now allows you to configure with same IP address of BVI-G, because the interfaces are separately assigned to two different virtual routers.
- Click **Ok**.
- Click **Save**.

If you want to enable inter-BVI communication, use an external router as default gateway. In overlapping BVI scenarios, as in this example, use twice NAT external router as gateway to establish inter-BVI traffic. When configuring NAT for the members of a bridge group, you specify the member interface. You cannot configure NAT for the bridge group interface (BVI) itself. When doing NAT between bridge group member interfaces, you must specify the real and mapped addresses. You cannot specify “any” as the interface.

How to Configure User Authentication with Overlapping Networks

In virtual routing, you can configure multiple virtual routers with overlapping IP and overlapping users. In the example, VRG, and VRB are the virtual routers with overlapping IP - 192.168.1.1/24. The users on two different domains are also on overlapping network IP 192.168.1.20. For VRG and VRB users to access the shared server 172.16.10.X, leak routes to the global virtual router. Use source NAT to handle the overlapping IP. For controlling the access from VRG and VRB users, you must set user authentication in management center. Management Center uses realms, Active Directories, Identity source, and Identity rules and policies for authenticating user identity. Because threat defense does not have direct role in authenticating users, user access is managed only through the access control policy. For controlling traffic from the overlapping users, use Identity policy and rules to create access control policy.

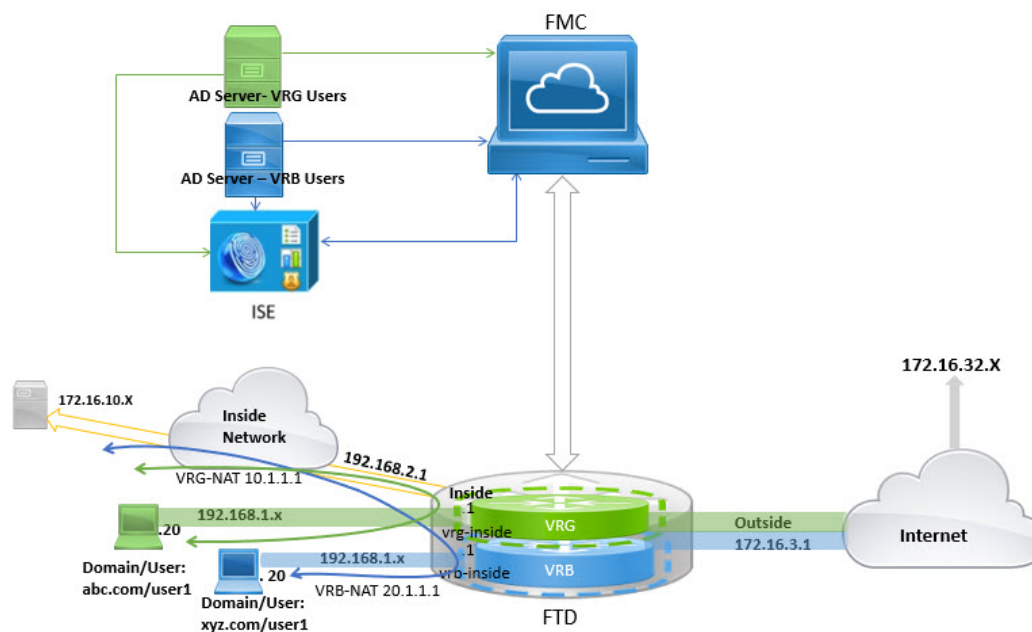

Before you begin

This example assumes that you have:

- Two AD servers for the VRG and VRB users.
- ISE with the two AD servers added.

Procedure

Step 1

Configure the inside interface of the device for VRG:

- Choose **Devices > Device Management > Interfaces**.
- Edit the interfaces that you want to assign to VRG:
 - **Name**—For this example, VRG-inside.
 - Select the **Enabled** checkbox.
 - In **IPv4**, for **IP Type**, choose **Use Static IP**.
 - **IP Address**—Enter 192.168.1.1/24.

- Click **Ok**.
- Click **Save**.

Step 2

Configure the inside interface of the device for VRB:

- Choose **Devices > Device Management > Interfaces**.
- Edit the interfaces that you want to assign to VRB:
 - **Name**—For this example, VRB-inside.

- Select the **Enabled** checkbox.
- In **IPV4**, for **IP Type**, choose **Use Static IP**.
- **IP Address**—Leave it blank. The system doesn't allow you to configure interfaces with same IP address, as you're yet to create user-defined virtual routers.

- Click **Ok**.
- Click **Save**.

Step 3

Configure VRG and the static default route leak to the inside interface of the Global router for the VRG users to access the common server 172.16.10.1:

- Choose **Devices > Device Management**, and edit the threat defense device.
- Choose **Routing > Manage Virtual Routers**. Click **Add Virtual Router** and create VRG.
- For VRG, in **Virtual Router Properties**, assign VRG-inside and save.

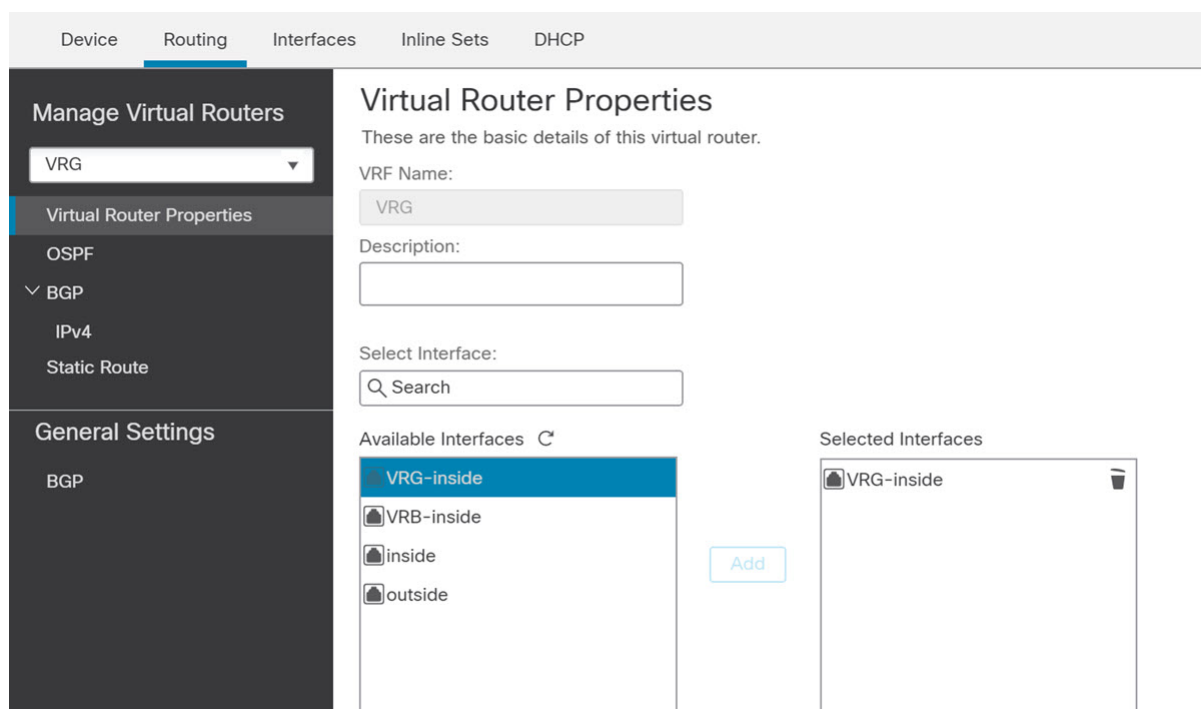

- Click **Static Route**.
- Click **Add Route**. In **Add Static Route Configuration**, specify the following:
 - **Interface**—Select the inside interface of the global router.
 - **Network**—Select the any-ipv4 object.
 - **Gateway**—Leave it blank. When leaking a route into another virtual router, do not select a gateway.
- Click **Ok**.
- Click **Save**.

Step 4

Configure VRB and the static default route leak to the inside interface of the Global router for the VRB users to access the shared server 172.16.10.x:

- Choose **Devices > Device Management**, and edit the threat defense device.

- b) Choose **Routing > Manage Virtual Routers**. Click **Add Virtual Router** and create VRB.
- c) For VRB, in **Virtual Router Properties**, assign VRB-inside and save.

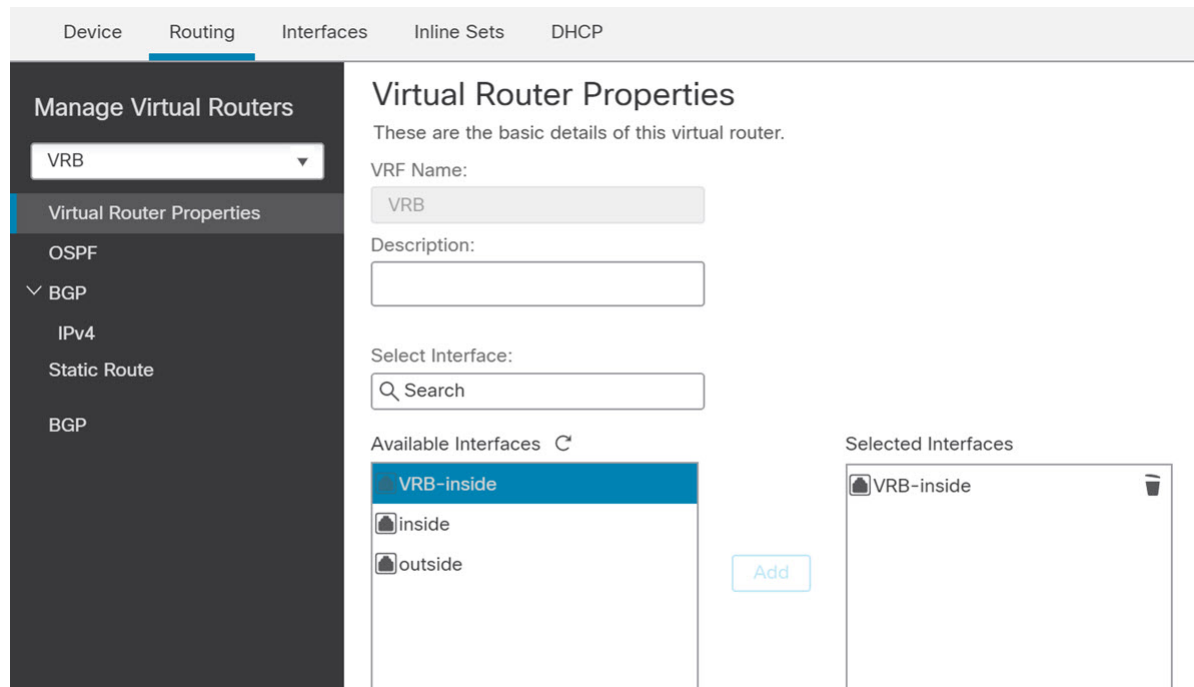

- d) Click **Static Route**.
- e) Click **Add Route**. In **Add Static Route Configuration**, specify the following:
 - **Interface**—Select the inside interface of the global router.
 - **Network**—Select the any-ipv4 object.
 - **Gateway**—Leave it blank. When leaking a route into another virtual router, do not select a gateway.
- f) Click **Ok**.
- g) Click **Save**.

Step 5 Revisit the VRB-inside interface configuration:

- a) Choose **Devices > Device Management > Interfaces**.
- b) Click **Edit** against VRB-inside interface. Specify the IP Address as 192.168.1.1/24. The system now allows you to configure with the same IP address as that of VRG-inside, because the interfaces are separately assigned to two different virtual routers.
- c) Click **Ok**.
- d) Click **Save**.

Step 6 Add NAT rules for the source objects VRG and VRB. Click **Devices > NAT**.

Step 7 Click **New Policy**.

Step 8 Enter a NAT policy name, and select the threat defense device. Click **Save**.

Step 9 In the NAT page, click **Add Rule** and define the following source NAT for VRG:

- **NAT Rule**—Select Manual NAT Rule.
- **Type**—Select Static.

- **Insert**—Select Above, if any NAT rule exists.
- Click **Enabled**.
- In **Interface Objects**, select VRG-Inside object and click **Add to Source** (If the object is not available, create one in **Object > Object Management > Interface**), and select Global-Inside object and click **Add to Destination**.
- In **Translation**, select the following:
 - **Original Source**, select VRG-Users.
 - **Translated Source**, click **Add** and define object, VRG-NAT with 10.1.1.1. Select VRG-NAT as shown in the following figure:

Add NAT Rule

NAT Rule:
Manual NAT Rule

Insert:
In Category NAT Rules Before

Type:
Static

Enable

Description:

Interface Objects Translation PAT Pool Advanced

Original Packet	Translated Packet
Original Source:* VRG-Users +	Translated Source: Address
Original Destination: Address +	Translated Destination: VRG-NAT +
Original Source Port: <input type="text"/>	Translated Source Port: <input type="text"/>

Cancel OK

Step 10 Click **Ok**.

Step 11 In the NAT page, click **Add Rule** and define the following source NAT for VRB:

- **NAT Rule**—Select Manual NAT Rule.
- **Type**—Select Static.
- **Insert**—Select Above, if any NAT rule exists.
- Click **Enabled**.

- In **Interface Objects**, select VRB-Inside object and click **Add to Source** (If the object is not available, create one in **Object > Object Management > Interface**), and select Global-Inside object and click **Add to Destination**.
- In **Translation**, select the following:
 - **Original Source**, select VRB-Users.
 - **Translated Source**, click **Add** and define object, VRB-NAT with 20.1.1.1. Select VRB-NAT as shown in the following figure:

Add NAT Rule

NAT Rule:
Manual NAT Rule

Insert:
In Category NAT Rules Before

Type:
Static

Enable

Description:

Interface Objects Translation PAT Pool Advanced

Original Packet	Translated Packet
Original Source:* VRB-Users +	Translated Source: Address
Original Destination: Address +	VRB-NAT +
	Translated Destination: +
Original Source Port:	Translated Source Port:

Cancel OK

Step 12 Click **Save**.

The NAT rule looks like this:

Rules						
Filter by Device						
#	Direction	Type	Source Interface	Destination Interface	Original Sources	Original Packet Original Destinations
NAT Rules Before						
1		St...	any	any	VRG-Users	
2		St...	any	any	VRB-Users	
Auto NAT Rules						

- Step 13** Add the two unique AD servers in management center one for each VRG and VRB users—choose **System > Integration > Realms**.
- Step 14** Click **New Realm** and complete the fields. For detailed information on the fields, see [Realm Fields](#).
- Step 15** For controlling the access from VRG and VRB users, define 2 Active Directories, see [Realm Directory and Synchronize fields](#) see [Create an LDAP Realm or an Active Directory Realm and Realm Directory](#)
- Step 16** Add ISE in management center—choose **System > Integration > Identity Sources**.
- Step 17** Click **Identity Services Engine** and complete the fields. For detailed information on the fields, see [How to Configure ISE/ISE-PIC for User Control Using a Realm](#).
- Step 18** Create Identity policy, rules, and then define access control policy for controlling access of overlapping users from VRG and VRB.

How to Interconnect Virtual Routers using BGP

You can now configure BGP settings on a device to leak the routes among virtual routers (Global and user-defined virtual routers). The route target of the source virtual router is exported to the BGP table, which, in turn is imported to the destination virtual router. The route map is used to share the Global virtual routes with the user-defined virtual routers and vice versa. Note that all import or export of the routes to the BGP table is configured at the user-defined virtual router, including the Global virtual routes.

Consider the firewall device of a factory is configured with the following virtual routers and interfaces:

- Global virtual router is configured with Inside (10.10.1.4/24) and Outside (10.10.0.5/24)
- VR-S (Sales) virtual router is configured with Inside1 (10.10.10.7/24) and Outside1 (10.10.11.7/24)
- VR-W (Warehouse) virtual router is configured with Inside2 (10.10.12.7/24) and Outside2 (10.10.13.7/24)

Assume that you want the routes of warehouse (VR-W) to be leaked with sales (VR-S) and Global, and the outside interface routes of VR-S to VR-W. Similarly, you want the outside interface routes of the Global router to be leaked to sales (VR-S). This example demonstrates the BGP configuration procedure to achieve interconnecting the routers:

Figure 3: Interconnect Virtual Routers using BGP Settings

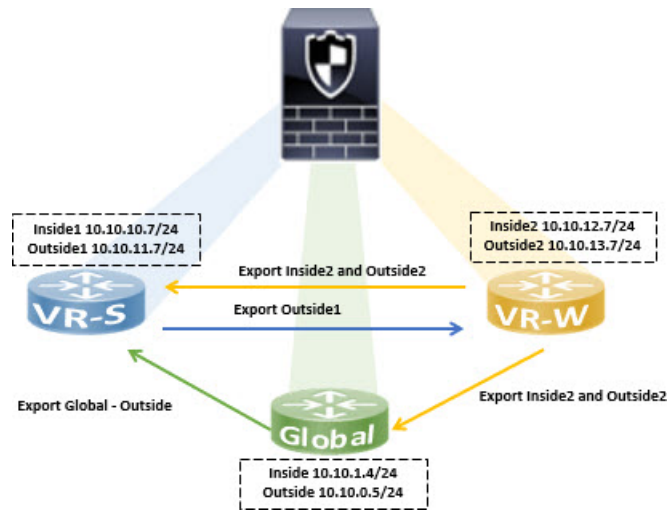
**Before you begin**

- Create a Virtual Router—VR-S and VR-W.
- Enable BGP and for each virtual router [Configure BGP for redistribution of connected routes](#).

Procedure

Step 1 Configure VR-W to export its routes tagging them with a route target to VR-S:

- Choose **Devices > Device Management**, edit device, and then click the **Routing** tab.
- From the virtual router drop-down, select VR-W.
- Click **BGP > IPv4 > Route Import/Export**.
- To leak the VR-W routes to VR-S, tag the routes with a route target, so that the VR-W routes are exported to its BGP table with the route target marked on them. In the **Route Targets Export** field, enter a value, say, `200:200`. Click **Add**:

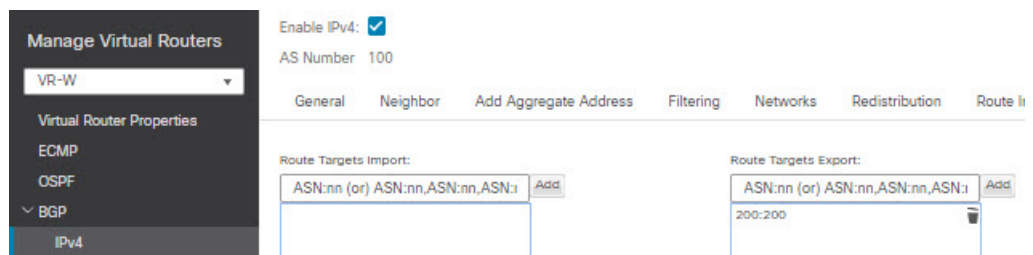

- From the virtual router drop-down, select VR-S.
- Click **BGP > IPv4 > Route Import/Export**.
- To receive the leaked routes from VR-W, configure the Import Route Target to import the VR-W routes that are marked with the route target from the (peer or redistributed) BGP table. In the **Route Targets Import** field, enter the same route target value that you had configured for VR-W, `200:200`. Click **Add**.

Manage Virtual Routers

VR-S

Virtual Router Properties

ECMP

OSPF

BGP

IPv4

Enable IPv4:

AS Number 100

General Neighbor Add Aggregate Address Filtering Networks Redistribution Route I

Route Targets Import:

ASN:nn (or) ASN:nn,ASN:nn,ASN:nn	Add
200:200	<input type="button" value="Add"/>

Route Targets Export:

ASN:nn (or) ASN:nn,ASN:nn,ASN:nn	Add
	<input type="button" value="Add"/>

Note If you want to conditionalize routes to be leaked from VR-W, you can specify the match criteria in the route map object, and choose it in the **User Virtual Router Export Route Map**. Similarly, if you want to conditionalize the routes to be imported to VR-S from the BGP table, you can use the **User Virtual Router Import Route Map**. This procedure is explained in Step 3.

Step 2 Configure VR-W to export its routes to the Global virtual router:

- You need to create a route map that would allow the VR-W routes to be exported to the Global routing table. Choose **Objects > Object Management > Route Map**.
- Click **Add Route Map**, give a name, say *Export-to-Global*, and then click **Add**.
- Specify a **Sequence Number**, say 1, and then choose Allow from the **Redistribution** drop-down list:

New Route Map Object

Name

Export-to-Global

Entries (1)

Add

Sequence No ▲	Redistribution
1	Allow

Allow Overrides

Cancel Save

- Click **Save**.
- In this example, all the VR-W routes are leaked to the Global routing table. Hence, no match criteria is configured for the route map.
- Navigate to the **Routing** tab of the device, and select VR-W. Click **BGP > IPv4 > Route Import/Export**.
 - From the **Global Virtual Router Export Route Map** drop-down list, choose Export-to-Global:

Enable IPv4:

AS Number: 100

General Neighbor Add Aggregate Address Filtering Networks Redistribution Rout

Route Targets Import:

ASN:nn (or) ASN:nn,ASN:nn,ASN:nn Add

User Virtual Router

Import Route Map:

Global Virtual Router

Import Route Map:

Route Targets Export:

ASN:nn (or) ASN:nn,ASN:nn,ASN:nn Add

200:200

User Virtual Router

Export Route Map:

Global Virtual Router

Export Route Map:

Export-to-Global

Step 3

To leak only the Outside1 routes of VR-S to VR-W:

- a) From the virtual router drop-down, select VR-S.
- b) Click **BGP > IPv4 > Route Import/Export**.
- c) To leak the VR-S routes to VR-W, tag the routes with a route target, so that the VR-S routes are exported to its BGP table with the route target marked on them. In the **Route Targets Export** field, enter a value, say, *100:100*. Click **Add**.
- d) From the virtual router drop-down, select VR-W, and choose **BGP > IPv4 > Route Import/Export**.
- e) To receive the leaked routes from VR-S, configure the Import Route Target to import the VR-S routes that are marked with the route target from the (peer or redistributed) BGP table. In the **Route Targets Import** field, enter the VR-S route target value, *100:100*. Click **Add**.
- f) Now, you need to conditionalize that only the Outside1 routes of VR-S to be leaked to VR-W. Choose **Objects > Object Management > Prefix List > IPv4 Prefix List**.
- g) Click **Add IPv4 Prefix List**, give a name, say *VRS-Outside1-Only*, and then click **Add**.
- h) Specify a **Sequence Number**, say 1, and then choose Allow from the **Redistribution** drop-down list.
- i) Enter the IP Address (first two octets) of the VR-S Outside1 interface.
- j) Click **Save**.
- k) Create a route map with the match clause with the prefix list. Click **Route Map**. Click **Add Route Map**, give a name, say *Import-from-VRS*, and then click **Add**.
- l) Specify a **Sequence Number**, say 1, and then choose Allow from the **Redistribution** drop-down list.
- m) In the **Match Clause** tab, click **IPv4**. Under **Address** tab, click **Prefix List**.
- n) Under **Available IPv4 Prefix List**, select *VRS-Outside1-Only*, and then click **Add**.
- o) Click **Save**.
- p) Navigate to the **Routing** tab of the device, and select VR-W. Click **BGP > IPv4 > Route Import/Export**.
- q) From the **Global Virtual Router Import Route Map** drop-down list, choose *Import-from-VRS*:

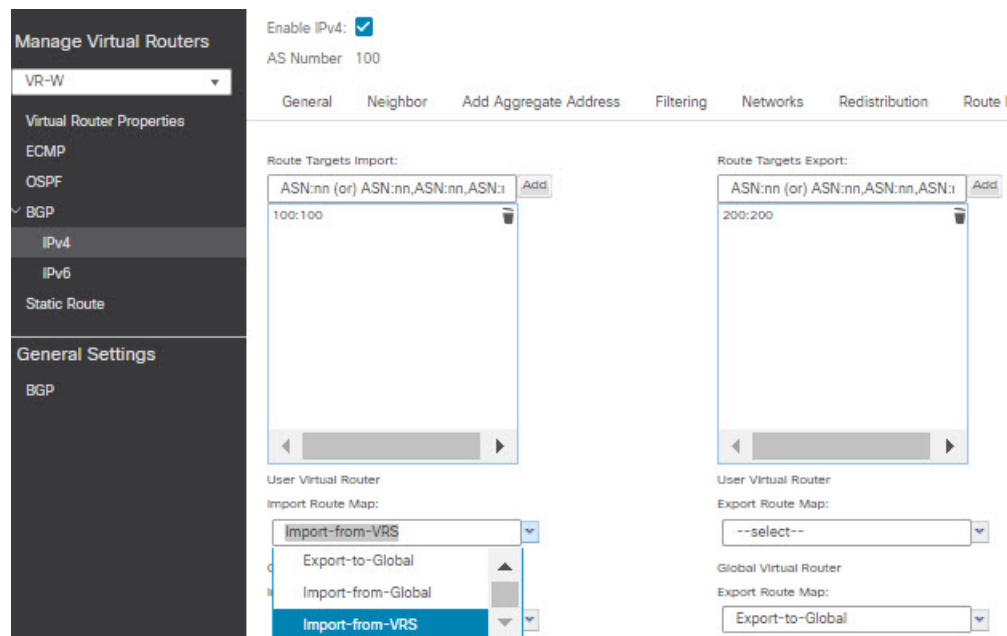

Step 4 Configure VR-S to import the Outside routes of Global virtual router:

Note To leak routes to or from a Global virtual router, you must configure the source or destination user defined virtual router respectively. Thus, in this example, VR-S is the destination router that imports the routes from Outside interface of the Global virtual router.

- Choose **Objects > Object Management > Prefix List > IPv4 Prefix List**.
- Click **Add IPv4 Prefix List**, give a name, say *Global-Outside-Only*, and then click **Add**.
- Specify a **Sequence Number**, say 1, and then choose Allow from the **Redistribution** drop-down list.
- Enter the IP Address (first two octets) of the Global Outside interface:

Add Prefix List Entry

Action:

Sequence No:
Range: 1-4294967295

IP Addresses: (Limit 250) Address:
Format: ipaddr/len (len<=32)

Min Prefix Length:
Range: 1 - 32

Max Prefix Length:
Range: 1 - 32

- Click **Save**.
- Click **Route Map**. Click **Add Route Map**, give a name, say *Import-from-Global*, and then click **Add**.
- Specify a **Sequence Number**, say 1, and then choose Allow from the **Redistribution** drop-down list.

- h) In the **Match Clause** tab, click **IPv4**. Under **Address** tab, click **Prefix List**.
 i) Under **Available IPv4 Prefix List**, select **Global-Outside-Only**, and then click **Add**:

Add Route Map Entry

Sequence No:

Redistribution:

Match Clauses Set Clauses

Security Zones

IPv4
 IPv6
 BGP
 Others

Address (2) Next Hop (0) Route Source (0)

Select addresses to match as access list or prefix list addresses of route.

Access List
 Prefix List

Available Access Lists :

Available IPv4 Prefix List

Selected IPv4 Prefix List

- j) Click **Save**.
 k) Navigate to the **Routing** tab of the device, and select VR-S. Click **BGP > IPv4 > Route Import/Export**.
 l) From the **Global Virtual Router Import Route Map** drop-down list, choose **Import-from-Global**:

Manage Virtual Routers

VR-S

Virtual Router Properties
 ECMP
 OSPF
 BGP
 IPv4
 IPv6
 Static Route

General Settings
 BGP

Enable IPv4:
 AS Number 100

General Neighbor Add Aggregate Address Filtering Networks Redistribution Route I

Route Targets Import:

ASN:nn (or) ASN:nn,ASN:nn,ASN:1

200:200

User Virtual Router
 Import Route Map:

Global Virtual Router
 Import Route Map:

Route Targets Export:

ASN:nn (or) ASN:nn,ASN:nn,ASN:1

User Virtual Router
 Export Route Map:

Global Virtual Router
 Export Route Map:

Step 5 Save and Deploy.

History for Virtual Routers

Feature	Minimum Management Center	Minimum Threat Defense	Details
AAA for user-defined VRF interfaces.	7.6	7.6	<p>A device's authentication, authorization, and accounting (AAA) is now supported on user-defined Virtual Routing and Forwarding (VRF) interfaces. The default is to use the management interface.</p> <p>In device platform settings, you can now associate a security zone or interface group having the VRF interface, with a configured external authentication server.</p> <p>New/modified screens: Devices > Platform Settings > External Authentication</p>
Virtual routing with dynamic VTI.	7.4	7.4	<p>You can now configure a virtual router with a dynamic VTI for a route-based site-to-site VPN.</p> <p>New/modified screens: Devices > Device Management > Edit Device > Routing > Virtual Router Properties > Dynamic VTI interfaces under Available Interfaces</p> <p>Platform restrictions: Supported only on native mode standalone or high availability devices. Not supported for container instances or clustered devices.</p>
Virtual router support for the ISA 3000.	7.0	7.0	You can configure up to 10 virtual routers on the ISA 3000.
SNMP support on user-defined virtual routers	7.0	7.0	You can now configure SNMP on user-defined virtual routers.
Bulk removal of virtual routers.	6.7	6.6	<p>You can remove multiple virtual routers from threat defense at a time.</p> <p>New/modified screens: Devices > Device Management > Routing > Manage Virtual Routers</p>

Feature	Minimum Management Center	Minimum Threat Defense	Details
Virtual routers and VRF-Lite for threat defense.	6.6	6.6	<p>You can now create multiple virtual routers to maintain separate routing tables for groups of interfaces. Because each virtual router has its own routing table, you can provide clean separation in the traffic flowing through the device. Virtual routers implement the “light” version of Virtual Routing and Forwarding, or VRF-Lite, which does not support Multiprotocol Extensions for BGP (MBGP). The maximum number of virtual routers you can create ranges from five to 100, and depends on the device model..</p> <p>New/modified screens: Devices > Device Management > edit device > Routing tab</p> <p>New/modified CLI commands: .</p> <ul style="list-style-type: none"> • show vrf • Added the [vrf name all] keyword set to these CLI commands, and changed the output to indicate virtual router information where applicable: clear ospf, clear route, ping, show asp table routing, show bgp, show ipv6 route, show ospf, show route, show snort counters <p>Platform restrictions: Not supported on the Firepower 1010 and ISA 3000.</p>

