



Firepower 1010 Threat Defense Getting Started: Management Center on a Local Management Network

First Published: 2024-10-16

Last Modified: 2024-10-21

Americas Headquarters

Cisco Systems, Inc.
170 West Tasman Drive
San Jose, CA 95134-1706
USA
<http://www.cisco.com>
Tel: 408 526-4000
800 553-NETS (6387)
Fax: 408 527-0883



CHAPTER 1

Before You Begin

Manage the firewall using the Secure Firewall Management Center on a dedicated management network.

- [Power On the Firewall, on page 1](#)
- [Which Application is Installed: Threat Defense or ASA?, on page 2](#)
- [Access the Threat Defense CLI, on page 3](#)
- [Check the Version and Reimage, on page 4](#)
- [Obtain Licenses, on page 5](#)
- [\(If Needed\) Power Off the Firewall, on page 7](#)

Power On the Firewall

System power is controlled by the power cord; there is no power button.



Note The first time you boot up the firewall, threat defense initialization can take approximately 15 to 30 minutes.

Before you begin

It's important that you provide reliable power for your firewall (for example, using an uninterruptable power supply (UPS)). Loss of power without first shutting down can cause serious file system damage. There are many processes running in the background all the time, and losing power does not allow the graceful shutdown of your system.

Procedure

- Step 1** Attach the power cord to the firewall, and connect it to an electrical outlet.
The power turns on automatically when you plug in the power cord.
- Step 2** Check the Power LED on the back of the firewall; if it is solid green, the firewall is powered on.

Figure 1: System and Power LEDs

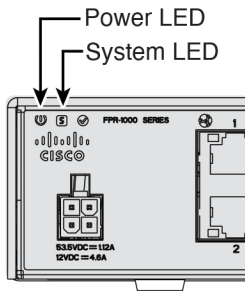

Step 3 Check the System LED on the back of the firewall; after it is solid green, the system has passed power-on diagnostics.

Which Application is Installed: Threat Defense or ASA?

Both applications, threat defense or ASA, are supported on the hardware. Connect to the console port and determine which application was installed at the factory.

Procedure

Step 1 Connect to the console port using either port type.

Figure 2: Console Port

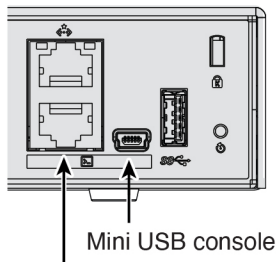

RJ-45 console

Step 2 See the CLI prompts to determine if your firewall is running threat defense or ASA.

Threat Defense

You see the firepower login (FXOS) prompt. You can disconnect without logging in and setting a new password. If you need to log in all the way, see [Access the Threat Defense CLI, on page 3](#).

```
firepower login:
```

ASA

You see the ASA prompt.

```
ciscoasa>
```

- Step 3** If you are running the wrong application, see [Cisco Secure Firewall ASA and Secure Firewall Threat Defense Reimage Guide](#).

Access the Threat Defense CLI

You might need to access the CLI for configuration or troubleshooting.

Procedure

- Step 1** Connect to the console port using either port type.

Figure 3: Console Port

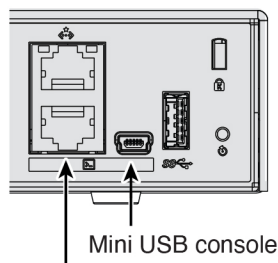

RJ-45 console

- Step 2** You connect to FXOS. Log in to the CLI using the **admin** username and the password (the default is **Admin123**). The first time you log in, you are prompted to change the password.

```
firepower login: admin
Password: Admin123
Successful login attempts for user 'admin' : 1

[...]

Hello admin. You must change your password.
Enter new password: *****
Confirm new password: *****
Your password was updated successfully.

[...]

firepower#
```

- Step 3** Change to the threat defense CLI.

Note If you want to use the device manager for initial setup, do not access the threat defense CLI, which starts the CLI setup.

connect ftd

The first time you connect to the threat defense CLI, you are prompted to complete initial setup.

Example:

```
firepower# connect ftd
>
```

To exit the threat defense CLI, enter the **exit** or **logout** command. This command returns you to the FXOS prompt.

Example:

```
> exit
firepower#
```

Check the Version and Reimage

We recommend that you install your target version before you configure the firewall. Alternatively, you can perform an upgrade after you are up and running, but upgrading, which preserves your configuration, may take longer than using this procedure.

What Version Should I Run?

Cisco recommends running a Gold Star release indicated by a gold star next to the release number on the software download page. You can also refer to the release strategy described in <https://www.cisco.com/c/en/us/products/collateral/security/firewalls/bulletin-c25-743178.html>.

Procedure

Step 1 Connect to the console port using either port type.

Figure 4: Console Port

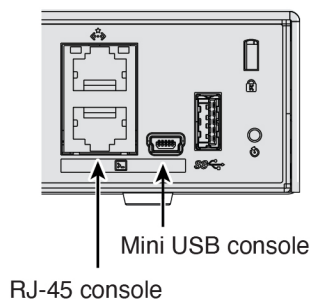

Step 2 At the FXOS CLI, show the running version.

```
scope ssa
```

```
show app-instance
```

Example:

```
Firepower# scope ssa
Firepower /ssa # show app-instance
```

```
Application Name Slot ID Admin State Operational State Running Version Startup Version Cluster Oper
State
-----
-----
ftd                1      Enabled      Online          7.6.0.65      7.6.0.65      Not Applicable
```

Step 3

If you want to install a new version, perform these steps.

- a) By default, the Management interface uses DHCP. If you need to set a static IP address for the Management interface, enter the following commands.

```
scope fabric-interconnect a
```

```
set out-of-band static ip ip netmask netmask gw gateway
```

```
commit-buffer
```

Note If you encounter the following error, you must disable DHCP before committing the change. Follow the commands below to disable DHCP.

```
firepower /fabric-interconnect* # commit-buffer
Error: Update failed: [Management ipv4 address (IP <ip> / net mask <netmask> ) is not
in the same network of current DHCP server IP range <ip - ip>.
Either disable DHCP server first or config with a different ipv4 address.]
firepower /fabric-interconnect* # exit
firepower* # scope system
firepower /system* # scope services
firepower /system/services* # disable dhcp-server
firepower /system/services* # commit-buffer
```

- b) Perform the [reimage procedure](#) in the [FXOS troubleshooting guide](#).

You will need to download the new image from a server accessible from the Management interface.

After the firewall reboots, you connect to the FXOS CLI again.

- c) At the FXOS CLI, you are prompted to set the admin password again.

Obtain Licenses

When you bought your device from Cisco or a reseller, your licenses should have been linked to your Smart Software License account. If you don't have an account on the [Smart Software Manager](#), click the link to [set up a new account](#).

If you have not already done so, register the management center with the Smart Software Manager. Registering requires you to generate a registration token in the Smart Software Manager. See the [Cisco Secure Firewall Management Center Administration Guide](#) for detailed instructions.

The threat defense has the following licenses:

- Essentials—Required
- IPS
- Malware Defense
- URL Filtering
- Cisco Secure Client

1. If you need to add licenses yourself, go to [Cisco Commerce Workspace](#) and use the **Search All** field.

Figure 5: License Search

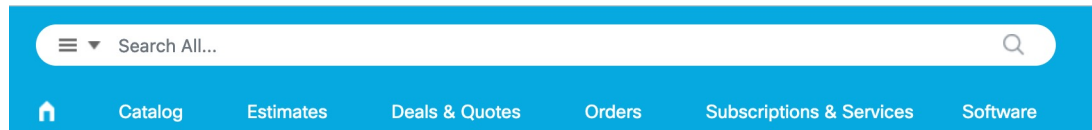

2. Search for the following license PIDs.



Note If a PID is not found, you can add the PID manually to your order.

- IPS, Malware Defense, and URL combination:
 - L-FPR1010T-TMC=

When you add one of the above PIDs to your order, you can then choose a term-based subscription corresponding with one of the following PIDs:

- L-FPR1010T-TMC-1Y
- L-FPR1010T-TMC-3Y
- L-FPR1010T-TMC-5Y
- Cisco Secure Client—See the [Cisco Secure Client Ordering Guide](#).

3. Choose **Products & Services** from the results.

Figure 6: Results

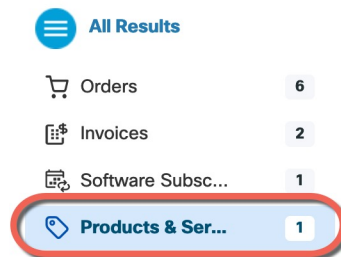

(If Needed) Power Off the Firewall

It's important that you shut down your system properly. Simply unplugging the power can cause serious file system damage. There are many processes running in the background all the time, and unplugging or shutting off the power does not allow the graceful shutdown of your firewall system.

The Firepower 1010 chassis does not have an external power switch..

Power Off the Firewall at the CLI

You can use the FXOS CLI to safely shut down the system and power off the firewall.

Procedure

Step 1 Connect to the console port using either port type.

Figure 7: Console Port

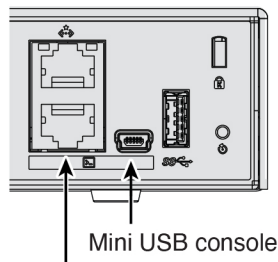

RJ-45 console

Step 2 In the FXOS CLI, connect to local-mgmt mode.

```
firepower # connect local-mgmt
```

Step 3 Shut down the system.

```
firepower(local-mgmt) # shutdown
```

Example:

```
firepower(local-mgmt)# shutdown
This command will shutdown the system. Continue?
Please enter 'YES' or 'NO': yes
INIT: Stopping Cisco Threat Defense.....ok
```

Step 4 Monitor the system prompts as the firewall shuts down. When the shutdown is complete, you will see the following prompt.

```
System is stopped.
It is safe to power off now.
Do you want to reboot instead? [y/N]
```

Step 5 You can now unplug the power to physically remove power from the chassis if necessary.

Power Off the Firewall Using the Management Center

Shut down your system properly using the management center.

Procedure

Step 1 Shut down the firewall.

- a) Choose **Devices > Device Management**.
- b) Next to the device that you want to restart, click **Edit** (✎).
- c) Click the **Device** tab.
- d) Click **Shut Down Device** (🔌) in the **System** section.
- e) When prompted, confirm that you want to shut down the device.

Step 2 If you have a console connection to the firewall, monitor the system prompts as the firewall shuts down. When shutdown is complete, you will see the following prompt.

```
System is stopped.  
It is safe to power off now.
```

```
Do you want to reboot instead? [y/N]
```

If you do not have a console connection, wait approximately 3 minutes to ensure the system has shut down.

Step 3 You can now unplug the power to physically remove power from the chassis if necessary.



CHAPTER 2

Cable and Register the Firewall

Cable the firewall and then register the firewall to the management center.

- [Cable the Firewall, on page 9](#)
- [Perform Initial Configuration, on page 10](#)
- [Register the Firewall with the Management Center, on page 17](#)

Cable the Firewall

Connect the management center to the dedicated Management 1/1 interface. The management network needs access to the internet for updates. For example, you can connect the management network to the internet through the firewall itself (for example, by connecting to the inside network).

See the [hardware installation guide](#) for more information.

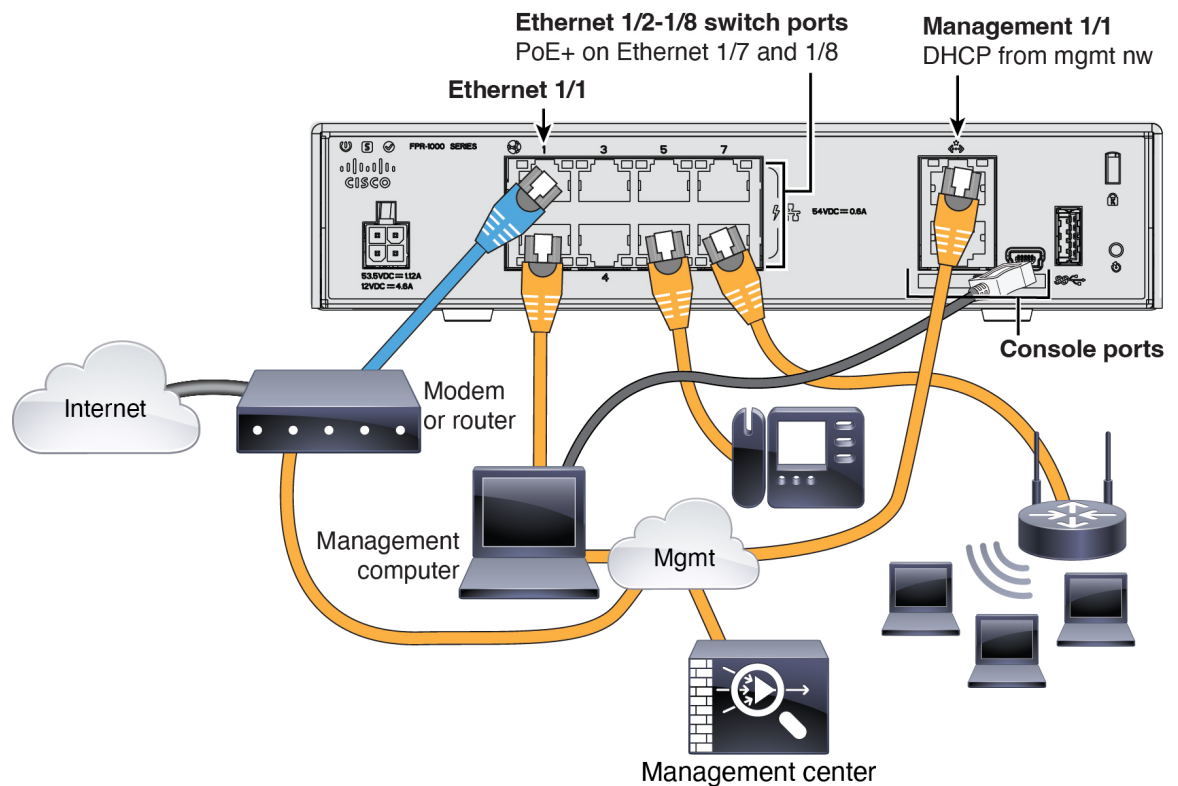

Perform Initial Configuration

Perform initial configuration of the firewall using the Secure Firewall device manager or using the CLI.

Initial Configuration: Device Manager

Using this method, after you register the firewall, the following interfaces will be preconfigured in addition to the Management interface:

- Ethernet 1/1—**outside**, IP address from DHCP, IPv6 autoconfiguration
- VLAN1— **inside**, 192.168.95.1/24
- Default route—Obtained through DHCP on the outside interface
- Additional interfaces—Any interface configuration from the device manager is preserved.

Other settings, such as the DHCP server on inside, access control policy, or security zones, are not preserved.

Procedure

- Step 1** Connect your computer to the inside interface (Ethernet 1/2 through 1/8).
- Step 2** Log into the device manager.

- Go to <https://192.168.95.1>.
- Log in with the username **admin** and the default password **Admin123**.
- You are prompted to read and accept the General Terms and change the admin password.

Step 3

Use the setup wizard.

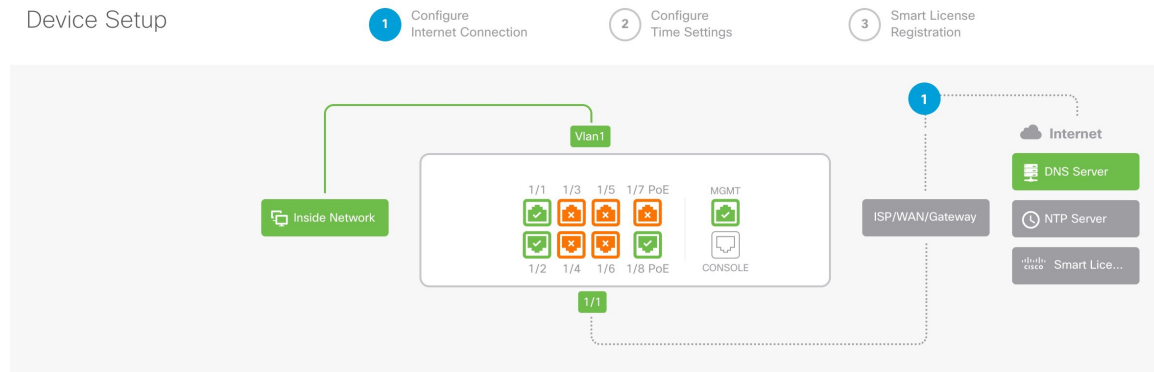
Figure 8: Device Setup

Note The exact port configuration depends on your model.

- Configure the outside and management interfaces.

Figure 9: Connect firewall to internet

Connect firewall to Internet

The initial access control policy will enforce the following actions.
You can edit the policy after setup.

<p>Rule 1 Trust Outbound Traffic</p> <p>This rule allows traffic to go from inside to outside, which is needed for the Smart License configuration.</p>	<p>Default Action Block all other traffic</p> <p>The default action blocks all other traffic.</p>
--	--

Outside Interface Address

Connect Ethernet1/1 (Outside) to your ISP/WAN device, for example, your cable modem or router. Then, configure the addresses for the outside interface.

Configure IPv4

Using DHCP

Configure IPv6

Using DHCP

Don't have internet connection?
[Skip device setup](#)

- 1. Outside Interface Address**—Use a static IP address if you plan for high availability. You cannot configure PPPoE using the setup wizard; you can configure PPPoE after you complete the wizard.
- 2. Management Interface**—Setting the Management interface IP address is not part of the setup wizard, but you can set the following options. If you need to use a static IP address, see Step [Step 4, on page 13](#).

DNS Servers—The DNS server for the system's management address. The default is the OpenDNS public DNS servers.

Firewall Hostname

- b) Configure the **Time Setting (NTP)** and click **Next**.

Figure 10: Time Setting (NTP)

Time Setting (NTP)

System Time: 11:56:20AM October 03 2024 -06:00

Time Zone for Scheduling Tasks

(UTC+00:00) UTC

NTP Time Server

Default NTP Servers

Server Name

0.sourcefire.pool.ntp.org

1.sourcefire.pool.ntp.org

2.sourcefire.pool.ntp.org

NEXT

- c) Select **Start 90 day evaluation period without registration**.

Register with Cisco Smart Software Manager

Register with Cisco Smart Software Manager to use the full functionality of this device and to apply subscription licenses.

[What is smart license? ↗](#)

Continue with evaluation period: Start 90-day evaluation period without registration
Recommended if device will be cloud managed. [Learn More](#) ↗

Please make sure you register with Cisco before the evaluation period ends. Otherwise you will not be able to make any changes to the device configuration.

Do not register the threat defense with the Smart Software Manager; all licensing is performed on the management center.

d) Click **Finish**.

Figure 11: What's Next

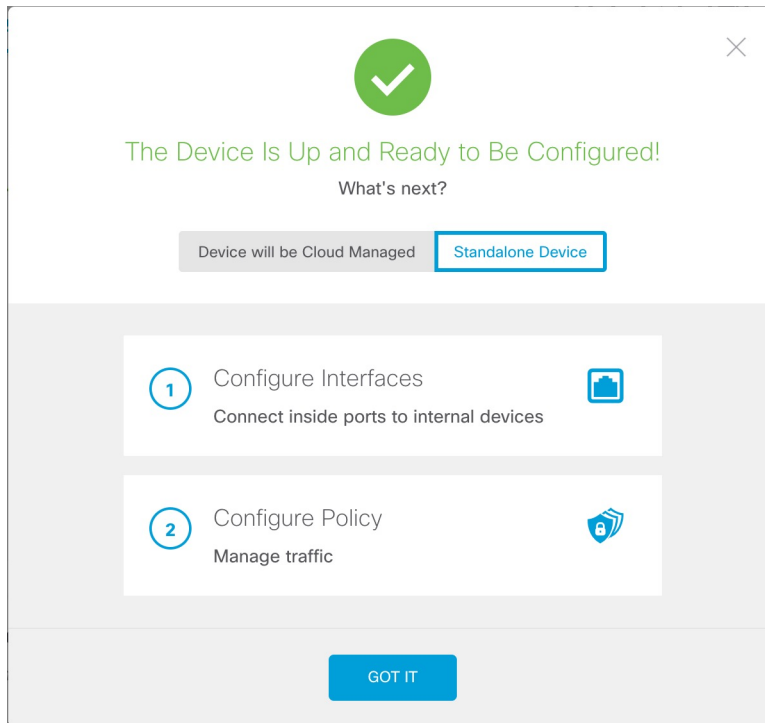

e) Choose **Standalone Device**, and then **Got It**.

Step 4 (Optional) Configure the Management interface with a static IP address. See the Management interface on **Device > Interfaces**.

Step 5 If you want to configure additional interfaces, choose **Device**, and then click the link in the **Interfaces** summary.

Step 6 Register with the management center by choosing **Device > System Settings > Central Management** and clicking **Proceed**

Configure the **Management Center/CDO Details**.

Figure 12: Management Center/CDO Details

Configure Connection to Management Center or CDO

Provide details to register to the management center/CDO.

Management Center/CDO Details

Do you know the Management Center/CDO hostname or IP address?

Yes No

Threat Defense



10.89.5.16
fe80::6a87:c6ff:fea6:4c00/64

→

Management Center/CDO



10.89.5.35

Management Center/CDO Hostname or IP Address

10.89.5.35

Management Center/CDO Registration Key

••••

NAT ID

Required when the management center/CDO hostname or IP address is not provided. We recommend always setting the NAT ID even when you specify the management center/CDO hostname or IP address.

11203

Connectivity Configuration

Threat Defense Hostname

1120-3

DNS Server Group

CustomDNSServerGroup

Management Center/CDO Access Interface

Data Interface

Please select an interface

Management Interface [View details](#)

- a) For **Do you know the Management Center/CDO hostname or IP address**, click **Yes** if you can reach the management center using an IP address or hostname or **No** if the management center is behind NAT or does not have a public IP address or hostname.
- b) If you chose **Yes**, enter the **Management Center/CDO Hostname/IP Address**.

c) Specify the **Management Center/CDO Registration Key**.

This key is a one-time registration key of your choice that you will also specify on the management center when you register the firewall. The registration key must not exceed 37 characters. Valid characters include alphanumerical characters (A–Z, a–z, 0–9) and the hyphen (-). This ID can be used for multiple firewalls registering to the management center.

d) Specify a **NAT ID**.

This ID is a unique, one-time string of your choice that you will also specify on the management center. We recommend that you specify the NAT ID even if you know the IP addresses of both devices. The NAT ID must not exceed 37 characters. Valid characters include alphanumerical characters (A–Z, a–z, 0–9) and the hyphen (-). This ID *cannot* be used for any other firewalls registering to the management center. The NAT ID is used in combination with the IP address to verify that the connection is coming from the correct device; only after authentication of the IP address/NAT ID will the registration key be checked.

Step 7 Configure the **Connectivity Configuration**.

- a) Specify the **Threat Defense Hostname**.
- b) Specify the **DNS Server Group**.

Although you already set this: Choose an existing group, or create a new one. The default DNS group is called **CiscoUmbrellaDNSServerGroup**, which includes the OpenDNS servers.

- c) For the **Management Center/CDO Access Interface**, click **Management Interface**.

Step 8 Click **Connect**.

The **Registration Status** dialog box shows the current status of the management center registration.

Figure 13: Successful Connection

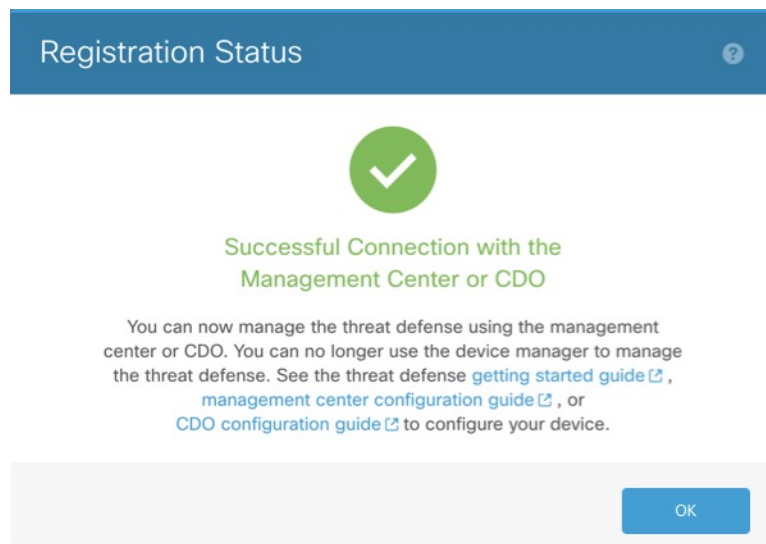

Step 9 After the **Saving Management Center/CDO Registration Settings** step on the status screen, go to the management center and add the firewall. See [Register the Firewall with the Management Center, on page 17](#).

Initial Configuration: CLI

Set the dedicated Management IP address, gateway, and other basic networking settings using the CLI setup script.

Procedure

Step 1 Connect to the console port and access the threat defense CLI. See [Access the Threat Defense CLI, on page 3](#).

Step 2 Complete the CLI setup script for the Management interface settings.

Note You cannot repeat the CLI setup script unless you clear the configuration, for example, by reimaging. However, all of these settings can be changed later at the CLI using **configure network** commands. See [Cisco Secure Firewall Threat Defense Command Reference](#).

```
You must accept the EULA to continue.
Press <ENTER> to display the EULA:
Cisco General Terms
[...]
```

```
Please enter 'YES' or press <ENTER> to AGREE to the EULA:
```

```
System initialization in progress. Please stand by.
You must configure the network to continue.
Configure at least one of IPv4 or IPv6 unless managing via data interfaces.
Do you want to configure IPv4? (y/n) [y]:
Do you want to configure IPv6? (y/n) [y]: n
```

Guidance: Enter **y** for at least one of these types of addresses.

```
Configure IPv4 via DHCP or manually? (dhcp/manual) [manual]:
Enter an IPv4 address for the management interface [192.168.45.61]: 10.89.5.17
Enter an IPv4 netmask for the management interface [255.255.255.0]: 255.255.255.192

Enter the IPv4 default gateway for the management interface [data-interfaces]: 10.10.10.1

Enter a fully qualified hostname for this system [firepower]: 1010-3
Enter a comma-separated list of DNS servers or 'none' [208.67.222.222,208.67.220.220,2620:119:35::35]:
Enter a comma-separated list of search domains or 'none' []: cisco.com
If your networking information has changed, you will need to reconnect.
Disabling IPv6 configuration: management0
Setting DNS servers: 208.67.222.222,208.67.220.220,2620:119:35::35
Setting DNS domains:cisco.com

Setting hostname as 1010-3
Setting static IPv4: 10.89.5.17 netmask: 255.255.255.192 gateway: data on management0
Updating routing tables, please wait...
All configurations applied to the system. Took 3 Seconds.
Saving a copy of running network configuration to local disk.
For HTTP Proxy configuration, run 'configure network http-proxy'
```

```
Manage the device locally? (yes/no) [yes]: no
```

Guidance: Enter **no** to use the management center.

```
Setting hostname as 1010-3
Setting static IPv4: 10.89.5.17 netmask: 255.255.255.192 gateway: data on management0
Updating routing tables, please wait...
All configurations applied to the system. Took 3 Seconds.
```

Saving a copy of running network configuration to local disk.
For HTTP Proxy configuration, run 'configure network http-proxy'

Configuring firewall mode ...

Device is in OffBox mode - disabling/removing port 443 from iptables.
Update policy deployment information
- add device configuration
- add network discovery
- add system policy

You can register the sensor to a Firepower Management Center and use the Firepower Management Center to manage it. Note that registering the sensor to a Firepower Management Center disables on-sensor Firepower Services management capabilities.

When registering the sensor to a Firepower Management Center, a unique alphanumeric registration key is always required. In most cases, to register a sensor to a Firepower Management Center, you must provide the hostname or the IP address along with the registration key.

```
'configure manager add [hostname | ip address ] [registration key ]'
```

However, if the sensor and the Firepower Management Center are separated by a NAT device, you must enter a unique NAT ID, along with the unique registration key.

```
'configure manager add DONTRESOLVE [registration key ] [ NAT ID ]'
```

Later, using the web interface on the Firepower Management Center, you must use the same registration key and, if necessary, the same NAT ID when you add this sensor to the Firepower Management Center.

>

Step 3 Identify the management center.

```
configure manager add {hostname | IPv4_address | IPv6_address | DONTRESOLVE} reg_key nat_id
```

- {hostname | IPv4_address | IPv6_address | **DONTRESOLVE**}—Specifies either the FQDN or IP address of the management center. If the management center is not directly addressable, use **DONTRESOLVE**, in which case the firewall must have a reachable IP address or hostname.
- reg_key—Specifies a one-time registration key of your choice that you will also specify on the management center when you register the threat defense. The registration key must not exceed 37 characters. Valid characters include alphanumeric characters (A–Z, a–z, 0–9) and the hyphen (-).
- nat_id—Specifies a unique, one-time string of your choice that you will also specify on the management center. The NAT ID must not exceed 37 characters. Valid characters include alphanumeric characters (A–Z, a–z, 0–9) and the hyphen (-). This ID cannot be used for any other devices registering to the management center.

Example:

```
> configure manager add fmc-1.example.com regk3y78 natid56  
Manager successfully configured.
```

Register the Firewall with the Management Center

Register the firewall to the management center.

Procedure

- Step 1** Log into the management center.
- Enter the following URL.
`https://fmc_ip_address`
 - Enter your username and password.
 - Click **Log In**.
- Step 2** Choose **Devices > Device Management**.
- Step 3** From the **Add** drop-down list, choose **Add Device**.

Figure 14: Add Device Using a Registration Key

Add Device ?

CDO Managed Device

Host:

Display Name:

Registration Key:*

Group:

Access Control Policy:*

Smart Licensing
 Note: All virtual Firewall Threat Defense devices require a performance tier license. Make sure your Smart Licensing account contains the available licenses you need. It's important to choose the tier that matches the license you have in your account. Click [here](#) for information about the Firewall Threat Defense performance-tiered licensing. Until you choose a tier, your Firewall Threat Defense virtual defaults to the FTDv50 selection.

Performance Tier (only for Firewall Threat Defense virtual 7.0 and above):

Carrier
 Malware Defense
 IPS
 URL

Advanced
Unique NAT ID:

Transfer Packets

[Cancel](#) [Register](#)

Set the following parameters:

- **Host**—Enter the IP address or hostname of the firewall you want to add, if available. Leave this field blank if it is not available.
- **Display Name**—Enter the name for the firewall as you want it to display in the management center. You cannot change this name later.
- **Registration Key**—Enter the same registration key that you specified in the firewall initial configuration.
- **Domain**—Assign the device to a leaf domain if you have a multidomain environment.

- **Group**—Assign it to a device group if you are using groups.
- **Access Control Policy**—Choose an initial policy. Unless you already have a customized policy you know you need to use, choose **Create new policy**, and choose **Block all traffic**. You can change this later to allow traffic; see [Configure an Access Control Rule, on page 35](#).

Figure 15: New Policy

New Policy

Name:
ftd-ac-policy

Description:

Select Base Policy:
None

Default Action:
 Block all traffic
 Intrusion Prevention
 Network Discovery

Cancel Save

- **Smart Licensing**—Assign the Smart Licenses you need for the features you want to deploy. **Note:** You can apply the Secure Client remote access VPN license after you add the device, from the **System > Licenses > Smart Licenses** page.
- **Unique NAT ID**—Specify the NAT ID that you specified in the firewall initial configuration.
- **Transfer Packets**—Check the **Transfer Packets** check box so that for each intrusion event, the device transfers the packet to the management center for inspection.

This option is enabled by default. For each intrusion event, the device sends event information and the packet that triggered the event to the management center for inspection. If you disable it, only event information will be sent to the management center; the packet will not be sent.

Step 4 Click **Register**.

If the threat defense fails to register, check the following items:

- **Ping**—Access the threat defense CLI (see [Access the Threat Defense CLI, on page 3](#)), and ping the management center IP address using the following command:

```
ping system fmc_ip_address
```

If the ping is not successful, check your network settings using the **show network** command. If you need to change the firewall Management IP address, use the **configure network {ipv4 | ipv6} manual** command.

- **Registration key, NAT ID, and the management center IP address**—Make sure you are using the same registration key and NAT ID on both devices. You can set the registration key and NAT ID on the firewall using the **configure manager add** command.

For more troubleshooting information, see <https://cisco.com/go/fmc-reg-error>.



CHAPTER 3

Configure a Basic Policy

Configure a basic security policy with the following settings:

- Inside and outside interfaces—Assign a static IP address to the inside interface, and use DHCP for the outside interface.
- DHCP server—Use a DHCP server on the inside interface for clients.
- Default route—Add a default route through the outside interface.
- NAT—Use interface PAT on the outside interface.
- Access control—Allow traffic from inside to outside.

You can also customize your security policy to include more advanced inspections.

- [Configure Interfaces, on page 23](#)
- [Configure the DHCP Server, on page 28](#)
- [Add the Default Route, on page 30](#)
- [Configure NAT, on page 32](#)
- [Configure an Access Control Rule, on page 35](#)
- [Deploy the Configuration, on page 37](#)

Configure Interfaces

When you use the device manager for initial setup instead of using the CLI, the following interfaces are preconfigured:

- Ethernet 1/1—**outside**, IP address from DHCP, IPv6 autoconfiguration
- VLAN1—**inside**, 192.168.95.1/24
- Default route—Obtained through DHCP on the outside interface

If you performed additional interface-specific configuration within device manager before registering with the management center, then that configuration is preserved.

If you used the CLI for initial setup, there is no preconfiguration of your device.

In both cases, you need to perform additional interface configuration after you register the device. For CLI initial setup, you must add the VLAN1 interface for the inside switch ports. Additional configuration includes

converting switch ports to firewall interfaces as desired, assigning interfaces to security zones, and changing IP addresses.

The following example configures a routed-mode inside interface (VLAN1) with a static address and a routed-mode outside interface using DHCP (Ethernet1/1). It also adds a DMZ interface for an internal web server.

Procedure

Step 1 Choose **Devices > Device Management**, and click **Edit** (✎) for the device.

Step 2 Click **Interfaces**.

Figure 16: Interfaces

Interface	Logical Name	Type	Security Zones	MAC Address (Active/Standby)	IP Address	Path Monitorin	Port Mode	VLAN Usage	SwitchPo	Virtual Router
Management1/1	management	Physical				Disabled			Global	
Ethernet1/1	outside	Physical	outside		10.89.5.29/255.255.255.192...	Disabled			Global	
Ethernet1/2		Physical				Disabled	Access	1		
Ethernet1/3		Physical				Disabled	Access	1		
Ethernet1/4		Physical				Disabled	Access	1		

Step 3 If you used the CLI for initial setup, enable the switch ports.

a) Click **Edit** (✎) for the switch port.

Figure 17: Enable Switch Port

Edit Physical Interface

General Hardware Configuration

Interface ID:
Ethernet1/2

Enabled

Description:

Port Mode:
Access

VLAN ID:
1

(1 - 4070)

Protected:

b) Enable the interface by checking the **Enabled** check box.

- c) (Optional) Change the VLAN ID; the default is 1. You will next add a VLAN interface to match this ID.
- d) Click **OK**.

Step 4 Add (or edit) the **inside** VLAN interface.

- a) Click **Add Interfaces > VLAN Interface**, or if this interface already exists, click **Edit** (✎) for the interface.

Figure 18: Add VLAN Interface

Add VLAN Interface

General IPv4 IPv6 Advanced

Name:

Enabled

Description:

Mode:

Security Zone:

MTU:
(64 - 9198)

Priority:
(0 - 65535)

VLAN ID *:
(1 - 4070)

Disable Forwarding on Interface Vlan:

Associated Interface	Port Mo...
No records to display	

- b) From the **Security Zone** drop-down list, choose an existing inside security zone or add a new one by clicking **New**. For example, add a zone called **inside_zone**. You apply your security policy based on zones or groups. If VLAN1 was preconfigured, the rest of these fields are optional.
- c) Enter a **Name** up to 48 characters in length. For example, name the interface **inside**.
- d) Check the **Enabled** check box.
- e) Leave the **Mode** set to **None**.

- f) Set the **VLAN ID** to **1**.

By default, all of the switchports are set to VLAN 1; if you choose a different VLAN ID here, you need to also edit each switchport to be on the new VLAN ID.

You cannot change the VLAN ID after you save the interface; the VLAN ID is both the VLAN tag used, and the interface ID in your configuration.

- g) Click the **IPv4** and/or **IPv6** tab.

- **IPv4**—Choose **Use Static IP** from the drop-down list, and enter an IP address and subnet mask in slash notation.

For example, enter **192.168.1.56/24**

Figure 19: Set Inside IP Address

The screenshot shows the 'Add VLAN Interface' configuration page with the 'IPv4' tab selected. The 'IP Type' dropdown menu is set to 'Use Static IP'. The 'IP Address' field contains the value '192.168.1.56/24'. Below the field, there is a small example text: 'eg. 192.0.2.1/255.255.255.128 or 192.0.2.1/25'.

- **IPv6**—Check the **Autoconfiguration** check box for stateless autoconfiguration.

- h) Click **OK**.

Step 5 Click **Edit** (✎) for Ethernet1/1 that you want to use for **outside**.

The **General** page appears.

Figure 20: General

Edit Physical Interface

General IPv4 IPv6 Path Monitoring Harc

Name:

Enabled

Management Only

Description:

Mode:

Security Zone:

Interface ID:

MTU:
(64 - 9198)

Priority:
(0 - 65535)

Propagate Security Group Tag:

NVE Only:

- From the **Security Zone** drop-down list, choose an existing outside security zone or add a new one by clicking **New**. For example, add a zone called **outside_zone**.
If VLAN1 was pre-configured, the rest of these fields are optional.
- Enter a **Name** up to 48 characters in length.
For example, name the interface **outside**.
- Check the **Enabled** check box.
- Leave the **Mode** set to **None**.
- Click the **IPv4** and/or **IPv6** tab.
 - IPv4**—Choose **Use DHCP**, and configure the following optional parameters:
 - Obtain default route using DHCP**—Obtains the default route from the DHCP server.
 - DHCP route metric**—Assigns an administrative distance to the learned route, between 1 and 255. The default administrative distance for the learned routes is 1.

Figure 21: Set Outside IP Address

Edit Physical Interface

General **IPv4** IPv6 Path Monitoring

IP Type:

Obtain default route using DHCP:

DHCP route metric:

(1 - 255)

- **IPv6**—Check the **Autoconfiguration** check box for stateless autoconfiguration.

f) Click **OK**.

Step 6 Configure a DMZ interface to host a web server, for example.

- Disable switch-port mode for the switch port you want to use for the DMZ by clicking the slider in the **SwitchPort** column so it shows as disabled (☐).
- Click **Edit** (✎) for the interface.
- From the **Security Zone** drop-down list, choose an existing DMZ security zone or add a new one by clicking **New**.
For example, add a zone called **dmz_zone**.
- Enter a **Name** up to 48 characters in length.
For example, name the interface **dmz**.
- Check the **Enabled** check box.
- Leave the **Mode** set to **None**.
- Click the **IPv4** and/or **IPv6** tab and configure the IP address as desired.
- Click **OK**.

Step 7 Click **Save**.

Configure the DHCP Server

Enable the DHCP server if you want clients to use DHCP to obtain IP addresses from the firewall.

Procedure

Step 1 Choose **Devices > Device Management**, and click **Edit** (✎) for the device.

Step 2 Choose **DHCP > DHCP Server**.

Figure 22: DHCP Server

The screenshot shows the DHCP Server configuration interface. At the top, there are tabs for Device, Routing, Interfaces, Inline Sets, DHCP (selected), VTEP, and SNMP. On the left, there are sub-sections for DHCP Server, DHCP Relay, and DDNS. The main configuration area includes:

- Ping Timeout: 50 (10 - 10000 ms)
- Lease Length: 3600 (300 - 10,48,575 sec)
- Auto-Configuration:
- Interface:
- Override Auto Configured Settings:
 - Domain Name:
 - Primary DNS Server: + Primary WINS Server: +
 - Secondary DNS Server: + Secondary WINS Server: +

 At the bottom, there is a 'Server' tab (highlighted with a red box) and an 'Advanced' section. A '+ Add' button (also highlighted with a red box) is located in the bottom right corner. Below the configuration area is a table with columns for Interface, Address Pool, and Enable DHCP Server, currently showing 'No records to display'.

Step 3 In the **Server** area, click **Add** and configure the following options.

Figure 23: Add Server

The 'Add Server' dialog box contains the following configuration options:

- Interface*:
- Address Pool*: (2.2.2.10-2.2.2.20)
- Enable DHCP Server

 At the bottom, there are 'Cancel' and 'OK' buttons.

- **Interface**—Choose the interface name from the drop-down list.
- **Address Pool**—Set the range of IP addresses. The IP addresses must be on the same subnet as the selected interface and cannot include the IP address of the interface itself.
- **Enable DHCP Server**—Enable the DHCP server on the selected interface.

Step 4 Click **OK**.

Step 5 Click **Save**.

Add the Default Route

The default route normally points to the upstream router reachable from the outside interface. If you obtained the outside address from DHCP, your device might have already received a default route. If you need to manually add the route, complete this procedure.

Procedure

Step 1 Choose **Devices > Device Management**, and click **Edit** (✎) for the device.

Step 2 Choose **Routing > Static Route**.

Figure 24: Static Route

The screenshot shows the 'Static Route' configuration page. The navigation menu on the left includes 'Device', 'Routing', 'Interfaces', 'Inline Sets', 'DHCP', 'VTEP', and 'SNMP'. Under 'Routing', 'Static Route' is highlighted. The main content area has a '+ Add Route' button in the top right. Below the button is a table with columns: Network, Interface, Leaked from Virtual Router, Gateway, Tunneled, Metric, and Tracked. The table is currently empty, with expandable sections for 'IPv4 Routes' and 'IPv6 Routes'.

If you received a default route from the DHCP server, it will show in this table.

Step 3 Click **Add Route**, and set the following options.

Figure 25: Add Static Route Configuration

Add Static Route Configuration

Type: IPv4 IPv6

Interface*
outside

(Interface starting with this icon signifies it is available for route leak)

Available Network

- any-ipv4
- gateway
- IPv4-Benchmark-Tests
- IPv4-Link-Local
- IPv4-Multicast
- IPv4-Private-10.0.0.0-8

Selected Network

- any-ipv4

Gateway*
gateway

Metric:
1
(1 - 254)

Tunneled: (Used only for default Route)

Route Tracking:

- **Type**—Click the **IPv4** or **IPv6** radio button depending on the type of static route that you are adding.
- **Interface**—Choose the egress interface; typically the outside interface.
- **Available Network**—Choose **any-ipv4** for an IPv4 default route, or **any-ipv6** for an IPv6 default route, and click **Add** to move it to the **Selected Network** list.
- **Gateway** or **IPv6 Gateway**—Enter or choose the gateway router that is the next hop for this route. You can provide an IP address or a Networks/Hosts object.

Step 4 Click **OK**.

The route is added to the static route table.

Step 5 Click **Save**.

Configure NAT

This procedure creates a NAT rule for internal clients to convert the internal addresses to a port on the outside interface IP address. This type of NAT rule is called *interface Port Address Translation (PAT)*.

Procedure

Step 1 Choose **Devices > NAT**, and click **New Policy**.

Step 2 Name the policy, select the devices that you want to use the policy, and click **Save**.

Figure 26: New Policy

New Policy ⓘ

Name:
FTD_policy

Description:

Targeted Devices
Select devices to which you want to apply this policy.

Available Devices and Templates
Q Search by name or value

192.168.0.124
192.168.0.155

Selected Devices and Templates

192.168.0.124	✕
192.168.0.155	✕

Add to Policy

Cancel **Save**

The policy is added the management center. You still have to add rules to the policy.

Figure 27: NAT Policy

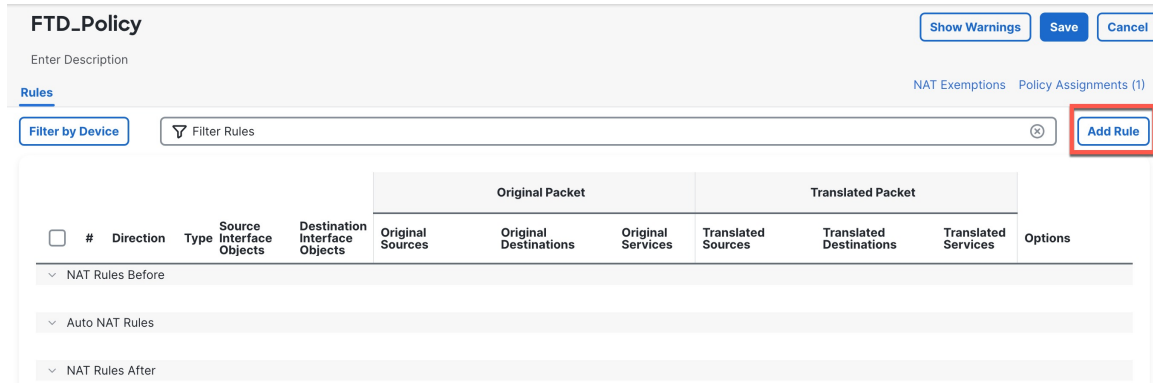

Step 3 Click **Add Rule**.

Step 4 Configure the basic rule options:

Figure 28: Basic Rule Options

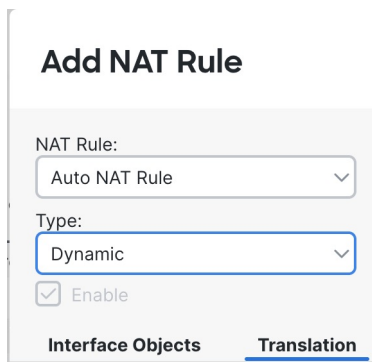

- **NAT Rule**—Choose **Auto NAT Rule**.
- **Type**—Choose **Dynamic**.

Step 5 On the **Interface Objects** page, add the outside zone from the **Available Interface Objects** area to the **Destination Interface Objects** area.

Figure 29: Interface Objects

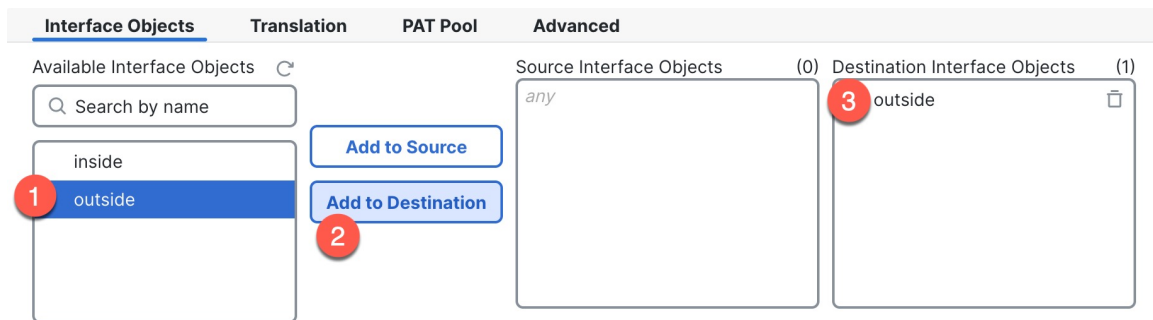

Step 6 On the **Translation** page, configure the following options:

Figure 30: Translation

Interface Objects	Translation	PAT Pool	Advanced
Original Packet		Translated Packet	
Original Source:* <input type="text" value="all-ipv4"/> +		Translated Source: <input type="text" value="Destination Interface IP"/>	
Original Port: <input type="text" value="TCP"/>		Translated Port: <input type="text"/>	

Note: The 'Translated Source' dropdown is highlighted with a red box and contains a message: "The values selected for Destination Interface Objects in 'Interface Objects' tab will be used".

- **Original Source**—Click **Add (+)** to add a network object for all IPv4 traffic (**0.0.0.0/0**).

Figure 31: New Network Object

New Network Object

Name

Description

Network
 Host Range Network FQDN

Allow Overrides

Note You cannot use the system-defined **any-ipv4** object, because Auto NAT rules add NAT as part of the object definition, and you cannot edit system-defined objects.

- **Translated Source**—Choose **Destination Interface IP**.

Step 7 Click **Save** to add the rule.

The rule is saved to the **Rules** table.

Step 8 Click **Save** on the NAT page to save your changes.

Configure an Access Control Rule

If you created a basic **Block all traffic** access control policy when you registered the device, then you need to add rules to the policy to allow traffic through the device. The access control policy can include multiple rules that are evaluated in order.

This procedure creates an access control rule to allow all traffic from the inside zone to the outside zone.

Procedure

- Step 1** Choose **Policy > Access Policy > Access Policy**, and click **Edit** (✎) for the access control policy assigned to the device.
- Step 2** Click **Add Rule**, and set the following parameters.

Figure 32: Source Zone

The screenshot shows the 'Add Rule' configuration interface. At the top, the rule name is 'inside-to-outside' (marked with a red circle and '1'). The action is set to 'Allow'. Below, the 'Zones' tab is selected, showing a list of zones: 'inside' (Routed Security Zone) is checked (marked with a red circle and '2'), and 'outside' (Routed Security Zone) is unchecked. A red circle with the number '3' highlights the 'Add Source Zone' button at the bottom right.

1. Name this rule, for example, **inside-to-outside**.
2. Select the inside zone from **Zones**
3. Click **Add Source Zone**.

Figure 33: Destination Zone

The screenshot shows the 'Add Rule' configuration interface. The rule name is 'inside-to-outside'. The 'Zones' tab is active, showing both 'inside' and 'outside' (Routed Security Zones) selected as source zones (marked with a red circle and '4'). The 'Add Destination Zone' button at the bottom right is highlighted with a red circle and the number '5'. The 'Add Source Zone' button is also visible.

4. Select the outside zone from **Zones**.

5. Click **Add Destination Zone**.

Leave the other settings as is.

Step 3 (Optional) Customize associated policies by clicking on the policy type in the packet flow diagram.

Prefilter, Decryption, Security Intelligence, and Identity policies are applied before an access control rule. Customizing these policies is not required, but after you know your network's needs, they let you improve network performance by either fastpathing trusted traffic (bypassing processing) or blocking traffic so no further processing is required.

Figure 34: Policies Applied Before Access Control

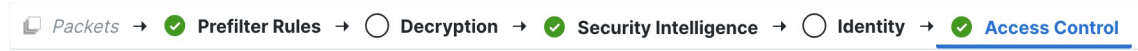

- **Prefilter Rules**—The Default Prefilter Policy passes all traffic for the other rules to act on (analyzes). The only change to the default policy you can make is to **block** tunnel traffic. Otherwise, you can create a new prefilter policy to associate with the access control policy that can analyze (pass on), fastpath (bypass further checks) or block.

Prefiltering lets you improve performance by dealing with traffic before it gets any further, by either blocking or fastpathing. In a new policy, you can add *tunnel* rules and *prefilter* rules. A tunnel rule lets you fastpath, block, or rezone plaintext (non-encrypted), passthrough tunnels. A prefilter rule lets you fastpath or block non-tunneled traffic identified by IP address, port, and protocol.

For example, if you know you want to block all FTP traffic on your network, but fastpath SSH traffic from an administrator, you can add a new prefilter policy.

- **Decryption**—Decryption is not applied by default. Decryption is a way to expose network traffic to deep inspection. In most cases, you don't want to decrypt traffic, and can only do so if it is legally allowed. For maximum network protection, a decryption policy might be a good idea for traffic going to critical servers or coming from untrusted network segments.
- **Security Intelligence**—(Requires the IPS license) Security Intelligence is enabled by default. Security Intelligence is another early defense against malicious activity applied before passing connections to the access control policy for further processing. Security Intelligence uses reputation intelligence to quickly block connections to or from IP addresses, URLs, and domain names provided by Talos, the threat intelligence organization at Cisco. You can add or delete additional IP addresses, URLs, or domains if desired.

Note If you do not have the IPS license, this policy will not be deployed even though it shows in your access control policy as enabled.

- **Identity**—Identity is not applied by default. You can require a user to authenticate before allowing traffic to be processed by the access control policy.

Step 4 (Optional) Add an Intrusion policy that is applied after the access control rule.

The Intrusion policy is a defined set of intrusion detection and prevention configurations that inspects traffic for security violations. The management center includes many system-provided policies you can enable as-is or that you can customize. This step enables a system-provided policy.

- Click the **Intrusion Policy** drop-down list.

Figure 35: System-Provided Intrusion Policies

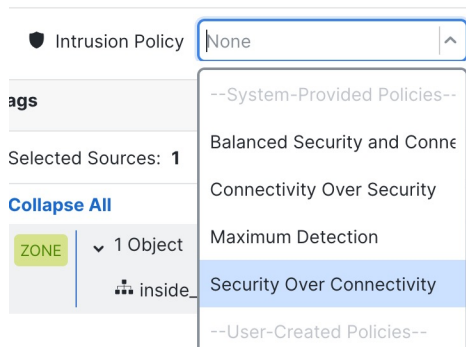

- b) Choose one of the system-provided policies from the list.

Step 5

(Optional) Add a File policy that is applied after the access control rule.

- a) Click the **File Policy** drop-down list and choose either an existing policy or add one by choosing the **Open File Policy List**.

Figure 36: File Policy

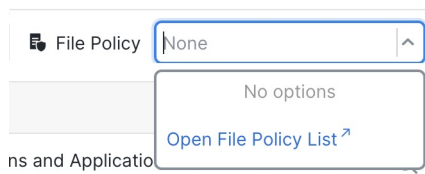

For a new policy, the **Policies > Malware & File** page opens in a separate tab.

- b) See the [Cisco Secure Firewall Device Manager Configuration Guide](#) for details on creating the policy.
- c) Return to the **Add Rule** page and select the newly created policy from the drop-down list.

Step 6

Click **Apply**.

The rule is added to the **Rules** table.

Step 7

Click **Save**.

Deploy the Configuration

Deploy the configuration changes to the device; none of your changes are active on the device until you deploy them.

Procedure**Step 1**

Click **Deploy** in the upper right.

Figure 37: Deploy

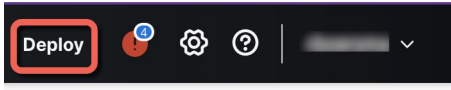

Step 2 For a quick deployment, check specific devices and then click **Deploy**.

Figure 38: Deploy Selected

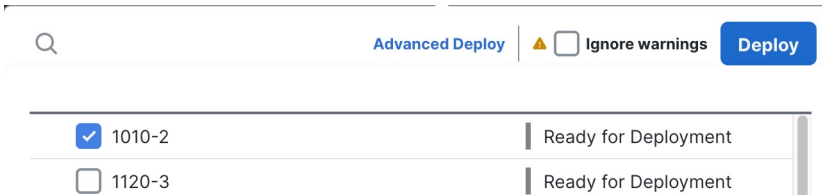

Or click **Deploy All** to deploy to all devices.

Figure 39: Deploy All

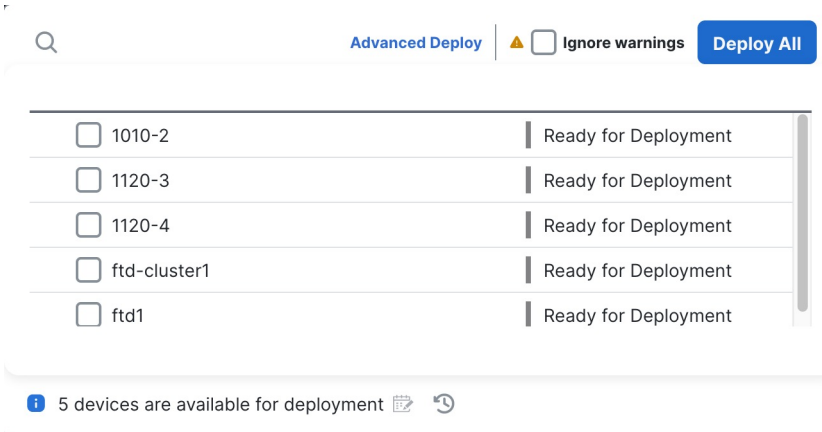

Otherwise, for additional deployment options, click **Advanced Deploy**.

Figure 40: Advanced Deployment

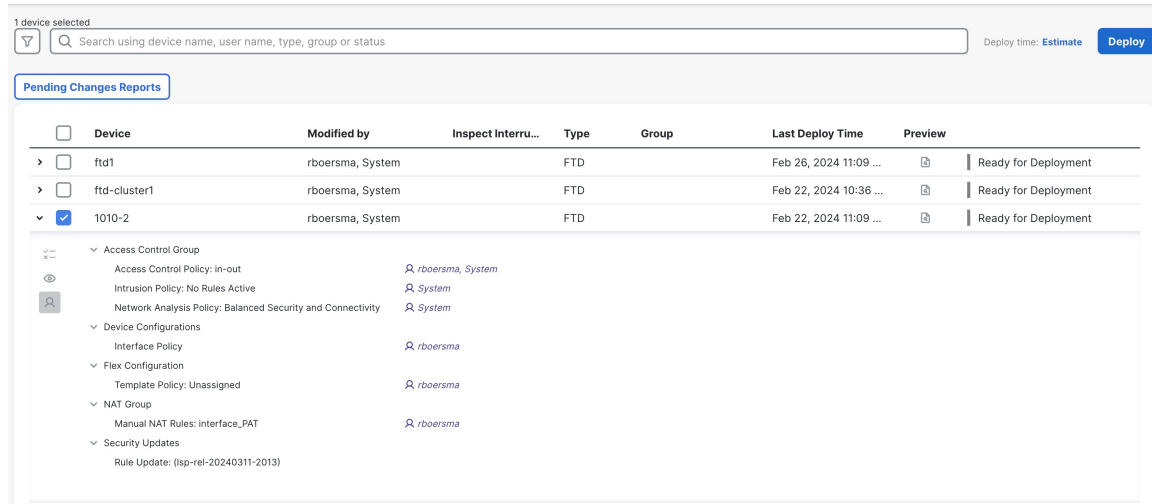

Step 3

Ensure that the deployment succeeds. Click the icon to the right of the **Deploy** button in the menu bar to see status for deployments.

Figure 41: Deployment Status

