



Cisco Content Security Management Appliance M195, M395, M695, and M695F Hardware Installation Guide

First Published: 2019-07-08

Last Modified: 2021-07-19

Americas Headquarters

Cisco Systems, Inc.
170 West Tasman Drive
San Jose, CA 95134-1706
USA
<http://www.cisco.com>
Tel: 408 526-4000
800 553-NETS (6387)
Fax: 408 527-0883

THE SPECIFICATIONS AND INFORMATION REGARDING THE PRODUCTS IN THIS MANUAL ARE SUBJECT TO CHANGE WITHOUT NOTICE. ALL STATEMENTS, INFORMATION, AND RECOMMENDATIONS IN THIS MANUAL ARE BELIEVED TO BE ACCURATE BUT ARE PRESENTED WITHOUT WARRANTY OF ANY KIND, EXPRESS OR IMPLIED. USERS MUST TAKE FULL RESPONSIBILITY FOR THEIR APPLICATION OF ANY PRODUCTS.

THE SOFTWARE LICENSE AND LIMITED WARRANTY FOR THE ACCOMPANYING PRODUCT ARE SET FORTH IN THE INFORMATION PACKET THAT SHIPPED WITH THE PRODUCT AND ARE INCORPORATED HEREIN BY THIS REFERENCE. IF YOU ARE UNABLE TO LOCATE THE SOFTWARE LICENSE OR LIMITED WARRANTY, CONTACT YOUR CISCO REPRESENTATIVE FOR A COPY.

The Cisco implementation of TCP header compression is an adaptation of a program developed by the University of California, Berkeley (UCB) as part of UCB's public domain version of the UNIX operating system. All rights reserved. Copyright © 1981, Regents of the University of California.

NOTWITHSTANDING ANY OTHER WARRANTY HEREIN, ALL DOCUMENT FILES AND SOFTWARE OF THESE SUPPLIERS ARE PROVIDED "AS IS" WITH ALL FAULTS. CISCO AND THE ABOVE-NAMED SUPPLIERS DISCLAIM ALL WARRANTIES, EXPRESSED OR IMPLIED, INCLUDING, WITHOUT LIMITATION, THOSE OF MERCHANTABILITY, FITNESS FOR A PARTICULAR PURPOSE AND NON-INFRINGEMENT OR ARISING FROM A COURSE OF DEALING, USAGE, OR TRADE PRACTICE.

IN NO EVENT SHALL CISCO OR ITS SUPPLIERS BE LIABLE FOR ANY INDIRECT, SPECIAL, CONSEQUENTIAL, OR INCIDENTAL DAMAGES, INCLUDING, WITHOUT LIMITATION, LOST PROFITS OR LOSS OR DAMAGE TO DATA ARISING OUT OF THE USE OR INABILITY TO USE THIS MANUAL, EVEN IF CISCO OR ITS SUPPLIERS HAVE BEEN ADVISED OF THE POSSIBILITY OF SUCH DAMAGES.

Any Internet Protocol (IP) addresses and phone numbers used in this document are not intended to be actual addresses and phone numbers. Any examples, command display output, network topology diagrams, and other figures included in the document are shown for illustrative purposes only. Any use of actual IP addresses or phone numbers in illustrative content is unintentional and coincidental.

All printed copies and duplicate soft copies of this document are considered uncontrolled. See the current online version for the latest version.

Cisco has more than 200 offices worldwide. Addresses and phone numbers are listed on the Cisco website at www.cisco.com/go/offices.

Cisco and the Cisco logo are trademarks or registered trademarks of Cisco and/or its affiliates in the U.S. and other countries. To view a list of Cisco trademarks, go to this URL: <https://www.cisco.com/c/en/us/about/legal/trademarks.html>. Third-party trademarks mentioned are the property of their respective owners. The use of the word partner does not imply a partnership relationship between Cisco and any other company. (1721R)

© 2019-2021 Cisco Systems, Inc. All rights reserved.



CONTENTS

CHAPTER 1

Overview 1

- Features 1
- Package Contents 3
- Serial Number Locations 4
- Front Panel 6
- Front Panel LEDs 9
- Rear Panel 12
- Rear Panel LEDs 14
- Power Supply 15
- Hardware Specifications 17
- Product ID Numbers 18
- Power Cord Specifications 19

CHAPTER 2

Installation Preparation 27

- Installation Warnings 27
- Safety Recommendations 29
- Maintain Safety with Electricity 29
- Prevent ESD Damage 30
- Site Environment 30
- Site Considerations 31
- Power Supply Considerations 31
- Rack Configuration Considerations 31

CHAPTER 3

Rack-Mount the Chassis 33

- Unpack and Inspect the Chassis 33
- Rack-Mount the Chassis 33

CHAPTER 4

Maintenance and Upgrade 37

Power Button Shut Down 37

Enable RPC 38

Reset the Chassis Remotely 39

Install/Uninstall the Locking Faceplate 39

Remove and Replace a Drive 40

Remove and Replace a Power Supply 43



CHAPTER 1

Overview

- [Features, on page 1](#)
- [Package Contents, on page 3](#)
- [Serial Number Locations, on page 4](#)
- [Front Panel, on page 6](#)
- [Front Panel LEDs, on page 9](#)
- [Rear Panel, on page 12](#)
- [Rear Panel LEDs, on page 14](#)
- [Power Supply, on page 15](#)
- [Hardware Specifications, on page 17](#)
- [Product ID Numbers, on page 18](#)
- [Power Cord Specifications, on page 19](#)

Features

The Cisco Content Security Management Appliances (SMA) M195, M395, M695, and M695F centralize reporting, tracking, management of quarantined email messages, and web security appliance configuration settings. They also allow automated data backups.

The SMA M195, M395, M695, and M695F support Cisco AsyncOS version 12.5 and later. See [Product ID Numbers, on page 18](#) for a list of field-replaceable product IDs (PIDs) associated with the SMA security management appliances.

The following figures show the Cisco Content Security Appliances.

Figure 1: Cisco Content Security M195 and M395



Figure 2: Cisco Content Security M695 and M695F



The following table lists the features of the SMA M195, M395, M695, and M695F.

Table 1: SMA M195, M395, M695, and M695F Features

Feature	M195	M395	M695	M695F
Form factor	1 RU		2 RU	
Rack mount	Standard 19-inch (48.3 cm) 4-post EIA rack			
Airflow	Front to rear Cold aisle to hot aisle			
Pullout asset card	Displays the serial number			
Grounding holes	Two threaded holes for dual-hole grounding lug Use is optional; the supported AC power supplies have internal grounding, so no additional chassis grounding is required.			
Locking faceplate	Optional			
Unit identification button	On front panel			
Power button	On rear panel			
Processor	Before January 2021: One Intel Xeon 4110 After January 2021: One Intel Xeon 4210	Before January 2021: One Intel Xeon 4116 After January 2021: One Intel Xeon 4216	Before January 2021: Two Intel Xeon 4110 After January 2021: Two Intel Xeon 4210	
Memory	16-GB RAM		32-GB RAM	
RDIMMs Internal component only; not field-replaceable	Before January 2021: One 16-GB DDR4-2400-MHz DIMM After January 2021: One 16-GB DDR4-2933-MHz DIMM		Before January 2021: Two 16-GB DDR4-2400-MHz DIMMs After January 2021: Two 16-GB DDR4-2933-MHz DIMMs	
Management port	One built-in port (DATA 1)	One built-in port (MGMT)		

Feature	M195	M395	M695	M695F
Network ports	One Gigabit Ethernet (DATA 2)	Five Gigabit Ethernet (DATA 1, DATA 2, DATA 3, DATA 4, DATA 5)		One Gigabit Ethernet (DATA 1) Two fiber optic (DATA 2 and DATA 3)
Remote power cycling (RPC)	Accessed through the 1-Gb dedicated port			
USB ports	Two USB 3.0 Type A			
SFP+ ports	No			Two fiber optic
Supported SFP+	—			GLC-SX-MMD (1 Gb) (optional) SFP-10G-SR (10 Gb) (optional)
Serial console port	One 1-Gb RJ-45 serial port running RS-232 (RS-232D TIA-561) Directly connects a computer to the chassis			
AC power supply Note Do not mix power supply type or wattage between models.	One 770-W AC You can order a second power supply for redundancy as 1+1.	Two 770-W AC Hot-swappable and redundant as 1+1	Two 1050-W AC Hot-swappable and redundant as 1+1	
Fans	Six fans for front-to-rear cooling Internal component only; not field-replaceable. If one fan fails, you must send your chassis for return material authorization (RMA).			
Storage	Two 600-GB SAS HDDs RAID 1, hot-swappable	Eight 600-GB SAS HDDs RAID 10, hot-swappable	Sixteen 600-GB SAS HDDs RAID 10, hot-swappable	

Package Contents

The following figure shows the package contents for the SMA M195, M395, M695, and M695F. Note that the contents are subject to change and your exact contents might contain additional or fewer items.

Figure 3: Package Contents

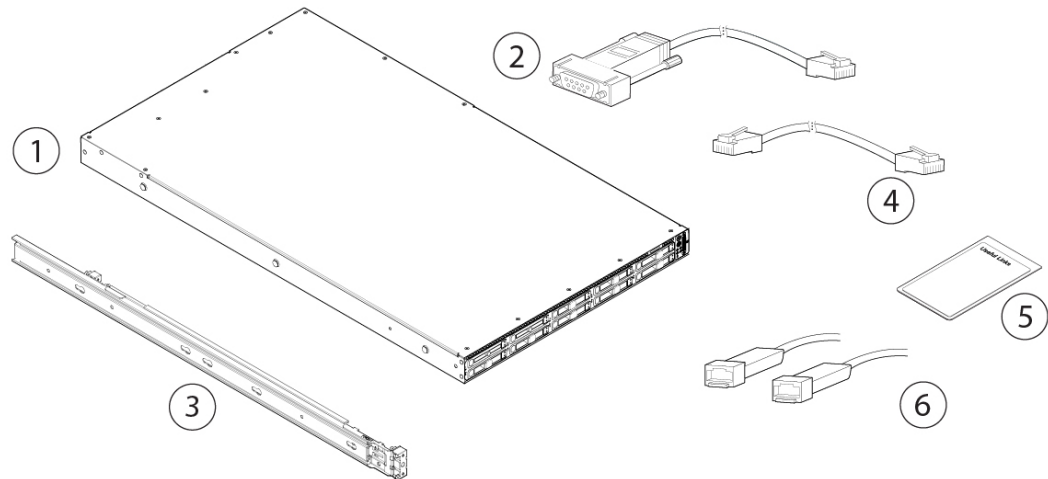

1	Chassis	2	RJ-45 to DB9-RS232 console cable (Cisco part number 72-3383-XX)
3	Cisco rail kit (Cisco part number 800-43376-02)	4	RJ-45 to RJ-45 Cat 5 Ethernet cable, yellow six feet long (Cisco part number 72-1482-XX)
5	Useful Links document The steps in the Useful Links document send you to the documentation you need to install, set up, and configure your SMA appliance.	6	Two 1-Gb or 10-Gb SFP+ fiber optic transceivers with cables Note Supported on the M695F. You cannot mix SFP transceiver types in the same chassis. You can either have two 1-Gb or two 10-Gb SFPs in the same chassis.

Serial Number Locations

The serial number (SN) for the SMA M195, M395, M695, and M695F is printed on the pullout asset card located on the front panel as shown in the following figure.

Figure 4: Serial Number on Pullout Asset Card

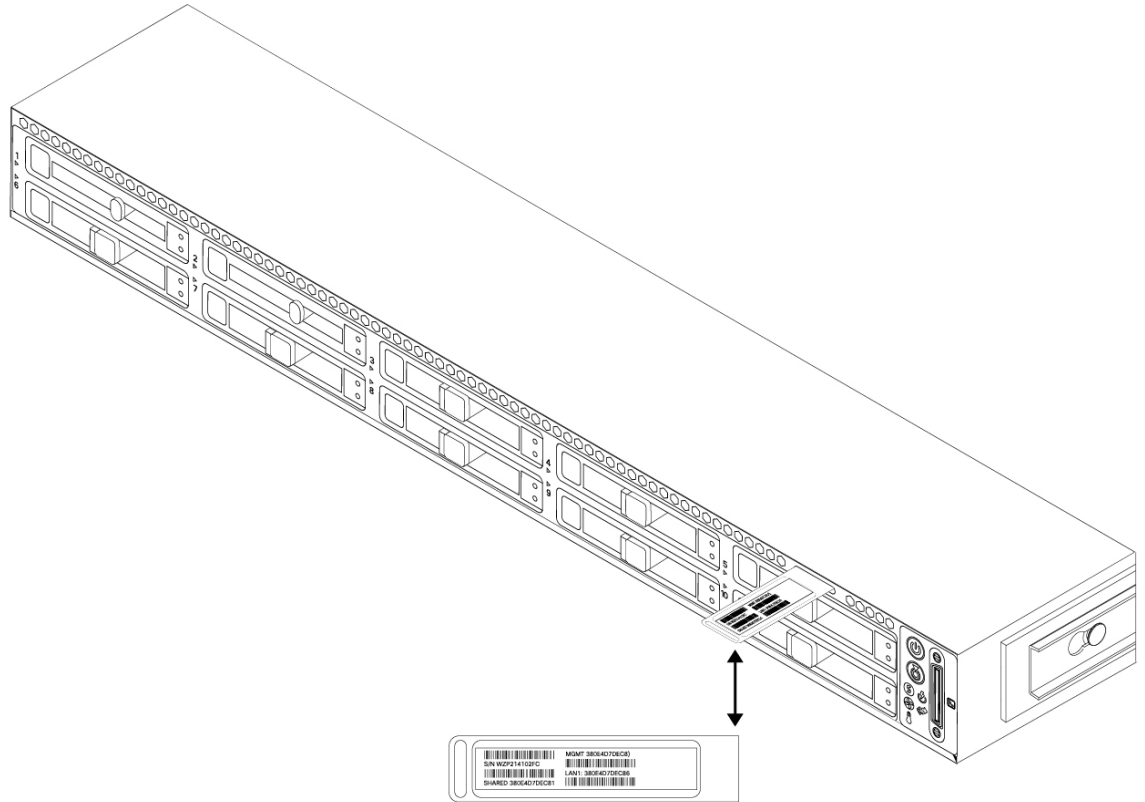

The serial number is also on the label on the cover of the chassis as shown in the following figure.



Caution

The cover latch on the top of the chassis cover is not supported. There are no internal field-replaceable parts in the SMA M195, M395, M695, and M695F.

Figure 5: Serial Number Location on Cover

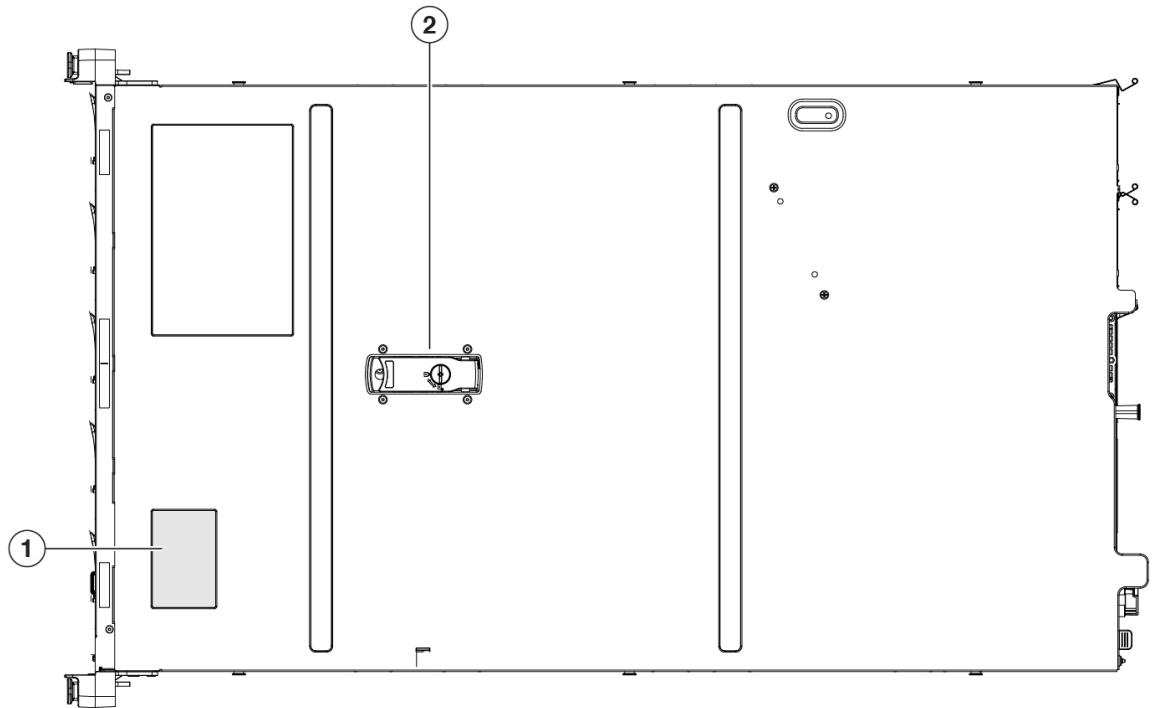

1	Serial number label	2	Cover latch Not supported
----------	---------------------	----------	------------------------------

Front Panel

The following figure shows the front panel features and disk-drive configuration for the SMA M195. See [Front Panel LEDs, on page 9](#) for a description of the LEDs.

Figure 6: M195 Front Panel

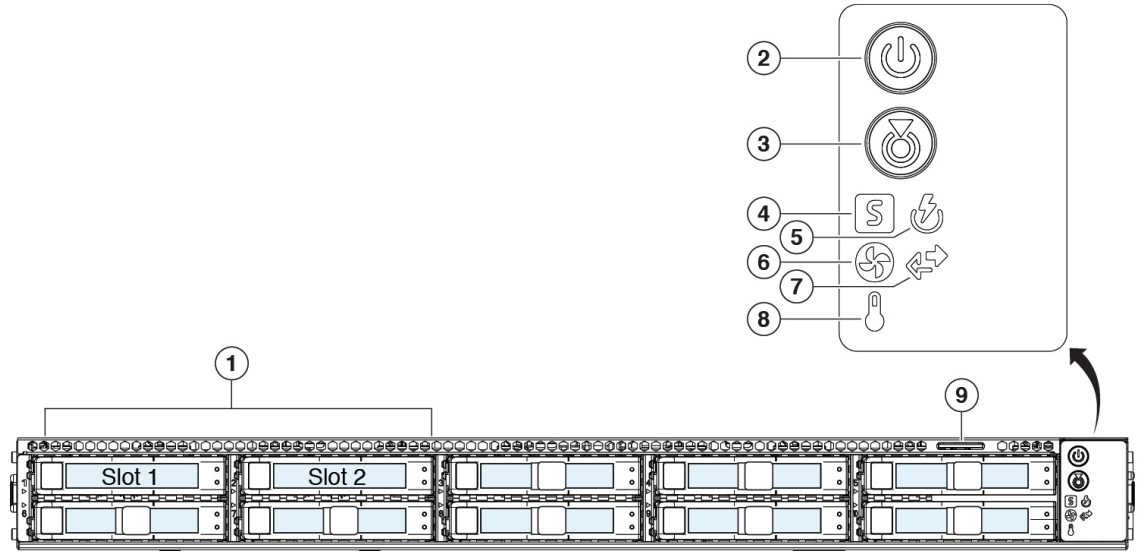

1	Drive bays Supports two 600-GB SAS HDDs in slots 1 and 2	2	Power button/power status LED
3	Unit identification button/LED	4	System status LED
5	Power supply status LED	6	Fan status LED
7	Network link activity LED	8	Temperature status LED
9	Pullout asset card	—	

The following figure shows the front panel features and disk-drive configuration for the SMA M395. See [Front Panel LEDs](#), on page 9 for a description of the LEDs.

Figure 7: M395 Front Panel

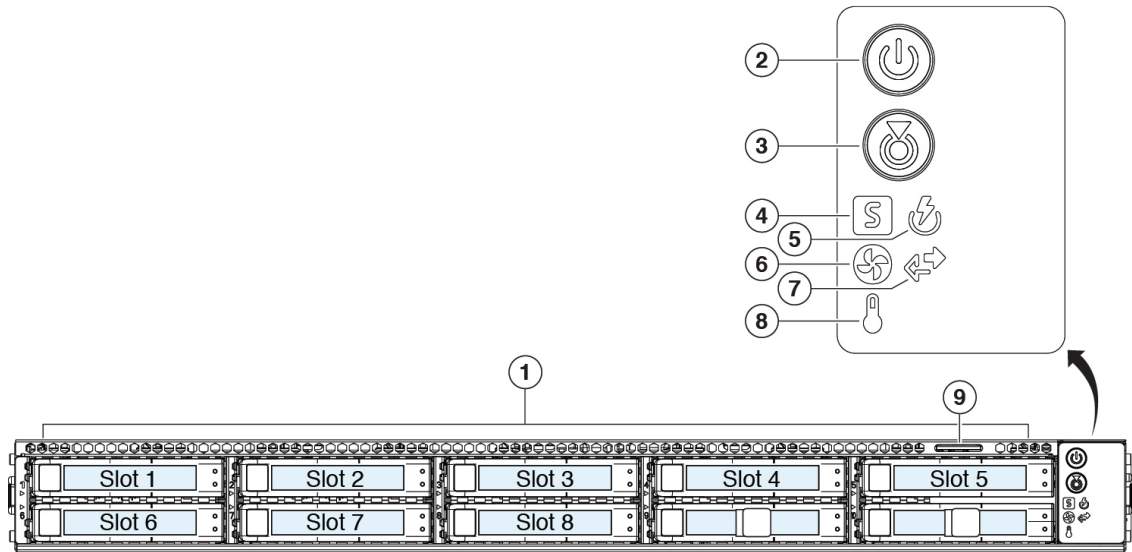

1 Drive bays Supports eight 600-GB SAS HDDs in slots 1 through 8	2 Power button/power status LED
3 Unit identification button/LED	4 System status LED
5 Power supply status LED	6 Fan status LED
7 Network link activity LED	8 Temperature status LED
9 Pullout asset card	—

The following figure shows the front panel features and disk-drive configuration for the SMA M695 and M695F. See [Front Panel LEDs](#), on page 9 for a description of the LEDs.

Figure 8: M695 and M695F Front Panel

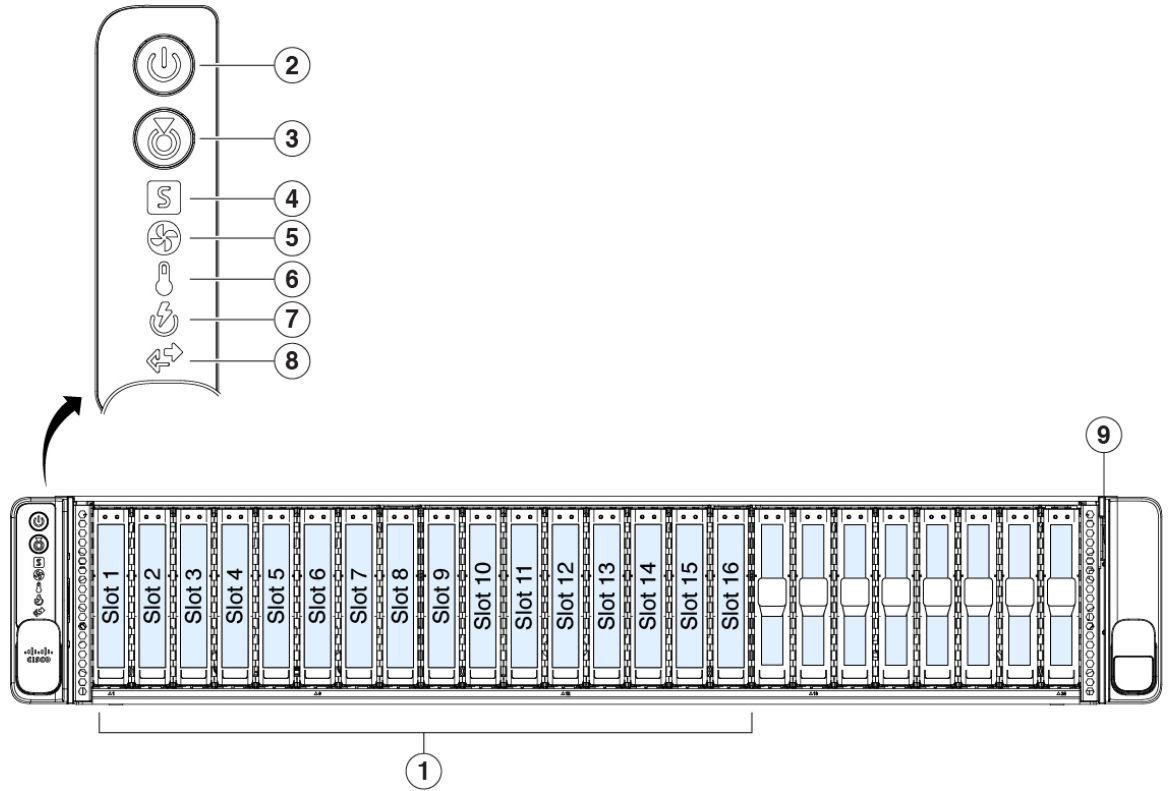

1	Drive bays Supports sixteen 600-GB SAS HDDs in slots 1 through 16	2	Power button/power status LED
3	Unit identification button/LED	4	System status LED
5	Fan status LED	6	Temperature status LED
7	Power supply status LED	8	Network link activity LED
9	Pullout asset card		—

Front Panel LEDs

The following figure shows the front panel LEDs for the M195, M395, M695, and M695F, and describes their states.

Figure 9: Front Panel LEDs and Their States

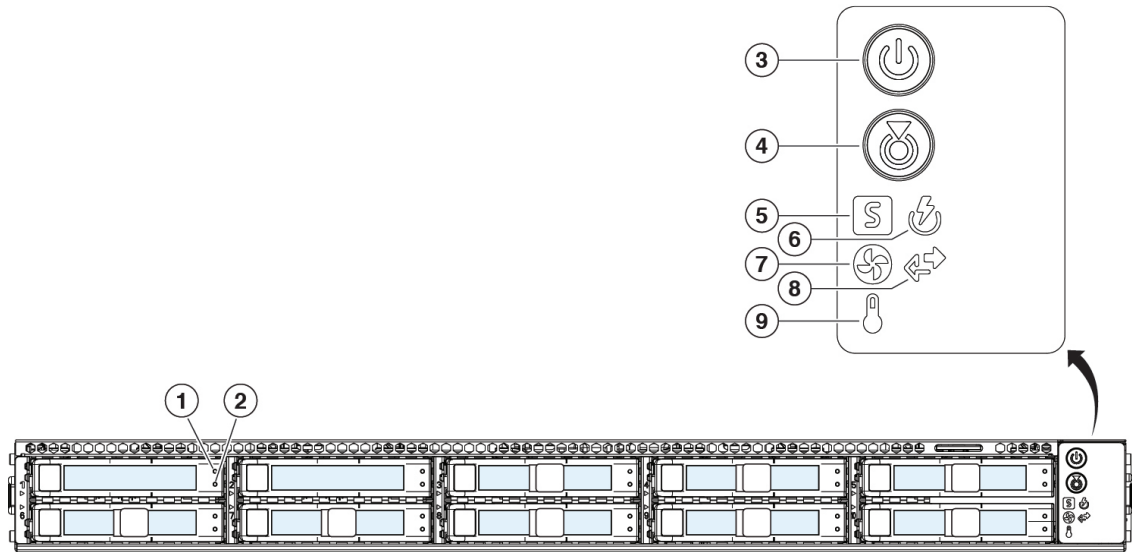

<p>1 Drive fault LED:</p> <ul style="list-style-type: none"> • Off—The drive is operating properly. • Amber—Drive fault detected. • Amber, flashing—The drive is rebuilding. • Amber, flashing with 1-second interval—Drive locate function activated in the software. 	<p>2 Drive activity LED:</p> <ul style="list-style-type: none"> • Off—There is no drive in the drive tray (no access, no fault). • Green—The drive is ready. • Green, flashing—The drive is reading or writing data.
<p>3 Power LED:</p> <ul style="list-style-type: none"> • Off—There is no AC power to the chassis. • Amber—The chassis is in standby mode. • Green—The chassis is in main power mode. Power is supplied to all components. 	<p>4 Unit identification LED:</p> <ul style="list-style-type: none"> • Off—The unit identification function is not in use. • Blue, flashing—The unit identification function is activated.

5	<p>System status LED:</p> <ul style="list-style-type: none"> • Green—The chassis is running in normal operating condition. • Green, flashing—The chassis is performing system initialization and memory check. • Amber—The chassis is in a degraded operational state (minor fault). <ul style="list-style-type: none"> • Power supply redundancy is lost. • CPUs are mismatched. • At least one CPU is faulty. • At least one DIMM is faulty. • At least one drive in a RAID configuration failed. • Amber, 2 flashes—There is a major fault with the system board. • Amber, 3 flashes—There is a major fault with the DIMMs. • Amber, 4 flashes—There is a major fault with the CPUs. 	6	<p>Power supply status LED:</p> <ul style="list-style-type: none"> • Green—All power supplies are operating normally. • Amber—One or more power supplies are in a degraded operational state. • Amber, flashing—One or more power supplies are in a critical fault state.
7	<p>Fan status LED:</p> <ul style="list-style-type: none"> • Green—All fans are operating properly. • Amber, flashing—One or more fans breached the nonrecoverable threshold. 	8	<p>Network link activity LED:</p> <ul style="list-style-type: none"> • Off—The Ethernet port link is idle. • Green—One or more Ethernet ports are link-active, but there is no activity. • Green, flashing—One or more Ethernet ports are link-active with activity.
9	<p>Temperature status LED:</p> <ul style="list-style-type: none"> • Green—The chassis is operating at normal temperature. • Amber—One or more temperature sensors breached the critical threshold. • Amber, flashing—One or more temperature sensors breached the nonrecoverable threshold. 	—	

Rear Panel

The following figure shows the rear panel of the SMA M195. See [Rear Panel LEDs, on page 14](#) for a description of the LEDs.

Figure 10: M195 Rear Panel

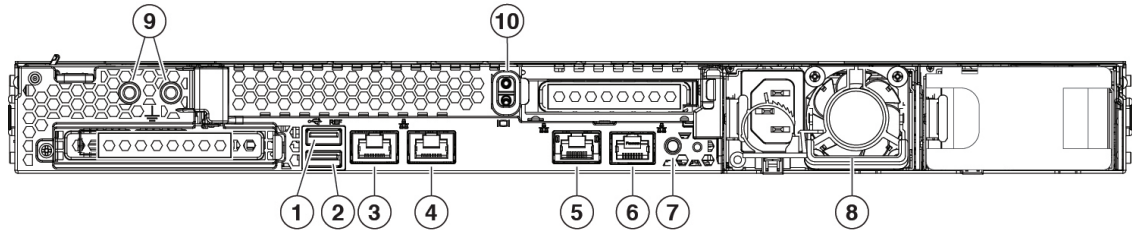

1	USB 3.0 Type A (USB 1)	2	USB 3.0 Type A (USB 2)
3	Management interface (DATA 1)	4	Data interface (DATA 2)
5	RPC port (RPC)	6	Serial console port (Console) RJ-45 connector that directly connects a computer to the appliance.
7	Unit identification button	8	One 770-W AC power supply You can order a second power supply to provide redundancy as 1 + 1.
9	Threaded holes for dual-hole grounding lug Use is optional; the supported AC power supplies have internal grounding, so no additional chassis grounding is required.	10	Riser handle Not supported

The following figure shows the rear panel of the SMA M395. See [Rear Panel LEDs, on page 14](#) for a description of the LEDs.

Figure 11: M395 Rear Panel

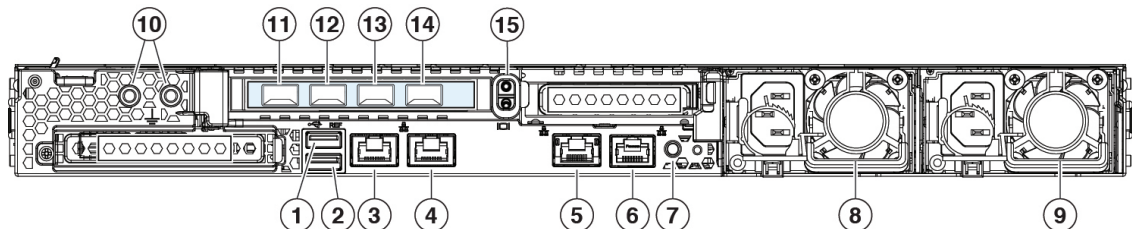

1	USB 3.0 Type A (USB 1)	2	USB 3.0 Type A (USB 2)
3	Management interface (MGMT)	4	Data interface (DATA 5)

5	RPC port (RPC)	6	Serial console port (Console) RJ-45 connector that directly connects a computer to the appliance.
7	Unit identification button	8	770-W AC power supply (PSU 1)
9	770-W AC power supply (PSU 2)	10	Threaded holes for dual-hole grounding lug Use is optional; the supported AC power supplies have internal grounding, so no additional chassis grounding is required.
11	Data interface (DATA 1)	12	Data interface (DATA 2)
13	Data interface (DATA 3)	14	Data interface (DATA 4)
15	Riser handle Not supported		—

The following figure shows the rear panel of the SMA M695. See [Rear Panel LEDs, on page 14](#) for a description of the LEDs.

Figure 12: M695 Rear Panel

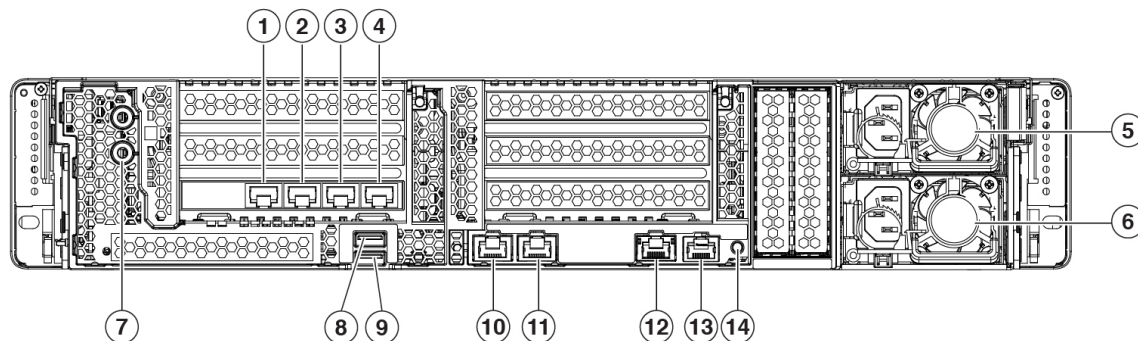

1	Data interface (DATA 1)	2	Data interface (DATA 2)
3	Data interface (DATA 3)	4	Data interface (DATA 4)
5	1050-W AC power supply (PSU1)	6	1050-W AC power supply (PSU 2)
7	Threaded holes for dual-hole grounding lug Use is optional; the supported AC power supplies have internal grounding, so no additional chassis grounding is required.	8	USB 3.0 Type A (USB 1)
9	USB 3.0 Type A (USB 2)	10	Management interface (MGMT)
11	Data interface (DATA 5)	12	RPC port (RPC)

<p>13 Serial console port (Console) RJ-45 connector that directly connects a computer to the appliance.</p>	<p>14 Unit identification button</p>
--	---

The following figure shows the rear panel of the SMA M695F. See [Rear Panel LEDs](#), on page 14 for a description of the LEDs.

Figure 13: M695F Rear Panel

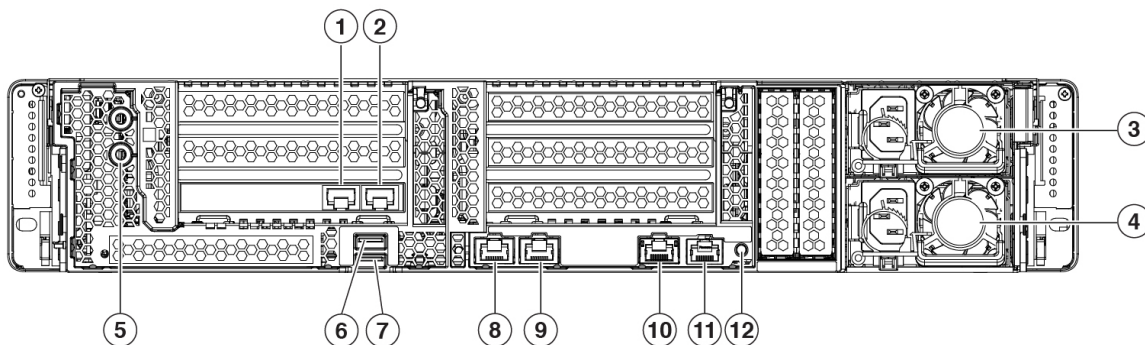

<p>1 Data interface (DATA 2) 1/10-Gigabit SFP+ fiber optic support Use only Cisco-supported SFP+ transceivers.</p>	<p>2 Data interface (DATA 3) 1/10-Gigabit SFP+ fiber optic support Use only Cisco-supported SFP+ transceivers.</p>
<p>3 1050-W AC power supply (PSU 1)</p>	<p>4 1050-W AC power supply (PSU 2)</p>
<p>5 Threaded holes for dual-hole grounding lug Use is optional; the supported AC power supplies have internal grounding, so no additional chassis grounding is required.</p>	<p>6 USB 3.0 Type A (USB 1)</p>
<p>7 USB 3.0 Type A (USB 2)</p>	<p>8 Management interface (MGMT)</p>
<p>9 Data interface (DATA 1)</p>	<p>10 RPC port (RPC)</p>
<p>11 Serial console port (Console) RJ-45 connector that directly connects a computer to the appliance.</p>	<p>12 Unit identification button</p>

Rear Panel LEDs

The following figure shows the rear panel LEDs of the SMA M195 model and describes the LED states. The M395, M695, and M695F have the same LEDs except that these models have more data interfaces; the speed and status LED descriptions are the same.

Figure 14: Rear Panel LEDs and Their States

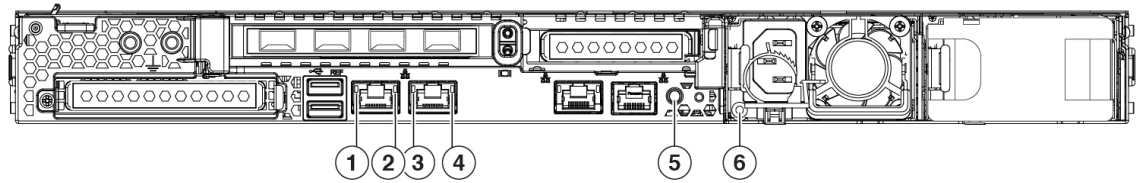

1 Management interface link speed: <ul style="list-style-type: none"> • Off—Link speed is 100 Mbps. • Amber—Link speed is 1 Gbps. • Green—Link speed is 10 Gbps. 	2 Management interface link status: <ul style="list-style-type: none"> • Off—No link is present. • Green—Link is active. • Green, flashing—Traffic is present on the active link.
3 Data interface link speed: <ul style="list-style-type: none"> • Off—Link speed is 10 Mbps. • Amber—Link speed is 100 Mbps. • Green—Link speed is 1 Gbps. 	4 Data interface link status: <ul style="list-style-type: none"> • Off—No link is present. • Green—Link is active. • Green, flashing—Traffic is present on the active link.
5 Rear unit identification: <ul style="list-style-type: none"> • Off—The unit identification function is not in use. • Blue, flashing—The unit identification function is activated. 	6 Power supply (one LED for each power supply): <ul style="list-style-type: none"> • Off—No AC input (12-V main power off; 12-V standby power off) • Green, flashing—12-V main power off; 12-V standby power on. • Green—12-V main power on; 12-V standby power on. • Amber, flashing—Warning threshold detected but 12-V main power on. • Amber—Critical error detected; 12-V main power off (for example, overcurrent, overvoltage, or overtemperature failure).

Power Supply



Note Make sure that one power supply is always active.

The following table lists the specifications for the 770-W AC power supply (Cisco part number 341-0591-04) used in the SMA M195 and M395.

Table 2: 770-W Power Supply Specifications

Description	Specification
AC input voltage range	Nominal range: 100 to 120 V AC, 200 to 240 V AC Range: 90–132 V AC, 180–264 V AC
AC input frequency	Nominal range: 50–60 Hz Range: 47–63 Hz
Maximum AC input current	9.5 A peak at 100-V AC 4.5 A peak at 208 V AC
Maximum input volt amperes	950 VA at 100 V AC
Maximum output power for each power supply	770 W
Maximum inrush current	15 A (subcycle duration)
Maximum hold-up time	12 ms at 770 W
Power supply output voltage	12 V DC
Power supply standby voltage	12 V DC
Efficiency rating	Climate Savers Platinum Efficiency (80 Plus Platinum certified)
Form factor	RSP2
Input connector	IEC320 C13/C15

The following table lists the specifications for the 1050-W AC power supply (Cisco part number 341-0638-03) used in the SMA M695 and 695F.

Table 3: 1050-W Power Supply Specifications

Description	Specification
AC input voltage range	Nominal range: 100 to 120 V AC, 200 to 240 V AC Range: 90–132 V AC, 180–264 V AC
AC input frequency	Nominal range: 50–60 Hz Range: 47–63 Hz
Maximum AC input current	12.5 A peak at 100 V AC 6.0 A peak at 208 V AC
Maximum input volt amperes	1250 VA at 100 V AC

Description	Specification
Maximum output power for each power supply	1050 W
Maximum inrush current	15 A (subcycle duration)
Maximum hold-up time	12 ms at 1050 W
Power supply output voltage	12 V DC
Power supply standby voltage	12 V DC
Efficiency rating	Climate Savers Platinum Efficiency (80 Plus Platinum certified)
Form factor	RSP2
Input connector	IEC320 C13/14/15

Hardware Specifications

The following table lists the hardware specifications for the SMA M195, M395, M695, and M695F.

Table 4: M195, M395, M695, and M695F Hardware Specifications

Specification	M195	M395	M695	M695F
Dimensions (H x W x D)	1.7 x 16.89 x 29.8 inches (4.32 x 43.0 x 75.6 cm)		3.4 x 16.9 x 29.5 inches (8.64 x 42.92 x 74.93 cm)	
Weight	30.5 lbs (13.84 kg)	35.3 lbs (16.01 kg)	51.2 lbs (23.22 kg)	51.4 lbs (23.31 kg)
Temperature	Operating: 41 to 95°F (5 to 35°C) Derate the maximum temperature by 1°C for every 1000 ft (305 m) of altitude above sea level. Nonoperating: -40 to 149°F (-40 to 65°C) When stored or transported			
Relative humidity	Operating: 10 to 90% noncondensing Nonoperating: 5 to 93% noncondensing			
Altitude	Operating: 0 to 10,000 ft Nonoperating: 0 to 40,000 ft When stored or transported			
Sound power level	5.5 Bels (measure A-weighted per ISO7779 LWAd) Operation at 73°F (23°C)			

Specification	M195	M395	M695	M695F
Sound pressure level	40 dBa (measure A-weighted per ISO7779 LpAM)			
	Operation at 73°F (23°C)			

Product ID Numbers

The following table lists the field-replaceable PIDs associated with SMA M195, M395, M695, and M695F. The spare components are ones that you can order and replace yourself. If any internal components fail, you must get an RMA for the entire chassis including the SFPs and SFP cables. Remove the drives and power supplies before you send the chassis for RMA. See the [Cisco Returns Portal](#) for more information.

Table 5: SMA C195, C395, C695, and C695F PIDs

PID	Description
CCS-HDD-600GB10K	SMA M195, M395, M695, M695F HDD
CCS-HDD-600GB10K=	SMA M195, M395, M695, M695F HDD (spare)
CCS-PSU1-770AC	SMA M195 and M395 770 AC power supply
CCS-PSU1-770AC=	SMA M195 and M395 770 AC power supply (spare)
CCS-PSU1-1050AC	SMA M695 and M695F 1050 AC power supply
CCS-PSU1-1050AC=	SMA M695 and M695F 1050 AC power supply (spare)
UCSC-RAILB-M4	SMA M195, M395, M695, and M695F rail kit
UCSC-RAILB-M4=	SMA M195, M395, M695, and M695F rail kit (spare)
UCSC-BZL-C220M5	SMA M195 and M395 1 RU locking faceplate
UCSC-BZL-C220M5=	SMA M195 and M395 1 RU locking faceplate (spare)
UCSC-BZL-C240M5	SMA M695 and M695F 2 RU locking faceplate
UCSC-BZL-C240M5=	SMA M695 and M695F 2 RU locking faceplate (spare)
SFP-10G-SR	ESA C695F 10-Gb SFP
SFP-10G-SR=	ESA C695F 10-Gb SFP (spare)
GLC-SX-MMD	ESA C695F 1-Gb SFP
GLC-SX-MMD=	ESA C695F 1-Gb SFP (spare)

Power Cord Specifications

Each power supply has a separate power cord. Standard power cords or jumper power cords are available for connection to the SMA. The jumper power cords for use in racks are available as an optional alternative to the standard power cords.

If you do not order the optional power cord with the system, you are responsible for selecting the appropriate power cord for the product. Using a incompatible power cord with this product may result in electrical safety hazard. Orders delivered to Argentina, Brazil, and Japan must have the appropriate power cord ordered with the system.

The following power cords and jumper cords are supported.

Figure 15: Argentina CAB-250V-10A-AR

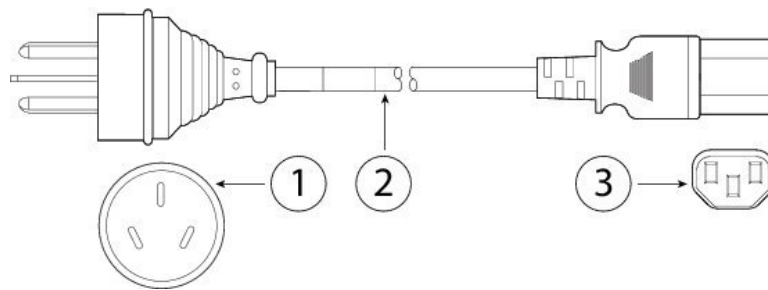

1	Plug: IRAM 2073	2	Cord set rating: 10 A, 250 V
3	Connector: IEC 60320/C13		

Figure 16: Australia CAB-9K10A-AU

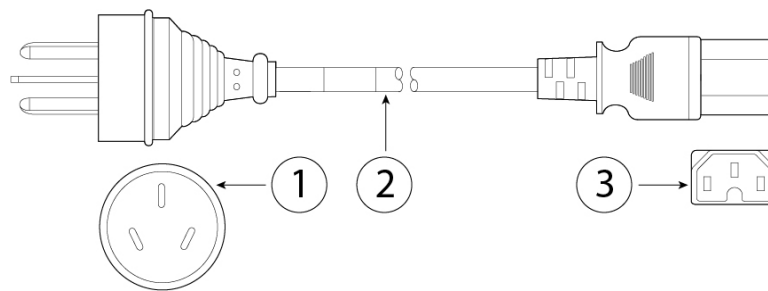

1	Plug: A.S. 3112-2000	2	Cord set rating: 10 A, 250 V
3	Connector: IEC 60320/C15		

Figure 17: Brazil PWR-250V-10A-BZ

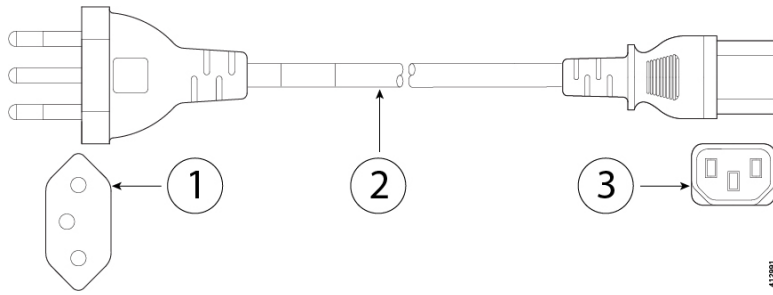

1	Plug: NBR 14136	2	Cord set rating: 10 A, 250 V
3	Connector: IEC 60320/C13		

Figure 18: Cabinet Jumper CAB-C13-C14-2M

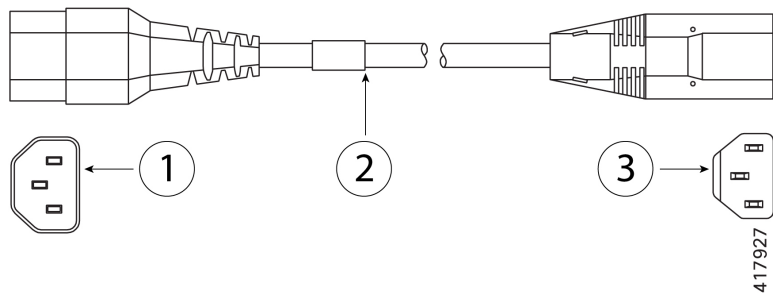

1	Plug: SS10A	2	Cord set rating: 10A, 250V
3	Connector: HS10S, C-13 to C-14		

Figure 19: Cabinet Jumper CAB-C13-C14-AC

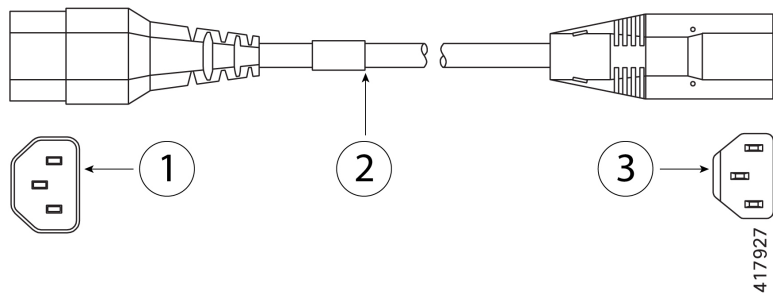

1	Plug: SS10A	2	Cord set rating: 10 A, 250 V
3	Connector: HS10S, C-13 to C-14 (recessed receptacle)		

Figure 20: Cabinet Jumper CAB-C13-CBN

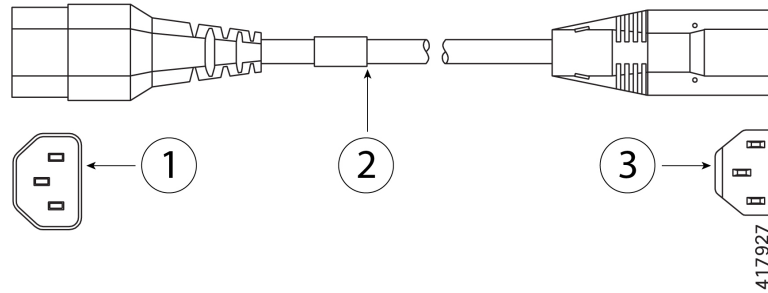

1	Plug: SS10A	2	Cord set rating: 10 A, 250 V
3	Connector: HS10S, C-13 to C-14		

Figure 21: China CAB-250V-10A-CH

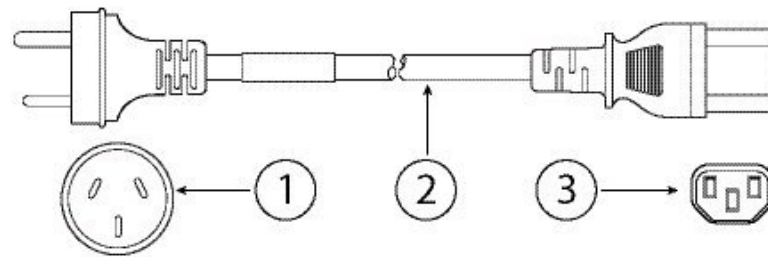

1	Plug: GB2099.1/2008	2	Cord set rating: 10 A, 250 V
3	Connector: IEC 60320/C13		

Figure 22: Europe CAB-9K10A-EU

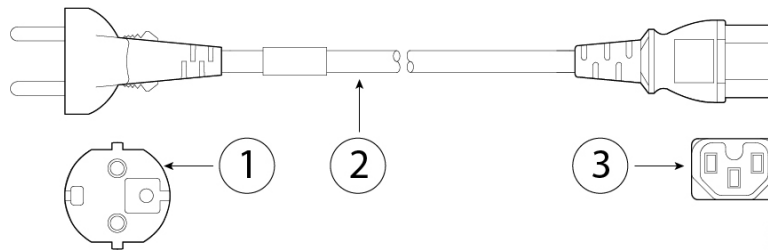

1	Plug: CEE 7/7 (M2511)	2	Cord set rating: 10 A/16 A, 250 V
3	Connector: IEC 60320/C15 (VSCC 15)		

Figure 23: India CAB-250V-10A-ID

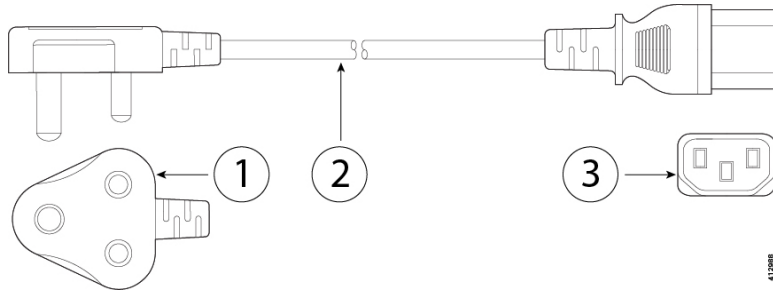

1	Plug: IS 6538-1971	2	Cord set rating: 16 A, 250 V
3	Connector: IEC 60320-C13		

Figure 24: Israel CAB-250V-10A-IS

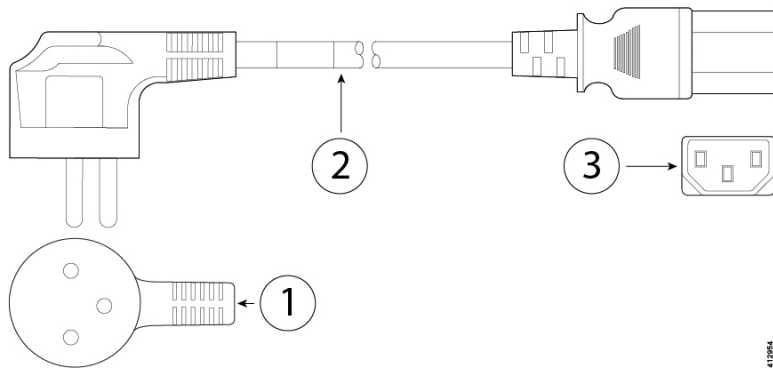

1	Plug: SI-32	2	Cord set rating: 10 A, 250 V
3	Connector: IEC 60320-C13		

Figure 25: Italy CAB-9K10A-IT

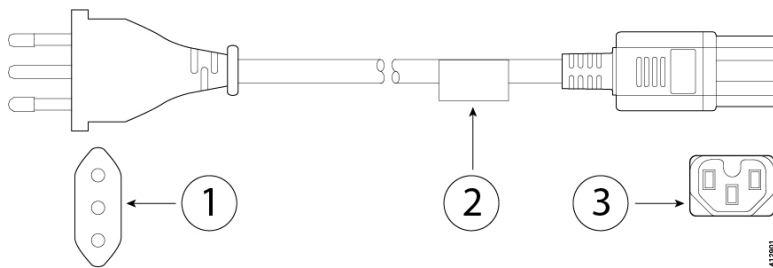

1	Plug: CEI 23-16/VII (I/3G)	2	Cord set rating: 10 A, 250 V
3	Connector: IEC 60320/C15 (EN 60320/C15M)		

Figure 26: Japan CAB-JPN-3PIN

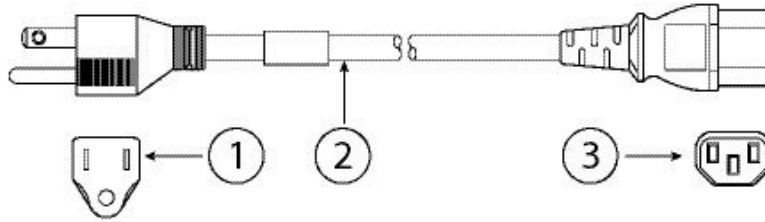

1	Plug: JIS 8303	2	Cord set rating: 12 A, 125 V
3	Connector: IEC 60320/C13		

Figure 27: Japan CAB-C13-C14-2M-JP

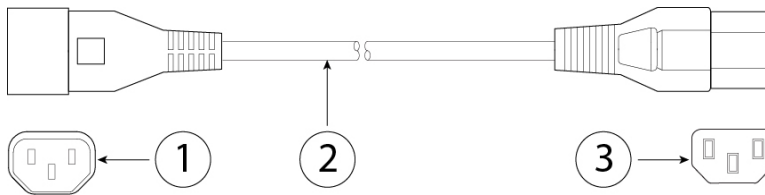

1	Plug: EN 60320-2-2/E	2	Cord set rating: 10 A, 250 V
3	Connector: EN 60320/C13 to C14		

Figure 28: Korea CAB-9K10S-KOR

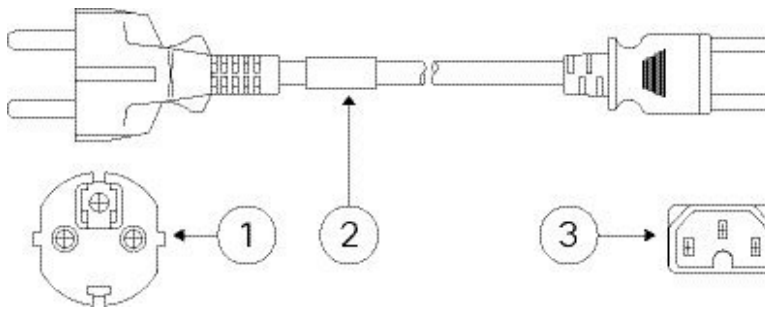

1	Plug: EL211 (KSC 8305)	2	Cord set rating: 10 A, 250 V
3	Connector: IEC 60320/C15		

Figure 29: North America CAB-9K12A-NA

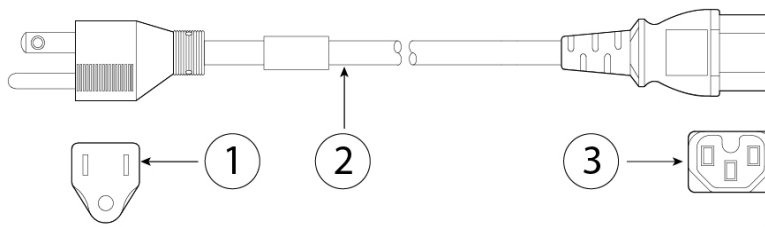

1	Plug: NEMA5-15P	2	Cord set rating: 13 A, 125 V
3	Connector: IEC 60320/C15		

Figure 30: North America CAB-N5K6A-NA

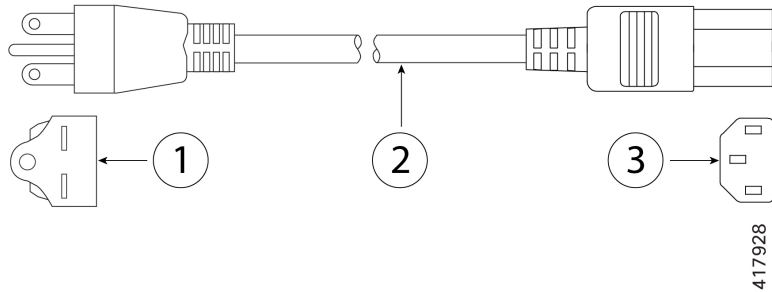

1	Plug: NEMA6-15P	2	Cord set rating: 10 A, 125 V
3	Connector: IEC 60320/C13		

Figure 31: North America CAB-AC-L620-C13

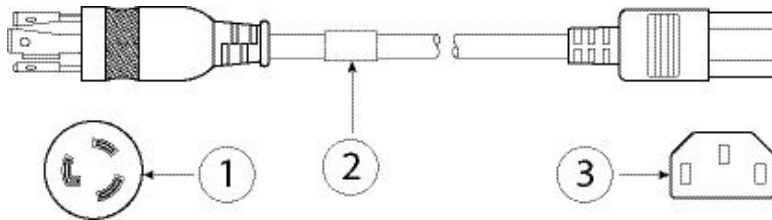

1	Plug: NEMA L6-20 (molded twist lock)	2	Cord set rating: 13 A, 250 V
3	Connector: IEC 60320/C13		

Figure 32: Switzerland CAB-9K10A-SW

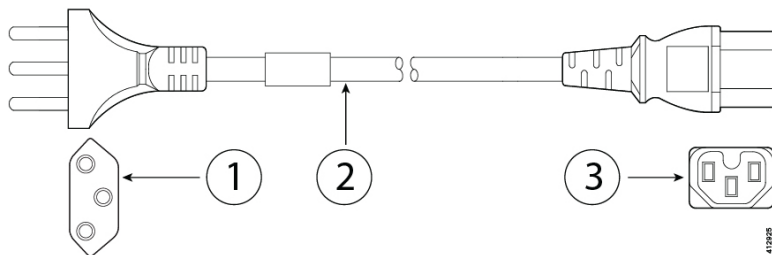

1	Plug: SEV 1011 (MP232-R)	2	Cord set rating: 10 A, 250 V
3	Connector: IEC 60320/C15		

Figure 33: Taiwan CAB-ACTW

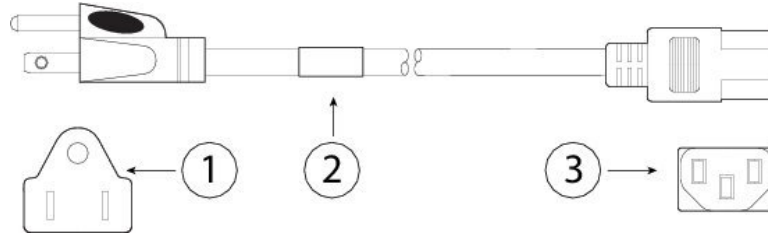

1	Plug: EL 302 (CNS10917)	2	Cord set rating: 10 A, 125 V
3	Connector: IEC 60320/C13		

Figure 34: United Kingdom CAB-9K10A-UK

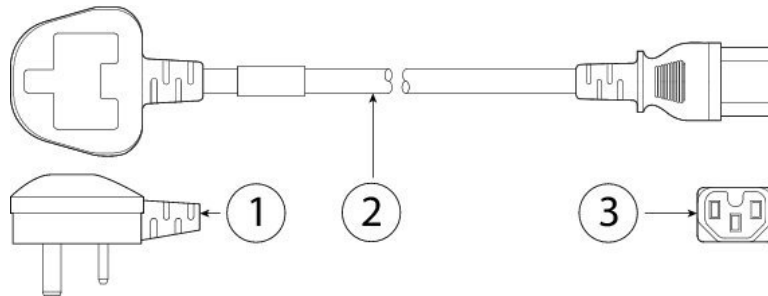

1	Plug: BS1363A/SS145	2	Cord set rating: 10 A, 250 V
3	Connector: IEC 60320/C15		



CHAPTER 2

Installation Preparation

- [Installation Warnings, on page 27](#)
- [Safety Recommendations, on page 29](#)
- [Maintain Safety with Electricity, on page 29](#)
- [Prevent ESD Damage, on page 30](#)
- [Site Environment, on page 30](#)
- [Site Considerations, on page 31](#)
- [Power Supply Considerations, on page 31](#)
- [Rack Configuration Considerations, on page 31](#)

Installation Warnings

Read the [Regulatory Compliance and Safety Information](#) document before installing the chassis.

Take note of the following warnings:



Warning **Statement 1071**—Warning Definition

IMPORTANT SAFETY INSTRUCTIONS

Before you work on any equipment, be aware of the hazards involved with electrical circuitry and be familiar with standard practices for preventing accidents. Read the installation instructions before using, installing, or connecting the system to the power source. Use the statement number provided at the end of each warning statement to locate its translation in the translated safety warnings for this device.

SAVE THESE INSTRUCTIONS





Warning Statement 1005—Circuit Breaker

This product relies on the building's installation for short-circuit (overcurrent) protection. Ensure that the protective device is rated not greater than: 250 V, 15 A.



Warning Statement 1006—Chassis Warning for Rack-Mounting and Servicing

To prevent bodily injury when mounting or servicing this unit in a rack, you must take special precautions to ensure that the system remains stable. The following guidelines are provided to ensure your safety:

- This unit should be mounted at the bottom of the rack if it is the only unit in the rack.
 - When mounting this unit in a partially filled rack, load the rack from the bottom to the top with the heaviest component at the bottom of the rack.
 - If the rack is provided with stabilizing devices, install the stabilizers before mounting or servicing the unit in the rack.
-



Warning Statement 1015—Battery Handling

To reduce risk of fire, explosion or leakage of flammable liquid or gas:

- Replace the battery only with the same or equivalent type recommended by the manufacturer.
 - Do not dismantle, crush, puncture, use sharp tool to remove, short external contacts, or dispose of in fire.
 - Do not use if battery is warped or swollen.
 - Do not store or use battery in a temperature $> 60^{\circ}\text{C}$.
 - Do not store or use battery in low air pressure environment $< 69.7\text{ kPa}$.
-



Warning Statement 1017—Restricted Area

This unit is intended for installation in restricted access areas. A restricted access area can be accessed by skilled, instructed, or qualified personnel.



Warning Statement 1019—Main Disconnecting Device

The plug-socket combination must be accessible at all times, because it serves as the main disconnecting device.



Warning **Statement 1053**—Class 1M Laser Radiation

Hazard level 1M invisible laser radiation is present. Do not view directly with nonattenuating optical instruments.



Warning **Statement 1047**—Overheating Prevention

To prevent the system from overheating, do not operate it in an area that exceeds the maximum recommended ambient temperature of: 95° F (35° C).



Warning **Statement 1074**—Comply with Local and National Electrical Codes

To reduce risk of electric shock or fire, installation of the equipment must comply with local and national electrical codes.

Safety Recommendations

Observe these safety guidelines:

- Keep the area clear and dust free before, during, and after installation.
- Keep tools away from walkways, where you and others might trip over them.
- Do not wear loose clothing or jewelry, such as earrings, bracelets, or chains that could get caught in the chassis.
- Wear safety glasses if you are working under any conditions that might be hazardous to your eyes.
- Do not perform any action that creates a potential hazard to people or makes the equipment unsafe.
- Never attempt to lift an object that is too heavy for one person.

Maintain Safety with Electricity



Warning Before working on a chassis, be sure the power cord is unplugged.

Read the [Regulatory Compliance and Safety Information](#) document before installing the chassis.

Follow these guidelines when working on equipment powered by electricity:

- Before beginning procedures that require access to the interior of the chassis, locate the emergency power-off switch for the room in which you are working. Then, if an electrical accident occurs, you can act quickly to turn off the power.

- Do not work alone if potentially hazardous conditions exist anywhere in your work space.
- Never assume that power is disconnected; always check.
- Look carefully for possible hazards in your work area, such as moist floors, ungrounded power extension cables, frayed power cords, and missing safety grounds.
- If an electrical accident occurs:
 - Use caution; do not become a victim yourself.
 - Disconnect power from the chassis.
 - If possible, send another person to get medical aid. Otherwise, assess the condition of the victim, and then call for help.
 - Determine whether the person needs rescue breathing or external cardiac compressions; then take appropriate action.
- Use the chassis within its marked electrical ratings and product usage instructions.
- The Cisco Content Security Appliance x95 Series are equipped with an AC-input power supply, which is shipped with a three-wire electrical cord with a grounding-type plug that fits into a grounding-type power outlet only. Do not circumvent this safety feature. Equipment grounding should comply with local and national electrical codes.

Prevent ESD Damage

ESD occurs when electronic components are improperly handled, and it can damage equipment and impair electrical circuitry, which can result in intermittent or complete failure of your equipment.

Always follow ESD-prevention procedures when removing and replacing components. Ensure that the chassis is electrically connected to an earth ground. Wear an ESD-preventive wrist strap, ensuring that it makes good skin contact. Connect the grounding clip to an unpainted surface of the chassis frame to safely ground ESD voltages. To properly guard against ESD damage and shocks, the wrist strap and cord must operate effectively. If no wrist strap is available, ground yourself by touching the metal part of the chassis.

For safety, periodically check the resistance value of the antistatic strap, which should be between one and 10 megohms.

Site Environment

See [Hardware Specifications](#), on page 17 for information about physical specifications.

When planning the site layout and equipment locations, consider the information in the next section to help avoid equipment failures and reduce the possibility of environmentally caused shutdowns. If you are currently experiencing shutdowns or unusually high error rates with your existing equipment, these considerations may help you isolate the cause of failures and prevent future problems.

Site Considerations

Considering the following helps you plan an acceptable operating environment for the chassis, and avoid environmentally-caused equipment failures.

- Electrical equipment generates heat. Ambient air temperature might not be adequate to cool equipment to acceptable operating temperatures without adequate circulation. Make sure that the room in which you operate your system has adequate air circulation.
- Ensure that the chassis cover is secure. The chassis is designed to allow cooling air to flow effectively within it. An open chassis allows air leaks, which may interrupt and redirect the flow of cooling air from the internal components.
- Always follow ESD-prevention procedures to avoid damage to equipment. Damage from static discharge can cause immediate or intermittent equipment failure.

Power Supply Considerations

See [Power Supply, on page 15](#) for more detailed information about the power supply in the chassis.

When installing the chassis, consider the following:

- Check the power at the site before installing the chassis to ensure that it is free of spikes and noise. Install a power conditioner, if necessary, to ensure proper voltages and power levels in the appliance-input voltage.
- Install proper grounding for the site to avoid damage from lightning and power surges.
- The chassis does not have a user-selectable operating range. Refer to the label on the chassis for the correct appliance input-power requirement.
- Several styles of AC-input power supply cords are available for the chassis; make sure that you have the correct style for your site.
- If you are using dual redundant (1+1) power supplies, we recommend that you use independent electrical circuits for each power supply.
- Install an uninterruptible power source for your site, if possible.

Rack Configuration Considerations

See [Rack-Mount the Chassis, on page 33](#) for the rack-mount procedure.

Consider the following when planning a rack configuration:

- If you are mounting a chassis in an open rack, make sure that the rack frame does not block the intake or exhaust ports.
- Be sure enclosed racks have adequate ventilation. Make sure that the rack is not overly congested as each chassis generates heat. An enclosed rack should have louvered sides and a fan to provide cooling air.

- In an enclosed rack with a ventilation fan in the top, heat generated by equipment near the bottom of the rack can be drawn upward and into the intake ports of the equipment above it in the rack. Ensure that you provide adequate ventilation for equipment at the bottom of the rack.
- Baffles can help to isolate exhaust air from intake air, which also helps to draw cooling air through the chassis. The best placement of the baffles depends on the airflow patterns in the rack. Experiment with different arrangements to position the baffles effectively.



CHAPTER 3

Rack-Mount the Chassis

- [Unpack and Inspect the Chassis, on page 33](#)
- [Rack-Mount the Chassis, on page 33](#)

Unpack and Inspect the Chassis



Note The chassis is thoroughly inspected before shipment. If any damage occurred during transportation or any items are missing, contact your customer service representative immediately. Keep the shipping container in case you need to send the chassis back due to damage.

See [Package Contents, on page 3](#) for a list of what shipped with the chassis.

- Step 1** Remove the chassis from its cardboard container and save all packaging material.
- Step 2** Compare the shipment to the equipment list provided by your customer service representative. Verify that you have all items.
- Step 3** Check for damage and report any discrepancies or damage to your customer service representative. Have the following information ready:
- Invoice number of shipper (see the packing slip)
 - Model and serial number of the damaged unit
 - Description of damage
 - Effect of damage on the installation
-

Rack-Mount the Chassis

Before you begin

You can install the chassis in a rack using the Cisco rack kit (part number 800-43376-02).

The rack must be of the following type:

- A standard 19-inch (48.3-cm) wide, 4-post EIA rack with mounting posts that conform to English universal hole spacing per section 1 of ANSI/EIA-310-D-1992.
- The rack post holes can be square 0.38-inch (9.6 mm), round 0.28-inch (7.1 mm), #12-24 UNC, or #10-32 UNC when you use the supplied slide rails.
- The minimum vertical rack space per appliance must be 1 RU, equal to 1.75 inches (44.45 mm).
- The slide rails for the chassis have an adjustment range of 24 to 36 inches (610 to 914 mm).



Note The slide rails that ship with the chassis do not require tools for installation if you install them in a rack that has square 0.38-inch (9.6 mm), round 0.28-inch (7.1 mm), or #12-24 UNC threaded holes.

Safety Warnings

Take note of the following warning:



Warning Statement 1006—Chassis Warning for Rack-Mounting and Servicing

To prevent bodily injury when mounting or servicing this unit in a rack, you must take special precautions to ensure that the system remains stable. The following guidelines are provided to ensure your safety:

- This unit should be mounted at the bottom of the rack if it is the only unit in the rack.
- When mounting this unit in a partially filled rack, load the rack from the bottom to the top with the heaviest component at the bottom of the rack.
- If the rack is provided with stabilizing devices, install the stabilizers before mounting or servicing the unit in the rack.

Step 1

Attach the inner rails to the sides of the chassis:

- Align an inner rail with one side of the chassis so that the three keyed slots in the rail align with the three pegs on the side of the chassis.
- Set the keyed slots over the pegs, and then slide the rail toward the front to lock it in place on the pegs. The front slot has a metal clip that locks over the front peg.
- Install the second inner rail to the opposite side of the chassis.

Figure 35: Attach the Inner Rail to the Side of the Server

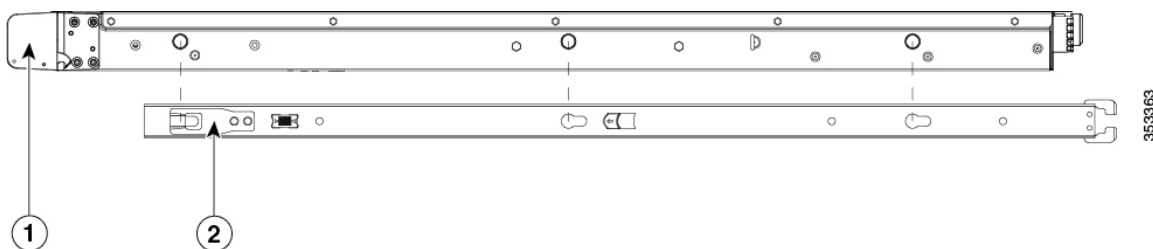

1	Front of chassis	2	Locking clip on inner rail
---	------------------	---	----------------------------

Step 2

Open the front securing plate on both slide-rail assemblies. The front end of the slide-rail assembly has a spring-loaded securing plate that must be open before you can insert the mounting pegs into the rack-post holes.

On the outside of the assembly, push the green arrow button toward the rear to open the securing plate.

Figure 36: Front Securing Mechanism, Inside of Front End

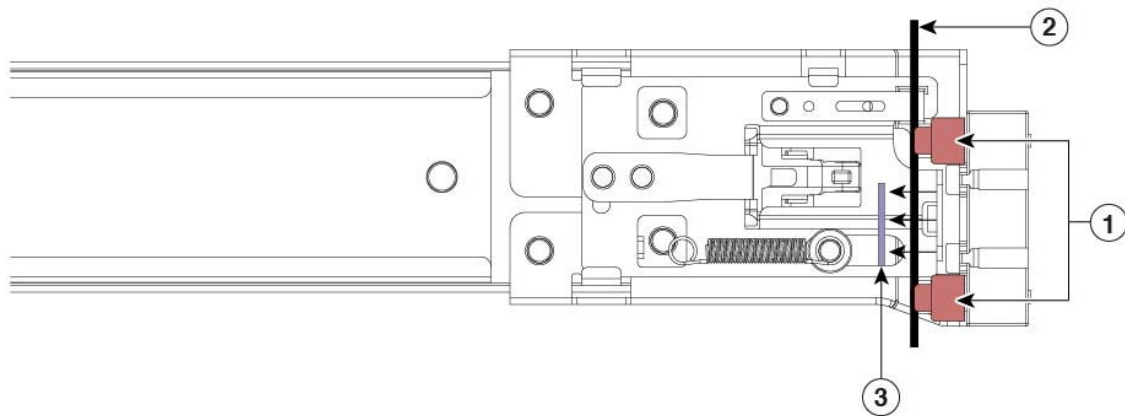

1	Front mounting pegs	2	Rack post
3	Securing plate shown pulled back to open position		—

Step 3

Install the slide rails into the rack:

- a) Align one slide-rail assembly front end with the front rack-post holes that you want to use.

The slide rail front end wraps around the outside of the rack post and the mounting pegs enter the rack-post holes from the outside-front.

Note The rack post must be between the mounting pegs and the open securing plate.

- b) Push the mounting pegs into the rack-post holes from the outside-front.
 c) Press the securing plate release button, marked “PUSH.” The spring-loaded securing plate closes to lock the pegs in place.
 d) Attach the second slide-rail assembly to the opposite side of the rack. Make sure that the two slide-rail assemblies are at the same height with each other and are level front-to-back.
 e) Pull the inner slide rails on each assembly out toward the rack front until they hit the internal stops and lock in place.

Step 4

Insert the chassis into the slide rails:

- a) Align the rear of the inner rails that are attached to the chassis sides with the front ends of the empty slide rails on the rack.
 b) Push the inner rails into the slide rails on the rack until they stop at the internal stops.
 c) Slide the release clip toward the rear on both inner rails, and then continue pushing the chassis into the rack until its front slam latches engage with the rack posts

Figure 37: Inner Rail Release Clip

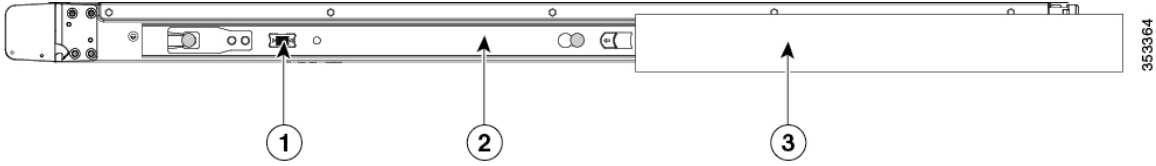

1	Inner rail release clip	2	Inner rail attached to chassis and inserted into outer rail
3	Outer rail attached to rack post		

Step 5

(Optional) Secure the chassis in the rack more permanently by using the two screws that are provided with the slide rails. Perform this step if you plan to move the rack with chassis installed. With the chassis fully pushed into the slide rails, open a hinged slam latch lever on the front of the chassis and insert the screw through the hole that is under the lever. The screw threads into the static part of the rail on the rack post and prevents the chassis from being pulled out. Repeat for the opposite slam latch.

What to do next

Install the cables according to your default software configuration as described in the [Getting Started Guide](#) for your software version.



CHAPTER 4

Maintenance and Upgrade

- [Power Button Shut Down, on page 37](#)
- [Enable RPC, on page 38](#)
- [Reset the Chassis Remotely, on page 39](#)
- [Install/Uninstall the Locking Faceplate, on page 39](#)
- [Remove and Replace a Drive, on page 40](#)
- [Remove and Replace a Power Supply, on page 43](#)

Power Button Shut Down

The chassis runs in two modes:

- Main power mode—Power is supplied to all components and all operating systems can run.
- Standby power mode—Power is supplied only to the service processor and certain components. You can safely remove power cords from the chassis in this mode.



Caution After you shut down the chassis to standby power, electric current is still present in the chassis. To completely remove power as directed in some maintenance procedures, you must disconnect all power cords from all power supplies in the chassis.

You can shut down the chassis using the front panel Power button or software management.

Step 1 Check the Power LED:

- Amber—The chassis is already in standby mode and you can safely remove power.
- Green—The chassis is in main power mode and you must shut it down before you can safely remove power.

Step 2 Perform a graceful shutdown or a hard shutdown:

Caution To avoid data loss or damage to your operating system, perform a graceful shutdown of the operating system.

- Graceful shutdown—Press and release the Power button. The operating system performs a graceful shutdown and the chassis goes into standby mode. The power LED is amber.

- Emergency shutdown—Press and hold the Power button for four seconds to force the main power off and immediately enter standby mode.

Step 3 If a maintenance procedure instructs you to completely remove power from the chassis, disconnect all power cords from the power supplies.

Enable RPC

You must enable and configure RPC before you can remotely reset chassis power.

Before you begin

- Cable the RPC port directly to a secure network.
 - Open necessary ports through the firewall to make sure the chassis is accessible remotely.
 - RPC requires a unique IPv4 address for the RPC port. You must use the following procedure to configure the RPC port. You cannot configure it using the **ipconfig** command.
 - To cycle chassis power you must have a third-party tool that supports the Intelligent Platform Management Interface (IPMI) version 2.0.
-

Step 1 Use SSH or the serial console port to access the CLI.

Step 2 Log in using an account with Administrator access.

Step 3 Enter the following commands:

```
remotepower
setup
```

Step 4 Follow the prompts to specify the following:

- The dedicated IP address for the RPC port, netmask, and gateway.
- The username and password required to execute the **power-cycle** command.

These credentials are independent of other credentials used to access your appliance. Store this information for administrators who may need to set up RPC in the future.

Step 5 Enter **commit** to save your changes.

Step 6 Test your configuration to verify that you can remotely manage chassis power.

What to do next

[Reset the Chassis Remotely, on page 39](#)

Reset the Chassis Remotely

If the chassis requires a hard reset, you can reboot the chassis remotely using a third-party IPMI tool.

Before you begin

- You must enable RPC in advance. See [Enable RPC, on page 38](#) for the procedure.
- Only the following IPMI commands are supported. Refer to your IPMI tool documentation on how to use them.

status, on, off, cycle, reset, diag, soft

- Set up a utility that can manage devices using IPMI version 2.0.

Step 1 Use IPMI to issue a supported power-cycling command to the IP address assign to the RPC port.

Note The RPC port must be configured with the required credentials. See [Enable RPC, on page 38](#) for more information.

For example, issue the following command from a UNIX computer with IPMI support:

```
ipmitool -I lan -H ip-address -U remoteresetuser -P password chassis power reset
```

Step 2 Wait at least 11 minutes for the chassis to reboot.

Install/Uninstall the Locking Faceplate

The locking faceplate (Cisco part number 74-115098-01 for a 1 RU chassis and Cisco part number 74-115099-01 for a 2 RU chassis) ships with the key you need to lock the faceplate to the front panel of the chassis. The locking faceplate clicks in between the two side handles on the front panel.

Step 1 Insert the right side of the locking faceplate by aligning the two plastic tabs with the two cutouts on the right side handle on the front of the chassis.

Figure 38: Locking Faceplate

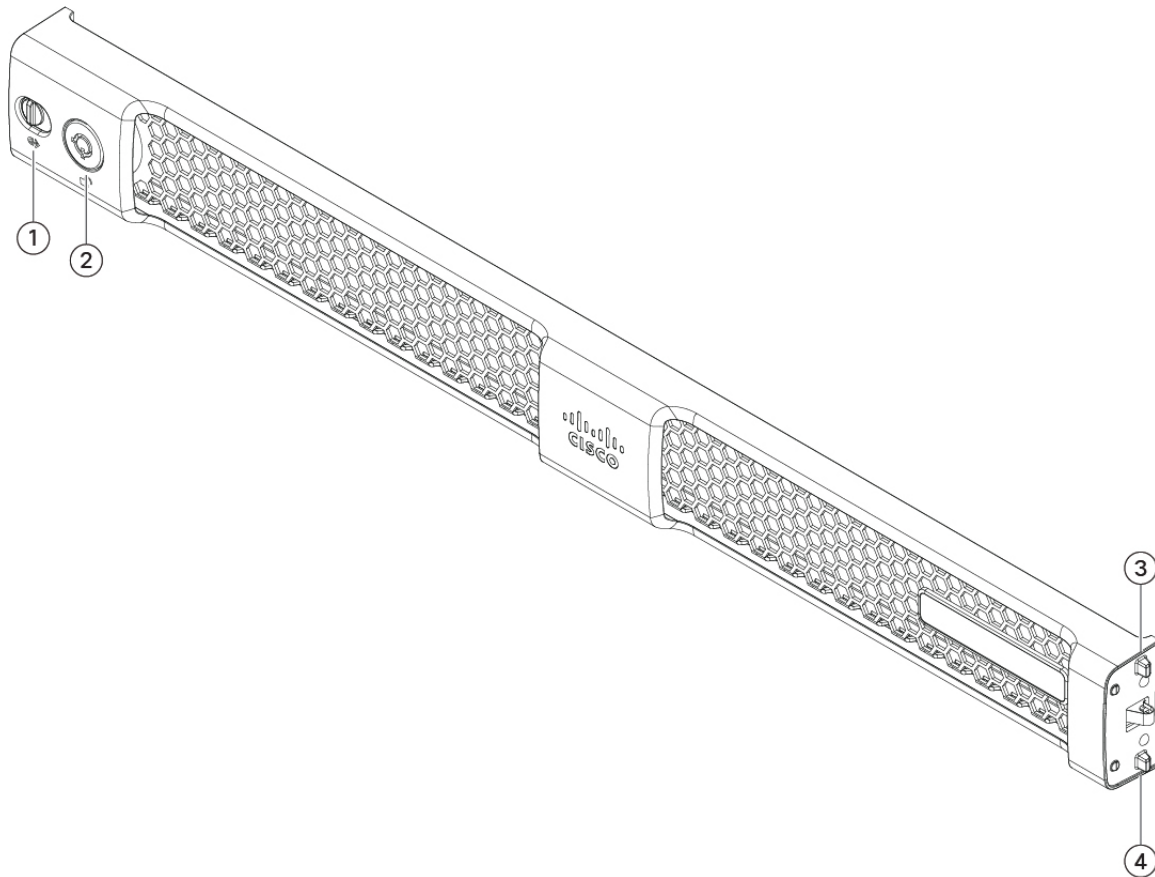

1	Latch	2	Key hole
3	Spring-mounted tab	4	Spring-mounted tab

- Step 2** Press in the left side of the faceplate into the left side handle on the front panel. The tabs are spring-mounted to the latch, so they push in as the faceplate is installed.
- Step 3** Lock the faceplate using the key that shipped with the faceplate.
- Step 4** To uninstall the faceplate, unlock the faceplate, push the latch to the right, and pull the faceplate out.

Remove and Replace a Drive

The drives are hot-swappable. You do not have to shut down the chassis to remove or replace drives.

You cannot add more drives to the chassis. You can only replace the drives in the slots that are supported for your model.

Safety Warnings

Take note of the following warnings:

**Warning Statement 1018—Supply Circuit**

To reduce risk of electric shock and fire, take care when connecting units to the supply circuit so that wiring is not overloaded.

**Warning Statement 1019—Main Disconnecting Device**

The plug-socket combination must be accessible at all times, because it serves as the main disconnecting device.

**Warning Statement 1024—Ground Conductor**

This equipment must be grounded. To reduce the risk of electric shock, never defeat the ground conductor or operate the equipment in the absence of a suitably installed ground conductor. Contact the appropriate electrical inspection authority or an electrician if you are uncertain that suitable grounding is available.

**Warning Statement 1030—Equipment Installation**

Only trained and qualified personnel should be allowed to install, replace, or service this equipment.

**Warning Statement 1073—No User-Serviceable Parts**

There are no serviceable parts inside. To avoid risk of electric shock, do not open.

**Warning Statement 1074—Comply with Local and National Electrical Codes**

To reduce risk of electric shock or fire, installation of the equipment must comply with local and national electrical codes.

Step 1

Remove the drive that you are replacing:

- a) Press the release button on the face of the drive tray.
- b) Grasp and open the ejector lever and then pull the drive tray out of the slot.

Figure 39: Remove the Drive

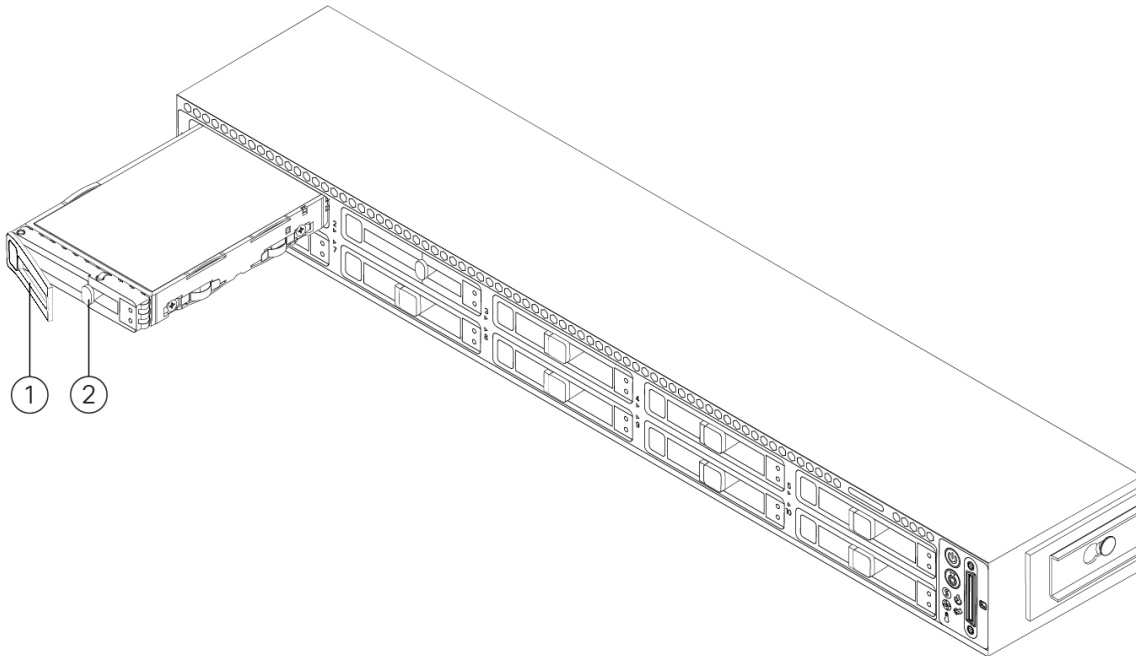

1 Ejector handle	2 Release button
------------------	------------------

Step 2 Remove the four drive-tray screws that secure the drive to the tray and then lift the drive out of the tray.

Figure 40: Remove the Drive Tray

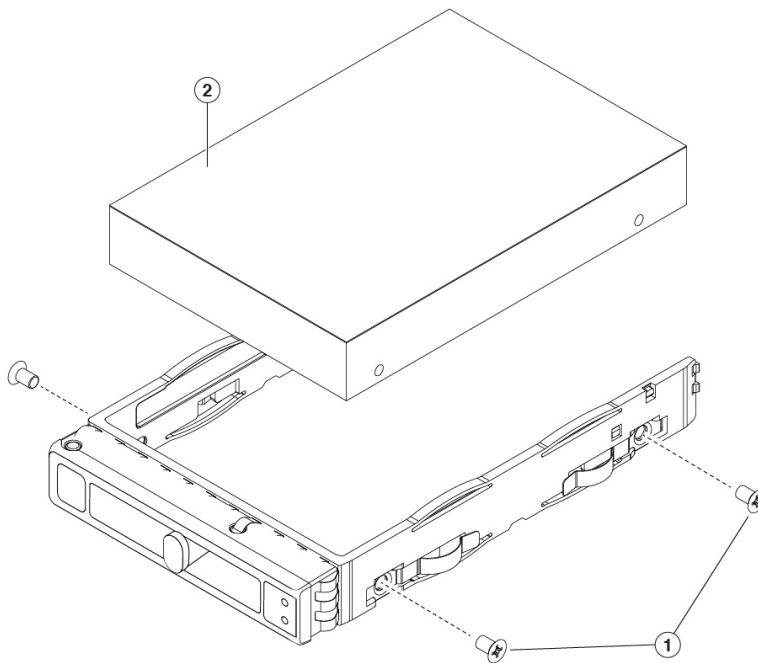

1	Drive tray screws (two on each side)	2	Drive removed from drive tray
----------	---------------------------------------	----------	-------------------------------

Step 3

Install a new drive:

- a) Place a new drive in the empty drive tray and install the four drive-tray screws.
- b) With the ejector lever on the drive tray open, insert the drive tray into the empty drive bay.
- c) Push the tray into the slot until it touches the backplane, and then close the ejector lever to lock the drive in place.

Remove and Replace a Power Supply

Two power supplies ship with the chassis; they are redundant and hot-swappable. One is the active power supply and the other is the standby power supply (1+1).



Note The M195 ships with one power supply, but you can add another one for redundancy.

The chassis also supports cold redundancy. Depending on the power being drawn by the chassis, one power supply might actively provide all power to the system while the remaining power supply is put into a standby state. For example, if the power consumption can be satisfied by power supply 1, then power supply 2 is put into a standby state.



Caution When you replace power supplies, do not mix power supply types in the chassis. Both power supplies must be the same wattage and Cisco PID.



Trouble Power supply health monitoring notifies you if the power supply loses power or malfunctions so that redundancy is lost. Check the power supply cables to make sure they are functioning. If they are and errors are still occurring, replace the power supply.

Safety Warnings

Take note of the following warnings:



Warning **Statement 1018**—Supply Circuit

To reduce risk of electric shock and fire, take care when connecting units to the supply circuit so that wiring is not overloaded.



Warning **Statement 1019**—Main Disconnecting Device

The plug-socket combination must be accessible at all times, because it serves as the main disconnecting device.

**Warning Statement 1024**—Ground Conductor

This equipment must be grounded. To reduce the risk of electric shock, never defeat the ground conductor or operate the equipment in the absence of a suitably installed ground conductor. Contact the appropriate electrical inspection authority or an electrician if you are uncertain that suitable grounding is available.

**Warning Statement 1030**—Equipment Installation

Only trained and qualified personnel should be allowed to install, replace, or service this equipment.

**Warning Statement 1073**—No User-Serviceable Parts

There are no serviceable parts inside. To avoid risk of electric shock, do not open.

**Warning Statement 1074**—Comply with Local and National Electrical Codes

To reduce risk of electric shock or fire, installation of the equipment must comply with local and national electrical codes.

Step 1

Remove the power supply that you are replacing or the blank panel from an empty bay:

a) Do one of the following actions:

- If the chassis has one power supply, shut down and remove power from the chassis. See [Power Button Shut Down, on page 37](#) for the procedure.
- If the chassis has two power supplies, you do not have to shut down the chassis.

b) Remove the power cord from the power supply that you are replacing.

c) Grasp the power supply handle while pinching the release lever toward the handle.

d) Pull the power supply out of the bay.

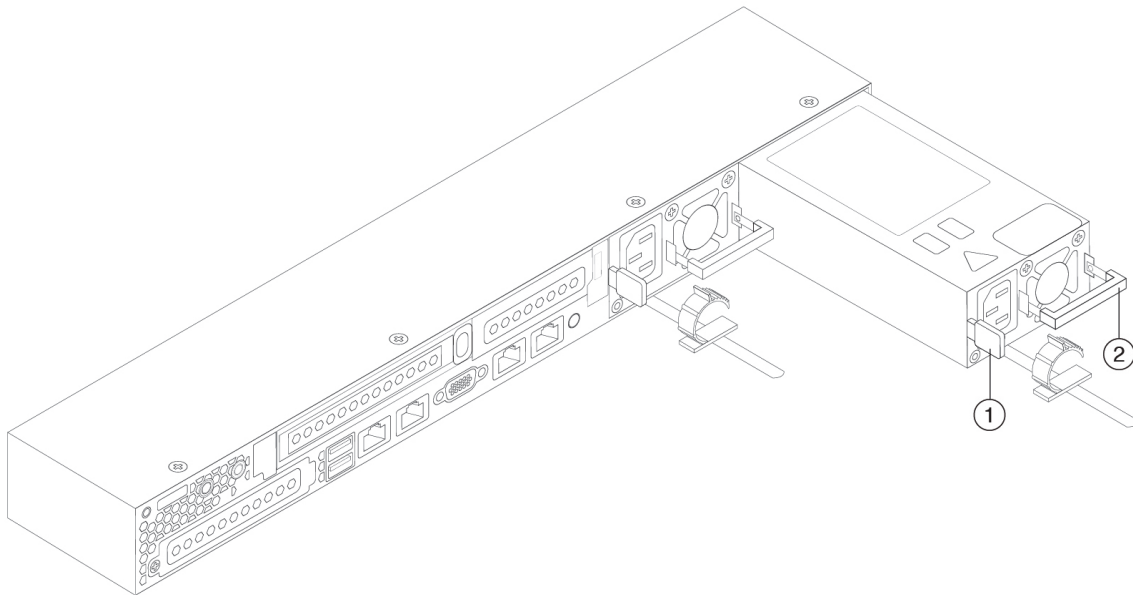
Figure 41: Remove and Replace the AC Power Supply

1	Release lever	2	Handle
----------	---------------	----------	--------

Step 2

Install a new power supply:

- a) Grasp the power supply handle and insert the new power supply into the empty bay.
 - b) Push the power supply into the bay until the release lever locks.
 - c) Connect the power cord to the new power supply.
 - d) If you shut down the chassis, press the Power button to return it to main power mode.
-

