



Hardware Installation Guide for Cisco ISR 1100 and ISR 1100X Series Integrated Services Routers

First Published: 2019-09-30

Last Modified: 2023-07-25

Americas Headquarters

Cisco Systems, Inc.
170 West Tasman Drive
San Jose, CA 95134-1706
USA
<http://www.cisco.com>
Tel: 408 526-4000
800 553-NETS (6387)
Fax: 408 527-0883

THE SPECIFICATIONS AND INFORMATION REGARDING THE PRODUCTS IN THIS MANUAL ARE SUBJECT TO CHANGE WITHOUT NOTICE. ALL STATEMENTS, INFORMATION, AND RECOMMENDATIONS IN THIS MANUAL ARE BELIEVED TO BE ACCURATE BUT ARE PRESENTED WITHOUT WARRANTY OF ANY KIND, EXPRESS OR IMPLIED. USERS MUST TAKE FULL RESPONSIBILITY FOR THEIR APPLICATION OF ANY PRODUCTS.

THE SOFTWARE LICENSE AND LIMITED WARRANTY FOR THE ACCOMPANYING PRODUCT ARE SET FORTH IN THE INFORMATION PACKET THAT SHIPPED WITH THE PRODUCT AND ARE INCORPORATED HEREIN BY THIS REFERENCE. IF YOU ARE UNABLE TO LOCATE THE SOFTWARE LICENSE OR LIMITED WARRANTY, CONTACT YOUR CISCO REPRESENTATIVE FOR A COPY.

The following information is for FCC compliance of Class A devices: This equipment has been tested and found to comply with the limits for a Class A digital device, pursuant to part 15 of the FCC rules. These limits are designed to provide reasonable protection against harmful interference when the equipment is operated in a commercial environment. This equipment generates, uses, and can radiate radio-frequency energy and, if not installed and used in accordance with the instruction manual, may cause harmful interference to radio communications. Operation of this equipment in a residential area is likely to cause harmful interference, in which case users will be required to correct the interference at their own expense.

The following information is for FCC compliance of Class B devices: This equipment has been tested and found to comply with the limits for a Class B digital device, pursuant to part 15 of the FCC rules. These limits are designed to provide reasonable protection against harmful interference in a residential installation. This equipment generates, uses and can radiate radio frequency energy and, if not installed and used in accordance with the instructions, may cause harmful interference to radio communications. However, there is no guarantee that interference will not occur in a particular installation. If the equipment causes interference to radio or television reception, which can be determined by turning the equipment off and on, users are encouraged to try to correct the interference by using one or more of the following measures:

- Reorient or relocate the receiving antenna.
- Increase the separation between the equipment and receiver.
- Connect the equipment into an outlet on a circuit different from that to which the receiver is connected.
- Consult the dealer or an experienced radio/TV technician for help.

Modifications to this product not authorized by Cisco could void the FCC approval and negate your authority to operate the product.

The Cisco implementation of TCP header compression is an adaptation of a program developed by the University of California, Berkeley (UCB) as part of UCB's public domain version of the UNIX operating system. All rights reserved. Copyright © 1981, Regents of the University of California.

NOTWITHSTANDING ANY OTHER WARRANTY HEREIN, ALL DOCUMENT FILES AND SOFTWARE OF THESE SUPPLIERS ARE PROVIDED "AS IS" WITH ALL FAULTS. CISCO AND THE ABOVE-NAMED SUPPLIERS DISCLAIM ALL WARRANTIES, EXPRESSED OR IMPLIED, INCLUDING, WITHOUT LIMITATION, THOSE OF MERCHANTABILITY, FITNESS FOR A PARTICULAR PURPOSE AND NONINFRINGEMENT OR ARISING FROM A COURSE OF DEALING, USAGE, OR TRADE PRACTICE.

IN NO EVENT SHALL CISCO OR ITS SUPPLIERS BE LIABLE FOR ANY INDIRECT, SPECIAL, CONSEQUENTIAL, OR INCIDENTAL DAMAGES, INCLUDING, WITHOUT LIMITATION, LOST PROFITS OR LOSS OR DAMAGE TO DATA ARISING OUT OF THE USE OR INABILITY TO USE THIS MANUAL, EVEN IF CISCO OR ITS SUPPLIERS HAVE BEEN ADVISED OF THE POSSIBILITY OF SUCH DAMAGES.

Any Internet Protocol (IP) addresses and phone numbers used in this document are not intended to be actual addresses and phone numbers. Any examples, command display output, network topology diagrams, and other figures included in the document are shown for illustrative purposes only. Any use of actual IP addresses or phone numbers in illustrative content is unintentional and coincidental.

All printed copies and duplicate soft copies of this document are considered uncontrolled. See the current online version for the latest version.

Cisco has more than 200 offices worldwide. Addresses and phone numbers are listed on the Cisco website at www.cisco.com/go/offices.

The documentation set for this product strives to use bias-free language. For purposes of this documentation set, bias-free is defined as language that does not imply discrimination based on age, disability, gender, racial identity, ethnic identity, sexual orientation, socioeconomic status, and intersectionality. Exceptions may be present in the documentation due to language that is hardcoded in the user interfaces of the product software, language used based on standards documentation, or language that is used by a referenced third-party product.

Cisco and the Cisco logo are trademarks or registered trademarks of Cisco and/or its affiliates in the U.S. and other countries. To view a list of Cisco trademarks, go to this URL: <https://www.cisco.com/c/en/us/about/legal/trademarks.html>. Third-party trademarks mentioned are the property of their respective owners. The use of the word partner does not imply a partnership relationship between Cisco and any other company. (1721R)

© 2019–2023 Cisco Systems, Inc. All rights reserved.



CONTENTS

CHAPTER 1	Overview of Cisco ISR 1100 and ISR 1100X Series Routers	1
	Comparison of Models	1
	Cisco ISR1100-4G and Cisco ISR1100X-4G Routers	2
	Cisco ISR1100-6G and Cisco ISR1100X-6G Routers	4
	Cisco ISR1100-4GLTE Routers	7
	Power Supply	10
	LED Indicators on Cisco ISR1100-4G, Cisco ISR1100X-4G, Cisco ISR1100-6G, and Cisco ISR1100X-6G Routers	11
	LED Indicators on Cisco ISR1100-4GLTE Routers	13
	Wireless Specifications for the Cisco ISR1100-4GLTE Platform	15

CHAPTER 2	Preinstallation	17
	General Safety Standards	17
	Site Preparation Guidelines	18
	Environmental Requirements	19
	Tools and Equipment Required for Installation	19

CHAPTER 3	Install and Connect Cisco ISR 1100 and ISR 1100X Series Routers	21
	Unpack Router	21
	Install Cisco ISR 1100 and ISR 1100X Series Routers	21
	Mount the Router on a Desk or Shelf	22
	Mount the Router on a Wall	23
	Mount the Router on a Rack Tray	26
	Connect Cisco ISR 1100 and ISR 1100X Series Routers	29
	Chassis Grounding	29
	Connect the Power Cable	30

Connect the Router to a Console 31

CHAPTER 4

Default Configuration at Startup 33

Cisco ISR1100-4G and Cisco ISR1100-6G Routers, Cisco vEdge Operating System 33

Cisco ISR1100-4GLTE Routers, Cisco vEdge Operating System 35

Cisco ISR1100-4G Routers, Cisco IOS XE 37

Cisco ISR1100-6G Routers, Cisco IOS XE 38

Cisco ISR1100-4GLTE Routers, Cisco IOS XE 40

CHAPTER 5

Install External Modules and FRUs 43

Safety Warnings 43

Install Antennas for Cisco ISR1100-4GLTE Routers 43

Install and Remove SFP Modules 44

Install the Micro SIM Card 45



CHAPTER 1

Overview of Cisco ISR 1100 and ISR 1100X Series Routers

Cisco ISR 1100 and ISR 1100X Series Integrated Services Routers deliver essential WAN, security, and multi-cloud capability of the Cisco SD-WAN solution. These routers provide highly secure site-to-site data connectivity to small business and home offices, remote offices, and branch offices. These routers are available in fixed form factors.

- [Comparison of Models, on page 1](#)
- [Cisco ISR1100-4G and Cisco ISR1100X-4G Routers, on page 2](#)
- [Cisco ISR1100-6G and Cisco ISR1100X-6G Routers, on page 4](#)
- [Cisco ISR1100-4GLTE Routers, on page 7](#)
- [Power Supply, on page 10](#)
- [LED Indicators on Cisco ISR1100-4G, Cisco ISR1100X-4G, Cisco ISR1100-6G, and Cisco ISR1100X-6G Routers, on page 11](#)
- [LED Indicators on Cisco ISR1100-4GLTE Routers, on page 13](#)
- [Wireless Specifications for the Cisco ISR1100-4GLTE Platform, on page 15](#)

Comparison of Models

The following table provides a comparison of select features among Cisco ISR 1100 and ISR 1100X Series models.

Model	CPU	Memory	GE SFP Ports	Micro SIM	LTE Debug Micro-USB
ISR1100-4G	Intel 2.2 GHz 4-core	4 GB	0	0	0
ISR1100X-4G	Intel 2.2 GHz 4-core	8 GB	0	0	0
ISR1100-6G	Intel 2.2 GHz 4-core	4 GB	2	0	0

Model	CPU	Memory	GE SFP Ports	Micro SIM	LTE Debug Micro-USB
ISR1100X-6G	Intel 2.2 GHz 4-core	8 GB	2	0	0
ISR1100-4GLTE	Intel 2.2 GHz 4-core	4 GB	0	1	1

Cisco ISR1100-4G and Cisco ISR1100X-4G Routers

This topic describes the chassis and provides technical specifications for the following:

- Cisco ISR1100-4G router
- Cisco ISR1100X-4G router

Chassis Views

The figures below show the front, side, and back panels of the Cisco ISR1100-4G router. The corresponding panels of the Cisco ISR1100X-4G router are comparable to these.

Figure 1: Front Panel

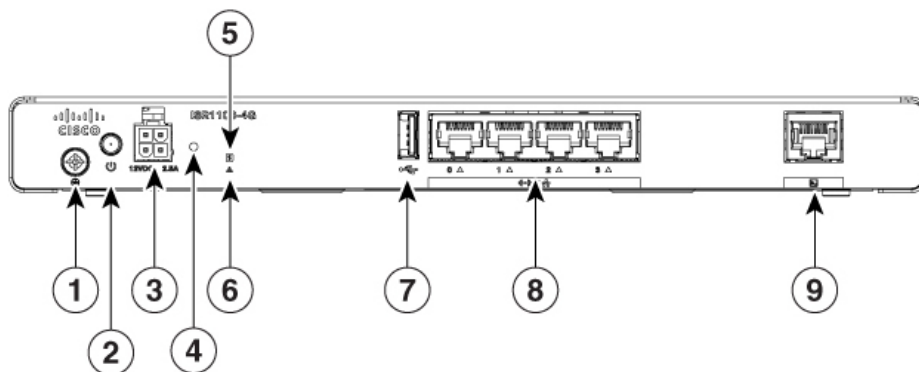

369637

Figure 2: Side Panel

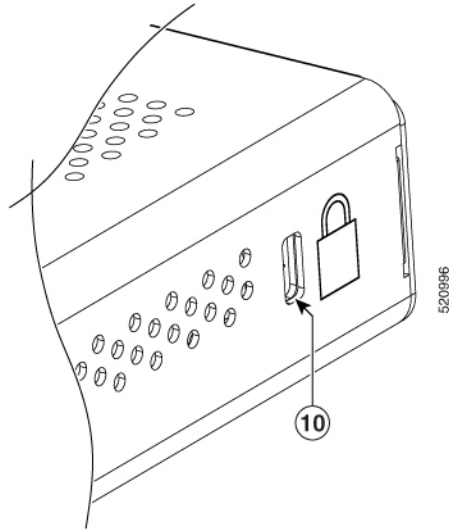

1	Ground Screw
2	Power Button
3	12 VDC Input
4	Reset Button
5	System LED
6	Status LED
7	Type A USB port
8	RJ-45 Ethernet Ports
9	RJ-45 Console Port
10	Kensington Lock Slot

Figure 3: Back Panel



Chassis Specifications

Item	Specification
Services and Slot Density	
CPU	Intel 2.2 GHz 4-core

Item	Specification
RJ45 Console	1 Note The console port only supports a baud rate of 115,200.
USB Type A	USB 3.0, 4.5 W Maximum
Bulk Flash	8 GB eMMC pSLC (5.8 GB usable)
Serial Flash	Dual 16MB
Memory DDR4 ECC DRAM	Cisco ISR1100-4G: 4 GB Cisco ISR1100X-4G: 8 GB
GE WAN Ports	4
Physical Specifications	
Form Factor	10.2 in x 7 in x 1.1 in
Operating Conditions	
Temperature	Fanless design 0 to 40°C (32 to 104°F) at sea level (temperature de-rating of 1.5 deg C per 1000 feet of altitude applicable up to max of 10,000 feet or 3000 m)
Altitude	Max 3000 m (10000 ft)
Humidity	10 to 85% RH non-condensing
Transportation/Storage Conditions	
Temperature	-40 to 70°C (-40 to 158°F)
Humidity	5 to 95% RH non-condensing
Altitude	4570 m (15,000 ft)
Reliability	
MTBF	Approximately 1.6 million hours (about 183 years) at 25°C ambient

Regulatory Compliance: For information on regulatory compliance (EMC, safety, and environment), see [ISR1100-4G/6G Data Sheet](#).

Cisco ISR1100-6G and Cisco ISR1100X-6G Routers

This topic describes the chassis and provides technical specifications for the following:

- Cisco ISR1100-6G

- Cisco ISR1100X-6G

Chassis Views

The figures below show the front, side, and back panels of the Cisco ISR1100-6G router. The corresponding panels of the Cisco ISR1100X-6G router are comparable to these.

Figure 4: Front Panel

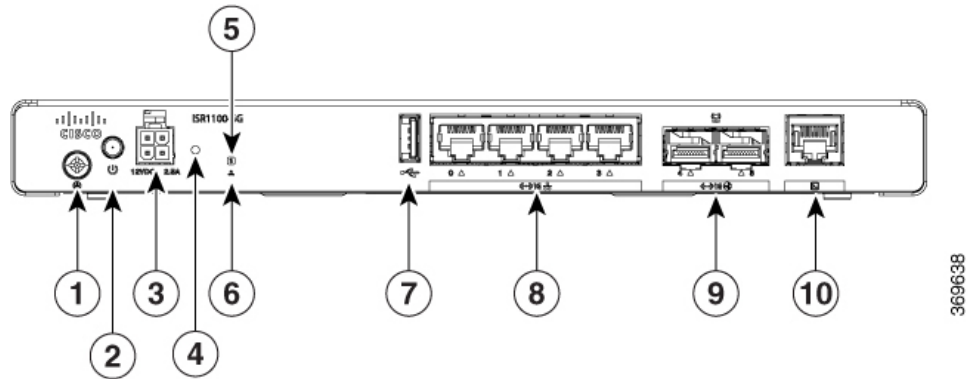
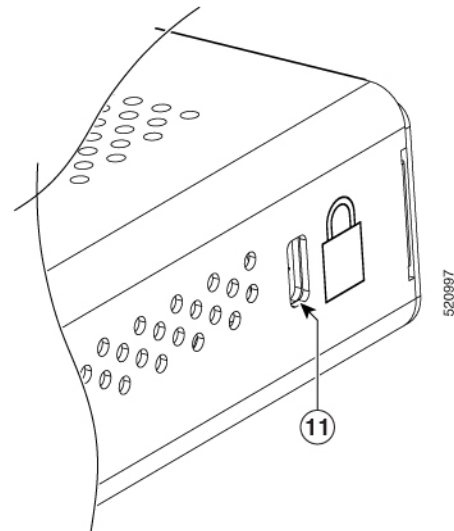

Figure 5: Side Panel



1	Ground Screw
2	Power Button
3	12 VDC Input
4	Reset Button
5	System LED
6	Status LED

7	Type A USB port
8	RJ-45 Ethernet Ports
9	SFP Ethernet ports
10	RJ-45 Console Port
11	Kensington Lock Slot

Figure 6: Back Panel



Chassis Specifications

Item	Specification
Services and Slot Density	
CPU	Intel 2.2 GHz 4-core
RJ45 Console	1 Note The console port only supports a baud rate of 115,200.
USB Type A	USB 3.0, 4.5 W Maximum.
Bulk Flash	<ul style="list-style-type: none"> • Cisco ISR1100-6G: 8GB eMMC pSLC (5.8 GB usable) • Cisco ISR1100X-6G : 16GB eMMC pSLC (13.1 GB usable)
Serial Flash	Dual 16 MB
Memory DDR4 ECC DRAM	Cisco ISR1100-6G: 4 GB Cisco ISR1100X-6G : 8 GB
GE WAN Ports	4
GE SFP Ports	2
Physical Specifications	
Form Factor	10.2 in x 7 in x 1.1 in
Operating Conditions	

Item	Specification
Temperature	Fanless design 0 to 40°C (32 to 104°F) at sea level (temperature de-rating of 1.5 deg C per 1000 feet of altitude applicable up to max of 10,000 feet or 3000 m)
Altitude	Maximum 3000 m (10000 ft)
Humidity	10 to 85% RH non-condensing
Transportation/Storage Conditions	
Temperature	-40 to 70°C (-40 to 158°F)
Humidity	5 to 95% RH non-condensing
Altitude	4570 m (15000 ft)
Reliability	
MTBF	Approximately 1.6 million hours (about 183 years) at 25°C ambient

Regulatory Compliance: For information on regulatory compliance (EMC, safety, and environment), see [ISR1100-4G/6G Data Sheet](#).

Cisco ISR1100-4GLTE Routers

This topic describes the chassis and technical specifications of the Cisco ISR1100-4GLTE routers.

Cisco ISR1100-4GLTE Variants

Cisco ISR1100-4GLTE routers are available in these variants:

- Cisco ISR1100-4GLTENA
- Cisco ISR1100-4GLTEGB

These routers come with built-in, Category-4 modems. There is no difference in the hardware specifications of Cisco ISR1100-4GLTENA and Cisco ISR1100-4GLTEGB. The difference is only in terms of the LTE bands supported. See [Wireless Specifications for the Cisco ISR1100-4GLTE Platform](#) for more details.

Cisco ISR1100-4GLTE Chassis

The following figures show the front, side, and back panels of the Cisco ISR1100-4GLTE routers.



Note For the purpose of illustration, the figure shows the chassis of Cisco ISR1100-4GLTEGB

Figure 7: Front Panel (SIM Cover Removed to Show SIM Slot)

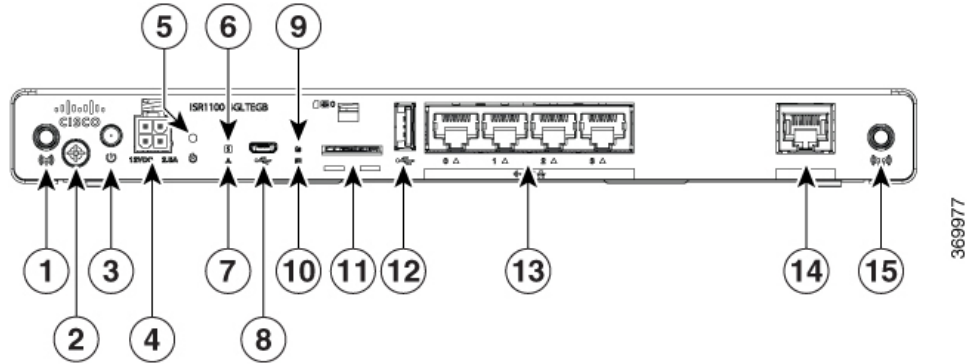
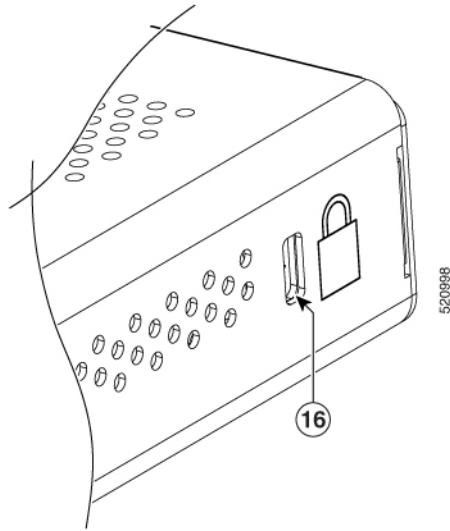

Figure 8: Side Panel



1	Main Antenna
2	Ground Screw
3	Power Button
4	12 VDC Input
5	Reset Button
6	System LED
7	Status LED
8	Micro USB
9	Received signal Strength Indicator (RSSI) LED
10	SIM LED

11	SIM Slot
12	USB Port
13	RJ-45 Ethernet Ports
14	RJ-45 Console
15	Antenna (Diversity)
16	Kensington Lock Slot

Figure 9: Back Panel



Figure 10: SIM Slot (SIM Cover Removed)

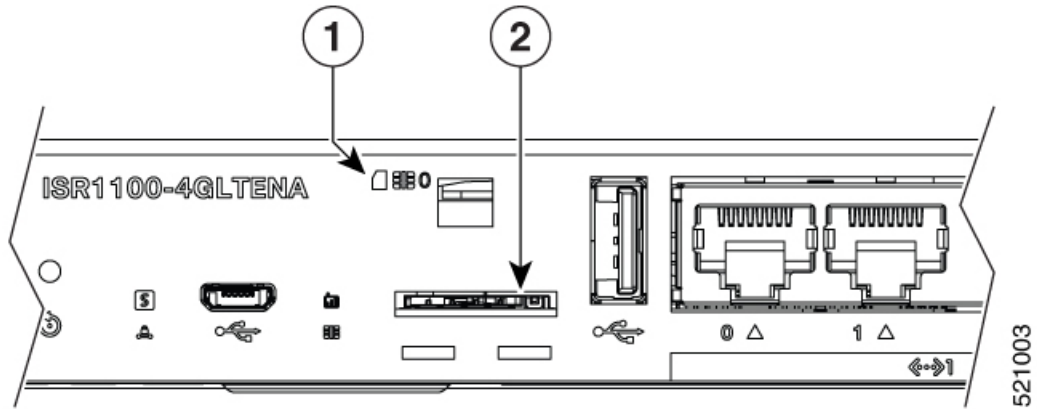

1	Indicates SIM Card Orientation
2	SIM Slot

Chassis Specifications

Item	Specification
Services and Slot Density	
RJ45 Console	1 Note The console port only supports a baud rate of 115,200.
Ethernet RJ45 Ports	4
USB Type A	USB 3.0, 4.5 W Maximum

Item	Specification
Bulk Flash	8 GB eMMC pSLC Note Usable memory is 5.8 GB only.
Serial Flash	Dual 16MB
Memory DDR4 ECC DRAM	4 GB
GE WAN Ports	4
Micro-SIM Socket	1
LTE Debug Port	1 (Micro USB Connector)
Physical Specifications	
Form Factor	10.2 in x 7 in x 1.1 in
Operating Conditions	
Temperature	Fanless design 0 to 40°C (32 to 104°F) at sea level (temperature de-rating of 1.5 deg C per 1000 feet of altitude applicable up to max of 10,000 feet or 3000 m)
Altitude	Max 3000 m (10000 ft)
Humidity	10 to 85% RH non-condensing
Transportation/Storage Conditions	
Temperature	-40 to 70°C (-40 to 158°F)
Humidity	5 to 95% RH non-condensing
Altitude	4570 m (15,000 ft)
Reliability	
MTBF	Approximately 1.6 million hours (about 183 years) at 25°C ambient

Regulatory Compliance: For information on regulatory compliance (EMC, safety, and environment), see [ISR1100-4G/6G Data Sheet](#).

Power Supply

The following models use the same external Power Supply Unit (PSU):

- Cisco ISR1100-4G
- Cisco ISR1100X-4G

- Cisco ISR1100-6G
- Cisco ISR1100X-6G
- Cisco ISR1100-4GLTE

The external power supply specifications are as follows.

Table 1: External Power Supply Unit Specifications

AC input voltage	100-240 VAC nominal
AC input line frequency	50-60 Hz
Maximum Output Power	30 Watts
Output Voltage	12 VDC
P/N	PWR-30W-I-AC



Note Do not hang the Power Supply Unit (PSU) from the power socket. Place it on a surface.

LED Indicators on Cisco ISR1100-4G, Cisco ISR1100X-4G, Cisco ISR1100-6G, and Cisco ISR1100X-6G Routers

LED Indicators on Cisco ISR1100-4G and Cisco ISR1100X-4G

Figure 11: Front Panel LED Indicators

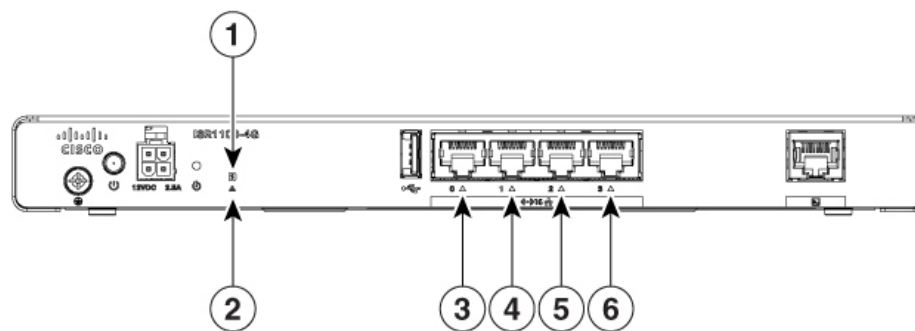

1	SYS LED
2	STATUS LED
3, 4, 5, 6	RJ-45 Ethernet Port LED

Table 2: LED Indicator Behavior

Port	LED Color	Description
SYS	OFF	System is off
	Amber (blinking)	Boot up phase
	Green steady on	Normal operation
	Amber (steady)	System going down/fault
STATUS	Green	OMP connection is up
	OFF	System is down or OMP connection is down
RJ-45 Ethernet Port LEDs (0-3)	Green solid	Link is established
	Green (blinking)	Data transmission is in progress
	OFF	Link is not connected or is down

LED Indicators on Cisco ISR1100-6G, Cisco ISR1100X-6G

Figure 12: Front Panel LED Indicators

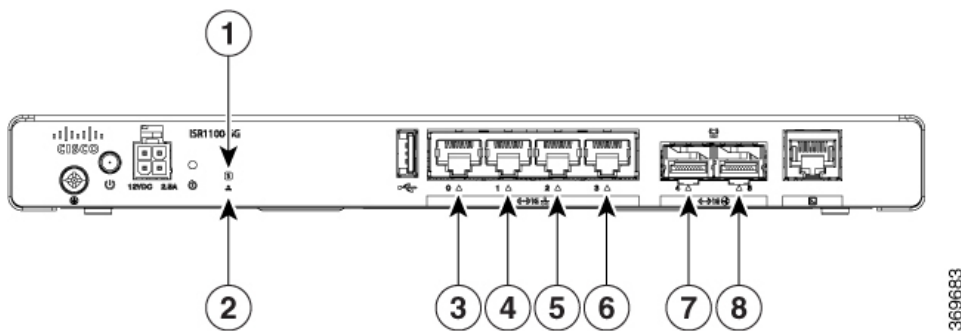

1	SYS LED
2	STATUS LED
3, 4, 5, 6	RJ-45 Ethernet Port LED
7, 8	SFP Ethernet Port LED

Table 3: LED Indicator Behavior

Port	LED Color	Description
SYS	OFF	System is off
	Amber (blinking)	Boot up phase
	Green steady on	Normal operation
	Amber (steady)	System going down/fault
STATUS	Green	OMP connection is up
	OFF	System is down or OMP connection is down
RJ-45 Ethernet Port LEDs (0-3)	Green (solid)	Link is established
	Green (blinking)	Data transmission in progress on the link
	OFF	Link is not connected or is down
SFP Ethernet Port LEDs (4-5)	Green (solid)	Link is established
	Green (blinking)	Data transmission in progress on the link
	OFF	Link is not connected or is down

LED Indicators on Cisco ISR1100-4GLTE Routers

The following figure and table describe the LED indicators on the front panel of the Cisco ISR1100-4GLTE routers.



Note The figure shows a Cisco ISR1100-4GLTEGB router.

Figure 13: Front Panel LED Indicators on Cisco ISR1100-4GLTE Routers

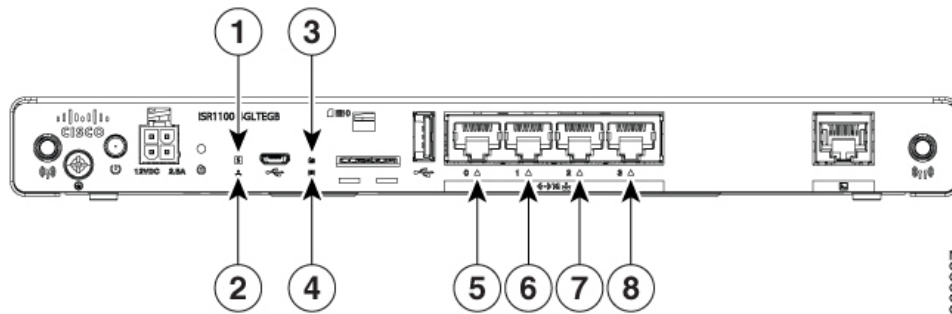

1	System LED
2	Status LED
3	RSSI LED
4	SIM LED
5, 6, 7, 8	RJ-45 Ethernet Port LEDs

The following table applies to both Cisco ISR1100-4GLTENA and Cisco ISR1100-4GLTEGB routers.

Table 4: LED Indicator Behavior

Port	LED Color	Description
SYS	OFF	System is off
	Amber (blinking)	Boot up phase
	Green steady on	Normal operation
	Amber (steady)	System going down/fault
STATUS	Green	OMP connection is up
	OFF	System is down or OMP connection is down
RSSI LED	OFF	LTE interface is shut
	Green (steady)	LTE is enabled, excellent signal
	Green/Orange (blinking)	LTE is enabled, good signal
	Orange (steady)	LTE is enabled, poor signal
	Orange (blinking)	LTE is enabled, but there is some error (no connectivity with BTS or lack of signal)
SIM LED	OFF	No SIM or SIM is offline
	On 1sec, Off 1sec	Low power mode
	On 200 ms, Off 5 sec	No service
	On (steady)	In service
	On 5 sec, Off 200 ms	Roaming
	On 400 ms, Off 100 ms	Data Active

Port	LED Color	Description
RJ-45 Ethernet Port LEDs (0-3)	Green (solid)	Link is established
	Green (blinking)	Data transmission in progress on the link
	OFF	Link is not connected or is down

Wireless Specifications for the Cisco ISR1100-4GLTE Platform

This table lists wireless specifications for Cisco ISR1100-4GLTENA and Cisco ISR1100-4GLTEGB routers.

Table 5: Wireless Specifications for Cisco ISR1100-4GLTE Routers

Features	Cisco ISR1100-4GLTENA	Cisco ISR1100-4GLTEGB
Region	North America	Global
4G LTE Bands	<ul style="list-style-type: none"> • Band 2 (1900 MHz) • Band 4 (1700 MHz) • Band 5 (850 MHz) • Bands 12, 13, 14, 17 (700 MHz) • Band 66 (1700 MHz) 	<ul style="list-style-type: none"> • Band 1 (2100 MHz) • Band 3 (1800 MHz) • Band 7 (2600 MHz) • Band 8 (900 MHz) • Band 20 (800 MHz) • Band 28 (700 MHz)



CHAPTER 2

Preinstallation

This chapter provides preinstallation information, such as recommendations and requirements that must be met before installing your router. Before you begin, inspect all items for shipping damage. If anything appears to be damaged or if you encounter problems installing or configuring your router, contact customer service.

- [General Safety Standards, on page 17](#)
- [Site Preparation Guidelines, on page 18](#)
- [Environmental Requirements, on page 19](#)
- [Tools and Equipment Required for Installation, on page 19](#)

General Safety Standards

General Safety Warnings



Warning This warning symbol means danger. You are in a situation that could cause bodily injury. Before you work on any equipment, be aware of the hazards involved with electrical circuitry and be familiar with standard practices for preventing accidents. Use the statement number provided at the end of each warning to locate its translation in the translated safety warnings that accompanied this device. Statement 1071

SAVE THESE INSTRUCTIONS

Safety with Electricity



Warning Ultimate disposal of this product should be handled according to all national laws and regulations. Statement 1040



Warning This product relies on the building's installation for short-circuit (overcurrent) protection. Ensure that the protective device is rated not greater than 20A. Statement 1005



Warning Only trained and qualified personnel should be allowed to install, replace, or service this equipment. Statement 1030



Caution Before removing or installing router modules and components, ensure that the router chassis is electrically connected to ground. Ensure that you attach an ESD grounding strap to an ESD point and place the other end of the strap around your bare wrist making good skin contact. Failure to use an ESD grounding strap could result in damage to the router.



Caution Some router components are hot-swappable and hot-insertable. You can remove and replace them without powering off or disconnecting power to the router. Do not, however, install the router or any of its component if they appear to be damaged.

- Locate the emergency power-off switch in the room in which you are working. In case of an electrical accident, quickly turn off the power.
- Disconnect power before installing or removing the router.
- If an electrical accident occurs, use caution and immediately turn off power to the router.
- Do not work alone if hazardous conditions exist.
- Always check that power is disconnected from a circuit. Never assume that it is disconnected.
- Carefully inspect your work area for possible hazards, such as moist floors, worn-out power cords, ungrounded power extension cords, and missing safety grounds.
- Operate the device within marked electrical ratings and product usage instructions.
- To ensure that the router and the FRUs function safely and correctly, use the specified cables and connectors, and make certain they are in good condition.

Site Preparation Guidelines

Efficient operation of routers requires proper site planning and proper layout of your equipment rack or wiring closet:

- Ensure that the area around the router is kept free of dust and conductive material.
- Follow appropriate airflow guidelines so that the cooling system functions normally.
- Follow ESD prevention procedures to avoid any damage to the router.



Warning Installing or mounting of devices with LTE radio must be done such that a minimum separation distance (distance between a person and the device, or the device's antennas) of 20 cm is always ensured.

Environmental Requirements

Install the routers in a dry, clean, temperature-controlled, and well-ventilated environment:

- For the router to operate normally, maintain an ambient temperature in the range 0°C to 40°C (32°F to 104°F). If the ambient temperature is too high or the air vents are blocked, the router can overheat.
- Avoid temperature extremes. Ensure that the router is operating at an ambient temperature not more than 40°C (104°F) at sea level. For higher altitudes, a derating of 1.50°C per 1,000 feet applies.
- High humidity conditions can cause moisture to penetrate into the chassis. The devices support 10% to 85% humidity levels, non-condensing.

Airflow Requirements

When planning your site for installing Cisco ISR 1100 and ISR 1100X Series Routers routers, allow enough clearance around the installed router.

Tools and Equipment Required for Installation

You need the following tools and equipment to install and upgrade the router and its components:

- ESD-preventive cord and wrist strap
- Number 2 Phillips screwdriver
- Phillips screwdrivers: small, 3/16-in. (4 to 5 mm) and medium, 1/4-in. (6 to 7 mm)
- Wire crimper
- Copper wire for connecting the chassis to an earth ground:
 - AWG 14 (2 mm²) or larger for chassis grounding
- For grounding, an appropriate user-supplied ring terminal sized appropriately for a #6-32 screw.



CHAPTER 3

Install and Connect Cisco ISR 1100 and ISR 1100X Series Routers

This chapter describes how to install and connect Cisco ISR 1100 and ISR 1100X Series Routers.

- [Unpack Router, on page 21](#)
- [Install Cisco ISR 1100 and ISR 1100X Series Routers, on page 21](#)
- [Connect Cisco ISR 1100 and ISR 1100X Series Routers, on page 29](#)

Unpack Router

Do not unpack the router until you are ready to install it. If the final installation site is not yet ready, keep the chassis in its shipping container to prevent accidental damage.

The router, accessory kit, publications, and any optional equipment that you ordered may be shipped in more than one container. When you unpack the containers, check the packing list to ensure that you received all the items on the list.

Install Cisco ISR 1100 and ISR 1100X Series Routers

Cisco ISR 1100 and ISR 1100X Series Routers can be installed in the following ways:

- [Mount the Router on a Desk or Shelf, on page 22](#)
- [Mount the Router on a Wall, on page 23](#)
- [Mount the Router on a Rack Tray, on page 26](#)



Warning Statement 1004

Read the installation instructions before using, installing or connecting the system to the power source.

**Warning Statement 1074**

Installation of the equipment must comply with local and national electrical codes.

**Warning Statement 1005—Circuit Breaker**

This product relies on the building's installation for short-circuit (overcurrent) protection. To reduce risk of electric shock or fire, ensure that the protective device is rated not greater than:

20A

**Warning** This product is a Class 1 laser product.**Warning Statement 1076**

To prevent airflow restriction, allow clearance around the ventilation openings to be at least: 1.75 in. (4.4 cm).

Mount the Router on a Desk or Shelf

You can mount the chassis on a desktop by placing it on a desk in a horizontal position. Make sure there are no blockages or obstructions within one inch of the top of the chassis or within 0.5 inches of the sides so that nothing interferes with cooling.

The bottom of the router has four rubber feet that protect the router and the surface. Do not remove the rubber feet included with the chassis. They are needed for proper cooling.

Figure 14: Mount on a Desk or Shelf

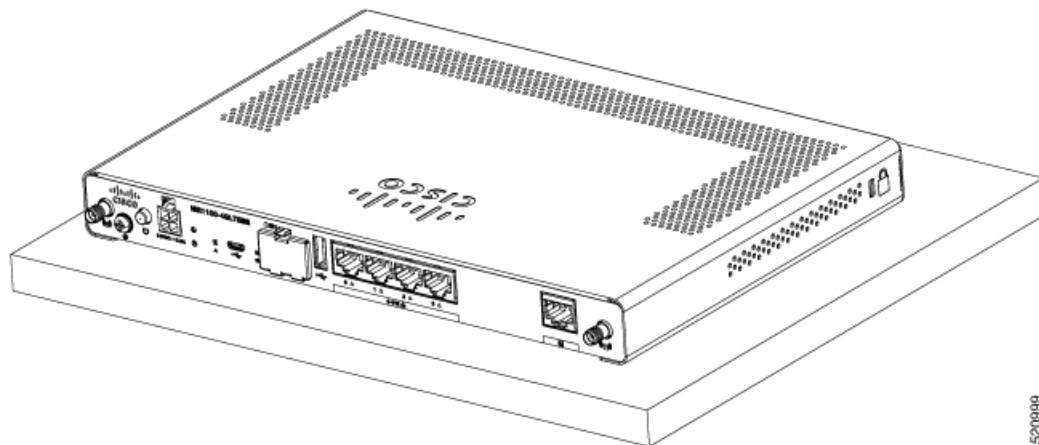

5200988



Note Do not stack routers.

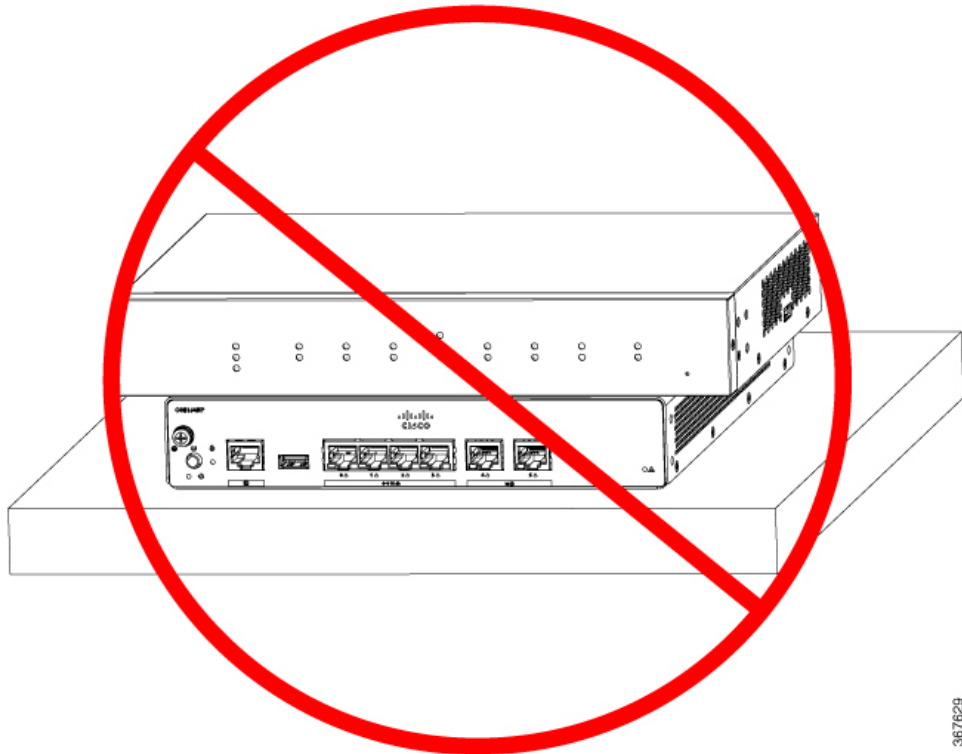

367629

Mount the Router on a Wall

Cisco ISR 1100 and ISR 1100X Series routers designed for wall-mounting have mounting holes on the bottom of the chassis for securing with screws or anchors to a vertical surface. Note the **UP** marking on the bottom of the chassis, indicating the correct direction for mounting the router.



Note Read the wall-mounting instructions carefully before beginning installation. Failure to use the correct hardware or to follow the correct procedures could result in a hazardous situation to people and damage to the system. Statement 378



Note For safety reasons, the only supported wall-mount orientation is as shown in step 3 below. The mounting slots support only this orientation. Marking is provided on the bottom of the router (see step 1) showing the correct orientation.



Note When choosing a location for wall mounting the router, consider cable limitations and wall structure.

Mount the Router on a Wall

1. Determine where to drill holes in the wall, based on the positions of the mounting holes on the router. The following figure shows the wall-mount holes located on the underside of the router.

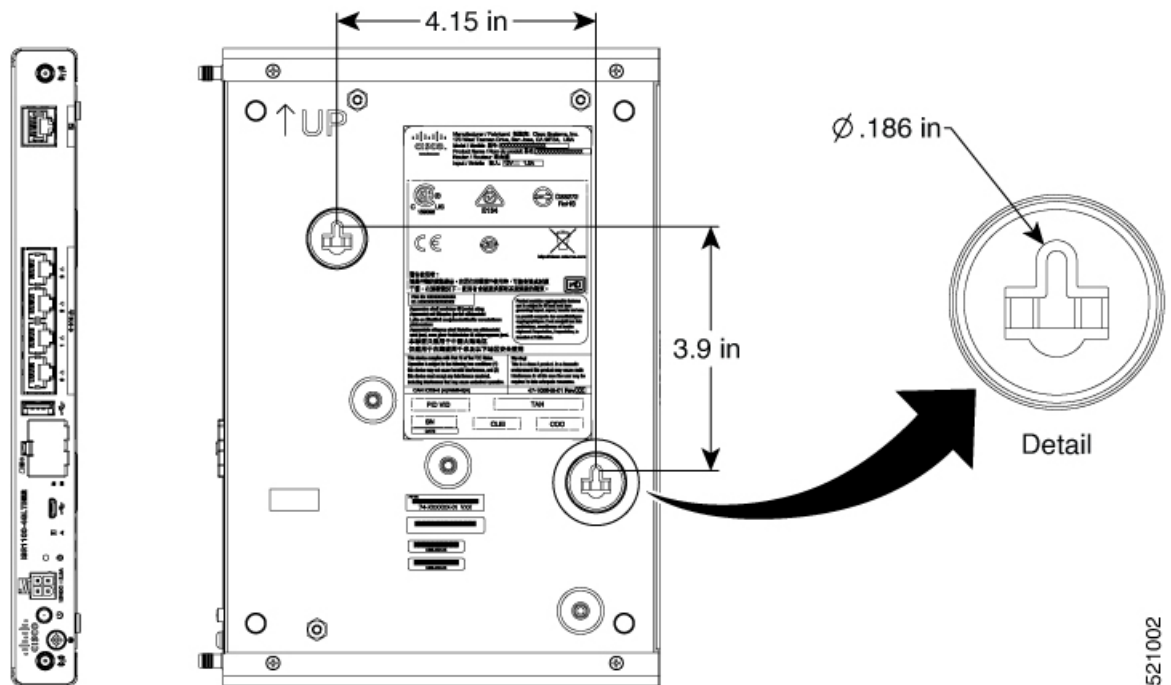

521002

2. Drill holes in the wall in the correct positions for the router mounting holes.
3. Insert screws, using anchors if necessary, depending on the wall material. Use screws that fit the mounting holes on the router. A minimum of .073 inch (1.9 mm) is required between the screw head and the wall in order to secure the router to the wall.

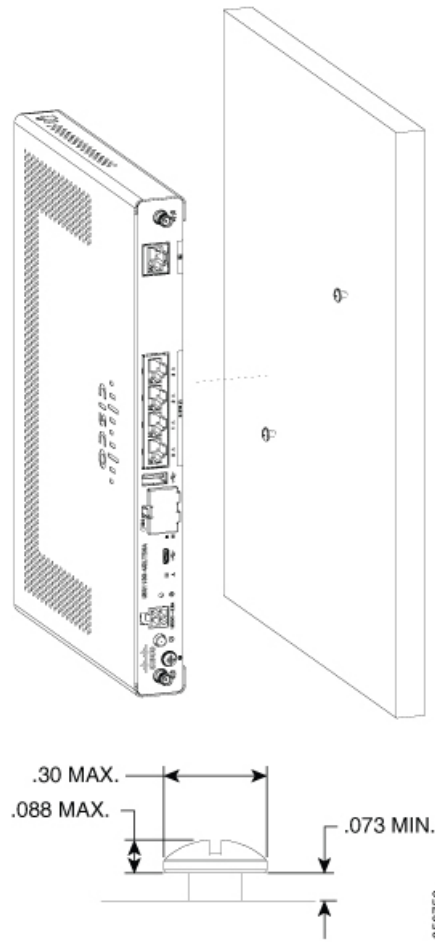

4. Hang the router on the screws without forcibly pushing towards the wall side.

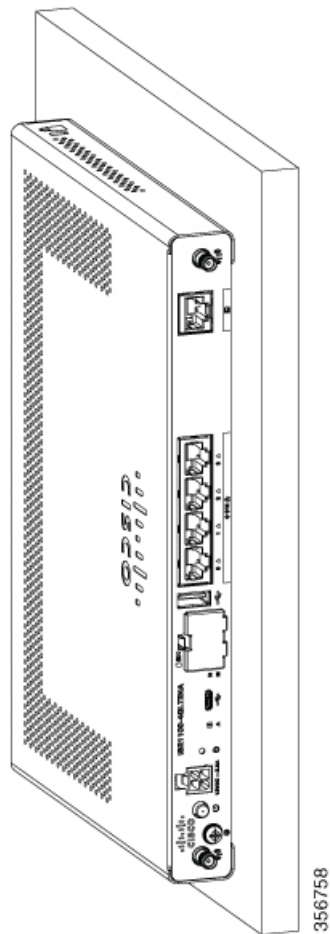

Mount the Router on a Rack Tray

You can mount Cisco ISR 1100 and ISR 1100X Series routers on an equipment rack tray (product ACS-1100-RM1-19) designed specifically for these devices. There are two options for securing the router to the rack tray:

- Secure the router and external power supply using straps.
- Secure the router using mounting screws and the external power supply using a strap.

You can mount the router with the front panel, containing the ports, facing the front of the rack tray or the back of the tray.

Secure the Router and Power Supply Using Straps

1. Place the router and external power supply onto the rack tray as shown in the following figure. You can mount the router with the front panel, containing the ports, facing the front of the tray or facing the back of the tray.

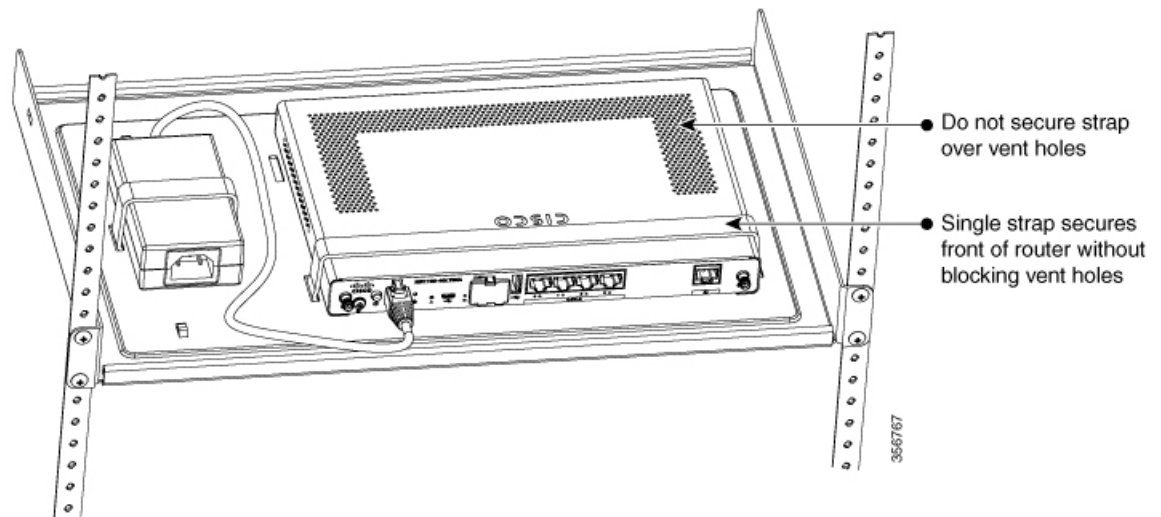

2. Using the straps included with the rack tray, secure the external power supply and the router chassis, as shown.
Use only one strap to secure the chassis. Ensure that the strap does not cover any of the ventilation holes. Blocking ventilation holes affects airflow and can interfere with router cooling.
3. Bundle any excess length of the power cable using plastic cable ties and secure the cable to the tray using one of the bridge lance attachment points on the left side of the tray, near the power supply position.

Secure the Router Using Mounting Screws

1. On the bottom of the router, remove the four screws that secure the router cover.

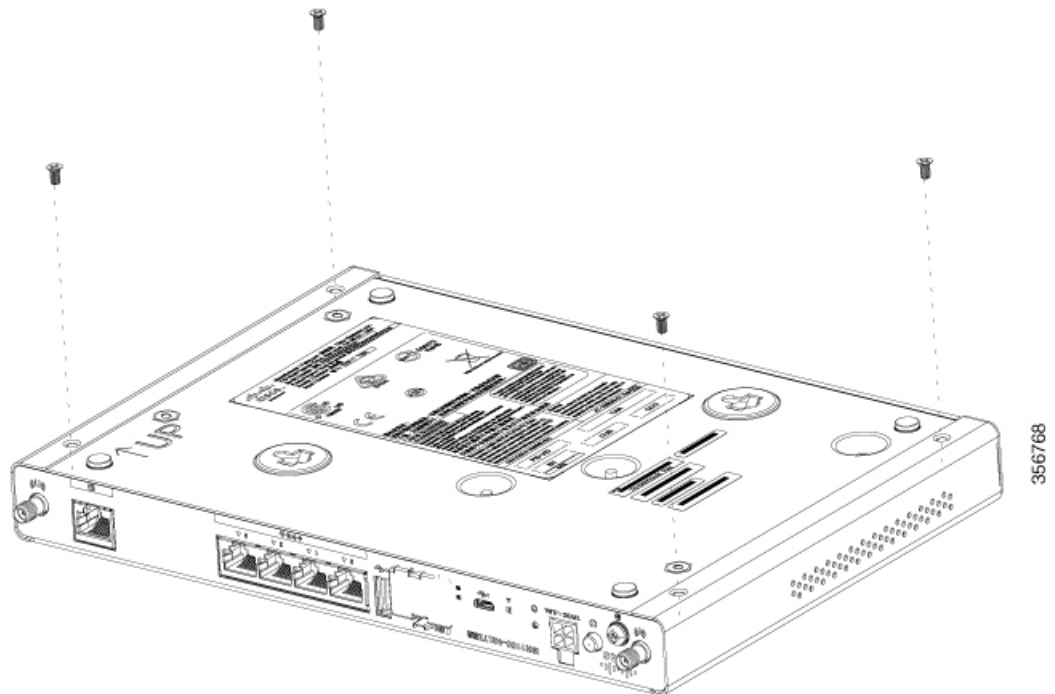

Mount the Router on a Rack Tray

- Secure the router to the rack tray using the M3 mounting screws from the rack tray kit. Tighten to between 5 and 6.8 inch pounds of torque. You can mount the router with the front panel, containing the ports, facing the front of the tray or facing the back of the tray.



Note If there is equipment installed above and below the rack position intended for the tray and router, it may be easier to mount the router to the tray before installing the tray in the rack. This ensures clear access for positioning the router on the tray and for inserting the mounting screws.

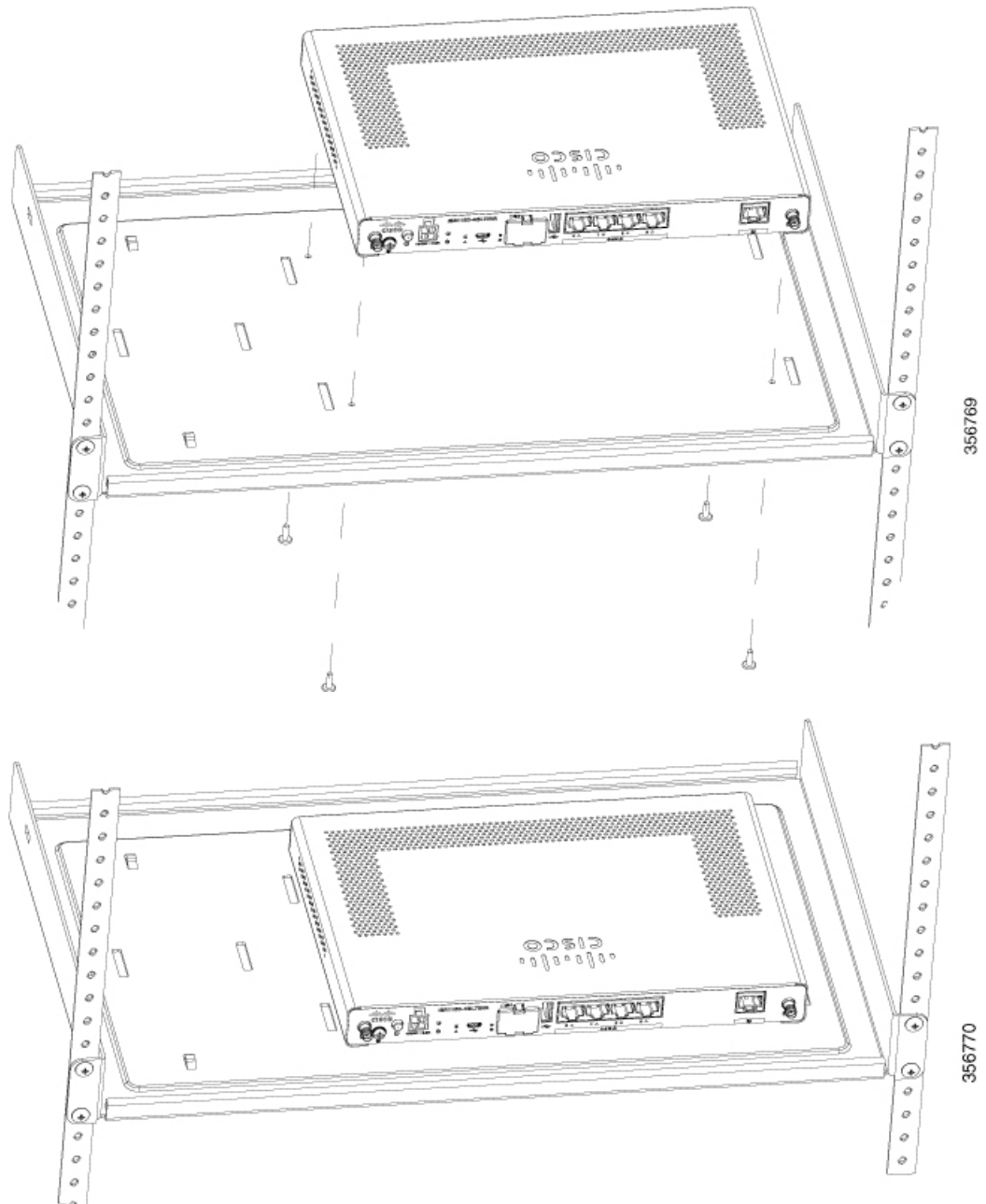

- Place the external power supply onto the rack tray and use a strap included with the rack tray to secure the power supply.

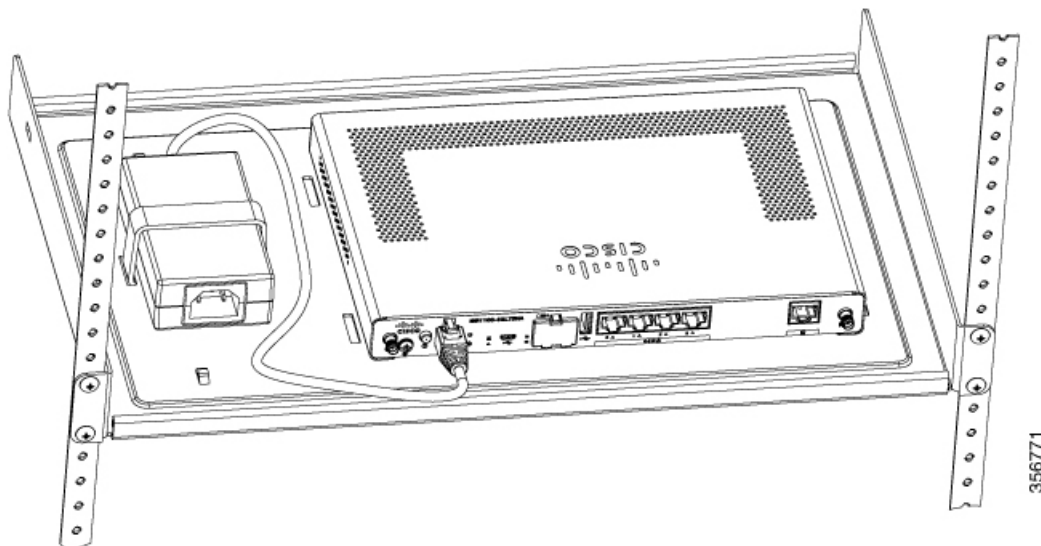

- Bundle any excess length of the power cable using plastic cable ties. Secure the cable to the tray using one of the bridge lance attachment points on the left side of the tray, near the power supply position.

Connect Cisco ISR 1100 and ISR 1100X Series Routers

Chassis Grounding



Warning

Connect the Chassis to Earth Ground—To reduce the risk of electric shock, the chassis of this equipment needs to be connected to permanent earth ground during normal use. Statement 445



Warning

Only trained and qualified personnel should be allowed to install, replace, or service this equipment. Statement 1030

To meet safety and electromagnetic interference (EMI) requirements and to ensure proper operation of Cisco ISR1100 and ISR1100X Series routers, connect the router to a reliable earth ground before powering it on.



Note

You need to use your own 14 AWG copper wire and ring terminal. These are not part of the accessory kit.

- For grounding the chassis, use a copper wire of size 14 AWG and a ring terminal.
- Strip one end of the ground wire to the length required for the ground lug or the ring terminal, and attach the ring terminal to the cable.

3. Crimp the ground wire to the ground lug or ring terminal, using a crimp tool of the appropriate size.
4. Make sure that the cable does not touch or block access to other router components.
5. Using a number 2 Phillips (+) screwdriver, attach the ground lug to the router using the UNC 6-32 screw included with the router. Tighten to between 8.3 and 11.0 inch pounds of torque.

Figure 15: Chassis Grounding for Cisco ISR1100 and ISR1100X Series Models (Cisco ISR1100-4G Model Shown)

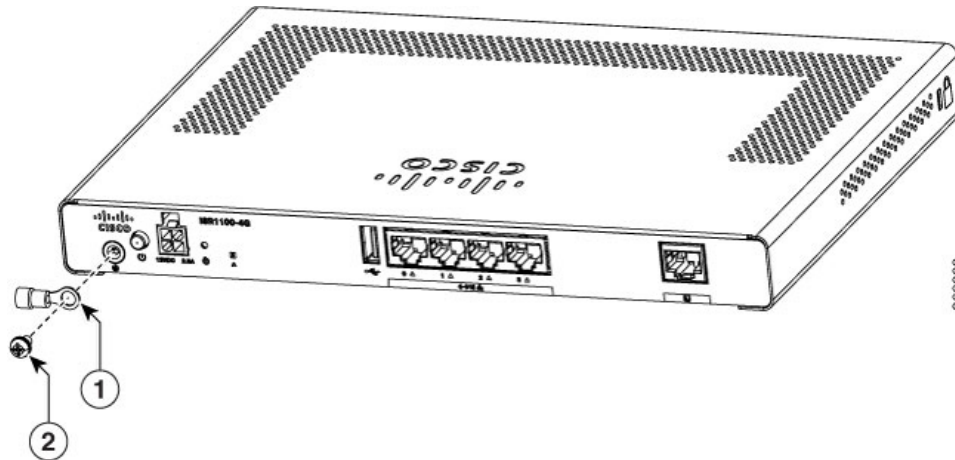

1	Ground Lug
2	Screw (UNC 6-32)

Connect the Power Cable

Before you connect power to the router, ensure that you have:

- Electrostatic discharge (ESD) grounding strap.
- Power cords appropriate for your location.

Connect Router to AC Power

Before you power the router, first ensure that it is connected to earth ground. Next, plug the power supply output cable to the 4-pin power connector on the front panel. Finally, plug the input power cord to the AC power source.

When removing the power connector, press the latch on the top of the connector to release it from the socket.



Warning

To prevent the system from overheating, do not operate it in an area that exceeds the maximum recommended ambient temperature of 104°F (40°C). Statement 1047

Figure 16: Power Connector

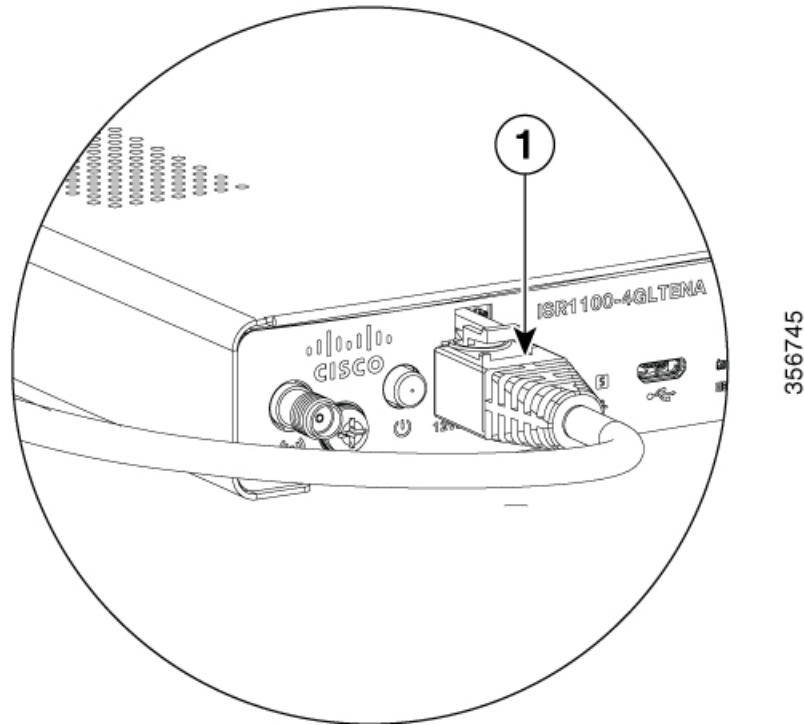

356745

	Item
1	Power Cable Connector

Connect the Router to a Console

You can configure and manage Cisco ISR1100 and ISR1100X Series routers using a management console. To connect the router to a management console, use the console port which accepts a cable with an RJ-45 connector.

To connect the router to a console:

1. Connect the end of the console cable with the RJ-45 connector to the console port on the router.
2. Connect the end of the cable with the DB-9 connector (or USB Type-A) to the terminal or PC. If your terminal or PC has a console port that does not accommodate a DB-9 connector, you must provide an appropriate adapter for that port.



Caution Power over Ethernet (PoE) enabled cables can damage the console port. Do not accidentally connect these cables to the console port.



CHAPTER 4

Default Configuration at Startup

Cisco ships each Cisco ISR 1100 and ISR 1100X Series router from the factory with a default configuration, either for Cisco vEdge operating system or Cisco IOS XE. The default configuration file sets the default CLI prompt, configures OMP, and enables logging of syslog messages to a file.

Smart Licensing

The default configurations include a command that relates to Cisco Smart Licensing. For information about Cisco Smart Licensing, see the [Cisco Smart Licensing Guide](#).

- [Cisco ISR1100-4G and Cisco ISR1100-6G Routers, Cisco vEdge Operating System, on page 33](#)
- [Cisco ISR1100-4GLTE Routers, Cisco vEdge Operating System, on page 35](#)
- [Cisco ISR1100-4G Routers, Cisco IOS XE, on page 37](#)
- [Cisco ISR1100-6G Routers, Cisco IOS XE, on page 38](#)
- [Cisco ISR1100-4GLTE Routers, Cisco IOS XE, on page 40](#)

Cisco ISR1100-4G and Cisco ISR1100-6G Routers, Cisco vEdge Operating System

The following is the default configuration at start up for the following router models when ordered with Cisco vEdge operating system.

- Cisco ISR1100-4G
- Cisco ISR1100X-4G
- Cisco ISR1100-6G
- Cisco ISR1100X-6G



Note This information is provided for convenience. Default configurations are subject to change.

```
device# show running-config
system
host-name vedge
```

```

admin-tech-on-failure
no route-consistency-check
vbond ztp.viptela.com

aaa

auth-order local radius tacacs

usergroup basic
  task system read write
  task interface read write
!

usergroup netadmin
!

usergroup operator
  task system read
  task interface read
  task policy read
  task routing read
  task security read
!

usergroup tenantadmin
!

user admin
  password
  $6$tebXK3g64cMdWjSp$kIbJ/qShDI4/eLQ0M8NlyCK7rlmsZAlnwGFqCVZc7rNlIE6f801Q6IuP4pHJinc8pSTNGAEYtoCAwDuAiGPF9/
!
!
logging
  disk
  enable
!
!
!
omp
no shutdown
graceful-restart
advertise connected
advertise static
!
security
ipsec
  authentication-type ah-sha1-hmac sha1-hmac
!
!
```

```

vpn 0
interface ge0/0
  ip dhcp-client
  ipv6 dhcp-client
  tunnel-interface
  encapsulation ipsec
  no allow-service bgp
  allow-service dhcp
  allow-service dns
  allow-service icmp
  no allow-service sshd
  no allow-service netconf
  no allow-service ntp
  no allow-service ospf
  no allow-service stun
  allow-service https
  !
  no shutdown
!
!
vpn 512
!
```

Cisco ISR1100-4GLTE Routers, Cisco vEdge Operating System

The following is the default configuration at start up for the following router models when ordered with Cisco vEdge operating system.

- Cisco ISR1100-4GLTENA
- Cisco ISR1100-4GLTEGB



Note This information is provided for convenience. Default configurations are subject to change.

```

Device# show running-config
system
  host-name                vedge
  admin-tech-on-failure
  no route-consistency-check
  vbond ztp.viptela.com
  aaa
  auth-order local radius tacacs
  usergroup basic
    task system read write
    task interface read write
  !
  usergroup netadmin
  !
  usergroup operator
    task system read
    task interface read
    task policy read
    task routing read
    task security read
  !
  usergroup tenantadmin
  !
  user admin
```

```

password
$6$tebXK3g64cMdWjSp$kIbJ/qShDI4/eLQ0M8NlyCK7rlmsZAlnwGFqCVZc7rNlIE6f801Q6IuP4pHJinc8pSTNGAEYtoCAwDuAiGPF9/

!
!
logging
disk
enable
!
!
!
omp
no shutdown
graceful-restart
advertise connected
advertise static
!
security
ipsec
authentication-type ah-shal-hmac shal-hmac
!
!
vpn 0
interface cellular0
ip dhcp-client
tunnel-interface
encapsulation ipsec
color lte
no allow-service bgp
allow-service dhcp
allow-service dns
allow-service icmp
no allow-service sshd
no allow-service netconf
no allow-service ntp
no allow-service ospf
no allow-service stun
allow-service https
!
mtu 1428
profile 0
technology auto
no shutdown
!
interface ge0/0
ip dhcp-client
ipv6 dhcp-client
tunnel-interface
encapsulation ipsec
no allow-service bgp
allow-service dhcp
allow-service dns
allow-service icmp
no allow-service sshd
no allow-service netconf
no allow-service ntp
no allow-service ospf
no allow-service stun
allow-service https
!
no shutdown
!
!

```



```
vpn 512
!
```

Cisco ISR1100-4G Routers, Cisco IOS XE

The following is the default configuration at start up for the following router models when ordered with Cisco IOS XE.

- Cisco ISR1100-4G
- Cisco ISR1100X-4G



Note This information is provided for convenience. Default configurations are subject to change.

```
device# show sdwan running-config
system
  admin-tech-on-failure
  !
memory free low-watermark processor 68184
call-home
  contact-email-addr sch-smart-licensing@cisco.com
  profile CiscoTAC-1
  active
  destination transport-method http
  !
!
no service tcp-small-servers
no service udp-small-servers
platform qfp utilization monitor load 80
hostname Router
username admin privilege 15 secret 0 admin
no ip finger
no ip rcmd rcp-enable
no ip rcmd rsh-enable
no ip dhcp use class
ip ssh version 2
no ip http server
ip http secure-server
ip nat settings central-policy
ip nat settings gatekeeper-size 1024
interface GigabitEthernet0/0/0
  no shutdown
  negotiation auto
exit
interface GigabitEthernet0/0/1
  no shutdown
  negotiation auto
exit
interface GigabitEthernet0/0/2
  no shutdown
  negotiation auto
exit
interface GigabitEthernet0/0/3
  no shutdown
  negotiation auto
exit
aaa authentication enable default enable
aaa authentication login default local
```

```

aaa authorization console
aaa authorization exec default local
login on-success log
line aux 0
!
line con 0
  login authentication default
  speed 115200
  stopbits 1
!
line vty 0 4
  login authentication default
!
line vty 5 80
  login authentication default
!
sdwan
  appqoe
  no tcpopt enable
  no dreopt enable
!
omp
  no shutdown
  graceful-restart
  no as-dot-notation
  address-family ipv4
    advertise connected
    advertise static
  !
  address-family ipv6
    advertise connected
    advertise static
  !
!
!
security
  ipsec
    authentication-type ah-shal-hmac shal-hmac
  !
!

```

Cisco ISR1100-6G Routers, Cisco IOS XE

The following is the default configuration at start up for the following router models when ordered with Cisco IOS XE.

- Cisco ISR1100-6G
- Cisco ISR1100X-6G



Note This information is provided for convenience. Default configurations are subject to change.

```

device# show sdwan running-config
system
  admin-tech-on-failure
!
memory free low-watermark processor 68184
call-home

```

```
contact-email-addr sch-smart-licensing@cisco.com
profile CiscoTAC-1
  active
  destination transport-method http
!
!
no service tcp-small-servers
no service udp-small-servers
platform qfp utilization monitor load 80
hostname Router
username admin privilege 15 secret 0 admin
no ip finger
no ip rcmd rcp-enable
no ip rcmd rsh-enable
no ip dhcp use class
ip ssh version 2
no ip http server
ip http secure-server
ip nat settings central-policy
ip nat settings gatekeeper-size 1024
interface GigabitEthernet0/0/0
  no shutdown
  negotiation auto
exit
interface GigabitEthernet0/0/1
  no shutdown
  negotiation auto
exit
interface GigabitEthernet0/0/2
  no shutdown
  negotiation auto
exit
interface GigabitEthernet0/0/3
  no shutdown
  negotiation auto
exit
interface GigabitEthernet0/0/4
  no shutdown
  negotiation auto
exit
interface GigabitEthernet0/0/5
  no shutdown
  negotiation auto
exit
aaa authentication enable default enable
aaa authentication login default local
aaa authorization console
aaa authorization exec default local
login on-success log
line aux 0
!
line con 0
  login authentication default
  speed 115200
  stopbits 1
!
line vty 0 4
  login authentication default
!
line vty 5 80
  login authentication default
!
sdwan
appqoe
```

```

no tcpopt enable
no dreopt enable
!
omp
no shutdown
graceful-restart
no as-dot-notation
address-family ipv4
  advertise connected
  advertise static
!
address-family ipv6
  advertise connected
  advertise static
!
!
!
security
ipsec
  authentication-type ah-shal-hmac shal-hmac
!
!

```

Cisco ISR1100-4GLTE Routers, Cisco IOS XE

The following is the default configuration at start up for the following router models when ordered with Cisco IOS XE.

- Cisco ISR1100-4GLTENA
- Cisco ISR1100-4GLTEGB



Note This information is provided for convenience. Default configurations are subject to change.

```

device# show sdwan running-config
system
  admin-tech-on-failure
!
memory free low-watermark processor 68304
call-home
  contact-email-addr sch-smart-licensing@cisco.com
  profile CiscoTAC-1
  active
  destination transport-method http
!
!
no service tcp-small-servers
no service udp-small-servers
platform qfp utilization monitor load 80
hostname Router
username admin privilege 15 secret 0 admin
controller Cellular 0/1/0
!
no ip finger
no ip rcmd rcp-enable
no ip rcmd rsh-enable
no ip dhcp use class
no ip http server

```

```
ip http secure-server
ip nat settings central-policy
ip nat settings gatekeeper-size 1024
interface GigabitEthernet0/0/0
  no shutdown
  negotiation auto
exit
interface GigabitEthernet0/0/1
  no shutdown
  negotiation auto
exit
interface GigabitEthernet0/0/2
  no shutdown
  negotiation auto
exit
interface GigabitEthernet0/0/3
  no shutdown
  negotiation auto
exit
interface Cellular0/1/0
  no shutdown
  ip address negotiated
  ipv6 enable
exit
interface Cellular0/1/1
  shutdown
  ip address negotiated
exit
aaa authentication enable default enable
aaa authentication login default local
aaa authorization console
aaa authorization exec default local
login on-success log
line aux 0
!
line con 0
  login authentication default
  stopbits 1
!
line vty 0 4
  login authentication default
!
line vty 5 80
  login authentication default
!
sdwan
  appqoe
  no tcptopt enable
!
  omp
  no shutdown
  graceful-restart
  no as-dot-notation
  address-family ipv4
  advertise connected
  advertise static
!
  address-family ipv6
  advertise connected
  advertise static
!
!
!
security
```

```
ipsec
 authentication-type ah-sha1-hmac sha1-hmac
!
!
```



CHAPTER 5

Install External Modules and FRUs

This chapter describes how to install and remove optional small-form-pluggable (SFP) modules in the router to provide optical Gigabit Ethernet connectivity. It also describes how to install antennas and a SIM card for Cisco ISR1100-4GLTE routers.

- [Safety Warnings](#), on page 43
- [Install Antennas for Cisco ISR1100-4GLTE Routers](#) , on page 43
- [Install and Remove SFP Modules](#), on page 44
- [Install the Micro SIM Card](#), on page 45

Safety Warnings



Warning

Pluggable optical modules comply with IEC 60825-1 Ed. 3 and 21 CFR 1040.10 and 1040.11 with or without exception for conformance with IEC 60825-1 Ed. 3 as described in Laser Notice No. 56, dated May 8, 2019. Statement 1255



Warning

Class 1 laser product. Statement 1008

Install Antennas for Cisco ISR1100-4GLTE Routers

Cisco ISR1100-4GLTE routers have two antenna terminals: Main and Diversity. Cisco ISR1100-4GLTE routers ship with one Omnidirectional Dipole Antenna (LTE-ANTM-SMA-D).

For information on installing the antenna provided with the router, see [Installation Instructions for Cisco 4G LTEA, 4GLTE, and 3G Omnidirectional Dipole Antenna](#).



Note

For best performance, you are recommended to install two antennas.

For information on other supported antennas, see [Antenna Selection Table](#).

For information on cables and accessories, see [Cisco RF Cables and Accessories](#)

Install and Remove SFP Modules

Install SFPs

Optical SFPs use a small laser to generate the fiber-optic signal. Keep the optical transmit and receive ports covered whenever a cable is not connected to the port.



Warning Invisible laser radiation may be emitted from the end of the unterminated fiber cable or connector. Do not view directly with optical instruments. Viewing the laser output with certain optical instruments (for example, eye loupes, magnifiers, and microscopes) within a distance of 100 mm may pose an eye hazard. Statement 1056

Fiber type and Core diameter (μm)	Wavelength (nm)	Max. Power (mW)	Beam divergence (rad)
SM 11	1200 - 1400	39 - 50	0.1 - 0.11
MM 62.5	1200 - 1400	150	0.18 NA
MM 50	1200 - 1400	135	0.17 NA
SM 11	1400 - 1600	112 - 145	0.11 - 0.13

346377

To install an SFP module in your router:

1. Read the “Safety Warnings” section , and disconnect the power supply before you replace any module.
2. Slide the SFP into the router connector until it locks into position.



Note The following image is for reference only.

Figure 17: Install an SFP Module

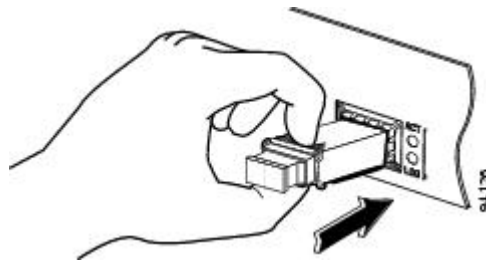

Caution Do not remove the optical port plugs from the SFP until you are ready to connect cabling.

3. Connect the network cable to the SFP module.

Remove SFP Modules

Read the “Safety Warnings” section in this chapter, and disconnect the power supply before you replace any module.

1. Disconnect all cables from the SFP module.



Caution The latching mechanism used on many SFPs locks the SFP into place when cables are connected. Do not pull at the cabling in an attempt to remove the SFP.

2. Disconnect the SFP latch.



Note SFP modules use various latch designs to secure the module in the SFP port. Latch designs are not linked to SFP models or technology type. For information on the SFP technology type and model, see the label on the side of the SFP.

Figure 18: Latch Mechanisms for Disconnecting SFP Modules

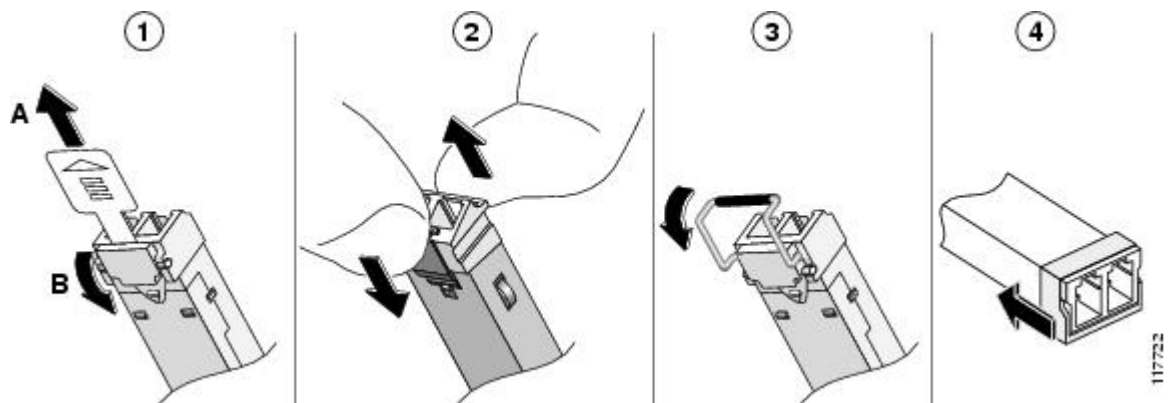

- 1: Sliding latch
- 2: Swing and slide latch
- 3: Bale-clasp latch
- 4: Plastic collar latch

3. Grasp the SFP on both sides and remove it from the router.

Install the Micro SIM Card

This section describes how to install and replace the SIM card on router models that use a SIM.



Note Do not touch any part of the exposed PCB circuit area when the SIM cover is removed.

