



Removing and Replacing Chassis Components

This chapter provides instructions on how to remove and replace components from the Cisco NCS 4000 FCC.

- [Removing the Power Components, on page 1](#)
- [Removing an Impedance Carrier, on page 4](#)
- [Removing the Chassis Door, on page 5](#)
- [Attaching the Front Door, on page 5](#)
- [Replacing the Fan Trays and Air Filter, on page 9](#)

Removing the Power Components

This section describes how to remove power components from the Cisco NCS 4000 FCC.

While it is possible to remove power components from the Cisco NCS 4000 FCC separately, some parts (such as the power tray) require that other parts be removed first.

We recommend that you remove the power components in the order outlined in this section.

Removing DC Input Power Cables

This section describes how to remove DC input power cables from a power tray terminal block.

Prerequisites

Power off the DC power modules in the tray you want to disconnect.



Note Before removal, make sure that the input power cables are not energized.

Required Tools and Equipment

- ESD-preventive wrist strap
- 6-inch, number-1 Phillips screwdriver
- 3/8-inch ratchet wrench with 7/16-pt. socket
- Voltmeter

To disconnect DC input power cables, follow these steps:

Procedure

- Step 1** Attach the ESD-preventive wrist strap to your wrist and connect its leash to one of the two ESD jacks on the chassis. You can also connect the ESD-preventive wrist strap leash to any bare metal surface on the chassis.
 - Step 2** Using the voltmeter, verify that there is no voltage on the cables that are about to be removed.
 - Step 3** Use the screwdriver to remove the screw that secures the terminal block cover into the mounting standoff.
 - Step 4** Slide the terminal block cover downward.
 - Step 5** Remove the terminal block cover.
 - Step 6** Disconnect the DC power cables from their terminals in the following order and note the color of each cable:
 - a) Negative (PWR) cables first.
 - b) Positive (RTN) cables last.
 - Step 7** Replace the terminal block cover.
-

Removing a Power Module Slot Cover

This section describes how to remove a power module slot cover from a power module slot in a DC power tray.

To remove a power module slot cover from the front of a power tray, follow these steps:

Procedure

- Step 1** Gently pinch the tabs on the top of the power module slot cover to partially detach the slot cover from the slot.
 - Step 2** Slide the power module slot cover out by removing the tabs on the bottom of the power module slot cover from the two holes on the bottom of the slot.
-

Removing DC Power Module

This section describes how to remove a power module from a power tray.



Note It is not necessary to turn off the switch on the power tray to remove individual power modules. Power modules support OIR, so they can be removed and replaced with the power on and the system operating.

To remove a power module from the front of a power tray, follow these steps:

Procedure

- Step 1** Release the snap hook on the power module.

- Step 2** Slide the power module out of its bay in the power tray while supporting it with your other hand. Use the handle available on the front plate of the power module.
-

Replacing a Power Module

The following section describes how to replace a power module in a NCS 4000 FCC.

Following are the limitations when a Delta power module (DC power) is replaced with an ACBEL power module (DC power).

- Release 6.5.25 and 6.5.26 software packages come with ACBEL PEM FPD image with version 4.02. Post upgrade, the state of ACBEL PSU FPD is shown as NOT READY but the power module will function normally.

Follow these steps to replace DC power modules for a chassis:

Procedure

- Step 1** Using two hands to support the power module, slide it into the power tray.
- Step 2** Secure the power module into the power tray using the snap hook.
-

Removing the Chassis Ground Cable

This section describes how to remove the chassis ground cable on the Cisco NCS 4000 FCC.

Prerequisites

Before performing this task, completely power off the entire system. Remove all DC input power connections.



Caution Do not remove the chassis ground cable unless the chassis is powered off and to be replaced.

Required Tools and Equipment

- 3/8-inch drive socket wrench
- 10-mm 6-pt. socket

Procedure

To remove the ground cable from the chassis, remove the two M6 bolts that attach the ground cable to the NEBS grounding point.

Removing an Impedance Carrier

This section describes how to remove a fabric card or RPMC card impedance carrier from the Cisco NCS 4000 FCC.



Caution The FCC ships with impedance carriers preinstalled in all the slots.

The eight fabric card slots are populated with a fabric card at all times, except when a replacement is required.

Figure 1: FC Impedance Carrier

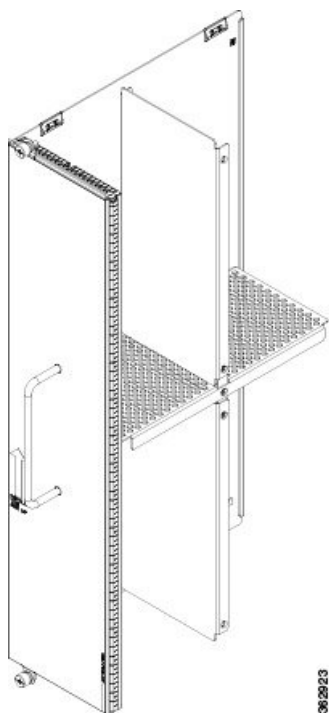
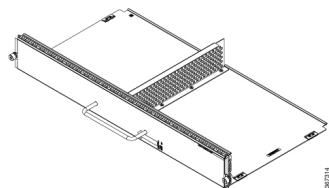

Figure 2: RPMC Card Impedance Carrier



Prerequisites

Before performing this task, open the door, if installed.

Required Tools and Equipment

- Number-2 Phillips screwdriver or number-2 common (flat-head) screwdriver

To remove an impedance carrier from the FCC, follow these steps:

Procedure

- Step 1** Identify the impedance carrier to be removed from the card cage.
 - Step 2** Use the number-2 Phillips screwdriver or number-2 common (flat-head) screwdriver to turn the two captive screws on the front panel of the card counterclockwise to loosen it from the slot.
 - Step 3** Grasp the impedance carrier handle with one hand and gently pull it halfway from the slot. Place one hand under the impedance carrier to guide it.
 - Step 4** Hold the impedance carrier underneath and by the handle, pull it from the slot, and set it carefully aside.
-

Removing the Chassis Door

This section describes how to remove the chassis door.

Required Tools and Equipment

- ESD-preventive wrist strap
- Number 2 Phillips screwdriver, medium and small slot-head screwdrivers

To remove the front door of the chassis, follow these steps.

Procedure

- Step 1** Turn the knob to unlock the door.
 - Step 2** Open the door.
 - Step 3** Loosen the screw to disconnect the ground cable.
 - Step 4** Move the door up to release from the hinge pins.
-

Attaching the Front Door

This section describes how to attach the front door.

Required Tools and Equipment

- ESD-preventive wrist strap
- Number 2 Phillips screwdriver, medium and small slot-head screwdrivers
- Front door (Cisco PID NCS4KF-DOOR(=))



Note For ease of installation, it is recommended to stand in front of the chassis while assembling the door.

To attach the front door of the chassis, follow these steps.

Procedure

Step 1 Lift the door up and align the three door hinges to the hinge pins available on the chassis.

Figure 3: Aligning the Door Hinges

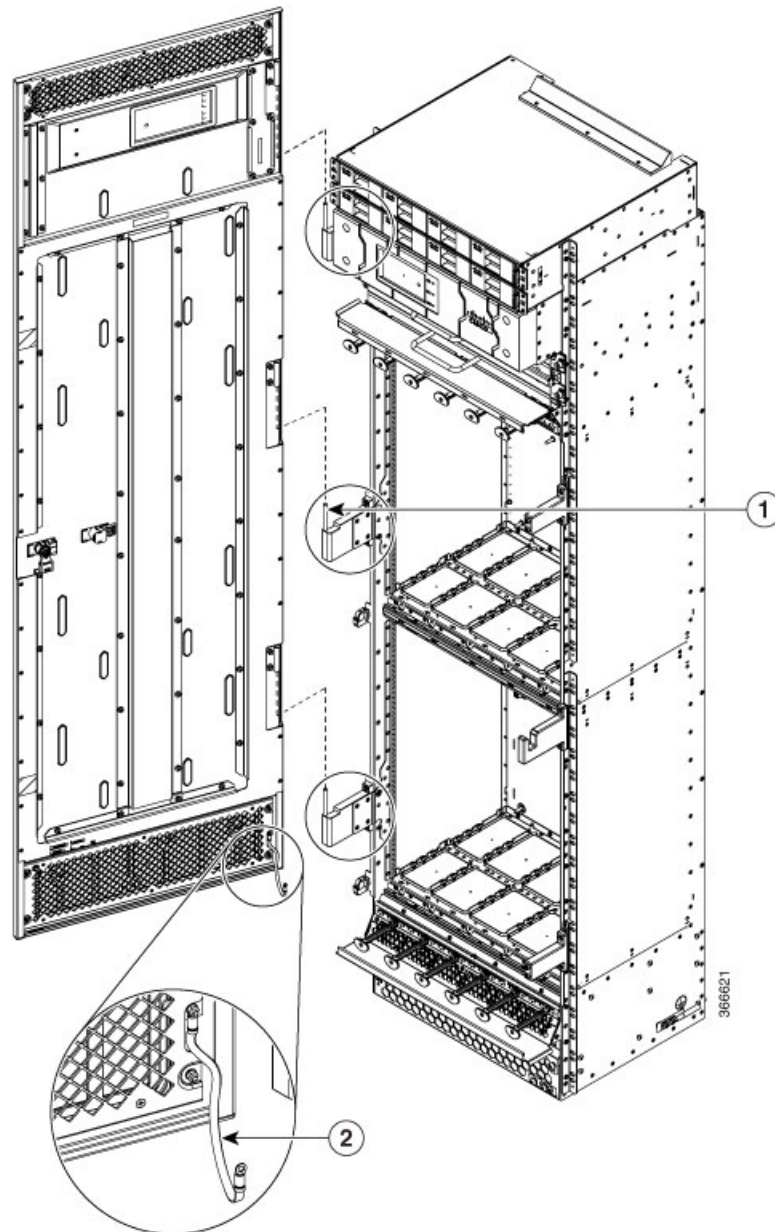

1	Hinge pins	2	Ground strap cable
---	------------	---	--------------------

- Step 2** Lower the door.
- Step 3** To attach the ground cable, loosen the screw from the chassis fixing point.
- Step 4** Feed the screw through the ground cable ring lug, through the washer, and then into the machined block.
- Step 5** Using a Phillips screwdriver, insert and tighten the screw using a torque of 6 in-lb.
- The following figure shows the shelf assembly with the front door and ground strap installed.

Figure 4: FCC with Door Ground Strap Installed

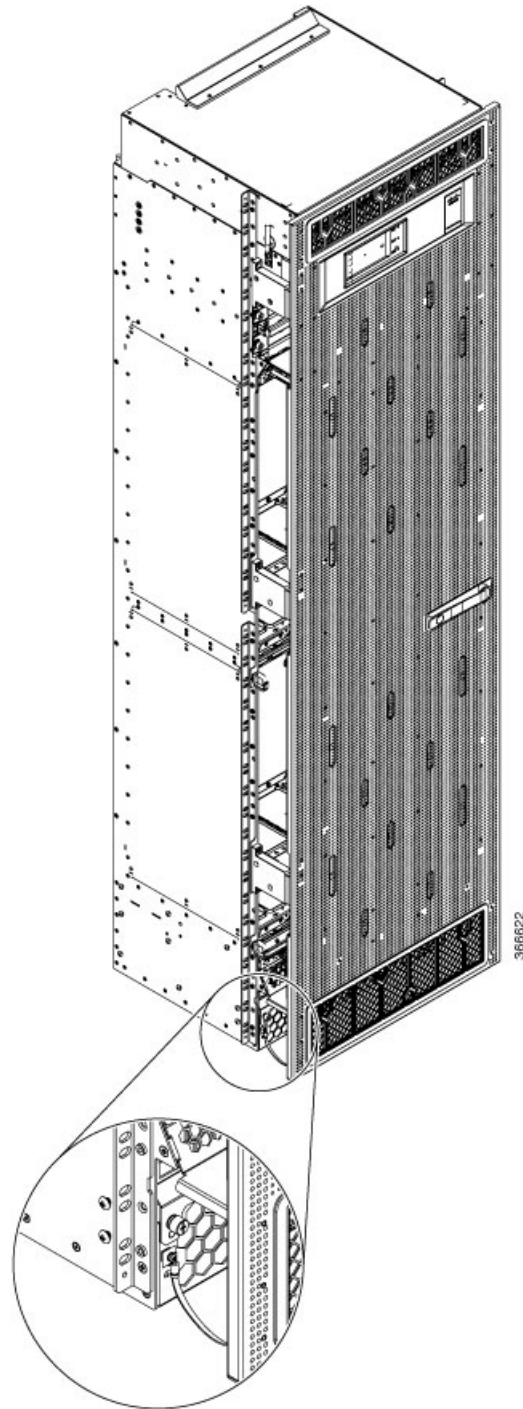

Replacing the Fan Trays and Air Filter

This section describes how to replace a fan tray and air filter from the Cisco NCS 4000 FCC and includes the following topics:



Note The NCS 4000 FCC is shipped with the air filter preinstalled.

About the Fan Trays and Air Filter

This section provides an overview of the fan trays and air filter for the Cisco NCS 4000 FCC. These components help circulate and filter the airflow throughout the FCC.

The airflow volumes for a fully loaded Cisco NCS 4000 FCC are as follows:

- Chassis airflow: Up to 1250 cubic feet per minute
- DC power system airflow: 240 cubic feet per minute

About the Fan Trays

The Cisco NCS 4000 FCC has two fan trays that are adjacent to each other and located directly above the upper cable management bracket on the front of the FCC. Each fan tray has six axial fans. The fans pull the heated air from the system and throw it out through the rear of the chassis. Both the fan trays must be present in the chassis at all times.

When there is one or more fan failures, the system monitors the temperature sensors mounted on the critical components within the various boards and increases fan speed to hold temperatures below their critical threshold. The system does this monitoring even when all the fans are operating correctly (so that it protects the components if the air intake is blocked for example). If temperatures exceed the critical threshold, the associated cards are shut down to avoid permanent damage.

If either fan tray is removed from the FCC, the other fan tray will immediately spin up to maximum speed to provide sufficient cooling performance. Although the system can operate indefinitely at full capacity with just one operational fan tray up to an ambient room temperature of 40°C (104°F) without overheating, there is no longer any redundancy offered, so immediate replacement of the missing fan tray is advised.

When both fan trays are removed, a critical alarm is generated, along with a syslog message warning you to install a fan tray or the entire FCC will shut down in 45 seconds.



Note The upper and lower fan trays are interchangeable so the fan tray installation is the same.

Fan Tray LEDs

The green/yellow LED lights when the fan tray is inserted into the fan tray slot. The following table describes the fan tray LEDs and their meanings.

Table 1: NCS 6000 FCC Fan Tray LEDs

LED Color	Description
Green	The fan tray is operating normally.
Yellow	The fan tray has one or more errors detected.
Off	No power is applied to the fan tray.

About the Air Filter

The Cisco NCS 4000 FCC has a serviceable air filter mounted in a slide-out tray accessible from the front of the FCC just below the lower cable management bracket. The air filter removes dust from the room air drawn into the FCC by the two fan trays. Once a month (or more often in dusty environments), you should examine the air filter. Replace it if it appears excessively dirty or damaged.

Failure to replace a compromised air filter can result in insufficient air circulation through the FCC and temperature-related environmental alarms.



Note To comply with Telecordia GR-63-Core standard air filter requirements for NEBS deployments, the air filter must be replaced, not cleaned.

Replacing the Fan Tray

This section describes how to replace a fan tray.

Required Tools and Equipment

- ESD-preventive wrist strap
- 6-inch, Number-1 Phillips screwdriver
- Fan tray (Cisco PID NCS4KF-FTA=)

To replace a fan tray, follow these steps:

Procedure

- Step 1** Attach the ESD-preventive wrist strap to your wrist and connect its leash to the ESD jack on the FCC. You can also connect the ESD-preventive wrist strap leash to any bare metal surface on the FCC.
- Step 2** Using the screwdriver, loosen the two captive screws on the fan tray faceplate.
- Step 3** Pull firmly on the fan tray handle to pull it free.
- Step 4** Grasp the fan tray handle and pull it straight out to disconnect the fan tray from the connector mounted on the front of the fan tray bay on the rear side of the FCC. Slide the fan tray halfway from the fan tray bay.
- Step 5** Use your free hands to support the fan tray, and then slide the fan tray completely from the fan tray bay.
- Step 6** To install the replacement fan tray, use both hands to support and position the fan tray in front of the fan tray bay (the labels are located on the bottom of the fan tray).

Figure 5: Replacing a Fan Tray

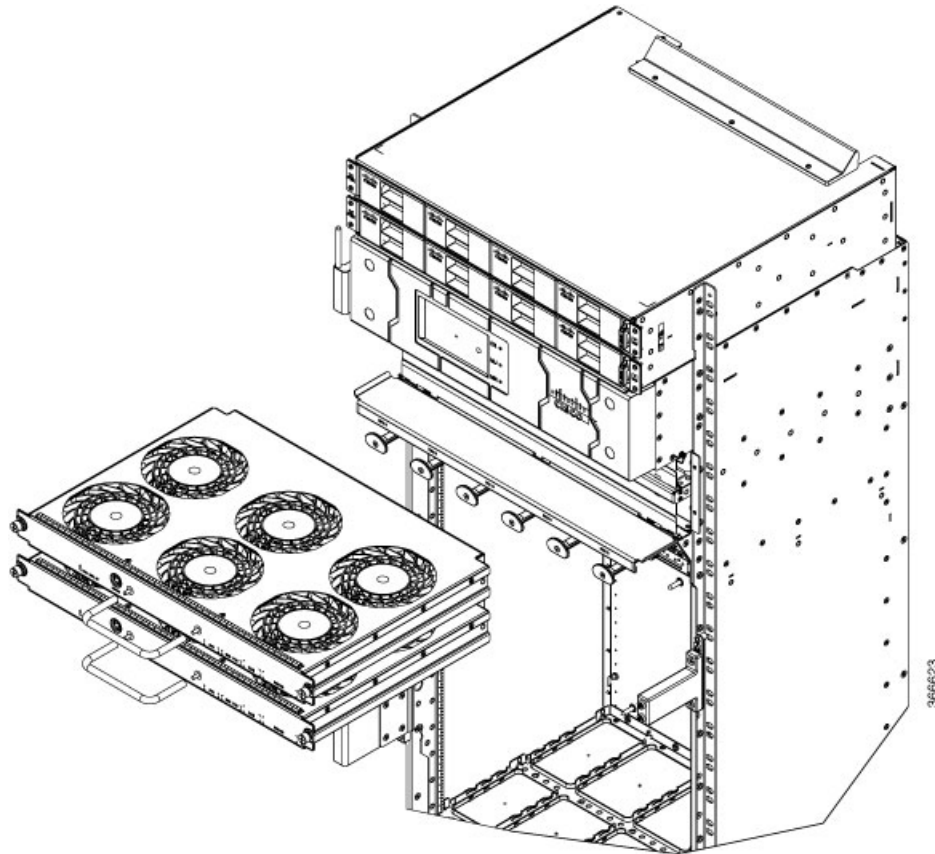

- Step 7** Slide the fan tray into the fan tray bay. Stop when the fan tray makes contact with the FCC connector in the back of the fan tray bay.
- Caution** To prevent damage to the FCC connector, do not use excessive force when inserting a fan tray into its bay.
- Step 8** Firmly push on the fan tray handle to seat the fan tray connector in the FCC connector. When the fan tray is completely seated, the fan tray faceplate flanges meet the rear side of the FCC.
- Note** All electrical and control line connections are made automatically when the connectors mate. The LED will light when the fan tray is inserted. The LED is yellow initially, until the system has confirmed it is functioning correctly.
- Step 9** Tighten the captive screws on each side of the fan tray faceplate using a torque of 10 in-lb.

Replacing the Air Filter

This section describes how to install an air filter in the Cisco NCS 4000 FC. The following figure shows the FCC air filter. The air filter is located on the front of the FCC.



Note We recommend that you change the air filter every three months.

Figure 6: FCC Air Filter

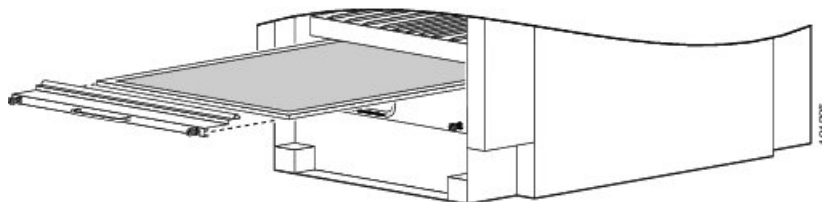

Note A lattice of wire exists on both sides of the filter material with an arrow denoting airflow direction and a pair of sheet metal straps on the downstream side of the filter assembly.



Caution Never operate the FCC without an air filter. Operating the FCC without a filter for an extended time can result in damage to the FCC hardware.

Required Tools and Equipment

- ESD-preventive wrist strap
- 6-inch, Number-1 Phillips screwdriver
- Air filter

To replace the air filter, follow these steps:

Procedure

Step 1

Remove the filter you are replacing.

- a) Loosen the two captive screws on the filter cover. The filter will automatically drop down.
- b) Pull outward on the center of the filter door to pull it free.
- c) Grasp the pull tab in the center of the air filter, and slide it out from the slot.

Figure 7: Replacing the Air Filter—Front Side of the FCC

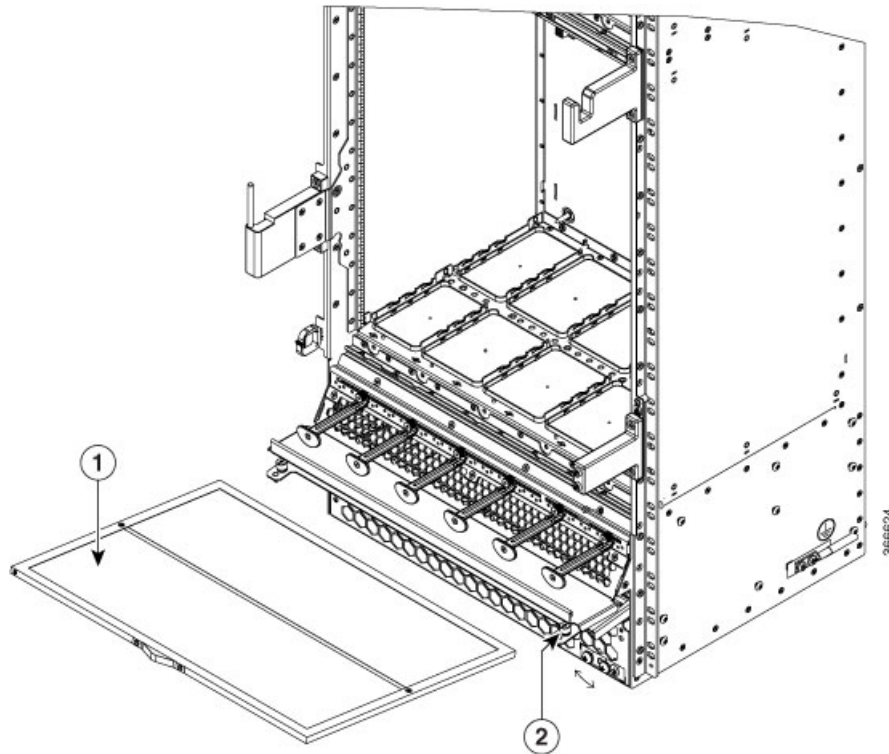

1	Air Filter	2	Captive screw
---	------------	---	---------------

Step 2 Install the replacement air filter.

Note Verify air flow direction when installing the new air filter. An air flow direction arrow is stamped on the air filter frame and should be installed pointing up.

- a) Slide the new air filter into the slot.
- b) Swing up and push in the filter cover.
- c) Tighten the two captive screws on the front of the filter cover using a torque of 10in-lb.

