



Installing the Cisco ASR 920 Series Router

This chapter describes how to install the Cisco ASR 920 Series Router and includes the following sections:

- [Prerequisites, on page 1](#)
- [Installing the Router in a Rack, on page 1](#)
- [Wall Mounting the Router, on page 8](#)
- [Install the AC Power Cables, on page 11](#)
- [Install the DC Power Supply, on page 13](#)
- [Connect SFP Modules, on page 16](#)
- [Connect Gigabit Ethernet Ports, on page 19](#)
- [Install the Chassis Ground Connection, on page 21](#)
- [Power Connection Guidelines, on page 23](#)
- [Connect Chassis to Network, on page 25](#)

Prerequisites

Before installing the Cisco ASR 920 Series Router, it is important to prepare for the installation by:

- Preparing the site (site planning) and reviewing the installation plans or method of procedures (MOP). See “Site Planning” section on page 2-9 .
- Unpacking and inspecting the Cisco ASR 920 Series Router. See “Receiving the Cisco ASR 920 Series Router” section on page 2-20 .
- Gathering the tools and test equipment required to properly install the Cisco ASR 920 Series Router. See “Tools and Equipment” section on page 2-21 .

For more instructions on how to prepare for the installation of the Cisco ASR 920 Series Router, see Chapter 2, “Preparing for Installation.”

Installing the Router in a Rack

The following sections describe how to install the Cisco ASR 920 Series Router in a rack. The procedures in this section apply to both horizontal and vertical mounting of the router in a rack:

Installing the Chassis Brackets

The chassis is shipped with mounting brackets that can be installed on the front or rear of the chassis. To install the brackets on the front of the chassis, perform these steps:

Procedure

Step 1 Remove the rack-mount brackets from the accessory kit and position them beside the router chassis.

The figure below shows how to attach the brackets at the front, middle, and rear positions on the Cisco ASR 920 Series Router for a 19-inch EIA rack.

Figure 1: Attaching Mounting Brackets for a 19-inch EIA Rack (Front, Middle, and Rear Positions)

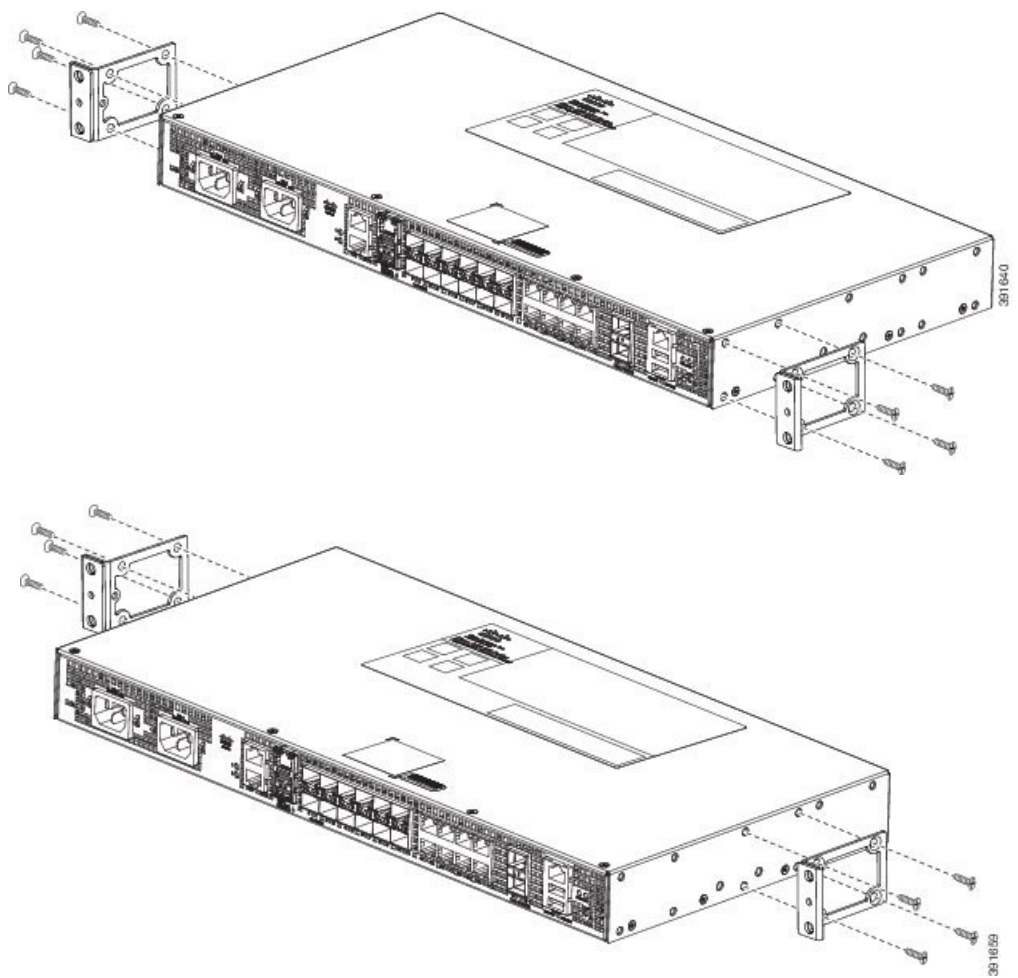

Figure 2: Shows how to attach the brackets on the Cisco ASR 920 Series Router for a 23-inch cabinet.

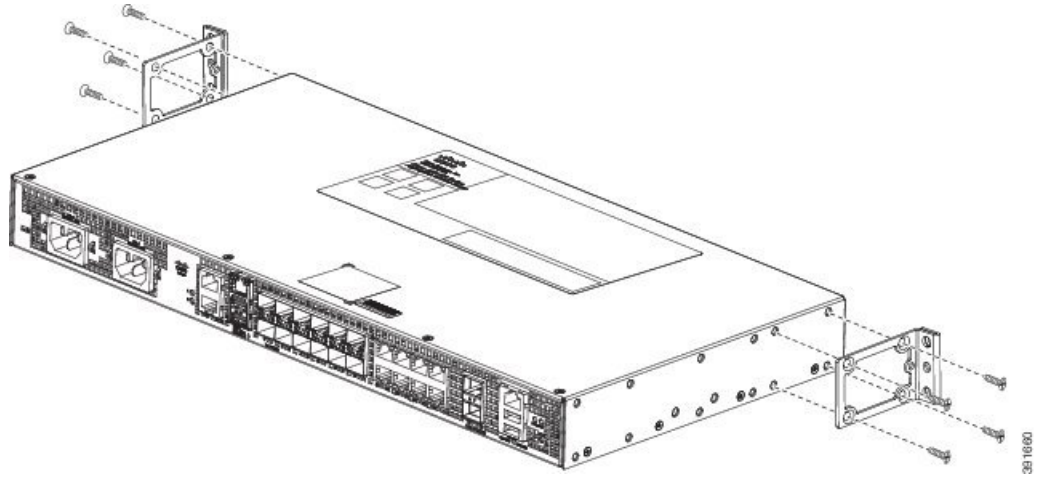
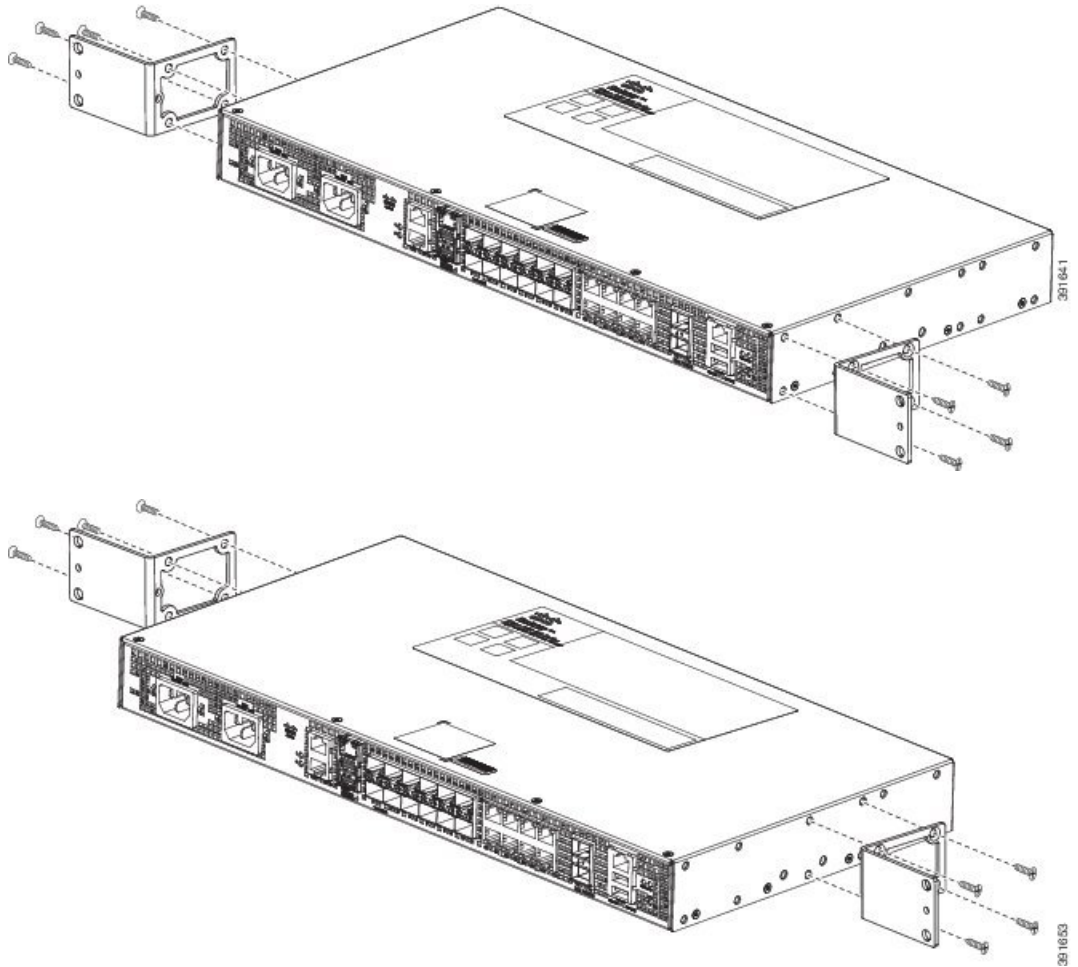

Figure 3: Attaching Mounting Brackets for a 23-inch Cabinet (Front, Middle, and Rear Positions)



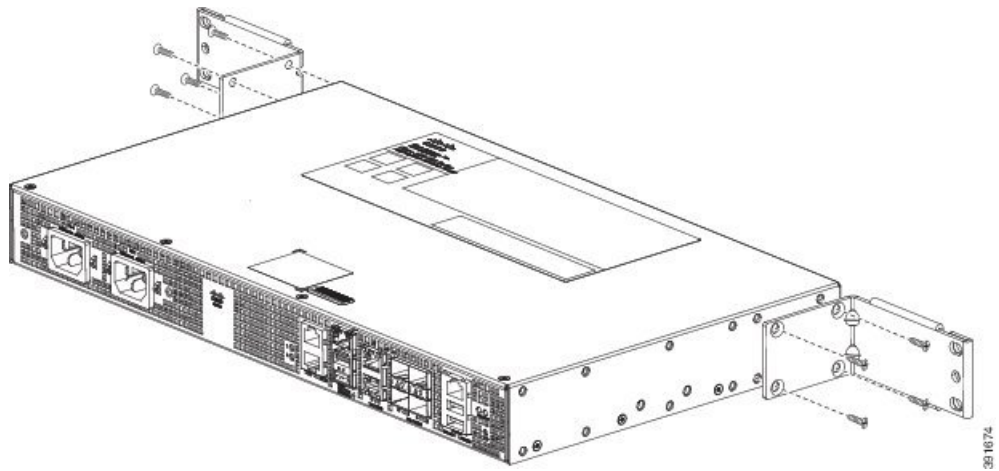
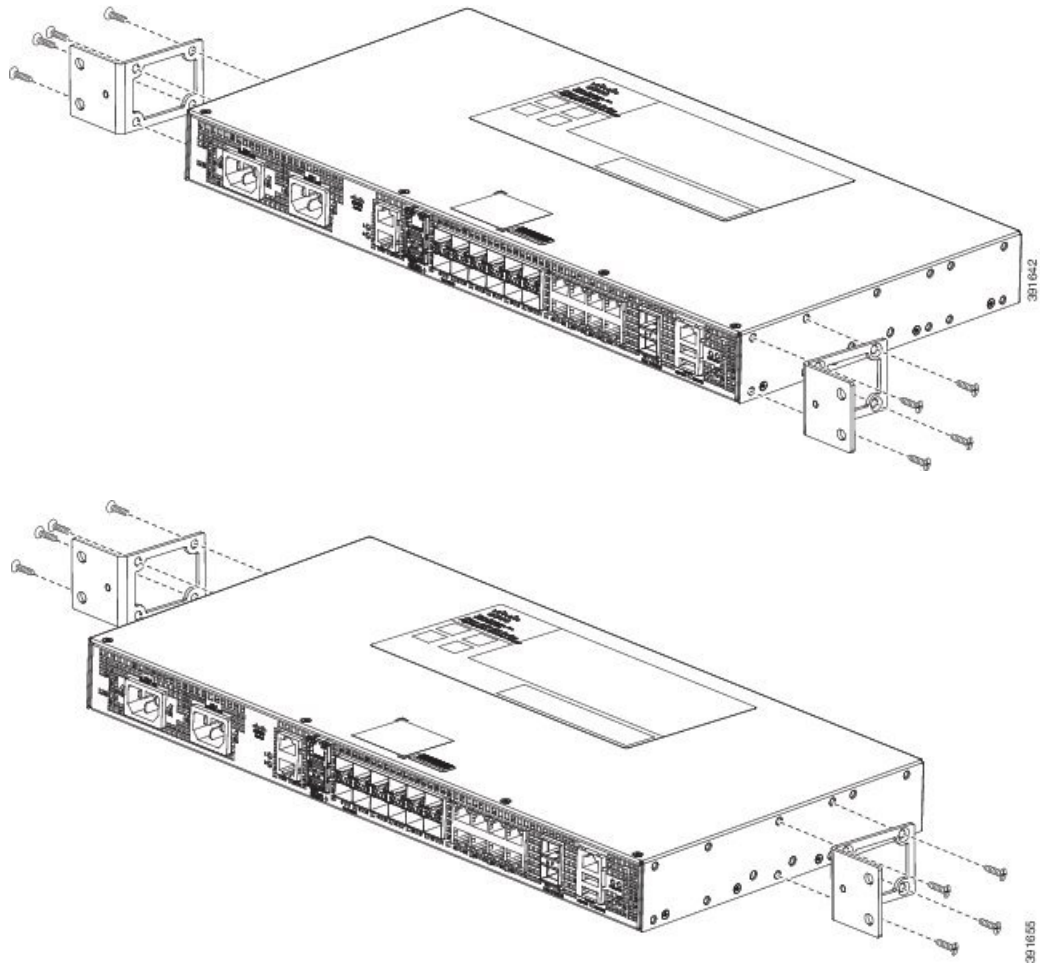
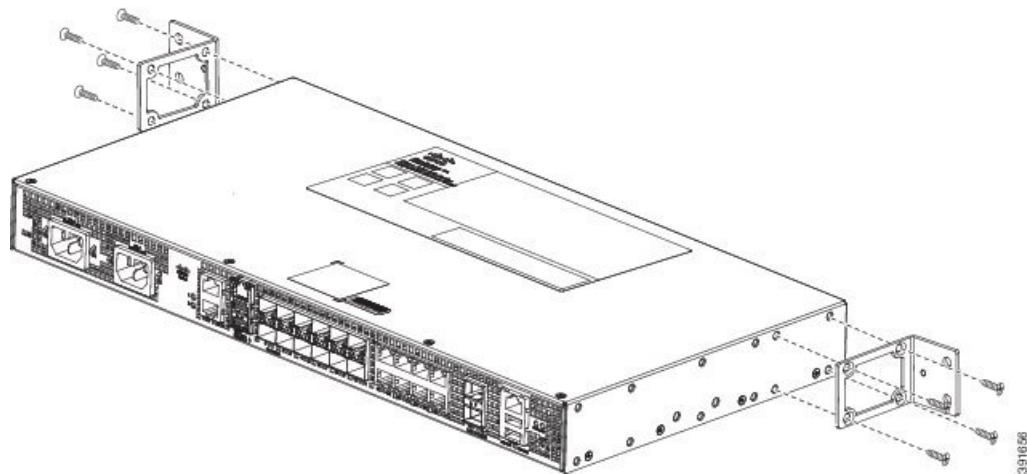

Figure 4: Attaching Mounting Brackets for a 300 mm ETSI Cabinet (Front, Middle, and Rear Positions)





- Step 2** Position one of the brackets against the chassis side, and align the screw holes.
- Step 3** Secure the bracket to the chassis with the screws removed when performing Step 1 . The recommended maximum torque is 10 in.-lb.
- Step 4** Repeat Step 2 and Step 3 for the other bracket.

Installing the Router Chassis in the Rack



Note Ensure adequate air flow when mounting the router in a rack. For more information, see the “Air Flow Guidelines” section on page 11 .



Note Install the cable guides before installing the router in a 19-inch EIA rack. See [Attaching the Cable Guides](#).

To install the router chassis in the equipment rack, perform these steps:

Procedure

- Step 1** Position the chassis in the rack as follows:
- If the front of the chassis (front panel) is at the front of the rack, insert the rear of the chassis between the mounting posts.
 - If the rear of the chassis is at the front of the rack, insert the front of the chassis between the mounting posts.
- Step 2** Align the mounting holes in the bracket (and optional cable guide) with the mounting holes in the equipment rack.

The following figure shows how to install the Cisco ASR 920 Series Router in a 19-inch EIA rack.

Figure 5: Installing the Chassis in a 19-inch EIA Rack

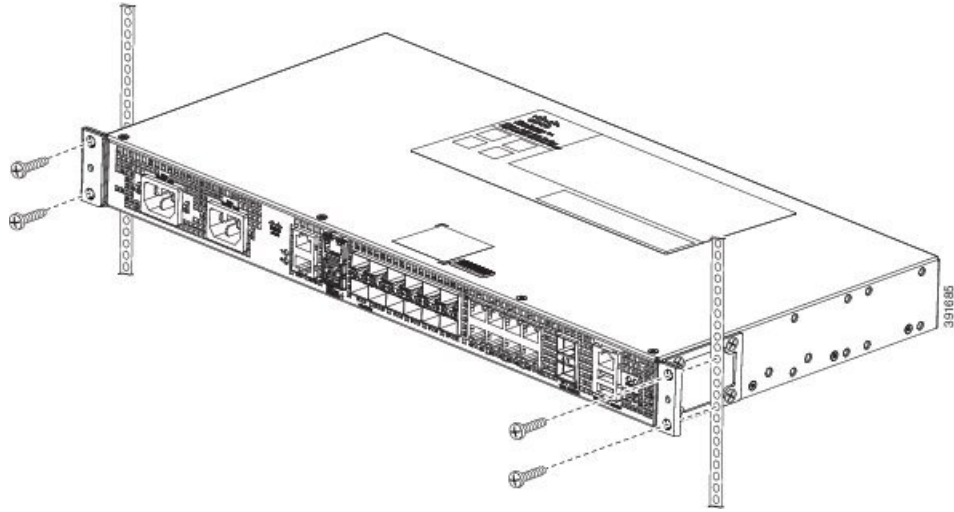

- Step 3** Install the four M6x12mm zinc-plated steel screws through the holes in the bracket and into the threaded holes in the equipment rack posts.
- Step 4** Use a tape measure and level to verify that the chassis is installed straight and level.

Attaching the Cable Guides

The Cisco ASR 920 Series Router supports the following cable guides:

- A920-CBL-GUIDE (left and right)—help in routing the cables from all components on the front panel thereby enabling a proper cable-bending radius.



Note If the chassis is mounted using 19-inch brackets, you must assemble the cable guides before installing the chassis on the rack.

To install the cable guides, perform these steps:

Procedure

- Step 1** Position the cable guide-left and cable guide-right against the front of the chassis and align the four screw holes, as shown in the figure below.

Figure 6: Cable Guide Installation For 19-inch Rack Brackets

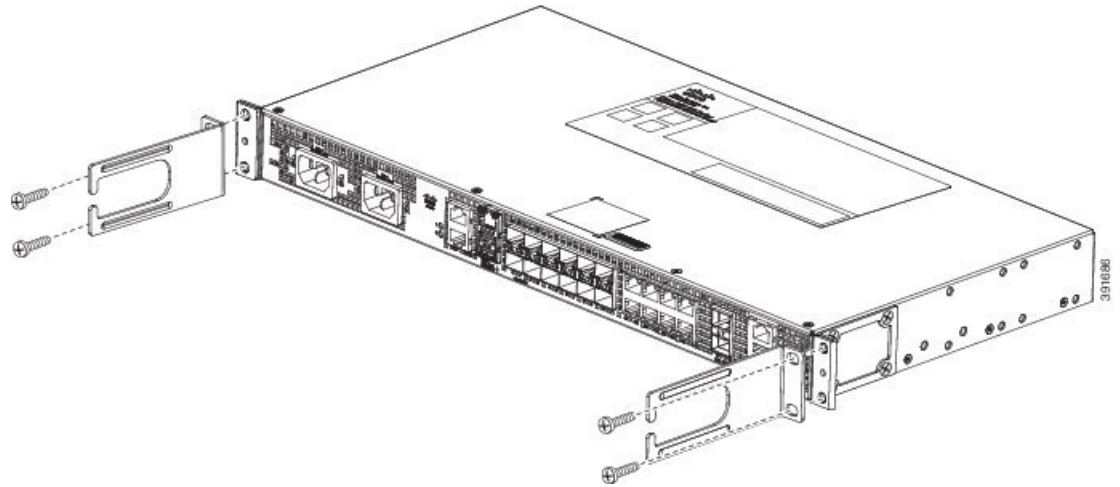
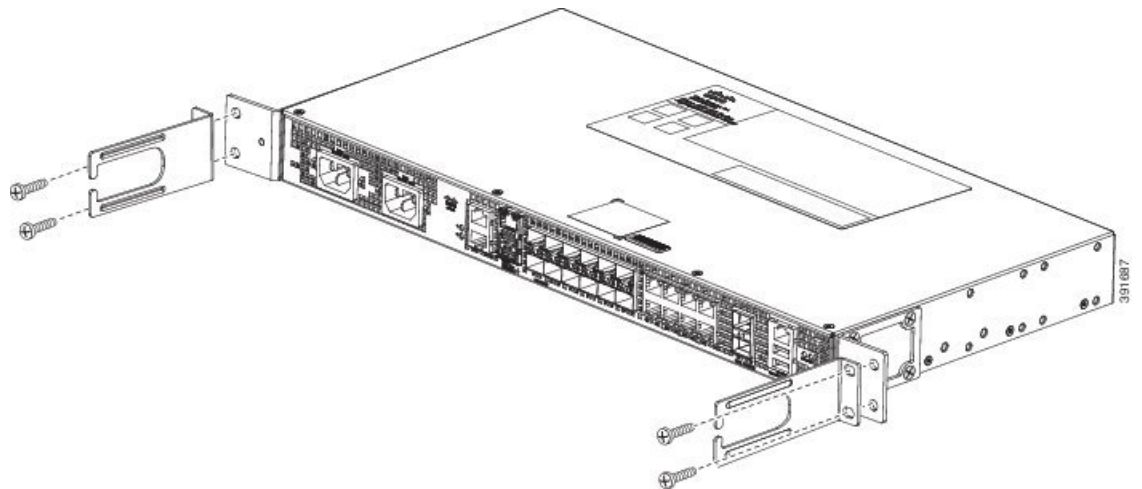
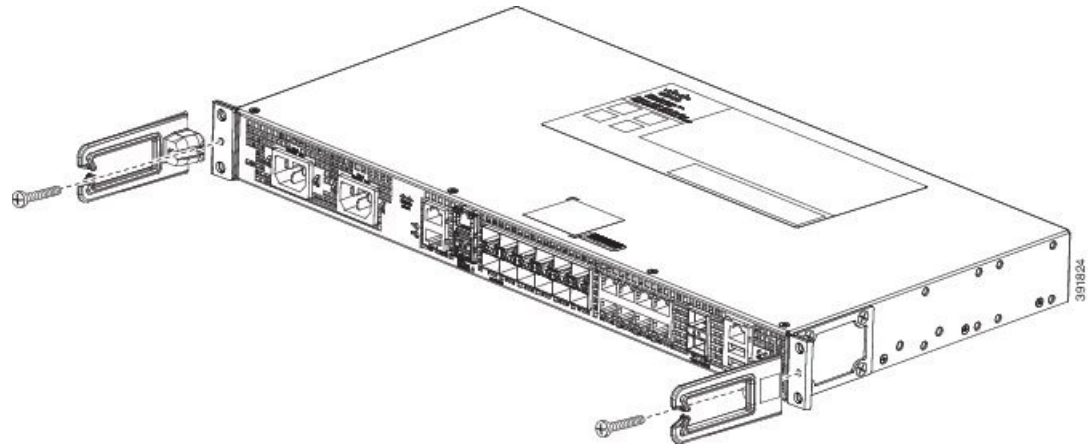

Figure 7: Cable Guide Installation For ETSI Rack Brackets



- Step 2** Secure the cable guides with the four M6x12mm screws supplied with the cable kit. The recommended maximum torque is 3N-m.

Figure 8: Installing the Cable Guides (As Per the Standard Kit)



Wall Mounting the Router

To install the router on a wall, follow the instructions in these procedures:

Attaching the Brackets to the Router for Wall-Mounting



Note While wall mounting the router, always ensure that the power supplies are at the top position.

The figure below shows how to attach a 19-inch bracket to one side of the router. Follow the same steps to attach the second bracket to the opposite side.

Figure 9: Attaching 19-inch Brackets for Wall Mounting

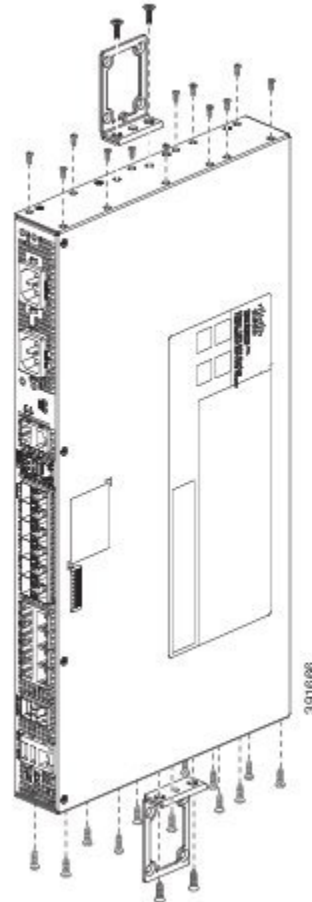

Mounting the Router on the Wall

For the best support of the router and cables, ensure the router is attached securely to wall studs or to a firmly attached plywood mounting backboard.



Warning Suitable for mounting on and over a concrete or other non-combustible surface only. Statement 345



Caution Before mounting the router, ensure that all unused holes at the sides of the router are always protected by screws.

Figure 10: Installing Screws in Unused Holes Before Wall Mounting the Router

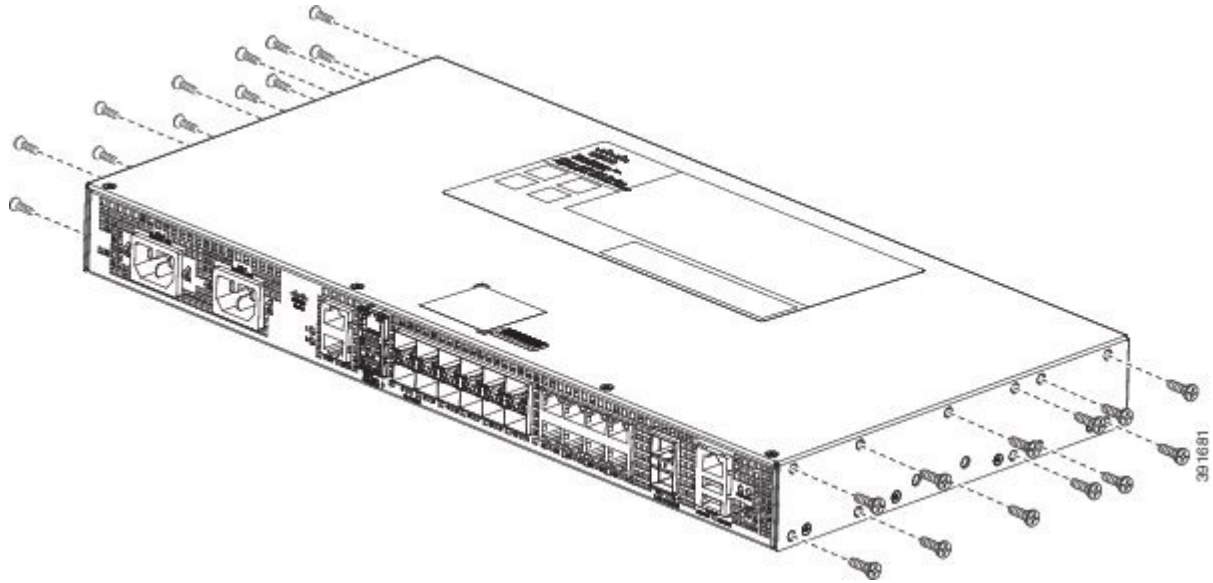

Mount the router with the front panel as shown in the following figure.

Figure 11: Mounting the Router on the Wall

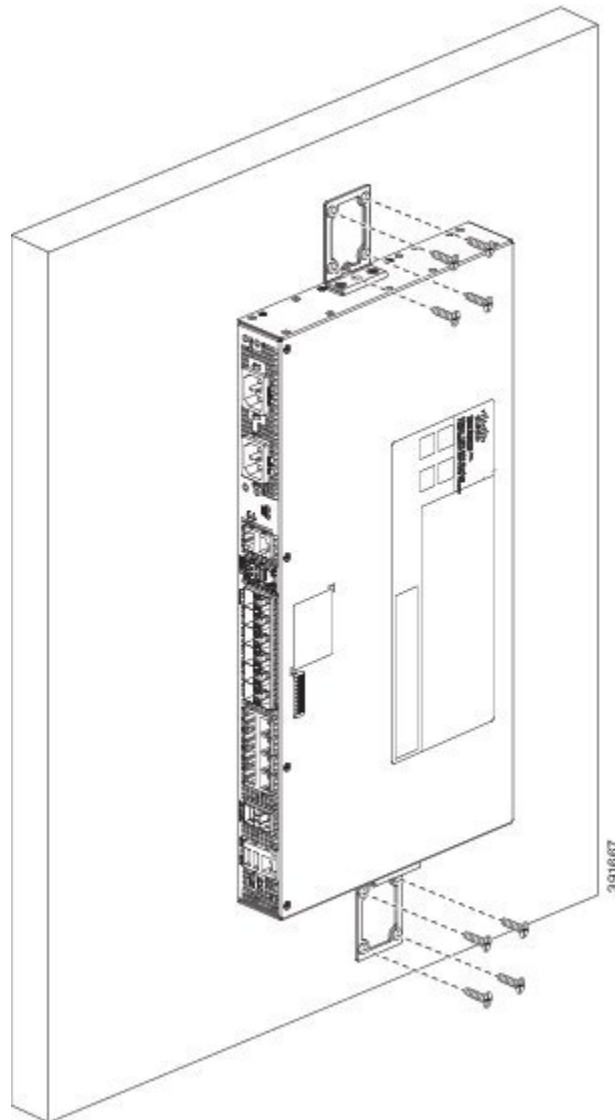

Caution When mounting the router vertically, ensure that the power supplies are at the top.

Install the AC Power Cables

To install the AC power cables in the power supply slots:



Note Ensure that the power cords are always secured with the help of a cable guide to avoid a cable overhang or any strain on the connector.

Procedure

Step 1 Attach the AC power retainer chord as shown in the figure below.

Figure 12: Attaching the AC Power Retainer Chord

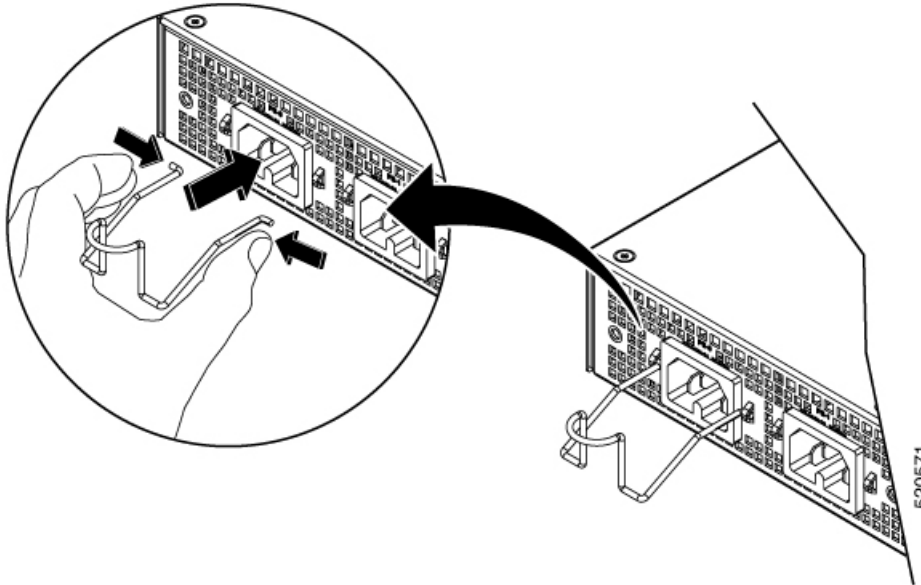

Step 2 Lift the power retainer and plug in the AC power supply.

Step 3 Push the retainer clip towards the power cord until it rests on the boot, this ensures accidental removal or drop-off of the power cord.

Figure 13: Locking the Power Retainer Chord

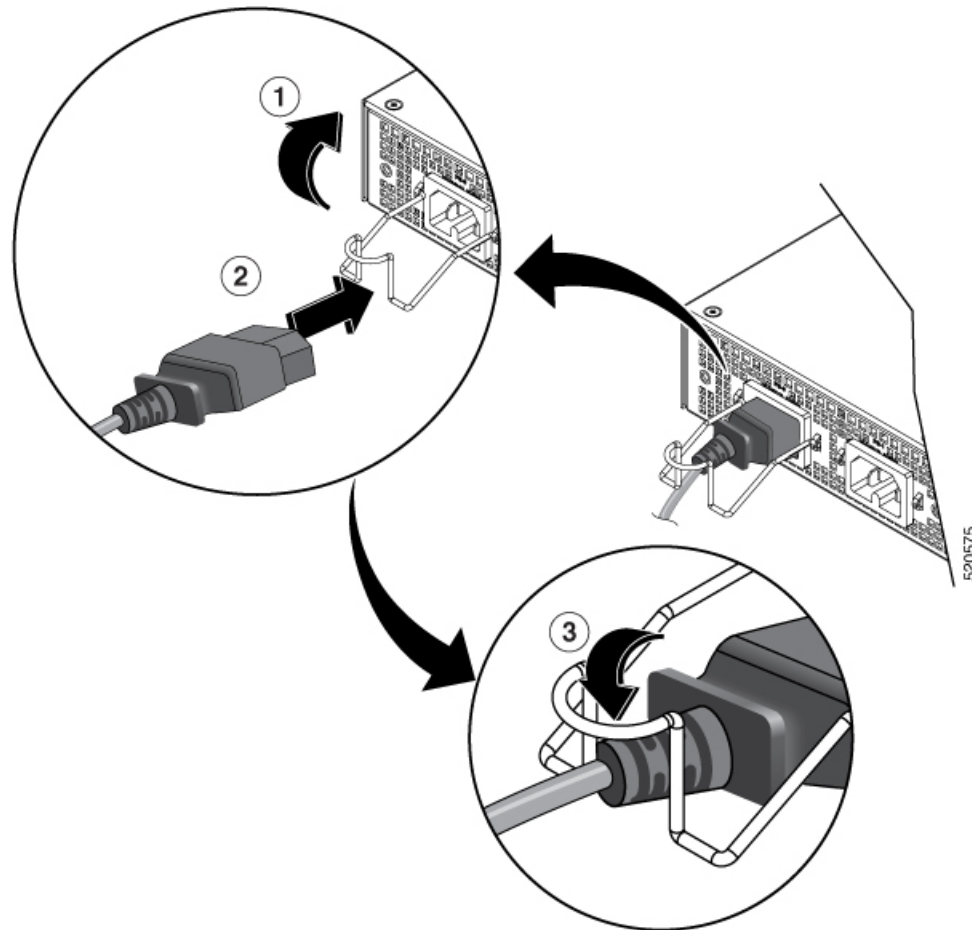

- Step 4** Connect the other end of the power cord to an AC-input power source.
- Step 5** Verify power supply operation by checking that the power supply LED is green.

Install the DC Power Supply



Note When installing DC power supply, use 14 AWG, 90°C wires. Always ensure that the building's installation for short-circuit (overcurrent) protection does not exceed 15A.



Note The DC connector or terminal block has an inbuilt screw and cage nut to which a torque of 1.3 to 1.8 N-m can be applied.

Figure 14: DC Connector With Inbuilt Screw

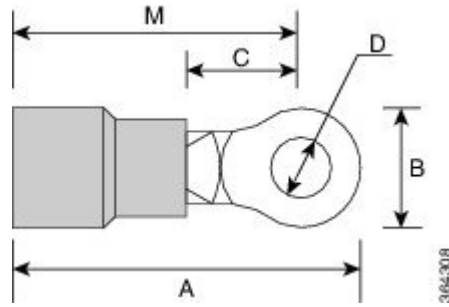

A	0.97 inches	C	0.27 inches
B	0.31 inches	M	0.81 inches

To attach the DC power supplies:

Procedure

-
- Step 1** Open the DC power supply guard.
- Step 2** Attach the DC supply wires in the designated screws. See the figure below.

Figure 15: Using the DC Power Supply Guard

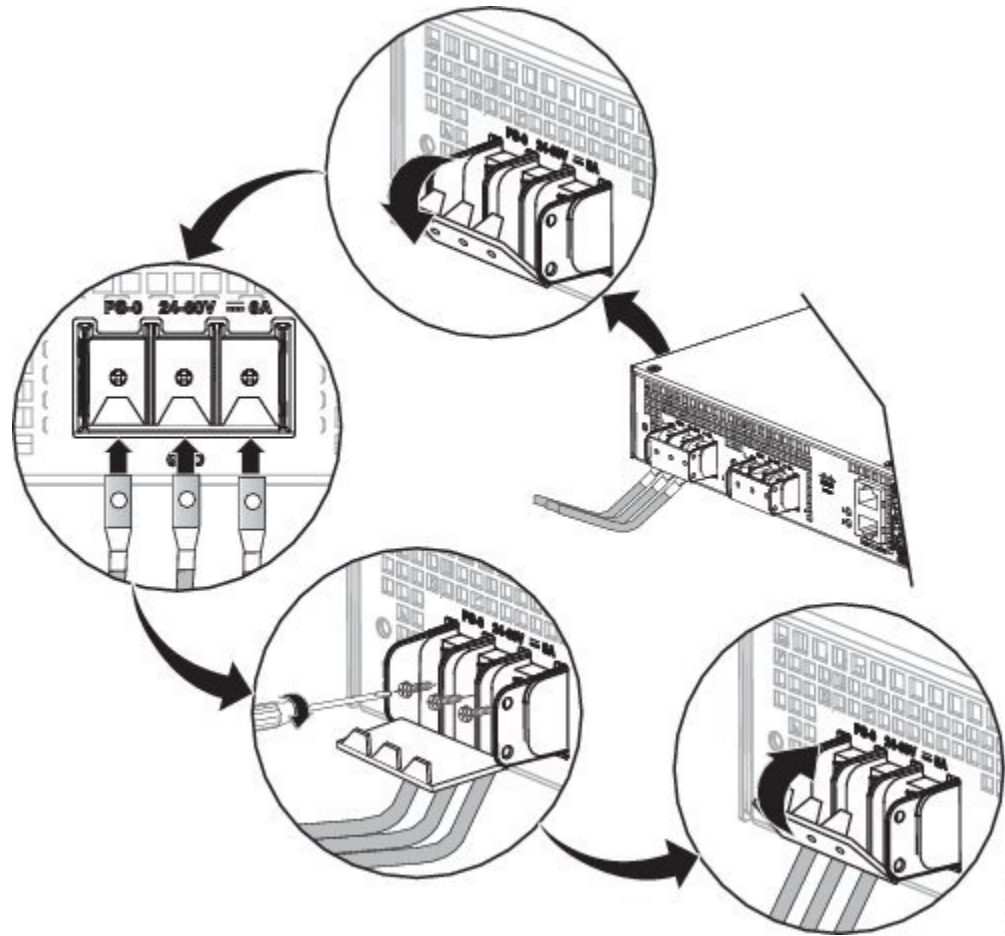
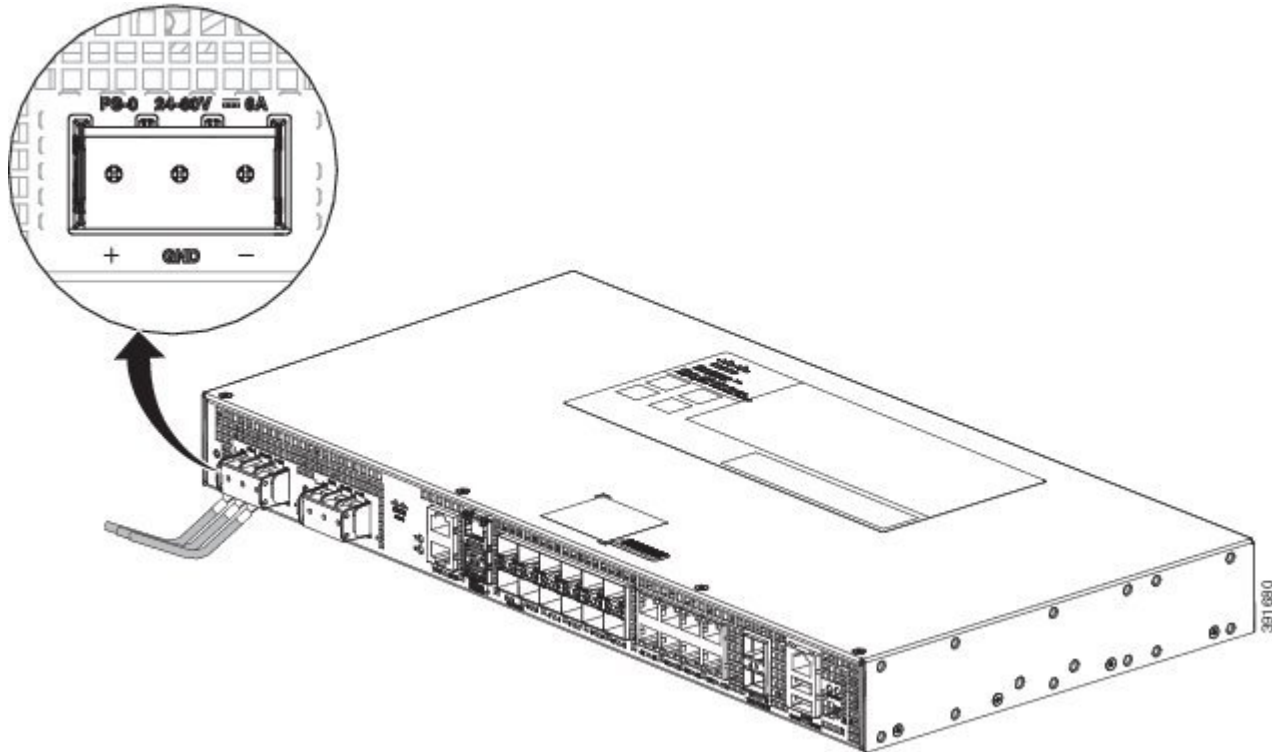

Figure 16: Attaching the DC Power Supply



Step 3 Close the DC power supply guard.

Power on the Device

After the device is mounted, perform these tasks to complete the installation:

- Power on the device.
- Connect the front-panel ports.

Connect SFP Modules

Before you begin this task, ensure that you have read and understood the safety warnings in the *Safety Precautions for Module Installation and Removal* section of the *Safety Warnings* chapter.

Use only Cisco SFP modules on a Cisco device. Each SFP module has an internal serial EEPROM that is encoded with security information. This encoding provides a way for Cisco to identify and validate that the SFP modules meet the requirements of the device.



Caution

We recommend that you wait for 30 seconds between the removal and insertion of an SFP module from the device. The wait period allows the transceiver software to initialize and synchronize with the device. Changing an SFP before this wait period could result in transceiver initialization issues that disable the SFP.

This section provides procedures for installing and connecting SFP modules. Also, it provides the procedure for removing SFP modules.

Install SFP Modules

The figure below shows an SFP module that has a bale-clasp latch.



Caution We strongly recommend that you do not install or remove fiber-optic SFP modules with cables attached because of the potential damage to the cables, the cable connector, or the optical interfaces in the SFP module. Disconnect all cables before removing or installing an SFP module.

Removing and installing an SFP module can shorten its useful life. Do not remove and insert SFP modules more often than is absolutely necessary.

Figure 17: SFP Module with a Bale-Clasp Latch

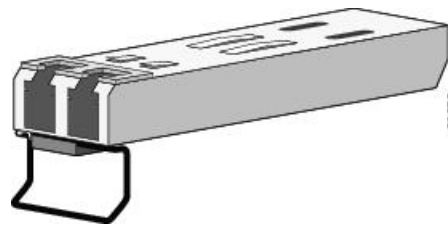

To insert an SFP module into the module slot, follow these steps:

Procedure

- Step 1** Attach an ESD-preventive wrist strap to your wrist and to a bare metal surface on the chassis.
Some SFP modules identify the top side of the module with send (TX) and receive (RX) markings or arrows that show the direction of the connection.
- Step 2** If the SFP module that you are using has the markings, use them to identify the top side of the module.
- Step 3** Align the SFP module in front of the slot opening.
- Step 4** Insert the SFP module into the slot until you feel the connector on the module snap into place in the rear of the slot.

Figure 18: Installing an SFP Module into an SFP Module Slot

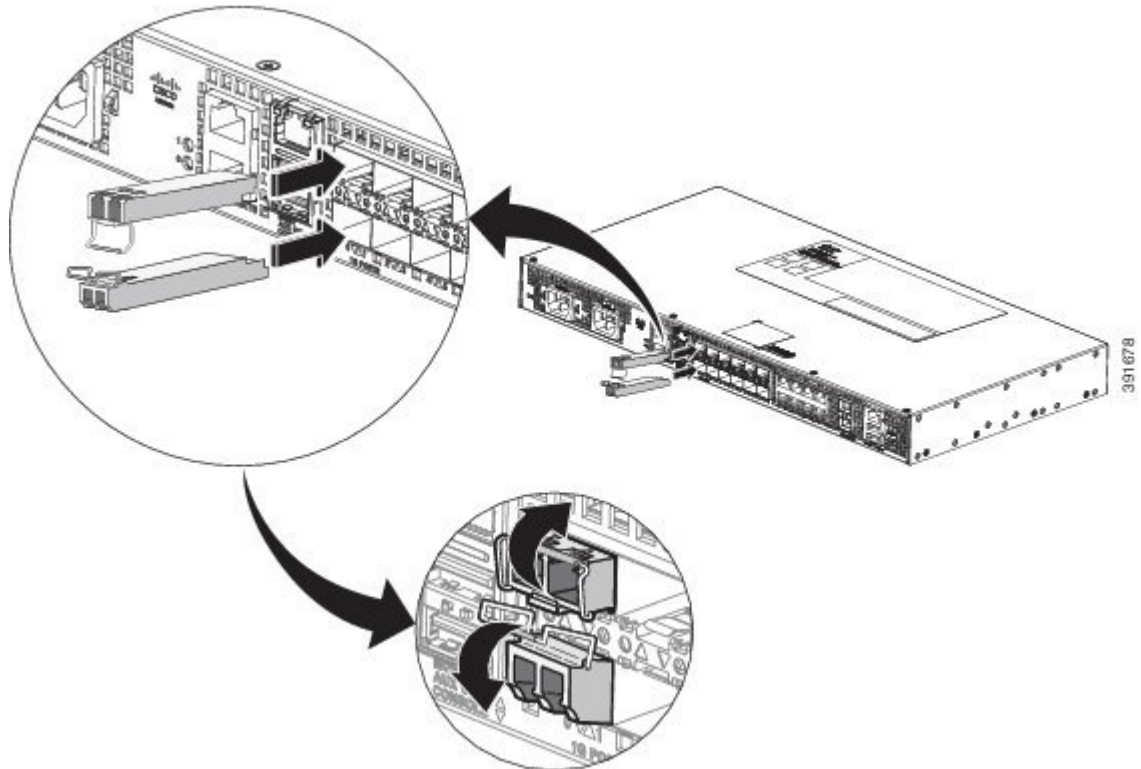

Caution Do not remove the dust plugs from the fiber-optic SFP module port or the rubber caps from the fiber-optic cable until you are ready to connect the cable. The plugs and caps protect the SFP module ports and cables from contamination and ambient light. Store the dust plugs for later use.

- Step 5** Insert the cable connector into the SFP module:
- For fiber-optic SFP modules, insert the LC cable into the SFP module.
 - For copper 1000BASE-T SFP modules, insert the RJ-45 cable connector into the SFP module.

Remove SFP Modules

To remove an SFP module from a module receptacle, follow these steps:

Procedure

- Step 1** Attach an ESD-preventive wrist strap to your wrist and to a bare metal surface on the chassis.
- Step 2** Disconnect the cable from the SFP module, and insert a dust plug into the cable end.
- Tip** For reattachment, note which cable connector plug is send (TX) and which is receive (RX).
- Step 3** Unlock and remove the SFP module, as shown in the following figure.

If the module has a bale-clasp latch, pull the bale out and down to eject the module. If the bale-clasp latch is obstructed and you cannot use your index finger to open it, use a small, flat-blade screwdriver or other long, narrow instrument to open the bale-clasp latch.

Figure 19: Removing a Bale-Clasp Latch SFP Module

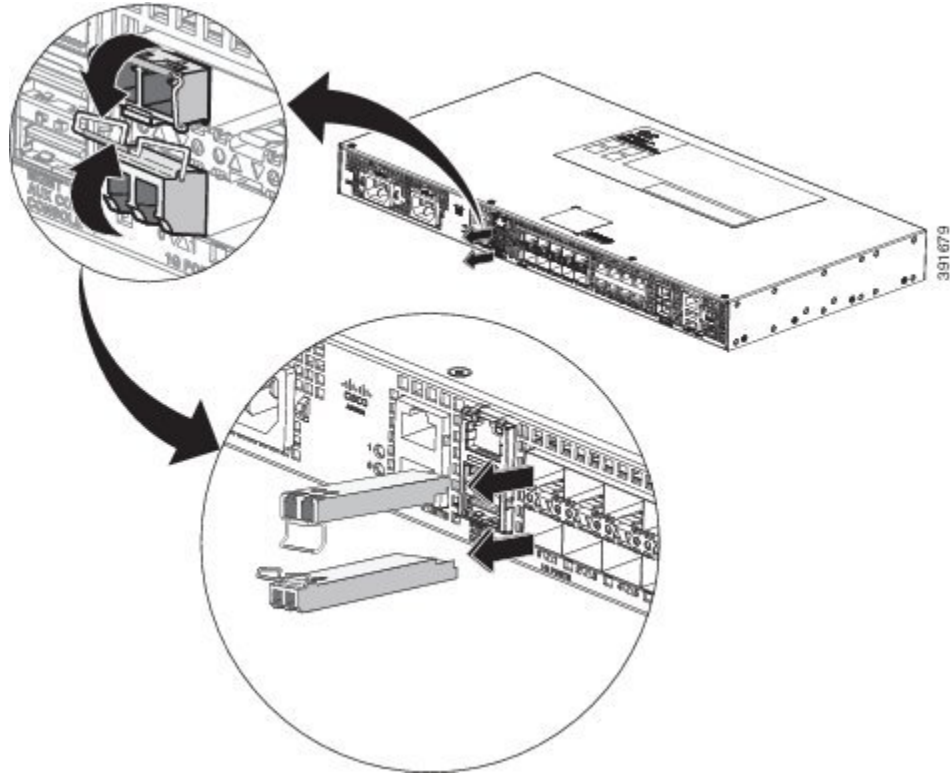

- Step 4** Grasp the SFP module between your thumb and index finger, and carefully remove it from the module slot.
- Step 5** For fiber-optic SFP modules, insert a dust plug into the optical ports of the SFP module to keep the optical interfaces clean.
- Step 6** Place the removed SFP module in an antistatic bag or other protective environment.

Connect Gigabit Ethernet Ports

You can choose to connect either a copper or a fiber cable in the Gigabit Ethernet ports.



Note The device 10/100/1000 ports configure themselves to operate at the speed of devices to which they are attached. Autonegotiation is enabled by default in the chassis. You can manually set the speed and the duplex parameters. If the device to which the ports are attached, does not autonegotiate, low performance or no linkage may result.

To maximize performance, choose one of these methods for configuring Ethernet ports:

- Have ports autonegotiate both speed and duplex.
- Set the port speed and duplex parameters on both ends of the connection.



Note You can use the **mdix auto** command in interface configuration mode in CLI to enable automatic media-dependent interface with crossover detection. After you enable, the device detects the required cable type for copper Ethernet connections and configures the interfaces accordingly. Therefore, you can use either a crossover or a straight-through cable for connecting to a copper 10/100/1000 port. If the **mdix auto** command is not enabled, connect the cable through SFP module.

Procedure

Step 1 Connect to workstations, servers, and devices, connect a straight-through cable to an RJ-45 connector on the front panel. When connecting to devices or repeaters, use a crossover cable.

Step 2 Connect the other end of the cable to an RJ-45 connector on the other device. The port LED turns on when both the device and the connected device have established a link.

If the port LED does not turn on, check whether the device at the other end is turned on or whether there is any failure.

Note On user network interface (UNI) ports, the port LED turns green after the link is established.

Step 3 Reconfigure and reboot the connected device if necessary.

Step 4 Repeat Steps 1 to 3 for each device that is to be connected.

Connect to SFP Modules

This section describes how to connect to SFP modules.

Connect Fiber Optic SFP Modules



Caution Do not remove the rubber plugs from the SFP module port or from the fiber optic cable until you are ready to connect the cable. The plugs and caps protect the SFP module ports and cables from contamination and ambient light.

Procedure

Step 1 Remove the rubber plugs from the module port and fiber optic cable, and store them for future use.

Step 2 Insert one end of the fiber optic cable into the SFP module port.

Step 3 Insert the other end into a fiber optic connector at a target device.

Step 4 Observe the port's LED status.

The LED turns green when the device and the target device establish a link.

If the LED is off, check whether the target device is turned on, or whether there is any failure in the target device.

Step 5 If necessary, reconfigure and restart the device or target device.

Install the Chassis Ground Connection

Before you connect the power or turn on the power to the router, you must provide an adequate chassis ground (earth) connection to your router.

This section describes how to ground the router chassis. The grounding lug location is on the back panel of the router.



Tip Ensure that the grounding lug wire does not cover the fan opening.

Figure 20: Attaching a Grounding Lug to the Rear of the Router

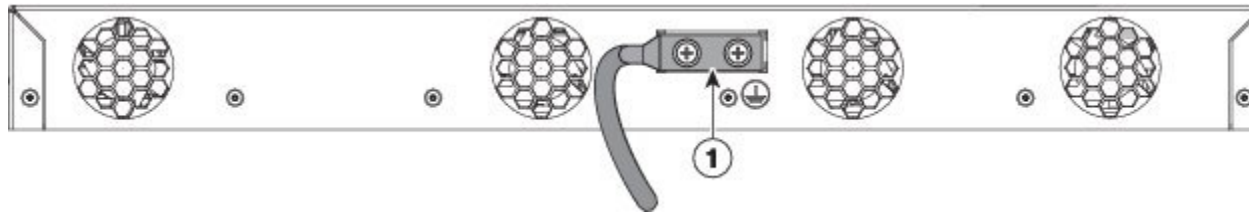

1 Grounding-lug

To ensure that the chassis ground connection that you provide is adequate, you need the following parts and tools:

- Ratcheting torque screwdriver with Phillips head that exerts up to 15 in.-lb (1.69 N-m) of torque for attaching the ground wire to the router
- Crimping tool as specified by the ground lug manufacturer
- 6-AWG or larger copper wire for the ground wire
- Wire-stripping tools appropriate to the wire you are using



Caution Before making connections to the router, ensure that you disconnect the power at the circuit breaker. Otherwise, severe injury to you or damage to the router may occur.



Warning This equipment must be grounded. Never defeat the ground conductor or operate the equipment in the absence of a suitably installed ground conductor. Contact the appropriate electrical inspection authority or an electrician if you are uncertain that suitable grounding is available. Statement 1024



Warning Use copper conductors only. Statement 1025



Warning When installing the unit, the ground connection must always be made first and disconnected last. Statement 42

This unit is to be installed in a restrictive access location and must be permanently grounded to a minimum 6-AWG copper ground wire.

Perform the following procedure to ground the router using a 2-hole lug and the corresponding mounting point. Most carriers require a minimum 6-AWG ground connection. Verify your carrier's requirements for the ground connection.

Procedure

- Step 1** If your ground wire is insulated, use a wire-stripping tool to strip the ground wire to 0.5 inch \pm 0.02 inch (12.7 mm \pm 0.5 mm) (See the figure below).

Figure 21: Stripping a Ground Wire

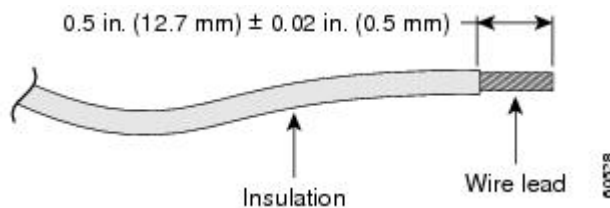

- Step 2** Slide the open end of your 2-hole ground lug over the exposed area of the ground wire.
- Step 3** Using a crimping tool (as specified by the ground lug manufacturer), crimp the ground lug to the ground wire as shown in the figure below.

Figure 22:

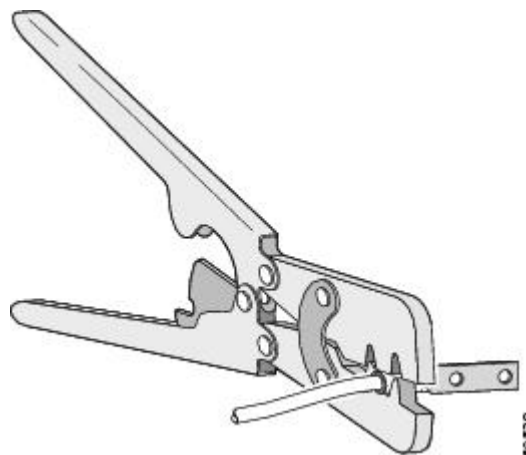

- Step 4** Use a Phillips head screwdriver to attach the 2-hole ground lug and wire assembly to the router with the 2 pan-head Phillips head screws.
- Step 5** Connect the other end of the ground wire to a suitable grounding point at your site.
-

Power Connection Guidelines

This section provides guidelines for connecting the device power supplies to the site power source.

**Warning**

The plug-socket combination must be accessible at all times, because it serves as the main disconnecting device.

**Warning**

This equipment must be grounded. To reduce the risk of electric shock, never defeat the ground conductor or operate the equipment in the absence of a suitably installed ground conductor. Contact the appropriate electrical inspection authority or an electrician if you are uncertain that suitable grounding is available.

Guidelines for DC-Powered Systems

Basic guidelines for DC-powered systems include the following:

- Each chassis power supply has its own dedicated input power source. The source must comply with the safety extra-low voltage (SELV) requirements in the UL 60950, CSA 60950, EN 60950, and IEC 60950 standards.
- Protect the circuit by a dedicated two-pole circuit breaker. Ensure that the circuit breaker is sized according to the power supply input rating and local or national code requirements.
- The circuit breaker is considered as the disconnect device and is easily accessible.
- The system ground is the power supply and chassis ground.
- Use the grounding lug to attach a wrist strap for ESD protection during servicing.
- Do not connect the DC return wire to the system frame or to the system-grounding equipment.
- Ensure that the DC return is grounded at the source side.
- Ensure that each power feed of the equipment is connected to different sources.

Guidelines for AC-Powered Systems

Basic guidelines for AC-powered systems include the following:

- Each chassis power supply has its own dedicated branch circuit.
- Ensure that the circuit breaker is sized according to the power supply input rating and local or national code requirements.

- The AC power receptacles that are used to plug in the chassis must be the grounding type. The grounding conductors that connect to the receptacles must connect to protective earth ground at the service equipment.

Prevent Power Loss

Use the following guidelines to prevent power loss to the device:

- To prevent input power loss, ensure that the maximum load on each circuit supplying the power is within the current ratings of the wiring and breakers.
- In some systems, you can use an UPS to protect against power failures at your site. Avoid UPS types that use ferroresonant technology. These UPS types can become unstable with systems such as the device, which can have substantial current-draw fluctuations due to bursty data traffic patterns.

Determining power requirements is useful for planning the power distribution system to support the device.

Activate DC Power Supply

Procedure

- Step 1** Remove the tape from the circuit-breaker device handle, and restore power by moving the circuit-breaker device handle to the On (I) position.
- Step 2** Verify the power supply operation by ascertaining that the front panel LED is green.
- Step 3** If the LEDs indicate a power problem, see the *Troubleshooting Aids* chapter.
- Step 4** If you are also connecting a redundant DC power supply, repeat these steps for the second power source.

Note When you connect a redundant DC power supply, ensure that each power supply is connected to a separate power source to prevent power loss during a failure.

Activate AC Power Supply

Procedure

- Step 1** Plug the power cord into the power supply.
- Step 2** Connect the other end of the power cord to an AC-input power source.
- Step 3** Verify the power supply operation by ascertaining that the front panel LED is green.
- Step 4** If the LEDs indicate a power problem, see the *Troubleshooting Aids* chapter.
- Step 5** If you are also connecting a redundant AC power supply, repeat these steps for the second power source.

Note When you connect a redundant AC power supply, ensure that each power supply is connected to a separate power source to prevent power loss during failure.

Connect Chassis to Network



Note Connect only SELV services to all the device ports.

Connecting Console Cables

The following sections describe how to connect to the router using console cables:

Connecting to the USB Serial Port Using Microsoft Windows

This procedure shows how to connect to the USB serial port using Microsoft Windows.



Note Install the USB device driver before establishing a physical connection between the router and the PC, by using the USB console cable plugged into the USB serial port. Otherwise, the connection will fail. For more information, see the [Installing the Cisco USB Device Driver](#).

Procedure

	Command or Action	Purpose
Step 1	Connect a USB Type A-to-Type A cable to the USB console port, as shown in the figure below. If you are using the USB serial port for the first time on a Windows-based PC, install the USB driver now according to the instructions in the following sections:	<ul style="list-style-type: none"> • Installing the Cisco Microsoft Windows XP USB Driver, page 3-29 • Installing the Cisco Microsoft Windows 2000 USB Driver, page 3-29 • Installing the Cisco Microsoft Windows Vista USB Driver, page 3-30 <p>Note You cannot use the USB port and the EIA port concurrently. When the USB port is used, it takes priority over the EIA port.</p>
Step 2	Connect the USB Type A cable to the PC.	
Step 3	To communicate with the router, start a terminal emulator application, such as Microsoft Windows HyperTerminal. This software should be configured with the following parameters:	<ul style="list-style-type: none"> • 9600 baud • 8 data bits • no parity • 1 stop-bit • no flow control

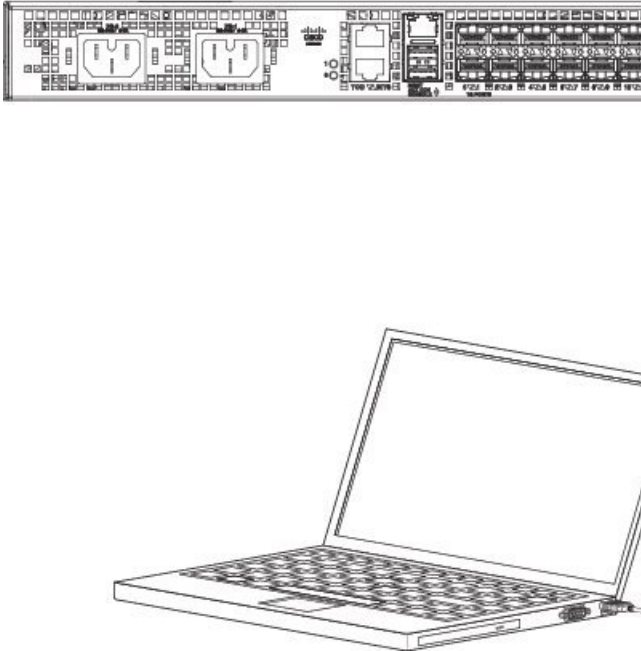
	Command or Action	Purpose								
		<p data-bbox="987 279 1479 327"><i>Figure 23: Connecting the USB Console Cable to the Cisco ASR 920 Series Router</i></p>  <table border="1" data-bbox="987 1205 1479 1415"> <thead> <tr> <th data-bbox="993 1209 1049 1257">Label</th> <th data-bbox="1049 1209 1151 1257">Cable</th> <th data-bbox="1151 1209 1281 1257">Label</th> <th data-bbox="1281 1209 1472 1257">Cable</th> </tr> </thead> <tbody> <tr> <td data-bbox="993 1262 1049 1411">1</td> <td data-bbox="1049 1262 1151 1411">USB Type-A console port</td> <td data-bbox="1151 1262 1281 1411">2</td> <td data-bbox="1281 1262 1472 1411">USB USB Type-A to USB Type-A console cable</td> </tr> </tbody> </table>	Label	Cable	Label	Cable	1	USB Type-A console port	2	USB USB Type-A to USB Type-A console cable
Label	Cable	Label	Cable							
1	USB Type-A console port	2	USB USB Type-A to USB Type-A console cable							

Connecting to the Console Port Using Mac OS X

This procedure describes how to connect a Mac OS X system USB port to the console using the built-in OS X terminal utility.

Procedure

-
- Step 1** Use the Finder to choose Applications > Utilities > Terminal.
 - Step 2** Connect the OS X USB port to the router.
 - Step 3** Enter the following commands to find the OS X USB port number:

Example:

```
macbook:user$ cd /dev
macbook:user$ ls -ltr /dev/*usb*
crw-rw-rw- 1 root  wheel      9,  66 Apr  1 16:46 tty.usbmodem1a21 DT-macbook:dev user$
```

Step 4 Connect to the USB port with the following command followed by the router USB port speed:

Example:

```
macbook:user$ screen /dev/tty.usbmodem1a21 9600
```

To disconnect the OS X USB console from the terminal window, enter Ctrl-a followed by Ctrl-\

Connecting to the Console Port Using Linux

This procedure shows how to connect a Linux system USB port to the console using the built-in Linux terminal utility.

Procedure

- Step 1** Open the Linux terminal window.
- Step 2** Connect the Linux USB port to the router.
- Step 3** Enter the following commands to find the Linux USB port number:

Example:

```
root@usb-suse# cd /dev
root@usb-suse /dev# ls -ltr *ACM*
crw-r--r-- 1 root  root    188,  0 Jan 14 18:02 ttyACM0
root@usb-suse /dev#
```

Step 4 Connect to the USB port with the following command, followed by the router USB port speed:

Example:

```
root@usb-suse /dev# screen /dev/ttyACM0 9600
```

To disconnect the Linux USB console from the terminal window, enter Ctrl-a followed by : then quit

Installing the Cisco USB Device Driver

A USB device driver must be installed the first time a Microsoft Windows-based PC is connected to the USB serial port on the router.

This procedure describes how to install the Microsoft Windows USB device driver in Microsoft Windows XP, Windows Vista, Windows 2000, Windows 7, and Windows 8. Download the driver for your router model from the Tools and Resources Download Software site, USB Console Software category, at:

<https://software.cisco.com/download/default?contentID=28037604&flowID=71056&softwareID=28285512&class=3.13&cmd=AVAILABLE&releaseCycle=&type=1st>



Note To download the driver, you must have a valid service contract associated to your Cisco.com profile.

Procedure

- Step 1** Unzip the file asr-9xx_usbconsole_drivers.zip.
 - Step 2** Double-click xrusbser_ver2100_installer.exe in the XR21x141x-Win-DriversOnly-Vers2.1.0.0/EXE folder. Installation Wizard GUI is displayed.
 - Step 3** Click Next. The InstallShield Wizard Completed window is displayed.
 - Step 4** Click Finish.
 - Step 5** Connect the USB cable to the PC and router USB console ports. Follow the on-screen instructions to complete the installation of the driver.
 - Step 6** XR21V1401 USB UART Device driver successfully installed message is displayed.
The USB console is ready for use.
-

Uninstalling the Cisco USB Driver

This procedure describes how to uninstall the Microsoft Windows USB device driver in Microsoft Windows XP, Windows Vista, Windows 2000, Windows 7, and Windows 8.



Note Disconnect the router console terminal before uninstalling the driver.

Procedure

- Step 1** Choose Start > Control Panel > Add or Remove Programs.
 - Step 2** Scroll to **Windows Driver Package - Exar corporation (xrusbser) Ports** and click **Remove**. The **Program Maintenance** window is displayed.
 - Step 3** Click **Yes** to uninstall the driver.
-

Connect to the EIA Console Port



Note The US-to-RJ45 adapter cable and the DB9 console cable are not included with the router; they can be ordered separately from Cisco.



Note The serial console cable kit is not included with the router; it is ordered separately.

To connect a terminal to the EIA Console port on the router, follow these steps:

Procedure

- Step 1** Connect the USB end of the USB-to RJ-45 cable to the EIA Console port.
- Step 2** Connect the RJ-45 end of the DB-9 adapter cable to the USB-to RJ-45 cable, as shown in the figure below.

Figure 24: EIA Console Port

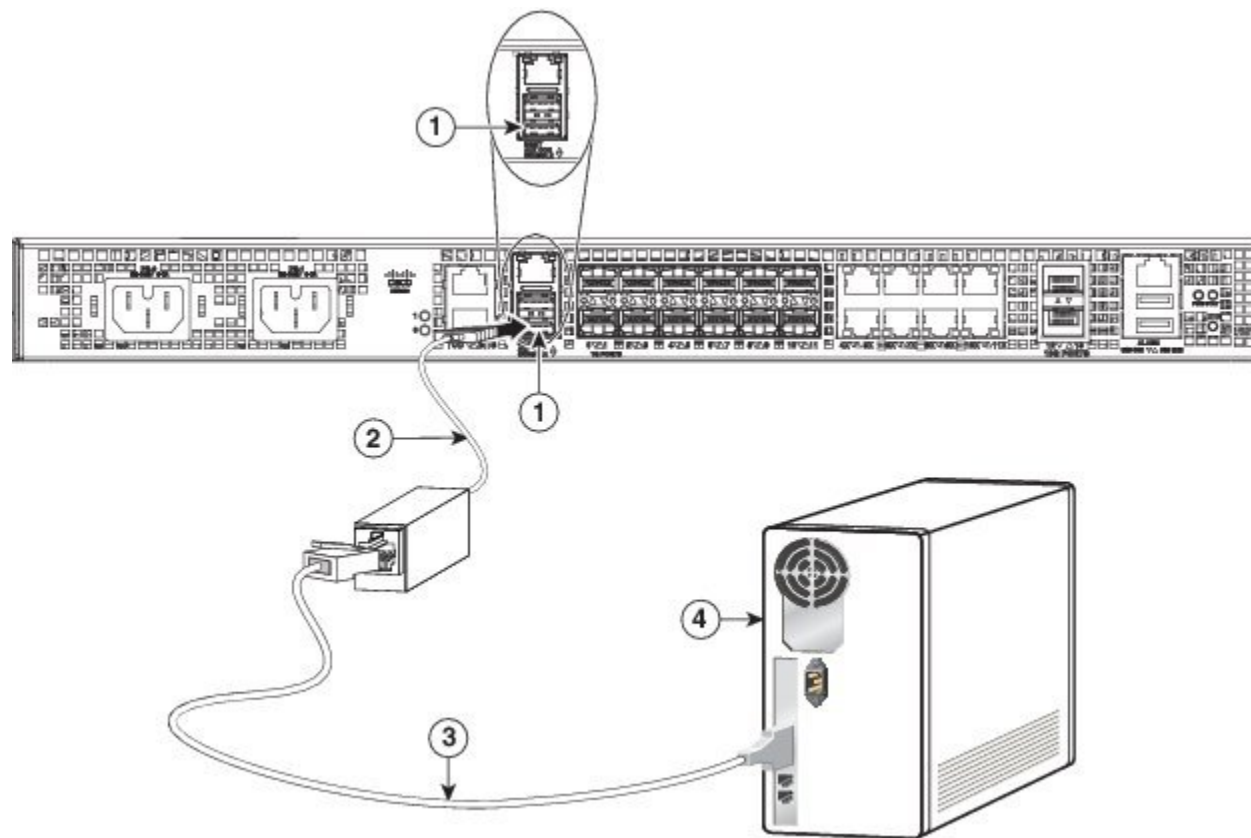

Table 1: EIA Console Port

Label	Component	Label	Component
1	EIA Console port	3	RJ-45 to DB-9 cable
2	USB-to-RJ45 adapter	4	Desktop or system

- Step 3** Connect the DB-9 end of the console cable to the DB-9 end of the terminal.

Step 4 To communicate with the router, start a terminal emulator application, such as Microsoft Windows HyperTerminal. This software should be configured with the following parameters:

- 9600 baud
 - 8 data bits
 - no parity
 - 1 stop-bit
 - no flow control
-

Connect a Management Ethernet Cable

When using the Ethernet Management port in the default mode (speed-auto and duplex-auto), the port operates in the auto-MDI/MDI-X mode. The port automatically provides the correct signal connectivity through the Auto-MDI/MDI-X feature, and senses a crossover or straight-through cable and adapts to it.

However, the Ethernet Management port may be configured to a fixed speed (10, 100, or 1000 Mbps) through command-line interface (CLI) commands. In such a case, the port is forced to operate in the MDI mode.

When in a fixed-speed configuration and MDI mode, use:

- a crossover cable to connect to an MDI port
- a straight-through cable to connect to an MDI-X port

Install and Remove SFP and SFP+ Modules

The router supports a variety of SFP and SFP+ modules, including optical and Ethernet modules. For information on how to install and remove SFP and SFP+ modules, see the documentation for the SFP or SFP+ module at:

http://www.cisco.com/en/US/partner/products/hw/modules/ps5455/prod_installation_guides_list.html.

For information about inspecting and cleaning fiber-optic connections, see:

http://www.cisco.com/en/US/partner/tech/tk482/tk876/technologies_white_paper09186a0080254eba.shtml.



Caution

We recommend that you wait for 30 seconds between the removal and insertion of an SFP on an interface module. We recommend this to allow the transceiver software to initialize and synchronize with the router. Changing an SFP more quickly could result in transceiver initialization issues that disable the SFP.

Connecting a USB Flash Device

To connect a USB flash device to the Cisco ASR 920 Series Router, insert the memory stick in the USB port labeled USB MEM. The Flash memory module can be inserted only one way, and can be inserted or removed regardless of whether the router is powered up or not.

The figure below shows the USB port connector on the Cisco ASR 920 Series Router.

Figure 25: Cisco ASR 920 Series Router Flash Token Memory Stick



Removing a USB Flash Device

To remove and replace a USB flash token memory stick from and into a Cisco ASR 920 Series Router, follow these steps:



Note If the USB flash device is abruptly removed, the constant sync operations of the file system in progress fail due to the USB device removal. These errors occur with ext2 or ext3 or ext4 file systems and are not seen with fat32 file system. This is a default behavior on any Linux platform.

The following error messages are displayed when you remove the USB device:

```
*Jun 24 10:29:45.766: %IOSXE-3-PLATFORM: R0/0: kernel: EXT2-fs (sda1): previous I/O error
to superblock detected
*Jun 24 10:29:45.878: %IOSXE-3-PLATFORM: R0/0: kernel: EXT2-fs (sda1): previous I/O error
to superblock detected
*Jun 24 10:29:46.012: %IOSXE-3-PLATFORM: R0/0: kernel: EXT2-fs (sda1): previous I/O error
to superblock detected
*Jun 24 10:29:46.013: %IOSXE-3-PLATFORM: R0/0: kernel: EXT2-fs (sda1): previous I/O error
to superblock detected
```

Procedure

Step 1 Execute the `eject usb0:` command before removing the USB from the router.

Example:

```
rommon 2 > eject usb0
rommon 2 >
```

If you do not run this command before removing the USB, the following error message is displayed:

```
rommon 2 > dir usb0:
usb_stor_BBB_comdat:usb_bulk_msg error
failed to send CBW status 34
RESET:stall
usb_stor_BBB_comdat:usb_bulk_msg error
failed to send CBW status 34
RESET:stall
usb_stor_BBB_comdat:usb_bulk_msg error
```

Step 2 Pull the memory stick from the USB port.

Step 3 To replace the Cisco USB Flash memory stick, simply insert the module into the USB port labeled USB MEM, as shown in the figure above. The Flash memory module can be inserted only one way, and can be inserted or removed regardless of whether the router is powered up or not.

This completes the USB Flash memory installation procedure.

Connecting Timing Cables

The following sections describe how to connect timing cables to the Cisco ASR 920 Series Router:

Connecting a Cable to the BITS Interface

The following steps describe how to connect a cable to the router's BITS port:

Procedure

- Step 1** Confirm that the router is powered off.
- Step 2** Connect one end of the cable to the BITS port using a straight-through, shielded RJ48C-to-RJ48C cable.
- Step 3** Connect the other end to the BTS patch or demarcation panel at your site.
- Step 4** Turn on the power to the router.

For information about the BITS port pinouts, see [Chapter 5, "Troubleshooting"](#)

Warning To comply with the Telcordia GR-1089 NEBS standard for electromagnetic compatibility and safety, connect the BITS ports only to intra-building or unexposed wiring or cable. The intrabuilding cable must be shielded and the shield must be grounded at both ends. The intra-building port(s) of the equipment or subassembly must not be metallicly connected to interfaces that connect to the OSP or its wiring. These interfaces are designed for use as intra-building interfaces only (Type 2 or Type 4 ports as described in GR-1089-CORE) and require isolation from the exposed OSP cabling. The addition of Primary Protectors is not sufficient protection in order to connect these interfaces metallicly to OSP wiring. Statement

Connecting Cables to a GPS Interface

The following sections describe how to connect cables from the Cisco ASR 920 Series Router to a GPS unit for input or output timing of frequency:

Connecting a Cable to the ToD Interface

Procedure

- Step 1** Connect one end of a straight-through Ethernet cable to the GPS unit.
- Step 2** Connect the other end of the straight-through Ethernet cable to the ToD/1-PPS port on the Cisco ASR 920 Series Router.

Warning To comply with the Telcordia GR-1089 NEBS standard for electromagnetic compatibility and safety, connect the ToD ports only to intra-building or unexposed wiring or cable. The intrabuilding cable must be shielded and the shield must be grounded at both ends. The intra-building port(s) of the equipment or subassembly must not be metalically connected to interfaces that connect to the OSP or its wiring. These interfaces are designed for use as intra-building interfaces only (Type 2 or Type 4 ports as described in GR-1089-CORE) and require isolation from the exposed OSP cabling. The addition of Primary Protectors is not sufficient protection in order to connect these interfaces metalically to OSP wiring.

Note For more information about GPS-port pinouts, see [Chapter 5, “Troubleshooting.”](#)

Connect Cable to Copper Gigabit Ethernet Port

The device interface modules support RJ-45 and Ethernet SFP ports.

The RJ-45 port supports standard straight-through and crossover Category 5 unshielded twisted-pair (UTP) cables. Cisco does not supply Category 5 UTP cables. These cables are available commercially.

Procedure

-
- Step 1** Confirm that the device is powered off.
 - Step 2** Connect one end of the cable to the Gigabit Ethernet port on the device.
 - Step 3** Connect the other end to the BTS patch or demarcation panel at your site.
-

You have successfully installed the device and you are now ready to carry out a basic device configuration.

Connect Cables to SFP Modules

For information on connecting cables to Cisco optical and Ethernet SFP interfaces, see:

http://www.cisco.com/en/US/partner/products/hw/modules/ps5455/prod_installation_guides_list.html.

Connector and Cable Specifications

For more information on cable specifications and pinouts, see [Chapter 5, “Troubleshooting”](#).

