



Cisco ASR 1000 Series Aggregation Services Routers Software Configuration Guide, Cisco IOS XE 17

First Published: 2019-11-15

Last Modified: 2024-08-15

Americas Headquarters

Cisco Systems, Inc.
170 West Tasman Drive
San Jose, CA 95134-1706
USA
<http://www.cisco.com>
Tel: 408 526-4000
800 553-NETS (6387)
Fax: 408 527-0883



CONTENTS

CHAPTER 1

Preface 1

- Objectives 1
- Document Revision History 1
- Organization 6
- Related Documentation 8
- Document Conventions 8
- Communications, Services, and Additional Information 10

CHAPTER 2

Read Me First 11

- Short Description 12

CHAPTER 3

Software Packaging and Architecture 13

- Software Packaging on the Cisco ASR 1000 Series Routers 13
 - ASR 1000 Series Routers Software Overview 13
 - Consolidated Packages 14
 - Important Information About Consolidated Packages 14
 - Individual Software SubPackages Within a Consolidated Package 14
 - Important Notes About Individual SubPackages 15
 - Optional Software SubPackages Outside of Consolidated Packages 15
 - Important Notes About Optional SubPackages 15
- Provisioning Files 16
 - Important Notes About Provisioning Files 16
- ROMmon Image 16
- File to Upgrade Field Programmable Hardware Devices 17
- Image Signing and Bootup 17
- Processes Overview 19

IOS as a Process	20
Dual IOS Processes	21
File Systems on the Cisco ASR 1000 Series Router	21
Autogenerated File Directories and Files	22
Important Notes About Autogenerated Directories	22

CHAPTER 4**Using Cisco IOS XE Software 23**

Accessing the CLI Using a Router Console	23
Accessing the CLI Using a Directly-Connected Console	23
Connecting to the Console Port	24
Using the Console Interface	24
Accessing the CLI from a Remote Console Using Telnet	25
Preparing to Connect to the Router Console Using Telnet	25
Using Telnet to Access a Console Interface	26
Using Keyboard Shortcuts	27
Using the History Buffer to Recall Commands	28
Understanding the Command Mode	28
Getting Help	30
Finding Command Options	30
Using the no and default Forms of Commands	33
Syslog for Improper Card Seating	33
Saving Configuration Changes	33
Managing Configuration Files	33
Filtering the Output of the show and more Commands	35
Powering Off a Router	35
Finding Support Information for Platforms and Cisco Software Images	35
Using the Cisco Feature Navigator	36
Using the Software Advisor	36
Using the Software Release Notes	36

CHAPTER 5**Console Port, Telnet, and SSH Handling 37**

Console Port Overview for the Cisco ASR 1000 Series Routers	37
Console Port Handling Overview	37
Telnet and SSH Overview for the Cisco ASR 1000 Series Routers	38

Persistent Telnet and Persistent SSH Overview	38
Configuring a Console Port Transport Map	38
Examples	40
Configuring Persistent Telnet	40
Examples	42
Configuring Persistent SSH	42
Examples	44
Viewing Console Port, SSH, and Telnet Handling Configurations	45
Important Notes and Restrictions	48

CHAPTER 6**Consolidated Packages and SubPackages Management 49**

Running the Cisco ASR 1000 Series Routers: An Overview	49
Running the Cisco ASR 1000 Series Routers Using Individual and Optional SubPackages: An Overview	49
Running the Cisco ASR 1000 Series Routers Using a Consolidated Package: An Overview	50
Running the Cisco ASR 1000 Series Routers: A Summary	51
Software File Management Using Command Sets	52
The request platform Command Set	52
The copy Command	52
The issu Command Set	53
Managing and Configuring the Router to Run Using Consolidated Packages and Individual SubPackages	53
Quick Start Software Upgrade	53
Managing and Configuring a Router to Run Using a Consolidated Package	54
Managing and Configuring a Consolidated Package Using the copy Command	55
Managing and Configuring a Consolidated Package Using the request platform software package install Command	56
Managing and Configuring a Router to Run Using Individual SubPackages From a Consolidated Package	57
Extracting a Consolidated Package and Booting Using the Provisioning File	57
Copying a Set of Individual SubPackage Files, and Booting Using a Provisioning File	61
Managing and Configuring a Router to Run Using Optional SubPackages	61
Installing an Optional SubPackage	62
Uninstalling an Optional SubPackage	63
Troubleshooting Software Mismatch with ESP Board ASR1000-ESP10-N	65

Upgrading Individual SubPackages 66

Upgrading a SPA SubPackage 66

CHAPTER 7

Installing the Software using install Commands 69

Installing the Software Using install Commands 69

Restrictions for Installing the Software Using install Commands 69

Information About Installing the Software Using install Commands 69

Install Mode Process Flow 70

Booting the Platform in Install Mode 75

One-Step Installation or Converting from Bundle Mode to Install Mode 76

Three-Step Installation 77

Upgrading in Install Mode 78

Downgrading in Install Mode 79

Terminating a Software Installation 79

Configuration Examples for Installing the Software Using install Commands 79

Troubleshooting Software Installation Using install Commands 91

CHAPTER 8

Software Upgrade Processes Supported by Cisco ASR 1000 Series Routers 93

Prerequisites for Software Upgrade Processes 94

ISSU Upgrade for Redundant Platforms 95

Overview of ISSU on the Cisco ASR 1000 Series Routers 95

ISSU Rollback Timer Overview 97

Software Upgrade with Dual IOS Processes on a Single RP Overview 97

Cisco IOS XE Software Package Compatibility for ISSU 98

Restrictions for ISSU 98

ISSU Upgrade Procedures 99

Using ISSU to Perform a Consolidated Package Upgrade in a Dual Route Processor
Configuration 99

Using ISSU to Upgrade the Subpackages in a Dual Route Processor Configuration 105

In Service One-Shot Software Upgrade Procedure 157

ISSU Procedures (Prior to Cisco IOS XE Release 2.1.2) 157

Using ISSU to Perform a Consolidated Package Upgrade in a Dual Route Processor Configuration
(Prior to Cisco IOS XE 2.1.2) 158

Using ISSU to Upgrade Subpackages (Prior to Cisco IOS XE Release 2.1.2) 158

Upgrade Process with Service Impact for Nonredundant Platforms	160
Configuring SSO on a Cisco ASR 1001, Cisco ASR 1001-X, Cisco ASR 1001-HX, Cisco ASR 1002, Cisco ASR 1002-X, Cisco ASR 1002-HX, or Cisco ASR 1004 Router	160
Using Subpackages for Software Upgrade on a Cisco ASR 1001 Router, Cisco ASR 1001-X Router, Cisco ASR 1001-HX Router, Cisco ASR 1002-X Router or a ASR 1002-HX Router	163
Examples	170
Using Subpackages for Software Upgrade on a Cisco ASR 1002 Router or Cisco ASR 1004 Router (software upgrade Command Set)	179
Examples	188
Using Subpackages for Software Upgrade on a Cisco ASR 1002 Router or Cisco ASR 1004 Router (request platform Command Set)	207
Examples	215
Minimal Disruptive Restart ISSU	234
Restrictions and Limitations	235
High-Availability Considerations	236
Using ISSU to Perform a Consolidated Package Upgrade in a Dual Route Processor Configuration with MDR	236
Examples	240
Using ISSU to Upgrade the Subpackages on a Cisco ASR 1006 Router and Cisco ASR 1013 Router (issu Command Set) with MDR	245
Examples	256
Using ISSU to Upgrade Subpackages on a Cisco ASR 1006 Router or Cisco ASR 1013 Router (request platform command set) with MDR	283
Examples	292
Additional References	319
Feature Information for Software Upgrade Process	320

CHAPTER 9
Software Upgrade Process Using install Commands 323

Prerequisites for Software Upgrade Process Using install Commands	323
Restrictions for Software Upgrade Process Using install Commands	323
Information About Software Upgrade Process Using install Commands	324
Introduction to install Commands	324
Software Upgrade Process Modes, Options, and Workflows using install Commands	324
Guidelines for Software Upgrade Process When Using install Commands	325
Super Package Upgrade Process	325

Super Package Upgrade Use Cases	326
Subpackage Upgrade Process	326
Subpackage Upgrade Use Cases	328
Crash Handling and Rollback	329
Auto Upgrade on ASR 1000 Series Routers	329
How to Upgrade Software Using install Commands	330
Upgrading Software Using 3-Step Super Package Workflow on Consolidated Platforms	330
Upgrading Software Using 5-Step Super Package Workflow on Consolidated Platforms	331
Upgrading Software Using 1-Step Super Package Workflow on Consolidated Platforms	332
Upgrading Software Using 3-Step Subpackage Workflow on Dual RP Devices	333
Upgrading Software Using 8-Step Subpackage Workflow on Dual RP Devices	333
Upgrading Software Using 1-Step Subpackage Workflow on Dual RP Devices	335
Upgrading Software on Cisco ASR 1001-X Router, Cisco ASR 1001-HX Router, Cisco ASR 1002-X Router, and Cisco ASR 1002-HX Router	336
Upgrading Software on Cisco ASR 1004 Router	337
Tracking Software Upgrade Process	339
Enable Auto Upgrade Using Install Command	340
Enable Auto Upgrade (Global Configuration)	340
Additional References for Software Upgrade Process Using install Commands	341
Feature Information for Software Upgrade Process Using install Commands	341

CHAPTER 10**Support for Security-Enhanced Linux 343**

Overview	343
Prerequisites for SELinux	343
Restrictions for SELinux	343
Information About SELinux	343
Supported Platforms	344
Configuring SELinux	344
Configuring SELinux (EXEC Mode)	345
Configuring SELinux (CONFIG Mode)	345
Examples for SELinux	345
SysLog Message Reference	346
Verifying SELinux Enablement	346
Troubleshooting SELinux	347

CHAPTER 11**Factory Reset 349**

- Feature Information for Factory Reset 349
- Information About Factory Reset 350
- Software and Hardware Support for Factory Reset 351
- Prerequisites for Performing Factory Reset 351
- Restrictions for Performing a Factory Reset 352
- When to Perform Factory Reset 352
- How to Perform a Factory Reset 352
- What Happens after a Factory Reset 353

CHAPTER 12**High Availability Overview 355**

- Finding Feature Information in This Module 355
- Contents 356
- Hardware Redundancy Overview on the Cisco ASR 1000 Series Routers 356
- Software Redundancy on the Cisco ASR 1000 Series Routers 357
 - Software Redundancy Overview 357
 - Second IOS Process on a Cisco ASR 1002-X, Cisco ASR 1002-HX or Cisco 1004 Router 358
 - Configuring two Cisco IOS process on one RP 359
 - Example 360
- Route Processor Redundancy 360
- Stateful Switchover 360
 - SSO-Aware Protocol and Applications 361
- IPsec Failover 361
- Bidirectional Forwarding Detection 361
- Additional References 362
- Feature Information for High Availability Overview 363

CHAPTER 13**Broadband Scalability and Performance 365**

- Finding Feature Information in This Module 365
- Contents 365
- PPP Sessions and L2TP Tunnel Scaling 365
 - Restrictions for PPP Sessions and L2TP Tunnel Scaling 366
- Configuring the Cisco ASR 1000 Series Router for High Scalability 366

Configuring Call Admission Control	367
Control Plane Policing	367
VPDN Group Session Limiting	367
PPPoE Session Limiting	368
Monitoring PPP Sessions Using the SNMP Management Tools	368
Configuring the Access Interface Input and Output Hold Queue	368
Configuring the keepalive Command	368
Scaling the L2TP Tunnel Configurations	369
Using the cisco avpair lcp interface config RADIUS Attribute	369
Enhancing the Scalability of Per-User Configurations	369
Setting the VRF and IP Unnumbered Interface Configurations in User Profiles	370
Setting the VRF and IP Unnumbered Interface Configurations in Virtual Interface Templates	370
Redefining User Profiles to Use the ip:vrf-id and ip:ip-unnumbered VSAs	370
Additional References	371
Feature Information for Broadband Scalability and Performance	372

CHAPTER 14
UniDirectional Link Detection (UDLD) Protocol 373

Finding Feature Information	373
Contents	373
Restrictions for the UDLD Protocol	373
Information About the UDLD Protocol	374
UDLD Overview	374
Configuring the UDLD Aggressive Mode	375
Default UDLD Configuration	375
How to Configure the UDLD Protocol	375
Enabling UDLD Globally	376
Enabling UDLD on Individual LAN Interfaces	376
Disabling UDLD on Fiber-Optic LAN Interfaces	377
Configuring the UDLD Probe Message Interval	378
Resetting the Disabled LAN Interfaces Manually	379
Resetting the Disabled LAN Interfaces Automatically	379
Debugging UDLD	380
Configuration Examples for UDLD Protocol	381
Example: Verifying a UDLD Configuration	381

Example: Verifying Information About Neighbors	381
Example: Displaying all the UDLD Interface Statuses	381
Additional References	382
Feature Information for Configuring UDLD on Cisco ASR 1000 Series Aggregation Services Routers	383

CHAPTER 15**Using the Management Ethernet Interface 385**

Finding Feature Information in This Module	385
Contents	385
Gigabit Ethernet Management Interface Overview	385
Gigabit Ethernet Port Numbering	386
IP Address Handling in ROMmon and the Management Ethernet Port	386
Gigabit Ethernet Management Interface VRF	387
Common Ethernet Management Tasks	387
Viewing the VRF Configuration	387
Viewing Detailed VRF Information for the Management Ethernet VRF	388
Setting a Default Route in the Management Ethernet Interface VRF	388
Setting the Management Ethernet IP Address	388
Telnetting over the Management Ethernet Interface	389
Pinging over the Management Ethernet Interface	389
Copy Using TFTP or FTP	389
NTP Server	389
SYSLOG Server	390
SNMP-Related Services	390
Domain Name Assignment	390
DNS service	390
RADIUS or TACACS+ Server	390
VTY lines with ACL	391
Additional References	391
Feature Information for Using the Management Ethernet Interface	392

CHAPTER 16**Network Synchronization Support 393**

Finding Feature Information	393
Contents	393

Prerequisites for Network Synchronization Support	394
Network Synchronization Overview	394
Features Supported on ASR 1000 Platforms	394
Synchronization Status Message and Ethernet Synchronization Messaging Channel	398
Synchronization Status Message	398
Ethernet Synchronization Messaging Channel	398
Clock Selection Algorithm	399
Restrictions for Network Synchronization	399
Configuring Network Synchronization	400
Configuring Clock Recovery from SyncE	400
Examples	402
Configuring Clock Recovery from a BITS Port	402
Configuring Clock Recovery with a BITS Port as an Input-Source	402
Configuring a SyncE Using the System-to-External Method	404
Configuring Clock Recovery with a BITS Port as an Output-Source	405
Configuring a SyncE Using the System-to-External Method	407
Configuring SyncE by Using the Line to External Feature	407
Managing Synchronization	409
Verifying the Network Synchronization Configuration	411
Troubleshooting the Network Synchronization Configuration	414
Additional References	416
Feature Information for Network Synchronization Support	417

CHAPTER 17**IEEE 1588v2 PTP Support 419**

Restrictions for IEEE 1588v2 PTP	419
Information About IEEE 1588v2 PTP	419
PTP Clocks	420
Components of a PTP-enabled Network	420
Clock-Synchronization Process	421
PTP Messages	422
PTP Clocking Modes	422
PTP Accuracy	422
IEEE 1588v2 PTP Support	426
Configuring IEEE 1588v2 PTP	427

Configuring Input or Output Network Clocking	427
Configuring an Ordinary Clock	427
Configuring an Ordinary Clock as Primary PTP	427
Configuring an Ordinary Clock as Secondary PTP	429
Configuring a Boundary Clock	430
Examples	432
Configuring Time of Day	432
Configuring Input Time-of-Day Messages	432
Configuring Output Time-of-Day Messages	434
Configuration Examples for IEEE 1588v2 PTP on a Cisco ASR1002-X Router	436
Verifying the IEEE 1588v2 PTP Configuration	437
Additional References	438
Feature Information for IEEE 1588v2 PTP Support	438

CHAPTER 18

Configuring Bridge Domain Interfaces	441
Restrictions for Bridge Domain Interfaces	441
Information About Bridge Domain Interface	442
Ethernet Virtual Circuit Overview	442
Bridge Domain Interface Encapsulation	443
Assigning a MAC Address	443
Support for IP Protocols	444
Support for IP Forwarding	444
Packet Forwarding	444
Layer 2 to Layer 3	444
Layer 3 to Layer 2	445
Link States of a Bridge Domain and a Bridge Domain Interface	445
BDI Initial State	445
BDI Link State	445
Bridge Domain Interface Statistics	446
Creating or Deleting a Bridge Domain Interface	446
Bridge Domain Interface Scalability	446
Bridge-Domain Virtual IP Interface	447
How to Configure a Bridge Domain Interface	447
Example	449

Displaying and Verifying Bridge Domain Interface Configuration	449
Configuring Bridge-Domain Virtual IP Interface	451
Associating VIF Interface with a Bridge Domain	451
Verifying Bridge-Domain Virtual IP Interface	451
Example Configuration Bridge-Domain Virtual IP Interface	451
Configuring Flexible NetFlow over a Bridge Domain Virtual IP Interface	452
Examples: Flexible NetFlow over a Bridge Domain Virtual IP Interface	453
Additional References	457
Feature Information for Configuring Bridge Domain Interfaces	457

CHAPTER 19	Enabling Support for Tunable DWDM-XFP-C	459
	Configuring the DWDM-XFP-C Module	462
	Verifying the ITU Configuration	463

CHAPTER 20	Monitoring and Maintaining Multilink Frame Relay	465
	Feature Overview	465
	Configuring Multilink Frame Relay	465
	Monitoring and Maintaining Frame Relay and Multilink Frame Relay	465
	Additional References	466
	Feature Information for Monitoring and Maintaining Multilink Frame Relay	467

CHAPTER 21	Configuring MPLS Layer 2 VPNs	469
	Overview of L2VPN Interworking	470
	L2VPN Interworking Modes	470
	Ethernet or Bridged Interworking	470
	IP or Routed Interworking	471
	Virtual Private LAN Services	472
	Reverse Layer 2 Gateway Protocol	472
	BPDUs Sent Out of R-L2GP Ports	473
	BPDUs Received on R-L2GP Ports	474
	BPDUs Received on L2 Protocol Forwarding PW	474
	Restrictions for R-L2GP	474
	Configuring the R-L2GP	474
	Configuring the MST	474

Configuring an R-L2GP Instance	475
Attaching an R-L2GP Instance to a Port	476
Example: Configuring an R-L2GP	477
Configuring the Layer 2 Protocol Forwarding Virtual Private LAN Services Pseudowire Between Two Redundant NPES	478
Verifying an R-L2GP Configuration	479
Prerequisites for Frame Relay DLCI-to-ATM AAL5SNAP Bridged Interworking	479
Frame Relay DLCI-to-ATM AAL5SNAP Bridged Interworking	479
Configuring Frame Relay DLCI-to-ATM AAL5SNAP Bridged Interworking	481
Example: Frame Relay-to-ATM Bridged Interworking on an ATM-PE Router	485
Example: Frame Relay-to-ATM Bridged Interworking on a Frame Relay-PE Router	486
Gigabit EtherChannel for Virtual Private Wire Service	487
Supported Modes	487
GEC Like-to-Like Mode	487
Any-to-GEC Mode	487
Restrictions for Gigabit EtherChannel for Virtual Private Wire Service	488
Configuring Gigabit EtherChannel for Virtual Private Wire Service	488
EtherChannel-to-EtherChannel over MPLS (Bridged) Interworking	488
EtherChannel-to-EtherChannel over MPLS (Routed) Interworking	491
Example: GEC Like-to-Like (Routed) Interworking	493
Any-to-EtherChannel over MPLS (Bridged) Interworking	493
Any-to-EtherChannel over MPLS (Routed) Interworking	495
High-Level Data Link Control-Ethernet Interworking	499
Prerequisites for HDLC-Ethernet Interworking	499
Restrictions for HDLC-Ethernet Interworking	500
Configuring HDLC-Ethernet Interworking	500
Bridge Mode	500
On the HDLC-PE	500
On the Ethernet PE	501
On the HDLC-PE	503
On the Ethernet PE	504
Routed Mode	505
On HDLC-PE	505
On Ethernet PE	506

On HDLC-PE	508
On Ethernet PE	508
Example: HDLC-Ethernet Interworking Configuration	509
Example: Different Forms of Protocol-Based CLI Configuration	509
Example: Verifying the Configuration for HDLC-Ethernet Interworking	515
Example: HDLC-Dot1Q Interworking	525
Additional References	526
Technical Assistance	528
Feature Information for Configuring MPLS Layer 2 VPNs	528
Glossary	530

CHAPTER 22**EVPN VPWS over SR-TE Preferred Path 531**

Feature Information for EVPN VPWS over SR-TE Preferred Path	531
Restrictions for EVPN VPWS over SR-TE Preferred Path	531
Information About EVPN VPWS over SR-TE Preferred Path	532
How to Configure EVPN VPWS over SR-TE Preferred Path	532
Configuring EVPN VPWS over SR-TE Preferred Path	532
Configuring EVPN VPWS over SR-TE Preferred Path with Fallback Disable	533
Removing Fallback Disable from EVPN VPWS over SR-TE Preferred Path	533
Disabling EVPN VPWS over SR-TE Preferred Path Configuration	533
Verifying EVPN VPWS over SR-TE Preferred Path	533

CHAPTER 23**Enabling Management by REST API 535**

Introduction	535
Overview of Installation	535
Enabling REST API Support Using the Cisco IOS XE CLI	536
Configuring the Data Plane Dual Management Interface to Support the REST API	536
Configuration Notes	536
Configuring the Management Plane Dual Management Interface to Support the REST API	540
Configuration Notes	540
Configuring the REST API Local Port and AutoSave Options	544
Configuring onep	544
Disabling REST API Support	545
Viewing the REST API Container Status	546

CHAPTER 24

LSM-MLDP-based MVPN Support	547
Restrictions and Usage Guidelines	547
Configuring LSM-MLDP-based MVPN Support	548
Configuring MLDP MVPN Intranet Services	549
Example	552
Verification	552
Configuring MLDP MVPN for Extranet Services	554
Configuring MLDP MVPN for Extranet using SSC	554
Configuring MLDP MVPN for Extranet using SSC	557
Example	559
Configuring MLDP MVPN for Extranet Services using RSC	560
Configuring MLDP MVPN for Extranet Services using RSC	562
Example	564
Configuring MLDP TE-FRR Support	565
Configuring MLDP with PIM-based MVPN	566
MLDP Support with Load Balancing	566
Root Node Redundancy	566
Verification	566
Sample Configuration for MLDP MVPN	576
Configuration Example Using SSM Mode	576
MLDP MVPN Extranet SSC	576
MLDP MVPN Extranet RSC	581
MLDP MVPN Intranet	587
Configuration Example Using SM Mode	591
MLDP MVPN Extranet SSC	592
MLDP MVPN Extranet RSC	597
MLDP MVPN Intranet	602
Troubleshooting LSM MLDP based MVPN Support	607
MVPN MLDP over GRE	608
Prerequisites for MVPN MLDP over GRE	608
Restrictions for MVPN MLDP over GRE	608
Configuring MVPN MLDP over GRE	609
Example: Configuring MVPN MLDP over GRE	614

CHAPTER 25	Tracing and Trace Management	621
	Tracing Overview	621
	How Tracing Works	621
	Tracing Levels	622
	Viewing a Tracing Level	623
	Setting a Tracing Level	624
	Viewing the Content of the Trace Buffer	625

CHAPTER 26	Packet Trace	627
	Information About Packet Trace	627
	Usage Guidelines for Configuring Packet Trace	628
	Configuring Packet Trace	628
	Configuring Packet Tracer with UDF Offset	630
	Displaying Packet-Trace Information	633
	Removing Packet-Trace Data	634
	Configuration Examples for Packet Trace	634
	Example: Configuring Packet Trace	634
	Example: Using Packet Trace	636
	Additional References	641
	Feature Information for Packet Trace	642

CHAPTER 27	Packet Drops	645
	Information About Packet Drops	645
	Viewing Packet Drop Information	646
	Verifying Packet Information	647
	Packet Drops Warnings	648
	Configuring Packet Drops Warning Thresholds	649
	Viewing Packet Drops Warning Thresholds	650
	Feature Information for Packet Drops	651

CHAPTER 28	Configuring and Accessing the Web User Interface	653
	Web User Interface Overview	653
	Web User Interface General Overview	653

Legacy Web User Interface Overview	654
Graphics-Based Web User Interface Overview	655
Persistent Web User Interface Transport Maps Overview	656
Configuring the Router for Web User Interface Access	657
Authentication and the Web User Interface	659
Domain Name System and the Web User Interface	659
Clocks and the Web User Interface	660
Accessing the Web User Interface	660
Using Auto Refresh	661
Web User Interface Tips and Tricks	662
Configuring Web User Interface in Cisco IOS XE 16 Releases	663
Web User Interface	663
Setting Up Factory Default Device Using WebUI	663
Using Basic or Advanced Mode Setup Wizard	664

CHAPTER 29**PPP Half-Bridge on the Cisco ASR 1000 Series Routers 669**

Prerequisites for PPP Half-Bridge on the Cisco ASR 1000 Series Routers	669
Information About PPP Half-Bridge on the Cisco ASR 1000 Series Routers	670
PPP Half-Bridge Supported Features	670
Configuration Examples for PPP Half-Bridge	671
Example: Configuring PPP Half-Bridge on the Cisco ASR 1000 Series Routers	671
Example: Configuring PPP Full-Bridge on the Cisco 7206 Routers	671
Verifying PPP Half-Bridge	671
Debugging PPP Half-Bridge	672
Additional References	673
Feature Information for PPP Half-Bridge on the Cisco ASR 1000 Series Routers	674

CHAPTER 30**Cisco ASR 1000 Embedded Services Processor 10G Non Crypto Capable New Feature 675**

Information About Cisco ASR 1000 ESP 10G Non Crypto Capable New Feature	675
Checking the ESP Board	676
Additional References	676

CHAPTER 31**Ethernet Virtual Connections on Port Channels 679**

Information About Ethernet Virtual Connections on Port Channels	679
---	-----

Usage Guidelines for Configuring an EVC on a Port Channel	679
Quality of Service Support	680
Configuring a Basic EVC Port Channel	680
Configuring a Port Channel Interface with ethernet Service Instances	680
Adding a Port Channel Ethernet Flow Point to a Bridge Domain	682
Adding an Ethernet Port to the Port Channel Interface	682
Load Balancing the EVCs on Port Channels	683
Enabling Flow Based Load Balancing on a Port Channel	684
Configuring Flow Based Load Balancing	685
VLAN-Based Manual Load Balancing	686
Configuring VLAN Based Manual Load Balancing	686
Example: Ethernet Virtual Connections on Port Channels	690
Configuring LACP	691
691	
Configuring the LACP Mode per Port Channel Interface	691
VLAN Manual Load Balancing on Q-in-Q Interfaces	692
Prerequisites for VLAN Manual Load Balancing on Q-in-Q Interfaces	692
Restrictions for VLAN Manual Load Balancing on Q-in-Q Interfaces	692
Information About VLAN Manual Load Balancing on Q-in-Q Interfaces	693
Configure VLAN Manual Load Balancing on Q-in-Q Interfaces	693
Verify VLAN Manual Load Balancing on Q-in-Q Interfaces	694

CHAPTER 32**Configuring Traffic Storm Control 697**

Understanding Traffic Storm Control	697
Prerequisites for Configuring Traffic Storm Control	697
Configuring Traffic Storm Control	697
Examples	699
Example: Configuring a Traffic Storm Control CIR	700

CHAPTER 33**Cisco Thousand Eyes Enterprise Agent Application Hosting 701**

Cisco ThousandEyes Enterprise Agent Application Hosting	701
Feature Information for Cisco ThousandEyes Enterprise Agent Application Hosting	702
Supported Platforms and System Requirements	702
Workflow to Install and Run the Cisco ThousandEyes Application	703

Workflow to Host the Cisco ThousandEyes Application	703
Downloading and Copying the Image to the Device	705
Connecting the Cisco ThousandEyes Agent with the Controller	706
Modifying the Agent Parameters	707
Uninstalling the Application	707
Troubleshooting the Cisco ThousandEyes Application	707

CHAPTER 34**Online Diagnostics 709**

Scheduling Online Diagnostics	709
Configuring Health-Monitoring Diagnostics	709
Generic Online Diagnostic Commands	709
Generic Online Diagnostic EXEC Commands	710
Generic Online Diagnostic Show commands	710
Generic Online Diagnostic Example	710
Health Monitoring Diagnostics Configuration Example	712
Slot and Subslot Level Show Commands Output Example	715

CHAPTER 35**Unsupported Commands 727**

Unsupported Commands in Cisco ASR 1000 Series Routers	727
---	-----

CHAPTER 36**Configuration Examples 731**

Configuring the Router to Boot the Consolidated Package on the TFTP Server	731
Copying the Consolidated Package from the TFTP Server to the Router	734
Configuring the Router to Boot Using the Consolidated Package Stored on the Router	735
Extracting the SubPackages from a Consolidated Package into the Same File System	736
Extracting the SubPackages from a Consolidated Package into a Different File System	737
Configuring the Router to Boot Using the SubPackages	738
Backing Up Configuration Files	741
Copying a Startup Configuration File to Bootflash	741
Copying a Startup Configuration File to an USB Flash Disk	742
Copying a Startup Configuration File to a TFTP Server	742
Enabling a Second IOS Process on a Single RP Using SSO	742
ISSU—Consolidated Package Upgrade	746



CHAPTER 1

Preface

This preface describes the objectives and organization of this document and explains how to find additional information on related products and services.

- [Objectives, on page 1](#)
- [Document Revision History, on page 1](#)
- [Organization, on page 6](#)
- [Related Documentation, on page 8](#)
- [Document Conventions, on page 8](#)
- [Communications, Services, and Additional Information, on page 10](#)

Objectives

This document provides an overview of software functionality that is specific to the Cisco ASR 1000 Series Aggregation Services Routers. It is not intended as a comprehensive guide to all of the software features that can be run using the Cisco ASR 1000 Series Routers, but only the software aspects that are specific to these routers.

For information on general software features that are also available on the Cisco ASR 1000 Series Routers, see the Cisco IOS XE technology guide for that specific software feature.

Document Revision History

The Document Revision History records technical changes to this document. The table shows the Cisco IOS XE software release number and document revision number for the change, the date of the change, and a brief summary of the change.

Release No.	Date	Change Summary
Cisco IOS Denali 16.2.1	March 31, 2016	Added <i>Read Me First</i> chapter.
IOS XE 3.13.1	December 12, 2014	Added <i>PPP Half-Bridge on the Cisco ASR 1000 Series Routers</i> chapter.

Release No.	Date	Change Summary
IOS XE 3.13	July 30, 2014	Added new content to document IEEE 1588v2 PTP Support in the <i>IEEE 1588v2 PTP Support</i> chapter. Added HDLC-Ethernet Interworking feature updates in the “ <i>High-Level Data Link Control-Ethernet Interworking</i> ” section of the <i>Configuring MPLS Layer 2 VPNs</i>
IOS XE 3.12	March 28, 2014	Added Multi Member-link MLPPPoA or MLPPPoEoA feature updates in the “ <i>Cisco IOS XE Scaling Limits for MLP Bundles</i> ” section of the <i>Multilink PPP Support for the Cisco ASR 1000 Series Routers</i> chapter.
IOS XE 3.12	March 28, 2014	Added Minimal Disruptive Restart Phase 3 feature updates in the <i>Software Upgrade Processes Supported by Cisco ASR 1000 Series Routers</i> chapter.
IOS XE 3.12	March 28, 2014	Added MVPNv6 support for the MVPN MLDP over GRE feature in the <i>LSM-MLDP-based MVPN Support</i> chapter.
IOS XE 3.11.0	November 21, 2013	Added MVPNv4 support for the MVPN MLDP over GRE feature in the <i>LSM-MLDP-based MVPN Support</i> chapter.
IOS XE 3.10.0	July 30, 2013	Added <i>Packet Trace</i> chapter.
IOS XE 3.9.0	March 28, 2013	Added new content to document UniDirectional Link Detection (UDLD) Protocol in the <i>UniDirectional Link Detection (UDLD) Protocol</i> chapter.
IOS XE 3.8.0	November 28, 2012	Added Minimal Disruptive Restart Process section in the <i>Software Upgrade Processes Supported by Cisco ASR 1000 Series Routers</i> chapter.

Release No.	Date	Change Summary
IOS XE 3.7.0	July 25, 2012	<p>Added new content to the Synchronous Ethernet in the <i>Network Synchronization Support</i> chapter.</p> <p>Added new content to document the Walk-by User Support for PWLAN in ISG in the <i>Broadband Scalability and Performance</i> chapter.</p> <p>Added new content to the bridge domain interface configurations in the <i>Configuring Bridge Domain Interfaces</i> chapter.</p>
IOS XE 3.6.0	March 30, 2012	<p>Added new content to document the Frame Relay to ATM Bridged Interworking in the <i>Configuring MPLS Layer 2 VPNs</i> chapter.</p> <p>Added new content to document the xconnect support on GEC (VPWS) on ASR1000 in the <i>Configuring MPLS Layer 2 VPNs</i> chapter.</p>
IOS XE 3.4.0S	July 25, 2011	<p>Added new content to document the Monitoring and Maintaining Multilink Frame Relay feature in the <i>Monitoring and Maintaining Multilink Frame Relay</i> chapter.</p> <p>Added new content to document In Service One-Shot Software Upgrade Procedure in the <i>Software Upgrade Processes Supported by Cisco ASR 1000 Series Routers</i> chapter.</p>

Release No.	Date	Change Summary
IOS XE 3.3.0S	March 30, 2011	<p>Added new content to document the Scalability and Performance in the <i>Broadband Scalability and Performance</i> chapter.</p> <p>Added software upgrade information for ASR 1001 chassis in the “<i>Using Subpackages for Software Upgrade on a Cisco ASR 1001 Router, Cisco ASR 1001-X Router or a Cisco ASR 1002-X Router</i>” section in <i>Software Upgrade Processes Supported by Cisco ASR 1000 Series Routers</i> chapter.</p>
IOS XE 3.2.0S	November 24, 2010	<p>Added new content to document bridge domain interface configurations in the <i>Configuring Bridge Domain Interfaces</i> chapter.</p> <p>Added new content to document the Synchronous Ethernet in the <i>Network Synchronization Support</i> chapter.</p>
IOS XE 3.1.0S	July 30, 2010	<p>Added upgrade and file package information in the <i>Software Packaging and Architecture</i> chapter.</p> <p>Added restriction regarding ISSU support in Cisco IOS XE Release 3.1S in <i>Software Upgrade Processes Supported by Cisco ASR 1000 Series Routers</i> chapter.</p>
IOS XE 2.6	February 26, 2010	<p>Moved the ISSU compatibility tables into the Release Notes for Cisco ASR 1000 Series Aggregation Services Routers document.</p> <p>Relocated other ISSU compatibility information into the <i>Software Upgrade Processes Supported by Cisco ASR 1000 Series Routers</i> chapter.</p>

Release No.	Date	Change Summary
IOS XE 2.5	December 15, 2009	Updated the <i>Software Upgrade Processes Supported by Cisco ASR 1000 Series Routers</i> chapter with new compatibility information.
IOS XE 2.4	June 30, 2009	Updated the <i>Software Upgrade Processes Supported by Cisco ASR 1000 Series Routers</i> chapter with new compatibility information. Updated book with installation information for the new optional subpackage for the Cisco WebEx Node for ASR 1000 Series.
IOS XE 2.3	February 27, 2009	Updated the <i>Software Upgrade Processes Supported by Cisco ASR 1000 Series Routers</i> chapter with new compatibility information.
IOS XE 2.2	November 20, 2008	Updated the <i>Software Upgrade Processes Supported by Cisco ASR 1000 Series Routers</i> chapter with new compatibility information.
IOS XE 2.2	November 3, 2008	Added new content to document compatibility of different versions of Cisco IOS XE software in the <i>Software Upgrade Processes Supported by Cisco ASR 1000 Series Routers</i> chapter.
IOS XE 2.2	October 3, 2008	Updated book to document ISSU procedures for Cisco IOS XE Release 2.2. Removed ISSU procedures from the <i>Consolidated Packages and SubPackage Management</i> chapter of the book and created the <i>Software Upgrade Processes Supported by Cisco ASR 1000 Series Routers</i> chapter.
IOS XE 2.2	September 23, 2008	Added the “ <i>Troubleshooting Software Mismatch with ESP Board ASR1000-ESP10-N</i> ” section for the Cisco ASR 1000 Embedded Services Processor 10G Non Crypto Capable feature.

Release No.	Date	Change Summary
IOS XE 2.1	July 2, 2008	Added the <i>Configuring and Accessing the Web User Interface</i> section. Added Appendix <i>Configuration Examples</i> .
IOS XE 2.1	May 2, 2008	First release of the book.

Organization

This document contains the following chapters:

Title	Description
Read Me First	Provides information that is pertinent to Cisco ASR 1000 Series Routers in Cisco IOS XE Denali 16.2.1.
Software Packaging and Architecture	Provides an introduction to Cisco ASR 1000 Series Routers software packaging, processes, and file systems.
Using Cisco IOS XE Software	Provides an introduction to accessing the command-line interface (CLI) and using the Cisco software and related tools.
Console Port, Telnet, and SSH Handling	Provides an overview and configuration options for the handling of incoming console port, telnet, and SSH traffic on the Cisco ASR 1000 Series Routers.
Consolidated Packages and SubPackage Management	Provides information on downloading, installing, and running the software on the Cisco ASR 1000 Series Routers.
Software Upgrade Process	Provides information on ISSU compatibility and performing limited-downtime software upgrades on the Cisco ASR 1000 Series Routers.
High Availability Overview	Provides an overview of the High Availability architecture, behavior, and features on the Cisco ASR 1000 Series Routers.
Scalability and Performance	Provides information on scaling and performance on the Cisco ASR 1000 Series Routers.
Cisco License Call Home	Provides information on activating the Cisco License for Call Home feature.

Title	Description
Configuring Call Home for Cisco ASR 1000 Series Aggregation Services Routers	Provides information about the Call Home feature, which supports e-mail-based and web-based notification of critical system events. A versatile range of message formats are available for optimal compatibility with pager services, standard e-mail, or XML-based automated parsing applications.
Configuring Cisco Right-To-Use License	Provides information on activating the Cisco Right-To-Use License.
UniDirectional Link Detection (UDLD) Protocol	Provides an overview and configuration options for the UDLD protocol on the Cisco ASR 1000 Series Routers.
Using the Management Ethernet Interface	Provides an overview and configuration options for the Management Ethernet interface on the Cisco ASR 1000 Series Routers.
Synchronous Ethernet Support On The Cisco ASR 1000 Series Routers	Provides an overview and configuration options for the Synchronous Ethernet on the Cisco ASR 1000 Series Routers.
Configuring Ethernet Over Soft GRE	Provides an overview and configuration for the Generic Routing Encapsulation (GRE) is a tunneling protocol that can encapsulate a wide variety of network layer protocols inside virtual point-to-point links over an IP internetwork.
Configuring Bridge Domain Interfaces	Provides an overview of configuration options for the Bridge Domain Interface on the Cisco ASR 1000 Series Routers.
Monitoring and Maintaining Multilink Frame Relay	Provides an overview of monitoring and maintaining the Multilink Frame Relay feature for the Cisco ASR 1000 Series Routers.
Configuring MPLS Layer 2 VPNs	Provides an overview of the Frame Relay to ATM Bridged Interworking feature.
LSM-MLDP-based MVPN Support	Provides information on the Label Switched Multicast (LSM) feature supports IPv4 and IPv6 multicast traffic over a Multi-Protocol Label Switching (MPLS) network.
Tracing and Trace Management	Provides an overview of tracing on the Cisco ASR 1000 Series Router, and how to manage the tracing process and files.
PPP Half-Bridge on the Cisco ASR 1000 Series Routers	Provides information about PPP half-bridge on the Cisco ASR 1000 Series Routers.

Title	Description
Configuring and Accessing the Web User Interface	Provides an overview of the Cisco ASR 1000 Series Router web user interface, and information on configuring and accessing the web user interface.

Related Documentation

This section refers you to other documentation that also might be useful as you configure your Cisco ASR 1000 Series Router. The documentation listed below is available online.

Cisco ASR 1000 Series Routers Documentation

- The Cisco ASR 1000 Series has a documentation roadmap that provides listings to a broad range of documentation available for the Cisco ASR 1000 Series Routers. See the Cisco ASR 1000 Series Router Documentation Roadmap at: http://cisco.com/en/US/products/ps9343/products_documentation_roadmaps_list.html
- The documentation homepage for the Cisco ASR 1000 Series Routers contains a wide variety of hardware and software information for the Cisco ASR 1000 Series Routers and can be viewed at: http://cisco.com/en/US/products/ps9343/tsd_products_support_series_home.html
- The documentation homepage for Cisco IOS XE contains Cisco IOS XE technology guides and feature documentation and can be viewed at: http://cisco.com/en/US/products/ps9587/tsd_products_support_series_home.html
- For information on commands, see the following: <http://www.cisco.com/c/en/us/support/ios-nx-os-software/ios-xe-3s/products-command-reference-list.html>

Document Conventions

Within the SIP and SPA software configuration guides, the term router is generally used to refer to a variety of Cisco products (for example, routers, access servers, and switches). Routers, access servers, and other networking devices that support Cisco IOS software are shown interchangeably within examples. These products are used only for illustrative purposes; that is, an example that shows one product does not necessarily indicate that other products are not supported.

This document uses the following conventions:

Convention	Description
^ or Ctrl	Both the ^ symbol and Ctrl represent the Control (Ctrl) key on a keyboard. For example, the key combination ^D or Ctrl-D means that you hold down the Control key while you press the D key. (Keys are indicated in capital letters but are not case sensitive.)
bold font	Commands and keywords and user-entered text appear in bold font .
<i>Italic font</i>	Document titles, new or emphasized terms, and arguments for which you supply values are in <i>italic font</i> .

Convention	Description
<code>Courier font</code>	Terminal sessions and information the system displays appear in <code>courier</code> font.
Bold Courier font	Bold Courier font indicates text that the user must enter.
[x]	Elements in square brackets are optional.
...	An ellipsis (three consecutive nonbolded periods without spaces) after a syntax element indicates that the element can be repeated.
	A vertical line, called a pipe, indicates a choice within a set of keywords or arguments.
[x y]	Optional alternative keywords are grouped in brackets and separated by vertical bars.
{x y}	Required alternative keywords are grouped in braces and separated by vertical bars.
[x {y z}]	Nested set of square brackets or braces indicate optional or required choices within optional or required elements. Braces and a vertical bar within square brackets indicate a required choice within an optional element.
string	A nonquoted set of characters. Do not use quotation marks around the string or the string will include the quotation marks.
<>	Nonprinting characters such as passwords are in angle brackets.
[]	Default responses to system prompts are in square brackets.
!, #	An exclamation point (!) or a pound sign (#) at the beginning of a line of code indicates a comment line.

Reader Alert Conventions

This document uses the following conventions for reader alerts:



Note Means *reader take note*. Notes contain helpful suggestions or references to material not covered in the manual.



Tip Means *the following information will help you solve a problem*.



Caution Means *reader be careful*. In this situation, you might do something that could result in equipment damage or loss of data.

**Timesaver**

Means *the described action saves time*. You can save time by performing the action described in the paragraph.

**Warning**

Means *reader be warned*. In this situation, you might perform an action that could result in bodily injury.

Communications, Services, and Additional Information

- To receive timely, relevant information from Cisco, sign up at [Cisco Profile Manager](#).
- To get the business impact you're looking for with the technologies that matter, visit [Cisco Services](#).
- To submit a service request, visit [Cisco Support](#).
- To discover and browse secure, validated enterprise-class apps, products, solutions and services, visit [Cisco DevNet](#).
- To obtain general networking, training, and certification titles, visit [Cisco Press](#).
- To find warranty information for a specific product or product family, access [Cisco Warranty Finder](#).

Cisco Bug Search Tool

[Cisco Bug Search Tool](#) (BST) is a web-based tool that acts as a gateway to the Cisco bug tracking system that maintains a comprehensive list of defects and vulnerabilities in Cisco products and software. BST provides you with detailed defect information about your products and software.



CHAPTER 2

Read Me First

Important Information



Note For CUBE feature support information in Cisco IOS XE Bengaluru 17.6.1a and later releases, see [Cisco Unified Border Element IOS-XE Configuration Guide](#).



Note The documentation set for this product strives to use bias-free language. For purposes of this documentation set, bias-free is defined as language that does not imply discrimination based on age, disability, gender, racial identity, ethnic identity, sexual orientation, socioeconomic status, and intersectionality. Exceptions may be present in the documentation due to language that is hardcoded in the user interfaces of the product software, language used based on RFP documentation, or language that is used by a referenced third-party product.

Feature Information

Use [Cisco Feature Navigator](#) to find information about feature support, platform support, and Cisco software image support. An account on Cisco.com is not required.

Related References

- [Cisco IOS Command References, All Releases](#)

Obtaining Documentation and Submitting a Service Request

- To receive timely, relevant information from Cisco, sign up at [Cisco Profile Manager](#).
- To get the business impact you're looking for with the technologies that matter, visit [Cisco Services](#).
- To submit a service request, visit [Cisco Support](#).
- To discover and browse secure, validated enterprise-class apps, products, solutions and services, visit [Cisco DevNet](#).
- To obtain general networking, training, and certification titles, visit [Cisco Press](#).
- To find warranty information for a specific product or product family, access [Cisco Warranty Finder](#).

- [Short Description, on page 12](#)

Short Description

Cisco and the Cisco logo are trademarks or registered trademarks of Cisco and/or its affiliates in the U.S. and other countries. To view a list of Cisco trademarks, go to this URL: <https://www.cisco.com/c/en/us/about/legal/trademarks.html>. Third-party trademarks mentioned are the property of their respective owners. The use of the word partner does not imply a partnership relationship between Cisco and any other company. (1721R)



CHAPTER 3

Software Packaging and Architecture

The Cisco ASR 1000 Series Aggregation Services Routers introduce a new software packaging model and architecture.

This chapter discusses this new packaging and architecture and contains the following sections:

- [Software Packaging on the Cisco ASR 1000 Series Routers, on page 13](#)
- [Image Signing and Bootup, on page 17](#)
- [Processes Overview, on page 19](#)

Software Packaging on the Cisco ASR 1000 Series Routers

This section covers the following topics:

ASR 1000 Series Routers Software Overview

The Cisco ASR 1000 Series Routers run using Cisco IOS XE software. Cisco IOS XE is released using consolidated packages and optional subpackages.

Each consolidated package contains a collection of software subpackages. Each software subpackage is an individual software file that controls a different element or elements of the Cisco ASR 1000 Series Router. Each individual software subpackage can be upgraded individually, or all software subpackages for a specific consolidated package can be upgraded as part of a complete consolidated package upgrade. Importantly, IOS (the RPIOS subpackage) is considered one of the seven individual subpackages that makes up a complete consolidated package.

A collection of software subpackages packaged together creates a single consolidated package. A consolidated package allows users to upgrade all individual subpackages on the router with a single software image download. Consolidated packages can be downloaded from Cisco.com; users who want to run the router using individual subpackages that are part of the consolidated package must first download the image from Cisco.com and extract the individual subpackages from the image, which can be done by entering **request platform** command-line interface commands.

Beginning in Cisco IOS XE Release 2.4, support for a supplemental, optional subpackage of type called *sipspawma* is introduced to support the Cisco WebEx Node for ASR 1000 Series shared port adapter (SPA). Optional subpackages are installed similarly to individual subpackages; however, optional subpackages are not bundled as part of a consolidated package like prior support for the individual subpackages, and optional subpackages must be downloaded independently.

Consolidated Packages

A consolidated package is a single image composed of individual software subpackage files. A single consolidated package file is a bootable file, and the Cisco ASR 1000 Series Router can be run using the consolidated package.



Note Consolidated packages only contain the required individual subpackage files. These packages do not contain supplemental, optional subpackages, such as the “sipspawma” package for the Cisco WebEx Node for ASR 1000 Series.

Each consolidated package also contains a provisioning file. A provisioning file is used for booting in cases where the individual subpackages are extracted from the consolidated package, or optional subpackages are used to run the router. For additional information on the advantages and disadvantages of running a complete consolidated package, see the [“Running the Cisco ASR 1000 Series Routers: An Overview” section on page 5-1](#).

For information about the consolidated packages available in a specific version of Cisco IOS XE, see the release notes for that version of Cisco IOS XE. The [Cisco IOS XE Software Release Notes](#) contains the release notes for each version of Cisco IOS XE.

Important Information About Consolidated Packages

The important information about consolidated packages include:

- For each version of a consolidated package, the RPBase, RPControl, ESPBase, SIPSPA, and SIPBase subpackages are identical among consolidated packages.
- For each version of consolidated package, the RPIOS subpackage is always different among consolidated packages.
- A consolidated package file is a bootable file. If the router is configured to run using a the complete consolidated package, boot the router using the consolidated package file. If the router is configured to run using individual subpackages, boot the router using the provisioning file. For additional information on the advantages and disadvantages of running a complete consolidated package, see the [“Running the Cisco ASR 1000 Series Routers: An Overview” section on page 5-1](#).
- If you need to install optional subpackages, then you must boot the router using the individual subpackage provisioning file method.

Individual Software SubPackages Within a Consolidated Package

This section provides an overview of the Cisco ASR 1000 Series Routers subpackages and the purpose of each individual subpackage. Every consolidated package will have all of these individual subpackages. To see additional information about each individual subpackages in a particular Cisco IOS XE release, see *Cisco IOS XE Release Notes* for that release.

Table 1: Individual SubPackages

SubPackage	Purpose
RPBase	Provides the operating system software for the Route Processor.

SubPackage	Purpose
RPCControl	Controls the control plane processes that interface between the IOS process and the rest of the platform.
RPAccess	Exports processing of restricted components, such as Secure Socket Layer (SSL), Secure Shell (SSH), and other security features.
RPIOS	Provides the Cisco IOS kernel, which is where IOS features are stored and run. Each consolidated package has a different RPIOS.
ESPBase	Provides the ESP operating system and control processes, and the ESP software.
SIPBase	Controls the SIP operating system and control processes.
SIPSPA	Provides the SPA driver and Field Programmable Device (FPD) images.

Important Notes About Individual SubPackages

The important information about individual subpackage include:

- Individual subpackages cannot be downloaded from Cisco.com individually. To get these individual subpackages, users must download a consolidated package and then extract the individual subpackages from the consolidated package using the command-line interface.
- If the router is being run using individual subpackages instead of being run using a complete consolidated package, the router must be booted using a provisioning file. A provisioning file is included in all consolidated packages and is extracted from the image along with the individual subpackages whenever individual subpackages are extracted.

Optional Software SubPackages Outside of Consolidated Packages

Beginning in Cisco IOS XE Release 2.4, the ASR 1000 Series Routers support a new type of subpackage—this is an optional software subpackage that is available as a separate, external package that is downloaded and installed along with the other required subpackages.

sipspawmak9 is an optional subpackage that provides the system software for the Cisco WebEx Node for ASR 1000 Series Routers.

Important Notes About Optional SubPackages

The important information about optional subpackages include:

- Optional subpackages are downloaded separately from consolidated package files. Optional subpackages are not contained within a consolidated package for a release.
- Optional package installation works similarly to the installation of individual subpackages using a provisioning file.
- Optional subpackages can be uninstalled to remove provisioning when the package no longer applies to an RP.
- Optional subpackages are easily supported by the standard ISSU upgrade process as long as the package is located in the directory of the provisioning file for each RP.

Provisioning Files



Note You must use the provisioning files to manage the boot process if you need to install optional subpackages.

Provisioning files manage the boot process when the Cisco ASR 1000 Series Router is configured to run using individual subpackages or optional subpackages (such as the package for the Cisco WebEx Node for ASR 1000 Series). When individual subpackages are being used to run the Cisco ASR 1000 Series Router, the router has to be configured to boot the provisioning file. The provisioning file manages the bootup of each individual subpackage and the Cisco ASR 1000 Series Router assumes normal operation.

Provisioning files are extracted automatically when individual subpackage files are extracted from a consolidated package.

Provisioning files are not necessary for running the router using the complete consolidated package; if you want to run the router using the complete consolidated package, simply boot the router using the consolidated package file.

See the [“Running the Cisco ASR 1000 Series Routers: An Overview” section on page 5-1](#) for additional information on the advantages and disadvantages of running individual subpackages versus running a complete consolidated package.

Important Notes About Provisioning Files

The important information about provisioning files include:

- Each consolidated package contains two provisioning files. One of the provisioning files is always named “packages.conf”, while the other provisioning file will have a name based on the consolidated package naming structure. In any consolidated package, both provisioning files perform the exact same function.
- In most cases, the “packages.conf” provisioning file should be used to boot the router. Configuring the router to boot using this file is generally easier because the router can be configured to boot using “packages.conf”, so no changes have to be made to the boot statement when Cisco IOS XE is upgraded (the **boot system file-system:packages.conf** configuration command can remain unmodified before and after an upgrade).
- The provisioning file and individual subpackage files must be kept in the same directory. The provisioning file does not work properly if the individual subpackage files are in other directories.
- The provisioning filename can be renamed; the individual subpackage filenames cannot be renamed.
- After placing the provisioning file and the individual subpackage files in a directory and booting the router, it is highly advisable not to rename, delete, or alter any of these files. Renaming, deleting, or altering the files can lead to unpredictable router problems and behaviors.

ROMmon Image

An independent ROMmon image is released periodically separate from consolidated packages or any other software releases.

See the documentation that accompanies the ROMmon image for information on each ROMmon image. For additional information on ROMmon, see the *Cisco ASR 1000 Series Routers Maintain and Operate Guide*

File to Upgrade Field Programmable Hardware Devices

Starting in Cisco IOS XE Release 3.1.0S, a hardware programmable package file used to upgrade field programmable hardware devices is released as needed. A package file is provided for the field programmable device to customers in cases where a field upgrade is required. If the Cisco ASR 1000 Series Router contains an incompatible version of the hardware programmable firmware on the Cisco ASR1000-RP, Cisco ASR1000-SIP, or Cisco ASR1000-ESP, then that firmware may need to be upgraded.

Generally an upgrade is only necessary in cases where a system message indicates one of the field programmable devices on the Cisco ASR 1000 Series Router needs an upgrade or a Cisco technical support representative suggests an upgrade.

In Cisco IOS XE Release 3.1.0S, a package file that contains a new version of the Complex Programmable Logic Device (CPLD) code is available for users who need to upgrade old versions of firmware on a Cisco ASR1000-RP2 or Cisco ASR1000-SIP10 in a Cisco ASR 1013 Router.

For more information on upgrading field programmable hardware devices, see the *Upgrading Field Programmable Hardware Devices for Cisco ASR 1000 Series Routers* document.

Image Signing and Bootup

The Cisco build servers generate the Cisco IOS XE images. The Cisco IOS XE images use the Abraxas image signing system to sign these images securely with the Cisco private RSA keys.

When you copy the Cisco IOS XE image onto a Cisco ASR 1000 Series Router, the Cisco's ROMMON Boot ROM verifies the image using Cisco release keys. These keys are public keys that correspond to the Cisco release private key that is stored securely on the Abraxas servers. The release key is stored in the ROMMON.

All the new Cisco ASR 1000 Series platforms support Cisco's Secure Boot technology. The Cisco Secure Boot technology serves as a hardware trust anchor which validates the ROMMON software to ensure that the ROMMON software is not tampered with.

The Cisco IOS XE image is digitally signed during the build time. An SHA-512 hash is generated over the entire binary image file, and then the hash is encrypted with a Cisco RSA 2048-bit private key. The ROMMON verifies the signature using the Cisco public key. If the software is not generated by a Cisco build system, the signature verification fails. The Cisco ASR 1000 Series ROMMON rejects the image and stops booting. If the signature verification is successfully, the Cisco ASR 1000 Series Router boots the image to the Cisco IOS XE runtime environment.

The ROMMON follows these steps when it verifies a signed Cisco IOS XE image during the boot up process:

1. Loads the Cisco IOS XE image into the CPU memory.
2. Examines the Cisco IOS XE package header.
3. Runs a non-secure integrity check on the image to ensure that there is no unintentional file corruption from the disk or TFTP. This is performed using a non-secure SHA-1 Hash.
4. Copies the Cisco's RSA 2048-bit public release key from the ROMMON storage and validates that the Cisco's RSA 2048-bit public release key is not tampered.
5. Extracts the Code Signing signature (SHA-512 Hash) from the package header and verifies it using Cisco's RSA 2048-bit public release key.
6. Performs the Code Signing validation by calculating the SHA-512 hash of the Cisco IOS XE package and compares it with the Code Signing signature. The Signed package is now validated.

7. Examines the Cisco IOS XE package header to validate the platform type and CPU architecture for compatibility.
8. Extracts the Cisco IOS XE software from the Cisco IOS XE package and boots it.



Note In above process, the step 3 is a non-secure check of the image which is intended to confirm the image against inadvertent corruption due to disk errors, file transfer errors, or copying errors. This is not part of the image code signing. This check is not intended to detect deliberate image tampering.

Image Code Signing validation occurs in steps 4, 5, and 6. This is a secure code signing check of the image using an SHA-512 Hash that is encrypted with a 2048-bit RSA key. This check is intended to detect deliberate image tampering.

During this process, the device displays the following:

```

Initializing Hardware ...
System integrity status: 90170400 12030107

System Bootstrap, Version 16.12(8r), RELEASE SOFTWARE
Copyright (c) 1994-2020 by cisco Systems, Inc.

Current image running: Boot ROM0
Last reset cause: LocalSoft

ASR1001-HX platform with 8388608 Kbytes of main memory

File size is 0x32e9b97c
Located asr1000-universalk9.17.01.01.SPA.bin
Image size 854178172 inode num 34, bks cnt 208540 blk size 8*512
#####
#####
##### <---- (*) STEP
1
Boot image size = 854178172 (0x32e9b97c) bytes <---- (*) STEP
1

ROM:RSA Self Test Passed
ROM:Sha512 Self Test Passed

Package header rev 1 structure detected <---- (*) STEP
2
Calculating SHA-1 hash...done <---- (*) STEP
3
validate_package_cs: SHA-1 hash: <---- (*) STEP
3
  calculated 3971e404:1211e83e:87ecc2bb:4f80bd9b:bacad0d7 <---- (*) STEP 3
  expected 3971e404:1211e83e:87ecc2bb:4f80bd9b:bacad0d7 <---- (*) STEP 3
Validating main package signatures <---- (*) STEP
4 & 5

RSA Signed RELEASE Image Signature Verification Successful. <---- (*) STEP
6
Image validated <---- (*) STEP
7

Restricted Rights Legend <---- (*) STEP
8

```

Use, duplication, or disclosure by the Government is subject to restrictions as set forth in subparagraph (c) of the Commercial Computer Software - Restricted Rights clause at FAR sec. 52.227-19 and subparagraph (c) (1) (ii) of the Rights in Technical Data and Computer Software clause at DFARS sec. 252.227-7013.

Cisco Systems, Inc.
170 West Tasman Drive
San Jose, California 95134-1706

Cisco IOS Software [Amsterdam], ASR1000 Software (X86_64_LINUX_IOSD-UNIVERSALK9-M), Version 17.1.1, RELEASE SOFTWARE (fc3)
Technical Support: <http://www.cisco.com/techsupport>
Copyright (c) 1986-2019 by Cisco Systems, Inc.
Compiled Fri 22-Nov-19 03:43 by mcpre

Processes Overview

Cisco IOS XE has numerous components that run entirely as separate processes on the Cisco ASR 1000 Series Routers. This modular architecture increases network resiliency by distributing operating responsibility among separate processes rather than relying on Cisco IOS software for all operations.

This section covers the following topics:

The following table provides a list of the important individual processes for the Cisco ASR 1000 Series Routers. These processes run in the background, and the CLI on Cisco ASR 1000 Series Routers using Cisco IOS-XE is identical in look, feel, and usage to the Cisco IOS CLI on most platforms. This information is provided because it may be useful for checking router state and troubleshooting, but understanding this information is not essential to understanding most router operations.

Table 2: Individual Processes

Process	Purpose	Affected FRUs	SubPackage Mapping
Chassis Manager	Responsible for all chassis management functions, including management of the HA state, environmental monitoring, and FRU state control.	RP (one instance per RP)SIP (one instance per SIP)ESP (one instance per ESP)	RPControlSIPBaseESPBase
Host Manager	Provides an interface between the IOS process and many of the information-gathering functions of the underlying platform kernel and operating system.	RP (one instance per RP)SIP (one instance per SIP)ESP (one instance per ESP)	RPControlSIPBaseESPBase
Logger	Provides IOS facing logging services to processes running on each FRU.	RP (one instance per RP)SIP (one instance per SIP)ESP (one instance per ESP)	RPControlSIPBaseESPBase

Process	Purpose	Affected FRUs	SubPackage Mapping
Interface Manager	Provides an interface between the IOS process and the per-SPA interface processes on the SIP.	RP (one instance per RP)SIP (one instance per SIP)	RPCControlSIPBase
IOS	The IOS process implements all forwarding and routing features for the router.	RP (one per software redundancy instance per RP). Maximum of two instances per RP.	RPIOS
Forwarding Manager	Manages the downloading of configuration to each of the ESPs and the communication of forwarding plane information, such as statistics, to the IOS process.	RP (one per software redundancy instance per RP). Maximum of two instances per RP.ESP (one per ESP)	RPCControl ESPBase
Pluggable Services	The integration point between platform policy application, such as authentication and the IOS process.	RP (one per software redundancy instance per RP). Maximum of two instances per RP.	RPCControl
Shell Manager	Provides all user interface features and handling related to features in the nonIOS image of the consolidated package.	RP (one instance per RP)	RPCControl
SPA driver process	Provides an isolated process driver for a specific SPA.	SPA (one instance per SPA per SIP)	SIPSPA
CPP driver process	Manages the CPP hardware forwarding engine on the ESP.	ESP (one instance per ESP)	ESPBase
CPP HA process	Manages HA state for the CPP hardware forwarding engine.	ESP (one instance per ESP)	ESPBase
CPP SP process	Performs high-latency tasks for the CPP-facing functionality in the ESP instance of the Forwarding Manager process.	ESP (one instance per ESP)	ESPBase

IOS as a Process

In almost all previous Cisco router platforms, an overwhelming majority of the internal software processes are run using Cisco IOS memory.

The Cisco ASR 1000 Series Routers introduce a distributed software architecture that moves many operating system responsibilities out of the IOS process. In this architecture, IOS, which previously was responsible for almost all of the internal software processes, now runs as one of many Linux processes while allowing other Linux processes to share responsibility for running the router. This architecture allows for better allocation of memory so the router can run more efficiently.

Dual IOS Processes

The Cisco ASR 1000 Series Router introduces a dual IOS process model that allows for increased high availability at all times.

Using SSO or RPR, a second IOS process can be enabled on a Cisco ASR 1002 or 1004 Router. On Cisco ASR 1000 Series Routers configured with dual Route Processors, the second IOS process runs on the standby Route Processor.

The state of these dual IOS processes can be checked by entering the **show platform** command.

The advantages of a second IOS process includes:

- Increased fault tolerance—In the event of an active IOS failure, the second IOS process immediately becomes the active IOS process with little to no service disruption.
- No downtime software upgrades—IOS and other software on the router can be upgraded using the In Service Software Upgrade (ISSU) feature in the standby IOS process, thereby allowing the network to remain active during the software upgrade. See the “[Router#](#)” section on page 5-20 for additional information on when ISSU can and cannot be used to perform no downtime software upgrades.

File Systems on the Cisco ASR 1000 Series Router

The following table provides a list of file systems that can be seen on the Cisco ASR 1000 Series Routers.

Table 3: File Systems

File System	Description
bootflash:	The boot flash memory file system on the active RP.
cns:	The Cisco Networking Services file directory.
harddisk:	The hard disk file system on the active RP. The harddisk: file system is not available on the Cisco ASR 1002 Routers.
nvrnram:	Router NVRAM. You can copy the startup configuration to NVRAM or from NVRAM.
obfl:	The file system for Onboard Failure Logging files.
stby-bootflash:	The boot flash memory file system on the standby RP.
stby-harddisk:	The hard disk file system on the standby RP. The harddisk: file system is not available on the Cisco ASR 1002 Routers.
stby-usb[0-1]:	The Universal Serial Bus (USB) flash drive file systems on the standby RP. The stby-usb: file system is not available on the Cisco ASR 1002 Routers.
system:	The system memory file system, which includes the running configuration.
tar:	The archive file system.
tmpsys:	The temporary system files file system.

File System	Description
usb[0-1]:	The Universal Serial Bus (USB) flash drive file systems on the active RP. Only usb0: is available on the Cisco ASR 1002 Router.

If you run into a file system not listed in the above table, enter the ? help option or see the **copy** command reference for additional information on that file system.

Autogenerated File Directories and Files

This section discusses the autogenerated files and directories that might appear on your Cisco ASR 1000 Series Routers, and how the files in these directories can be managed.

The following table provides a list and descriptions of autogenerated files on the Cisco ASR 1000 Series Routers.

Table 4: Autogenerated Files

File or Directory	Description
crashinfo files	A crashinfo file may appear in the bootflash: or harddisk: file system. These files provide descriptive information of a crash and may be useful for tuning or troubleshooting purposes, but the files are not part of router operations and can be erased without impacting the functioning of the router.
core directory	The storage area for .core files. If this directory is erased, it will automatically regenerate itself at bootup. The .core files in this directory can be erased without impacting any router functionality, but the directory itself should not be erased.
lost+found directory	This directory is created on bootup if a system check is performed. Its appearance is completely normal and does not indicate any issues with the router.
tracelogs directory	The storage area for trace files. Trace files are useful for troubleshooting. Trace files, however, are not part of router operations and can be erased without impacting the router's performance.

Important Notes About Autogenerated Directories

The important information about autogenerated directories include:

- Any autogenerated file on the bootflash: directory should not be deleted, renamed, moved, or altered in any way unless directed by customer support. Altering autogenerating files on the bootflash: can have unpredictable consequences for system performance.
- Crashinfo, core, and trace files can be deleted, but the core and tracelog directories that are automatically part of the harddisk: file system should not be deleted.



CHAPTER 4

Using Cisco IOS XE Software

This chapter provides information to prepare you to configure the Cisco ASR 1000 Series Routers:

- [Accessing the CLI Using a Router Console, on page 23](#)
- [Using Keyboard Shortcuts, on page 27](#)
- [Using the History Buffer to Recall Commands, on page 28](#)
- [Understanding the Command Mode, on page 28](#)
- [Getting Help, on page 30](#)
- [Using the no and default Forms of Commands, on page 33](#)
- [Syslog for Improper Card Seating, on page 33](#)
- [Saving Configuration Changes, on page 33](#)
- [Managing Configuration Files, on page 33](#)
- [Filtering the Output of the show and more Commands, on page 35](#)
- [Powering Off a Router, on page 35](#)
- [Finding Support Information for Platforms and Cisco Software Images, on page 35](#)

Accessing the CLI Using a Router Console

The following sections describe how to access the command-line interface (CLI) using a directly-connected console or by using Telnet or a modem to obtain a remote console:

Accessing the CLI Using a Directly-Connected Console

This section describes how to connect to the console port on the router and use the console interface to access the CLI.

The console port on a Cisco ASR 1000 Series Router is an EIA/TIA-232 asynchronous, serial connection with no flow control and an RJ-45 connector. The console port is located on the front panel of each Route Processor (RP).



Note Cisco ASR 1000 Series Router auxiliary port does not support modem.

Connecting to the Console Port

To connect to the console port, complete the following steps:

SUMMARY STEPS

1. Configure your terminal emulation software with the following settings:
2. Connect to the port using the RJ-45-to-RJ-45 cable and RJ-45-to-DB-25 DTE adapter or using the RJ-45-to-DB-9 DTE adapter (labeled “Terminal”).

DETAILED STEPS

- Step 1** Configure your terminal emulation software with the following settings:
- 9600 bits per second (bps)
 - 8 data bits
 - No parity
 - 1 stop bit
 - No flow control
- Step 2** Connect to the port using the RJ-45-to-RJ-45 cable and RJ-45-to-DB-25 DTE adapter or using the RJ-45-to-DB-9 DTE adapter (labeled “Terminal”).
-

Using the Console Interface

Every RP on a Cisco ASR 1000 Series Router has a console interface. Notably, a standby RP can be accessed using the console port in addition to the active RP in a dual RP configuration.

To access the CLI using the console interface, complete the following steps:

SUMMARY STEPS

1. After you attach the terminal hardware to the console port on the router and you configure your terminal emulation software with the proper settings, the following prompt appears:
2. Press **Return** to enter user EXEC mode. The following prompt appears:
3. From user EXEC mode, enter the **enable** command as shown in the following example:
4. At the password prompt, enter your system password. If an enable password has not been set on your system, this step may be skipped. The following example shows entry of the password enablepass:
5. When your enable password is accepted, the privileged EXEC mode prompt appears:
6. You now have access to the CLI in privileged EXEC mode and you can enter the necessary commands to complete your desired tasks.
7. To exit the console session, enter the **quit** command as shown in the following example:

DETAILED STEPS

- Step 1** After you attach the terminal hardware to the console port on the router and you configure your terminal emulation software with the proper settings, the following prompt appears:

Example:

Press RETURN to get started.

Step 2 Press **Return** to enter user EXEC mode. The following prompt appears:

Example:

```
Router>
```

Step 3 From user EXEC mode, enter the **enable** command as shown in the following example:

Example:

```
Router> enable
```

Step 4 At the password prompt, enter your system password. If an enable password has not been set on your system, this step may be skipped. The following example shows entry of the password enablepass:

Example:

```
Password: enablepass
```

Step 5 When your enable password is accepted, the privileged EXEC mode prompt appears:

Example:

```
Router#
```

Step 6 You now have access to the CLI in privileged EXEC mode and you can enter the necessary commands to complete your desired tasks.

Step 7 To exit the console session, enter the **quit** command as shown in the following example:

Example:

```
Router# quit
```

Accessing the CLI from a Remote Console Using Telnet

This section describes how to connect to the console interface on a router using Telnet to access the CLI.

Preparing to Connect to the Router Console Using Telnet

Before you can access the router remotely using Telnet from a TCP/IP network, you need to configure the router to support virtual terminal lines (vty) using the **line vty** global configuration command. You also should configure the vtys to require login and specify a password.



Note To prevent disabling login on the line, be careful that you specify a password with the **password** command when you configure the **login** line configuration command. If you are using authentication, authorization, and accounting (AAA), you should configure the **login authentication** line configuration command. To prevent disabling login on the line for AAA authentication when you configure a list with the **login authentication** command, you must also configure that list using the **aaa authentication login** global configuration command. For more information about AAA services, see the *Cisco IOS XE Security Configuration Guide*, and the *Cisco IOS Security Command Reference Guide*.

In addition, before you can make a Telnet connection to the router, you must have a valid host name for the router or have an IP address configured on the router. For more information about requirements for connecting to the router using Telnet, information about customizing your Telnet services, and using Telnet key sequences, see the *Cisco IOS Configuration Fundamentals Configuration Guide*.

Using Telnet to Access a Console Interface

To access a console interface using Telnet, complete the following steps:

SUMMARY STEPS

1. From your terminal or PC, enter one of the following commands:
2. At the password prompt, enter your login password. The following example shows entry of the password `mypass`:
3. From user EXEC mode, enter the **enable** command as shown in the following example:
4. At the password prompt, enter your system password. The following example shows entry of the password `enablepass`:
5. When the enable password is accepted, the privileged EXEC mode prompt appears:
6. You now have access to the CLI in privileged EXEC mode and you can enter the necessary commands to complete your desired tasks.
7. To exit the Telnet session, use the **exit** or **logout** command as shown in the following example:

DETAILED STEPS

Step 1 From your terminal or PC, enter one of the following commands:

- **connect** *host* [*port*] [*keyword*]
- **telnet** *host* [*port*] [*keyword*]

In this syntax, *host* is the router hostname or an IP address, *port* is a decimal port number (23 is the default), and *keyword* is a supported keyword. For more information, see the *Cisco IOS Configuration Fundamentals Command Reference Guide*.

Note If you are using an access server, then you will need to specify a valid port number such as **telnet 198.51.100.40 2004**, in addition to the hostname or IP address.

The following example shows the **telnet** command to connect to the router named `router`:

Example:

```
unix_host% telnet router
Trying 198.51.100.40...
```



```
Connected to 198.51.100.40.
Escape character is '^]'.
unix_host% connect
```

Step 2 At the password prompt, enter your login password. The following example shows entry of the password mypass:

Example:

```
User Access Verification
Password: mypass
```

Note If no password has been configured, press **Return**.

Step 3 From user EXEC mode, enter the **enable** command as shown in the following example:

Example:

```
Router> enable
```

Step 4 At the password prompt, enter your system password. The following example shows entry of the password enablepass:

Example:

```
Password: enablepass
```

Step 5 When the enable password is accepted, the privileged EXEC mode prompt appears:

Example:

```
Router#
```

Step 6 You now have access to the CLI in privileged EXEC mode and you can enter the necessary commands to complete your desired tasks.

Step 7 To exit the Telnet session, use the **exit** or **logout** command as shown in the following example:

Example:

```
Router# logout
```

Using Keyboard Shortcuts

Commands are not case sensitive. You can abbreviate commands and parameters if the abbreviations contain enough letters to be different from any other currently available commands or parameters.

The following table lists the keyboard shortcuts for entering and editing commands.

Table 5: Keyboard Shortcuts

Keystrokes	Purpose
Ctrl-B or the Left Arrow key ¹	Move the cursor back one character
Ctrl-F or the Right Arrow key ¹	Move the cursor forward one character

Keystrokes	Purpose
Ctrl-A	Move the cursor to the beginning of the command line
Ctrl-E	Move the cursor to the end of the command line
Esc B	Move the cursor back one word
Esc F	Move the cursor forward one word

¹ The arrow keys function only on ANSI-compatible terminals such as VT100s.

Using the History Buffer to Recall Commands

The history buffer stores the last 20 commands you entered. History substitution allows you to access these commands without retyping them, by using special abbreviated commands.

The following table lists the history substitution commands.

Table 6: History Substitution Commands

Command	Purpose
Ctrl-P or the Up Arrow key ²	Recall commands in the history buffer, beginning with the most recent command. Repeat the key sequence to recall successively older commands.
Ctrl-N or the Down Arrow key ¹	Return to more recent commands in the history buffer after recalling commands with Ctrl-P or the Up Arrow key.
Router# show history	While in EXEC mode, list the last several commands you have just entered.

² The arrow keys function only on ANSI-compatible terminals such as VT100s.

Understanding the Command Mode

The command modes available in the traditional Cisco IOS CLI are exactly the same as the command modes available in Cisco IOS XE.

You use the CLI to access Cisco IOS XE software. Because the CLI is divided into many different modes, the commands available to you at any given time depend on the mode that you are currently in. Entering a question mark (?) at the CLI prompt allows you to obtain a list of commands available for each command mode.

When you log in to the CLI, you are in user EXEC mode. User EXEC mode contains only a limited subset of commands. To have access to all commands, you must enter privileged EXEC mode, normally by using a password. From privileged EXEC mode, you can issue any EXEC command—user or privileged mode—or you can enter global configuration mode. Most EXEC commands are one-time commands. For example, **show** commands show important status information, and **clear** commands clear counters or interfaces. The EXEC commands are not saved when the software reboots.

Configuration modes allow you to make changes to the running configuration. If you later save the running configuration to the startup configuration, these changed commands are stored when the software is rebooted.

To enter specific configuration modes, you must start at global configuration mode. From global configuration mode, you can enter interface configuration mode and a variety of other modes, such as protocol-specific modes.

ROM monitor mode is a separate mode used when the Cisco IOS XE software cannot load properly. If a valid software image is not found when the software boots or if the configuration file is corrupted at startup, the software might enter ROM monitor mode.

The following table describes how to access and exit various common command modes of the Cisco IOS XE software. It also shows examples of the prompts displayed for each mode.

Table 7: Accessing and Exiting Command Modes

Command Mode	Access Method	Prompt	Exit Method
User EXEC	Log in.	Router>	Use the logout command.
Privileged EXEC	From user EXEC mode, use the enable EXEC command.	Router#	To return to user EXEC mode, use the disable command.
Global configuration	From privileged EXEC mode, use the configure terminal privileged EXEC command.	Router (config) #	To return to privileged EXEC mode from global configuration mode, use the exit or end command.
Interface configuration	From global configuration mode, specify an interface using an interface command.	Router (config-if) #	To return to global configuration mode, use the exit command. To return to privileged EXEC mode, use the end command.
Diagnostic	<p>The router boots up or accesses diagnostic mode in the following scenarios:</p> <p>In some cases, diagnostic mode will be reached when the IOS process or processes fail. In most scenarios, however, the router will.</p> <p>A user-configured access policy was configured using the transport-map command that directed the user into diagnostic mode. See the Chapter 4, “Console Port, Telnet, and SSH Handling” of this book for information on configuring access policies.</p> <p>The router was accessed using a Route Processor auxiliary port.</p> <p>A break signal (Ctrl-C, Ctrl-Shift-6, or the send break command) was entered and the router was configured to go into diagnostic mode when the break signal was received.</p>	Router (diag) #	<p>If the IOS process failing is the reason for entering diagnostic mode, the IOS problem must be resolved and the router rebooted to get out of diagnostic mode.</p> <p>If the router is in diagnostic mode because of a transport-map configuration, access the router through another port or using a method that is configured to connect to the Cisco IOS CLI.</p> <p>If the router is accessed through the Route Processor auxiliary port, access the router through another port. Accessing the router through the auxiliary port is not useful for customer purposes anyway.</p>
ROM monitor	From privileged EXEC mode, use the reload EXEC command. Press the Break key during the first 60 seconds while the system is booting.	>	To exit ROM monitor mode, use the continue command.

Getting Help

Entering a question mark (?) at the CLI prompt displays a list of commands available for each command mode. You can also get a list of keywords and arguments associated with any command by using the context-sensitive help feature.

To get help specific to a command mode, a command, a keyword, or an argument, use one of the commands listed in the following table:

Table 8: Help Commands and Purpose

Command	Purpose
help	Provides a brief description of the help system in any command mode.
abbreviated-command-entry?	Provides a list of commands that begin with a particular character string. (No space between command and question mark.)
abbreviated-command-entry<Tab>	Completes a partial command name.
?	Lists all commands available for a particular command mode.
command ?	Lists the keywords or arguments that you must enter next on the command line. (Space between command and question mark.)

Finding Command Options

This section provides an example of how to display syntax for a command. The syntax can consist of optional or required keywords and arguments. To display keywords and arguments for a command, enter a question mark (?) at the configuration prompt or after entering part of a command followed by a space. The Cisco IOS XE software displays a list and brief description of available keywords and arguments. For example, if you were in global configuration mode and wanted to see all the keywords or arguments for the **arap** command, you would type **arap ?**.

The <cr> symbol in command help output stands for “carriage return.” On older keyboards, the carriage return key is the Return key. On most modern keyboards, the carriage return key is the Enter key. The <cr> symbol at the end of command help output indicates that you have the option to press **Enter** to complete the command and that the arguments and keywords in the list preceding the <cr> symbol are optional. The <cr> symbol by itself indicates that no more arguments or keywords are available and that you must press **Enter** to complete the command.

The following table shows examples of how you can use the question mark (?) to assist you in entering commands.

Table 9: Finding Command Options

Command	Comment
Router> enable Password: <password> Router#	Enter the enable command and password to access privileged EXEC commands. You are in privileged EXEC mode when the prompt changes to a “#” from the “>”; for example, Router> to Router# .

Command	Comment
<pre>Router# configure terminal Enter configuration commands, one per line. End with CNTL/Z. Router(config)#</pre>	<p>Enter the configure terminal privileged EXEC command to enter global configuration mode. You are in global configuration mode when the prompt changes to Router(config)# .</p>
<pre>Router(config)# interface serial ? <0-6> Serial interface number Router(config)# interface serial 4 ? / Router(config)# interface serial 4/ ? <0-3> Serial interface number Router(config)# interface serial 4/0 ? <cr> Router(config)# interface serial 4/0 Router(config-if)#</pre>	<p>Enter interface configuration mode by specifying the serial interface that you want to configure using the interface serial global configuration command.</p> <p>Enter ? to display what you must enter next on the command line. In this example, you must enter the serial interface slot number and port number, separated by a forward slash.</p> <p>When the <cr> symbol is displayed, you can press Enter to complete the command.</p> <p>You are in interface configuration mode when the prompt changes to Router(config-if)# .</p>
<pre>Router(config-if)# ? Interface configuration commands: . . . ip Interface Internet Protocol config commands keepalive Enable keepalive lan-name LAN Name command llc2 LLC2 Interface Subcommands load-interval Specify interval for load calculation for an locaddr-priority Assign a priority group logging Configure logging for interface loopback Configure internal loopback on an interface mac-address Manually set interface MAC address mls mls router sub/interface commands mpoa MPOA interface configuration commands mtu Set the interface Maximum Transmission Unit (MTU) netbios Use a defined NETBIOS access list or enable no name-caching Negate a command or set its defaults nrzi-encoding Enable use of NRZI encoding ntp Configure NTP . . Router(config-if)#</pre>	<p>Enter ? to display a list of all the interface configuration commands available for the serial interface. This example shows only some of the available interface configuration commands.</p>

Command	Comment
<pre>Router(config-if)# ip ? Interface IP configuration subcommands: access-group Specify access control for packets accounting Enable IP accounting on this interface address Set the IP address of an interface authentication authentication subcommands bandwidth-percent Set EIGRP bandwidth limit broadcast-address Set the broadcast address of an interface cgmpp Enable/disable CGMP directed-broadcast Enable forwarding of directed broadcasts dvmrp DVMRP interface commands hello-interval Configures IP-EIGRP hello interval helper-address Specify a destination address for UDP broadcasts hold-time Configures IP-EIGRP hold time . . . Router(config-if)# ip</pre>	<p>Enter the command that you want to configure for the interface. This example uses the ip command.</p> <p>Enter ? to display what you must enter next on the command line. This example shows only some of the available interface IP configuration commands.</p>
<pre>Router(config-if)# ip address ? A.B.C.D IP address negotiated IP Address negotiated over PPP Router(config-if)# ip address</pre>	<p>Enter the command that you want to configure for the interface. This example uses the ip address command.</p> <p>Enter ? to display what you must enter next on the command line. In this example, you must enter an IP address or the negotiated keyword.</p> <p>A carriage return (<cr>) is not displayed; therefore, you must enter additional keywords or arguments to complete the command.</p>
<pre>Router(config-if)# ip address 198.51.100.1 ? A.B.C.D IP subnet mask Router(config-if)# ip address 198.51.100.1</pre>	<p>Enter the keyword or argument that you want to use. This example uses the 198.51.100.1 IP address.</p> <p>Enter ? to display what you must enter next on the command line. In this example, you must enter an IP subnet mask.</p> <p>A <cr> is not displayed; therefore, you must enter additional keywords or arguments to complete the command.</p>
<pre>Router(config-if)# ip address 198.51.100.1 255.255.255.0 ? secondary Make this IP address a secondary address <cr> Router(config-if)# ip address 198.51.100.1 255.255.255.0</pre>	<p>Enter the IP subnet mask. This example uses the 255.255.255.0 IP subnet mask.</p> <p>Enter ? to display what you must enter next on the command line. In this example, you can enter the secondary keyword, or you can press Enter.</p> <p>A <cr> is displayed; you can press Enter to complete the command, or you can enter another keyword.</p>
<pre>Router(config-if)# ip address 198.51.100.1 255.255.255.0 Router(config-if)#</pre>	<p>In this example, Enter is pressed to complete the command.</p>

Using the no and default Forms of Commands

Almost every configuration command has a **no** form. In general, use the **no** form to disable a function. Use the command without the **no** keyword to re-enable a disabled function or to enable a function that is disabled by default. For example, IP routing is enabled by default. To disable IP routing, use the **no ip routing** command; to re-enable IP routing, use the **ip routing** command. The Cisco IOS software command reference publications provide the complete syntax for the configuration commands and describe what the **no** form of a command does.

Many CLI commands also have a **default** form. By issuing the command **default command-name**, you can configure the command to its default setting. The Cisco IOS software command reference publications describe the function of the **default** form of the command when the **default** form performs a different function than the plain and **no** forms of the command. To see what default commands are available on your system, enter **default ?** in the appropriate command mode.

Syslog for Improper Card Seating

The Syslog for Improper Card Seating helps to detect if the card is seated properly onto chassis. If card is not inserted correctly, it displays a message onto console prompting to re-insert the card correctly. The feature also helps to suppress the ESI reframe error messages which may appear during OIR or upgrade. These error messages can be misunderstood as an indication of faulty hardware even if those messages have no functional impact.

Saving Configuration Changes

Use the **copy running-config startup-config** command to save your configuration changes to the startup configuration so that the changes will not be lost if the software reloads or a power outage occurs. For example:

```
Router# copy running-config startup-config
Building configuration...
```

It might take a minute or two to save the configuration. After the configuration has been saved, the following output appears:

```
[OK]
Router#
```

This task saves the configuration to NVRAM.

Managing Configuration Files

On the Cisco ASR 1000 Series Routers, the startup configuration file is stored in the `nvr` file system and the running-configuration files are stored in the `system` file system. This configuration file storage setup is not unique to the Cisco ASR 1000 Series Routers and is used on several Cisco router platforms.

As a matter of routine maintenance on any Cisco router, users should backup the startup configuration file by copying the startup configuration file from NVRAM onto one of the router's other file systems and, additionally,

onto a network server. Backing up the startup configuration file provides an easy method of recovering the startup configuration file in the event the startup configuration file in NVRAM becomes unusable for any reason.

The **copy** command can be used to backup startup configuration files. The following examples show the startup configuration file in NVRAM being backed up:

Example 1: Copying a Startup Configuration File to Bootflash

```
Router# dir bootflash:
Directory of bootflash:/
  11  drwx      16384   Dec 4 2007 04:32:46 -08:00  lost+found
86401 drwx      4096   Dec 4 2007 06:06:24 -08:00  .ssh
14401 drwx      4096   Dec 4 2007 06:06:36 -08:00  .rollback_timer
28801 drwx      4096   May 29 2008 16:31:41 -07:00  .prst_sync
43201 drwx      4096   Dec 4 2007 04:34:45 -08:00  .installer
  12  -rw-    208904396  May 28 2008 16:17:34 -07:00
asr1000rpl-adventerprisek9.02.01.00.122-33.XNA.bin
Router# copy nvram:startup-config bootflash:
Destination filename [startup-config]?
3517 bytes copied in 0.647 secs (5436 bytes/sec)
Router# dir bootflash:
Directory of bootflash:/
  11  drwx      16384   Dec 4 2007 04:32:46 -08:00  lost+found
86401 drwx      4096   Dec 4 2007 06:06:24 -08:00  .ssh
14401 drwx      4096   Dec 4 2007 06:06:36 -08:00  .rollback_timer
28801 drwx      4096   May 29 2008 16:31:41 -07:00  .prst_sync
43201 drwx      4096   Dec 4 2007 04:34:45 -08:00  .installer
  12  -rw-    208904396  May 28 2008 16:17:34 -07:00
asr1000rpl-adventerprisek9.02.01.00.122-33.XNA.bin
  13  -rw-         7516   Jul 2 2008 15:01:39 -07:00  startup-config
```

Example 2: Copying a Startup Configuration File to USB Flash Disk

```
Router# dir usb0:
Directory of usb0:/
43261 -rwx    208904396  May 27 2008 14:10:20 -07:00
asr1000rpl-adventerprisek9.02.01.00.122-33.XNA.bin
255497216 bytes total (40190464 bytes free)
Router# copy nvram:startup-config usb0:
Destination filename [startup-config]?
3172 bytes copied in 0.214 secs (14822 bytes/sec)
Router# dir usb0:
Directory of usb0:/
43261 -rwx    208904396  May 27 2008 14:10:20 -07:00
asr1000rpl-adventerprisek9.02.01.00.122-33.XNA.bin43262 -rwx          3172   Jul 2 2008
15:40:45 -07:00  startup-config255497216 bytes total (40186880 bytes free)
```

Example 3: Copying a Startup Configuration File to a TFTP Server

```
Router# copy bootflash:startup-config tftp:
Address or name of remote host []? 198.51.100.81
Destination filename [pe24_asr-1002-config]? /auto/tftp-users/user/startup-config
!!
3517 bytes copied in 0.122 secs (28828 bytes/sec)
```

For more detailed information on managing configuration files, see the *Managing Configuration Files* section in the *Cisco IOS XE Configuration Fundamentals Configuration Guide*

Filtering the Output of the show and more Commands

You can search and filter the output of **show** and **more** commands. This functionality is useful if you need to sort through large amounts of output or if you want to exclude output that you need not see.

To use this functionality, enter a **show** or **more** command followed by the “pipe” character (|); one of the keywords **begin**, **include**, or **exclude**; and a regular expression on which you want to search or filter (the expression is case sensitive):

```
show command | {append | begin | exclude | include | redirect | section | tee} regular-expression
```

The output matches certain lines of information in the configuration file. The following example illustrates how to use output modifiers with the **show interface** command when you want the output to include only lines in which the expression “protocol” appears:

```
Router# show interface | include protocol  
FastEthernet0/0 is up, line protocol is up  
Serial4/0 is up, line protocol is up  
Serial4/1 is up, line protocol is up  
Serial4/2 is administratively down, line protocol is down  
Serial4/3 is administratively down, line protocol is down
```

Powering Off a Router

Before you turn off a power supply, make certain the chassis is grounded and you perform a soft shutdown on the power supply. Not performing a soft shutdown will often not harm the router, but may cause problems in certain scenarios.

To perform a soft shutdown before powering off the router, enter the **reload** command to halt the system and then wait for ROM Monitor to execute before proceeding to the next step.

The following screenshot shows an example of this process:

```
Router# reload  
Proceed with reload? [confirm]  
...(Some messages are omitted here)  
Initializing Hardware...  
Calculating the ROMMON CRC...CRC is correct.
```

Place the power supply switch in the Off position after seeing this message.

Finding Support Information for Platforms and Cisco Software Images

Cisco software is packaged in feature sets consisting of software images that support specific platforms. The feature sets available for a specific platform depend on which Cisco software images are included in a release. To identify the set of software images available in a specific release or to find out if a feature is available in a given Cisco IOS XE software image, you can use Cisco Feature Navigator or the software release notes.

Using the Cisco Feature Navigator

Use Cisco Feature Navigator to find information about platform support and software image support. Cisco Feature Navigator enables you to determine which Cisco IOS XE software images support a specific software release, feature set, or platform. To access Cisco Feature Navigator, go to <http://www.cisco.com/go/cfn>. An account on Cisco.com is not required.

Using the Software Advisor

To see if a feature is supported by a Cisco IOS XE release, to locate the software document for that feature, or to check the minimum software requirements of Cisco IOS XE software with the hardware installed on your router, Cisco maintains the Software Advisor tool on Cisco.com at <http://www.cisco.com/cgi-bin/Support/CompNav/Index.pl>.

You must be a registered user on Cisco.com to access this tool.

Using the Software Release Notes

Cisco IOS XE software releases include release notes that provide the following information:

- Platform support information
- Memory recommendations
- New feature information
- Open and resolved severity 1 and 2 caveats for all platforms

Release notes are intended to be release-specific for the most current release, and the information provided in these documents may not be cumulative in providing information about features that first appeared in previous releases. Refer to Cisco Feature Navigator for cumulative feature information.



CHAPTER 5

Console Port, Telnet, and SSH Handling

This chapter covers the following topics:

- [Console Port Overview for the Cisco ASR 1000 Series Routers, on page 37](#)
- [Console Port Handling Overview, on page 37](#)
- [Telnet and SSH Overview for the Cisco ASR 1000 Series Routers, on page 38](#)
- [Persistent Telnet and Persistent SSH Overview, on page 38](#)
- [Configuring a Console Port Transport Map, on page 38](#)
- [Configuring Persistent Telnet, on page 40](#)
- [Configuring Persistent SSH, on page 42](#)
- [Viewing Console Port, SSH, and Telnet Handling Configurations, on page 45](#)
- [Important Notes and Restrictions, on page 48](#)

Console Port Overview for the Cisco ASR 1000 Series Routers

The console port on the Cisco ASR 1000 Series Router is an EIA/TIA-232 asynchronous, serial connection with no flow control and an RJ-45 connector. The console port is used to access the router and is located on the front panel of the Route Processor (RP).

For information on accessing the router using the console port, see the [“Accessing the CLI Using a Directly-Connected Console” section on page 3-2](#).

Console Port Handling Overview

Users using the console port to access the router are automatically directed to the IOS command-line interface, by default.

If a user is trying to access the router through the console port and sends a break signal (a break signal can be sent by entering **Ctrl-C** or **Ctrl-Shift-6**, or by entering the **send break** command at the Telnet prompt) before connecting to the IOS command-line interface, the user is directed into a diagnostic mode by default if the nonRPIOS subpackages can be accessed.

These settings can be changed by configuring a transport map for the console port and applying that transport map to the console interface.

Telnet and SSH Overview for the Cisco ASR 1000 Series Routers

Telnet and Secure Shell (SSH) on the Cisco ASR 1000 Series Routers can be configured and handled like Telnet and SSH on other Cisco platforms. For information on traditional Telnet, see the **line** command in the *Cisco IOS Terminal Services Command Reference guide* located at:

http://www.cisco.com/en/US/docs/ios/12_2/termserv/command/reference/trfloshe.html#wp1029818.

For information on configuring traditional SSH, see the “Configuring Secure Shell” chapter of the *Cisco IOS Security Configuration Guide* located at:

http://www.cisco.com/en/US/docs/ios/12_2/security/configuration/guide/scfssh.html.

The Cisco ASR 1000 Series Routers also introduces persistent Telnet and persistent SSH. Persistent Telnet and persistent SSH allow network administrators to more clearly define the treatment of incoming traffic when users access the router through the Management Ethernet port using Telnet or SSH. Notably, persistent Telnet and persistent SSH provide more robust network access by allowing the router to be configured to be accessible through the Ethernet Management port using Telnet or SSH even when the IOS process has failed.

Persistent Telnet and Persistent SSH Overview

In traditional Cisco routers, accessing the router using Telnet or SSH is not possible in the event of an IOS failure. When Cisco IOS fails on a traditional Cisco router, the only method of accessing the router is through the console port. Similarly, if all active IOS processes have failed on a Cisco ASR 1000 Series Router that is not using persistent Telnet or persistent SSH, the only method of accessing the router is through the console port.

With persistent Telnet and persistent SSH, however, users can configure a transport map that defines the treatment of incoming Telnet or SSH traffic on the Management Ethernet interface.

See the [Configuring Persistent Telnet, on page 40](#) and the [Configuring Persistent SSH, on page 42](#) for information on the various other options that are configurable using persistent Telnet or persistent SSH transport maps.

Configuring a Console Port Transport Map

This task describes how to configure a transport map for a console port interface on the Cisco ASR 1000 Series Router.

SUMMARY STEPS

1. **enable**
2. **configure terminal**
3. **transport-map type console** *transport-map-name*
4. **connection wait** [**allow interruptible** | **none**]
5. **exit**
6. **transport type console** *console-line-number* **input** *transport-map-name*

DETAILED STEPS

	Command or Action	Purpose
Step 1	<p>enable</p> <p>Example:</p> <pre>Router> enable</pre>	<p>Enables privileged EXEC mode.</p> <ul style="list-style-type: none"> • Enter your password if prompted.
Step 2	<p>configure terminal</p> <p>Example:</p> <pre>Router# configure terminal</pre>	<p>Enters global configuration mode.</p>
Step 3	<p>transport-map type console <i>transport-map-name</i></p> <p>Example:</p> <pre>Router(config)# transport-map type console consolehandler</pre>	<p>Creates and names a transport map for handling console connections, and enter transport map configuration mode.</p>
Step 4	<p>connection wait [allow interruptible none]</p> <p>Example:</p> <pre>Router(config-tmap)# connection wait none</pre> <p>Example:</p>	<p>Specifies how a console connection will be handled using this transport map:</p> <ul style="list-style-type: none"> • allow interruptible—The console connection waits for an IOS vty line to become available, and also allows user to enter diagnostic mode by interrupting a console connection waiting for the IOS vty line to become available. This is the default setting. <p>Note Users can interrupt a waiting connection by entering Ctrl-C or Ctrl-Shift-6.</p> <ul style="list-style-type: none"> • none—The console connection immediately enters diagnostic mode.
Step 5	<p>exit</p> <p>Example:</p> <pre>Router(config-tmap)# exit</pre>	<p>Exits transport map configuration mode to re-enter global configuration mode.</p>
Step 6	<p>transport type console <i>console-line-number</i> input <i>transport-map-name</i></p> <p>Example:</p> <p>Example:</p> <pre>Router(config)# transport type console 0 input consolehandler</pre>	<p>Applies the settings defined in the transport map to the console interface.</p> <p>The <i>transport-map-name</i> for this command must match the <i>transport-map-name</i> defined in the transport-map type console comm and.</p>

Examples

In the following example, a transport map to set console port access policies is created and attached to console port 0:

```
Router(config)# transport-map type console consolehandler
Router(config-tmap)# connection wait allow interruptible
Router(config-tmap)# exit
Router(config)# transport type console 0 input consolehandler
```

Configuring Persistent Telnet

This task describes how to configure persistent Telnet on the Cisco ASR 1000 Series Routers.

Before you begin

For a persistent Telnet connection to access an IOS vty line on the Cisco ASR 1000 Series Router, local login authentication must be configured for the vty line (the **login** command in line configuration mode). If local login authentication is not configured, users will not be able to access IOS using a Telnet connection into the Management Ethernet interface with an applied transport map.

SUMMARY STEPS

1. **enable**
2. **configure terminal**
3. **transport-map type persistent telnet** *transport-map-name*
4. **connection wait** [allow {interruptible}| none {disconnect}]
5. **transport interface gigabitethernet 0**
6. **exit**
7. **transport type persistent telnet input** *transport-map-name*

DETAILED STEPS

	Command or Action	Purpose
Step 1	enable Example: Router> enable	Enables privileged EXEC mode. <ul style="list-style-type: none"> • Enter your password if prompted.
Step 2	configure terminal Example: Router# configure terminal	Enters global configuration mode.

	Command or Action	Purpose
Step 3	<p>transport-map type persistent telnet <i>transport-map-name</i></p> <p>Example:</p> <pre>Router(config)# transport-map type persistent telnet telnethandler</pre>	<p>Creates and names a transport map for handling persistent Telnet connections, and enters transport map configuration mode.</p>
Step 4	<p>connection wait [allow {interruptible} none {disconnect}]</p> <p>Example:</p> <pre>Router(config-tmap)# connection wait none</pre> <p>Example:</p>	<p>Specifies how a persistent Telnet connection will be handled using this transport map:</p> <ul style="list-style-type: none"> • allow—The Telnet connection waits for an IOS vty line to become available, and exits the router if interrupted. • allow interruptible—The Telnet connection waits for the IOS vty line to become available, and also allows user to enter diagnostic mode by interrupting a Telnet connection waiting for the IOS vty line to become available. This is the default setting. <p>Note Users can interrupt a waiting connection by entering Ctrl-C or Ctrl-Shift-6.</p> <ul style="list-style-type: none"> • none—The Telnet connection immediately enters diagnostic mode. • none disconnect—The Telnet connection does not wait for the IOS vty line and does not enter diagnostic mode, so all Telnet connections are rejected if no vty line is immediately available in IOS.
Step 5	<p>transport interface gigabitethernet 0</p> <p>Example:</p> <pre>Router(config-tmap)# transport interface gigabitethernet 0</pre>	<p>Applies the transport map settings to the Management Ethernet interface (interface gigabitethernet 0).</p> <p>Persistent Telnet can only be applied to the Management Ethernet interface on the Cisco ASR 1000 Series Routers. This step must be taken before applying the transport map to the Management Ethernet interface.</p>
Step 6	<p>exit</p> <p>Example:</p> <pre>Router(config-tmap)# exit</pre>	<p>Exits transport map configuration mode to re-enter global configuration mode.</p>
Step 7	<p>transport type persistent telnet input <i>transport-map-name</i></p> <p>Example:</p> <p>Example:</p> <pre>Router(config)# transport type persistent telnet input telnethandler</pre>	<p>Applies the settings defined in the transport map to the Management Ethernet interface.</p> <p>The <i>transport-map-name</i> for this command must match the <i>transport-map-name</i> defined in the transport-map type persistent telnet comm and.</p>

Examples

In the following example, a transport map that will make all Telnet connections wait for an IOS vty line to become available before connecting to the router, while also allowing the user to interrupt the process and enter diagnostic mode, is configured and applied to the Management Ethernet interface (interface gigabitethernet 0).

The transport map is then applied to the interface when the **transport type persistent telnet input** command is entered to enable persistent Telnet.

```
Router(config)# transport-map type persistent telnet telnethandler
Router(config-tmap)# connection wait allow interruptible
Router(config-tmap)# transport interface gigabitethernet 0
Router(config-tmap)# exit
Router(config)# transport type persistent telnet input telnethandler
```

Configuring Persistent SSH

This task describes how to configure persistent SSH on the Cisco ASR 1000 Series Routers.

SUMMARY STEPS

1. **enable**
2. **configure terminal**
3. **transport-map type persistent ssh *transport-map-name***
4. **connection wait [allow {interruptible}| none {disconnect}]**
5. **rsa keypair-name *rsa-keypair-name***
6. **authentication-retries number-of-retries**
7. **time-out timeout-interval**
8. **transport interface gigabitethernet 0**
9. **exit**
10. **transport type persistent ssh input *transport-map-name***

DETAILED STEPS

	Command or Action	Purpose
Step 1	enable Example: Router> enable	Enables privileged EXEC mode. <ul style="list-style-type: none"> • Enter your password if prompted.
Step 2	configure terminal Example: Router# configure terminal	Enters global configuration mode.

	Command or Action	Purpose
Step 3	<p>transport-map type persistent ssh <i>transport-map-name</i></p> <p>Example:</p> <pre>Router(config)# transport-map type persistent ssh sshhandler</pre>	Creates and names a transport map for handling persistent SSH connections, and enters transport map configuration mode.
Step 4	<p>connection wait [allow {interruptible} none {disconnect}]</p> <p>Example:</p> <pre>Router(config-tmap)# connection wait allow interruptible</pre> <p>Example:</p>	<p>Specifies how a persistent SSH connection will be handled using this transport map:</p> <ul style="list-style-type: none"> • allow—The SSH connection waits for the vty line to become available, and exits the router if interrupted. • allow interruptible—The SSH connection waits for the vty line to become available, and also allows users to enter diagnostic mode by interrupting a SSH connection waiting for the vty line to become available. This is the default setting. <p>Note Users can interrupt a waiting connection by entering Ctrl-C or Ctrl-Shift-6.</p> <ul style="list-style-type: none"> • none—The SSH connection immediately enters diagnostic mode. • none disconnect—The SSH connection does not wait for the vty line from IOS and does not enter diagnostic mode, so all SSH connections are rejected if no vty line is immediately available.
Step 5	<p>rsa keypair-name <i>rsa-keypair-name</i></p> <p>Example:</p> <pre>Router(config-tmap)# rsa keypair-name sshkeys</pre>	<p>Names the RSA keypair to be used for persistent SSH connections.</p> <p>For persistent SSH connections, the RSA keypair name must be defined using this command in transport map configuration mode. The RSA keypair definitions defined elsewhere on the router, such as through the use of the ip ssh rsa keypair-name command, do not apply to persistent SSH connections.</p> <p>No <i>rsa-keypair-name</i> is defined by default.</p>
Step 6	<p>authentication-retries <i>number-of-retries</i></p> <p>Example:</p> <pre>Router(config-tmap)# authentication-retries 4</pre>	<p>(Optional) Specifies the number of authentication retries before dropping the connection.</p> <p>The default <i>number-of-retries</i> is 3.</p>
Step 7	<p>time-out <i>timeout-interval</i></p> <p>Example:</p> <pre>Router(config-tmap)# time-out 30</pre>	<p>(Optional) Specifies the SSH time-out interval in seconds.</p> <p>The default <i>timeout-interval</i> is 120 seconds.</p>

	Command or Action	Purpose
Step 8	transport interface gigabitethernet 0 Example: <pre>Router(config-tmap)# transport interface gigabitethernet 0</pre>	Applies the transport map settings to the Management Ethernet interface (interface gigabitethernet 0). Persistent SSH can only be applied to the Management Ethernet interface on the Cisco ASR 1000 Series Routers.
Step 9	exit Example: <pre>Router(config-tmap)# exit</pre>	Exits transport map configuration mode to re-enter global configuration mode.
Step 10	transport type persistent ssh input <i>transport-map-name</i> Example: Example: <pre>Router(config)# transport type persistent ssh input sshhandler</pre>	Applies the settings defined in the transport map to the Management Ethernet interface. The <i>transport-map-name</i> for this command must match the <i>transport-map-name</i> defined in the transport-map type persistent ssh command .

Examples

In the following example, a transport map that will make all SSH connections wait for the vty line to become active before connecting to the router is configured and applied to the Management Ethernet interface (interface gigabitethernet 0). The RSA keypair is named sshkeys.

This example only uses the commands required to configure persistent SSH.

```
Router(config)# transport-map type persistent ssh sshhandler
Router(config-tmap)# connection wait allow
Router(config-tmap)# rsa keypair-name sshkeys
Router(config-tmap)# transport interface gigabitethernet 0
```

In the following example, a transport map is configured that will apply the following settings to any users attempting to access the Management Ethernet port via SSH:

- Users using SSH will wait for the vty line to become active, but will enter diagnostic mode if the attempt to access IOS through the vty line is interrupted.
- The RSA keypair name is sshkeys
- The connection allows one authentication retry.
- The banner “ --Waiting for vty line-- ” will appear if the connection is waiting for the vty line to become active.

The transport map is then applied to the interface when the **transport type persistent ssh input** command is entered to enable persistent SSH:

```
Router(config)# transport-map type persistent ssh sshhandler
Router(config-tmap)# connection wait allow interruptible
Router(config-tmap)# rsa keypair-name sshkeys
Router(config-tmap)# authentication-retries 1
```

```
Router(config-tmap)#banner wait X
Enter TEXT message. End with the character 'X'.
--Waiting for vty line--
X
Router(config-tmap)#
time-out 30
Router(config-tmap)# transport interface gigabitethernet 0
Router(config-tmap)# exit
Router(config)# transport type persistent ssh input sshhandler
```

Viewing Console Port, SSH, and Telnet Handling Configurations

Use the **show transport-map all name *transport-map-name* | type console persistent ssh telnet[*type*]** EXEC or privileged EXEC command to view the transport map configurations.

In the following example, a console port, persistent SSH, and persistent Telnet transport are configured on the router and various forms of the **show transport-map** command are entered to illustrate the various ways the **show transport-map** command can be entered to gather transport map configuration information.

```
Router# show transport-map all
Transport Map:
  Name: consolehandler
  Type: Console Transport
Connection:
  Wait option: Wait Allow Interruptable
  Wait banner:
Waiting for the IOS CLI

Transport Map:
  Name: sshhandler
  Type: Persistent SSH Transport
Interface:
  GigabitEthernet0
Connection:
  Wait option: Wait Allow Interruptable
  Wait banner:
Waiting for IOS prompt

SSH:
  Timeout: 120
  Authentication retries: 5
  RSA keypair: sshkeys
Transport Map:
  Name: telnethandler
  Type: Persistent Telnet Transport
Interface:
  GigabitEthernet0
Connection:
  Wait option: Wait Allow Interruptable
  Wait banner:
Waiting for IOS process

Transport Map:
  Name: telnethandling1
  Type: Persistent Telnet Transport
Connection:
  Wait option: Wait Allow
Router# show transport-map type console
Transport Map:
```

```
Name: consolehandler
Type: Console Transport
Connection:
  Wait option: Wait Allow Interruptable
  Wait banner:
Waiting for the IOS CLI

Router# show transport-map type persistent ssh
Transport Map:
  Name: sshhandler
  Type: Persistent SSH Transport
Interface:
  GigabitEthernet0
Connection:
  Wait option: Wait Allow Interruptable
  Wait banner:
Waiting for IOS prompt

SSH:
  Timeout: 120
  Authentication retries: 5
  RSA keypair: sshkeys
Router# show transport-map type persistent telnet

Transport Map:
  Name: telnethandler
  Type: Persistent Telnet Transport
Interface:
  GigabitEthernet0
Connection:
  Wait option: Wait Allow Interruptable
  Wait banner:
Waiting for IOS process

Transport Map:
  Name: telnethandling1
  Type: Persistent Telnet Transport
Connection:
  Wait option: Wait Allow
Router# show transport-map name telnethandler
Transport Map:
  Name: telnethandler
  Type: Persistent Telnet Transport
Interface:
  GigabitEthernet0
Connection:
  Wait option: Wait Allow Interruptable
  Wait banner:
Waiting for IOS process

Router# show transport-map name consolehandler
Transport Map:
  Name: consolehandler
  Type: Console Transport
Connection:
  Wait option: Wait Allow Interruptable
  Wait banner:
Waiting for the IOS CLI

Router# show transport-map name sshhandler
Transport Map:
  Name: sshhandler
  Type: Persistent SSH Transport
Interface:
```

```

GigabitEthernet0
Connection:
  Wait option: Wait Allow Interruptable
  Wait banner:
Waiting for IOS prompt

SSH:
  Timeout: 120
  Authentication retries: 5
  RSA keypair: sshkeys
Router#

```

The **show platform software configuration access policy** command can be used to view the current configurations for the handling of incoming console port, SSH, and Telnet connections. The output of this command provides the current wait policy for each type of connection, as well as any information on the currently configured banners.

```

Router# show platform software configuration access policy
The current access-policies
Method      : telnet
Rule        : wait
Shell banner:
Wait banner :
Method      : ssh
Rule        : wait
Shell banner:
Wait banner :
Method      : console
Rule        : wait with interrupt
Shell banner:
Wait banner :

```

In the following example, the connection policy and banners are set for a persistent SSH transport map, and the transport map is enabled.

The **show platform software configuration access policy** output is given both before the new transport map is enabled and after the transport map is enabled so the changes to the SSH configuration are illustrated in the output.

```

Router# show platform software configuration access policy

The current access-policies
Method      : telnet
Rule        : wait with interrupt

Wait banner :
Waiting for IOS Process
Method      : ssh
Rule        : wait
Shell banner:
Wait banner :
Method      : console
Rule        : wait with interrupt
Shell banner:
Wait banner :
Router# configure terminal
Enter configuration commands, one per line.  End with CNTL/Z.
Router(config)# transport-map type persistent ssh sshhandler
Router(config-tmap)# connection wait allow interruptible

Router(config-tmap)# rsa keypair-name sshkeys
Router(config-tmap)# transport interface gigabitethernet 0

```

```
Router(config-tmap)# exit
Router(config)# transport type persistent ssh input sshhandler
Router(config)# exit
Router# show platform software configuration access policy
The current access-policies
Method      : telnet
Rule        : wait with interrupt

Wait banner :
Waiting for IOS process
Method      : ssh
Rule        : wait with interrupt

Wait banner :
Waiting for IOS
Method      : console
Rule        : wait with interrupt
Shell banner:
Wait banner :
```

Important Notes and Restrictions

The important notes and restriction pertaining to the console port, SSH, and telnet handling include:

- The Telnet and SSH settings made in the transport map override any other Telnet or SSH settings when the transport map is applied to the Management Ethernet interface.
- Only local usernames and passwords can be used to authenticate users entering a Management Ethernet interface. AAA authentication is not available for users accessing the router through a Management Ethernet interface using persistent Telnet or persistent SSH.
- Applying a transport map to a Management Ethernet interface with active Telnet or SSH sessions can disconnect the active sessions. Removing a transport map from an interface, however, does not disconnect any active Telnet or SSH sessions.



CHAPTER 6

Consolidated Packages and SubPackages Management

This chapter discusses how consolidated packages and software subpackages (individual and optional) are managed and are used to run the Cisco ASR 1000 Series Aggregation Services Routers. It contains the following sections:



Note This section of the document does not discuss limited downtime upgrades. For information on limited downtime upgrades, see the [“Software Upgrade Processes Supported by Cisco ASR 1000 Series Routers”](#) section on page 6-1 .

- [Running the Cisco ASR 1000 Series Routers: An Overview, on page 49](#)
- [Software File Management Using Command Sets, on page 52](#)
- [Managing and Configuring the Router to Run Using Consolidated Packages and Individual SubPackages, on page 53](#)
- [Upgrading Individual SubPackages, on page 66](#)

Running the Cisco ASR 1000 Series Routers: An Overview

The Cisco ASR 1000 Series Routers can be run using a complete consolidated package or using individual subpackages.

This section covers the following topics:

Running the Cisco ASR 1000 Series Routers Using Individual and Optional SubPackages: An Overview

The Cisco ASR 1000 Series Routers can be configured to run using individual subpackages and optional subpackages.

When the router is configured to run using individual and optional subpackages:

- Each individual subpackage within a consolidated package is extracted onto the router as its own file.
- Additionally, any optional subpackages must be separately downloaded and stored in the same directory with the provisioning file and the other individual subpackages that have been extracted.

- The router then runs by accessing each file as needed for operational purposes. All individual and optional subpackage files must be stored in the same directory on the router for the router to run properly using individual subpackages.

When a Cisco ASR 1000 Series Router is configured to run using individual and optional subpackages, software image content from the RP is copied into memory on an as-needed basis only. Memory is conserved for other router processes, such as passing traffic. The router, therefore, allows for the highest peak traffic load when configured to run using individual subpackages.

When running the Cisco ASR 1000 Series Routers using individual and optional subpackages, the router must be configured to boot using the provisioning file that was included in the consolidated package with the individual subpackage files. This provisioning file must also be in the same directory as the individual and optional subpackage files. The router boots faster when configured to run using individual and optional subpackages than it does when configured to run using a consolidated package.

A Cisco ASR 1000 Series Router cannot be configured to run individual and optional subpackages stored on a TFTP or any other network server. The individual and optional subpackages along with the provisioning file must be copied onto the bootflash: file system to run the router using this method.

Running the Cisco ASR 1000 Series Routers Using a Consolidated Package: An Overview

The Cisco ASR 1000 Series Routers can also be configured to run using a consolidated package.



Note Booting the router from a consolidated package is not supported for installation of optional subpackages. For more information, see the [Running the Cisco ASR 1000 Series Routers Using Individual and Optional SubPackages: An Overview, on page 49](#).

When the router is configured to run using a consolidated package, the entire consolidated package file is copied onto the router or accessed by the router via TFTP or another network transport method. The router runs using the consolidated package file.

When a Cisco ASR 1000 Series Router is configured to run using the consolidated package file, more memory is required to process router requests because the router has to search one larger file for every request. The peak amount of memory available for passing network traffic is therefore lower when the router is configured to run using a consolidated package.

A Cisco ASR 1000 Series Router configured to run using a consolidated package is booted by booting the consolidated package file. Because this file is large, the boot process for routers running using the consolidated package is slower than the boot process for routers running individual subpackages.

A Cisco ASR 1000 Series Router configured to run using a consolidated package does have some advantages over a Cisco ASR 1000 Series Router configured to run individual subpackages. First, a consolidated package can be booted and utilized using TFTP or another network transport method. Secondly, configuring the router to use the one consolidated package file is easier than managing several individual subpackage files. Running the router using a consolidated package may be the right method of running the router in certain networking environments.

The consolidated package should be stored on bootflash:, usb[0-1]:, or a remote file system when this method is used to run the router.

Running the Cisco ASR 1000 Series Routers: A Summary

This section summarizes the advantages and disadvantages of each method of running your Cisco ASR 1000 Series Routers.

The advantages of running your router using individual subpackages include:

- Optimizes router memory usage—When the router is booting using the individual and optional subpackage method, software image content from the Router Processor (RP) is copied into memory on an as-needed basis only, which conserves memory for other router processes. The router boots fastest and allows for the highest peak traffic load when booted using the individual subpackage boot approach.

The advantages of running your router using a consolidated package include:

- Simplified installation—Only one software file needs to be managed instead of several separate images.
- Storage—A consolidated package, unlike individual subpackages, can be used to run the router while being stored in bootflash:, on a USB Flash disk, or on a network server. A consolidated package can be booted and utilized using TFTP or another network transport method, while the individual subpackage method requires the individual subpackage files to be copied into the bootflash: file directory on the router.

[Table 10: Advantages and Disadvantages of Running Individual subPackages and Consolidated Packages, on page 51](#) summarizes the advantages and disadvantages of the approaches.

Table 10: Advantages and Disadvantages of Running Individual subPackages and Consolidated Packages

Approach	Advantages	Disadvantages
Individual and optional subpackages Note This method is required if you need to install any optional subpackages for your system.		<ul style="list-style-type: none"> • Multiple software subpackages more difficult to manage. • Cannot be booted from TFTP or any other network server. If you are going to use the individual subpackage boot method, each individual subpackage file must be placed in the bootflash: directory. • Individual and optional subpackage files and the provisioning file must be stored in bootflash:.
Consolidated Package	<ul style="list-style-type: none"> • Easier management. Only have to manage one file instead of many files. • A consolidated package file can be stored in bootflash:, on a USB Flash disk, or on any TFTP or other network server. 	<ul style="list-style-type: none"> • Slower boot times and lessened maximum system scalability because the larger image must be processed at all times.

Software File Management Using Command Sets

Software files can be managed on the Cisco ASR 1000 Series Routers using three distinct command sets. This section provides overviews of the following command sets:

The request platform Command Set

The **request platform software package** command is part of the larger **request platform** command set being introduced on the Cisco ASR 1000 Series Routers. For additional information on each **request platform** command and the options available with each command, see the *Cisco IOS Configuration Fundamentals Command Reference* .

The **request platform software package** command, which can be used to upgrade individual subpackages and a complete consolidated package, is used to upgrade software on the Cisco ASR 1000 Series Routers. Notably, the **request platform software package** command is the recommended way of performing an individual subpackage upgrade, and also provides the only method of no-downtime upgrades of individual subpackages on the router when the router is running individual subpackages.

The **request platform software package** command requires that the destination device or process be specified in the command line, so the commands can be used to upgrade software on both an active or a standby processor. The **request platform software package** command allows for no downtime software upgrades in many scenarios.

The basic syntax of the command is **request platform software package install rp *rp-slot-number* file *file-URL***, where *rp-slot-number* is the number of the RP slot and *file-URL* is the path to the file being used to upgrade the Cisco ASR 1000 Series Router. The command has other options; see the **request platform software package** command references for information on all of the options available with this command set.

In Cisco IOS XE Release 2.4, the **request platform software package uninstall** command is introduced on the Cisco ASR 1000 Series Routers to remove provisioning of an optional subpackage from an RP. The syntax for the command follows the install form of the command: **request platform software package uninstall rp *rp-slot-number* type *pkg***, where *rp-slot-number* is the number of the RP slot and *pkg* is the type of optional subpackage file to be removed.



Note For additional information on limited downtime upgrades using the **request platform software package** command set, see the [“Software Upgrade Processes Supported by Cisco ASR 1000 Series Routers” section on page 6-1](#) .

The copy Command

The **copy** command can be used to move consolidated packages and individual subpackages onto the router, though using this command to move individual subpackage files from one storage area to another is often inefficient (in these scenarios, it is almost always preferable to move the consolidated package, then extract the subpackages, or to extract the subpackages without moving the consolidated package).

To upgrade a consolidated package on the Cisco ASR 1000 Series Routers, copy the consolidated package onto a file system, usually bootflash: or usb[0-1]: on the router, using the **copy** command as you would on

most other Cisco routers. After making this copy, configure the router to boot using the consolidated package file.

To upgrade the router and reboot using individual subpackages, copy the consolidated package onto the router using the **copy** command, enter the **request platform software package expand** command to extract the individual subpackages, and configure the router to boot using subpackages. Other methods, such as copying each individual subpackage in the same consolidated package from a directory or using the **request platform software package** command to extract the subpackages onto a router directory are also usable, though copying individual subpackages is often inefficient.

See the **copy** command reference for a list of the options that are available with the **copy** command.

The issu Command Set

The **issu** command set that is available on other Cisco routers is also available on the Cisco ASR 1000 Series Routers. The **issu** command set can be used to perform both consolidated package and individual subpackage upgrades.

The **issu** command set includes the **issu** command with the **loadversion**, **runversion**, **commitversion**, and **abortversion** options. See the **issu** command references for information on all of the options available with each of these commands.

A confirm prompt is displayed when the command **issu abortversion** is issued and when the standby has not reached the terminal (hot) state.

The following example shows a confirm prompt notification:

```
The system is without a fully initialized peer and service impact will occur. Proceed with
abort? [confirm]
```

The **issu runversion** command is optional for completing a consolidated package upgrade on the Cisco ASR 1000 Series Routers. You can enter **issu commitversion** from the active RP to complete the software upgrade, then use the **redundancy force-switchover** command to switch to the upgraded RP on this platform, if desired.



Note For additional information on limited downtime upgrades using the **issu** command set, see the [“Software Upgrade Processes Supported by Cisco ASR 1000 Series Routers”](#) section on page 6-1 .

Managing and Configuring the Router to Run Using Consolidated Packages and Individual SubPackages

This section discusses the following topics:

Quick Start Software Upgrade

The following instructions provide a quick start version of upgrading the software running the Cisco ASR 1000 Series Routers. These instructions assume you have access to the consolidated package and that the files will be stored in a bootflash: file system that is not storing any previously installed subpackages or consolidated packages and that has enough room for the file or files.

For more detailed installation examples, see the other sections of this chapter.

To upgrade the software using a quick start version, perform the following steps:

SUMMARY STEPS

1. Copy the consolidated package into bootflash: using the **copy URL-to-image bootflash:** command.
2. If you want to run the router using individual subpackages, enter the **request platform software package expand file bootflash:image-name** command. If you want to run the router using a consolidated package, skip this step.
3. Enter the **dir bootflash:** command to verify your consolidated package or your extracted subpackages are in the directory.
4. If you are trying to run individual subpackages, use the **delete bootdisk:image-name** to delete the consolidated package. If you want to run the router using the consolidated package, skip this step.
5. Set up the boot parameters for your boot. Set the configuration register to 0x2 by entering the **config-register 0x2102** global configuration command, and enter the **boot system flash bootflash:image-name** (if running using the consolidated package) or **boot system flash bootflash:provisioning-file-name** (if running using individual subpackages) global configuration command.
6. Enter **copy running-config startup-config** to save your configuration.
7. Enter the **reload** command to reload the router and finish the boot. The upgraded software should be running when the reload completes.

DETAILED STEPS

-
- Step 1** Copy the consolidated package into bootflash: using the **copy URL-to-image bootflash:** command.
- Step 2** If you want to run the router using individual subpackages, enter the **request platform software package expand file bootflash:image-name** command. If you want to run the router using a consolidated package, skip this step.
- Step 3** Enter the **dir bootflash:** command to verify your consolidated package or your extracted subpackages are in the directory.
- Step 4** If you are trying to run individual subpackages, use the **delete bootdisk:image-name** to delete the consolidated package. If you want to run the router using the consolidated package, skip this step.
- Step 5** Set up the boot parameters for your boot. Set the configuration register to 0x2 by entering the **config-register 0x2102** global configuration command, and enter the **boot system flash bootflash:image-name** (if running using the consolidated package) or **boot system flash bootflash:provisioning-file-name** (if running using individual subpackages) global configuration command.
- Step 6** Enter **copy running-config startup-config** to save your configuration.
- Step 7** Enter the **reload** command to reload the router and finish the boot. The upgraded software should be running when the reload completes.
-

Managing and Configuring a Router to Run Using a Consolidated Package



Note Do not use this procedure if you also need to install any optional subpackages.

This section documents the following procedures:

Managing and Configuring a Consolidated Package Using the copy Command

To upgrade a consolidated package on the Cisco ASR 1000 Series Routers using the **copy** command, copy the consolidated package into the bootflash: directory on the router using the **copy** command as you would on most other Cisco routers. After making this copy, configure the router to boot using the consolidated package file.

In the following example, the consolidated package file is copied onto the bootflash: file system from TFTP. The config-register is then set to boot using **boot system** commands, and the **boot system** commands instruct the router to boot using the consolidated package stored in the bootflash: file system. The new configuration is then saved using the **copy running-config startup-config** command, and the system is then reloaded to complete the process.

```
Router# dir bootflash:
Directory of bootflash:/
  11  drwx      16384   Dec 4 2007 04:32:46 -08:00  lost+found
86401 drwx      4096   Dec 4 2007 06:06:24 -08:00  .ssh
14401 drwx      4096   Dec 4 2007 06:06:36 -08:00  .rollback_timer
28801 drwx      4096   Mar 18 2008 17:31:17 -07:00  .prst_sync
43201 drwx      4096   Dec 4 2007 04:34:45 -08:00  .installer
  13  -rw-      45977   Apr 9 2008 16:48:46 -07:00  target_support_output.tgz.tgz
928862208 bytes total (712273920 bytes free)
Router# copy tftp bootflash:
Address or name of remote host []? 198.51.100.81
Source filename []? /auto/tftp-users/user/asr1000rp1-adventerprisek9.02.01.00.122-33.XNA.bin
Destination filename [asr1000rp1-adventerprisek9.02.01.00.122-33.XNA.bin]?
Accessing
tftp://198.51.100.81//auto/tftp-users/user/asr1000rp1-adventerprisek9.02.01.00.122-33.XNA.bin...
Loading /auto/tftp-users/user/asr1000rp1-adventerprisek9.02.01.00.122-33.XNA.bin from
198.51.100.81 (via GigabitEthernet0): !!!!!!!
[OK - 208904396 bytes]
208904396 bytes copied in 330.453 secs (632176 bytes/sec)
Router# dir bootflash:
Directory of bootflash:/
  11  drwx      16384   Dec 4 2007 04:32:46 -08:00  lost+found
86401 drwx      4096   Dec 4 2007 06:06:24 -08:00  .ssh
14401 drwx      4096   Dec 4 2007 06:06:36 -08:00  .rollback_timer
28801 drwx      4096   Mar 18 2008 17:31:17 -07:00  .prst_sync
43201 drwx      4096   Dec 4 2007 04:34:45 -08:00  .installer
  12  -rw-    208904396   May 28 2008 16:17:34 -07:00  asr1000rp1-adventerprisek9.02.01.00.122-33.XNA.bin
  13  -rw-      45977   Apr 9 2008 16:48:46 -07:00  target_support_output.tgz.tgz
928862208 bytes total (503156736 bytes free)
Router# config t
Enter configuration commands, one per line. End with CNTL/Z.
Router(config)#boot system flash bootflash:asr1000rp1-adventerprisek9.02.01.00.122-33.XNA.bin
Router(config)#config-reg 0x2102
Router(config)#exit
Router#show run | include boot
boot-start-marker
boot system flash bootflash:asr1000rp1-adventerprisek9.02.01.00.122-33.XNA.bin
boot-end-marker
Router# copy run start
Destination filename [startup-config]?
Building configuration...
[OK]
Router# reload
```

Managing and Configuring a Consolidated Package Using the request platform software package install Command

In the following example, the **request platform software package install** command is used to upgrade a consolidated package running on RP 0. The **force** option, which forces the upgrade past any prompt (such as already having the same consolidated package installed), is used in this example.

```
Router# request platform software package install rp 0 file
bootflash:asr1000rp1-adventerprise9.02.01.00.122-33.XNA.bin force

--- Starting installation state synchronization ---
Finished installation state synchronization
--- Starting file path checking ---
Finished file path checking
--- Starting image file verification ---
Checking image file names
Verifying image file locations
Locating image files and validating name syntax
Inspecting image file types
Processing image file constraints
Extracting super package content
Verifying parameters
Validating package type
Copying package files
Checking and verifying packages contained in super package
Creating candidate provisioning file

WARNING:
WARNING: Candidate software will be installed upon reboot
WARNING:

Finished image file verification
--- Starting candidate package set construction ---
Verifying existing software set
Processing candidate provisioning file
Constructing working set for candidate package set
Constructing working set for running package set
Checking command output
Constructing merge of running and candidate packages
Finished candidate package set construction
--- Starting compatibility testing ---
Determining whether candidate package set is compatible
WARNING:
WARNING: Candidate software combination not found in compatibility database
WARNING:
Determining whether installation is valid
Determining whether installation is valid ... skipped
Checking IPC compatibility with running software
Checking IPC compatibility with running software ... skipped
Checking candidate package set infrastructure compatibility
Checking infrastructure compatibility with running software
Checking infrastructure compatibility with running software ... skipped
Finished compatibility testing
--- Starting commit of software changes ---
Updating provisioning rollback files
Creating pending provisioning file
Committing provisioning file
Finished commit of software changes
SUCCESS: Software provisioned. New software will load on reboot.
```

Router# **reload**



Note A reload must be performed to finish this procedure. The [Managing and Configuring a Consolidated Package Using the copy Command, on page 55](#) includes an example of how to configure the router to boot using the consolidated package, and then an example of what happens after the reload is performed to finish the installation.

Managing and Configuring a Router to Run Using Individual SubPackages From a Consolidated Package

To run the router using individual subpackages from a consolidated package, follow one of the following procedures:

Extracting a Consolidated Package and Booting Using the Provisioning File

To extract a consolidated package and to boot using provisioning file, perform the following steps:

SUMMARY STEPS

1. Perform one of the following tasks:
2. Configure the router to boot using the provisioning file. The sequence below provides an example that would boot the router using the provisioning file named `packages.conf` that was stored with the other subpackages in the `bootflash: file system`:

DETAILED STEPS

Step 1 Perform one of the following tasks:

- Copy the consolidated package file (or, in cases where you have every individual subpackage and a provisioning file for the subpackages available, each individual subpackage and the provisioning file) onto the `bootflash: file system` using the **copy** command. Make sure to copy the consolidated package into the `bootflash: file system` and directory where you want to store the provisioning file and the individual image subpackages. Enter the **request platform software package expand file bootflash:url-to-Cisco-IOS-XE-imagename** command with no other option to extract the provisioning file and the individual subpackages out of the consolidated package file and into the current directory in `bootflash:`.
- Copy the consolidated package file onto any file system on your router, then enter the **request platform software package expand file file-system:url-to-Cisco-IOS-XE-imagename to bootflash:** command to extract the provisioning file and the individual image subpackages onto the `bootflash: file system`.

Note After performing this step, do not move any of the files. The bootup process cannot function properly unless all of the subpackages and the provisioning file are located in the same directory. Also, do not rename the subpackage files. Only the provisioning file can be renamed, and the renaming of the provisioning file, if desired, should be done at this step before the router is rebooted.

Step 2 Configure the router to boot using the provisioning file. The sequence below provides an example that would boot the router using the provisioning file named `packages.conf` that was stored with the other subpackages in the `bootflash: file system`:

Example:

```

Router(config)# no boot system
Router(config)# config-register 0x2102
Router(config)# boot system flash bootflash:packages.conf
Router(config)# exit
*May 11 01:31:04.815: %SYS-5-CONFIG_I: Configured from console by con
Router# copy running-config startup-config
Building configuration...
[OK]
Router# reload

```

What to do next

Extracting the SubPackages and the Provisioning File: Example 1

The following example shows how to extract the individual subpackages and the provisioning file from a consolidated package that has already been placed in the directory where you want to store the individual subpackages and the provisioning file.

Output of the directory before and after the extraction is given to confirm the files were extracted.

```

Router# dir bootflash:
Directory of bootflash:/
 11 drwx      16384   Dec 4 2007 04:32:46 -08:00  lost+found
86401 drwx      4096   Dec 4 2007 06:06:24 -08:00  .ssh
14401 drwx      4096   Dec 4 2007 06:06:36 -08:00  .rollback_timer
28801 drwx      4096   Mar 18 2008 17:31:17 -07:00  .prst_sync
43201 drwx      4096   Dec 4 2007 04:34:45 -08:00  .installer
 12 -rw-    208904396   May 9 2008 14:36:31 -07:00
asr1000rpl-adventerprisek9.02.01.00.122-33.XNA.bin
 13 -rw-      45977   Apr 9 2008 16:48:46 -07:00  target_support_output.tgz.tgz
928862208 bytes total (503156736 bytes free)
Router# request platform software package expand file
bootflash:asr1000rpl-adventerprisek9.02.01.00.122-33.XNA.bin
Verifying parameters
Validating package type
Copying package files
SUCCESS: Finished expanding all-in-one software package.
Router# dir bootflash:
Directory of bootflash:/
 11 drwx      16384   Dec 4 2007 04:32:46 -08:00  lost+found
86401 drwx      4096   Dec 4 2007 06:06:24 -08:00  .ssh
14401 drwx      4096   Dec 4 2007 06:06:36 -08:00  .rollback_timer
28801 drwx      4096   Mar 18 2008 17:31:17 -07:00  .prst_sync
43201 drwx      4096   Dec 4 2007 04:34:45 -08:00  .installer
 12 -rw-    208904396   May 9 2008 14:36:31 -07:00
asr1000rpl-adventerprisek9.02.01.00.122-33.XNA.bin
57611 -rw-    47071436   May 22 2008 11:26:23 -07:00
asr1000rpl-espbase.02.01.00.122-33.XNA.pkg
57602 -rw-      5740   May 22 2008 11:26:22 -07:00
asr1000rpl-packages-adventerprisek9.02.01.00.122-33.XNA.conf
57612 -rw-    20334796   May 22 2008 11:26:24 -07:00
asr1000rpl-rpaccess.02.01.00.122-33.XNA.pkg
57613 -rw-    22294732   May 22 2008 11:26:24 -07:00
asr1000rpl-rpbase.02.01.00.122-33.XNA.pkg
57614 -rw-    21946572   May 22 2008 11:26:25 -07:00
asr1000rpl-rpcontrol.02.01.00.122-33.XNA.pkg
57615 -rw-    48099532   May 22 2008 11:26:26 -07:00
asr1000rpl-rpios-adventerprisek9.02.01.00.122-33.XNA.pkg
57616 -rw-    34324684   May 22 2008 11:26:27 -07:00

```



```

asr1000rp1-sipbase.02.01.00.122-33.XNA.pkg
57617 -rw- 22124748 May 22 2008 11:26:28 -07:00
asr1000rp1-sipspa.02.01.00.122-33.XNA.pkg
57603 -rw- 6256 May 22 2008 11:26:28 -07:00 packages.conf
13 -rw- 45977 Apr 9 2008 16:48:46 -07:00 target_support_output.tgz.tgz
928862208 bytes total (286662656 bytes free)

```

Extracting the SubPackages and the Provisioning File: Example 2

The following example shows how to extract the individual subpackages and the provisioning file from a consolidated package that has already been placed on the router in a directory that will not store the individual subpackages and the provisioning file. In this particular example, the contents of a consolidated package stored in usb0: are extracted into bootflash:

Output of the bootflash: directory before and after the extraction is given to confirm the files were extracted:

```

Router# dir usb0:
Directory of usb0:/
 1240 -rwx 208904396 May 27 2008 14:10:20 -07:00
asr1000rp1-adventerprisek9.02.01.00.122-33.XNA.bin
255497216 bytes total (40190464 bytes free)
Router# dir bootflash:
Directory of bootflash:/
 11 drwx 16384 Dec 13 2004 03:45:47 -08:00 lost+found
87937 drwx 4096 Dec 13 2004 03:46:45 -08:00 .rollback_timer
14657 drwx 4096 Dec 13 2004 03:47:17 -08:00 .installer
29313 drwx 4096 Dec 13 2004 03:53:00 -08:00 .ssh
 12 -rw- 33554432 Dec 13 2004 03:53:49 -08:00 nvram_00100
58625 drwx 4096 May 7 2008 17:27:51 -07:00 .prst_sync
945377280 bytes total (695246848 bytes free)
Router# request platform software package expand file
usb0:asr1000rp1-adventerprisek9.02.01.00.122-33.XNA.bin to bootflash:
Verifying parameters
Validating package type
Copying package files
SUCCESS: Finished expanding all-in-one software package.
Router# dir bootflash:
Directory of bootflash:/
 11 drwx 16384 Dec 13 2004 03:45:47 -08:00 lost+found
87937 drwx 4096 Dec 13 2004 03:46:45 -08:00 .rollback_timer
14657 drwx 4096 Dec 13 2004 03:47:17 -08:00 .installer
29313 drwx 4096 Dec 13 2004 03:53:00 -08:00 .ssh
 12 -rw- 33554432 Dec 13 2004 03:53:49 -08:00 nvram_00100
43979 -rw- 47071436 May 27 2008 14:25:01 -07:00
asr1000rp1-espbase.02.01.00.122-33.XNA.pkg
58625 drwx 4096 May 7 2008 17:27:51 -07:00 .prst_sync
43970 -rw- 5740 May 27 2008 14:25:00 -07:00
asr1000rp1-packages-adventerprisek9.02.01.00.122-33.XNA.conf
43980 -rw- 20334796 May 27 2008 14:25:01 -07:00
asr1000rp1-rpaccess.02.01.00.122-33.XNA.pkg
43981 -rw- 22294732 May 27 2008 14:25:02 -07:00
asr1000rp1-rpbase.02.01.00.122-33.XNA.pkg
43982 -rw- 21946572 May 27 2008 14:25:03 -07:00
asr1000rp1-rpcontrol.02.01.00.122-33.XNA.pkg
43983 -rw- 48099532 May 27 2008 14:25:04 -07:00
asr1000rp1-rpios-adventerprisek9.02.01.00.122-33.XNA.pkg
43984 -rw- 34324684 May 27 2008 14:25:05 -07:00
asr1000rp1-sipbase.02.01.00.122-33.XNA.pkg
43985 -rw- 22124748 May 27 2008 14:25:05 -07:00
asr1000rp1-sipspa.02.01.00.122-33.XNA.pkg
43971 -rw- 6256 May 27 2008 14:25:05 -07:00 packages.conf
945377280 bytes total (478752768 bytes free)

```

Extracting the SubPackages, Configuring the Router to Boot Using the Provisioning File, and Reloading the Router: Example 3

In the following example, the provisioning file and the individual subpackages are extracted from a consolidated package. The router is then configured to boot using the provisioning file. This example also shows the config-register being set and the running configuration being saved because these tasks must be performed for the router to reload properly. The router is then reloaded to complete the process.

```

Router# dir bootflash:
Directory of bootflash:/
  11 drwx      16384   Dec 4 2007 04:32:46 -08:00  lost+found
86401 drwx      4096   Dec 4 2007 06:06:24 -08:00  .ssh
14401 drwx      4096   Dec 4 2007 06:06:36 -08:00  .rollback_timer
28801 drwx      4096   Mar 18 2008 17:31:17 -07:00  .prst_sync
43201 drwx      4096   Dec 4 2007 04:34:45 -08:00  .installer
  12 -rw-    208904396   May 9 2008 14:36:31 -07:00
asr1000rpl-adventerprisek9.02.01.00.122-33.XNA.bin
  13 -rw-      45977   Apr 9 2008 16:48:46 -07:00  target_support_output.tgz.tgz
928862208 bytes total (503156736 bytes free)
Router# request platform software package expand file
bootflash:asr1000rpl-adventerprisek9.02.01.00.122-33.XNA.bin
Verifying parameters
Validating package type
Copying package files
SUCCESS: Finished expanding all-in-one software package.
Router# dir bootflash:
Directory of bootflash:/
  11 drwx      16384   Dec 4 2007 04:32:46 -08:00  lost+found
86401 drwx      4096   Dec 4 2007 06:06:24 -08:00  .ssh
14401 drwx      4096   Dec 4 2007 06:06:36 -08:00  .rollback_timer
28801 drwx      4096   Mar 18 2008 17:31:17 -07:00  .prst_sync
43201 drwx      4096   Dec 4 2007 04:34:45 -08:00  .installer
  12 -rw-    208904396   May 9 2008 14:36:31 -07:00
asr1000rpl-adventerprisek9.02.01.00.122-33.XNA.bin
57611 -rw-    47071436   May 22 2008 11:26:23 -07:00
asr1000rpl-espbase.02.01.00.122-33.XNA.pkg
57602 -rw-      5740   May 22 2008 11:26:22 -07:00
asr1000rpl-packages-adventerprisek9.02.01.00.122-33.XNA.conf
57612 -rw-    20334796   May 22 2008 11:26:24 -07:00
asr1000rpl-rpaccess.02.01.00.122-33.XNA.pkg
57613 -rw-    22294732   May 22 2008 11:26:24 -07:00
asr1000rpl-rpbase.02.01.00.122-33.XNA.pkg
57614 -rw-    21946572   May 22 2008 11:26:25 -07:00
asr1000rpl-rpcontrol.02.01.00.122-33.XNA.pkg
57615 -rw-    48099532   May 22 2008 11:26:26 -07:00
asr1000rpl-rpios-adventerprisek9.02.01.00.122-33.XNA.pkg
57616 -rw-    34324684   May 22 2008 11:26:27 -07:00
asr1000rpl-sipbase.02.01.00.122-33.XNA.pkg
57617 -rw-    22124748   May 22 2008 11:26:28 -07:00
asr1000rpl-sipspa.02.01.00.122-33.XNA.pkg
57603 -rw-      6256   May 22 2008 11:26:28 -07:00  packages.conf
  13 -rw-      45977   Apr 9 2008 16:48:46 -07:00  target_support_output.tgz.tgz
928862208 bytes total (286662656 bytes free)
Router(config)# no boot system
Router(config)# config-register 0x2102
Router(config)# boot system flash bootflash:packages.conf
Router(config)# exit
Router# copy run start
Router# reload

```

Copying a Set of Individual SubPackage Files, and Booting Using a Provisioning File

To copy a set of individual subpackage files and to boot using a provisioning file, perform the following steps:



Note Although this upgrade method works, it is less efficient than other methods of upgrading the router's software.

SUMMARY STEPS

1. Copy each individual subpackage and the provisioning file into the bootflash: directory using the **copy** command. Note that this method of running the router will only work if all the individual subpackages for a release and a provisioning file are downloaded onto the router and stored in the bootflash: directory. No other file directories should be used for booting the router using individual subpackages. The files can also be moved on the router physically using a USB Flash drive.
2. Configure the router to boot using the provisioning file.

DETAILED STEPS

Step 1 Copy each individual subpackage and the provisioning file into the bootflash: directory using the **copy** command. Note that this method of running the router will only work if all the individual subpackages for a release and a provisioning file are downloaded onto the router and stored in the bootflash: directory. No other file directories should be used for booting the router using individual subpackages. The files can also be moved on the router physically using a USB Flash drive.

Step 2 Configure the router to boot using the provisioning file.

The sequence below provides an example that describes how to boot the router using the provisioning file named packages.conf that was stored with the other subpackages in the bootflash: file system. The router runs using individual subpackages once the reload is complete.

Example:

```
Router(config)# no boot system
Router(config)# config-register 0x2102
Router(config)# boot system flash bootflash:packages.conf
Router(config)# exit
*May 11 01:31:04.815: %SYS-5-CONFIG_I: Configured from console by con
Router# write memory
Building configuration...
[OK]
Router# reload
```

Managing and Configuring a Router to Run Using Optional SubPackages

To manage and configure a Cisco ASR 1000 Series Router to run using optional subpackages, perform the following tasks:

Installing an Optional SubPackage



Note If you install the Cisco WebEx Node for ASR 1000 Series SPA before the software subpackage is installed, you will receive the error message %ASR1000_RP_SPA-3-MISSING_SPA_PKG_ERR. This message will resolve once you download and install the appropriate sipspawma subpackage and then reload the router in individual subpackage mode.

To run the router using an optional subpackage, perform the following steps for each RP in the system:

SUMMARY STEPS

1. Verify that the RP is running in individual subpackage mode and was booted from a provisioning file. For more information, see the [Managing and Configuring a Router to Run Using Individual SubPackages From a Consolidated Package, on page 57](#).
2. Verify that the version of the optional subpackage that you want to install is the same version as the software running on the active RP.
3. Download the optional subpackage that you want to install. Optional subpackages must be downloaded independently from consolidated packages for the Cisco ASR 1000 Series Routers.
4. On each RP, copy the optional subpackage to the directory where any other individual subpackages and the provisioning file is located.
5. Run the **request platform software package install rp file** command, as shown in the following example.

DETAILED STEPS

- Step 1** Verify that the RP is running in individual subpackage mode and was booted from a provisioning file. For more information, see the [Managing and Configuring a Router to Run Using Individual SubPackages From a Consolidated Package, on page 57](#).
- Step 2** Verify that the version of the optional subpackage that you want to install is the same version as the software running on the active RP.
- Step 3** Download the optional subpackage that you want to install. Optional subpackages must be downloaded independently from consolidated packages for the Cisco ASR 1000 Series Routers.
- Step 4** On each RP, copy the optional subpackage to the directory where any other individual subpackages and the provisioning file is located.
- Step 5** Run the **request platform software package install rp file** command, as shown in the following example.

Note Do not use the optional **slot** or **bay** keywords for the initial installation.

Example:

```
Router# request platform software package install rp 0 file
bootflash:asr1000rp1-sipspawmak9.BLD_V122_33_XND_ASR_RLS4_THROTTLE_LATEST_20090511_042308.pkg
--- Starting local lock acquisition on R0 --- Finished local lock acquisition on R0
--- Starting file path checking ---
Finished file path checking
--- Starting image file verification --- Checking image file names Verifying image file locations
Locating image files and validating name syntax
Found asr1000rp1-
sipspawmak9.BLD_V122_33_XND_ASR_RLS4_THROTTLE_LATEST_20090511_042308.pkg
Inspecting image file types
```

```

Processing image file constraints
Creating candidate provisioning file
WARNING: No package of type sipspawmak9 is installed.
WARNING: Package will be installed for all SIP slots and bays.
Finished image file verification
--- Starting candidate package set construction --- Verifying existing software set Processing
candidate provisioning file Constructing working set for candidate package set Constructing working
set for running package set Checking command output Constructing merge of running and candidate
packages Checking if resulting candidate package set would be complete Finished candidate package
set construction
--- Starting compatibility testing ---
Determining whether candidate package set is compatible
WARNING:
WARNING: Candidate software combination not found in compatibility database
WARNING:
Determining whether installation is valid
WARNING:
WARNING: Candidate software combination not found in compatibility database
WARNING:
Software sets are identified as compatible Checking IPC compatibility with running software Checking
candidate package set infrastructure compatibility Checking infrastructure compatibility with running
software Checking package specific compatibility Finished compatibility testing
--- Starting impact testing ---
Checking operational impact of change
Finished impact testing
--- Starting list of software package changes --- No old package files removed New files list:
  Added asr1000rp1-
sipspawmak9.BLD_V122_33_XND_ASR_RLS4_THROTTLE_LATEST_20090511_042308.pkg
Finished list of software package changes
--- Starting commit of software changes --- Updating provisioning rollback files Creating pending
provisioning file Committing provisioning file Finished commit of software changes
--- Starting analysis of software changes --- Finished analysis of software changes
--- Starting update running software --- Blocking peer synchronization of operating information
Creating the command set placeholder directory
  Finding latest command set
  Finding latest command shortlist lookup file
  Finding latest command shortlist file
  Assembling CLI output libraries
  Assembling CLI input libraries
  Applying interim IPC and database definitions
  Replacing running software
  Replacing CLI software
  Restarting software
  Restarting software: target frus filtered out ... skipped
  Applying final IPC and database definitions
  Generating software version information
  Notifying running software of updates
  Unblocking peer synchronization of operating information Unmounting old packages Cleaning temporary
installation files
  Finished update running software
SUCCESS: Finished installing software.

```

Uninstalling an Optional SubPackage

In Cisco IOS XE Release 2.4, the Cisco ASR 1000 Series Routers support removal of an installed optional subpackage.

To uninstall an optional subpackage, perform the following steps:

SUMMARY STEPS

1. On each RP in the system, use the **request platform software package uninstall** command as shown in the following example:
2. Use the **show version provisioned** command to verify that the optional subpackage is no longer installed.
3. (Optional) Use the **request platform software clean** command to remove the unused packages.

DETAILED STEPS

Step 1 On each RP in the system, use the **request platform software package uninstall** command as shown in the following example:

Example:

```
Router# request platform software package uninstall rp 0 type sipspawma
--- Starting local lock acquisition on R0 --- Finished local lock acquisition on R0
--- Starting uninstall preparation ---
Validating uninstall options
Creating candidate provisioning file
Finished uninstall preparation
--- Starting candidate package set construction --- Verifying existing software set Processing
candidate provisioning file Constructing working set for candidate package set Constructing working
set for running package set Checking command output Constructing merge of running and candidate
packages Checking if resulting candidate package set would be complete Finished candidate package
set construction
--- Starting compatibility testing ---
Determining whether candidate package set is compatible Determining whether installation is valid
Software sets are identified as compatible Checking IPC compatibility with running software Checking
candidate package set infrastructure compatibility Checking infrastructure compatibility with running
software Checking package specific compatibility Finished compatibility testing
--- Starting list of software package changes --- Old files list:
Removed asr1000rp1-
sipspawmak9.BLD_V122_33_XND_ASR_RLS4_THROTTLE_LATEST_20090511_042308.pkg
No new package files added
Finished list of software package changes
--- Starting commit of software changes --- Updating provisioning rollback files Creating pending
provisioning file Committing provisioning file Finished commit of software changes
--- Starting analysis of software changes --- Finished analysis of software changes
--- Starting update running software --- Blocking peer synchronization of operating information
Creating the command set placeholder directory
Finding latest command set
Finding latest command shortlist lookup file
Finding latest command shortlist file
Assembling CLI output libraries
Assembling CLI input libraries
Applying interim IPC and database definitions
Replacing running software
Replacing CLI software
Restarting software
Restarting software: target frus filtered out ... skipped
Applying final IPC and database definitions
Generating software version information
Notifying running software of updates
Unblocking peer synchronization of operating information Unmounting old packages Cleaning temporary
installation files
Finished update running software
SUCCESS: Finished installing software.
```

Step 2 Use the **show version provisioned** command to verify that the optional subpackage is no longer installed.

Step 3 (Optional) Use the **request platform software clean** command to remove the unused packages.

Troubleshooting Software Mismatch with ESP Board ASR1000-ESP10-N

The Cisco ASR 1000 ESP board ASR1000-ESP10-N enables you to install a Cisco ASR 1000 Series Aggregation Services Router without encryption features. This unrestricted product format, in which all encryption chips have been removed, can be provided in the Cisco ASR 1002, 1004, and 1006 Series Routers. This ESP must be used with the appropriate Cisco IOS XE 2.2 image that does not contain encryption software.

You cannot load Cisco IOS XE software images or subpackages which contain encryption software, onto a Cisco ASR 1000 Series Router that contains the non crypto enabled ESP board (ASR1000-ESP10-N). As soon as the combination of an encryption-enabled Cisco IOS XE image and encryption-disabled ESP is detected—on bootup, online removal or insertion, or during an install—a message is emitted:

```
ESP[0|1] does not support strong cryptography. Chassis will reload.
```

The Route Processor (RP) then reloads the chassis and reboots continuously.

To troubleshoot this problem, follow these steps:

SUMMARY STEPS

1. Enable ROM Monitor (ROMmon) mode by entering the **reload** command.
2. Press the Break key during the first 60 seconds while the system is booting.
3. Force the system to remain in ROMmon mode, waiting for manual bootup, by entering the command: **confreg 0x0**.
4. Load the latest Cisco IOS XE package or subpackages that are compatible with the ASR1000-ESP10-N ESP board.
5. Remove the forced manual boot mode by entering the command: **confreg config register setting**, where *config register setting* is the default for the user system, often 0x2102.
6. Reboot the system.

DETAILED STEPS

Step 1 Enable ROM Monitor (ROMmon) mode by entering the **reload** command.

Step 2 Press the Break key during the first 60 seconds while the system is booting.

Step 3 Force the system to remain in ROMmon mode, waiting for manual bootup, by entering the command: **confreg 0x0**.

Step 4 Load the latest Cisco IOS XE package or subpackages that are compatible with the ASR1000-ESP10-N ESP board.

Compatible subpackages include:

- Cisco ASR1000 Series RP1 IP BASE W/O CRYPTO
- Cisco ASR1000 Series RP1 ADVANCED IP SERVICES W/O CRYPTO
- Cisco ASR1000 Series RP1 ADVANCED ENTERPRISE SERVICES W/O CRYPTO

Step 5 Remove the forced manual boot mode by entering the command: **confreg config register setting**, where *config register setting* is the default for the user system, often 0x2102.

Step 6 Reboot the system.

Upgrading Individual SubPackages

One consolidated package contains seven individual subpackages. Each individual subpackage can be upgraded independently.

When using this method to upgrade subpackages, however, remember that all subpackages that are part of the same consolidated package should be used together on the Cisco ASR 1000 Series Routers. Individual subpackage upgrades are atypical on the Cisco ASR 1000 Series Routers, because it is very rare to experience a case where a single subpackage is upgraded without upgrading all the subpackages from the consolidated package. Individual subpackage upgrades are most useful when only a single subpackage of an otherwise functioning set of subpackages requires an upgrade.

This section uses the SPA subpackage installation to illustrate an individual subpackage upgrade. Although it does not comprehensively cover every possible individual subpackage upgrade scenario, the CLI for each type of upgrade is similar.

Upgrading a SPA SubPackage

In the following example, the **request platform software package install** command is used to upgrade a SIPSPA subpackage for the SPA in bay 0 of the SIP in router slot 1. In this example, the **force** option, which forces the upgrade past any prompt (such as already having the same subpackage installed), is used.



Caution

Do not run your router using subpackages from different consolidated packages. The Cisco ASR 1000 Series Router is not designed to use multiple subpackages from different consolidated packages. Running subpackages from different consolidated packages is not recommended and can cause unpredictable router behavior. Individual subpackages should only be upgraded individually if you or a Cisco customer support representative has determined that upgrading to the same subpackage that is running could have some benefit for your Cisco ASR 1000 Series Router.

```
Router# request platform software package install rp 0 file
bootflash:asr1000rp1-sipspa.02.01.00.122-33.XNA.pkg slot 1 bay 0 force
--- Starting installation state synchronization ---
Finished installation state synchronization
--- Starting file path checking ---
Finished file path checking
--- Starting image file verification ---
Checking image file names
Verifying image file locations
Locating image files and validating name syntax
Inspecting image file types
Processing image file constraints
Creating candidate provisioning file
Finished image file verification
--- Starting candidate package set construction ---
Verifying existing software set
Processing candidate provisioning file
Constructing working set for candidate package set
Constructing working set for running package set
```



```
Checking command output
Constructing merge of running and candidate packages
Finished candidate package set construction
--- Starting compatibility testing ---
Determining whether candidate package set is compatible
WARNING:
WARNING: Candidate software combination not found in compatibility database
WARNING:
Determining whether installation is valid
Software sets are identified as compatible
Checking IPC compatibility with running software
Checking candidate package set infrastructure compatibility
Checking infrastructure compatibility with running software
Finished compatibility testing
--- Starting impact testing ---
Checking operational impact of change
Finished impact testing
--- Starting commit of software changes ---
Updating provisioning rollback files
Creating pending provisioning file
Committing provisioning file
Finished commit of software changes
--- Starting analysis of software changes ---
Finished analysis of software changes
--- Starting update running software ---
Blocking peer synchronization of operating information
Creating the command set placeholder directory
  Finding latest command set
  Assembling CLI output libraries
  Assembling CLI input libraries
  Applying interim IPC and database definitions
    interim IPC and database definitions applied
    Replacing running software
    Replacing CLI software
    Restarting software
Restarting SPA CCl/0
  Applying interim IPC and database definitions
  Notifying running software of updates
  Unblocking peer synchronization of operating information
  Unmounting old packages
  Cleaning temporary installation files
  Finished update running software

SUCCESS: Finished installing software.
Router#
```



CHAPTER

7

Installing the Software using install Commands

- [Installing the Software Using install Commands, on page 69](#)
- [Information About Installing the Software Using install Commands, on page 69](#)
- [Configuration Examples for Installing the Software Using install Commands, on page 79](#)
- [Troubleshooting Software Installation Using install Commands, on page 91](#)

Installing the Software Using install Commands

From Cisco IOS XE 17.15.1a, all Cisco IOS XE platforms are shipped in install mode by default. Users can boot the platform, and upgrade or downgrade to Cisco IOS XE software versions using a set of **install** commands.

Restrictions for Installing the Software Using install Commands

- ISSU is not covered in this feature.
- Install mode requires a reboot of the system.

Information About Installing the Software Using install Commands

For routers shipped in install mode, a set of **install** commands can be used for starting, upgrading and downgrading of platforms in install mode. This update is applicable to the Cisco Catalyst 8000 Edge platforms.

From Cisco IOS XE 17.15.1a release, this update is applicable to all Cisco IOS XE platforms.

The following table describes the differences between Bundle mode and Install mode:

Table 11: Bundle Mode vs Install Mode

Bundle Mode	Install Mode
This mode provides a consolidated boot process, using local (hard disk, flash) or remote (TFTP) .bin image. Note Bundle boot from USB and TFTPBoot is not supported.	This mode uses the local (bootflash) packages.conf file for the boot process.
This mode uses a single .bin file.	.bin file is replaced with expanded .pkg files in this mode.
CLI: <code>#boot system file <filename></code>	CLI: <code>#install add file bootflash: [activate commit]</code>
To upgrade in this mode, point the boot system to the new image.	To upgrade in this mode, use the install commands.
Image Auto-Upgrade: When a new Field-Replaceable Unit (FRU) is inserted in a modular chassis, manual intervention is required to get the new FRU running with the same version as the active FRUs.	Image Auto-Upgrade: When a new FRU is inserted in a modular chassis, the joining FRU is auto-upgraded to the image version in sync with the active FRUs.
Rollback: Rollback to the previous image with multiple Software Maintenance Updates (SMUs) may require multiple reloads.	Rollback: Enables rollback to an earlier version of Cisco IOS XE software, including multiple patches in single reload.

Install Mode Process Flow

The install mode process flow comprises three commands to perform installation and upgrade of software on platforms—**install add**, **install activate**, and **install commit**.

The following flow chart explains the install process with **install** commands:

Process with Install Commit

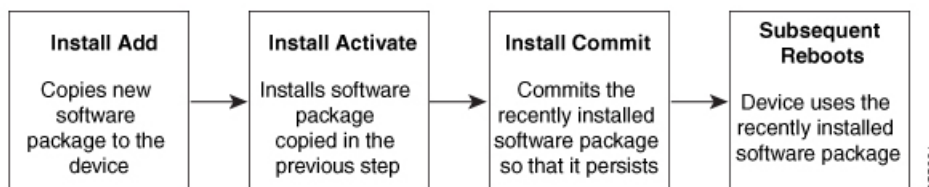

The **install add** command copies the software package from a local or remote location to the platform. The location can be FTP, HTTP, HTTPS, or TFTP. The command extracts individual components of the .package file into subpackages and packages.conf files. It also validates the file to ensure that the image file is specific to the platform on which it is being installed.

The **install activate** command performs the required validations and provisions the packages previously added using the **install add** command. It also triggers a system reload.

The **install commit** command confirms the packages previously activated using the **install activate** command, and makes the updates persistent over reloads.



Note Installing an update replaces any previously installed software image. At any time, only one image can be installed in a device.

The following set of install commands is available:

Table 12: List of install Commands

Command	Syntax	Purpose
install add	install add file <i>location:filename.bin</i>	<p>Copies the contents of the image, package, and SMUs to the software repository. File location may be local or remote. This command does the following:</p> <ul style="list-style-type: none"> • Validates the file-checksum, platform compatibility checks, and so on. • Extracts individual components of the package into subpackages and packages.conf • Copies the image into the local inventory and makes it available for the next steps.
install activate	install activate	<p>Activates the package added using the install add command.</p> <ul style="list-style-type: none"> • Use the show install summary command to see which image is inactive. This image will get activated. • System reloads on executing this command. Confirm if you want to proceed with the activation. Use this command with the prompt-level none keyword to automatically ignore any confirmation prompts.

Command	Syntax	Purpose
(install activate) auto abort-timer	install activate auto-abort timer <30-1200>	<p>The auto-abort timer starts automatically, with a default value of 120 minutes. If the install commit command is not executed within the time provided, the activation process is terminated, and the system returns to the last-committed state.</p> <ul style="list-style-type: none"> • You can change the time value while executing the install activate command. • The install commit command stops the timer, and continues the installation process. • The install activate auto-abort timer stop command stops the timer without committing the package. • Use this command with the prompt-level none keyword to automatically ignore any confirmation prompts. • This command is valid only in the three-step install variant.
install commit	install commit	<p>Commits the package activated using the install activate command, and makes it persistent over reloads.</p> <ul style="list-style-type: none"> • Use the show install summary command to see which image is uncommitted. This image will get committed.

Command	Syntax	Purpose
install abort	install abort	<p>Terminates the installation and returns the system to the last-committed state.</p> <ul style="list-style-type: none"> • This command is applicable only when the package is in activated status (uncommitted state). • If you have already committed the image using the install commit command, use the install rollback to command to return to the preferred version.
install remove	install remove {file <filename> inactive}	<p>Deletes inactive packages from the platform repository. Use this command to free up space.</p> <ul style="list-style-type: none"> • file: Removes specified files. • inactive: Removes all the inactive files.
install rollback to	install rollback to {base label committed id}	<p>Rolls back the software set to a saved installation point or to the last-committed installation point. The following are the characteristics of this command:</p> <ul style="list-style-type: none"> • Requires reload. • Is applicable only when the package is in committed state. • Use this command with the prompt-level none keyword to automatically ignore any confirmation prompts. <p>Note If you are performing install rollback to a previous image, the previous image must be installed in install mode. Only SMU rollback is possible in bundle mode.</p>

Command	Syntax	Purpose
install deactivate	install deactivate file <filename>	Removes a package from the platform repository. This command is supported only for SMUs. <ul style="list-style-type: none"> Use this command with the prompt-level none keyword to automatically ignore any confirmation prompts.

The following show commands are also available:

Table 13: List of show Commands

Command	Syntax	Purpose
show install log	show install log	Provides the history and details of all install operations that have been performed since the platform was booted.
show install package	show install package <filename>	Provides details about the .pkg/.bin file that is specified.
show install summary	show install summary	Provides an overview of the image versions and their corresponding install states for all the FRUs. <ul style="list-style-type: none"> The table that is displayed will state for which FRUs this information is applicable. If all the FRUs are in sync in terms of the images present and their state, only one table is displayed. If, however, there is a difference in the image or state information among the FRUs, each FRU that differs from the rest of the stack is listed in a separate table.
show install active	show install active	Provides information about the active packages for all the FRUs. If there is a difference in the information among the FRUs, each FRU that differs from the rest of the stack is listed in a separate table.

Command	Syntax	Purpose
show install inactive	show install inactive	Provides information about the inactive packages, if any, for all the FRUs. If there is a difference in the information among the FRUs, each FRU that differs from the rest of the stack is listed in a separate table.
show install committed	show install committed	Provides information about the committed packages for all the FRUs. If there is a difference in the information among the FRUs, each FRU that differs from the rest of the stack is listed in a separate table.
show install uncommitted	show install uncommitted	Provides information about uncommitted packages, if any, for all the FRUs. If there is a difference in the information among the FRUs, each FRU that differs from the rest of the stack is listed in a separate table.
show install rollback	show install rollback {point-id label}	Displays the package associated with a saved installation point.
show version	show version [rp-slot] [installed [user-interface] provisioned running]	Displays information about the current package, along with hardware and platform information.

Booting the Platform in Install Mode

You can install, activate, and commit a software package using a single command (one-step install) or multiple separate commands (three-step install).

If the platform is working in bundle mode, the one-step install procedure must be used to initially convert the platform from bundle mode to install mode. Subsequent installs and upgrades on the platform can be done with either one-step or three-step variants.

One-Step Installation or Converting from Bundle Mode to Install Mode



Note

- All the CLI actions (for example, add, activate, and so on) are executed on all the available FRUs.
- The configuration save prompt will appear if an unsaved configuration is detected.
- The reload prompt will appear after the second step in this workflow. Use the **prompt-level none** keyword to automatically ignore the confirmation prompts.
- If the prompt-level is set to None, and there is an unsaved configuration, the install fails. You must save the configuration before reissuing the command.

Use the one-step install procedure described below to convert a platform running in bundle boot mode to install mode. After the command is executed, the platform reboots in install boot mode.

Later, the one-step install procedure can also be used to upgrade the platform.

This procedure uses the **install add file activate commit** command in privileged EXEC mode to install a software package, and to upgrade the platform to a new version.

SUMMARY STEPS

1. **enable**
2. **install add file location: *filename* [activate commit]**
3. **exit**

DETAILED STEPS

	Command or Action	Purpose
Step 1	enable Example: Device>enable	Enables privileged EXEC mode. Enter your password, if prompted.
Step 2	install add file location: <i>filename</i> [activate commit] Example: Device#install add file bootflash:c8000e-universal-k9-ED_V177_THROTTLE_LATEST_20211021_031123_V17_7_0_117.SPA.bin activate commit	Copies the software install package from a local or remote location (through FTP, HTTP, HTTPS, or TFTP) to the platform and extracts the individual components of the .package file into subpackages and packages.conf files. It also performs a validation and compatibility check for the platform and image versions, activates the package, and commits the package to make it persistent across reloads. The platform reloads after this command is run.
Step 3	exit Example: Device#exit	Exits privileged EXEC mode and returns to user EXEC mode.

Three-Step Installation



Note

- All the CLI actions (for example, add, activate, and so on) are executed on all the available FRUs.
- The configuration save prompt will appear if an unsaved configuration is detected.
- The reload prompt will appear after the install activate step in this workflow. Use the **prompt-level none** keyword to automatically ignore the confirmation prompts.

The three-step installation procedure can be used only after the platform is in install mode. This option provides more flexibility and control to the customer during installation.

This procedure uses individual **install add**, **install activate**, and **install commit** commands for installing a software package, and to upgrade the platform to a new version.

SUMMARY STEPS

1. **enable**
2. **install add file location:** *filename*
3. **show install summary**
4. **install activate** [**auto-abort-timer** *<time>*]
5. **install abort**
6. **install commit**
7. **install rollback to committed**
8. **install remove** {*file filesystem: filename* | **inactive**}
9. **show install summary**
10. **exit**

DETAILED STEPS

	Command or Action	Purpose
Step 1	enable Example: Device>enable	Enables privileged EXEC mode. Enter your password, if prompted.
Step 2	install add file location: <i>filename</i> Example: Device#install add file bootflash:c8000e-universalk9-ED_V17_THR0TTL_LATEST_20211027_030841_V17_7_0_120.SPA.bin	Copies the software install package from a remote location (through FTP, HTTP, HTTPS, or TFTP) to the platform, and extracts the individual components of the .package file into subpackages and packages.conf files.
Step 3	show install summary Example: Device#show install summary	(Optional) Provides an overview of the image versions and their corresponding install state for all the FRUs.

	Command or Action	Purpose
Step 4	install activate [auto-abort-timer <time>] Example: Device# install activate auto-abort-timer 120	Activates the previously added package and reloads the platform. <ul style="list-style-type: none"> • When doing a full software install, do not provide a package filename. • In the three-step variant, auto-abort-timer starts automatically with the install activate command; the default for the timer is 120 minutes. If the install commit command is not run before the timer expires, the install process is automatically terminated. The platform reloads and boots up with the last committed version.
Step 5	install abort Example: Device#install abort	(Optional) Terminates the software install activation and returns the platform to the last committed version. <ul style="list-style-type: none"> • Use this command only when the image is in activated state, and not when the image is in committed state.
Step 6	install commit Example: Device#install commit	Commits the new package installation and makes the changes persistent over reloads.
Step 7	install rollback to committed Example: Device#install rollback to committed	(Optional) Rolls back the platform to the last committed state.
Step 8	install remove { file <i>filesystem: filename</i> inactive } Example: Device#install remove inactive	(Optional) Deletes software installation files. <ul style="list-style-type: none"> • file: Deletes a specific file • inactive: Deletes all the unused and inactive installation files.
Step 9	show install summary Example: Device#show install summary	(Optional) Displays information about the current state of the system. The output of this command varies according to the install commands run prior to this command.
Step 10	exit Example: Device#exit	Exits privileged EXEC mode and returns to user EXEC mode.

Upgrading in Install Mode

Use either the one-step installation or the three-step installation to upgrade the platform in install mode.

Downgrading in Install Mode

Use the **install rollback** command to downgrade the platform to a previous version by pointing it to the appropriate image, provided the image you are downgrading to was installed in install mode.

The **install rollback** command reloads the platform and boots it with the previous image.



Note The **install rollback** command succeeds only if you have not removed the previous file using the **install remove inactive** command.

Alternatively, you can downgrade by installing the older image using the **install** commands.

Terminating a Software Installation

You can terminate the activation of a software package in the following ways:

- When the platform reloads after activating a new image, the auto-abort-timer is triggered (in the three-step install variant). If the timer expires before issuing the **install commit** command, the installation process is terminated, and the platform reloads and boots with the last committed version of the software image.

Alternatively, use the **install auto-abort-timer stop** command to stop this timer, without using the **install commit** command. The new image remains uncommitted in this process.

- Using the **install abort** command returns the platform to the version that was running before installing the new software. Use this command before issuing the **install commit** command.

Configuration Examples for Installing the Software Using install Commands

The following is an example of the one-step installation or converting from bundle mode to install mode:

```
Router# install add file
bootflash:c8000be-universalk9.BLD_V177_THROTTLE_LATEST_20211021_031123_V17_7_0_117.SSA.bin
  activate commit
install_add_activate_commit: START Thu Oct 28 21:57:21 UTC 2021

System configuration has been modified.
Press Yes(y) to save the configuration and proceed.
Press No(n) for proceeding without saving the configuration.
Press Quit(q) to exit, you may save configuration and re-enter the command. [y/n/q]y
Building configuration...

[OK]Modified configuration has been saved

*Oct 28 21:57:39.818: %SYS-6-PRIVCFG_ENCRYPT_SUCCESS: Successfully encrypted private config
file
*Oct 28 21:57:39.925: %INSTALL-5-INSTALL_START_INFO: R0/0: install_engine: Started install
one-shot
bootflash:c8000be-universalk9.BLD_V177_THROTTLE_LATEST_20211021_031123_V17_7_0_117.SSA.bininstall_add_activate_commit:
Adding PACKAGE
```

```

install_add_activate_commit: Checking whether new add is allowed ....

--- Starting Add ---
Performing Add on Active/Standby
  [1] Add package(s) on R0
  [1] Finished Add on R0
Checking status of Add on [R0]
Add: Passed on [R0]
Finished Add

Image added. Version: 17.07.01.0.1515
install_add_activate_commit: Activating PACKAGE
Following packages shall be activated:
/bootflash/c8000be-rpboot.BLD_V177_THROTTLE_LATEST_20211021_031123_V17_7_0_117.SSA.pkg
/bootflash/c8000be-mono-universalk9.BLD_V177_THROTTLE_LATEST_20211021_031123_V17_7_0_117.SSA.pkg
/bootflash/c8000be-firmware_sm_nim_adpt.BLD_V177_THROTTLE_LATEST_20211021_031123_V17_7_0_117.SSA.pkg
/bootflash/c8000be-firmware_sm_dsp_sp2700.BLD_V177_THROTTLE_LATEST_20211021_031123_V17_7_0_117.SSA.pkg
/bootflash/c8000be-firmware_sm_async.BLD_V177_THROTTLE_LATEST_20211021_031123_V17_7_0_117.SSA.pkg
/bootflash/c8000be-firmware_sm_lt3e3.BLD_V177_THROTTLE_LATEST_20211021_031123_V17_7_0_117.SSA.pkg
/bootflash/c8000be-firmware_sm_10g.BLD_V177_THROTTLE_LATEST_20211021_031123_V17_7_0_117.SSA.pkg
/bootflash/c8000be-firmware_prince.BLD_V177_THROTTLE_LATEST_20211021_031123_V17_7_0_117.SSA.pkg
/bootflash/c8000be-firmware_nim_xdsl.BLD_V177_THROTTLE_LATEST_20211021_031123_V17_7_0_117.SSA.pkg
/bootflash/c8000be-firmware_nim_ssd.BLD_V177_THROTTLE_LATEST_20211021_031123_V17_7_0_117.SSA.pkg
/bootflash/c8000be-firmware_nim_shdsl.BLD_V177_THROTTLE_LATEST_20211021_031123_V17_7_0_117.SSA.pkg
/bootflash/c8000be-firmware_nim_ge.BLD_V177_THROTTLE_LATEST_20211021_031123_V17_7_0_117.SSA.pkg
/bootflash/c8000be-firmware_nim_cwan.BLD_V177_THROTTLE_LATEST_20211021_031123_V17_7_0_117.SSA.pkg
/bootflash/c8000be-firmware_nim_bri_st_fw.BLD_V177_THROTTLE_LATEST_20211021_031123_V17_7_0_117.SSA.pkg
/bootflash/c8000be-firmware_nim_async.BLD_V177_THROTTLE_LATEST_20211021_031123_V17_7_0_117.SSA.pkg
/bootflash/c8000be-firmware_ngwic_t1e1.BLD_V177_THROTTLE_LATEST_20211021_031123_V17_7_0_117.SSA.pkg
/bootflash/c8000be-firmware_dsp_tilegx.BLD_V177_THROTTLE_LATEST_20211021_031123_V17_7_0_117.SSA.pkg
/bootflash/c8000be-firmware_dsp_sp2700.BLD_V177_THROTTLE_LATEST_20211021_031123_V17_7_0_117.SSA.pkg
/bootflash/c8000be-firmware_dsp_analogbri.BLD_V177_THROTTLE_LATEST_20211021_031123_V17_7_0_117.SSA.pkg
/bootflash/c8000be-firmware_dreamliner.BLD_V177_THROTTLE_LATEST_20211021_031123_V17_7_0_117.SSA.pkg

This operation may require a reload of the system. Do you want to proceed? [y/n]
--- Starting Activate ---
Performing Activate on Active/Standby

*Oct 28 22:05:49.484: %INSTALL-5-INSTALL_AUTO_ABORT_TIMER_PROGRESS: R0/0: rollback_timer:
Install auto abort timer will expire in 7200 seconds  [1] Activate package(s) on R0
  [1] Finished Activate on R0
Checking status of Activate on [R0]
Activate: Passed on [R0]
Finished Activate

--- Starting Commit ---
Performing Commit on Active/Standby
  [1] Commit package(s) on R0

Building configuration...
  [1] Finished Commit on R0
Checking status of Commit on [R0]
Commit: Passed on [R0]
Finished Commit

[OK]
*Oct 28 22:06:55.375: %SYS-6-PRIVCFG_ENCRYPT_SUCCESS: Successfully encrypted private config
fileSend model notification for install_add_activate_commit before reload
Install will reload the system now!
SUCCESS: install_add_activate_commit  Thu Oct 28 22:07:22 UTC 2021

Router#
*Oct 28 22:07:22.661: %INSTALL-5-INSTALL_COMPLETED_INFO: R0/0: install_engine: Completed
install one-shot PACKAGE

```

```
bootflash:c8000be-universalk9.BLD_V177_THROTTLE_LATEST_20211021_031123_V17_7_0_117.SSA.binOct
 28 22:07:26.864: %PMAN-5-EXITACTION: R0/0: pvp: Process manager is exiting: reload action
  requested
```

□

Press RETURN to get started!

The following is an example of the three-step installation:

```
Router# install add file
bootflash:c8000be-universalk9.BLD_V177_THROTTLE_LATEST_20211027_030841_V17_7_0_120.SSA.bin

install_add: START Thu Oct 28 22:36:43 UTC 2021

*Oct 28 22:36:44.526: %INSTALL-5-INSTALL_START_INFO: R0/0: install_engine: Started install
 add
bootflash:c8000be-universalk9.BLD_V177_THROTTLE_LATEST_20211027_030841_V17_7_0_120.SSA.bininstall_add:
 Adding PACKAGE
install_add: Checking whether new add is allowed ....

--- Starting Add ---
Performing Add on Active/Standby
  [1] Add package(s) on R0
  [1] Finished Add on R0
Checking status of Add on [R0]
Add: Passed on [R0]
Finished Add

Image added. Version: 17.07.01.0.1601
SUCCESS: install_add Thu Oct 28 22:40:25 UTC 2021

Router#
*Oct 28 22:40:25.971: %INSTALL-5-INSTALL_COMPLETED_INFO: R0/0: install_engine: Completed
install add PACKAGE
bootflash:c8000be-universalk9.BLD_V177_THROTTLE_LATEST_20211027_030841_V17_7_0_120.SSA.bin

Router# show install log
[0|install_op_boot]: START Thu Oct 28 22:09:29 Universal 2021
[0|install_op_boot(INFO, )]: Mount IMG INI state base image
[0|install_op_boot]: END SUCCESS Thu Oct 28 22:09:30 Universal 2021
[0|install_op_boot(INFO, )]: cleanup_trap remote_invocation 0 operation install_op_boot
.. 0 .. 0
[1|display_install_log]: START Thu Oct 28 22:12:11 UTC 2021
[2|install_add]: START Thu Oct 28 22:36:43 UTC 2021
[2|install_add(INFO, )]: Set INSTALL_TYPE to PACKAGE
[2|install_add(CONSOLE, )]: Adding PACKAGE
[2|install_add(CONSOLE, )]: Checking whether new add is allowed ....
[2|install_add(INFO, )]: check_add_op_allowed: Install type PACKAGE
[remote|install_add]: START Thu Oct 28 22:37:12 UTC 2021
[remote|install_add]: END SUCCESS Thu Oct 28 22:40:10 UTC 2021
[remote|install_add(INFO, )]: cleanup_trap remote_invocation 1 operation install_add .. 0
.. 0
[2|install_add(INFO, )]: Remote output from R0
[2|install_add(INFO, )]: install_add: START Thu Oct 28 22:37:12 UTC 2021
Expanding image file:
bootflash:c8000be-universalk9.BLD_V177_THROTTLE_LATEST_20211027_030841_V17_7_0_120.SSA.bin
Verifying parameters
Expanding superpackage
bootflash:c8000be-universalk9.BLD_V177_THROTTLE_LATEST_20211027_030841_V17_7_0_120.SSA.bin
... parameters verified
Validating package type
... package type validated
```

```

Copying package files
  c8000be-firmware_dreamliner.BLD_V177_THROTTLE_LATEST_20211027_030841_V17_7_0_120.SSA.pkg

c8000be-firmware_dsp_analogbri.BLD_V177_THROTTLE_LATEST_20211027_030841_V17_7_0_120.SSA.pkg

  c8000be-firmware_dsp_sp2700.BLD_V177_THROTTLE_LATEST_20211027_030841_V17_7_0_120.SSA.pkg
  c8000be-firmware_dsp_tilegx.BLD_V177_THROTTLE_LATEST_20211027_030841_V17_7_0_120.SSA.pkg
  c8000be-firmware_ngwic_t1e1.BLD_V177_THROTTLE_LATEST_20211027_030841_V17_7_0_120.SSA.pkg
  c8000be-firmware_nim_async.BLD_V177_THROTTLE_LATEST_20211027_030841_V17_7_0_120.SSA.pkg

c8000be-firmware_nim_bri_st_fw.BLD_V177_THROTTLE_LATEST_20211027_030841_V17_7_0_120.SSA.pkg

  c8000be-firmware_nim_cwan.BLD_V177_THROTTLE_LATEST_20211027_030841_V17_7_0_120.SSA.pkg
  c8000be-firmware_nim_ge.BLD_V177_THROTTLE_LATEST_20211027_030841_V17_7_0_120.SSA.pkg
  c8000be-firmware_nim_shdsl.BLD_V177_THROTTLE_LATEST_20211027_030841_V17_7_0_120.SSA.pkg

  c8000be-firmware_nim_ssd.BLD_V177_THROTTLE_LATEST_20211027_030841_V17_7_0_120.SSA.pkg
  c8000be-firmware_nim_xdsl.BLD_V177_THROTTLE_LATEST_20211027_030841_V17_7_0_120.SSA.pkg
  c8000be-firmware_prince.BLD_V177_THROTTLE_LATEST_20211027_030841_V17_7_0_120.SSA.pkg
  c8000be-firmware_sm_10g.BLD_V177_THROTTLE_LATEST_20211027_030841_V17_7_0_120.SSA.pkg
  c8000be-firmware_sm_1t3e3.BLD_V177_THROTTLE_LATEST_20211027_030841_V17_7_0_120.SSA.pkg
  c8000be-firmware_sm_async.BLD_V177_THROTTLE_LATEST_20211027_030841_V17_7_0_120.SSA.pkg

c8000be-firmware_sm_dsp_sp2700.BLD_V177_THROTTLE_LATEST_20211027_030841_V17_7_0_120.SSA.pkg

  c8000be-firmware_sm_nim_adpt.BLD_V177_THROTTLE_LATEST_20211027_030841_V17_7_0_120.SSA.pkg

  c8000be-mono-universalk9.BLD_V177_THROTTLE_LATEST_20211027_030841_V17_7_0_120.SSA.pkg
  c8000be-rpboot.BLD_V177_THROTTLE_LATEST_20211027_030841_V17_7_0_120.SSA.pkg
WARNING: A different version of provisioning file packages.conf already exists in bootflash:

WARNING: The provisioning file from the expanded bundle will be saved as
WARNING: bootflash:c8000be-universalk9.BLD_V177_THROTTLE_LATEST_20211027_0.conf
... package files copied
SUCCESS: Finished expanding all-in-one software package.
Image file expanded
SUCCESS: install_add Thu Oct 28 22:40:10 UTC 2021
[2|install_add]: END SUCCESS Thu Oct 28 22:40:25 UTC 2021
[2|install_add(INFO, )]: cleanup_trap remote_invocation 0 operation install_add .. 0 .. 0
[3|COMP_CHECK]: START Thu Oct 28 22:40:26 UTC 2021
[3|COMP_CHECK]: END FAILED exit(1) Thu Oct 28 22:40:27 UTC 2021
[3|COMP_CHECK(INFO, )]: cleanup_trap remote_invocation 0 operation COMP_CHECK .. 1 .. 1
[4|install_activate]: START Thu Oct 28 22:42:53 UTC 2021
[4|install_activate(INFO, )]: install_cli
[4|install_activate(CONSOLE, )]: Activating PACKAGE
[4|install_activate(INFO, )]: Acquiring transaction lock...
[4|install_activate(INFO, )]: global_trans_lock:
/bootflash/.installer/install_global_trans_lock
[4|install_activate(INFO, )]: tmp_global_trans_lock: /tmp/tmp_install_global_trans_lock
[4|install_activate(INFO, )]: tmp lock does not exist: /tmp/tmp_install_global_trans_lock
[4|install_activate(INFO, )]: global_trans_lock:
/bootflash/.installer/install_global_trans_lock
[4|install_activate(INFO, )]: tmp_global_trans_lock: /tmp/tmp_install_global_trans_lock
[4|install_activate(INFO, )]: local_trans_lock: /bootflash/.installer/install_local_trans_lock
[4|install_activate(INFO, )]: global_trans_lock:
/bootflash/.installer/install_global_trans_lock
[4|install_activate(INFO, )]: validate_lock: lock_duration is 7200
[4|install_activate(INFO, )]: install type stored in lock PACKAGE, install type PACKAGE,
install operation install_activate

```



```
[4|install_activate(INFO, )]: lock duration: 7200
[4|install_activate(INFO, )]: extend trans lock done.
/bootflash/.installer/install_global_trans_lock
[4|install_activate(INFO, require user prompt)]: install_cli
[4|install_activate( FATAL)]: Cannot proceed activate because of user input
[4|install_activate(INFO, )]: cleanup_trap remote_invocation 0 operation install_activate
.. 6 .. 0
[5|install_add]: START Thu Oct 28 22:45:48 UTC 2021
[5|install_add(INFO, )]: Set INSTALL_TYPE to PACKAGE
[5|install_add(CONSOLE, )]: Adding PACKAGE
[5|install_add(CONSOLE, )]: Checking whether new add is allowed ....
[5|install_add(INFO, )]: check_add_op_allowed: Install type PACKAGE
[5|install_add( FATAL)]: Super package already added. Add operation not allowed. install
remove inactive can be used to discard added packages
```

```
Router# install activate
install_activate: START Thu Oct 28 23:57:57 UTC 2021
install_activate: Activating PACKAGE
```

```
*Oct 28 23:57:57.823: %INSTALL-5-INSTALL_START_INFO: R0/0: install_engine: Started install
activateFollowing packages shall be activated:
/bootflash/c8000be-rpboot.BLD_V177_THROTTLE_LATEST_20211027_030841_V17_7_0_120.SSA.pkg
/bootflash/c8000be-mono-universalk9.BLD_V177_THROTTLE_LATEST_20211027_030841_V17_7_0_120.SSA.pkg
/bootflash/c8000be-firmware_sm_nim_adpt.BLD_V177_THROTTLE_LATEST_20211027_030841_V17_7_0_120.SSA.pkg
/bootflash/c8000be-firmware_sm_dsp_sp2700.BLD_V177_THROTTLE_LATEST_20211027_030841_V17_7_0_120.SSA.pkg
/bootflash/c8000be-firmware_sm_async.BLD_V177_THROTTLE_LATEST_20211027_030841_V17_7_0_120.SSA.pkg
/bootflash/c8000be-firmware_sm_lt3e3.BLD_V177_THROTTLE_LATEST_20211027_030841_V17_7_0_120.SSA.pkg
/bootflash/c8000be-firmware_sm_10g.BLD_V177_THROTTLE_LATEST_20211027_030841_V17_7_0_120.SSA.pkg
/bootflash/c8000be-firmware_prince.BLD_V177_THROTTLE_LATEST_20211027_030841_V17_7_0_120.SSA.pkg
/bootflash/c8000be-firmware_nim_xdsl.BLD_V177_THROTTLE_LATEST_20211027_030841_V17_7_0_120.SSA.pkg
/bootflash/c8000be-firmware_nim_ssd.BLD_V177_THROTTLE_LATEST_20211027_030841_V17_7_0_120.SSA.pkg
/bootflash/c8000be-firmware_nim_shdsl.BLD_V177_THROTTLE_LATEST_20211027_030841_V17_7_0_120.SSA.pkg
/bootflash/c8000be-firmware_nim_ge.BLD_V177_THROTTLE_LATEST_20211027_030841_V17_7_0_120.SSA.pkg
/bootflash/c8000be-firmware_nim_cwan.BLD_V177_THROTTLE_LATEST_20211027_030841_V17_7_0_120.SSA.pkg
/bootflash/c8000be-firmware_nim_bri_st_fw.BLD_V177_THROTTLE_LATEST_20211027_030841_V17_7_0_120.SSA.pkg
/bootflash/c8000be-firmware_nim_async.BLD_V177_THROTTLE_LATEST_20211027_030841_V17_7_0_120.SSA.pkg
/bootflash/c8000be-firmware_ngwic_tle1.BLD_V177_THROTTLE_LATEST_20211027_030841_V17_7_0_120.SSA.pkg
/bootflash/c8000be-firmware_dsp_tilegx.BLD_V177_THROTTLE_LATEST_20211027_030841_V17_7_0_120.SSA.pkg
/bootflash/c8000be-firmware_dsp_sp2700.BLD_V177_THROTTLE_LATEST_20211027_030841_V17_7_0_120.SSA.pkg
/bootflash/c8000be-firmware_dsp_analogbri.BLD_V177_THROTTLE_LATEST_20211027_030841_V17_7_0_120.SSA.pkg
/bootflash/c8000be-firmware_dreamliner.BLD_V177_THROTTLE_LATEST_20211027_030841_V17_7_0_120.SSA.pkg
```

```
This operation may require a reload of the system. Do you want to proceed? [y/n]
--- Starting Activate ---
Performing Activate on Active/Standby
```

```
*Oct 29 00:04:19.400: %INSTALL-5-INSTALL_AUTO_ABORT_TIMER_PROGRESS: R0/0: rollback_timer:
Install auto abort timer will expire in 7200 seconds [1] Activate package(s) on R0
--- Starting list of software package changes ---
Old files list:
Modified
c8000be-firmware_dreamliner.BLD_V177_THROTTLE_LATEST_20211021_031123_V17_7_0_117.SSA.pkg
Modified
c8000be-firmware_dsp_analogbri.BLD_V177_THROTTLE_LATEST_20211021_031123_V17_7_0_117.SSA.pkg
Modified
c8000be-firmware_dsp_sp2700.BLD_V177_THROTTLE_LATEST_20211021_031123_V17_7_0_117.SSA.pkg
Modified
c8000be-firmware_dsp_tilegx.BLD_V177_THROTTLE_LATEST_20211021_031123_V17_7_0_117.SSA.pkg
Modified
c8000be-firmware_ngwic_tle1.BLD_V177_THROTTLE_LATEST_20211021_031123_V17_7_0_117.SSA.pkg
Modified
c8000be-firmware_nim_async.BLD_V177_THROTTLE_LATEST_20211021_031123_V17_7_0_117.SSA.pkg
Modified
```

```

c8000be-firmware_nim_bri_st_fw.BLD_V177_THROTTLE_LATEST_20211021_031123_V17_7_0_117.SSA.pkg
    Modified
c8000be-firmware_nim_cwan.BLD_V177_THROTTLE_LATEST_20211021_031123_V17_7_0_117.SSA.pkg
    Modified
c8000be-firmware_nim_ge.BLD_V177_THROTTLE_LATEST_20211021_031123_V17_7_0_117.SSA.pkg
    Modified
c8000be-firmware_nim_shdsl.BLD_V177_THROTTLE_LATEST_20211021_031123_V17_7_0_117.SSA.pkg
    Modified
c8000be-firmware_nim_ssd.BLD_V177_THROTTLE_LATEST_20211021_031123_V17_7_0_117.SSA.pkg
    Modified
c8000be-firmware_nim_xdsl.BLD_V177_THROTTLE_LATEST_20211021_031123_V17_7_0_117.SSA.pkg
    Modified
c8000be-firmware_prince.BLD_V177_THROTTLE_LATEST_20211021_031123_V17_7_0_117.SSA.pkg
    Modified
c8000be-firmware_sm_10g.BLD_V177_THROTTLE_LATEST_20211021_031123_V17_7_0_117.SSA.pkg
    Modified
c8000be-firmware_sm_1t3e3.BLD_V177_THROTTLE_LATEST_20211021_031123_V17_7_0_117.SSA.pkg
    Modified
c8000be-firmware_sm_async.BLD_V177_THROTTLE_LATEST_20211021_031123_V17_7_0_117.SSA.pkg
    Modified
c8000be-firmware_sm_dsp_sp2700.BLD_V177_THROTTLE_LATEST_20211021_031123_V17_7_0_117.SSA.pkg
    Modified
c8000be-firmware_sm_nim_adpt.BLD_V177_THROTTLE_LATEST_20211021_031123_V17_7_0_117.SSA.pkg
    Modified
c8000be-mono-universalk9.BLD_V177_THROTTLE_LATEST_20211021_031123_V17_7_0_117.SSA.pkg
    Modified c8000be-rpboot.BLD_V177_THROTTLE_LATEST_20211021_031123_V17_7_0_117.SSA.pkg
    New files list:
    Added
c8000be-firmware_dreamliner.BLD_V177_THROTTLE_LATEST_20211027_030841_V17_7_0_120.SSA.pkg
    Added
c8000be-firmware_dsp_analogbri.BLD_V177_THROTTLE_LATEST_20211027_030841_V17_7_0_120.SSA.pkg
    Added
c8000be-firmware_dsp_sp2700.BLD_V177_THROTTLE_LATEST_20211027_030841_V17_7_0_120.SSA.pkg
    Added
c8000be-firmware_dsp_tilegx.BLD_V177_THROTTLE_LATEST_20211027_030841_V17_7_0_120.SSA.pkg
    Added
c8000be-firmware_ngwic_t1e1.BLD_V177_THROTTLE_LATEST_20211027_030841_V17_7_0_120.SSA.pkg
    Added
c8000be-firmware_nim_async.BLD_V177_THROTTLE_LATEST_20211027_030841_V17_7_0_120.SSA.pkg
    Added
c8000be-firmware_nim_bri_st_fw.BLD_V177_THROTTLE_LATEST_20211027_030841_V17_7_0_120.SSA.pkg
    Added
c8000be-firmware_nim_cwan.BLD_V177_THROTTLE_LATEST_20211027_030841_V17_7_0_120.SSA.pkg
    Added
c8000be-firmware_nim_ge.BLD_V177_THROTTLE_LATEST_20211027_030841_V17_7_0_120.SSA.pkg
    Added
c8000be-firmware_nim_shdsl.BLD_V177_THROTTLE_LATEST_20211027_030841_V17_7_0_120.SSA.pkg
    Added
c8000be-firmware_nim_ssd.BLD_V177_THROTTLE_LATEST_20211027_030841_V17_7_0_120.SSA.pkg
    Added
c8000be-firmware_nim_xdsl.BLD_V177_THROTTLE_LATEST_20211027_030841_V17_7_0_120.SSA.pkg
    Added
c8000be-firmware_prince.BLD_V177_THROTTLE_LATEST_20211027_030841_V17_7_0_120.SSA.pkg
    Added
c8000be-firmware_sm_10g.BLD_V177_THROTTLE_LATEST_20211027_030841_V17_7_0_120.SSA.pkg
    Added
c8000be-firmware_sm_1t3e3.BLD_V177_THROTTLE_LATEST_20211027_030841_V17_7_0_120.SSA.pkg
    Added
c8000be-firmware_sm_async.BLD_V177_THROTTLE_LATEST_20211027_030841_V17_7_0_120.SSA.pkg
    Added

```

```

c8000be-firmware_sm_dsp_sp2700.BLD_V177_THROTTLE_LATEST_20211027_030841_V17_7_0_120.SSA.pkg
    Added
c8000be-firmware_sm_nim_adpt.BLD_V177_THROTTLE_LATEST_20211027_030841_V17_7_0_120.SSA.pkg
    Added
c8000be-mono-universalk9.BLD_V177_THROTTLE_LATEST_20211027_030841_V17_7_0_120.SSA.pkg
    Added c8000be-rpboot.BLD_V177_THROTTLE_LATEST_20211027_030841_V17_7_0_120.SSA.pkg
    Finished list of software package changes
    [1] Finished Activate on R0
Checking status of Activate on [R0]
Activate: Passed on [R0]
Finished Activate

Send model notification for install_activate before reload
Install will reload the system now!
SUCCESS: install_activate  Fri Oct 29 00:05:09 UTC 2021

Router#
*Oct 29 00:05:09.504: %INSTALL-5-INSTALL_COMPLETED_INFO: R0/0: install_engine: Completed
install activate PACKAGEOct 29 00:05:14.494: %PMAN-5-EXITACTION: R0/0: pvp: Process manager
is exiting: reload action requested

Initializing Hardware ...

Checking for PCIe device presence...done
System integrity status: 0x610

System Bootstrap, Version 17.3(4.1r), RELEASE SOFTWARE
Copyright (c) 1994-2021 by cisco Systems, Inc.

Current image running   : Boot ROM1
Last reset cause       : LocalSoft
C8300-2N2S-6T platform with 8388608 Kbytes of main memory

□

Press RETURN to get started!

□

Router# install commit
install_commit: START Fri Oct 29 00:13:58 UTC 2021
install_commit: Committing PACKAGE

--- Starting Commit ---
Performing Commit on Active/Standby

*Oct 29 00:13:59.552: %INSTALL-5-INSTALL_START_INFO: R0/0: install_engine: Started install
commit [1] Commit package(s) on R0
    [1] Finished Commit on R0
Checking status of Commit on [R0]
Commit: Passed on [R0]
Finished Commit

SUCCESS: install_commit  Fri Oct 29 00:14:03 UTC 2021

Router#
*Oct 29 00:14:03.712: %INSTALL-5-INSTALL_COMPLETED_INFO: R0/0: install_engine: Completed
install commit PACKAGE

```

The following is an example of downgrading in install mode:

```

ROUTER# install activate file bootflash:c8000be-universalk9.17.06.01a.SPA.bin activate
commit

install_add_activate_commit: START Fri Dec 10 18:07:17 GMT 2021

*Dec 10 18:07:18.405 GMT: %INSTALL-5-INSTALL_START_INFO: R0/0: install_engine: Started
install one-shot bootflash:c8000be-universalk9.17.06.01a.SPA.bininstall_add_activate_commit:
  Adding PACKAGE
install_add_activate_commit: Checking whether new add is allowed ....

--- Starting Add ---
Performing Add on Active/Standby
  [1] Add package(s) on R0
  [1] Finished Add on R0
Checking status of Add on [R0]
Add: Passed on [R0]
Finished Add

Image added. Version: 17.06.01a.0.298
install_add_activate_commit: Activating PACKAGE
Following packages shall be activated:
/bootflash/c8000be-rpboot.17.06.01a.SPA.pkg
/bootflash/c8000be-mono-universalk9.17.06.01a.SPA.pkg
/bootflash/c8000be-firmware_sm_nim_adpt.17.06.01a.SPA.pkg
/bootflash/c8000be-firmware_sm_dsp_sp2700.17.06.01a.SPA.pkg
/bootflash/c8000be-firmware_sm_async.17.06.01a.SPA.pkg
/bootflash/c8000be-firmware_sm_lt3e3.17.06.01a.SPA.pkg
/bootflash/c8000be-firmware_sm_10g.17.06.01a.SPA.pkg
/bootflash/c8000be-firmware_prince.17.06.01a.SPA.pkg
/bootflash/c8000be-firmware_nim_xdsl.17.06.01a.SPA.pkg
/bootflash/c8000be-firmware_nim_ssd.17.06.01a.SPA.pkg
/bootflash/c8000be-firmware_nim_shdsl.17.06.01a.SPA.pkg
/bootflash/c8000be-firmware_nim_ge.17.06.01a.SPA.pkg
/bootflash/c8000be-firmware_nim_cwan.17.06.01a.SPA.pkg
/bootflash/c8000be-firmware_nim_bri_st_fw.17.06.01a.SPA.pkg
/bootflash/c8000be-firmware_nim_async.17.06.01a.SPA.pkg
/bootflash/c8000be-firmware_ngwic_tle1.17.06.01a.SPA.pkg
/bootflash/c8000be-firmware_dsp_tilegx.17.06.01a.SPA.pkg
/bootflash/c8000be-firmware_dsp_sp2700.17.06.01a.SPA.pkg
/bootflash/c8000be-firmware_dsp_analogbri.17.06.01a.SPA.pkg
/bootflash/c8000be-firmware_dreamliner.17.06.01a.SPA.pkg

This operation may require a reload of the system. Do you want to proceed? [y/n]
--- Starting Activate ---
Performing Activate on Active/Standby
  [1] Activate package(s) on R0
  [1] Finished Activate on R0
Checking status of Activate on [R0]
Activate: Passed on [R0]
Finished Activate

--- Starting Commit ---
Performing Commit on Active/Standby
  [1] Commit package(s) on R0
Building configuration...

  [1] Finished Commit on R0
Checking status of Commit on [R0]
Commit: Passed on [R0]
Finished Commit

[OK]
*Dec 10 18:14:57.782 GMT: %SYS-6-PRIVCFG_ENCRYPT_SUCCESS: Successfully encrypted private
config fileSend model notification for install_add_activate_commit before reload

```

```
/usr/binos/conf/install_util.sh: line 164: /bootflash/.prst_sync/reload_info: No such file
or directory
/usr/binos/conf/install_util.sh: line 168: /bootflash/.prst_sync/reload_info: No such file
or directory
cat: /bootflash/.prst_sync/reload_info: No such file or directory
Install will reload the system now!
SUCCESS: install_add_activate_commit  Fri Dec 10 18:15:23 GMT 2021

ROUTER#
*Dec 10 18:15:23.955 GMT: %INSTALL-5-INSTALL_COMPLETED_INFO: R0/0: install_engine: Completed
install one-shot PACKAGE bootflash:c8000be-universalk9.17.06.01a.SPA.binDec 10 18:15:27.708:
%PMAN-5-EXITACTION: R0/0: pvp: Process manager is exiting: reload action requested

Initializing Hardware ...

Checking for PCIe device presence...done
System integrity status: 0x610
Rom image verified correctly

System Bootstrap, Version 17.3(5r), RELEASE SOFTWARE
Copyright (c) 1994-2021 by cisco Systems, Inc.

Current image running: Boot ROM0

Last reset cause: LocalSoft
ROUTER platform with 8388608 Kbytes of main memory

□

Press RETURN to get started!

□

ROUTER#
ROUTER# show version
Cisco IOS XE Software, Version 17.06.01a
Cisco IOS Software [Bengaluru], c8000be Software (X86_64_LINUX_IOSD-UNIVERSALK9-M), Version
17.6.1a, RELEASE SOFTWARE (fc2)
Technical Support: http://www.cisco.com/techsupport
Copyright (c) 1986-2021 by Cisco Systems, Inc.
Compiled Sat 21-Aug-21 03:27 by mcpre

Cisco IOS-XE software, Copyright (c) 2005-2021 by cisco Systems, Inc.
All rights reserved. Certain components of Cisco IOS-XE software are
licensed under the GNU General Public License ("GPL") Version 2.0. The
software code licensed under GPL Version 2.0 is free software that comes
with ABSOLUTELY NO WARRANTY. You can redistribute and/or modify such
GPL code under the terms of GPL Version 2.0. For more details, see the
documentation or "License Notice" file accompanying the IOS-XE software,
or the applicable URL provided on the flyer accompanying the IOS-XE
software.

ROM: 17.3(5r)

ROUTER uptime is 0 minutes
Uptime for this control processor is 2 minutes
System returned to ROM by LocalSoft
System image file is "bootflash:packages.conf"
Last reload reason: LocalSoft

This product contains cryptographic features and is subject to United
States and local country laws governing import, export, transfer and
use. Delivery of Cisco cryptographic products does not imply
third-party authority to import, export, distribute or use encryption.
```

Importers, exporters, distributors and users are responsible for compliance with U.S. and local country laws. By using this product you agree to comply with applicable laws and regulations. If you are unable to comply with U.S. and local laws, return this product immediately.

A summary of U.S. laws governing Cisco cryptographic products may be found at: <http://www.cisco.com/wwl/export/crypto/tool/stqrg.html>

If you require further assistance please contact us by sending email to export@cisco.com.

Technology Package License Information:

```

-----
Technology      Type           Technology-package Current  Technology-package Next Reboot
-----
Smart License  Perpetual      None                    None
Smart License  Subscription   None                    None

```

The current crypto throughput level is 250000 kbps

Smart Licensing Status: Registration Not Applicable/Not Applicable

```

cisco ROUTER (1RU) processor with 3747220K/6147K bytes of memory.
Processor board ID FDO2521M27S
Router operating mode: Autonomous
5 Gigabit Ethernet interfaces
2 2.5 Gigabit Ethernet interfaces
2 Cellular interfaces
32768K bytes of non-volatile configuration memory.
8388608K bytes of physical memory.
7573503K bytes of flash memory at bootflash:.
1875361792K bytes of NVMe SSD at harddisk:.
16789568K bytes of USB flash at usb0:.

```

Configuration register is 0x2102

The following is an example of terminating a software installation:

```

Router# install abort
install_abort: START Fri Oct 29 02:42:51 UTC 2021

This install abort would require a reload. Do you want to proceed? [y/n]
*Oct 29 02:42:52.789:
  %INSTALL-5-INSTALL_START_INFO: R0/0: install_engine: Started install aborty
--- Starting Abort ---
Performing Abort on Active/Standby

  [1] Abort package(s) on R0
  [1] Finished Abort on R0
Checking status of Abort on [R0]
Abort: Passed on [R0]
Finished Abort

Send model notification for install_abort before reload
Install will reload the system now!
SUCCESS: install_abort  Fri Oct 29 02:44:47 UTC 2021

Router#
*Oct 29 02:44:47.866: %INSTALL-5-INSTALL_COMPLETED_INFO: R0/0: install_engine: Completed
install abort PACKAGEOct 29 02:44:51.577: %PMAN-5-EXITACTION: R0/0: pvp: Process manager

```

```

is exiting: reload action requested

Initializing Hardware ...

Checking for PCIe device presence...done
System integrity status: 0x610

System Bootstrap, Version 17.3(4.1r), RELEASE SOFTWARE
Copyright (c) 1994-2021 by cisco Systems, Inc.

Current image running   : Boot ROM1
Last reset cause        : LocalSoft
C8300-2N2S-6T platform with 8388608 Kbytes of main memory

□

Press RETURN to get started!

□

```

The following are sample outputs for show commands:

show install log

```

Device# show install log
[0|install_op_boot]: START Thu Oct 28 22:09:29 Universal 2021
[0|install_op_boot(INFO, )]: Mount IMG INI state base image
[0|install_op_boot]: END SUCCESS Thu Oct 28 22:09:30 Universal 2021

```

show install summary

```

Device# show install summary
[ R0 ] Installed Package(s) Information:
State (St): I - Inactive, U - Activated & Uncommitted,
             C - Activated & Committed, D - Deactivated & Uncommitted
-----
Type  St  Filename/Version
-----
IMG   C   17.07.01.0.1515
-----
Auto abort timer: inactive
-----

```

show install package *filesystem: filename*

```

Device# show install package
bootflash:c8000be-universalk9.BLD_V177_THROTTLE_LATEST_20211021_031123_V17_7_0_117.SSA.bin
Package: c8000be-universalk9.BLD_V177_THROTTLE_LATEST_20211021_031123_V17_7_0_117.SSA.bin
  Size: 831447859
  Timestamp: 2021-10-23 17:08:14 UTC
  Canonical path:
/bootflash/c8000be-universalk9.BLD_V177_THROTTLE_LATEST_20211021_031123_V17_7_0_117.SSA.bin

Raw disk-file SHA1sum:
  5c4e7617a6c71ffbcc73dcd034ab58bf76605e3f
Header size:      1192 bytes
Package type:     30000
Package flags:    0
Header version:   3

Internal package information:

```

```
Name: rp_super
BuildTime: 2021-10-21_13.00
ReleaseDate: 2021-10-21_03.11
BootArchitecture: i686
RouteProcessor: radium
Platform: C8000BE
User: mcpre
PackageName: universalk9
Build: BLD_V177_THROTTLE_LATEST_20211021_031123_V17_7_0_117
CardTypes:
```

Package is bootable from media and tftp.
Package contents:

```
Package:
c8000be-firmware_nim_ge.BLD_V177_THROTTLE_LATEST_20211021_031123_V17_7_0_117.SSA.pkg
Size: 2966620
Timestamp: 2021-10-21 20:10:44 UTC
```

```
Raw disk-file SHA1sum:
 501d59d5f152ca00084a0da8217bf6f6b95dddb1
Header size: 1116 bytes
Package type: 40000
Package flags: 0
Header version: 3
```

```
Internal package information:
Name: firmware_nim_ge
BuildTime: 2021-10-21_13.00
ReleaseDate: 2021-10-21_03.11
BootArchitecture: none
RouteProcessor: radium
Platform: C8000BE
User: mcpre
PackageName: firmware_nim_ge
Build: BLD_V177_THROTTLE_LATEST_20211021_031123_V17_7_0_117
CardTypes:
```

Package is not bootable.

```
Package:
c8000be-firmware_prince.BLD_V177_THROTTLE_LATEST_20211021_031123_V17_7_0_117.SSA.pkg
Size: 10204252
Timestamp: 2021-10-21 20:10:43 UTC
```

```
Raw disk-file SHA1sum:
 a57bed4ddecfd08af3b456f69d11aeb962865ea
Header size: 1116 bytes
Package type: 40000
Package flags: 0
Header version: 3
```

```
Internal package information:
Name: firmware_prince
BuildTime: 2021-10-21_13.00
ReleaseDate: 2021-10-21_03.11
BootArchitecture: none
RouteProcessor: radium
Platform: C8000BE
User: mcpre
PackageName: firmware_prince
Build: BLD_V177_THROTTLE_LATEST_20211021_031123_V17_7_0_117
CardTypes:
```

Package is not bootable.

show install active

```
Device# show install active
[ R0 ] Active Package(s) Information:
State (St): I - Inactive, U - Activated & Uncommitted,
             C - Activated & Committed, D - Deactivated & Uncommitted
-----
Type  St   Filename/Version
-----
IMG   C    17.07.01.0.1515
-----
Auto abort timer: inactive
-----
```

show install inactive

```
Device# show install inactive
[ R0 ] Inactive Package(s) Information:
State (St): I - Inactive, U - Activated & Uncommitted,
             C - Activated & Committed, D - Deactivated & Uncommitted
-----
Type  St   Filename/Version
-----
No Inactive Packages
-----
```

show install committed

```
Device# show install committed
[ R0 ] Committed Package(s) Information:
State (St): I - Inactive, U - Activated & Uncommitted,
             C - Activated & Committed, D - Deactivated & Uncommitted
-----
Type  St   Filename/Version
-----
IMG   C    17.07.01.0.1515
-----
Auto abort timer: inactive
-----
```

show install uncommitted

```
Device# show install uncommitted
[ R0 ] Uncommitted Package(s) Information:
State (St): I - Inactive, U - Activated & Uncommitted,
             C - Activated & Committed, D - Deactivated & Uncommitted
-----
Type  St   Filename/Version
-----
No Uncommitted Packages
-----
```

Troubleshooting Software Installation Using install Commands

Problem Troubleshooting the software installation

Solution Use the following show commands to view installation summary, logs, and software versions.

- **show install summary**
- **show install log**

- **show version**
- **show version running**

Problem Other installation issues

Solution Use the following commands to resolve installation issue:

- **dir** *<install directory>*
- **more location:***packages.conf*
- **show tech-support install:** this command automatically runs the **show** commands that display information specific to installation.
- **request platform software trace archive target bootflash** *<location>*: this command archives all the trace logs relevant to all the processes running on the system since the last reload, and saves this information in the specified location.



CHAPTER 8

Software Upgrade Processes Supported by Cisco ASR 1000 Series Routers

Cisco ASR 1000 Series Aggregation Services Routers support the following software upgrade procedures:

- In-Service Software Upgrades (ISSU) for redundant platforms—The ISSU process allows software to be updated or otherwise modified while packet forwarding continues with minimal interruption. ISSU supports two different software upgrade modes:
 - Consolidated package mode
 - Subpackage mode

The supported platforms include Cisco ASR 1006, ASR 1006-X, ASR 1009-X and Cisco ASR 1013 Routers

- Upgrade process with service impact for non redundant platforms—Non-hardware-redundant chassis models (such as the Cisco ASR 1001 Router, Cisco ASR 1001-X Router, Cisco ASR 1001-HX Router, Cisco ASR 1002 Router, Cisco ASR 1002-X Router, Cisco ASR 1002-HX Router, and Cisco ASR 1004 Router) do not support ISSU upgrade or downgrade. Instead subpackage software upgrade is supported only if the router is running in subpackage mode. Traffic loss cannot be avoided during the installation of the ESP package as a part of ISSU.

To upgrade your Cisco ASR 1000-RP successfully in a multi-slot chassis, a Cisco Hard Disk Drive (HDD) must be present in the RP. Without the presence of a Cisco HDD, there is a risk of upgrade failure.

If you want to upgrade the ROMMON and IOS at the same time, perform the steps given below:

- Copy the XE image to the router and configure the boot system to point to the new image.
- Copy the ROMMON package to the router and perform the ROMMON upgrade.
- Reload the router and verify that it boots to the IOS prompt on the new XE image.
- Verify that the new ROMMON image was successfully installed using a show platform.

The following table lists Compatibility matrix of the software upgrade process for various Cisco ASR 1000 Series Aggregation Services Router.

Table 14: Software Upgrade Compatibility Matrix for Various Cisco ASR 1000 Series Aggregation Services Router Platforms

Platform	Consolidated Package Upgrade	SubPackage Upgrade
Cisco ASR 1006 Router	Supported	Supported
CiscoASR 1013 Router	Supported	Supported
CiscoASR 1004 Router	Not Supported	Supported
CiscoASR 1002 Router	Not Supported	Supported
Cisco ASR 1002-X Router	Not Supported	Supported
CiscoASR 1002-F Router	Not Supported	Supported
CiscoASR 1001 Router	Not Supported	Supported
CiscoASR 1001-X Router	Not Supported	Supported
CiscoASR 1006-X Router	Supported	Supported
CiscoASR 1009-X Router	Supported	Supported
CiscoASR 1001-HX Router	Not Supported	Supported
CiscoASR 1002-HX Router	Not Supported	Supported

Finding Support Information for Platforms and Cisco IOS and Catalyst OS Software Images

Use Cisco Feature Navigator to find information about platform support and Cisco IOS and Catalyst OS software image support. To access Cisco Feature Navigator, go to <http://www.cisco.com/go/cfn>. An account on Cisco.com is not required.

- [Prerequisites for Software Upgrade Processes](#), on page 94
- [ISSU Upgrade for Redundant Platforms](#), on page 95
- [Upgrade Process with Service Impact for Nonredundant Platforms](#), on page 160
- [Minimal Disruptive Restart ISSU](#), on page 234
- [Using ISSU to Perform a Consolidated Package Upgrade in a Dual Route Processor Configuration with MDR](#), on page 236
- [Using ISSU to Upgrade the Subpackages on a Cisco ASR 1006 Router and Cisco ASR 1013 Router \(issu Command Set\) with MDR](#), on page 245
- [Using ISSU to Upgrade Subpackages on a Cisco ASR 1006 Router or Cisco ASR 1013 Router \(request platform command set\) with MDR](#), on page 283
- [Additional References](#), on page 319
- [Feature Information for Software Upgrade Process](#), on page 320

Prerequisites for Software Upgrade Processes

Be sure to complete the following prerequisites for running the ISSU process based on your chassis model:

- Refer to the ISSU compatibility tables in the *Release Notes for Cisco ASR 1000 Series Aggregation Services Routers*.
- 4 GB of DRAM memory is required for installing software upgrade on a system with RP1 route processor.
- ISSU is supported when the router is running in subpackage mode or in consolidated package mode.
- For the Cisco ASR 1001 Router, Cisco ASR 1001-X Router, ASR1001-HX Router, Cisco ASR 1002-X Router, and ASR1002-HX Router, the Cisco IOS Software redundancy requires 8-GB DRAM and the IOS software redundancy license.

ISSU Upgrade for Redundant Platforms

ISSU represent a full or partial software upgrade of a system from one version to another with minimal outage on the forwarding plane (minimal packet loss) and no outage on the control plane.

Overview of ISSU on the Cisco ASR 1000 Series Routers

For the Cisco ASR 1000 Series Routers, ISSU-compatibility depends on the software subpackage being upgraded and the hardware configuration. Consolidated packages are ISSU-compatible in dual RP configurations only and have other limitations described later in this document. Some RP and ESP software subpackages can be upgraded in service even in single RP or ESP hardware configurations via dual IOS processes running on the RP; others require dual RP or ESP configurations for an ISSU upgrade. The SPA and SIP software subpackages must be upgraded on a per-SPA or per-SIP basis.

If you are updating multiple subpackages, you should also realize that the sequence of the upgrade is important to minimize router downtime for the software upgrade.

The specific procedures in this document represent supported and tested installation sequences. The Cisco IOS XE system software allows other installation sequences for special purposes under the guidance of Cisco customer support representatives, but the steps in this document should be followed otherwise. These steps should be followed completely, as the Cisco ASR 1000 Series Routers are designed to run one version of Cisco IOS XE for all consolidated packages and subpackages on an RP, and running subpackages from different versions of Cisco IOS XE can cause unexpected router behavior.

When performing ISSU upgrades on the Cisco ASR 1000 Series Routers, it is important to remember that minimal interruption upgrades can be performed using either the **issu** command set or the **request platform** command set, and that either command set can be used to perform limited interruption individual consolidated package or subpackage upgrades.



Note ROMmon images are downloaded separately from Cisco IOS XE images and have their own installation procedures, and are therefore not mentioned as part in this document as part of the ISSU upgrade procedure.

The following table provides a list of the Cisco ASR 1000 Series Routers subpackages and whether or not they can be upgraded without losing any network traffic in single and dual RP and ESP configurations using ISSU.

Table 15: Limited Interruption Upgrade Compatibility Table

Subpackage	Nonredundant RP and ESP	Redundant RP and ESP
Consolidated package (any)	No (Reload required)	Yes (RP switchover)
RPBase	No (RP Reload required)	Yes (RP switchover)
RPControl	Yes (in-service)	Yes (in-service)
RPAccess	Yes (in-service)	Yes (in-service)
RPIOS	Yes ³ (IOS software switchover)	Yes (RP switchover)
RPBoot	No ⁴ (RP reload required)	Yes (RP reload)
ESPBase	No ⁵ (ESP reload required)	Yes ⁶ (via ESP switchover)
ESPX86Base	No ⁷ (ESP reload required)	Yes ⁸ (via ESP switchover)
SIPBase ⁹	No (SPAs in SIP do not forward traffic during upgrade)	Yes (With Minimal Disruptive Restart (MDR), traffic is forwarded with minimal interruption)
SIPSPA ¹⁰	No (SPAs in SIP do not forward traffic during upgrade)	Yes (With MDR, traffic is forwarded with minimal interruption)
ELCBase ¹¹	No (Built-in SPAs in an Ethernet Line Card (ELC) do not forward traffic during upgrade)	Yes (With MDR, traffic is forwarded with minimal interruption)
ELCSPA ¹²	No (Built-in SPAs in an ELC do not forward traffic during upgrade)	Yes (With MDR, traffic is forwarded with minimal interruption)
NIM SSD ¹³	No (NIM reload required)	NA
NGWIC T1E1 ¹⁴	No (T1E1 do not forward traffic during upgrade)	NA

³ Only supported if software redundancy is configured on the RP.

⁴ Rpbboot and Webui packages are introduced from Polaris 16.x.x release.

⁵ ESP has to reload to complete ESPBase subpackage upgrade. All router traffic will be lost during ESP upgrade.

⁶ An ESP switchover occurs as part of the upgrade, so traffic is forwarded with minimal interruption.

⁷ ESP has to reload to complete ESPBase subpackage upgrade. All router traffic will be lost during ESP upgrade and ESPX86Base is not included in the RP1 bundle.

⁸ An ESP switchover occurs as part of the upgrade, so traffic is forwarded with minimal interruption. ESPX86Base is not included in the RP1 bundle.

⁹ Any SIPBase upgrade will require the SPA interfaces to go down during the upgrade for all the SPAs in the SIP.

- ¹⁰ Any SIPSPA upgrade will require the SPA interfaces for that particular SPA to go down during the upgrade.
- ¹¹ Any ELCBase upgrade will require the ELC interfaces to go down during the upgrade for all the SPAs in the SIP. ELCBase is not included in the RP1 bundle
- ¹² Any ELCSPA upgrade will require the ELC interfaces for that particular SPA to go down during the upgrade. ELCSPA is not included in the RP1 bundle
- ¹³ NIM SSD is a built-in module available in ASR 1001-X platform. It is a slot for an extra harddisk, which helps increase the memory.
- ¹⁴ NGWIC T1E1 is a built-in module available in ASR 1001-X platform, used for serial interface. Any NGWIC T1E1 upgrade will require T1E1 interfaces for that particular SPA to go down during the upgrade.

ISSU Rollback Timer Overview

The Cisco ASR 1000 Series Router ISSU procedure has a rollback timer. Rollback timers are used for for ISSU procedures on all Cisco routers that support ISSU, but this section will provide a brief overview of ISSU rollback timers on the Cisco ASR 1000 Series Routers.

During ISSU, the rollback timer begins after the consolidated package or subpackage is loaded. If the upgrade does not move forward in the amount of time specified in the rollback timer, the configuration will automatically “roll back” to the previous configuration and the ISSU upgrade will be cancelled.

Upgrades using the **issu** command set and the **request platform** command set both have the rollback timer option. The **issu** command set always uses a rollback timer; the **request platform** command set does not use a rollback timer unless the **auto-rollback** option is used in the **request platform software package install** command line.

For the **issu** command set, the **issu acceptversion** command can be entered to stop the rollback timer without committing the upgrade during the ISSU upgrade. The **issu commitversion** command can be entered to stop the rollback timer and commit the ISSU upgrade.

For the **request platform** command set, the **request platform software package install rp slot commit** command must be entered to stop the rollback timer only in cases where the **auto-rollback** option is used.

The rollback timer for the **issu** command set can be configured by entering the **issu set rollback-timer** command. The rollback timer when used with the **request platform** command set is specified when you use the **auto-rollback** option when entering the **issu request platform software package install** command.

For ISSU upgrades on Cisco ASR 1000 Series Routers, it may be advisable to set long rollback times when the upgrade is being performed on routers with large configurations.

The amount of time left on the rollback timer during an ISSU upgrade can be checked by entering the **show issu rollback-timer** command.

Software Upgrade with Dual IOS Processes on a Single RP Overview

To complete a software upgrade of an individual subpackage using dual IOS processes on a single RP, SSO must first be enabled.

Software upgrade with dual IOS processes is useful for upgrading the individual RP subpackages that can be upgraded without a router reload. Importantly, note that most subpackage upgrades in a single RP configuration require a hardware reload to complete (whether an RP reload for an RP subpackage, an ESP reload for the ESPBase subpackage, a SIP reload for a SIPBase subpackage, or a SPA reload for the SIPSPA subpackage), so limited interruption upgrades for single RP configurations are not available in most upgrade scenarios.

Cisco IOS XE Software Package Compatibility for ISSU

When upgrading the Cisco IOS XE operating system software using the ISSU process, it is important to determine the compatibility of the upgraded software to your current software and hardware. The ISSU process allows software to be updated or otherwise modified while packet forwarding continues with minimal interruption.

Cisco IOS XE release compatibility using the ISSU process utilizes the SSO functionality to preserve state while software versions on the router differ, as during an upgrade. Most SSO-capable features in each Cisco IOS XE release are ISSU capable. ISSU is only supported if SSO is enabled in the configuration and the system is in a steady state (SSO ready state has been achieved). ISSU compatibility depends on the set of specific feature clients that are in use and whether they support ISSU. All ISSU upgrades include at least one IOS switchover operation. It is important to understand which features are in use and whether these features are ISSU compatible.

Cisco ASR1006, Cisco ASR1006-X, Cisco ASR1009-X, and Cisco ASR 1013 series routers are hardware-redundant chassis. The hardware-redundant chassis has two ESP linecards and two RPs which exchange state using hardware links. The Cisco ASR1002 and ASR1004 Series Routers are not hardware redundant, but are software-redundancy capable. The nonredundant chassis has a single RP and a single ESP, but allows the operation of up to two IOS processes on the single RP to exchange states locally.

Restrictions for ISSU

Restrictions for the ISSU procedures include:



Note Cisco IOS XE software compatibility is between “like” images, for example, *advipservicesk9* to *advipservicesk9*, *adventerprisek9* to *adventerprisek9*, and so on. Cross-image-type upgrades or installations are not supported in the ISSU process. For example, you cannot upgrade *ipbase* to *advipservicesk9* or *advipservices* to *advipservicesk9*.

- Different image types must not be run simultaneously.
- For ATM SPAs on the Cisco ASR1000 Series Routers, ISSU from releases prior to Cisco IOS XE Release 2.5.0 to Cisco IOS XE Release 2.5.0, or from Cisco IOS XE Release 2.5.0 to a release prior to Cisco IOS XE Release 2.5.0, is not supported. If you want to perform ISSU in this environment, you must first remove the configuration from the ATM SPAs on the router, and then shut down the SPAs using the **shutdown** command prior to running the ISSU process.
- Cisco IOS XE releases not listed as compatible in the ISSU compatibility tables must not be run simultaneously (in a Cisco ASR1006 series router or Cisco ASR 1013 series router) or co-installed on any of the Cisco ASR1000 Series Routers since unexpected failures of one or both RPs or state loss can be experienced. Cisco IOS XE releases listed as partially compatible may incur a loss of state. Cisco IOS XE releases listed as requiring an intermediate release are not directly compatible; however, a migration path is available to preserve some or all state by upgrading to a separate intermediate version, as shown in the tables. The tables do not cover nonredundant (software or hardware) environments as no incremental update is possible under those circumstances.
- In Cisco IOS XE Release 3.1S, ISSU upgrade and subpackage software upgrade from Cisco IOS XE Release 2.x.x to Cisco IOS XE Release 3.x.xS, including release 3.1S, are not supported. The ISSU downgrade from Cisco IOS XE Release 3.x.xS, including release 3.1S to 2.x.x, is also not supported. ISSU upgrade and subpackage software upgrade is restarted from Cisco IOS XE Release 3.1S. Therefore,

rebuilds and releases after Cisco IOS XE Release 3.1S will support ISSU and software upgrade and downgrade, based on the ISSU compatibility matrix tables.

- ISSU upgrade or downgrade between Cisco IOS XE 3.x.x release and Polaris 16.x.x release is not supported.



Note When you run the software upgrade from Cisco IOS XE Release 2.x.x to Cisco IOS XE Release 3.x.xS, you have to load the new image on both RPs, verify that it is good code, change the boot loader variable, and reboot the whole chassis. Failure to do that results in a "wedged" router and the only remedy is physically pull out one of the RPs, boot on the remaining RP, downgrade its code to the same version as the pulled out RP and start the process over again.

ISSU Upgrade Procedures

This section contains the following topics:

Using ISSU to Perform a Consolidated Package Upgrade in a Dual Route Processor Configuration

Consolidated packages can only be upgraded using ISSU in dual Route Processor configurations. ISSU is not supported for consolidated package upgrades in single Route Processor configurations.

If you want the RPs on your Cisco ASR 1000 Series router to be running using a consolidated package after the ISSU upgrade is complete, use the following instructions:



Note This procedure will only work if the current RPs are already running consolidated packages.

SUMMARY STEPS

1. **ip tftp** *source-interface gigabitethernet slot/port*
2. **copy tftp:** *URL-to-target-location*
3. **copy** *source-file-system:filename standby-destination-filesystem*
4. **dir** *URL-to-target-location*
5. **issu loadversion rp** *upgrade-rp-number standby-file-system:filename*
6. **issu runversion**
7. **telnetip-addressport**
8. **issu acceptversion**
9. **issu commitversion**
10. **show version**
11. **hw-module slot RP-slot reload**

DETAILED STEPS

	Command or Action	Purpose
Step 1	ip tftp <i>source-interface gigabitethernet slot/port</i> Example:	Specifies the Gigabit Ethernet TFTP source-interface to be configured:

	Command or Action	Purpose
	<pre>Router(config)# ip tftp source-interface gigabitethernet 0</pre>	<p>slot/port—Specifies the location of the TFTP source-interface.</p> <p>Note To copy a file using TFTP through the Management Ethernet interface, the ip tftp source-interface GigabitEthernet 0 command must be entered before entering the copy tftp command.</p>
Step 2	<p>copy tftp: <i>URL-to-target-location</i></p> <p>Example:</p> <pre>copy source-file-system:filename standby-destination-file-system</pre> <p>Example:</p> <p>Example:</p> <pre>Router# copy tftp bootflash:</pre>	Copy the consolidated package onto the active RP.
Step 3	<p>copy <i>source-file-system:filename</i> <i>standby-destination-file-system</i></p> <p>Example:</p> <p>Example:</p> <pre>Router# copy bootflash:asr1000rp1-adventerprisek9.02.01.01.122-33. XNA1.bin stby-bootflash:</pre>	Copy the consolidated package onto the standby RP.
Step 4	<p>dir <i>URL-to-target-location</i></p> <p>Example:</p> <pre>dir URL-to-target-stby-location</pre> <p>Example:</p> <p>Example:</p> <pre>Router# dir bootflash:</pre> <p>Example:</p> <pre>Router# dir stby-bootflash:</pre>	(Optional) Display the contents of the target directories to confirm the successful copy of the file package.
Step 5	<p>issu loadversion rp <i>upgrade-rp-number</i> <i>standby-file-system:filename</i></p> <p>Example:</p>	<p>Load the target consolidated package onto the standby RP.</p> <p>After you receive the message indicating that the terminal state has been reached, go on to Step 6.</p>

	Command or Action	Purpose
	<p>Example:</p> <pre>Router# issu loadversion rp 1 file stby-bootflash:asr1000rp1-adventerprisek9.02.01.01.12 2-33.XNA1.bin</pre>	
Step 6	<p>issu runversion</p> <p>Example:</p> <p>Example:</p> <pre>Router# issu runversion</pre>	<p>Run the consolidated package that was loaded in Step 5.</p> <p>Note If this command is entered before the terminal state is reached, a “peer is not online” or “Standby RP is not in terminal state” error message will be seen and the issu runversion command will not work. If the issu runversion command does not run for these reasons, wait for the “terminal state is reached” message to appear and retry the issu runversion command. You can also monitor the terminal state using the show platform command.</p> <p>After ISSU runversion is completed, a switchover will automatically occur and the standby RP will become the active RP.</p>
Step 7	<p>telnetip-addressport</p> <p>Example:</p> <p>Example:</p> <pre>[unix-server-1 ~]\$ telnet 198.51.100.157 2003</pre> <p>Example:</p> <pre>User Access Verification</pre> <p>Example:</p> <pre>Username: user</pre> <p>Example:</p> <pre>Password: *****</pre> <p>Example:</p>	<p>Log in to the RP being upgraded, preferably using the RP’s console port, to complete the upgrade. (This is the new active RP, that was the standby RP prior to the ISSU process.)</p> <p>Note Ensure the hostname does not end in “-stby” after logging into the RP, as this indicates that the RP being accessed is still the standby RP.</p> <p>There are many ways to log on to a console port. The example shows access to the console port from a UNIX host using telnet.</p>

	Command or Action	Purpose
	Router>	
Step 8	issu acceptversion Example: Example: Router# issu acceptversion	(Optional) Stops the ISSU rollback timer. This step is optional as long as Step 9 is completed before the rollback timer expires.
Step 9	issu commitversion Example: Example: Router# issu commitversion	Completes the ISSU upgrade.
Step 10	show version Example: show version active-RP running Example: show version active-RP provisioned Example: show platform Example: show running-configuration	(Optional) Enter the show version , show platform , or show running-configuration commands to confirm that the upgrade completed successfully, as follows: <ul style="list-style-type: none"> • show version—Confirm that the correct software version is running on your router and that the RP was booted from the correct file. • show running-configuration—Confirm that the booting configuration, in particular the boot system statements, are correct. <p>Tip Use the show running-config include boot command to display only the boot statements from the show running-configuration output.</p> <ul style="list-style-type: none"> • show platform— Confirm that both RP0 and RP1 are correctly running as active and standby.
Step 11	hw-module slot RP-slot reload Example: Example: Router# hw-module slot R0 reload	Reload the new software on the Standby RP.

Examples

The following example shows how to perform consolidated package upgrade in a dual route processor configuration:

```
Router(config)# ip tftp source-interface gigabitethernet 0
Router# copy tftp bootflash:
Address or name of remote host []? 198.51.100.81

Source filename []? /auto/tftp-users/user/asr1000rp1-adventerprise9.02.01.01.122-33.XNA1.bin

Destination filename [asr1000rp1-adventerprise9.02.01.01.122-33.XNA1.bin]?
Accessing
tftp://198.51.100.81//auto/tftp-users/user/asr1000rp1-adventerprise9.02.01.01.122-33.XNA1.bin...
Loading /auto/tftp-users/user/asr1000rp1-adventerprise9.02.01.01.122-33.XNA1.bin from
198.51.100.81 (via GigabitEthernet0): !!!!!!!
[OK - 209227980 bytes]
209227980 bytes copied in 329.215 secs (635536 bytes/sec)
Router# copy bootflash:asr1000rp1-adventerprise9.02.01.01.122-33.XNA1.bin stby-bootflash:

Destination filename [asr1000rp1-adventerprise9.02.01.01.122-33.XNA1.bin]?
Copy in progress...CCCCCCCC<output removed for brevity>
209227980 bytes copied in 434.790 secs (481216 bytes/sec)
Router# dir bootflash:
Directory of bootflash:/
  11  drwx      16384   Dec 4 2007 04:32:46 -08:00  lost+found
86401 drwx      4096    Dec 4 2007 06:06:24 -08:00  .ssh
14401 drwx      4096    Dec 4 2007 06:06:36 -08:00  .rollback_timer
28801 drwx      4096    Jul 21 2008 15:29:25 -07:00  .prst_sync
43201 drwx      4096    Dec 4 2007 04:34:45 -08:00  .installer
  12  -rw-    208904396   May 28 2008 16:17:34 -07:00
asr1000rp1-adventerprise9.02.01.00.122-33.XNA.bin
57604 -rw-    47071436   May 29 2008 15:45:24 -07:00
asr1000rp1-espbase.02.01.00.122-33.XNA.pkg
57602 -rw-     5740    May 29 2008 15:45:23 -07:00
asr1000rp1-packages-adventerprise9.02.01.00.122-33.XNA.conf
57605 -rw-   20334796   May 29 2008 15:45:25 -07:00
asr1000rp1-rpaccess.02.01.00.122-33.XNA.pkg
57606 -rw-   22294732   May 29 2008 15:45:25 -07:00
asr1000rp1-rpbase.02.01.00.122-33.XNA.pkg
57607 -rw-   21946572   May 29 2008 15:45:26 -07:00
asr1000rp1-rpcontrol.02.01.00.122-33.XNA.pkg
57608 -rw-   48099532   May 29 2008 15:45:27 -07:00
asr1000rp1-rpios-adventerprise9.02.01.00.122-33.XNA.pkg
57609 -rw-   34324684   May 29 2008 15:45:28 -07:00
asr1000rp1-sipbase.02.01.00.122-33.XNA.pkg
57610 -rw-   22124748   May 29 2008 15:45:29 -07:00
asr1000rp1-sipspa.02.01.00.122-33.XNA.pkg
  14  -rw-    275093    May 29 2008 16:27:53 -07:00  crashinfo_RP_00_00_20080529-162753-DST

  15  -rw-     7516    Jul 2 2008 15:01:39 -07:00  startup-config
  13  -rw-    45977    Apr 9 2008 16:48:46 -07:00  target_support_output.tgz.tgz
  16  -rw-   209227980   Jul 17 2008 16:06:58 -07:00
asr1000rp1-adventerprise9.02.01.01.122-33.XNA1.bin
928862208 bytes total (76644352 bytes free)
Router# dir stby-bootflash:
Directory of stby-bootflash:/
  11  drwx      16384   Dec 13 2004 03:45:47 -08:00  lost+found
87937 drwx      4096    Jul 17 2008 16:43:34 -07:00  .rollback_timer
14657 drwx      4096    Jul 17 2008 16:43:34 -07:00  .installer
29313 drwx      4096    Dec 13 2004 03:53:00 -08:00  .ssh
  12  -rw-   33554432   Dec 13 2004 03:53:49 -08:00  nvram_00100
```

Examples

```

    13 -rw- 208904396 Jun 5 2008 20:12:53 -07:00
asr1000rp1-adventerprisek9.02.01.00.122-33.XNA.bin
58625 drwx 4096 Jul 21 2008 15:32:59 -07:00 .prst_sync
43972 -rw- 47071436 Jun 5 2008 20:16:55 -07:00
asr1000rp1-espbases.02.01.00.122-33.XNA.pkg
43970 -rw- 5740 Jun 5 2008 20:16:54 -07:00
asr1000rp1-packages-adventerprisek9.02.01.00.122-33.XNA.conf
43973 -rw- 20334796 Jun 5 2008 20:16:56 -07:00
asr1000rp1-rpaccess.02.01.00.122-33.XNA.pkg
43974 -rw- 22294732 Jun 5 2008 20:16:56 -07:00
asr1000rp1-rpbase.02.01.00.122-33.XNA.pkg
43975 -rw- 21946572 Jun 5 2008 20:16:57 -07:00
asr1000rp1-rpcontrol.02.01.00.122-33.XNA.pkg
43976 -rw- 48099532 Jun 5 2008 20:16:58 -07:00
asr1000rp1-rpios-adventerprisek9.02.01.00.122-33.XNA.pkg
43977 -rw- 34324684 Jun 5 2008 20:16:59 -07:00
asr1000rp1-sipbase.02.01.00.122-33.XNA.pkg
43978 -rw- 22124748 Jun 5 2008 20:17:00 -07:00
asr1000rp1-sipspa.02.01.00.122-33.XNA.pkg
43971 -rw- 6256 Jun 5 2008 20:17:00 -07:00 packages.conf
    14 -rw- 209227980 Jul 17 2008 16:16:07 -07:00
asr1000rp1-adventerprisek9.02.01.01.122-33.XNA1.bin
945377280 bytes total (276652032 bytes free)
Router# issu loadversion rp 1 file
stby-bootflash:asr1000rp1-adventerprisek9.02.01.01.122-33.XNA1.bin

--- Starting installation state synchronization ---
Finished installation state synchronization
--- Starting file path checking ---
Finished file path checking
--- Starting system installation readiness checking ---
Finished system installation readiness checking
--- Starting installation changes ---
Setting up image to boot on next reset
Starting automatic rollback timer
Finished installation changes
SUCCESS: Software will now load.
PE23_ASR-1006#
*Jul 21 23:34:27.206: %ASR1000_OIR-6-OFFLINECARD: Card (rp) offline in slot R1
*Jul 21 23:34:27.271: %REDUNDANCY-3-STANDBY_LOST: Standby processor fault (PEER_NOT_PRESENT)
*Jul 21 23:34:27.271: %REDUNDANCY-3-STANDBY_LOST: Standby processor fault (PEER_DOWN)
*Jul 21 23:34:27.271: %REDUNDANCY-3-STANDBY_LOST: Standby processor fault
(P.E.E.R._R.E.D.U.N.D.A.N.C.Y._S.T.A.T.E._C.H.A.N.G.E)
*Jul 21 23:37:05.528: %ASR1000_OIR-6-ONLINECARD: Card (rp) online in slot R1
*Jul 21 23:37:25.480: %REDUNDANCY-5-PEER_MONITOR_EVENT: Active detected a standby insertion
(raw-event=PEER_FOUND(4))
*Jul 21 23:37:25.480: %REDUNDANCY-5-PEER_MONITOR_EVENT: Active detected a standby insertion
(raw-event=PEER_REDUNDANCY_STATE_CHANGE(5))
Finished installation state synchronization
*Jul 21 23:37:26.349: %REDUNDANCY-3-IPC: IOS versions do not match.
*Jul 21 23:38:47.172: %HA_CONFIG_SYNC-6-BULK_CFGSYNC_SUCCEED: Bulk Sync succeeded
*Jul 21 23:38:47.173: %RF-5-RF_TERMINAL_STATE: Terminal state reached for (SSO)
Router# issu runversion
--- Starting installation state synchronization ---
Finished installation state synchronization
Initiating active RP failover
SUCCESS: Standby RP will now become active
PE23_ASR-1006#
System Bootstrap, Version 12.2(33r)XN2, RELEASE SOFTWARE (fc1)
Technical Support: http://www.cisco.com/techsupport
Copyright (c) 2008 by Cisco Systems, Inc.
<additional output removed for brevity>
*Jul 21 23:43:31.970: %SYS-5-RESTART: System restarted --
Cisco IOS Software, IOS-XE Software (PPC_LINUX_IOSD-ADVENTERPRISEK9-M), Version 12.2(33)XNA,

```

```

RELEASE SOFTWARE (fc1)
Technical Support: http://www.cisco.com/techsupport
Copyright (c) 1986-2008 by Cisco Systems, Inc.
Compiled Thu 01-May-08 00:29 by mcpre
*Jul 21 23:43:31.978: %SSH-5-ENABLED: SSH 1.99 has been enabled
*Jul 21 23:43:35.196: Relay: standby progression done
*Jul 21 23:43:35.197: %PLATFORM-6-RF_PROG_SUCCESS: RF state STANDBY HOT

```

At this point of the procedure, use your UNIX client to log in to the other RP:

```

[unix-server-1 ~]$ telnet 198.51.100.157 2003
User Access Verification
Username: user
Password: *****
Router>
Router# issu acceptversion
Cancelling rollback timer
SUCCESS: Rollback timer cancelled
Router# issu commitversion
--- Starting installation changes ---
Cancelling rollback timer
Saving image changes
Finished installation changes
Building configuration...
[OK]
SUCCESS: version committed: bootflash:asr1000rpl-adventerprisek9.02.01.01.122-33.XNA1.bin

```

After you confirm the software versions and configuration, reload the RP as shown in the following example:

```

Router# hw-module slot R0 reload
Proceed with reload of module? [confirm]
*Jul 21 23:54:27.271: %REDUNDANCY-3-STANDBY_LOST: Standby processor fault (PEER_NOT_PRESENT)

*Jul 21 23:54:27.271: %REDUNDANCY-3-STANDBY_LOST: Standby processor fault (PEER_DOWN)
*Jul 21 23:54:27.271: %REDUNDANCY-3-STANDBY_LOST: Standby processor fault
(PEER_REDUNDANCY_STATE_CHANGE)
*Jul 21 23:57:05.528: %ASR1000_OIR-6-ONLINECARD: Card (rp) online in slot R0
*Jul 21 23:57:25.480: %REDUNDANCY-5-PEER_MONITOR_EVENT: Active detected a standby insertion
(raw-event=PEER_FOUND(4))
*Jul 21 23:57:25.480: %REDUNDANCY-5-PEER_MONITOR_EVENT: Active detected a standby insertion
(raw-event=PEER_REDUNDANCY_STATE_CHANGE(5))
*Jul 21 23:58:47.172: %HA_CONFIG_SYNC-6-BULK_CFGSYNC_SUCCEED: Bulk Sync succeeded
*Jul 21 23:58:47.173: %RF-5-RF_TERMINAL_STATE: Terminal state reached for (SSO)

```

Using ISSU to Upgrade the Subpackages in a Dual Route Processor Configuration

This section provides instructions on performing an ISSU upgrade on a Cisco ASR 1000 Series Router with dual RPs that is currently running individual subpackages.

This section covers the following topics:

Using ISSU to Upgrade the Subpackages on a Cisco ASR 1006 Router, ASR1006-X Router, ASR1009-X Router, or ASR 1013 Router (issu Command Set)

This section provides the instructions for performing an ISSU upgrade using subpackages on a Cisco ASR 1006 Router, ASR1006-X Router, ASR1009-X Router, or ASR 1013 Router with a dual RP setup using the **issu** command set.

This procedure can only be performed if the current ASR 1006 Router, ASR1006-X Router, ASR1009-X Router, or ASR 1013 Router have two active RPs and both RPs are running subpackages.

SUMMARY STEPS

1. **show version**
2. **copy running-config startup-config**
3. **mkdir** *URL-to-directory-name*
4. **ip tftp** *source-interface gigabitethernet port*
5. **copy tftp:** *URL-to-target-location*
6. **request platform software package expand file** *URL-to-consolidated-package*
7. **dir** *target-URL*
8. **copy file-system:asr1000rp2-espbase.version.pkg** *URL-to-directory-of-sub-packages-active-RP*
9. **copy file-system:asr1000rp2-espbase.version.pkg** *URL-to-directory-of-sub-packages-standby-RP*
10. **issu loadversion rp** *standby-RP file target-standbyRP-URL-for-sub-packages:asr1000rp*version*.pkg force*
11. **hw-module slot** *standby-RP reload*
12. **issu loadversion rp** *active-RP file URL-to-active-file-system:asr1000rp2-{sipbase,sipspa}*version*.pkg slotSIP-slot-numberforce*
13. **issu loadversion rp** *active-RP file URL-to-active-file-system:asr1000rp2-{elcbase,elcspa}*version*.pkg slotSIP-slot-numberforce*
14. **issu loadversion rp** *active-RP file URL-to-active-file-system:asr1000rp2-esp*version*.pkg slot standby-ESP-slot*
15. **issu loadversion rp** *active-RP file URL-to-active-file-system:asr1000rp*version*.pkg force*
16. **show version** *active-RP provisioned*
17. **redundancy force-switchover**
18. **request platform software package clean**

DETAILED STEPS

	Command or Action	Purpose
Step 1	<p>show version</p> <p>Example:</p> <pre>show version active-rp installed</pre> <p>Example:</p> <pre>dir filesystem: directory</pre> <p>Example:</p> <pre>show platform</pre> <p>Example:</p> <pre>show redundancy states</pre> <p>Example:</p> <pre>Router# show version</pre> <p>Example:</p> <pre>Router# show version r0 installed</pre>	<p>(Optional) Use the following commands to confirm the current router configuration, as follows:</p> <ul style="list-style-type: none"> • show version and show version active-rp installed—Verify the running version of the Cisco IOS XE software on the router, and which file was used to boot the router, and where that file is stored. • dir—Confirm that the files that were used to boot the router are located in the directory. • show platform—Confirm the current status of the active and standby RPs. • show redundancy states—Confirm the operational and configured redundancy states.

	Command or Action	Purpose
	<p>Example:</p> <pre>Router# dir bootflash:</pre> <p>Example:</p> <pre>Router# show platform</pre> <p>Example:</p> <pre>Router# show redundancy states</pre>	
Step 2	<p>copy running-config startup-config</p> <p>Example:</p> <pre>Router# copy running-config startup-config</pre>	After you have confirmed that the system states are acceptable, save the current configuration to the startup configuration.
Step 3	<p>mkdir <i>URL-to-directory-name</i></p> <p>Example:</p> <pre>Router# mkdir usb0:221subs</pre>	<p>Create a directory to store the consolidated package and subpackages.</p> <p>This directory must be created in most cases because the consolidated packages and subpackages have to be separated from the subpackages that booted the router at this step of the procedure.</p>
Step 4	<p>ip tftp <i>source-interface gigabitethernet port</i></p> <p>Example:</p> <pre>Router(config)# ip tftp source-interface gigabitethernet 0</pre>	<p>Specifies the Gigabit Ethernet TFTP source-interface to be configured:</p> <p>slot/port—Specifies the location of the TFTP source-interface.</p> <p>Note To copy a file using TFTP through the Management Ethernet interface, the ip tftp source-interface GigabitEthernet 0 command must be entered before entering the copy tftp command.</p>
Step 5	<p>copy tftp: <i>URL-to-target-location</i></p> <p>Example:</p> <pre>Router# copy tftp: usb0:221subs</pre>	<p>Copy the consolidated package file into the directory created in Step 3 of this procedure.</p> <p>The consolidated package in this step should not be copied into the same directory where the subpackages that are currently running your router are stored (the directory containing the packages.conf provisioning file from which the router was booted).</p> <p>Tip It is recommended that you copy the package onto a usb: or harddisk: file system for space considerations when performing this step of the procedure.</p>
Step 6	<p>request platform software package expand file <i>URL-to-consolidated-package</i></p>	Extract the subpackages out of the consolidated package file into the temporary directory.

	Command or Action	Purpose
	<p>Example:</p> <pre>Router# request platform software package expand file usb0:221subs/asr1000rp2-entbase.9.03.13.00.S.154-3.Sext.bin</pre>	<p>Note</p> <p>Take extra care to extract the subpackages to a temporary subdirectory and do not delete any of the files currently running the router at this point of the procedure. To erase the files that were running on the router before the ISSU upgrade, enter the request platform software package clean command after the ISSU upgrade has been completed.</p>
Step 7	<p>dir target-URL</p> <p>Example:</p> <pre>Router# dir usb0:221subs</pre>	(Optional) Display the directory to confirm that the files were extracted.
Step 8	<p>copy file-system:asr1000rp2-espbase.version.pkg URL-to-directory-of-sub-packages-active-RP</p> <p>Example:</p> <pre>copy file-system:asr1000rp2-esp86base.version.pkg URL-to-directory-of-sub-packages-active-RP</pre> <p>Example:</p> <pre>copy file-system:asr1000rp2-rpaccess.version.pkg URL-to-directory-of-sub-packages-active-RP</pre> <p>Example:</p> <pre>copy file-system:asr1000rp2-rpbase.version.pkg URL-to-directory-of-sub-packages-active-RP</pre> <p>Example:</p> <pre>copy file-system:asr1000rp2-rpcontrol.version.pkg URL-to-directory-of-sub-packages-active-RP</pre> <p>Example:</p> <pre>copy file-system:asr1000rp2-rpios.version.pkg URL-to-directory-of-sub-packages-active-RP</pre> <p>Example:</p> <pre>copy file-system:asr1000rp2-sipbase.version.pkg URL-to-directory-of-sub-packages-active-RP</pre> <p>Example:</p> <pre>copy file-system:asr1000rp2-sipspa.version.pkg URL-to-directory-of-sub-packages-active-RP</pre> <p>Example:</p>	<p>Copy the subpackages out of the temporary directory into the directory on the router where the subpackages running the active RP are currently stored.</p> <p>Note</p> <p>From Polaris 16.x.x release, the new packages rpboot and webui are introduced, which needs to be copied as well.</p>

	Command or Action	Purpose
	<p>copy <i>file-system:asr1000rp2-elcbase.version.pkg</i> <i>URL-to-directory-of-sub-packages-active-RP</i></p> <p>Example:</p> <p>copy <i>file-system:asr1000rp2-elcspa.version.pkg</i> <i>URL-to-directory-of-sub-packages-active-RP</i></p> <p>Example:</p> <pre>Router# copy usb0:221subs/asr1000rp2-espbase.03.13.00.S.154-3.S-ext.pkg bootflash:</pre> <p>Example:</p> <pre>usb0:221subs/asr1000rp2-espbase.03.13.00.S.154-3.S-ext.pkg bootflash:</pre> <p>Example:</p> <pre>Router# copy usb0:221subs/asr1000rp2-rpaccess.03.13.00.S.154-3.S-ext.pkg bootflash:</pre> <p>Example:</p> <pre>Router# copy usb0:221subs/asr1000rp2-rpbase.03.13.00.S.154-3.S-ext.pkg bootflash:</pre> <p>Example:</p> <pre>Router# copy usb0:221subs/asr1000rp2-rpcontrol.03.13.00.S.154-3.S-ext.pkg bootflash:</pre> <p>Example:</p> <pre>Router# copy usb0:221subs/asr1000rp2-rpicadentepisd.03.13.00.S.154-3.S-ext.pkg bootflash:</pre> <p>Example:</p> <pre>Router# copy usb0:221subs/asr1000rp2-sipbase.03.13.00.S.154-3.S-ext.pkg bootflash:</pre> <p>Example:</p> <pre>Router# copy</pre>	

	Command or Action	Purpose
	<pre>usb0:221subs/asr1000rp2-sipspa.03.13.00.S.154-3.S-ext.pkg bootflash: Example: Router# copy usb0:221subs/asr1000rp2-elcbase.03.13.00.S.154-3.S-ext.pkg bootflash: Example: Router# copy usb0:221subs/asr1000rp2-elcspa.03.13.00.S.154-3.S-ext.pkg bootflash:</pre>	
Step 9	<pre>copy file-system:asr1000rp2-espbase.version.pkg URL-to-directory-of-sub-packages-standby-RP Example: copy file-system:asr1000rp2-esp86base.version.pkg URL-to-directory-of-sub-packages-standby-RP Example: copy file-system:asr1000rp2-rpaccess.version.pkg URL-to-directory-of-sub-packages-standby-RP Example: copy file-system:asr1000rp2-rpbase.version.pkg URL-to-directory-of-sub-packages-standby-RP Example: copy file-system:asr1000rp2-rpcontrol.version.pkg URL-to-directory-of-sub-packages-standby-RP Example: copy file-system:asr1000rp2-rpios.version.pkg URL-to-directory-of-sub-packages-standby-RP Example: copy file-system:asr1000rp2-sipbase.version.pkg URL-to-directory-of-sub-packages-standby-RP Example: copy file-system:asr1000rp2-sipspa.version.pkg URL-to-directory-of-sub-packages-standby-RP Example:</pre>	<p>Copy the subpackages out of the temporary directory into the directory on the router where the subpackages running the standby RP are currently stored.</p> <p>Note From Polaris 16.x.x release, the new packages <i>rpboot</i> and <i>webui</i> are introduced, which needs to be copied as well.</p>

	Command or Action	Purpose
	<p>copy <i>file-system:asr1000rp2-elcbase.version.pkg</i> <i>URL-to-directory-of-sub-packages-standby-RP</i></p> <p>Example:</p> <p>copy <i>file-system:asr1000rp2-elcspa.version.pkg</i> <i>URL-to-directory-of-sub-packages-standby-RP</i></p> <p>Example:</p> <pre>Router# copy usb0:221subs/asr1000rp2-elcbase.03.13.00.S.154-3.S-ext.pkg stby-bootflash:</pre> <p>Example:</p> <pre>Router# copy usb0:221subs/asr1000rp2-elcspa.03.13.00.S.154-3.S-ext.pkg stby-bootflash:</pre> <p>Example:</p> <pre>Router# copy usb0:221subs/asr1000rp2-raccess.03.13.00.S.154-3.S-ext.pkg stby-bootflash:</pre> <p>Example:</p> <pre>Router# copy usb0:221subs/asr1000rp2-rbase.03.13.00.S.154-3.S-ext.pkg stby-bootflash:</pre> <p>Example:</p> <pre>Router# copy usb0:221subs/asr1000rp2-rcontrol.03.13.00.S.154-3.S-ext.pkg stby-bootflash:</pre> <p>Example:</p> <pre>Router# copy usb0:221subs/asr1000rp2-rpic-adetaprised.03.13.00.S.154-3.S-ext.pkg stby-bootflash:</pre> <p>Example:</p> <pre>Router# copy usb0:221subs/asr1000rp2-sipbase.03.13.00.S.154-3.S-ext.pkg stby-bootflash:</pre> <p>Example:</p>	

	Command or Action	Purpose
	<pre>Router# copy usb0:221subs/asr1000rp2-sipspa.03.13.00.S.154-3.S-ext.pkg stby-bootflash: Example: Router# copy usb0:221subs/asr1000rp2-elbase.03.13.00.S.154-3.S-ext.pkg stby-bootflash: Example: Router# copy usb0:221subs/asr1000rp2-elspa.03.13.00.S.154-3.S-ext.pkg stby-bootflash:</pre>	
Step 10	<pre>issu loadversion rp standby-RP file target-standbyRP-URL-for-sub-packages::asr1000rp*version*.pkg force Example: Router# issu loadversion rp 1 file stby-bootflash:asr1000rp*03.13.00.S.154-3.S-ext*.pkg force</pre>	<p>Upgrade the RP subpackages on the standby RP, where the “rp*” wildcard is specified to capture all of the RP subpackages for the desired upgrade release.</p> <p>Note From Polaris 16.x.x release, the image name starts with asr1000rpx86. Hence, the keyword <i>rpx86*</i> can be used during upgrade or downgrade between Polaris 16.x.x releases.</p>
Step 11	<pre>hw-module slot standby-RP reload Example: Router# hw-module slot R1 reload</pre>	Reload the standby RP.
Step 12	<pre>issu loadversion rp active-RP file URL-to-active-file-system::asr1000rp2-{sipbase,sipspa}*version*.pkg slotSIP-slot-numberforce Example: issu commitversion Example: Router# issu loadversion rp 0 file bootflash:asr1000rp2-{sipbase,sipspa}*03.13.00.S.154-3.S-ext*.pkg slot 0 force</pre>	<p>Upgrade the SIP and SPA subpackages for each SIP on the router.</p> <p>Note This step must be completed one SIP at a time, and repeated for each SIP installed on the router before performing the next step.</p> <p>Tip You can use the show ip interface brief command to identify which slots contain SIPs and SPAs. The interfaces with three numbers (in the form <i>SIP-number/SPA-number/interface-number</i>) identify the SIP and SPA locations in the router.</p>

	Command or Action	Purpose
		<p>Note The <i>pattern</i> options used in this CLI (sipbase and sipspa) were introduced in Cisco IOS XE Release 2.1.2 and are not available in previous Cisco IOS XE Releases. See the "ISSU Procedures (Prior to Cisco IOS XE Release 2.1.2)" section for pre-Cisco IOS XE Release 2.1.2 ISSU upgrade procedures.</p>
Step 13	<p>issu loadversion rp active-RP file <i>URL-to-active-file-system:asr1000rp2-(elcbase,elcspa)*version*.pkg</i> slot SIP-slot-number force</p> <p>Example: issu commitversion</p> <p>Example:</p> <p>Repeat this step for each ELC installed in the router before moving onto the next step.</p> <p>Example:</p> <pre>Router# issu loadversion rp 0 file bootflash:asr1000rp2-(elcbase,elcspa)*03.13.00.S.154-3.S-ext*.pkg slot 0 force</pre>	<p>Upgrade the ELC and SPA subpackages for each ELC on the router.</p> <p>Note This step must be completed for one ELC at a time, and repeated for each ELC installed on the router before performing the next step.</p> <p>Tip You can use the show ip interface brief command to identify which slots contain ELCs and SPAs. The interfaces with three numbers (in the form <i>ELC-number/SPA-number/interface-number</i>) identify the ELC and SPA locations in the router.</p> <p>Note The <i>pattern</i> options used in this CLI (elcbase and elcspa) were introduced in Cisco IOS XE Release 3.10S and are not available in previous Cisco IOS XE Releases.</p>
Step 14	<p>issu loadversion rp active-RP file <i>URL-to-active-file-system:asr1000rp2-esp*version*.pkg</i> slot standby-ESP-slot</p> <p>Example: issu commitversion</p> <p>Example:</p> <p>issu loadversion rp active-RP file <i>URL-to-active-file-system:asr1000rp2-esp*version*.pkg</i> slot active-ESP-slot</p> <p>Example: issu commitversion</p> <p>Example:</p> <pre>Router# issu loadversion rp 0 file bootflash:asr1000rp2-esp*03.13.00.S.154-3.S-ext*.pkg slot 1</pre> <p>Example:</p> <pre>Router# issu commitversion</pre>	<p>Upgrade the ESP Base subpackage on the standby and the active ESPs.</p> <p>After entering the issu loadversion rp command on the active RP, the ESP switchover will occur automatically. Minimal traffic interruption will occur as a result of this switchover.</p>

	Command or Action	Purpose
	<p>Example:</p> <pre>Router# issu loadversion rp 0 file bootflash:asr1000rp2-esp*03.13.00.S.154-3.S-ext*.pkg slot 0</pre> <p>Example:</p> <pre>Router# issu commitversion</pre>	
Step 15	<p>issu loadversion rp active-RP file <i>URL-to-active-file-system:asr1000rp*version*.pkg force</i></p> <p>Example:</p> <pre>issu commitversion</pre> <p>Example:</p> <pre>Router# issu loadversion rp 0 file bootflash:asr1000rp2*03.13.00.S.154-3.S-ext*.pkg force</pre> <p>Example:</p> <pre>issu commitversion</pre>	<p>Upgrade all of the subpackages on the active RP.</p> <p>Note This step is required to ensure that all subpackages on the router were upgraded as part of this procedure, and might upgrade some subpackages that would otherwise be missed in the process.</p> <p>Note From Polaris 16.x.x release, the image name starts with asr1000rpx86. Hence, the keyword <i>rpx86*</i> can be used during upgrade or downgrade between Polaris 16.x.x releases.</p>
Step 16	<p>show version active-RP provisioned</p> <p>Example:</p> <pre>show version active-RP installed</pre> <p>Example:</p> <pre>Router# show version r0 provisioned</pre> <p>Example:</p> <pre>Router# show version r0 installed</pre>	(Optional) Confirm that the subpackages are provisioned and installed.
Step 17	<p>redundancy force-switchover</p> <p>Example:</p> <pre>Router# redundancy force-switchover</pre>	Force an RP switchover to complete the upgrade.
Step 18	<p>request platform software package clean</p> <p>Example:</p> <pre>Router# request platform software package clean</pre>	(Optional) Removes all unused subpackages files from the router.

Examples

The following example shows ISSU upgrade using subpackages on a Cisco ASR 1006 router or ASR 1013 router with a dual RP setup using the **issu** command set

```
Router# show version
Cisco IOS Software, IOS-XE Software (X86_64_LINUX_IOSD-ADVENTERPRISEK9-M), Version 15.3(2)S,
RELEASE SOFTWARE (fc1)
<output removed for brevity>
System image file is "bootflash:Active_Dir/packages.conf"
<output removed for brevity>
cisco ASR1013 (RP2) processor with 4208889K/6147K bytes of memory.
Processor board ID FOX1343GJGC 20 Gigabit Ethernet interfaces
6 Ten Gigabit Ethernet interfaces
32768K bytes of non-volatile configuration memory.
8388608K bytes of physical memory.
1925119K bytes of eUSB flash at bootflash:.
78085207K bytes of SATA hard disk at harddisk:.
Configuration register is 0x2102
Router# show platform
Chassis type: ASR1013
Slot      Type                State                Insert time (ago)
-----
2         ASR1000-SIP40       ok                   1d03h
2/0      SPA-1X10GE-L-V2    ok                   1d03h
2/1      SPA-1X10GE-L-V2    ok                   1d03h
2/2      SPA-1X10GE-L-V2    ok                   1d03h
2/3      SPA-1X10GE-L-V2    ok                   1d03h
4        ASR1000-2T+20X1GE  ok                   1d03h
4/0      BUILT-IN-2T+20X1GE ok                   1d03h
R0       ASR1000-RP2        ok, active           1d03h
R1       ASR1000-RP2        ok, standby          1d03h
F0       ASR1000-ESP100     ok, active           1d03h
F1       ASR1000-ESP100     ok, standby          1d03h
P0       ASR1013-PWR-AC     ok                   1d03h
P1       ASR1013-PWR-AC     ok                   1d03h
P2       ASR1013-PWR-AC     ok                   1d03h
P3       ASR1013-PWR-AC     ps, fail             1d03h
Slot     CPLD Version        Firmware Version
-----
2        00200800            15.3(3r)S
4        00200800            15.2(1r)S
R0       10021901            15.3(3r)S
R1       10021901            15.3(3r)S
F0       12071700            15.3(3r)S
F1       12071700            15.3(3r)S
Router# show version r0 installed
Package: Provisioning File, version: n/a, status: active
  File: bootflash:Active_Dir/packages.conf, on: RP0
  Built: n/a, by: n/a
  File SHA1 checksum: a624f70f68c60292f4482433f43afd92487a55c4
Package: rpbase, version: 03.12.01.S.154-2.S, status: active
  File: bootflash:Active_Dir/asr1000rp2-rpbase.03.12.01.S.154-2.S.pkg, on: RP0
  Built: 2013-03-25_18.48, by: mcpre
  File SHA1 checksum: 3a9675142898cfac350d4e42f0e37bd9f4e48538
Package: rpcontrol, version: 03.12.01.S.154-2.S, status: active
  File: bootflash:Active_Dir/asr1000rp2-rpcontrol.03.12.01.S.154-2.S.pkg, on: RP0/0
  Built: 2013-03-25_18.48, by: mcpre
  File SHA1 checksum: 87b11f863f67fdf2610ee0769b929baab4c3efad
<output removed for brevity>
Router# dir bootflash:Active_Dir
Directory of bootflash:/Active_Dir/
 20 -rw- 41104112 Aug 3 2013 15:05:40 +05:30
```

Examples

```

asr1000rp2-elcbase.03.12.01.S.154-2.S.pkg
 21 -rw- 50285296 Aug 3 2013 15:05:40 +05:30 asr1000rp2-elcspa.03.12.01.S.154-2.S.pkg

 22 -rw- 82514676 Aug 3 2013 15:05:40 +05:30
asr1000rp2-espbase.03.12.01.S.154-2.S.pkg
 23 -rw- 101084628 Aug 3 2013 15:05:40 +05:30
asr1000rp2-esp86base.03.12.01.S.154-2.S.pkg
 17 -rw- 9059 Aug 3 2013 15:05:40 +05:30
asr1000rp2-packages-adventerprisek9.03.12.01.S.154-2.S.conf
 24 -rw- 29012724 Aug 3 2013 15:05:40 +05:30
asr1000rp2-rpaccess.03.12.01.S.154-2.S.pkg
 25 -rw- 49898964 Aug 3 2013 15:05:40 +05:30 asr1000rp2-rpbase.03.12.01.S.154-2.S.pkg

 26 -rw- 46557940 Aug 3 2013 15:05:40 +05:30
asr1000rp2-rpcontrol.03.12.01.S.154-2.S.pkg
 27 -rw- 114612988 Aug 3 2013 15:05:41 +05:30
asr1000rp2-rpios-adventerprisek9.03.12.01.S.154-2.S.pkg
 28 -rw- 41954036 Aug 3 2013 15:05:41 +05:30
asr1000rp2-sipbase.03.12.01.S.154-2.S.pkg
 29 -rw- 60957428 Aug 3 2013 15:05:41 +05:30 asr1000rp2-sipspa.03.12.01.S.154-2.S.pkg

 19 -rw- 9838 Aug 3 2013 15:05:41 +05:30
packages.conf
1940303872 bytes total (503164928 bytes free)
Router# show redundancy states
    my state = 13 -ACTIVE
    peer state = 8 -STANDBY HOT
    Mode = Duplex
    Unit = Primary
    Unit ID = 48
Redundancy Mode (Operational) = sso
Redundancy Mode (Configured) = sso
Redundancy State = sso
Maintenance Mode = Disabled
Manual Swact = enabled
Communications = Up
client count = 108
client_notification_TMR = 30000 milliseconds
RF debug mask = 0x0
Router# copy running-config startup-config
Destination filename [startup-config]?
Building configuration...
[OK]
Router# mkdir harddisk:Target_Subs
Create directory filename [Target_Subs]?
Created dir harddisk:/Target_Subs
Router# request platform software package expand file
harddisk:Target_Subs/asr1000rp2-adventerprisek9.03.13.00.S.154-3.S-ext.bin to
harddisk:Target_Subs
Verifying parameters
Validating package type
Copying package files
SUCCESS: Finished expanding all-in-one software package.
Router# dir harddisk:Target_Subs
Directory of harddisk:/Target_Subs/
3358722 -rw- 569597380 Aug 4 2013 18:45:38 +05:30
asr1000rp2-adventerprisek9.03.13.00.S.154-3.S-ext.bin
7684099 -rw- 37557200 Aug 4 2013 18:46:43 +05:30
asr1000rp2-elcbase.03.13.00.S.154-3.S-ext.pkg
7684100 -rw- 51194832 Aug 4 2013 18:46:43 +05:30
asr1000rp2-elcspa.03.13.00.S.154-3.S-ext.pkg
7684101 -rw- 80657364 Aug 4 2013 18:46:43 +05:30
asr1000rp2-espbase.03.13.00.S.154-3.S-ext.pkg
7684102 -rw- 95446456 Aug 4 2013 18:46:43 +05:30

```

```

asr1000rp2-esp86base.03.13.00.S.154-3.S-ext.pkg
7684097 -rw-          9381   Aug 4 2013 18:46:43 +05:30
asr1000rp2-packages-adventerprisek9.03.13.00.S.154-3.S-ext.conf
7684103 -rw-        23350232   Aug 4 2013 18:46:43 +05:30
asr1000rp2-rpaccess.03.13.00.S.154-3.S-ext.pkg
7684104 -rw-        37694900   Aug 4 2013 18:46:44 +05:30
asr1000rp2-rpbase.03.13.00.S.154-3.S-ext.pkg
7684105 -rw-        45536216   Aug 4 2013 18:46:44 +05:30
asr1000rp2-rpcontrol.03.13.00.S.154-3.S-ext.pkg
7684106 -rw-        118754284   Aug 4 2013 18:46:44 +05:30
asr1000rp2-rpios-adventerprisek9.03.13.00.S.154-3.S-ext.pkg
7684107 -rw-        38380500   Aug 4 2013 18:46:44 +05:30
asr1000rp2-sipbase.03.13.00.S.154-3.S-ext.pkg
7684108 -rw-        61760468   Aug 4 2013 18:46:44 +05:30
asr1000rp2-sipspa.03.13.00.S.154-3.S-ext.pkg
7684098 -rw-         10165   Aug 4 2013 18:46:44 +05:30  packages.conf
78704144384 bytes total (9254879232 bytes free)
Router# copy harddisk:Target_Subs/asr1000rp2-espbase.03.13.00.S.154-3.S-ext.pkg bootflash:
Active_Dir/Destination filename [Active_Dir/asr1000rp2-
espbase.03.13.00.S.154-3.S-ext.pkg]?
Copy in
progress...CCCCC80657364 bytes copied in 11.951 secs (6749005 bytes/sec)
Router# copy harddisk:Target_Subs/asr1000rp2-esp86base.03.13.00.S.154-3.S-ext.pkg bootflash:
Destination filename [Active_Dir/asr1000rp2-esp86base.03.13.00.S.154-3.S-ext.pkg]?
Copy in
progress...CCCCC
95446456 bytes copied in 14.213 secs (6715433 bytes/sec)
Router# Copy harddisk:Target_Subs/asr1000rp2-rpaccess.03.13.00.S.154-3.S-ext.pkg bootflash:
Destination filename [Active_Dir/asr1000rp2-rpaccess.03.13.00.S.154-3.S-ext.pkg]?
Copy in
progress...CCCCC
23350232 bytes copied in 3.441 secs (6785885 bytes/sec)
Router# copy harddisk:Target_Subs/asr1000rp2-rpbase.03.13.00.S.154-3.S-ext.pkg bootflash:
Destination filename [Active_Dir/asr1000rp2-rpbase.03.13.00.S.154-3.S-ext.pkg]?
Copy in
progress...CCCCC
37694900 bytes copied in 5.598 secs (6733637 bytes/sec)
Router# copy harddisk:Target_Subs/asr1000rp2-rpcontrol.03.13.00.S.154-3.S-ext.pkg bootflash:
Destination filename [Active_Dir/asr1000rp2-rpcontrol.03.13.00.S.154-3.S-ext.pkg]?
Copy in
progress...CCCCC
45536216 bytes copied in 6.797 secs (6699458 bytes/sec)
Router# copy harddisk:Target_Subs/asr1000rp2-rpios-adventerprisek9.03.13.00.S.154-3.S-ext.pkg
bootflash:
Destination filename [Active_Dir/asr1000rp2-rpios-adventerprisek9.03.13.00.S.154-3.S-ext.pkg]?

Copy in
progress...CCCCC
118754284 bytes copied in 17.798 secs (6672339 bytes/sec)
Router# copy harddisk:Target_Subs/asr1000rp2-sipbase.03.13.00.S.154-3.S-ext.pkg bootflash:
Destination filename [Active_Dir/asr1000rp2-sipbase.03.13.00.S.154-3.S-ext.pkg]?
Copy in progress...CCCCC
38380500 bytes copied in 5.962 secs (6437521 bytes/sec)
Router# copy harddisk:Target_Subs/asr1000rp2-sipspa.03.13.00.S.154-3.S-ext.pkg bootflash:
Destination filename [Active_Dir/asr1000rp2-sipspa.03.13.00.S.154-3.S-ext.pkg]?
Copy in
progress...CCCCC61760468 bytes copied in 9.408 secs (6564676 bytes/sec)
Router# copy harddisk:Target_Subs/asr1000rp2-elcbase.03.13.00.S.154-3.S-ext.pkg bootflash:
Destination filename [Active_Dir/asr1000rp2-elcbase.03.13.00.S.154-3.S-ext.pkg]?
Copy in
progress...CCCCC
37557200 bytes copied in 5.650 secs (6647292 bytes/sec)
Router# copy harddisk:Target_Subs/asr1000rp2-elcspa.03.13.00.S.154-3.S-ext.pkg bootflash:
Destination filename [Active_Dir/asr1000rp2-elcspa.03.13.00.S.154-3.S-ext.pkg]?

```

```

Copy in
progress...CCCC
51194832 bytes copied in 7.397 secs (6921026 bytes/sec)
Router# copy harddisk:Target_Subst/asr1000rp2-espbase.03.13.00.S.154-3.S-ext.pkg
stby-bootflash:
Destination filename [Active_Dir/asr1000rp2-espbase.03.13.00.S.154-3.S-ext.pkg]?
Copy in
progress...CCC
80657364 bytes copied in 132.765 secs (607520 bytes/sec)
Router# copy harddisk:Target_Subst/asr1000rp2-esp86base.03.13.00.S.154-3.S-ext.pkg
stby-bootflash:
Destination filename [Active_Dir/asr1000rp2-esp86base.03.13.00.S.154-3.S-ext.pkg]?
Copy in
progress...CCCC95446456 bytes copied in 177.587 secs (537463 bytes/sec)
Router# copy harddisk:Target_Subst/asr1000rp2-rpaccess.03.13.00.S.154-3.S-ext.pkg
stby-bootflash:
Destination filename [Active_Dir/asr1000rp2-rpaccess.03.13.00.S.154-3.S-ext.pkg]?
Copy in
progress...CCCCC
23350232 bytes copied in 55.396 secs (421515 bytes/sec)
Router# copy harddisk:Target_Subst/asr1000rp2-rpbase.03.13.00.S.154-3.S-ext.pkg stby-bootflash:
Destination filename [Active_Dir/asr1000rp2-rpbase.03.13.00.S.154-3.S-ext.pkg]?
Copy in
progress...CCCC
37694900 bytes copied in 86.199 secs (437301 bytes/sec)
Router# copy harddisk:Target_Subst/asr1000rp2-rpcontrol.03.13.00.S.154-3.S-ext.pkg
stby-bootflash:
Destination filename [Active_Dir/asr1000rp2-rpcontrol.03.13.00.S.154-3.S-ext.pkg]?
Copy in
progress...CCCCC
45536216 bytes copied in 101.527 secs (448513 bytes/sec)
Router# copy harddisk:Target_Subst/asr1000rp2-rpios-adventerprisek9.03.13.00.S.154-3.S-ext.pkg
stby-bootflash:
Destination filename [Active_Dir/asr1000rp2-rpios-adventerprisek9.03.13.00.S.154-3.S-ext.pkg]?

Copy in
progress...CCCC118754284 bytes copied in 212.646 secs (558460 bytes/sec)
Router# copy harddisk:Target_Subst/asr1000rp2-sipbase.03.13.00.S.154-3.S-ext.pkg
stby-bootflash:
Destination filename [Active_Dir/asr1000rp2-sipbase.03.13.00.S.154-3.S-ext.pkg]?
Copy in
progress...CCCCCC38380500 bytes copied in 83.162 secs (461515 bytes/sec)
Router# copy harddisk:Target_Subst/asr1000rp2-sipspa.03.13.00.S.154-3.S-ext.pkg stby-bootflash:
Destination filename [Active_Dir/asr1000rp2-sipspa.03.13.00.S.154-3.S-ext.pkg]?
Copy in
progress...CCCC
61760468 bytes copied in 119.391 secs (517296 bytes/sec)
Router# copy harddisk:Target_Subst/asr1000rp2-elcbase.03.13.00.S.154-3.S-ext.pkg
stby-bootflash:
Destination filename [Active_Dir/asr1000rp2-elcbase.03.13.00.S.154-3.S-ext.pkg]?
Copy in
progress...CCCC
37557200 bytes copied in 57.106 secs (657675 bytes/sec)
Router# copy harddisk:Target_Subst/asr1000rp2-elcspa.03.13.00.S.154-3.S-ext.pkg stby-bootflash:
Destination filename [Active_Dir/asr1000rp2-elcspa.03.13.00.S.154-3.S-ext.pkg]?
Copy in
progress...CCCC51194832 bytes copied in 87.453 secs (585398 bytes/sec)
Router# issu checkversion rp 1 file
stby-bootflash:Active_Dir/asr1000rp*03.13.00.S.154-3.S-ext*.pkg force
--- Starting local lock acquisition on R0 ---
Finished local lock acquisition on R0
--- Starting installation state synchronization ---
Finished installation state synchronization
--- Starting local lock acquisition on R1 ---

```

```

Finished local lock acquisition on R1
--- Starting file path checking ---
Finished file path checking
--- Starting image file verification ---
Checking image file names
Locating image files and validating name syntax
  Found asr1000rp2-elcbase.03.13.00.S.154-3.S-ext.pkg
  Found asr1000rp2-elcspa.03.13.00.S.154-3.S-ext.pkg
  Found asr1000rp2-espbase.03.13.00.S.154-3.S-ext.pkg
  Found asr1000rp2-esp86base.03.13.00.S.154-3.S-ext.pkg
  Found asr1000rp2-rpaccess.03.13.00.S.154-3.S-ext.pkg
  Found asr1000rp2-rpbase.03.13.00.S.154-3.S-ext.pkg
  Found asr1000rp2-rpcontrol.03.13.00.S.154-3.S-ext.pkg
  Found asr1000rp2-rpios-adventerprisek9.03.13.00.S.154-3.S-ext.pkg
  Found asr1000rp2-sipbase.03.13.00.S.154-3.S-ext.pkg
  Found asr1000rp2-sipsa.03.13.00.S.154-3.S-ext.pkg
Verifying image file locations
Inspecting image file types
  WARNING: In-service installation of IOSD package
  WARNING: requires software redundancy on target RP
  WARNING: or on-reboot parameter
  WARNING: Automatically setting the on-reboot flag
  WARNING: In-service installation of RP Base package
  WARNING: requires software reboot of target RP
Processing image file constraints
Creating candidate provisioning file
Finished image file verification
--- Starting candidate package set construction ---
Verifying existing software set
Processing candidate provisioning file
Constructing working set for candidate package set
Constructing working set for running package set
Checking command output
Constructing merge of running and candidate packages
Checking if resulting candidate package set would be complete
Finished candidate package set construction
--- Starting compatibility testing ---
Determining whether candidate package set is compatible
Determining whether installation is valid
Determining whether installation is valid ... skipped
Verifying image type compatibility
Checking IPC compatibility for candidate software
Checking candidate package set infrastructure compatibility
Checking infrastructure compatibility with running software
Checking infrastructure compatibility with running software ... skipped
Checking package specific compatibility
Finished compatibility testing
SUCCESS: Software is ISSU compatible.
Router#
Router#
Router# issu loadversion rp 1 file
stby-bootflash:Active_Dir/asr1000rp*03.13.00.S.154-3.S-ext*.pkg force
--- Starting local lock acquisition on R0 ---
Finished local lock acquisition on R0
--- Starting installation state synchronization ---
Finished installation state synchronization
--- Starting local lock acquisition on R1 ---
Finished local lock acquisition on R1
--- Starting file path checking ---
Finished file path checking
--- Starting image file verification ---
Checking image file names
Locating image files and validating name syntax
  Found asr1000rp2-elcbase.03.13.00.S.154-3.S-ext.pkg

```

```

Found asr1000rp2-elcspa.03.13.00.S.154-3.S-ext.pkg
Found asr1000rp2-espbase.03.13.00.S.154-3.S-ext.pkg
Found asr1000rp2-esp86base.03.13.00.S.154-3.S-ext.pkg
Found asr1000rp2-rpaccess.03.13.00.S.154-3.S-ext.pkg
Found asr1000rp2-rpbase.03.13.00.S.154-3.S-ext.pkg
Found asr1000rp2-rpcontrol.03.13.00.S.154-3.S-ext.pkg
Found asr1000rp2-rpios-adventerprisek9.03.13.00.S.154-3.S-ext.pkg
Found asr1000rp2-sipbase.03.13.00.S.154-3.S-ext.pkg
Found asr1000rp2-sipsa.03.13.00.S.154-3.S-ext.pkg
Verifying image file locations
Inspecting image file types
  WARNING: In-service installation of IOSD package
  WARNING: requires software redundancy on target RP
  WARNING: or on-reboot parameter
  WARNING: Automatically setting the on-reboot flag
  WARNING: In-service installation of RP Base package
  WARNING: requires software reboot of target RP
Processing image file constraints
Creating candidate provisioning file
Finished image file verification
--- Starting candidate package set construction ---
Verifying existing software set
Processing candidate provisioning file
Constructing working set for candidate package set
Constructing working set for running package set
Checking command output
Constructing merge of running and candidate packages
Checking if resulting candidate package set would be complete
Finished candidate package set construction
--- Starting compatibility testing ---
Determining whether candidate package set is compatible
Determining whether installation is valid
Determining whether installation is valid ... skipped
Verifying image type compatibility
Checking IPC compatibility for candidate software
Checking candidate package set infrastructure compatibility
Checking infrastructure compatibility with running software
Checking infrastructure compatibility with running software ... skipped
Checking package specific compatibility
Finished compatibility testing
--- Starting list of software package changes ---
Old files list:
  Removed asr1000rp2-elcbase.03.12.01.S.154-2.S.pkg
  Removed asr1000rp2-elcspa.03.12.01.S.154-2.S.pkg
  Removed asr1000rp2-espbase.03.12.01.S.154-2.S.pkg
  Removed asr1000rp2-esp86base.03.12.01.S.154-2.S.pkg
  Removed asr1000rp2-rpaccess.03.12.01.S.154-2.S.pkg
  Removed asr1000rp2-rpbase.03.12.01.S.154-2.S.pkg
  Removed asr1000rp2-rpcontrol.03.12.01.S.154-2.S.pkg
  Removed asr1000rp2-rpios-adventerprisek9.03.12.01.S.154-2.S.pkg
  Removed asr1000rp2-sipbase.03.12.01.S.154-2.S.pkg
  Removed asr1000rp2-sipsa.03.12.01.S.154-2.S.pkg
New files list:
  Added asr1000rp2-elcbase.03.13.00.S.154-3.S-ext.pkg
  Added asr1000rp2-elcspa.03.13.00.S.154-3.S-ext.pkg
  Added asr1000rp2-espbase.03.13.00.S.154-3.S-ext.pkg
  Added asr1000rp2-esp86base.03.13.00.S.154-3.S-ext.pkg
  Added asr1000rp2-rpaccess.03.13.00.S.154-3.S-ext.pkg
  Added asr1000rp2-rpbase.03.13.00.S.154-3.S-ext.pkg
  Added asr1000rp2-rpcontrol.03.13.00.S.154-3.S-ext.pkg
  Added asr1000rp2-rpios-adventerprisek9.03.13.00.S.154-3.S-ext.pkg
  Added asr1000rp2-sipbase.03.13.00.S.154-3.S-ext.pkg
  Added asr1000rp2-sipsa.03.13.00.S.154-3.S-ext.pkg
Finished list of software package changes

```

```

--- Starting commit of software changes ---
Updating provisioning rollback files
Creating pending provisioning file
Committing provisioning file
Finished commit of software changes
SUCCESS: Software provisioned.  New software will load on reboot.
Router#
Router# hw-module slot r1 reload
Proceed with reload of module? [confirm]
Router#
*Aug  4 19:14:01.721 IST: %IOSXE_OIR-6-OFFLINECARD: Card (rp) offline in slot R1
*Aug  4 19:14:01.761 IST: %REDUNDANCY-3-STANDBY_LOST: Standby processor fault
(PEER_NOT_PRESENT)
*Aug  4 19:14:01.761 IST: %REDUNDANCY-3-STANDBY_LOST: Standby processor fault (PEER_DOWN)
*Aug  4 19:14:01.761 IST: %REDUNDANCY-3-STANDBY_LOST: Standby processor fault
(PEER_REDUNDANCY_STATE_CHANGE)
*Aug  4 19:14:03.584 IST: %RF-5-RF_RELOAD: Peer reload. Reason: EHSA standby down
*Aug  4 19:14:03.594 IST: % Redundancy mode change to SSO
Router#
*Aug  4 19:17:35.443 IST: %IOSXE_OIR-6-ONLINECARD: Card (rp) online in slot R1
Router#
*Aug  4 19:17:48.061 IST: %REDUNDANCY-5-PEER_MONITOR_EVENT: Active detected a standby
insertion (raw-event=PEER_FOUND(4))
*Aug  4 19:17:48.061 IST: %REDUNDANCY-5-PEER_MONITOR_EVENT: Active detected a standby
insertion (raw-event=PEER_REDUNDANCY_STATE_CHANGE(5))
*Aug  4 19:17:51.003 IST: %REDUNDANCY-3-IPC: IOS versions do not match.

*Aug  4 19:19:08.380 IST: %NBAR_HA-5-NBAR_INFO: NBAR sync DONE!
*Aug  4 19:19:08.797 IST: %HA_CONFIG_SYNC-6-BULK_CFGSYNC_SUCCEEDED: Bulk Sync succeeded
*Aug  4 19:19:08.798 IST: %RF-5-RF_TERMINAL_STATE: Terminal state reached for (SSO)
Router# issu loadversion rp 0 file
bootflash:Active_Dir/asr1000rp2-{sipbase,sipspa}*03.13.00.S.154-3.S-ext*.pkg slot 2 force
--- Starting local lock acquisition on R0 ---
Finished local lock acquisition on R0
--- Starting installation state synchronization ---
Finished installation state synchronization
--- Starting file path checking ---
Finished file path checking
--- Starting image file verification ---
Checking image file names
Locating image files and validating name syntax
  Found asr1000rp2-sipbase.03.13.00.S.154-3.S-ext.pkg
  Found asr1000rp2-sipspa.03.13.00.S.154-3.S-ext.pkg
Verifying image file locations
Inspecting image file types
Processing image file constraints
Creating candidate provisioning file
Finished image file verification
--- Starting candidate package set construction ---
Verifying existing software set
Processing candidate provisioning file
Constructing working set for candidate package set
Constructing working set for running package set
Checking command output
Constructing merge of running and candidate packages
Checking if resulting candidate package set would be complete
Finished candidate package set construction
--- Starting compatibility testing ---
Determining whether candidate package set is compatible
WARNING:
WARNING: Candidate software combination not found in compatibility database
WARNING:
Determining whether installation is valid
Creating matrix_file by locate_latest_matrix_file  /tmp/issu/provision/sw

```

```

WARNING:
WARNING: Candidate software combination not found in compatibility database
WARNING:
WARNING:
WARNING: Candidate software combination not found in compatibility database
WARNING:
Software sets are identified as compatible
Verifying image type compatibility
Checking IPC compatibility with running software
Checking candidate package set infrastructure compatibility
Checking infrastructure compatibility with running software
Checking package specific compatibility
Finished compatibility testing
--- Starting impact testing ---
Checking operational impact of change
Finished impact testing
--- Starting list of software package changes ---
No old package files removed
New files list:
  Added asr1000rp2-sipbase.03.13.00.S.154-3.S-ext.pkg
  Added asr1000rp2-sipspa.03.13.00.S.154-3.S-ext.pkg
Finished list of software package changes
--- Starting commit of software changes ---
Updating provisioning rollback files
Creating pending provisioning file
Committing provisioning file
Finished commit of software changes
--- Starting analysis of software changes ---
Finished analysis of software changes
--- Starting update running software ---
Blocking peer synchronization of operating information
Creating the command set placeholder directory
  Finding latest command set
  Finding latest command shortlist lookup file
  Finding latest command shortlist file
  Assembling CLI output libraries
  Assembling CLI input libraries
  Assembling Dynamic configuration files
  Applying interim IPC and database definitions
  Replacing running software
  Replacing CLI software
  Restarting software
Generating software version information
  Notifying running software of updates
  Unblocking peer synchronization of operating information
Unmounting old packages
Cleaning temporary installation files
  Finished update running software

SUCCESS: Finished installing software.
*Aug  4 19:21:45.424 IST: %IOSXE_OIR-6-ONLINECARD: Card (cc) online in slot 2
*Aug  4 19:21:48.382 IST: %IOSXE_OIR-6-INSSPA: SPA inserted in subslot 2/0
*Aug  4 19:21:48.733 IST: %IOSXE_OIR-6-INSSPA: SPA inserted in subslot 2/1
*Aug  4 19:21:49.083 IST: %IOSXE_OIR-6-INSSPA: SPA inserted in subslot 2/2
*Aug  4 19:21:49.430 IST: %IOSXE_OIR-6-INSSPA: SPA inserted in subslot 2/3
*Aug  4 19:21:58.121 IST: %LINK-3-UPDOWN: SIP2/0: Interface EOBC2/1, changed state to up
*Aug  4 19:22:02.302 IST: %SPA_OIR-6-ONLINECARD: SPA (SPA-1X10GE-L-V2) online in subslot
2/0
*Aug  4 19:22:02.282 IST: %TRANSCEIVER-6-INSERTED: SIP2/0: transceiver module inserted in
TenGigabitEthernet2/0/0
*Aug  4 19:22:02.518 IST: %LINK-3-UPDOWN: SIP2/1: Interface EOBC2/1, changed state to up
*Aug  4 19:22:06.113 IST: %SPA_OIR-6-ONLINECARD: SPA (SPA-1X10GE-L-V2) online in subslot
2/1
*Aug  4 19:22:06.082 IST: %TRANSCEIVER-6-INSERTED: SIP2/1: transceiver module inserted in

```



```

TenGigabitEthernet2/1/0
*Aug 4 19:22:08.080 IST: %LINK-3-UPDOWN: SIP2/2: Interface EOBC2/1, changed state to up
*Aug 4 19:22:11.627 IST: %SPA_OIR-6-ONLINECARD: SPA (SPA-1X10GE-L-V2) online in subslot
2/2
*Aug 4 19:22:11.616 IST: %TRANSCEIVER-6-INSERTED: SIP2/2: transceiver module inserted in
TenGigabitEthernet2/2/0
*Aug 4 19:22:12.523 IST: %LINK-3-UPDOWN: SIP2/3: Interface EOBC2/1, changed state to up
*Aug 4 19:22:16.657 IST: %SPA_OIR-6-ONLINECARD: SPA (SPA-1X10GE-L-V2) online in subslot
2/3
*Aug 4 19:22:16.648 IST: %TRANSCEIVER-6-INSERTED: SIP2/3: transceiver module inserted in
TenGigabitEthernet2/3/0
Router# issu
commitversion
--- Starting local lock acquisition on R0 ---
Finished local lock acquisition on R0
--- Starting installation changes ---
Cancelling rollback timer
Finished installation changes
SUCCESS: Installation changes committed
Router# issu loadversion rp 0 file
bootflash:Active_Dir/asr1000rp2-{elcbase,elcspa}*03.13.00.S.154-3.S-ext*.pkg slot 4

--- Starting local lock acquisition on R0 ---
Finished local lock acquisition on R0
--- Starting installation state synchronization ---
Finished installation state synchronization
--- Starting file path checking ---
Finished file path checking
--- Starting image file verification ---
Checking image file names
Locating image files and validating name syntax
  Found asr1000rp2-elcbase.03.13.00.S.154-3.S-ext.pkg
  Found asr1000rp2-elcspa.03.13.00.S.154-3.S-ext.pkg
Verifying image file locations
Inspecting image file types
Processing image file constraints
Creating candidate provisioning file
Finished image file verification
--- Starting candidate package set construction ---
Verifying existing software set
Processing candidate provisioning file
Constructing working set for candidate package set
Constructing working set for running package set
Checking command output
Constructing merge of running and candidate packages
Checking if resulting candidate package set would be complete
Finished candidate package set construction
--- Starting compatibility testing ---
Determining whether candidate package set is compatible
WARNING:
WARNING: Candidate software combination not found in compatibility database
WARNING:
Determining whether installation is valid
Creating matrix_file by locate_latest_matrix_file /tmp/issu/provision/sw
WARNING:
WARNING: Candidate software combination not found in compatibility database
WARNING:
WARNING:
WARNING: Candidate software combination not found in compatibility database
WARNING:
Software sets are identified as compatible
Verifying image type compatibility
Checking IPC compatibility with running software
Checking candidate package set infrastructure compatibility

```

```

Checking infrastructure compatibility with running software
Checking package specific compatibility
Finished compatibility testing
--- Starting impact testing ---
Checking operational impact of change
Finished impact testing
--- Starting list of software package changes ---
No old package files removed
New files list:
  Added asr1000rp2-elcbase.03.13.00.S.154-3.S-ext.pkg
  Added asr1000rp2-elcspa.03.13.00.S.154-3.S-ext.pkg
Finished list of software package changes
--- Starting commit of software changes ---
Updating provisioning rollback files
Creating pending provisioning file
Committing provisioning file
Finished commit of software changes
--- Starting analysis of software changes ---
Finished analysis of software changes
--- Starting update running software ---
Blocking peer synchronization of operating information
Creating the command set placeholder directory
  Finding latest command set
  Finding latest command shortlist lookup file
  Finding latest command shortlist file
  Assembling CLI output libraries
  Assembling CLI input libraries
  Assembling Dynamic configuration files
  Applying interim IPC and database definitions
  Replacing running software
  Replacing CLI software
  Restarting software
  Applying final IPC and database definitions
*Aug 4 19:22:05.767 IST: %IOSXE_OIR-6-OFFLINECARD: Card (cc) offline in slot 4
*Aug 4 19:22:05.770 IST: %IOSXE_OIR-6-REMSPA: SPA removed from subslot 4/0, interfaces
disabled
  Generating software version information
  Notifying running software of updates
  Unblocking peer synchronization of operating information
Unmounting old packages
Cleaning temporary installation files
  Finished update running software

SUCCESS: Finished installing software.
*Aug 4 19:24:05.041 IST: %IOSXE_OIR-6-ONLINECARD: Card (cc) online in slot 4
*Aug 4 19:24:14.250 IST: %IOSXE_OIR-6-INSSPA: SPA inserted in subslot 4/0
*Aug 4 19:24:34.196 IST: %LINK-3-UPDOWN: SIP4/0: Interface EOBC0/1, changed state to up
*Aug 4 19:25:27.923 IST: %LINK-3-UPDOWN: Interface GigabitEthernet4/0/0, changed state to
down
*Aug 4 19:25:30.497 IST: %LINK-3-UPDOWN: Interface GigabitEthernet4/0/1, changed state to
down
*Aug 4 19:25:40.915 IST: %SPA_OIR-6-ONLINECARD: SPA (BUILT-IN-2T+20X1GE) online in subslot
4/0
*Aug 4 19:25:53.574 IST: %LINK-3-UPDOWN: Interface GigabitEthernet4/0/0, changed state to
up
*Aug 4 19:25:53.582 IST: %LINK-3-UPDOWN: Interface GigabitEthernet4/0/1, changed state to
up
Router# issu commitversion
--- Starting local lock acquisition on R0 ---
Finished local lock acquisition on R0
--- Starting installation changes ---
Cancelling rollback timer
Finished installation changes
SUCCESS: Installation changes committed

```

```
Router# issu loadversion rp 0 file
bootflash:Active_Dir/asr1000rp2-esp*03.13.00.S.154-3.S-ext*.pkg slot 1
--- Starting local lock acquisition on R0 ---
Finished local lock acquisition on R0
--- Starting installation state synchronization ---
Finished installation state synchronization
--- Starting file path checking ---
Finished file path checking
--- Starting image file verification ---
Checking image file names
Locating image files and validating name syntax
  Found asr1000rp2-espbase.03.13.00.S.154-3.S-ext.pkg
  Found asr1000rp2-esp86base.03.13.00.S.154-3.S-ext.pkg
Verifying image file locations
Inspecting image file types
Processing image file constraints
Creating candidate provisioning file
Finished image file verification
--- Starting candidate package set construction ---
Verifying existing software set
Processing candidate provisioning file
Constructing working set for candidate package set
Constructing working set for running package set
Checking command output
Constructing merge of running and candidate packages
Checking if resulting candidate package set would be complete
Finished candidate package set construction
--- Starting compatibility testing ---
Determining whether candidate package set is compatible
WARNING:
WARNING: Candidate software combination not found in compatibility database
WARNING:
Determining whether installation is valid
Creating matrix_file by locate_latest_matrix_file /tmp/issu/provision/sw
WARNING:
WARNING: Candidate software combination not found in compatibility database
WARNING:
WARNING:
WARNING: Candidate software combination not found in compatibility database
WARNING:
Software sets are identified as compatible
Verifying image type compatibility
Checking IPC compatibility with running software
Checking candidate package set infrastructure compatibility
Checking infrastructure compatibility with running software
Checking package specific compatibility
Finished compatibility testing
--- Starting impact testing ---
Checking operational impact of change
Finished impact testing
--- Starting list of software package changes ---
No old package files removed
New files list:
  Added asr1000rp2-espbase.03.13.00.S.154-3.S-ext.pkg
  Added asr1000rp2-esp86base.03.13.00.S.154-3.S-ext.pkg
Finished list of software package changes
--- Starting commit of software changes ---
Updating provisioning rollback files
Creating pending provisioning file
Committing provisioning file
Finished commit of software changes
--- Starting analysis of software changes ---
Finished analysis of software changes
--- Starting update running software ---
```

```

Blocking peer synchronization of operating information
Creating the command set placeholder directory
  Finding latest command set
  Finding latest command shortlist lookup file
  Finding latest command shortlist file
  Assembling CLI output libraries
  Assembling CLI input libraries
  Assembling Dynamic configuration files
  Applying interim IPC and database definitions
  Replacing running software
  Replacing CLI software
  Restarting software
    Restarting ESP1
  Applying final IPC and database definitions
Aug  4 19:29:16.751 IST: %IOSXE_OIR-6-OFFLINECARD: Card (fp) offline in slot F1
*Aug  4 19:29:18.172 IST: %CMRP-6-FP_HA_STATUS: R0/0: cmand:  F0 redundancy state is Active
with no Standby  Generating software version information
  Notifying running software of updates
  Unblocking peer synchronization of operating information
Unmounting old packages
Cleaning temporary installation files
  Finished update running software

SUCCESS: Finished installing software.
*Aug  4 19:30:50.972 IST: %CPPHA-7-START: F1: cpp_ha:  CPP 0 preparing image
/tmp/sw/fp/1/0/fpx86/mount/usr/cpp/bin/qfp-ucode-esp40
*Aug  4 19:30:51.362 IST: %CPPHA-7-START: F1: cpp_ha:  CPP 0 startup init image
/tmp/sw/fp/1/0/fpx86/mount/usr/cpp/bin/qfp-ucode-esp40
*Aug  4 19:30:53.088 IST: %IOSXE_OIR-6-ONLINECARD: Card (fp) online in slot F1
Router# issu commitversion
--- Starting local lock acquisition on R0 ---
Finished local lock acquisition on R0
--- Starting installation changes ---
Cancelling rollback timer
Finished installation changes
SUCCESS: Installation changes committed
Router# issu loadversion rp 0 file
bootflash:Active_Dir/asr1000rp2-esp*03.13.00.S.154-3.S-ext*.pkg slot 0
--- Starting local lock acquisition on R0 ---
Finished local lock acquisition on R0
--- Starting installation state synchronization ---
Finished installation state synchronization
--- Starting file path checking ---
Finished file path checking
--- Starting image file verification ---
Checking image file names
Locating image files and validating name syntax
  Found asr1000rp2-espbase.03.13.00.S.154-3.S-ext.pkg
  Found asr1000rp2-esp86base.03.13.00.S.154-3.S-ext.pkg
Verifying image file locations
Inspecting image file types
Processing image file constraints
Creating candidate provisioning file
Aug  4 19:31:14.730 IST: %CPPHA-7-START: F1: cpp_ha:  CPP 0 running init image
/tmp/sw/fp/1/0/fpx86/mount/usr/cpp/bin/qfp-ucode-esp40
*Aug  4 19:31:15.079 IST: %CPPHA-7-READY: F1: cpp_ha:  CPP 0 loading and initialization
completeFinished image file verification
--- Starting candidate package set construction ---
Verifying existing software set
*Aug  4 19:31:15.309 IST: %IOSXE-6-PLATFORM: F1: cpp_cp: Process
CPP_FILTER_EA_EVENT_API_CALL_REGISTERProcessing candidate provisioning file
*Aug  4 19:31:18.010 IST: %CMRP-6-FP_HA_STATUS: R0/0: cmand:  F0 redundancy state is Active
with ready StandbyConstructing working set for candidate package
setConstructing working set for running package set

```

```

Checking command output
Constructing merge of running and candidate packages
Checking if resulting candidate package set would be complete
Finished candidate package set construction
--- Starting compatibility testing ---
Determining whether candidate package set is compatible
WARNING:
WARNING: Candidate software combination not found in compatibility database
WARNING:
Determining whether installation is valid
Creating matrix_file by locate_latest_matrix_file /tmp/issu/provision/sw
Software sets are identified as compatible
Verifying image type compatibility
Checking IPC compatibility with running software
Checking candidate package set infrastructure compatibility
Checking infrastructure compatibility with running software
Checking package specific compatibility
Finished compatibility testing
--- Starting impact testing ---
Checking operational impact of change
Finished impact testing
--- Starting list of software package changes ---
Old files list:
    Removed asr1000rp2-espbase.03.12.01.S.154-2.S.pkg
    Removed asr1000rp2-esp86base.03.12.01.S.154-2.S.pkg
No new package files added
Finished list of software package changes
--- Starting commit of software changes ---
Updating provisioning rollback files
Creating pending provisioning file
Committing provisioning file
Finished commit of software changes
--- Starting analysis of software changes ---
Finished analysis of software changes
--- Starting update running software ---
Blocking peer synchronization of operating information
Creating the command set placeholder directory
    Finding latest command set
    Finding latest command shortlist lookup file
    Finding latest command shortlist file
    Assembling CLI output libraries
    Assembling CLI input libraries
    Assembling Dynamic configuration files
    Applying interim IPC and database definitions
    Replacing running software
    Replacing CLI software
    Restarting software
        Restarting ESP0
    Applying final IPC and database definitions
*Aug  4 19:32:46.187 IST: %IOSXE_OIR-6-OFFLINECARD: Card (fp) offline in slot F0
*Aug  4 19:32:46.539 IST: %CMRP-6-FP_HA_STATUS: R0/0: cmand: F1 redundancy state is Active
    Generating software version information
    Notifying running software of updates
    Unblocking peer synchronization of operating information
Unmounting old packages
Cleaning temporary installation files
    Finished update running software

SUCCESS: Finished installing software.
*Aug  4 19:34:19.748 IST: %CPPHA-7-START: F0: cpp_ha: CPP 0 preparing image
/tmp/sw/fp/0/0/fpx86/mount/usr/cpp/bin/qfp-ucode-esp40
*Aug  4 19:34:20.139 IST: %CPPHA-7-START: F0: cpp_ha: CPP 0 startup init image
/tmp/sw/fp/0/0/fpx86/mount/usr/cpp/bin/qfp-ucode-esp40
*Aug  4 19:34:21.858 IST: %IOSXE_OIR-6-ONLINECARD: Card (fp) online in slot F0

```

```

*Aug  4 19:34:43.609 IST: %CPPHA-7-START: F0: cpp_ha: CPP 0 running init image
/tmp/sw/fp/0/0/fpx86/mount/usr/cpp/bin/qfp-ucode-esp40
*Aug  4 19:34:43.958 IST: %CPPHA-7-READY: F0: cpp_ha: CPP 0 loading and initialization
complete
*Aug  4 19:34:44.190 IST: %IOSXE-6-PLATFORM: F0: cpp_cp: Process
CPP_PFILTER_EA_EVENT_API_CALL_REGISTER
*Aug  4 19:34:46.890 IST: %CMRP-6-FP_HA_STATUS: R0/0: cmand: F0 redundancy state is Standby
Router# issu commitversion
--- Starting local lock acquisition on R0 ---
Finished local lock acquisition on R0
--- Starting installation changes ---
Cancelling rollback timer
Finished installation changes
SUCCESS: Installation changes committed
Router# issu loadversion rp 0 file bootflash:Active_Dir/asr1000rp2*03.13.00.S.154-3.S-ext*.pkg
force
--- Starting local lock acquisition on R0 ---
Finished local lock acquisition on R0
s
--- Starting installation state synchronization ---
Finished installation state synchronization
--- Starting file path checking ---
Finished file path checking
--- Starting image file verification ---
Checking image file names
Locating image files and validating name syntax
  Found asr1000rp2-elcbase.03.13.00.S.154-3.S-ext.pkg
  Found asr1000rp2-elcspa.03.13.00.S.154-3.S-ext.pkg
  Found asr1000rp2-espbase.03.13.00.S.154-3.S-ext.pkg
  Found asr1000rp2-esp86base.03.13.00.S.154-3.S-ext.pkg
  Found asr1000rp2-rpaccess.03.13.00.S.154-3.S-ext.pkg
  Found asr1000rp2-rpbase.03.13.00.S.154-3.S-ext.pkg
  Found asr1000rp2-rpcontrol.03.13.00.S.154-3.S-ext.pkg
  Found asr1000rp2-rpios-adventerprisek9.03.13.00.S.154-3.S-ext.pkg
  Found asr1000rp2-sipbase.03.13.00.S.154-3.S-ext.pkg
  Found asr1000rp2-sipspa.03.13.00.S.154-3.S-ext.pkg
Verifying image file locations
Inspecting image file types
  WARNING: In-service installation of IOSD package
  WARNING: requires software redundancy on target RP
  WARNING: or on-reboot parameter
  WARNING: Automatically setting the on-reboot flag
  WARNING: In-service installation of RP Base package
  WARNING: requires software reboot of target RP
Processing image file constraints
Creating candidate provisioning file
Finished image file verification
--- Starting candidate package set construction ---
Verifying existing software set
Processing candidate provisioning file
Constructing working set for candidate package set
Constructing working set for running package set
Checking command output
Constructing merge of running and candidate packages
Checking if resulting candidate package set would be complete
Finished candidate package set construction
--- Starting compatibility testing ---
Determining whether candidate package set is compatible
Determining whether installation is valid
Determining whether installation is valid ... skipped
Verifying image type compatibility
Checking IPC compatibility for candidate software
Checking candidate package set infrastructure compatibility
Checking infrastructure compatibility with running software

```

```

Checking infrastructure compatibility with running software ... skipped
Checking package specific compatibility
Finished compatibility testing
--- Starting list of software package changes ---
Old files list:
  Removed asr1000rp2-elcbase.03.12.01.S.154-2.S.pkg
  Removed asr1000rp2-elcspa.03.12.01.S.154-2.S.pkg
  Removed asr1000rp2-rpaccess.03.12.01.S.154-2.S.pkg
  Removed asr1000rp2-rpbase.03.12.01.S.154-2.S.pkg
  Removed asr1000rp2-rpcontrol.03.12.01.S.154-2.S.pkg
  Removed asr1000rp2-rpios-adventerprisek9.03.12.01.S.154-2.S.pkg
  Removed asr1000rp2-sipbase.03.12.01.S.154-2.S.pkg
  Removed asr1000rp2-sipspa.03.12.01.S.154-2.S.pkg
New files list:
  Added asr1000rp2-rpaccess.03.13.00.S.154-3.S-ext.pkg
  Added asr1000rp2-rpbase.03.13.00.S.154-3.S-ext.pkg
  Added asr1000rp2-rpcontrol.03.13.00.S.154-3.S-ext.pkg
  Added asr1000rp2-rpios-adventerprisek9.03.13.00.S.154-3.S-ext.pkg
Finished list of software package changes
--- Starting commit of software changes ---
Updating provisioning rollback files
Creating pending provisioning file
Committing provisioning file
Finished commit of software changes
SUCCESS: Software provisioned.  New software will load on reboot.
Router# show platform
Chassis type: ASR1013
Slot      Type                State                Insert time (ago)
-----
  2        ASR1000-SIP40       ok                   1d04h
  2/0      SPA-1X10GE-L-V2    ok                   1d04h
  2/1      SPA-1X10GE-L-V2    ok                   1d04h
  2/2      SPA-1X10GE-L-V2    ok                   1d04h
  2/3      SPA-1X10GE-L-V2    ok                   1d04h
  4        ASR1000-2T+20X1GE  ok                   1d04h
  4/0      BUILT-IN-2T+20X1GE ok                   1d04h
  R0       ASR1000-RP2        ok, active          1d04h
  R1       ASR1000-RP2        ok, standby         1d04h
  F0       ASR1000-ESP100     ok, standby         1d04h
  F1       ASR1000-ESP100     ok, active          1d04h
  P0       ASR1013-PWR-AC     ok                   1d04h
  P1       ASR1013-PWR-AC     ok                   1d04h
  P2       ASR1013-PWR-AC     ok                   1d04h
  P3       ASR1013-PWR-AC     ps, fail            1d04h
Slot      CPLD Version        Firmware Version
-----
  2        00200800            15.3(3r)S
  4        00200800            15.2(1r)S
  R0       10021901            15.3(3r)S
  R1       10021901            15.3(3r)S
  F0       12071700            15.3(3r)S
  F1       12071700            15.3(3r)S
Router# show version R0 provisioned
Package: Provisioning File, version: n/a, status: active
  File: bootflash:Active_Dir/packages.conf, on: RP0
  Built: n/a, by: n/a
  File SHA1 checksum: c79075780592aec1312725f4a2357a034fda2d3b
Package: rpbase, version: 03.13.00.S.154-3.S-ext, status: n/a
  File: bootflash:Active_Dir/asr1000rp2-rpbase.03.13.00.S.154-3.S-ext.pkg, on: RP0
  Built: 2013-07-25_22.55, by: mcpre
  File SHA1 checksum: 4f655c54bb95b4dfa24a0d25ebf97cf8527c69e9
Package: rpcontrol, version: 03.13.00.S.154-3.S-ext, status: n/a
  File: bootflash:Active_Dir/asr1000rp2-rpcontrol.03.13.00.S.154-3.S-ext.pkg, on: RP0/0
  Built: 2013-07-25_22.55, by: mcpre

```

```

File SHA1 checksum: 8a0a45ea5c7a656c0eef6726174461584f182c78
Package: rpios-adventerprisek9, version: 03.13.00.S.154-3.S-ext, status: n/a
File: bootflash:Active_Dir/asr1000rp2-rpios-adventerprisek9.03.13.00.S.154-3.S-ext.pkg,
on: RP0/0
  Built: 2013-07-25_23.00, by: mcpre
File SHA1 checksum: 85e9eab826bff2194ef568a56c76453625383ad2
Package: rpaccess, version: 03.13.00.S.154-3.S-ext, status: n/a
File: bootflash:Active_Dir/asr1000rp2-rpaccess.03.13.00.S.154-3.S-ext.pkg, on: RP0/0
  Built: 2013-07-25_22.55, by: mcpre
File SHA1 checksum: a360dff0fd76a9b1ae67cda9116c97b62f25ab09
Package: rpcontrol, version: 03.13.00.S.154-3.S-ext, status: n/a
File: bootflash:Active_Dir/asr1000rp2-rpcontrol.03.13.00.S.154-3.S-ext.pkg, on: RP0/1
  Built: 2013-07-25_22.55, by: mcpre
File SHA1 checksum: 8a0a45ea5c7a656c0eef6726174461584f182c78
Package: rpios-adventerprisek9, version: 03.13.00.S.154-3.S-ext, status: n/a
File: bootflash:Active_Dir/asr1000rp2-rpios-adventerprisek9.03.13.00.S.154-3.S-ext.pkg,
on: RP0/1
  Built: 2013-07-25_23.00, by: mcpre
File SHA1 checksum: 85e9eab826bff2194ef568a56c76453625383ad2
Package: rpaccess, version: 03.13.00.S.154-3.S-ext, status: n/a
File: bootflash:Active_Dir/asr1000rp2-rpaccess.03.13.00.S.154-3.S-ext.pkg, on: RP0/1
  Built: 2013-07-25_22.55, by: mcpre
File SHA1 checksum: a360dff0fd76a9b1ae67cda9116c97b62f25ab09
Package: rpbase, version: 03.13.00.S.154-3.S-ext, status: n/a
File: bootflash:Active_Dir/asr1000rp2-rpbase.03.13.00.S.154-3.S-ext.pkg, on: RP1
  Built: 2013-07-25_22.55, by: mcpre
File SHA1 checksum: 4f655c54bb95b4dfa24a0d25ebf97cf8527c69e9
Package: rpcontrol, version: 03.13.00.S.154-3.S-ext, status: n/a
File: bootflash:Active_Dir/asr1000rp2-rpcontrol.03.13.00.S.154-3.S-ext.pkg, on: RP1/0
  Built: 2013-07-25_22.55, by: mcpre
File SHA1 checksum: 8a0a45ea5c7a656c0eef6726174461584f182c78
<some output removed for brevity>
Router# show version R0 provisioned
Package: Provisioning File, version: n/a, status: active
File: bootflash:Active_Dir/packages.conf, on: RP0
  Built: n/a, by: n/a
File SHA1 checksum: c79075780592aec1312725f4a2357a034fda2d3b
Package: rpbase, version: 03.12.01.S.154-2.S, status: active
File: bootflash:Active_Dir/asr1000rp2-rpbase.03.12.01.S.154-2.S.pkg, on: RP0
  Built: 2013-03-25_18.48, by: mcpre
File SHA1 checksum: 3a9675142898cfac350d4e42f0e37bd9f4e48538
Package: rpcontrol, version: 03.12.01.S.154-2.S, status: active
File: bootflash:Active_Dir/asr1000rp2-rpcontrol.03.12.01.S.154-2.S.pkg, on: RP0/0
  Built: 2013-03-25_18.48, by: mcpre
File SHA1 checksum: 87b11f863f67fdf2610ee0769b929baab4c3efad
Package: rpios-adventerprisek9, version: 03.12.01.S.154-2.S, status: active
File: bootflash:Active_Dir/asr1000rp2-rpios-adventerprisek9.03.12.01.S.154-2.S.pkg, on:
RP0/0
  Built: 2013-03-25_18.51, by: mcpre
File SHA1 checksum: b487136319da0a327844d353c77e533c53c56053
Package: rpaccess, version: 03.12.01.S.154-2.S, status: active
File: bootflash:Active_Dir/asr1000rp2-rpaccess.03.12.01.S.154-2.S.pkg, on: RP0/0
  Built: 2013-03-25_18.48, by: mcpre
File SHA1 checksum: 032bea36f74b19977b363243c99f02413b54104d
<some output removed for brevity>
Router# redundancy force-switchover
Proceed with switchover to standby RP? [confirm]
<output removed for brevity>
Router# request platform software package clean
Cleaning up unnecessary package files
No path specified, will use booted
path bootflash:Active_Dir/packages.conf
Cleaning bootflash:Active_Dir
Scanning boot directory for packages ... done.

```



```

Preparing packages list to delete ... asr1000rp2-elcbase.03.13.00.S.154-3.S-ext.pkg
  File is in use, will not delete...asr1000rp2-elcspa.03.13.00.S.154-3.S-ext.pkg
  File is in use, will not delete...asr1000rp2-espbase.03.13.00.S.154-3.S-ext.pkg
  File is in use, will not delete...asr1000rp2-esp86base.03.13.00.S.154-3.S-ext.pkg
  File is in use, will not delete...asr1000rp2-rpaccess.03.13.00.S.154-3.S-ext.pkg
  File is in use, will not delete...asr1000rp2-rpbase.03.13.00.S.154-3.S-ext.pkg
  File is in use, will not delete...asr1000rp2-rpcontrol.03.13.00.S.154-3.S-ext.pkg
  File is in use, will not delete...asr1000rp2-rpios-adventerprisek9.03.10.00.S.153
-3.S-ext.pkg
  File is in use, will not delete...asr1000rp2-sipbase.03.13.00.S.154-3.S-ext.pkg
  File is in use, will not delete...asr1000rp2-sipspa.03.13.00.S.154-3.S-ext.pkg
  File is in use, will not delete...packages.conf
  File is in use, will not delete... done.

Files that will be deleted: asr1000rp2-elcbase.03.12.01.S.154-2.S.pkg
  asr1000rp2-elcspa.03.12.01.S.154-2.S.pkg
  asr1000rp2-espbase.03.12.01.S.154-2.S.pkg
  asr1000rp2-esp86base.03.12.01.S.154-2.S.pkg
  asr1000rp2-packages-adventerprisek9.03.12.01.S.154-2.S.conf
  asr1000rp2-rpaccess.03.12.01.S.154-2.S.pkg
  asr1000rp2-rpbase.03.12.01.S.154-2.S.pkg
  asr1000rp2-rpcontrol.03.12.01.S.154-2.S.pkg
  asr1000rp2-rpios-adventerprisek9.03.12.01.S.154-2.S.pkg
  asr1000rp2-sipbase.03.12.01.S.154-2.S.pkg
  asr1000rp2-sipspa.03.12.01.S.154-2.S.pkg
  packages.conf.00-
Do you want to proceed? [confirm]y
  Deleting file bootflash:Active_Dir/asr1000rp2-elcbase.03.12.01.S.154-2.S.pkg ... done.
  Deleting file bootflash:Active_Dir/asr1000rp2-elcspa.03.12.01.S.154-2.S.pkg ... done.
  Deleting file bootflash:Active_Dir/asr1000rp2-espbase.03.12.01.S.154-2.S.pkg ... done.
  Deleting file bootflash:Active_Dir/asr1000rp2-esp86base.03.12.01.S.154-2.S.pkg... done.
  Deleting file
bootflash:Active_Dir/asr1000rp2-packages-adventerprisek9.03.12.01.S.154-2.S.conf ... done.
  Deleting file bootflash:Active_Dir/asr1000rp2-rpaccess.03.12.01.S.154-2.S.pkg ... done.
  Deleting file bootflash:Active_Dir/asr1000rp2-rpbase.03.12.01.S.154-2.S.pkg ... done.
  Deleting file bootflash:Active_Dir/asr1000rp2-rpcontrol.03.12.01.S.154-2.S.pkg ... done.
  Deleting file bootflash:Active_Dir/asr1000rp2-rpios-adventerprisek9.03.12.01.S.154-2.S.pkg
... done.
  Deleting file bootflash:Active_Dir/asr1000rp2-sipbase.03.12.01.S.154-2.S.pkg ... done.
  Deleting file bootflash:Active_Dir/asr1000rp2-sipspa.03.12.01.S.154-2.S.pkg ... done.
  Deleting file bootflash:Active_Dir/packages.conf.00- ... done.
SUCCESS: Files deleted.

```

Using ISSU to Upgrade Subpackages on a Cisco ASR 1006 Router, ASR1006-X Router, ASR1009-X Router, or ASR 1013 Router (request platform command set)

This procedure can only be performed if the current ASR 1006 router or ASR 1013 router has two active RPs and both RPs are running subpackages.

To perform an ISSU upgrade using subpackages on a Cisco ASR 1006 router or ASR 1013 router with a dual RP setup using the **request platform** command set, follow the following instructions.

SUMMARY STEPS

1. **show version**
2. **mkdir** *URL-to-directory-name*
3. **ip tftp source-interface gigabitethernet port**
4. **copy tftp:** *URL-to-target-location*
5. **request platform software package expand file** *URL-to-consolidated-package*
6. **dir** *target-URL*

7. **copy file-system:asr1000rp2-espbase.version.pkg** *URL-to-directory-of-sub-packages-active-RP*
8. **copy file-system:asr1000rp2-espbase.version.pkg** *URL-to-directory-of-sub-packages-standby-RP*
9. **request platform software package install rp** *standby-RP file*
*target-standbyRP-URL-for-sub-packages:asr1000rp*version*.pkg force*
10. **hw-module slot** *standby-RP* **reload**
11. **request platform software package install rp** *active-RP file*
*URL-to-active-file-system:asr1000rp2-{sipbase,sipspa}*version*.pkg slotSIP-slot-numberforce*
12. **request platform software package install rp** *active-RP file*
*URL-to-active-file-system:asr1000rp2-{elcbase,elcspa}*version*.pkg slotELC-slot-numberforce*
13. **request platform software package install rp** *active-RP file*
*URL-to-active-file-system:asr1000rp2-esp*version*.pkg slot* *standby-ESP-slot*
14. **request platform software package install rp** *active-RP file*
*URL-to-active-file-system:asr1000rp*version*.pkg force*
15. **show version** *active-RP* **provisioned**
16. **redundancy force-switchover**
17. **request platform software package clean**

DETAILED STEPS

	Command or Action	Purpose
Step 1	<p>show version</p> <p>Example:</p> <pre>show version active-rp installed</pre> <p>Example: <pre>show version standby-rp installed</pre> <p>Example:</p> <pre>dir filesystem:<directory></pre> <p>Example:</p> <pre>show platform</pre> <p>Example:</p> <pre>Router# show version</pre> <p>Example:</p> <pre>Router# show version r0 installed</pre> <p>Example:</p> <pre>Router# show version r1 installed</pre> <p>Example:</p> <pre>Router# dir bootflash:</pre> </p>	<p>(Optional) Use the following commands to confirm the current router configuration, as follows:</p> <ul style="list-style-type: none"> • show version and show version active-rp installed—Verify the running version of the Cisco IOS XE software on the router, and which file was used to boot the router, and where that file is stored. • dir—Confirm that the files that were used to boot the router are located in the directory. • show platform—Confirm the current status of the active and standby RPs.

	Command or Action	Purpose
	<p>Example:</p> <pre>Router# show platform</pre>	
Step 2	<p>mkdir <i>URL-to-directory-name</i></p> <p>Example:</p> <p>Example:</p> <pre>Router# mkdir usb0:221subs</pre> <p>Example:</p>	<p>Creates a directory to store the consolidated package and subpackages.</p> <p>This directory must be created in most cases because the consolidated packages and subpackages have to be separated from the subpackages that booted the router at this step of the procedure.</p>
Step 3	<p>ip tftp source-interface gigabitethernet port</p> <p>Example:</p> <pre>Router(config)# ip tftp source-interface gigabitethernet 0</pre>	<p>Specifies the Gigabit Ethernet TFTP source-interface to be configured:</p> <p>slot/port—Specifies the location of the TFTP source-interface.</p> <p>Note To copy a file using TFTP through the Management Ethernet interface, the ip tftp source-interface GigabitEthernet 0 command must be entered before entering the copy tftp command.</p>
Step 4	<p>copy tftp: <i>URL-to-target-location</i></p> <p>Example:</p> <p>Example:</p> <pre>Router# copy tftp: usb0:221subs</pre>	<p>Copies the consolidated package file into the directory created in Step 2.</p> <p>The consolidated package in this step should not be copied into the same directory where the subpackages that are currently running your router are stored (the directory containing the packages.conf provisioning file from which the router was booted).</p> <p>Tip It is recommended that you copy the package onto a usb: or harddisk: file system for space considerations when performing this step of the procedure.</p>
Step 5	<p>request platform software package expand file <i>URL-to-consolidated-package</i></p> <p>Example:</p> <p>Example:</p> <pre>Router# request platform software package expand file usb0:221subs/asr1000r2-adventerprisek9.03.13.00.S.154-3.S-ext.bin</pre>	<p>Extracts the subpackages out of the consolidated package file into the temporary directory.</p> <p>Note Take extra care to extract the subpackages to a temporary subdirectory and do not delete any of the files currently running the router at this point of the procedure. To erase the files that were running on the router before the ISSU upgrade, enter the request platform software package clean command after the ISSU upgrade has been completed.</p>

	Command or Action	Purpose
	Example:	
Step 6	<p>dir <i>target-URL</i></p> <p>Example:</p> <p>Example:</p> <pre>Router# dir usb0:221subs</pre>	(Optional) Displays the directory to confirm that the files were extracted.
Step 7	<p>copy <i>file-system:asr1000rp2-espbase.version.pkg</i> <i>URL-to-directory-of-sub-packages-active-RP</i></p> <p>Example:</p> <pre>copy file-system:asr1000rp2-espx86base.version.pkg URL-to-directory-of-sub-packages-active-RP</pre> <p>Example:</p> <pre>copy file-system:asr1000rp2-rpaccess.version.pkg URL-to-directory-of-sub-packages-active-RP</pre> <p>Example:</p> <pre>copy file-system:asr1000rp2-rpbase.version.pkg URL-to-directory-of-sub-packages-active-RP</pre> <p>Example:</p> <pre>copy file-system:asr1000rp2-rpcontrol.version.pkg URL-to-directory-of-sub-packages-active-RP</pre> <p>Example:</p> <pre>copy file-system:asr1000rp2-rpios.version.pkg URL-to-directory-of-sub-packages-active-RP</pre> <p>Example:</p> <pre>copy file-system:asr1000rp2-sipbase.version.pkg URL-to-directory-of-sub-packages-active-RP</pre> <p>Example:</p> <pre>copy file-system:asr1000rp2-sipspa.version.pkg URL-to-directory-of-sub-packages-active-RP</pre> <p>Example:</p> <pre>copy file-system:asr1000rp2-elcbase.version.pkg URL-to-directory-of-sub-packages-active-RP</pre>	Copies the subpackages out of the temporary directory into the directory on the router where the subpackages running the active RP are currently stored.

	Command or Action	Purpose
	<p>Example:</p> <pre>copy file-system: asr1000rp2-elcspa.version.pkg URL-to-directory-of-sub-packages-active-RP</pre> <p>Example:</p> <p>Example:</p> <pre>Router# copy usb0:221subs/asr1000rp2-esbase.03.13.00.S.154-3.S-ext.pkg bootflash:</pre> <p>Example:</p> <p>Example:</p> <pre>Router# copy usb0:221subs/asr1000rp2-esbase.03.13.00.S.154-3.S-ext.pkg bootflash:</pre> <p>Example:</p> <pre>Router# copy usb0:221subs/asr1000rp2-raccess.03.13.00.S.154-3.S-ext.pkg bootflash:</pre> <p>Example:</p> <p>Example:</p> <pre>Router# copy usb0:221subs/asr1000rp2-rbase.03.13.00.S.154-3.S-ext.pkg bootflash:</pre> <p>Example:</p> <p>Example:</p> <pre>Router# copy usb0:221subs/asr1000rp2-rcontrol.03.13.00.S.154-3.S-ext.pkg bootflash:</pre> <p>Example:</p> <p>Example:</p> <pre>Router# copy</pre>	

	Command or Action	Purpose
	<pre>usb0:221subs/asr1000rp2-espbase.03.13.00.S.154-3.S-ext.pkg bootflash: Example: Example: Router# copy usb0:221subs/asr1000rp2-sipbase.03.13.00.S.154-3.S-ext.pkg bootflash: Example: Example: Router# copy usb0:221subs/asr1000rp2-sipspa.03.13.00.S.154-3.S-ext.pkg bootflash: Example: Example: Router# copy usb0:221subs/asr1000rp2-elcbase.03.13.00.S.154-3.S-ext.pkg bootflash: Example: Example: Router# copy usb0:221subs/asr1000rp2-elcspa.03.13.00.S.154-3.S-ext.pkg bootflash:</pre>	
Step 8	<pre>copy file-system:asr1000rp2-espbase.version.pkg URL-to-directory-of-sub-packages-standby-RP Example: copy file-system:asr1000rp2-esp86base.version.pkg URL-to-directory-of-sub-packages-standby-RP Example: copy file-system:asr1000rp2-rpaccess.version.pkg URL-to-directory-of-sub-packages-standby-RP Example:</pre>	Copies the subpackages out of the temporary directory into the directory on the router where the subpackages running the standby RP are currently stored.

	Command or Action	Purpose
	<p>copy <i>file-system: asr1000rp2-rpbase . version . pkg</i> <i>URL-to-directory-of-sub-packages-standby-RP</i></p> <p>Example:</p> <p>copy <i>file-system: asr1000rp2-rpcontrol . version . pkg</i> <i>URL-to-directory-of-sub-packages-standby-RP</i></p> <p>Example:</p> <p>copy <i>file-system: asr1000rp2-rpios . version . pkg</i> <i>URL-to-directory-of-sub-packages-standby-RP</i></p> <p>Example:</p> <p>copy <i>file-system: asr1000rp2-sipbase . version . pkg</i> <i>URL-to-directory-of-sub-packages-standby-RP</i></p> <p>Example:</p> <p>copy <i>file-system: asr1000rp2-sipspace . version . pkg</i> <i>URL-to-directory-of-sub-packages-standby-RP</i></p> <p>Example:</p> <p>copy <i>file-system: asr1000rp2-elcbase . version . pkg</i> <i>URL-to-directory-of-sub-packages-standby-RP</i></p> <p>Example:</p> <p>copy <i>file-system: asr1000rp2-elcspa . version . pkg</i> <i>URL-to-directory-of-sub-packages-standby-RP</i></p> <p>Example:</p> <p>Example:</p> <pre>Router# copy usb0:221sub/asr1000rp2-espbase.03.13.00.S.154-3.S-ext.pkg stby-bootflash:</pre> <p>Example:</p> <p>Example:</p> <pre>Router# copy usb0:221sub/asr1000rp2-espbase.03.13.00.S.154-3.S-ext.pkg stby-bootflash:</pre> <p>Example:</p>	

Command or Action	Purpose
<p>Example:</p> <pre>Router# copy usb0:221subs/asr1000p2-rpaccess.03.13.00.S.154-3.S-ext.pkg stby-bootflash:</pre> <p>Example:</p> <p>Example:</p> <pre>Router# copy usb0:221subs/asr1000p2-rpbase.03.13.00.S.154-3.S-ext.pkg stby-bootflash:</pre> <p>Example:</p> <pre>Router# copy usb0:221subs/asr1000p2-rpcontrol.03.13.00.S.154-3.S-ext.pkg stby-bootflash:</pre> <p>Example:</p> <pre>Router# copy usb0:221subs/asr1000p2-rpic-control.03.13.00.S.154-3.S-ext.pkg stby-bootflash:</pre> <p>Example:</p> <pre>Router# copy usb0:221subs/asr1000p2-rpic-data.03.13.00.S.154-3.S-ext.pkg stby-bootflash:</pre> <p>Example:</p> <pre>Router# copy usb0:221subs/asr1000p2-rpbase.03.13.00.S.154-3.S-ext.pkg stby-bootflash:</pre> <p>Example:</p> <p>Example:</p> <pre>Router# copy usb0:221subs/asr1000p2-rpspa.03.13.00.S.154-3.S-ext.pkg stby-bootflash:</pre> <p>Example:</p>	

	Command or Action	Purpose
	<p>Example:</p> <pre>Router# copy usb0:221subs/asr1000rp2-elcspa.03.13.00.S.154-3.S-ext.pkg stby-bootflash:</pre> <p>Example:</p> <p>Example:</p> <pre>Router# copy usb0:221subs/asr1000rp2-elcspa.03.13.00.S.154-3.S-ext.pkg stby-bootflash:</pre> <p>Example:</p>	
<p>Step 9</p>	<p>request platform software package install rp <i>standby-RP</i> file <i>target-standbyRP-URL-for-sub-packages:asr1000rp*version*.pkg</i> force</p> <p>Example:</p> <p>Example:</p> <pre>Router# request platform software package install rp 1 file stby-bootflash:asr1000rp*03.13.00.S.154-3.S-ext*.pkg force</pre>	<p>Upgrades the RP subpackages on the standby RP, where the “rp*” wildcard is specified to capture all of the RP subpackages for the desired upgrade release.</p> <p>Note From Polaris 16.x.x release, the image name starts with asr1000rpx86. Hence, the keyword <i>rpx86*</i> can be used during upgrade or downgrade between Polaris 16.x.x releases.</p>
<p>Step 10</p>	<p>hw-module slot <i>standby-RP</i> reload</p> <p>Example:</p> <p>Example:</p> <pre>Router# hw-module slot R1 reload</pre>	<p>Reloads the standby RP.</p>
<p>Step 11</p>	<p>request platform software package install rp <i>active-RP</i> file <i>URL-to-active-file-system:asr1000rp2-{sipbase,sipsa}*version*.pkg</i> slotSIP-slot-numberforce</p> <p>Example:</p>	<p>Upgrades the SIP and SPA subpackages for each SIP on the router.</p> <p>Note This step must be completed one SIP at a time, and repeated for each SIP installed on the router before performing the next step.</p>

	Command or Action	Purpose
	<p>Example:</p> <p>Example:</p> <p>Example:</p> <pre>Router# request platform software package install rp 0 file bootflash:asr1000rp2-(sipbase,sipspa)*03.13.00.S.154-3.S-ext*.pkg slot 2 force</pre> <p>Example:</p>	<p>Tip You can use the show ip interface brief command to identify which slots contain SIPs and SPAs. The interfaces with three numbers (in the form <i>SIP-number/SPA-number/interface-number</i>) identify the SIP and SPA locations in the router.</p> <p>Note The <i>pattern</i> options used in this CLI (sipbase and sipspa) were introduced in Cisco IOS XE Release 2.1.2 and are not available in previous Cisco IOS XE Releases. See the ISSU Procedures (Prior to Cisco IOS XE Release 2.1.2), on page 157 for pre-Cisco IOS XE Release 2.1.2 ISSU upgrade procedures</p>
Step 12	<p>request platform software package install rp active-RP file <i>URL-to-active-file-system:asr1000rp2-(elcbase,elcspa)*version*.pkg</i> slot ELC-slot-number force</p> <p>Example:</p> <p>Example:</p> <p>Example:</p> <pre>Router# request platform software package install rp 0 file bootflash:asr1000rp2-(elcbase,elcspa)*03.13.00.S.154-3.S-ext*.pkg slot 4 force</pre> <p>Example:</p>	<p>Upgrades the ELC and SPA subpackages for each ELC on the router.</p> <p>Note This step must be completed for one ELC at a time, and repeated for each ELC installed on the router before performing the next step.</p> <p>Tip You can use the show ip interface brief command to identify which slots contain ELCs and SPAs. The interfaces with three numbers (in the form <i>ELC-number/SPA-number/interface-number</i>) identify the ELC and SPA locations in the router.</p> <p>Note The <i>pattern</i> options used in this CLI (elcbase and elcspa) were introduced in Cisco IOS XE Release 3.10S and are not available in previous Cisco IOS XE Releases</p>
Step 13	<p>request platform software package install rp active-RP file <i>URL-to-active-file-system:asr1000rp2-esp*version*.pkg</i> slot standby-ESP-slot</p> <p>Example:</p> <p>Example:</p> <pre>request platform software package install rp active-RP file URL-to-active-file-system:asr1000rp2-esp*version*.pkg slot active-ESP-slot</pre> <p>Example:</p>	<p>Upgrades the ESP Base subpackage on the standby and the active ESPs.</p> <p>After entering the issu loadversion rp command on the active RP, the ESP switchover will occur automatically. Minimal traffic interruption will occur as a result of this switchover.</p>

	Command or Action	Purpose
	<p>Example:</p> <pre>Router# request platform software package install rp 0 file bootflash:asr1000rp2-esp*03.13.00.S.154-3.S-ext*.pkg slot 1</pre> <p>Example:</p> <pre>Router# request platform software package install rp 0 file bootflash:asr1000rp2-esp*03.13.00.S.154-3.S-ext*.pkg slot 0</pre>	
Step 14	<p>request platform software package install rp <i>active-RP</i> file <i>URL-to-active-file-system:asr1000rp*version*.pkg</i> force</p> <p>Example:</p> <p>Example:</p> <pre>Router# request platform software package install rp 0 file bootflash:asr1000rp2*03.13.00.S.154-3.S-ext*.pkg force</pre>	<p>Upgrades all of the sub-packages on the active RP.</p> <p>Note This step is required to ensure that all subpackages on the router were upgraded as part of this procedure, and might upgrade some subpackages that would otherwise be missed in the process.</p> <p>Note From Polaris 16.x.x release, the image name starts with asr1000rpx86. Hence, the keyword <i>rpx86*</i> can be used during upgrade or downgrade between Polaris 16.x.x releases.</p>
Step 15	<p>show version <i>active-RP</i> provisioned</p> <p>Example:</p> <p>show version <i>active-RP</i> installed</p> <p>Example:</p> <p>Example:</p> <pre>Router# show version r0 provisioned</pre> <p>Example:</p> <pre>Router# show version r0 installed</pre>	<p>(Optional) Confirms the subpackages are provisioned and installed.</p>
Step 16	<p>redundancy force-switchover</p> <p>Example:</p> <p>Example:</p> <pre>Router# redundancy force-switchover</pre>	<p>Forces an RP switchover to complete the upgrade.</p>

Examples

	Command or Action	Purpose
Step 17	request platform software package clean	(Optional) Removes all unused subpackage files from the router.

Examples

This example shows ISSU upgrade using subpackages on a Cisco ASR 1006 router or ASR 1013 router with a dual RP setup:

```

Router# show version
Cisco IOS Software, IOS-XE Software (X86_64_LINUX_IOSD-ADVENTERPRISEK9-M), Version 15.3(2)S,
  RELEASE SOFTWARE (fc1)
<output removed for brevity>
System image file is "bootflash:Active_Dir/packages.conf"
<output removed for brevity>
cisco ASR1013 (RP2) processor with 4208889K/6147K bytes of memory.
Processor board ID FOX1343GJGC
20 Gigabit Ethernet interfaces
6 Ten Gigabit Ethernet interfaces
32768K bytes of non-volatile configuration memory.
8388608K bytes of physical memory.
1925119K bytes of eUSB flash at bootflash:.
78085207K bytes of SATA hard disk at harddisk:Configuration register is 0x2102
Router# show platform
Chassis type: ASR1013
Slot      Type                State                Insert time (ago)
-----
2         ASR1000-SIP40       ok                   1d03h
2/0      SPA-1X10GE-L-V2     ok                   1d03h
2/1      SPA-1X10GE-L-V2     ok                   1d03h
2/2      SPA-1X10GE-L-V2     ok                   1d03h
2/3      SPA-1X10GE-L-V2     ok                   1d03h
4         ASR1000-2T+20X1GE  ok                   1d03h
4/0      BUILT-IN-2T+20X1GE ok                   1d03h
R0       ASR1000-RP2         ok, active           1d03h
R1       ASR1000-RP2         ok, standby          1d03h
F0       ASR1000-ESP100     ok, active           1d03h
F1       ASR1000-ESP100     ok, standby          1d03h
P0       ASR1013-PWR-AC     ok                   1d03h
P1       ASR1013-PWR-AC     ok                   1d03h
P2       ASR1013-PWR-AC     ok                   1d03h
P3       ASR1013-PWR-AC     ps, fail             1d03h
Slot      CPLD Version        Firmware Version
-----
2         00200800            15.3(3r)S
4         00200800            15.2(1r)S
R0       10021901            15.3(3r)S
R1       10021901            15.3(3r)S
F0       12071700            15.3(3r)S
F1       12071700            15.3(3r)S
Router# show version r0 installed
Package: Provisioning File, version: n/a, status: active
  File: bootflash:Active_Dir/packages.conf, on: RP0
  Built: n/a, by: n/a

File SHA1 checksum: a624f70f68c60292f4482433f43afd92487a55c4
Package: rpbase, version: 03.12.01.S.154-2.S, status: active
  File: bootflash:Active_Dir/asr1000rp2-rpbase.03.12.01.S.154-2.S.pkg, on: RP0
  Built: 2013-03-25_18.48, by: mcpre

```

```

File SHA1 checksum: 3a9675142898cfac350d4e42f0e37bd9f4e48538
Package: rpcontrol, version: 03.12.01.S.154-2.S, status: active
  File: bootflash:Active_Dir/asr1000rp2-rpcontrol.03.12.01.S.154-2.S.pkg, on: RP0/0
  Built: 2013-03-25_18.48, by: mcpre

File SHA1 checksum: 87b11f863f67fdf2610ee0769b929baab4c3efad
<output removed for brevity>
Router# dir bootflash:Active_Dir
Directory of bootflash:/Active_Dir/
20 -rw-    41104112   Aug 3 2013 15:05:40 +05:30
asr1000rp2-elcbase.03.12.01.S.154-2.S.pkg
21 -rw-    50285296   Aug 3 2013 15:05:40 +05:30 asr1000rp2-elcspa.03.12.01.S.154-2.S.pkg
22 -rw-    82514676   Aug 3 2013 15:05:40 +05:30
asr1000rp2-espbase.03.12.01.S.154-2.S.pkg
23 -rw-   101084628   Aug 3 2013 15:05:40 +05:30
asr1000rp2-esp86base.03.12.01.S.154-2.S.pkg
17 -rw-         9059   Aug 3 2013 15:05:40 +05:30
asr1000rp2-packages-adventerprisek9.03.12.01.S.154-2.S.conf
24 -rw-   29012724   Aug 3 2013 15:05:40 +05:30
asr1000rp2-rpaccess.03.12.01.S.154-2.S.pkg
25 -rw-   49898964   Aug 3 2013 15:05:40 +05:30 asr1000rp2-rpbase.03.12.01.S.154-2.S.pkg
26 -rw-   46557940   Aug 3 2013 15:05:40 +05:30
asr1000rp2-rpcontrol.03.12.01.S.154-2.S.pkg
27 -rw-   114612988   Aug 3 2013 15:05:41 +05:30
asr1000rp2-rpios-adventerprisek9.03.12.01.S.154-2.S.pkg
28 -rw-   41954036   Aug 3 2013 15:05:41 +05:30 asr1000rp2-sipbase.03.12.01.S.154-2.S.pkg
29 -rw-   60957428   Aug 3 2013 15:05:41 +05:30 asr1000rp2-sipsa.03.12.01.S.154-2.S.pkg
19 -rw-         9838   Aug 3 2013 15:05:41 +05:30
packages.conf
1940303872 bytes total (503164928 bytes free)
Router# show redundancy states
      my state = 13
-ACTIVE peer state = 8  -STANDBY HOT
      Mode = Duplex
      Unit = Primary
      Unit ID = 48
Redundancy Mode (Operational) = sso
Redundancy Mode (Configured) = sso
Redundancy State = sso
Maintenance Mode = Disabled
Manual Swact = enabled
Communications = Up
client count = 108
client_notification_TMR = 30000 milliseconds
RF debug mask = 0x0
Router# copy running-config startup-config
Destination filename [startup-config]?
Building configuration...
[OK]
Router# mkdir harddisk:Target_Subs
Create directory filename [Target_Subs]?
Created dir harddisk:/Target_Subs
Router# request platform software package expand file
harddisk:Target_Subs/asr1000rp2-adventerprisek9.03.13.00.S.154-3.S-ext.bin to
harddisk:Target_Subs
Verifying parameters
Validating package type
Copying package files
SUCCESS: Finished expanding all-in-one software package.
#
Router# dir harddisk:Target_Subs
Directory of harddisk:/Target_Subs/
3358722 -rw-   569597380   Aug 4 2013 18:45:38 +05:30
asr1000rp2-adventerprisek9.03.13.00.S.154-3.S-ext.bin

```

Examples

```

7684099 -rw- 37557200 Aug 4 2013 18:46:43 +05:30
asr1000rp2-elcbase.03.13.00.S.154-3.S-ext.pkg
7684100 -rw- 51194832 Aug 4 2013 18:46:43 +05:30
asr1000rp2-elcspa.03.13.00.S.154-3.S-ext.pkg
7684101 -rw- 80657364 Aug 4 2013 18:46:43 +05:30
asr1000rp2-espbase.03.13.00.S.154-3.S-ext.pkg
7684102 -rw- 95446456 Aug 4 2013 18:46:43 +05:30
asr1000rp2-esp86base.03.13.00.S.154-3.S-ext.pkg
7684097 -rw- 9381 Aug 4 2013 18:46:43 +05:30
asr1000rp2-packages-adventerprisek9.03.13.00.S.154-3.S-ext.conf
7684103 -rw- 23350232 Aug 4 2013 18:46:43 +05:30
asr1000rp2-rpaccess.03.13.00.S.154-3.S-ext.pkg
7684104 -rw- 37694900 Aug 4 2013 18:46:44 +05:30
asr1000rp2-rpbase.03.13.00.S.154-3.S-ext.pkg
7684105 -rw- 45536216 Aug 4 2013 18:46:44 +05:30
asr1000rp2-rpcontrol.03.13.00.S.154-3.S-ext.pkg
7684106 -rw- 118754284 Aug 4 2013 18:46:44 +05:30
asr1000rp2-rpios-adventerprisek9.03.13.00.S.154-3.S-ext.pkg
7684107 -rw- 38380500 Aug 4 2013 18:46:44 +05:30
asr1000rp2-sipbase.03.13.00.S.154-3.S-ext.pkg
7684108 -rw- 61760468 Aug 4 2013 18:46:44 +05:30
asr1000rp2-sipspa.03.13.00.S.154-3.S-ext.pkg
7684098 -rw- 10165 Aug 4 2013 18:46:44 +05:30
packages.conf
78704144384 bytes total (9254879232 bytes free)
Router# copy harddisk:Target_Subs/asr1000rp2-espbase.03.13.00.S.154-3.S-ext.pkg bootflash:
Destination filename [Active_Dir/asr1000rp2-espbase.03.13.00.S.154-3.S-ext.pkg]?
Copy in
progress...CCCCC
80657364 bytes copied in 11.951 secs (6749005 bytes/sec)
Router# copy harddisk:Target_Subs/asr1000rp2-esp86base.03.13.00.S.154-3.S-ext.pkg bootflash:
Destination filename [Active_Dir/asr1000rp2-esp86base.03.13.00.S.154-3.S-ext.pkg]?
Copy in
progress...CCCC
95446456 bytes copied in 14.213 secs (6715433 bytes/sec)
Router# copy harddisk:Target_Subs/asr1000rp2-rpaccess.03.13.00.S.154-3.S-ext.pkg bootflash:
Destination filename [Active_Dir/asr1000rp2-rpaccess.03.13.00.S.154-3.S-ext.pkg]?
Copy in
progress...CCCCC
23350232 bytes copied in 3.441 secs (6785885 bytes/sec)
Router# copy harddisk:Target_Subs/asr1000rp2-rpbase.03.13.00.S.154-3.S-ext.pkg bootflash:
Destination filename [Active_Dir/asr1000rp2-rpbase.03.13.00.S.154-3.S-ext.pkg]?
Copy in
progress...CCCC
37694900 bytes copied in 5.598 secs (6733637 bytes/sec)
Router# copy harddisk:Target_Subs/asr1000rp2-rpcontrol.03.13.00.S.154-3.S-ext.pkg bootflash:
Destination filename [Active_Dir/asr1000rp2-rpcontrol.03.13.00.S.154-3.S-ext.pkg]?
Copy in
progress...CCCC
45536216 bytes copied in 6.797 secs (6699458 bytes/sec)
Router# copy harddisk:Target_Subs/asr1000rp2-rpios-adventerprisek9.03.13.00.S.154-3.S-ext.pkg
bootflash:
Destination filename
[Active_Dir/asr1000rp2-rpios-adventerprisek9.03.13.00.S.154-3.S-ext.pkg]?
Copy in
progress...CCCCC
118754284 bytes copied in 17.798 secs (6672339 bytes/sec)
Router# copy harddisk:Target_Subs/asr1000rp2-sipbase.03.13.00.S.154-3.S-ext.pkg bootflash:
Destination filename [Active_Dir/asr1000rp2-sipbase.03.13.00.S.154-3.S-ext.pkg]?
Copy in
progress...CCCC
38380500 bytes copied in 5.962 secs (6437521 bytes/sec)
Router# copy harddisk:Target_Subs/asr1000rp2-sipspa.03.13.00.S.154-3.S-ext.pkg bootflash:
Destination filename [Active_Dir/asr1000rp2-sipspa.03.13.00.S.154-3.S-ext.pkg]?

```

```

Copy in
progress...CCCCCC
61760468 bytes copied in 9.408 secs (6564676 bytes/sec)
Router# copy harddisk:Target_Sub/Target_Sub/asr1000rp2-elcbase.03.13.00.S.154-3.S-ext.pkg bootflash:
Destination filename [Active_Dir/asr1000rp2-elcbase.03.13.00.S.154-3.S-ext.pkg]?
Copy in
progress...CCCC
37557200 bytes copied in 5.650 secs (6647292 bytes/sec)
Router# copy
harddisk:Target_Sub/Target_Sub/asr1000rp2-elcspa.03.13.00.S.154-3.S-ext.pkg bootflash:
Destination filename [Active_Dir/asr1000rp2-elcspa.03.13.00.S.154-3.S-ext.pkg]?
Copy in
progress...CCCC
51194832 bytes copied in 7.397 secs (6921026 bytes/sec)
#
Router# copy harddisk:Target_Sub/Target_Sub/asr1000rp2-espbase.03.13.00.S.154-3.S-ext.pkg
stby-bootflash:
Destination filename [Active_Dir/asr1000rp2-espbase.03.13.00.S.154-3.S-ext.pkg]?
Copy in
progress...CCCC
80657364 bytes copied in 132.765 secs (607520 bytes/sec)
Router# copy
harddisk:Target_Sub/Target_Sub/asr1000rp2-esp86base.03.13.00.S.154-3.S-ext.pkg stby-bootflash:
Destination filename [Active_Dir/asr1000rp2-esp86base.03.13.00.S.154-3.S-ext.pkg]?
Copy in
progress...CCCC
95446456 bytes copied in 177.587 secs (537463 bytes/sec)
Router# copy harddisk:Target_Sub/Target_Sub/asr1000rp2-rpaccess.03.13.00.S.154-3.S-ext.pkg
stby-bootflash:
Destination filename [Active_Dir/asr1000rp2-rpaccess.03.13.00.S.154-3.S-ext.pkg]?
Copy in
progress...CCCC
23350232 bytes copied in 55.396 secs (421515 bytes/sec)
Router# copy harddisk:Target_Sub/Target_Sub/asr1000rp2-rpbase.03.13.00.S.154-3.S-ext.pkg stby-bootflash:
Destination filename [Active_Dir/asr1000rp2-rpbase.03.13.00.S.154-3.S-ext.pkg]?
Copy in
progress...CCCC
37694900 bytes copied in 86.199 secs (437301 bytes/sec)
Router# copy harddisk:Target_Sub/Target_Sub/asr1000rp2-rpcontrol.03.13.00.S.154-3.S-ext.pkg
stby-bootflash:
Destination filename [Active_Dir/asr1000rp2-rpcontrol.03.13.00.S.154-3.S-ext.pkg]?
Copy in
progress...CCCC
45536216 bytes copied in 101.527 secs (448513 bytes/sec)
Router# copy harddisk:Target_Sub/Target_Sub/asr1000rp2-rpios-adventerprisek9.03.13.00.S.154-3.S-ext.pkg
stby-bootflash:
Destination filename
[Active_Dir/asr1000rp2-rpios-adventerprisek9.03.13.00.S.154-3.S-ext.pkg]?
Copy in
progress...CCCC
118754284 bytes copied in 212.646 secs (558460 bytes/sec)
Router# copy harddisk:Target_Sub/Target_Sub/asr1000rp2-sipbase.03.13.00.S.154-3.S-ext.pkg
stby-bootflash:
Destination filename [Active_Dir/asr1000rp2-sipbase.03.13.00.S.154-3.S-ext.pkg]?
Copy in
progress...CCCC
38380500 bytes copied in 83.162 secs (461515 bytes/sec)
Router# copy harddisk:Target_Sub/Target_Sub/asr1000rp2-sipspa.03.13.00.S.154-3.S-ext.pkg stby-bootflash:
Destination filename [Active_Dir/asr1000rp2-sipspa.03.13.00.S.154-3.S-ext.pkg]?
Copy in
progress...CCCC
61760468 bytes copied in 119.391 secs (517296 bytes/sec)
#
Router# copy harddisk:Target_Sub/Target_Sub/asr1000rp2-elcbase.03.13.00.S.154-3.S-ext.pkg

```

```

stby-bootflash:
Destination filename [Active_Dir/asr1000rp2-elcbase.03.13.00.S.154-3.S-ext.pkg]?
Copy in
progress...CCCCC
37557200 bytes copied in 57.106 secs (657675 bytes/sec)
Router# copy harddisk:Target_Sub/asr1000rp2-elcspa.03.13.00.S.154-3.S-ext.pkg stby-bootflash:
Destination filename [Active_Dir/asr1000rp2-elcspa.03.13.00.S.154-3.S-
ext.pkg]?
Copy in
progress...CCCC
51194832 bytes copied in 87.453 secs (585398 bytes/sec)
Router# request platform software package install rp 1 file
stby-bootflash:Active_Dir/asr1000rp*03.13.00.S.154-3.S-ext*.pkg force
--- Starting local lock acquisition on R0 ---
Finished local lock acquisition on R0
--- Starting installation state synchronization ---
Finished installation state synchronization
--- Starting local lock acquisition on R1 ---
Finished local lock acquisition on R1
--- Starting file path checking ---
Finished file path checking
--- Starting image file verification ---
Checking image file names
Locating image files and validating name syntax
  Found asr1000rp2-elcbase.03.13.00.S.154-3.S-ext.pkg
  Found asr1000rp2-elcspa.03.13.00.S.154-3.S-ext.pkg
  Found asr1000rp2-espbase.03.13.00.S.154-3.S-ext.pkg
  Found asr1000rp2-esp86base.03.13.00.S.154-3.S-ext.pkg
  Found asr1000rp2-rpaccess.03.13.00.S.154-3.S-ext.pkg
  Found asr1000rp2-rpbase.03.13.00.S.154-3.S-ext.pkg
  Found asr1000rp2-rpcontrol.03.13.00.S.154-3.S-ext.pkg
  Found asr1000rp2-rpios-adventerprisek9.03.13.00.S.154-3.S-ext.pkg
  Found asr1000rp2-sipbase.03.13.00.S.154-3.S-ext.pkg
  Found asr1000rp2-sipspa.03.13.00.S.154-3.S-ext.pkg
Verifying image file locations
Inspecting image file types
  WARNING: In-service installation of IOSD package
  WARNING: requires software redundancy on target RP
  WARNING: or on-reboot parameter
  WARNING: Automatically setting the on-reboot flag
  WARNING: In-service installation of RP Base package
  WARNING: requires software reboot of target RP
Processing image file constraints
Creating candidate provisioning file
Finished image file verification
--- Starting candidate package set construction ---
Verifying existing software set
Processing candidate provisioning file
Constructing working set for candidate package set
Constructing working set for running package set
Checking command output
Constructing merge of running and candidate packages
Checking if resulting candidate package set would be complete
Finished candidate package set construction
--- Starting compatibility testing ---
Determining whether candidate package set is compatible
Determining whether installation is valid
Determining whether installation is valid ... skipped
Verifying image type compatibility
Checking IPC compatibility for candidate software
Checking candidate package set infrastructure compatibility
Checking infrastructure compatibility with running software
Checking infrastructure compatibility with running software ... skipped
Checking package specific compatibility

```



```

Finished compatibility testing
--- Starting list of software package changes ---
Old files list:
  Removed asr1000rp2-elcbase.03.12.01.S.154-2.S.pkg
  Removed asr1000rp2-elcspa.03.12.01.S.154-2.S.pkg
  Removed asr1000rp2-espbase.03.12.01.S.154-2.S.pkg
  Removed asr1000rp2-esp86base.03.12.01.S.154-2.S.pkg
  Removed asr1000rp2-rpaccess.03.12.01.S.154-2.S.pkg
  Removed asr1000rp2-rpbase.03.12.01.S.154-2.S.pkg
  Removed asr1000rp2-rpcontrol.03.12.01.S.154-2.S.pkg
  Removed asr1000rp2-rpios-adventerprisek9.03.12.01.S.154-2.S.pkg
  Removed asr1000rp2-sipbase.03.12.01.S.154-2.S.pkg
  Removed asr1000rp2-sipspsa.03.12.01.S.154-2.S.pkg
New files list:
  Added asr1000rp2-elcbase.03.13.00.S.154-3.S-ext.pkg
  Added asr1000rp2-elcspa.03.13.00.S.154-3.S-ext.pkg
  Added asr1000rp2-espbase.03.13.00.S.154-3.S-ext.pkg
  Added asr1000rp2-esp86base.03.13.00.S.154-3.S-ext.pkg
  Added asr1000rp2-rpaccess.03.13.00.S.154-3.S-ext.pkg
  Added asr1000rp2-rpbase.03.13.00.S.154-3.S-ext.pkg
  Added asr1000rp2-rpcontrol.03.13.00.S.154-3.S-ext.pkg
  Added asr1000rp2-rpios-adventerprisek9.03.13.00.S.154-3.S-ext.pkg
  Added asr1000rp2-sipbase.03.13.00.S.154-3.S-ext.pkg
  Added asr1000rp2-sipspsa.03.13.00.S.154-3.S-ext.pkg
Finished list of software package changes
--- Starting commit of software changes ---
Updating provisioning rollback files
Creating pending provisioning file
Committing provisioning file
Finished commit of software changes
SUCCESS: Software provisioned. New software will load on reboot.
Router# hw-module slot r1 reload
Proceed with reload of module? [confirm]Y
*Aug 4 19:14:01.721 IST: %IOSXE_OIR-6-OFFLINECARD: Card (rp) offline in slot R1
*Aug 4 19:14:01.761 IST: %REDUNDANCY-3-STANDBY_LOST: Standby processor fault
(PEER_NOT_PRESENT)
*Aug 4 19:14:01.761 IST: %REDUNDANCY-3-STANDBY_LOST: Standby processor fault (PEER_DOWN)
*Aug 4 19:14:01.761 IST: %REDUNDANCY-3-STANDBY_LOST: Standby processor fault
(PEER_REDUNDANCY_STATE_CHANGE)
*Aug 4 19:14:03.584 IST: %RF-5-RF_RELOAD: Peer reload. Reason: EHSA standby down
*Aug 4 19:14:03.594 IST: % Redundancy mode change to SSO
*Aug 4 19:17:35.443 IST: %IOSXE_OIR-6-ONLINECARD: Card (rp) online in slot R1
*Aug 4 19:17:48.061 IST: %REDUNDANCY-5-PEER_MONITOR_EVENT: Active detected a standby
insertion (raw-event=PEER_FOUND(4))
*Aug 4 19:17:48.061 IST: %REDUNDANCY-5-PEER_MONITOR_EVENT: Active detected a standby
insertion (raw-event=PEER_REDUNDANCY_STATE_CHANGE(5))
*Aug 4 19:17:51.003 IST: %REDUNDANCY-3-IPC: IOS versions do not match.
*Aug 4 19:19:08.380 IST: %NBAR_HA-5-NBAR_INFO: NBAR sync DONE!
*Aug 4 19:19:08.797 IST: %HA_CONFIG_SYNC-6-BULK_CFGSYNC_SUCCEEDED: Bulk Sync succeeded
*Aug 4 19:19:08.798 IST: %RF-5-RF_TERMINAL_STATE: Terminal state reached for (SSO)
Router# request platform software package install rp 0 file
bootflash:Active_Dir/asr1000rp2-{sipbase,sipspsa}*03.13.00.S.154-3.S-ext*.pkg slot 2 force
--- Starting local lock acquisition on R0 ---
Finished local lock acquisition on R0
--- Starting installation state synchronization ---
Finished installation state synchronization
--- Starting file path checking ---
Finished file path checking
--- Starting image file verification ---
Checking image file names
Locating image files and validating name syntax
  Found asr1000rp2-sipbase.03.13.00.S.154-3.S-ext.pkg
  Found asr1000rp2-sipspsa.03.13.00.S.154-3.S-ext.pkg
Verifying image file locations

```

```

Inspecting image file types
Processing image file constraints
Creating candidate provisioning file
Finished image file verification
--- Starting candidate package set construction ---
Verifying existing software set
Processing candidate provisioning file
Constructing working set for candidate package set
Constructing working set for running package set
Checking command output
Constructing merge of running and candidate packages
Checking if resulting candidate package set would be complete
Finished candidate package set construction
--- Starting compatibility testing ---
Determining whether candidate package set is compatible
WARNING: Candidate software combination not found in compatibility database
WARNING: Determining whether installation is valid
Creating matrix_file by locate_latest_matrix_file /tmp/issu/provision/sw
WARNING: Candidate software combination not found in compatibility database
WARNING: Candidate software combination not found in compatibility database
WARNING: Software sets are identified as compatible
Verifying image type compatibility
Checking IPC compatibility with running software
Checking candidate package set infrastructure compatibility
Checking infrastructure compatibility with running software
Checking package specific compatibility
Finished compatibility testing
--- Starting impact testing ---
Checking operational impact of change
Finished impact testing
--- Starting list of software package changes ---
No old package files removed
New files list:
  Added asr1000rp2-sipbase.03.13.00.S.154-3.S-ext.pkg
  Added asr1000rp2-sipspa.03.13.00.S.154-3.S-ext.pkg
Finished list of software package changes
--- Starting commit of software changes ---
Updating provisioning rollback files
Creating pending provisioning file
Committing provisioning file
Finished commit of software changes
--- Starting analysis of software changes ---
Finished analysis of software changes
--- Starting update running software ---
Blocking peer synchronization of operating information
Creating the command set placeholder directory
  Finding latest command set
  Finding latest command shortlist lookup file
  Finding latest command shortlist file
  Assembling CLI output libraries
  Assembling CLI input libraries
  Assembling Dynamic configuration files
  Applying interim IPC and database definitions
  Replacing running software
  Replacing CLI software
  Restarting software
  Generating software version information
  Notifying running software of updates
  Unblocking peer synchronization of operating information
Unmounting old packages
Cleaning temporary installation files
  Finished update running software

SUCCESS: Finished installing software.

```

```

*Aug 4 19:21:45.424 IST:
%IOSXE_OIR-6-ONLINECARD: Card (cc) online in slot 2
*Aug 4 19:21:48.382 IST: %IOSXE_OIR-6-INSSPA: SPA inserted in subslot 2/0
*Aug 4 19:21:48.733 IST: %IOSXE_OIR-6-INSSPA: SPA inserted in subslot 2/1
*Aug 4 19:21:49.083 IST: %IOSXE_OIR-6-INSSPA: SPA inserted in subslot 2/2
*Aug 4 19:21:49.430 IST: %IOSXE_OIR-6-INSSPA: SPA inserted in subslot 2/3
*Aug 4 19:21:58.121 IST: %LINK-3-UPDOWN: SIP2/0: Interface EOBC2/1, changed state to up
*Aug 4 19:22:02.302 IST: %SPA_OIR-6-ONLINECARD: SPA (SPA-1X10GE-L-V2) online in subslot
2/0
*Aug 4 19:22:02.282 IST: %TRANSCEIVER-6-INSERTED: SIP2/0: transceiver module inserted in
TenGigabitEthernet2/0/0
*Aug 4 19:22:02.518 IST: %LINK-3-UPDOWN: SIP2/1: Interface EOBC2/1, changed state to up
*Aug 4 19:22:06.113 IST: %SPA_OIR-6-ONLINECARD: SPA (SPA-1X10GE-L-V2) online in subslot
2/1
*Aug 4 19:22:06.082 IST: %TRANSCEIVER-6-INSERTED: SIP2/1: transceiver module inserted in
TenGigabitEthernet2/1/0
*Aug 4 19:22:08.080 IST: %LINK-3-UPDOWN: SIP2/2: Interface EOBC2/1, changed state to up
*Aug 4 19:22:11.627 IST: %SPA_OIR-6-ONLINECARD: SPA (SPA-1X10GE-L-V2) online in subslot
2/2
*Aug 4 19:22:11.616 IST: %TRANSCEIVER-6-INSERTED: SIP2/2: transceiver module inserted in
TenGigabitEthernet2/2/0
*Aug 4 19:22:12.523 IST: %LINK-3-UPDOWN: SIP2/3: Interface EOBC2/1, changed state to up
*Aug 4 19:22:16.657 IST: %SPA_OIR-6-ONLINECARD: SPA (SPA-1X10GE-L-V2) online in subslot
2/3
*Aug 4 19:22:16.648 IST: %TRANSCEIVER-6-INSERTED: SIP2/3: transceiver module inserted in
TenGigabitEthernet2/3/0
Router# issu commitversion
--- Starting local lock acquisition on R0 ---
Finished local lock acquisition on R0
--- Starting installation changes ---
Cancelling rollback timer
Finished installation changes
SUCCESS: Installation changes committed
Router# request platform software package install rp 0 file
bootflash:Active_Dir/asr1000rp2-{elcbase,elcspa}*03.13.00.S.154-3.S-ext*.pkg slot 4
--- Starting local lock acquisition on R0 ---
Finished local lock acquisition on R0
--- Starting installation state synchronization ---
Finished installation state synchronization
--- Starting file path checking ---
Finished file path checking
--- Starting image file verification ---
Checking image file names
Locating image files and validating name syntax
  Found asr1000rp2-elcbase.03.13.00.S.154-3.S-ext.pkg
  Found asr1000rp2-elcspa.03.13.00.S.154-3.S-ext.pkg
Verifying image file locations
Inspecting image file types
Processing image file constraints
Creating candidate provisioning file
Finished image file verification
--- Starting candidate package set construction ---
Verifying existing software set
Processing candidate provisioning file
Constructing working set for candidate package set
Constructing working set for running package set
Checking command output Constructing merge of running and candidate packages
Checking if resulting candidate package set would be complete
Finished candidate package set construction
--- Starting compatibility testing ---
Determining whether candidate package set is compatible
WARNING:Candidate software combination not found in compatibility database
WARNING:Determining whether installation is valid
Creating matrix_file by locate_latest_matrix_file /tmp/issu/provision/sw

```

```

WARNING:Candidate software combination not found in compatibility database
WARNING:Candidate software combination not found in compatibility database
WARNING:Software sets are identified as compatible
Verifying image type compatibility
Checking IPC compatibility with running software
Checking candidate package set infrastructure compatibility
Checking infrastructure compatibility with running software
Checking package specific compatibility
Finished compatibility testing
--- Starting impact testing ---
Checking operational impact of change
Finished impact testing
--- Starting list of software package changes ---
No old package files removed
New files list:
  Added asr1000rp2-elcbase.03.13.00.S.154-3.S-ext.pkg
  Added asr1000rp2-elcspa.03.13.00.S.154-3.S-ext.pkg
Finished list of software package changes
--- Starting commit of software changes ---
Updating provisioning rollback files
Creating pending provisioning file
Committing provisioning file
Finished commit of software changes
--- Starting analysis of software changes ---
Finished analysis of software changes
--- Starting update running software ---
Blocking peer synchronization of operating information
Creating the command set placeholder directory
  Finding latest command set
  Finding latest command shortlist lookup file
  Finding latest command shortlist file
  Assembling CLI output libraries
  Assembling CLI input libraries
  Assembling Dynamic configuration files
  Applying interim IPC and database definitions
  Replacing running software
  Replacing CLI software
  Restarting software
  Applying final IPC and database definitions
  Generating software version information
  Notifying running software of updates
  Unblocking peer synchronization of operating information
Unmounting old packages
Cleaning temporary installation files
  Finished update running software

SUCCESS: Finished installing software.
Router# issu commitversion
Starting local lock acquisition on R0 ---
Finished local lock acquisition on R0
--- Starting installation changes ---
Cancelling rollback timer
Finished installation changes
SUCCESS: Installation changes committed
Router# request platform software package install rp 0 file
bootflash:Active_Dir/asr1000rp2-esp*03.13.00.S.154-3.S-ext*.pkg slot 1
--- Starting local lock acquisition on R0 ---
Finished local lock acquisition on R0
--- Starting installation state synchronization---
Finished installation state synchronization
--- Starting file path checking ---
Finished file path checking
--- Starting image file verification ---
Checking image file names

```

```

Locating image files and validating name syntax
  Found asr1000rp2-espbase.03.13.00.S.154-3.S-ext.pkg
  Found asr1000rp2-esp86base.03.13.00.S.154-3.S-ext.pkg
Verifying image file locations
Inspecting image file types
Processing image file constraints
Creating candidate provisioning file
Finished image file verification
--- Starting candidate package set construction ---
Verifying existing software set
Processing candidate provisioning file
Constructing working set for candidate package set
Constructing working set for running package set
Checking command output
Constructing merge of running and candidate packages
Checking if resulting candidate package set would be complete
Finished candidate package set construction
--- Starting compatibility testing ---
Determining whether candidate package set is compatible
WARNING:Candidate software combination not found in compatibility database
WARNING:Determining whether installation is valid
Creating matrix_file by locate_latest_matrix_file /tmp/issu/provision/sw
WARNING:Candidate software combination not found in compatibility database
WARNING:Candidate software combination not found in compatibility database
WARNING:Software sets are identified as compatible
Verifying image type compatibility
Checking IPC compatibility with running software
Checking candidate package set infrastructure compatibility
Checking infrastructure compatibility with running software
Checking package specific compatibility
Finished compatibility testing
--- Starting impact testing ---
Checking operational impact of change
Finished impact testing
--- Starting list of software package changes ---
No old package files removed
New files list:
  Added asr1000rp2-espbase.03.13.00.S.154-3.S-ext.pkg
  Added asr1000rp2-esp86base.03.13.00.S.154-3.S-ext.pkg
Finished list of software package changes
--- Starting commit of software changes ---
Updating provisioning rollback files
Creating pending provisioning file
Committing provisioning file
Finished commit of software changes
--- Starting analysis of software changes ---
Finished analysis of software changes
--- Starting update running software ---
Blocking peer synchronization of operating information
Creating the command set placeholder directory
  Finding latest command set
  Finding latest command shortlist lookup file
  Finding latest command shortlist file
  Assembling CLI output libraries
  Assembling CLI input libraries
  Assembling Dynamic configuration files
  Applying interim IPC and database definitions
  Replacing running software
  Replacing CLI software
  Restarting software
  Restarting ESP1
  Applying final IPC and database definitions
*Aug 4 19:29:16.751 IST: %IOSXE_OIR-6-OFFLINECARD: Card (fp) offline in slot F1
*Aug 4 19:29:18.172 IST: %CMRP-6-FP_HA_STATUS: R0/0: cmand: F0 redundancy state is Active

```

```

with no Standby
Generating software version information
Notifying running software of updates
  Unblocking peer synchronization of operating information
Unmounting old packages
Cleaning temporary installation files
  Finished update running software

SUCCESS: Finished installing software.
*Aug  4 19:30:50.972 IST: %CPPHA-7-START: F1: cpp_ha: CPP 0 preparing image
/tmp/sw/fp/1/0/fpx86/mount/usr/cpp/bin/qfp-ucode-esp40
*Aug  4 19:30:51.362 IST: %CPPHA-7-START: F1: cpp_ha: CPP 0 startup init image
/tmp/sw/fp/1/0/fpx86/mount/usr/cpp/bin/qfp-ucode-esp40
*Aug  4 19:30:53.088 IST: %IOSXE_OIR-6-ONLINECARD: Card (fp) online in slot F1
Router# issu commitversion
--- Starting local lock acquisition on R0 ---
Finished local lock acquisition on R0
--- Starting installation changes ---
Cancelling rollback timer
Finished installation changes
SUCCESS: Installation changes committed
Router# request platform software package install rp 0 file
bootflash:Active_Dir/asr1000rp2-esp*03.13.00.S.154-3.S-ext*.pkg slot 0
--- Starting local lock acquisition on R0 ---
Finished local lock acquisition on R0
--- Starting installation state synchronization ---
Finished installation state synchronization
--- Starting file path checking ---
Finished file path checking
--- Starting image file verification ---
Checking image file names
Locating image files and validating name syntax
  Found asr1000rp2-espbase.03.13.00.S.154-3.S-ext.pkg
  Found asr1000rp2-esp86base.03.13.00.S.154-3.S-ext.pkg
Verifying image file locations
Inspecting image file types
Processing image file constraints
Creating candidate provisioning file
*Aug  4 19:31:14.730 IST: %CPPHA-7-START: F1: cpp_ha: CPP 0 running init image
/tmp/sw/fp/1/0/fpx86/mount/usr/cpp/bin/qfp-ucode-esp40
*Aug  4 19:31:15.079 IST: %CPPHA-7-READY: F1: cpp_ha: CPP 0 loading and initialization
completeFinished image file verification
--- Starting candidate package set construction ---
Verifying existing software set
*Aug  4 19:31:15.309 IST: %IOSXE-6-PLATFORM: F1: cpp_cp: Process
CPP_FILTER_EA_EVENT_API_CALL_REGISTERProcessing candidate provisioning file
*Aug  4 19:31:18.010 IST: %CMRP-6-FP_HA_STATUS: R0/0: cmand: F0 redundancy state is Active
  with ready StandbyConstructing working set for candidate package set
Constructing working set for running package set
Checking command output
Constructing merge of running and candidate packages
Checking if resulting candidate package set would be complete
Finished candidate package set construction
--- Starting compatibility testing ---
Determining whether candidate package set is compatible
WARNING:Candidate software combination not found in compatibility database
WARNING:Determining whether installation is valid
Creating matrix_file by locate_latest_matrix_file /tmp/issu/provision/sw
Software sets are identified as compatible
Verifying image type compatibility
Checking IPC compatibility with running software
Checking candidate package set infrastructure compatibility
Checking infrastructure compatibility with running software
Checking package specific compatibility

```

```

Finished compatibility testing
--- Starting impact testing ---
Checking operational impact of change
Finished impact testing
--- Starting list of software package changes ---
Old files list:
  Removed asr1000rp2-espbase.03.12.01.S.154-2.S.pkg
  Removed asr1000rp2-esp86base.03.12.01.S.154-2.S.pkg
No new package files added
Finished list of software package changes
--- Starting commit of software changes ---
Updating provisioning rollback files
Creating pending provisioning file
Committing provisioning file
Finished commit of software changes
--- Starting analysis of software changes ---
Finished analysis of software changes
--- Starting update running software ---
Blocking peer synchronization of operating information
Creating the command set placeholder directory
  Finding latest command set
  Finding latest command shortlist lookup file
  Finding latest command shortlist file
  Assembling CLI output libraries
  Assembling CLI input libraries
  Assembling Dynamic configuration files
  Applying interim IPC and database definitions
  Replacing running software
  Replacing CLI software
  Restarting software
  Restarting ESPO
  Applying final IPC and database definitions
*Aug  4 19:32:46.187 IST: %IOSXE_OIR-6-OFFLINECARD: Card (fp) offline in slot F0
*Aug  4 19:32:46.539 IST: %CMRP-6-FP_HA_STATUS: R0/0: cmand: F1 redundancy state is Active

Generating software version information
  Notifying running software of updates
  Unblocking peer synchronization of operating information
Unmounting old packages
Cleaning temporary installation files
  Finished update running software

SUCCESS: Finished installing software.
*Aug  4 19:34:19.748 IST: %CPPHA-7-START: F0: cpp_ha: CPP 0 preparing image
/tmp/sw/fp/0/0/fpx86/mount/usr/cpp/bin/qfp-ucode-esp40
*Aug  4 19:34:20.139 IST: %CPPHA-7-START: F0: cpp_ha: CPP 0 startup init image
/tmp/sw/fp/0/0/fpx86/mount/usr/cpp/bin/qfp-ucode-esp40
*Aug  4 19:34:21.858 IST: %IOSXE_OIR-6-ONLINECARD: Card (fp) online in slot F0
*Aug  4 19:34:43.609 IST: %CPPHA-7-START: F0: cpp_ha: CPP 0 running init image
/tmp/sw/fp/0/0/fpx86/mount/usr/cpp/bin/qfp-ucode-esp40
*Aug  4 19:34:43.958 IST: %CPPHA-7-READY: F0: cpp_ha: CPP 0 loading and initialization
complete
*Aug  4 19:34:44.190 IST: %IOSXE-6-PLATFORM: F0: cpp_cp: Process
CPP_FILTER_EA_EVENT_API_CALL_REGISTER
*Aug  4 19:34:46.890 IST: %CMRP-6-FP_HA_STATUS: R0/0: cmand: F0 redundancy state is Standby
Router# show platform
Chassis type: ASR1013
Slot      Type              State              Insert time (ago)
-----
  2        ASR1000-SIP40      ok                 1d04h
  2/0      SPA-1X10GE-L-V2    ok                 1d04h
  2/1      SPA-1X10GE-L-V2    ok                 1d04h
  2/2      SPA-1X10GE-L-V2    ok                 1d04h
  2/3      SPA-1X10GE-L-V2    ok                 1d04h

```

Examples

```

4          ASR1000-2T+20X1GE  ok          1d04h
4/0       BUILT-IN-2T+20X1GE  ok          1d04h
R0        ASR1000-RP2         ok, active  1d04h
R1        ASR1000-RP2         ok, standby 1d04h
F0        ASR1000-ESP100     ok, standby 1d04h
F1        ASR1000-ESP100     ok, active  1d04h
P0        ASR1013-PWR-AC     ok          1d04h
P1        ASR1013-PWR-AC     ok          1d04h
P2        ASR1013-PWR-AC     ok          1d04h
P3        ASR1013-PWR-AC     ps, fail    1d04h
Slot      CPLD Version        Firmware Version
-----

```

```

2          00200800          15.3(3r)S
4          00200800          15.2(1r)S
R0        10021901          15.3(3r)S
R1        10021901          15.3(3r)S
F0        12071700          15.3(3r)S
F1        12071700          15.3(3r)S

```

Router# **issu commitversion**

Starting local lock acquisition on R0 ---

Finished local lock acquisition on R0

--- Starting installation changes ---

Cancelling rollback timer

Finished installation changes

SUCCESS: Installation changes committed

Router# **request platform software package install rp 0 file**

bootflash:Active_Dir/asr1000rp2*03.13.00.S.154-3.S-ext*.pkg force

--- Starting local lock acquisition on R0 ---

Finished local lock acquisition on R0

--- Starting installation state synchronization ---

Finished installation state synchronization

--- Starting file path checking ---

Finished file path checking

--- Starting image file verification ---

Checking image file names

Locating image files and validating name syntax

Found asr1000rp2-elcbase.03.13.00.S.154-3.S-ext.pkg

Found asr1000rp2-elcspa.03.13.00.S.154-3.S-ext.pkg

Found asr1000rp2-espbase.03.13.00.S.154-3.S-ext.pkg

Found asr1000rp2-esp86base.03.13.00.S.154-3.S-ext.pkg

Found asr1000rp2-rpaccess.03.13.00.S.154-3.S-ext.pkg

Found asr1000rp2-rpbase.03.13.00.S.154-3.S-ext.pkg

Found asr1000rp2-rpcontrol.03.13.00.S.154-3.S-ext.pkg

Found asr1000rp2-rpios-adventerprisek9.03.13.00.S.154-3.S-ext.pkg

Found asr1000rp2-sipbase.03.13.00.S.154-3.S-ext.pkg

Found asr1000rp2-sipspa.03.13.00.S.154-3.S-ext.pkg

Verifying image file locations

Inspecting image file types

WARNING: In-service installation of IOSD package

WARNING: requires software redundancy on target RP

WARNING: or on-reboot parameter

WARNING: Automatically setting the on-reboot flag

WARNING: In-service installation of RP Base package

WARNING: requires software reboot of target RP

Processing image file constraints

Creating candidate provisioning file

Finished image file verification

--- Starting candidate package set construction ---

Verifying existing software set

Processing candidate provisioning file

Constructing working set for candidate package set

Constructing working set for running package set

Checking command output

```

Constructing merge of running and candidate packages
Checking if resulting candidate package set would be complete
Finished candidate package set construction
--- Starting compatibility testing ---
Determining whether candidate package set is compatible
Determining whether installation is valid
Determining whether installation is valid ... skipped
Verifying image type compatibility
Checking IPC compatibility for candidate software
Checking candidate package set infrastructure compatibility
Checking infrastructure compatibility with running software
Checking infrastructure compatibility with running software ... skipped
Checking package specific compatibility
Finished compatibility testing
--- Starting list of software package changes ---
Old files list:
  Removed asr1000rp2-elcbase.03.12.01.S.154-2.S.pkg
  Removed asr1000rp2-elcspa.03.12.01.S.154-2.S.pkg
  Removed asr1000rp2-rpaccess.03.12.01.S.154-2.S.pkg
  Removed asr1000rp2-rpbase.03.12.01.S.154-2.S.pkg
  Removed asr1000rp2-rpcontrol.03.12.01.S.154-2.S.pkg
  Removed asr1000rp2-rpios-adventerprisek9.03.12.01.S.154-2.S.pkg
  Removed asr1000rp2-sipbase.03.12.01.S.154-2.S.pkg
  Removed asr1000rp2-sipspa.03.12.01.S.154-2.S.pkg
New files list:
  Added asr1000rp2-rpaccess.03.13.00.S.154-3.S-ext.pkg
  Added asr1000rp2-rpbase.03.13.00.S.154-3.S-ext.pkg
  Added asr1000rp2-rpcontrol.03.13.00.S.154-3.S-ext.pkg
  Added asr1000rp2-rpios-adventerprisek9.03.13.00.S.154-3.S-ext.pkg
Finished list of software package changes
--- Starting commit of software changes ---
Updating provisioning rollback files
Creating pending provisioning file
Committing provisioning file
Finished commit of software changes
SUCCESS: Software provisioned. New
software will load on reboot.
Router# show version R0 provisioned
Package: Provisioning File, version: n/a, status: active
  File: bootflash:Active_Dir/packages.conf, on: RP0
  Built: n/a, by: n/a
  File SHA1 checksum: c79075780592aec1312725f4a2357a034fda2d3b
Package: rpbase, version: 03.13.00.S.154-3.S-ext, status: n/a
  File: bootflash:Active_Dir/asr1000rp2-rpbase.03.13.00.S.154-3.S-ext.pkg, on: RP0
  Built: 2013-07-25_22.55, by: mcpre
  File SHA1 checksum: 4f655c54bb95b4dfa24a0d25ebf97cf8527c69e9
Package: rpcontrol, version: 03.13.00.S.154-3.S-ext, status: n/a
  File: bootflash:Active_Dir/asr1000rp2-rpcontrol.03.13.00.S.154-3.S-ext.pkg, on: RP0/0
  Built: 2013-07-25_22.55, by: mcpre
  File SHA1 checksum: 8a0a45ea5c7a656c0eef6726174461584f182c78
Package: rpios-adventerprisek9, version: 03.13.00.S.154-3.S-ext, status: n/a
  File: bootflash:Active_Dir/asr1000rp2-rpios-adventerprisek9.03.13.00.S.154-3.S-ext.pkg,
on: RP0/0Built: 2013-07-25_23.00, by: mcpre
  File SHA1 checksum: 85e9eab826bff2194ef568a56c76453625383ad2
  File SHA1 checksum: 94763274fc807489410e299a45fd73fce9d67499
Package: sipbase, version: 03.13.00.S.154-3.S-ext, status: n/a
  File: bootflash:Active_Dir/asr1000rp2-sipbase.03.13.00.S.154-3.S-ext.pkg, on: SIP2
  Built: 2013-07-25_21.16, by: mcpre
  File SHA1 checksum: 3b6a4838972840a995ff22e73fd2bae910b268a7
<some output removed for brevity>
Router# show version R0 provisioned
Package: Provisioning File, version: n/a, status: active
  File: bootflash:Active_Dir/packages.conf, on: RP0
  Built: n/a, by: n/a

```

```

File SHA1 checksum: c79075780592aec1312725f4a2357a034fda2d3b
Package: rpbase, version: 03.12.01.S.154-2.S, status: active
File: bootflash:Active_Dir/asr1000rp2-rpbase.03.12.01.S.154-2.S.pkg, on: RP0
Built: 2013-03-25_18.48, by: mcpre
File SHA1 checksum: 3a9675142898cfac350d4e42f0e37bd9f4e48538
Package: rpcontrol, version: 03.12.01.S.154-2.S, status: active
File: bootflash:Active_Dir/asr1000rp2-rpcontrol.03.12.01.S.154-2.S.pkg, on: RP0/0
Built: 2013-03-25_18.48, by: mcpre
File SHA1 checksum: 87b11f863f67fdf2610ee0769b929baab4c3efad
Package: rpios-adventerprisek9, version: 03.12.01.S.154-2.S, status: active
File: bootflash:Active_Dir/asr1000rp2-rpios-adventerprisek9.03.12.01.S.154-2.S.pkg, on:
RP0/0 Built: 2013-03-25_18.51, by: mcpre
File SHA1 checksum: b487136319da0a327844d353c77e533c53c56053
Package: rpaccess, version: 03.12.01.S.154-2.S, status: active
File: bootflash:Active_Dir/asr1000rp2-rpaccess.03.12.01.S.154-2.S.pkg, on: RP0/0
Built: 2013-03-25_18.48, by: mcpre
File SHA1 checksum: 032bea36f74b19977b363243c99f02413b54104d
<some output removed for brevity>
Router# redundancy force-switchover
Proceed with switchover to standby RP? [confirm]
<output removed for brevity>
Router# request platform software package clean
Cleaning up unnecessary package files
No path specified, will use booted path bootflash:Active_Dir/packages.conf
Cleaning bootflash:Active_Dir
Scanning boot directory for packages ... done.
Preparing packages list to delete ... asr1000rp2-elcbase.03.13.00.S.154-3.S-ext.pkg
File is in use, will not delete...asr1000rp2-elcspa.03.13.00.S.154-3.S-ext.pkg
File is in use, will not delete...asr1000rp2-espbase.03.13.00.S.154-3.S-ext.pkg
File is in use, will not delete...asr1000rp2-esp86base.03.13.00.S.154-3.S-ext.pkg
File is in use, will not delete...asr1000rp2-rpaccess.03.13.00.S.154-3.S-ext.pkg
File is in use, will not delete... asr1000rp2-rpbase.03.13.00.S.154-3.S-ext.pkg
File is in use, will not delete.
asr1000rp2-rpcontrol.03.13.00.S.154-3.S-ext.pkg
File is in use, will not
delete...asr1000rp2-rpios-adventerprisek9.03.13.00.S.154-3.S-ext.pkg
File is in use, will not delete...asr1000rp2-sipbase.03.13.00.S.154-3.S-ext.pkg
File is in use, will not delete... asr1000rp2-sipspa.03.13.00.S.154-3.S-ext.pkg
File is in use, will not delete...packages.conf
File is in use, will not delete... done.

Files that will be deleted: asr1000rp2-elcbase.03.12.01.S.154-2.S.pkg
asr1000rp2-elcspa.03.12.01.S.154-2.S.pkg
asr1000rp2-espbase.03.12.01.S.154-2.S.pkg
asr1000rp2-esp86base.03.12.01.S.154-2.S.pkg
asr1000rp2-packages-adventerprisek9.03.12.01.S.154-2.S.conf
asr1000rp2-rpaccess.03.12.01.S.154-2.S.pkg
asr1000rp2-rpbase.03.12.01.S.154-2.S.pkg
asr1000rp2-rpcontrol.03.12.01.S.154-2.S.pkg
asr1000rp2-rpios-adventerprisek9.03.12.01.S.154-2.S.pkg
asr1000rp2-sipbase.03.12.01.S.154-2.S.pkg
asr1000rp2-sipspa.03.12.01.S.154-2.S.pkg
packages.conf.00-
Do you want to proceed? [confirm]y
Deleting file bootflash:Active_Dir/asr1000rp2-elcbase.03.12.01.S.154-2.S.pkg ... done.
Deleting file bootflash:Active_Dir/asr1000rp2-elcspa.03.12.01.S.154-2.S.pkg ... done.
Deleting file bootflash:Active_Dir/asr1000rp2-espbase.03.12.01.S.154-2.S.pkg ... done.
Deleting file bootflash:Active_Dir/asr1000rp2-esp86base.03.12.01.S.154-2.S.pkg ... done.

Deleting file
bootflash:Active_Dir/asr1000rp2-packages-adventerprisek9.03.12.01.S.154-2.S.conf ... done.
Deleting file bootflash:Active_Dir/asr1000rp2-rpaccess.03.12.01.S.154-2.S.pkg ... done.
Deleting file bootflash:Active_Dir/asr1000rp2-rpbase.03.12.01.S.154-2.S.pkg ... done.
Deleting file bootflash:Active_Dir/asr1000rp2-rpcontrol.03.12.01.S.154-2.S.pkg ... done.

```

```

Deleting file bootflash:Active_Dir/asr1000rp2-rpios-adventerprisek9.03.12.01.S.154-2.S.pkg
... done.
Deleting file bootflash:Active_Dir/asr1000rp2-sipbase.03.12.01.S.154-2.S.pkg ... done.
Deleting file bootflash:Active_Dir/asr1000rp2-sipsa.03.12.01.S.154-2.S.pkg ... done.
Deleting file bootflash:Active_Dir/packages.conf.00- ... done.
SUCCESS: Files deleted...

```

In Service One-Shot Software Upgrade Procedure

In service one-shot software upgrade procedure is an alternate to the standard ISSU procedure that enables you to upgrade or downgrade software using a single command. One-shot ISSU needs minimal user intervention or monitoring. Unlike the standard ISSU procedures, once the upgrade is initiated, the upgrade process cannot be cancelled.

The one-shot upgrade procedure is divided into stages. When a failure occurs, the command execution is stalled and users have to perform the rollback tasks manually. Necessary switchovers are automatically taken care of in one of the upgrade stages. During a switchover, the console and its output are lost. Additional commands are used to connect back to the console.



Note One-shot upgrade does not support multiple upgrades at the same time.

The **request platform software package install node file consolidated file name interface-module-delay secs** command is used for the one-shot ISSU procedure.

interface-module-delay is an optional parameter.

The interface-module-delay option specifies the time in seconds to wait after the first SIP and SPA combination has completed its upgrade or reboot before starting the upgrade of the next SIP and SPA. A minimum value of 60 seconds is recommended to ensure that all of the previously restarted SPAs are operational.

Example:

```

router# request platform software package install node file bootflash interface-module-delay
60

```

The SIP-delay option enables you to delay the SIP restart duration thus enabling you to choose the restart time to minimize traffic loss.

The **request platform software package install node attach** command enables the users to view the last run log that contains the reports of all the stages of the one-shot upgrade.

The **request platform software package install file mdr** command enables the users to initiate the ISSU procedure using MDR.

ISSU Procedures (Prior to Cisco IOS XE Release 2.1.2)

These instructions should be followed only if you are upgrading using ISSU to a pre-Cisco IOS XE 2.1.2 release. If you are using Cisco IOS XE Release 2.2.1 or later, follow the earlier instructions in this chapter to perform your ISSU upgrade.

This section contains the following topics:

Using ISSU to Perform a Consolidated Package Upgrade in a Dual Route Processor Configuration (Prior to Cisco IOS XE 2.1.2)

This procedure is identical to the procedure used to upgrade post-Cisco IOS XE 2.2 images using ISSU.

Using ISSU to Upgrade Subpackages (Prior to Cisco IOS XE Release 2.1.2)

This procedure will work on single RPs configured to run two IOS processes or on routers configured with dual RPs.

Versions of Cisco IOS XE Release 2.1 prior to Cisco IOS XE Release 2.1.2 and versions of Cisco IOS XE Release 2.2 prior to Cisco IOS XE Release 2.2.1 and installations not booted from the RPBase subpackage on Cisco IOS XE Release 2.2.1 or 2.1.2 require a different ISSU upgrade procedure.

SUMMARY STEPS

1. Copy all subpackages other than the **RPBase** subpackage into the same directory.
2. Install the RP subpackages from the directory simultaneously by using a wildcard statement to capture all of the RP subpackages. This command should capture the RPControl, RPAccess, and RPIOS subpackages without capturing the RPBase subpackage and should be done using the standby bay.
3. Wait for the system to reach SSO ready state. The **show platform** command can be used to monitor whether both IOS instances are active, and a system message will indicate SSO state has been reached.
4. Use the **redundancy force-switchover** command to trigger an IOS switchover.
5. Wait for the system to reach SSO ready state. Like in step 3, the state can be monitored by checking system messages or by entering the **show platform** command.
6. Install the RP subpackages from the directory simultaneously by using a wildcard statement to capture all of the RP subpackages. This command should capture the RPControl, RPAccess, and RPIOS subpackages without capturing the RPBase subpackage and should be done using the standby bay.
7. Install the SIPBASE and SIPSPA packages on each SIP:
8. Install the ESPBASE package on the ESP:
9. Copy the RPBase subpackage into the directory, then upgrade all of the RP subpackages simultaneously. This step will upgrade the RPBase subpackage, which is the last remaining subpackage that requires an upgrade:
10. Enter **show version provisioned** to confirm that all of the software has been updated.
11. Reload the router using the **reload** command when appropriate to complete the installation.

DETAILED STEPS

-
- Step 1** Copy all subpackages other than the **RPBase** subpackage into the same directory.
- Step 2** Install the RP subpackages from the directory simultaneously by using a wildcard statement to capture all of the RP subpackages. This command should capture the RPControl, RPAccess, and RPIOS subpackages without capturing the RPBase subpackage and should be done using the standby bay.
- Use the `asr1000rp1-rp*version.pkg` syntax instead of using the `{pattern}` syntax to complete this upgrade:
- ```
request platform software package install rp 1 file stby-bootflash:asr1000rp*02.02.01.122-33.XNB1*.pkg bay 1 force
```
- Step 3** Wait for the system to reach SSO ready state. The **show platform** command can be used to monitor whether both IOS instances are active, and a system message will indicate SSO state has been reached.

- Step 4** Use the **redundancy force-switchover** command to trigger an IOS switchover.
- Step 5** Wait for the system to reach SSO ready state. Like in step 3, the state can be monitored by checking system messages or by entering the **show platform** command.
- Step 6** Install the RP subpackages from the directory simultaneously by using a wildcard statement to capture all of the RP subpackages. This command should capture the RPControl, RPAccess, and RPIOS subpackages without capturing the RPBase subpackage and should be done using the standby bay.

Use the “asr1000rp1-rp\**version*.pkg syntax instead of using the {*pattern*} syntax to complete this upgrade:

**Example:**

```
request platform software package install rp 0 file stby-bootflash:asr1000rp*02.02.01.122-33.XNB1*.pkg
bay 0 force
```

- Step 7** Install the SIPBASE and SIPSPA packages on each SIP:

**Example:**

```
Router# request platform software package install rp 0 file
bootflash:asr1000rp1-sip*02.02.01.122-33.XNB1*.pkg slot 4 force
Router# request platform software package install rp 0 file
bootflash:asr1000rp1-sip*02.02.01.122-33.XNB1*.pkg slot 1 force
Router# request platform software package install rp 0 file
bootflash:asr1000rp1-sip*02.02.01.122-33.XNB1*.pkg slot 2 force
```

- Step 8** Install the ESPBASE package on the ESP:

**Example:**

```
Router# request platform software package install rp 0 file
bootflash:asr1000rp1-esp*02.02.01.122-33.XNB1*.pkg
```

- Step 9** Copy the RPBase subpackage into the directory, then upgrade all of the RP subpackages simultaneously. This step will upgrade the RPBase subpackage, which is the last remaining subpackage that requires an upgrade:

**Example:**

```
request platform software package install rp 1 file bootflash:asr1000rp*02.02.01.122-33.XNB1*.pkg
force
```

- Step 10** Enter **show version provisioned** to confirm that all of the software has been updated.

- Step 11** Reload the router using the **reload** command when appropriate to complete the installation.

**Example:**

```
Downgrades in versions that do not support the {
pattern
} syntax are problematic because an RPBASE package for the downgrade version will always be present
if an upgrade was previously performed. Removing and restaging all packages will work in this case,
but they effectively put the system into a state where if the RP reloads prior to the installation
being completed, the RP may no longer be bootable.
```

# Upgrade Process with Service Impact for Nonredundant Platforms

Subpackage software upgrade is supported for nonredundant platforms such as Cisco ASR 1001 Router, Cisco ASR1001-X, Cisco ASR 1002, Cisco ASR 1002-X, and ASR 1004 Routers in subpackage mode. This is because the software upgrade procedure on these chassis types requires an RP reload when upgrading the RPBase subpackage at the last step.

During the software upgrade process, there will be outage on the control plane as the entire platform is rebooted so that access to the router operating system and ROMmon is lost for a period of time.

For non-hardware-redundant chassis types, SIP impact can be mitigated by installing SIPs one slot at a time if SPAs are redundant across SIPs (such as when using Gigabit Etherchannel). ESP redundancy provides similar capability for the ESP allowing hitless upgrade of a chassis from one software release to another. Consolidated package mode does not provide such a per-slot staging option and always incurs a traffic loss equivalent to simultaneous OIR of all SIPs.



---

**Note** The Cisco ASR 1002 and ASR 1002-F Routers come by default with 4-GB DRAM. The Cisco ASR 1001 Router comes by default with 4-GB DRAM, and is upgradeable up to 8-GB or 16-GB DRAM.

---

This section explains how to upgrade subpackages on a Cisco ASR 1001, Cisco ASR 1001-X, Cisco ASR1002, Cisco ASR 1002-X, or Cisco ASR 1004 Router. It contains the following sections:

## Configuring SSO on a Cisco ASR 1001, Cisco ASR 1001-X, Cisco ASR 1001-HX, Cisco ASR 1002, Cisco ASR 1002-X, Cisco ASR 1002-HX, or Cisco ASR 1004 Router

The following instructions show how to configure SSO on a Cisco ASR 1001, Cisco ASR 1001-X, Cisco ASR 1001-HX, Cisco ASR 1002, Cisco ASR 1002-X, Cisco ASR 1002-HX, and Cisco ASR 1004 Routers. The standby IOS process is created automatically as part of these configuration steps.

### SUMMARY STEPS

1. (Optional) Enter the **show version** command to confirm the amount of DRAM on your router:
2. (Optional) Enter **show redundancy states** to see the current HA configuration:
3. Enter **configure terminal** to enter global configuration mode:
4. Enter the **redundancy** command to enter redundancy configuration mode:
5. Enter **mode sso** to enable SSO, or **mode none** to disable dual software redundancy:
6. Return to privileged EXEC mode using any method, such as entering **Ctrl-Z** or the **exit** command multiple times until you get to the # router prompt:
7. Enter the **show redundancy states** command to confirm the configured redundancy mode changed to your new configuration.
8. Enter the **copy running-config startup-config** command to save the new configuration, and press **enter** to confirm the filename (or change the name, if desired):

9. After the reload is complete, enter the **show redundancy states** command to confirm the operational redundancy mode has changed to the mode that you configured before.
10. The router must be reloaded for the new HA configuration. Enter the **reload** command to reload the router:
11. (Optional) To confirm an active and a standby IOS process exist, and how the processes are numbered, enter the **show platform** command.

## DETAILED STEPS

**Step 1** (Optional) Enter the **show version** command to confirm the amount of DRAM on your router:

**Example:**

```
Router# show version
<some output removed for brevity>
32768K bytes of non-volatile configuration memory.
4194304K bytes of physical memory.
921599K bytes of eUSB flash at bootflash:.
39004543K bytes of SATA hard disk at bootflash:.
Configuration register is 0x2102
```

In the example **show version** output, the router has 4 GB of DRAM memory.

If you are using a Cisco ASR 1001, Cisco ASR 1001-X, Cisco ASR 1001-HX, Cisco ASR 1002, Cisco ASR 1002-X, Cisco ASR 1002-HX, or Cisco ASR 1004 Router with less than required DRAM memory on the RP, SSO cannot be configured on your RP.

**Step 2** (Optional) Enter **show redundancy states** to see the current HA configuration:

**Example:**

```
Router# show redundancy states
 my state = 13 -ACTIVE
 peer state = 1 -DISABLED
 Mode = Simplex
 Unit ID = 6
Redundancy Mode (Operational) = Non-redundant
Redundancy Mode (Configured) = Non-redundant
Redundancy State = Non Redundant
```

In this example, HA for the dual RPs is not configured, as indicated by the nonredundant operational mode.

**Step 3** Enter **configure terminal** to enter global configuration mode:

**Example:**

```
Router# configure terminal
Enter configuration commands, one per line. End with CNTL/Z.
Router(config)#
```

**Step 4** Enter the **redundancy** command to enter redundancy configuration mode:

**Example:**

```
Router(config)# redundancy
Router(config-red)#
```

**Step 5** Enter **mode sso** to enable SSO, or **mode none** to disable dual software redundancy:

**Example:**

```
Router(config-red) # mode sso
Router(config-red) # mode none
```

**Step 6** Return to privileged EXEC mode using any method, such as entering **Ctrl-Z** or the **exit** command multiple times until you get to the **# router** prompt:

**Example:**

```
Router(config-red) #^Z
Router#
Router(config-red) #exit
Router(config) #exit
Router#
```

**Step 7** Enter the **show redundancy states** command to confirm the configured redundancy mode changed to your new configuration.

In the following example, the configured redundancy mode has been changed to SSO. Note that the operation redundancy mode remains unchanged:

**Example:**

```
Router# show redundancy states
 my state = 13 -ACTIVE
 peer state = 1 -DISABLED
 Mode = Simplex
 Unit ID = 6
Redundancy Mode (Operational) = Non-redundant
Redundancy Mode (Configured) = sso
Redundancy State = Non Redundant
```

**Step 8** Enter the **copy running-config startup-config** command to save the new configuration, and press **enter** to confirm the filename (or change the name, if desired):

**Example:**

```
Router# copy running-config startup-config
Destination filename [startup-config]?
Building configuration...
[OK]
PE25_ASR-1004#
```

**Step 9** After the reload is complete, enter the **show redundancy states** command to confirm the operational redundancy mode has changed to the mode that you configured before.

In this example, the operational redundancy mode has changed to SSO:

**Example:**

```
Router# show redundancy states
 my state = 13 -ACTIVE
 peer state = 8 -STANDBY HOT
 Mode = Duplex
 Unit ID = 6
Redundancy Mode (Operational) = sso
Redundancy Mode (Configured) = sso
Redundancy State = sso
```



**Step 10** The router must be reloaded for the new HA configuration. Enter the **reload** command to reload the router:

**Example:**

```
Router# reload
Proceed with reload? [confirm]
<bootup messages removed for brevity>
```

If you are not using the console port to complete this procedure, your session may be terminated at this point. If your session is terminated, give the router a few minutes to complete the reload and then log into the router.

**Example:**

**Step 11** (Optional) To confirm an active and a standby IOS process exist, and how the processes are numbered, enter the **show platform** command.

In this example, the **show platform** command output reveals that R0/0 is the active IOS process and R0/1 is the standby IOS process:

**Example:**

```
Router# show platform
Chassis type: ASR1004
Slot Type State Insert time (ago)

0 ASR1000-SIP10 ok 00:52:34
 0/0 SPA-2X1GE-V2 ok 00:51:30
 0/1 SPA-2XT3/E3 ok 00:51:24
R0 ASR1000-RP1 ok 00:52:34
R0/0 ok, active 00:52:34
R0/1 ok, standby 00:51:00
F0 ASR1000-ESP10 ok, active 00:52:34
P0 ASR1004-PWR-AC ok 00:51:57
P1 ASR1004-PWR-AC ok 00:51:57
```

## Using Subpackages for Software Upgrade on a Cisco ASR 1001 Router, Cisco ASR 1001-X Router, Cisco ASR 1001-HX Router, Cisco ASR 1002-X Router or a ASR 1002-HX Router

This section provides instructions on using software upgrade for Cisco ASR 1001 Router, Cisco ASR 1001-X Router, Cisco ASR 1001-HX Router, Cisco ASR 1002-X Router, or Cisco ASR 1002-HX Router running subpackages.

These instructions assume two IOS processes are active on the RP and that the router is already running using subpackages.



**Note** Step 17 does not have to be performed immediately, and should be done at a convenient time.

## SUMMARY STEPS

1. **show version**
2. **redundancy**
3. **mkdir** *URL-to-directory-name*
4. **ip tftp** *source-interface gigabitethernet port*
5. **copy tftp:** *URL-to-target-location*
6. **request platform software package expand file** *URL-to-consolidated-package*
7. **dir** *target-URL*
8. **copy** *file-system:asr1001-espbase.version.pkg* *URL-to-directory-of-sub-packages-active-RP*
9. **issu loadversion rp 0 file** *file-system :asr1001-{rpaccess,rpios,rpcontrol}\* version-string \*.pkg bay standby-bay force*
10. **issu commitversion**
11. **redundancy force-switchover**
12. **show platform**
13. **issu loadversion rp 0 file** *file-system :asr1001-{rpaccess,rpios,rpcontrol}\* version-string \*.pkg bay standby-bay force*
14. **issu commitversion**
15. **issu loadversion rp 0 file** *file-system :asr1001-{rpbase,sipbase,sipspa,espbase}\* version \*.pkg force*
16. **show version installed**
17. **reload**

## DETAILED STEPS

|        | Command or Action                                                                                                                                                                                                                                                                                                                                                                                                                                   | Purpose                                                                                                                                                                                                                                                                                                                                                                                                                                                                                                                                                                                                                                                                                                                                   |
|--------|-----------------------------------------------------------------------------------------------------------------------------------------------------------------------------------------------------------------------------------------------------------------------------------------------------------------------------------------------------------------------------------------------------------------------------------------------------|-------------------------------------------------------------------------------------------------------------------------------------------------------------------------------------------------------------------------------------------------------------------------------------------------------------------------------------------------------------------------------------------------------------------------------------------------------------------------------------------------------------------------------------------------------------------------------------------------------------------------------------------------------------------------------------------------------------------------------------------|
| Step 1 | <p><b>show version</b></p> <p><b>Example:</b></p> <pre>show version installed</pre> <p><b>Example:</b></p> <pre>dir filesystem:&lt;directory&gt;</pre> <p><b>Example:</b></p> <pre>show platform</pre> <p><b>Example:</b></p> <pre>show redundancy-states</pre> <p><b>Example:</b></p> <pre>Router# show version</pre> <p><b>Example:</b></p> <pre>Router# show version r0 installed</pre> <p><b>Example:</b></p> <pre>Router# dir bootflash:</pre> | <p>(Optional) Use the following commands to confirm the current router configuration, as follows:</p> <ul style="list-style-type: none"> <li>• <b>show version</b> and <b>show version active-rp installed</b>—Verify the running version of the Cisco IOS XE software on the router, and which file was used to boot the router, and where that file is stored.</li> <li>• <b>dir</b> <ul style="list-style-type: none"> <li>—Confirm that the files that were used to boot the router are located in the directory.</li> </ul> </li> <li>• <b>show platform</b>—Confirm the current status of the active and standby RPs.</li> <li>• <b>show redundancy states</b>—Confirm the operational and configured redundancy states.</li> </ul> |

|               | Command or Action                                                                                                                                                                               | Purpose                                                                                                                                                                                                                                                                                                                                                                                                                                                                                                                                     |
|---------------|-------------------------------------------------------------------------------------------------------------------------------------------------------------------------------------------------|---------------------------------------------------------------------------------------------------------------------------------------------------------------------------------------------------------------------------------------------------------------------------------------------------------------------------------------------------------------------------------------------------------------------------------------------------------------------------------------------------------------------------------------------|
|               | <p><b>Example:</b></p> <pre>Router# show platform</pre> <p><b>Example:</b></p> <pre>Router# show redundancy-states</pre>                                                                        |                                                                                                                                                                                                                                                                                                                                                                                                                                                                                                                                             |
| <b>Step 2</b> | <p><b>redundancy</b></p> <p><b>Example:</b></p> <pre>mode sso</pre> <p><b>Example:</b></p> <pre>Router(config)# redundancy</pre> <p><b>Example:</b></p> <pre>Router(config-red)# mode sso</pre> | <p>Configure SSO if it is not already configured.</p> <p><b>Note</b> Save the configuration after making this configuration step.</p>                                                                                                                                                                                                                                                                                                                                                                                                       |
| <b>Step 3</b> | <p><b>mkdir</b> <i>URL-to-directory-name</i></p> <p><b>Example:</b></p> <pre>Router# mkdir 221subs</pre>                                                                                        | <p>Create a directory to store the consolidated package and subpackages.</p> <p>This directory must be created in most cases because the consolidated packages and subpackages have to be separated from the subpackages that booted the router at this step of the procedure.</p>                                                                                                                                                                                                                                                          |
| <b>Step 4</b> | <p><b>ip tftp</b> <i>source-interface gigabitethernet port</i></p> <p><b>Example:</b></p> <pre>Router(config)# ip tftp source-interface gigabitethernet 0</pre>                                 | <p>Specifies the Gigabit Ethernet TFTP source-interface to be configured:</p> <p>slot/port—Specifies the location of the TFTP source-interface.</p> <p><b>Note</b> To copy a file using TFTP through the Management Ethernet interface, the <b>ip tftp source-interface GigabitEthernet 0</b> command must be entered before entering the <b>copy tftp</b> command.</p>                                                                                                                                                                     |
| <b>Step 5</b> | <p><b>copy tftp:</b> <i>URL-to-target-location</i></p> <p><b>Example:</b></p> <pre>Router# copy tftp: 221subs</pre>                                                                             | <p>Copy the consolidated package file into the directory created in <a href="#">Step 3</a> .</p> <p>The consolidated package in this step should not be copied into the same directory where the subpackages that are currently running your router are stored (the directory containing the packages.conf provisioning file from which the router was booted).</p> <p><b>Tip</b> It is recommended that you copy the package onto a usb: or harddisk: file system for space considerations when performing this step of the procedure.</p> |

|               | Command or Action                                                                                                                                                                                                                                                                                                                                                                                                                                                                                                                                                                                                                                                                                                                                                                                                                                                                           | Purpose                                                                                                                                                                                                                                                                                                                                                                                                                                                                             |
|---------------|---------------------------------------------------------------------------------------------------------------------------------------------------------------------------------------------------------------------------------------------------------------------------------------------------------------------------------------------------------------------------------------------------------------------------------------------------------------------------------------------------------------------------------------------------------------------------------------------------------------------------------------------------------------------------------------------------------------------------------------------------------------------------------------------------------------------------------------------------------------------------------------------|-------------------------------------------------------------------------------------------------------------------------------------------------------------------------------------------------------------------------------------------------------------------------------------------------------------------------------------------------------------------------------------------------------------------------------------------------------------------------------------|
| <b>Step 6</b> | <p><b>request platform software package expand file</b><br/><i>URL-to-consolidated-package</i></p> <p><b>Example:</b></p> <p><i>(Optional) dir target-URL</i></p> <p><b>Example:</b></p> <pre>Router# request platform software package expand file usb0:221subs/asr1001-universalk9.03.02.01.S.151-1.S1_2.bin</pre> <p><b>Example:</b></p> <pre>Router# dir 221subs</pre>                                                                                                                                                                                                                                                                                                                                                                                                                                                                                                                  | <p>Extract the subpackages out of the consolidated package file into the temporary directory.</p> <p><b>Note</b> Take extra care to extract the subpackages to a temporary subdirectory and do not delete any of the files currently running the router at this point of the procedure. To erase the files that were running on the router before the ISSU upgrade, enter the <b>request platform software package clean</b> command after the ISSU upgrade has been completed.</p> |
| <b>Step 7</b> | <p><b>dir target-URL</b></p> <p><b>Example:</b></p> <pre>Router# dir 221subs</pre>                                                                                                                                                                                                                                                                                                                                                                                                                                                                                                                                                                                                                                                                                                                                                                                                          | (Optional) Display the directory to confirm that the files were extracted.                                                                                                                                                                                                                                                                                                                                                                                                          |
| <b>Step 8</b> | <p><b>copy file-system:asr1001-espbase.version.pkg</b><br/>URL-to-directory-of-sub-packages-active-RP</p> <p><b>Example:</b></p> <pre>copy file-system:asr1001-rpaccess.version.pkg URL-to-directory-of-sub-packages-active-RP</pre> <p><b>Example:</b></p> <pre>copy file-system:asr1001-rpbase.version.pkg URL-to-directory-of-sub-packages-active-RP</pre> <p><b>Example:</b></p> <pre>copy file-system:asr1001-rpcontrol.version.pkg URL-to-directory-of-sub-packages-active-RP</pre> <p><b>Example:</b></p> <pre>copy file-system:asr1001-rpios.version.pkg URL-to-directory-of-sub-packages-active-RP</pre> <p><b>Example:</b></p> <pre>copy file-system:asr1001-sipbase.version.pkg URL-to-directory-of-sub-packages-active-RP</pre> <p><b>Example:</b></p> <pre>copy file-system:asr1001-sipspa.version.pkg URL-to-directory-of-sub-packages-active-RP</pre> <p><b>Example:</b></p> | Copy the subpackages out of the temporary directory into the directory on the router where the subpackages running the active RP are currently stored.                                                                                                                                                                                                                                                                                                                              |

|                | Command or Action                                                                                                                                                                                                                                                                                                                                                                                                                                                                                                                                                                                                             | Purpose                                                                    |
|----------------|-------------------------------------------------------------------------------------------------------------------------------------------------------------------------------------------------------------------------------------------------------------------------------------------------------------------------------------------------------------------------------------------------------------------------------------------------------------------------------------------------------------------------------------------------------------------------------------------------------------------------------|----------------------------------------------------------------------------|
|                | <pre>Router# copy 221subs/asr1001-esrbase.03.02.01.S.151-1.S1_2.pkg bootflash:  Example:  Router# copy 221subs/asr1001-rpaccess.03.02.01.S.151-1.S1_2.pkg bootflash:  Example:  Router# copy 221subs/asr1001-rpbase.03.02.01.S.151-1.S1_2.pkg bootflash:  Example:  Router# copy 221subs/asr1001-rpcontrol.03.02.01.S.151-1.S1_2.pkg bootflash:  Example:  Router# copy 221subs/asr1001-rpios-universalk9.03.02.01.S.151-1.S1_2.pkg bootflash:  Example:  Router# copy 221subs/asr1001-sipbase.03.02.01.S.151-1.S1_2.pkg bootflash:  Example:  Router# copy 221subs/asr1001-sipspa.03.02.01.S.151-1.S1_2.pkg bootflash:</pre> |                                                                            |
| <b>Step 9</b>  | <pre>issu loadversion rp 0 file file-system :asr1001-{rpaccess,rprios,rpcontrol}* version-string *.pkg bay standby-bay force  Example:  Router# issu loadversion rp 0 file bootflash:asr1001-{rpaccess,rprios,rpcontrol}*03.02.01.S.151-1.S1_2*.pkg bay 1 force</pre>                                                                                                                                                                                                                                                                                                                                                         | Upgrade the RPAccess, RPIOS, and RPControl subpackages in the standby bay. |
| <b>Step 10</b> | <pre>issu commitversion  Example:</pre>                                                                                                                                                                                                                                                                                                                                                                                                                                                                                                                                                                                       | Once the SSO state is reached, commit the software version.                |

|                | Command or Action                                                                                                                                                                                                                                                                                                                                                                                                                                    | Purpose                                                                                                                                                                                                                                                                                                                                                                                                                                                                                                       |
|----------------|------------------------------------------------------------------------------------------------------------------------------------------------------------------------------------------------------------------------------------------------------------------------------------------------------------------------------------------------------------------------------------------------------------------------------------------------------|---------------------------------------------------------------------------------------------------------------------------------------------------------------------------------------------------------------------------------------------------------------------------------------------------------------------------------------------------------------------------------------------------------------------------------------------------------------------------------------------------------------|
|                | Router# <b>issu commitversion</b>                                                                                                                                                                                                                                                                                                                                                                                                                    |                                                                                                                                                                                                                                                                                                                                                                                                                                                                                                               |
| <b>Step 11</b> | <p><b>redundancy force-switchover</b></p> <p><b>Example:</b></p> <pre>Router# redundancy force-switchover</pre>                                                                                                                                                                                                                                                                                                                                      | <p>Force a switchover from the active IOS process to the standby IOS process.</p> <p><b>Note</b> Your connection to the router often drops and is expected behavior at this point of the procedure in many scenarios. If this step drops your connection to the router, wait a few minutes before reconnecting to the router and then continue to <a href="#">Step 12</a>.</p>                                                                                                                                |
| <b>Step 12</b> | <p><b>show platform</b></p> <p><b>Example:</b></p> <pre>Router# show platform</pre>                                                                                                                                                                                                                                                                                                                                                                  | (Optional) Monitor system state to ensure both IOS processes are active.                                                                                                                                                                                                                                                                                                                                                                                                                                      |
| <b>Step 13</b> | <p><b>issu loadversion rp 0 file file-system :asr1001-{rpass, rpios, rpcontrol}* version-string *.pkg bay standby-bay force</b></p> <p><b>Example:</b></p> <pre>Router# issu loadversion rp 0 file hotflash:asr1001-{rpass,rpios,rpcontrol}*03.02.01.S.151-1.S1_2*.pkg bay 0 force</pre>                                                                                                                                                             | Upgrade the RPAcess, RPIOS, and RPControl subpackages in the standby bay (a different bay than in <a href="#">Step 9</a> ).                                                                                                                                                                                                                                                                                                                                                                                   |
| <b>Step 14</b> | <p><b>issu commitversion</b></p> <p><b>Example:</b></p> <pre>Router# issu commitversion</pre>                                                                                                                                                                                                                                                                                                                                                        | Commit the software version.                                                                                                                                                                                                                                                                                                                                                                                                                                                                                  |
| <b>Step 15</b> | <p><b>issu loadversion rp 0 file file-system :asr1001-{rpbase, sipbase, sipspa, espbase}* version *.pkg force</b></p> <p><b>Example:</b></p> <pre>issu loadversion rp 0 file file-system :asr1001-{rpbase, sipbase, sipspa, espbase}*version *.pkg force</pre> <p><b>Example:</b><br/>For ASR 1001 and ASR 1002-X</p> <pre>Router#issu loadversion rp 0 file hotflash:asr1001-{rpbase,sipbase,sipspa,espbase}*03.02.01.S.151-1.S1_2*.pkg force</pre> | <p>Upgrade the RP, SIP, SPA, and ESP subpackages for each SIP on the router.</p> <p><b>Note</b> This step must be completed one SIP at a time, and repeated for each SIP installed on the router before performing the next step.</p> <p><b>Tip</b> You can use the <b>show ip interface brief</b> command to identify which slots contain SIPs and SPAs. The interfaces with three numbers (in the form <i>SIP-number/SPA-number/interface-number</i>) identify the SIP and SPA locations in the router.</p> |

|         | Command or Action                                                                                                                                                                                                                                                                                                                                                                                                                                                                                                                                                                                                                                                                                                                                                                                                                                                                                                                                                                                                                                                                                                                                                                                                                                                                                                                                                                                                                                                                                        | Purpose                                                                                                                                                                                                                                                                                                                                                                                                                                                                                                                                                                                                                                             |
|---------|----------------------------------------------------------------------------------------------------------------------------------------------------------------------------------------------------------------------------------------------------------------------------------------------------------------------------------------------------------------------------------------------------------------------------------------------------------------------------------------------------------------------------------------------------------------------------------------------------------------------------------------------------------------------------------------------------------------------------------------------------------------------------------------------------------------------------------------------------------------------------------------------------------------------------------------------------------------------------------------------------------------------------------------------------------------------------------------------------------------------------------------------------------------------------------------------------------------------------------------------------------------------------------------------------------------------------------------------------------------------------------------------------------------------------------------------------------------------------------------------------------|-----------------------------------------------------------------------------------------------------------------------------------------------------------------------------------------------------------------------------------------------------------------------------------------------------------------------------------------------------------------------------------------------------------------------------------------------------------------------------------------------------------------------------------------------------------------------------------------------------------------------------------------------------|
|         | <p><b>Example:</b></p> <p>For ASR 1001-X</p> <pre>issu loadversion rp 0 file file-system :asr1001-{rpbases, sipbase, sipspa, esp, firmware}* version *.pkg force</pre> <p><b>Example:</b></p> <pre>Router#issu loadversion rp 0 file bootflash:221subs/asr1001-{rpbases, sipbase, sipspa, esp, firmware}*16.02.01.SPA.pkg force</pre> <p><b>Example:</b></p> <p>For ASR1001-HX and ASR1002-HX</p> <pre>issu loadversion rp 0 file file-system :asr1000-{rpbases, elcbases, elcspas, espbases}* version *.pkg force</pre> <p><b>Example:</b></p> <pre>Router# issu loadversion rp 0 file bootflash:221subs/asr1001-{rpbases, elcbases, elcspas, espbases}*16.02.01.SPA.pkg force</pre> <p><b>Example:</b></p> <p><b>For upgrade/downgrade between Polaris 16.x.x releases:</b></p> <p>For ASR1001-HX and ASR1002-HX Routers, <b>issu loadversion rp 0 file file-system</b></p> <pre>:asr1000-{rpbases, rpboot, elcbases, elcspas, espbases}* version *.pkg force</pre> <p><b>Example:</b></p> <pre>Router# issu loadversion rp 0 file bootflash:221subs/asr1001-{rpbases, rpboot, elcbases, elcspas, espbases}*16.02.01.SPA.pkg force</pre> <p><b>Example:</b></p> <p>For ASR1001-X, <b>issu loadversion rp 0 file file-system</b></p> <pre>:asr1001-{rpbases, rpboot, sipbase, sipspa, esp, firmware}* version *.pkg force</pre> <p><b>Example:</b></p> <pre>Router# issu loadversion rp 0 file bootflash:221subs/asr1001-{rpbases, rpboot, sipbase, sipspa, esp, firmware}*16.02.01.SPA.pkg force</pre> | <p><b>Note</b></p> <p>The <i>pattern</i> options used in this CLI (<b>rpbases, sipbase, sipspa, espbases and firmware</b>) were introduced in Cisco IOS XE Release 2.1.2 and are not available in previous Cisco IOS XE Releases. See the <a href="#">ISSU Procedures (Prior to Cisco IOS XE Release 2.1.2)</a>, on page 157 for pre-Cisco IOS XE Release 2.1.2 ISSU upgrade procedures.</p> <p>ASR 1001-HX and ASR1002-HX Routers are introduced from Polaris 16.x.x release only. Polaris 16.x.x release has 2 new packages i.e. rpboot and webui. Include these 2 packages for upgrade/downgrade between Polaris 16.x.x images at this step.</p> |
| Step 16 | <p><b>show version installed</b></p> <p><b>Example:</b></p> <pre>Router# show version installed</pre>                                                                                                                                                                                                                                                                                                                                                                                                                                                                                                                                                                                                                                                                                                                                                                                                                                                                                                                                                                                                                                                                                                                                                                                                                                                                                                                                                                                                    | <p>(Optional) Verify that the subpackages are properly installed.</p>                                                                                                                                                                                                                                                                                                                                                                                                                                                                                                                                                                               |

|         | Command or Action                                         | Purpose                                                                                                                                                                                                                                                                                                                                                                                                                                                                                                                         |
|---------|-----------------------------------------------------------|---------------------------------------------------------------------------------------------------------------------------------------------------------------------------------------------------------------------------------------------------------------------------------------------------------------------------------------------------------------------------------------------------------------------------------------------------------------------------------------------------------------------------------|
| Step 17 | <b>reload</b><br><b>Example:</b><br>Router# <b>reload</b> | (Optional) Reload the RP.<br><b>Tip</b> The router will continue normal operation even without a reload, so you can reload the router during scheduled maintenance or a slower traffic period. It is highly recommended reload to avoid conflicts in the software base.<br><b>Note</b> For ASR1001-HX and ASR1002-HX Router, the <b>sipbase</b> and <b>sipspa</b> package will be replaced by <b>elcbase</b> and <b>elcspa</b> package. New packages <b>rpboot</b> and <b>webui</b> are introduced from Polaris 16.x.x release. |

## Examples

The following example shows the software upgrade for Cisco ASR 1001 Router, Cisco ASR 1001-X Router or Cisco ASR 1002-X Router running subpackages.

```

Router#show version
Cisco IOS Software, IOS-XE Software (X86_64_LINUX_IOSD-UNIVERSALK9-M), Experimental Version
 15.1(20110301:124851) [asr1001-universalk9.03.02.01.S.151-1.S1]
Copyright (c) 1986-2011 by Cisco Systems, Inc.
Compiled Tue 01-Mar-11 06:25 by mcpre
Cisco IOS-XE software, Copyright (c) 2005-2011 by cisco Systems, Inc.
All rights reserved. Certain components of Cisco IOS-XE software are
licensed under the GNU General Public License ("GPL") Version 2.0. The
software code licensed under GPL Version 2.0 is free software that comes
with ABSOLUTELY NO WARRANTY. You can redistribute and/or modify such
GPL code under the terms of GPL Version 2.0. For more details, see the
documentation or "License Notice" file accompanying the IOS-XE software,
or the applicable URL provided on the flyer accompanying the IOS-XE
software.
ROM: IOS-XE ROMMON
Router uptime is 5 days, 26 minutes
Uptime for this control processor is 5 days, 27 minutes
System returned to ROM by reload
System image file is "bootflash:asr1001-universalk9.03.02.01.S.151-1.S1"
Last reload reason: Reload Command
This product contains cryptographic features and is subject to United
States and local country laws governing import, export, transfer and
use. Delivery of Cisco cryptographic products does not imply
third-party authority to import, export, distribute or use encryption.
Importers, exporters, distributors and users are responsible for
compliance with U.S. and local country laws. By using this product you
agree to comply with applicable laws and regulations. If you are unable
to comply with U.S. and local laws, return this product immediately.
A summary of U.S. laws governing Cisco cryptographic products may be found at:
http://www.cisco.com/wwl/export/crypto/tool/stqrg.html
If you require further assistance please contact us by sending email to
export@cisco.com.
License Info:
License UDI:
Device# PID SN UDI

```



```

*0 ASR1001 JAE14020AT1 ASR1001:JAE14020AT1
License Package Information for Module:'asr1001'
Module name Image level Pri Config Valid license

asr1001 adventerprise 1 NO adventurerprise
 advipservices 2 NO advipservices
 ipbase 3 NO ipbase
Module name Current Level Reboot Level

asr1001 ipbase ipbase
cisco ASR1001 (1RU) processor with 3851680K/6147K bytes of memory.
6 Gigabit Ethernet interfaces
32768K bytes of non-volatile configuration memory.
8388608K bytes of physical memory.
7782399K bytes of eUSB flash at bootflash:.
Configuration register is 0x8102
Router# show version installed
Package: Provisioning File, version: n/a, status: active
 File: consolidated:packages.conf, on: RP0
 Built: n/a, by: n/a
 File SHA1 checksum: e11c9aacb8c233ed10eeac61ca20a9469fb0b81e
Package: rpbase, version: 03.02.01.S.151-1.S1, status: active
 File: consolidated:asr1001-rpbase.03.02.01.S.151-1.S1.pkg, on: RP0
 Built: 2011-03-01_07.10, by: mcpre
 File SHA1 checksum: e3c93ac457f2632ae90ba346692d58001cf0d02c
Package: rpcontrol, version: 03.02.01.S.151-1.S1, status: active
 File: consolidated:asr1001-rpcontrol.03.02.01.S.151-1.S1.pkg, on: RP0/0
 Built: 2011-03-01_07.10, by: mcpre
 File SHA1 checksum: 59ba43488cf2a0e7bc06b66fad0e574bbdf42a62
<output removed for brevity>
Router#show redundancy states
 my state = 13 -ACTIVE
 peer state = 1 -DISABLED
 Mode = Simplex
 Unit = Primary
 Unit ID = 48
Redundancy Mode (Operational) = Non-redundant
Redundancy Mode (Configured) = Non-redundant
Redundancy State = Non Redundant
 Manual Swact = disabled (system is simplex (no peer unit))
 Communications = Down Reason: Simplex mode
 client count = 63
 client_notification_TMR = 30000 milliseconds
 keep_alive TMR = 4000 milliseconds
 keep_alive count = 0
 keep_alive threshold = 7
 RF debug mask = 0x0
Router# show platform

Chassis type: ASR1001
Slot Type State Insert time (ago)

0 ASR1001 ok 5d07h
0/0 ASR1001 ok 5d07h
0/1 SPA-2X1GE-V2 ok 5d07h
R0 ASR1001 ok, active 5d07h
F0 ASR1001 ok, active 5d07h
P0 ASR1001-PWR-AC ps, fail 5d07h
P1 ASR1001-PWR-AC ok 5d07h
P2 ASR1001-FANTRAY ok 5d07h
Slot CPLD Version Firmware Version

0 1001050E 12.2(20090526:143323) [gschnorr-mcp...
R0 10010514 12.2(20090526:143323) [gschnorr-mcp...

```

```

F0 1001050E 12.2(20090526:143323) [gschnorr-mcp_...
Router# mkdir 221subs
Create directory filename [221subs]?
Created dir bootflash:221subs
Router(config)# ip tftp source-interface gigabitethernet 0
Router# copy tftp: 221subs

Address or name of remote host []? 198.51.100.254
Source filename []? /auto/users/asr1001-universalk9.03.02.01.S.151-1.S1_2.bin,12
Destination filename [asr1001-universalk9.03.02.01.S.151-1.S1.bin,12]?
Accessing
tftp://198.51.100.254//auto/users/asr1001-universalk9.03.02.01.S.151-1.S1_2.bin,12...
Loading /auto/users/asr1001-universalk9.03.02.01.S.151-1.S1.bin,12 (via GigabitEthernet0):
!!!!!!
[OK - 209227980 bytes]
209227980 bytes copied in 880.002 secs (237759 bytes/sec)
Router# request platform software package expand file
221subs/asr1001-universalk9.03.02.01.S.151-1.S1_2.bin
Verifying parameters
Validating package type
Copying package files
SUCCESS: Finished expanding all-in-one software package.
Router# dir 221subs
Directory of 221subs/
72013 -rw- 51904716 Oct 7 2008 15:46:02 -07:00
asr1001-espbase.03.02.01.S.151-1.S1_2.pkg
72004 -rw- 5773 Oct 7 2008 15:46:02 -07:00
asr1001-packages-universalk9.03.02.01.S.151-1.S1_2.conf
72014 -rw- 20533452 Oct 7 2008 15:46:03 -07:00 asr1001-rpaccess.03.02.01.S.151-1.S1_
2.pkg
72015 -rw- 22388940 Oct 7 2008 15:46:03 -07:00 asr1001-rpbase.03.02.01.S.151-1.S1_2.pkg
72016 -rw- 27961548 Oct 7 2008 15:46:03 -07:00
asr1001-rpcontrol.03.02.01.S.151-1.S1_2.pkg
72017 -rw- 50942156 Oct 7 2008 15:46:03 -07:00
asr1001-rpios-universalk9.03.02.01.S.151-1.S1_2.pkg
72018 -rw- 36442316 Oct 7 2008 15:46:03 -07:00
asr1001-sipbase.03.02.01.S.151-1.S1_2.pkg
72019 -rw- 26366156 Oct 7 2008 15:46:03 -07:00 asr1001-sipspa.03.02.01.S.151-1.S1_2.pkg
72005 -rw- 6290 Oct 7 2008 15:46:03 -07:00 packages.conf
72003 -rw- 224768204 Oct 7 2008 15:38:57 -07:00
asr1001-universalk9.03.02.01.S.151-1.S1_2.bin
928862208 bytes total (466358272 bytes free)
Router# copy 221subs/asr1001-espbase.03.02.01.S.151-1.S1_2.pkg bootflash:
Destination filename [asr1001-espbase.03.02.01.S.151-1.S1_2.pkg]?
Copy in progress...CCCC
51904716 bytes copied in 5.478 secs (9475122 bytes/sec)
Router# copy 221subs/asr1001-rpaccess.03.02.01.S.151-1.S1_2.pkg bootflash:
Destination filename [asr1001-rpaccess.03.02.01.S.151-1.S1_2.pkg]?
Copy in progress...CCC
20533452 bytes copied in 2.346 secs (8752537 bytes/sec)
Router# copy 221subs/asr1001-rpbase.03.02.01.S.151-1.S1_2.pkg bootflash:

Destination filename [asr1001-rpbase.03.02.01.S.151-1.S1_2.pkg]?
Copy in progress...CCC
22388940 bytes copied in 2.496 secs (8969928 bytes/sec)
Router# copy 221subs/asr1001-rpcontrol.03.02.01.S.151-1.S1_2.pkg bootflash:
Destination filename [asr1001-rpcontrol.03.02.01.S.151-1.S1_2.pkg]?
Copy in progress...CCCC
27961548 bytes copied in 2.992 secs (9345437 bytes/sec)
Router# copy 221subs/asr1001-rpios-universalk9.03.02.01.S.151-1.S1_2.pkg bootflash:
Destination filename [asr1001-rpios-universalk9.03.02.01.S.151-1.S1_2.pkg]?
Copy in progress...CCCC
50942156 bytes copied in 5.719 secs (8907529 bytes/sec)
Router# copy 221subs/asr1001-sipbase.03.02.01.S.151-1.S1_2.pkg bootflash:

```

```

Destination filename [asr1001-sipbase.03.02.01.S.151-1.S1_2.pkg]?
Copy in progress...CCCC
36442316 bytes copied in 3.906 secs (9329830 bytes/sec)
Router# copy 221subs/asr1001-sipsba.03.02.01.S.151-1.S1_2.pkg bootflash:
Destination filename [asr1001-sipsba.03.02.01.S.151-1.S1_2.pkg]?
Copy in progress...CCC

```

26366156 bytes copied in 2.857 secs (9228616 bytes/sec)

```

Router# issu loadversion rp 0 file
bootflash:221subs/asr1001-{rpaccess,rpios,rpcontrol}*03.02.01.S.151-1.S1_2.pkg bay 1 force
--- Starting local lock acquisition on R0 ---
Finished local lock acquisition on R0
--- Starting file path checking ---
Finished file path checking
--- Starting image file verification ---
Checking image file names
Locating image files and validating name syntax
 Found asr1001-rpaccess.03.02.01.S.151-1.S1_2.pkg
 Found asr1001-rpios-universalk9.03.02.01.S.151-1.S1_2.pkg
 Found asr1001-rpcontrol.03.02.01.S.151-1.S1_2.pkg
Verifying image file locations
Inspecting image file types
Processing image file constraints
Creating candidate provisioning file
Finished image file verification
--- Starting candidate package set construction ---
Verifying existing software set
Processing candidate provisioning file
Constructing working set for candidate package set
Constructing working set for running package set
Checking command output
Constructing merge of running and candidate packages
Checking if resulting candidate package set would be complete
Finished candidate package set construction
--- Starting compatibility testing ---
Determining whether candidate package set is compatible
WARNING:
WARNING: Candidate software combination not found in compatibility database
WARNING:
Determining whether installation is valid
WARNING:
WARNING: Candidate software combination not found in compatibility database
WARNING:
WARNING:
WARNING: Candidate software combination not found in compatibility database
WARNING:
Software sets are identified as compatible
Verifying image type compatibility
Checking IPC compatibility with running software
Checking candidate package set infrastructure compatibility
Checking infrastructure compatibility with running software
Checking package specific compatibility
Finished compatibility testing
--- Starting impact testing ---
Checking operational impact of change
 WARNING: Connection may be lost during installation of IOS package
Finished impact testing
--- Starting list of software package changes ---
No old package files removed
New files list:
 Added asr1001-rpaccess.03.02.01.S.151-1.S1_2.pkg
 Added asr1001-rpcontrol.03.02.01.S.151-1.S1_2.pkg

```

```

 Added asr1001-rpios-universalk9.03.02.01.S.151-1.S1_2.pkg
Finished list of software package changes
--- Starting commit of software changes ---
Updating provisioning rollback files
Creating pending provisioning file
Committing provisioning file
Finished commit of software changes
--- Starting analysis of software changes ---
Finished analysis of software changes
--- Starting update running software ---
Blocking peer synchronization of operating information
Creating the command set placeholder directory
 Finding latest command set
 Finding latest command shortlist lookup file
 Finding latest command shortlist file
 Assembling CLI output libraries
 Assembling CLI input libraries
 Assembling Dynamic configuration files
 Applying interim IPC and database definitions
 Replacing running software
 Replacing CLI software
 Restarting software
 Restarting IOS PID: 9275, in slot/bay 0/1
*Mar 15 16:28:50.014: %REDUNDANCY-3-STANDBY_LOST: Standby processor fault (PEER_NOT_PRESENT)

*Mar 15 16:28:50.014: %REDUNDANCY-3-STANDBY_LOST: Standby processor fault (PEER_DOWN)
*Mar 15 16:28:50.014: %REDUNDANCY-3-STANDBY_LOST: Standby processor fault
(PERER_REDUNDANCY_STATE_CHANGE)
*Mar 15 16:28:52.224: %RF-5-RF_RELOAD: Peer reload. Reason: EHSA standby down
*Mar 15 16:29:29.214: %REDUNDANCY-5-PEER_MONITOR_EVENT: Active detected a standby insertion
(raw-event=PEER_FOUND(4))
*Mar 15 16:29:29.214: %REDUNDANCY-5-PEER_MONITOR_EVENT: Active detected a standby insertion
(raw-event=PEER_REDUNDANCY_STATE_CHANGE(5))
 Generating software version information

 Unblocking peer synchronization of operating information
Unmounting old packages
Cleaning temporary installation files
 Finished update running software

Router#issu commitversion
--- Starting local lock acquisition on R0 ---
Finished local lock acquisition on R0
--- Starting installation changes ---
Cancelling rollback timer
Finished installation changes
SUCCESS: Installation changes committed
Router#
*Mar 15 16:30:24.885: %NBAR_HA-5-NBAR_INFO: NBAR sync DONE!
*Mar 15 16:30:25.421: %HA_CONFIG_SYNC-6-BULK_CFGSYNC_SUCCEED: Bulk Sync succeedd
*Mar 15 16:30:25.423: %RF-5-RF_TERMINAL_STATE: Terminal state reached for (SSO)
Router#redundancy force-switchover
Proceed with switchover to standby RP? [confirm]y Manual Swact = enabled
%ASR1000_INFRA-6-CONSOLE_ACTIVE: R0/1 console active. Press RETURN to get star!
*Mar 15 16:31:00.014: %REDUNDANCY-3-SWITCHOVER: RP switchover (PEER_NOT_PRESENT)
*Mar 15 16:31:00.015: %REDUNDANCY-3-SWITCHOVER: RP switchover (PEER_DOWN)
*Mar 15 16:31:00.015: %REDUNDANCY-3-SWITCHOVER: RP switchover (PEER_REDUNDANCY_)
*Mar 15 16:31:00.328: %LINK-3-UPDOWN: Interface Lsmpi0, changed state to up
*Mar 15 16:31:00.328: %LINK-3-UPDOWN: Interface EOBC0, changed state to up
*Mar 15 16:31:00.328: %LINK-3-UPDOWN: Interface LIIN0, changed state to up
*Mar 15 16:31:01.328: %LINEPROTO-5-UPDOWN: Line protocol on Interface Lsmpi0, cp
*Mar 15 16:31:01.328: %LINEPROTO-5-UPDOWN: Line protocol on Interface EOBC0, chp
*Mar 15 16:31:01.328: %LINEPROTO-5-UPDOWN: Line protocol on Interface GigabitEtn
*Mar 15 16:31:01.328: %LINEPROTO-5-UPDOWN: Line protocol on Interface LIIN0, chp

```

```

*Mar 15 16:31:02.064: %RF-5-RF_RELOAD: Self reload. Reason: redundancy force-sw
*Mar 15 16:31:02.293: %SYS-5-SWITCHOVER: Switchover requested by red_switchover.
*Mar 15 16:31:02.321: %LINK-3-UPDOWN: Interface Null0, changed state to up
*Mar 15 16:31:03.321: %LINEPROTO-5-UPDOWN: Line protocol on Interface Null0, chp
*Mar 15 16:31:03.322: %LINEPROTO-5-UPDOWN: Line protocol on Interface GigabitEtn
*Mar 15 16:31:03.322: %LINEPROTO-5-UPDOWN: Line protocol on Interface GigabitEtn
*Mar 15 16:31:03.322: %LINEPROTO-5-UPDOWN: Line protocol on Interface GigabitEtn
*Mar 15 16:31:03.322: %LINEPROTO-5-UPDOWN: Line protocol on Interface GigabitEtn
*Mar 15 16:31:03.322: %LINEPROTO-5-UPDOWN: Line protocol on Interface GigabitEtn
*Mar 15 16:31:03.322: %LINEPROTO-5-UPDOWN: Line protocol on Interface GigabitEtn
*Mar 15 16:31:43.189: %REDUNDANCY-5-PEER_MONITOR_EVENT: Active detected a stand)
*Mar 15 16:31:43.189: %REDUNDANCY-5-PEER_MONITOR_EVENT: Active detected a stand)
*Mar 15 16:32:28.411: %NBAR_HA-5-NBAR_INFO: NBAR sync DONE!
*Mar 15 16:32:28.971: %HA_CONFIG_SYNC-6-BULK_CFGSYNC_SUCCEED: Bulk Sync succeedd
*Mar 15 16:32:28.973: %RF-5-RF_TERMINAL_STATE: Terminal state reached for (SSO)
Router# issu loadversion rp 0 file
bootflash:221subs/asr1001-{rpaccess,rprios,rpcontrol}*03.02.01.S.151-1.S1_2.pkg bay 0 force
--- Starting local lock acquisition on R0 ---
Finished local lock acquisition on R0
--- Starting file path checking ---
Finished file path checking
--- Starting image file verification ---
Checking image file names
Locating image files and validating name syntax
Verifying image file locations
Inspecting image file types
Processing image file constraints
Creating candidate provisioning file
Finished image file verification
--- Starting candidate package set construction ---
Verifying existing software set
Processing candidate provisioning file
Constructing working set for candidate package set
Constructing working set for running package set
Checking command output
Constructing merge of running and candidate packages
Checking if resulting candidate package set would be complete
Finished candidate package set construction
--- Starting compatibility testing ---
Determining whether candidate package set is compatible
WARNING:
WARNING: Candidate software combination not found in compatibility database
WARNING:
Determining whether installation is valid
Software sets are identified as compatible
Verifying image type compatibility
Checking IPC compatibility with running software
Checking candidate package set infrastructure compatibility
Checking infrastructure compatibility with running software
Checking package specific compatibility
Finished compatibility testing
--- Starting impact testing ---
Checking operational impact of change
WARNING: Connection may be lost during installation of IOS package
Finished impact testing
--- Starting list of software package changes ---
Old files list:
 Removed asr1001-rpaccess.03.02.01.S.151-1.S1.pkg
 Removed asr1001-rpcontrol.03.02.01.S.151-1.S1.pkg
 Removed asr1001-rpios-universalk9.03.02.01.S.151-1.S1.pkg
No new package files added
Finished list of software package changes
--- Starting commit of software changes ---
Updating provisioning rollback files

```

```

Creating pending provisioning file
Committing provisioning file
Finished commit of software changes
--- Starting analysis of software changes ---
Finished analysis of software changes
--- Starting update running software ---
Blocking peer synchronization of operating information
Creating the command set placeholder directory
 Finding latest command set
 Finding latest command shortlist lookup file
 Finding latest command shortlist file
 Assembling CLI output libraries
 Assembling CLI input libraries
 Assembling Dynamic configuration files
 Applying interim IPC and database definitions
 Replacing running software
 Replacing CLI software
 Restarting software
 Restarting IOS PID: 20548, in slot/bay 0/0
*Mar 15 16:36:14.365: %REDUNDANCY-3-STANDBY_LOST: Standby processor fault (PEER_NOT_PRESENT)

*Mar 15 16:36:14.365: %REDUNDANCY-3-STANDBY_LOST: Standby processor fault (PEER_DOWN)
*Mar 15 16:36:14.365: %REDUNDANCY-3-STANDBY_LOST: Standby processor fault
(P_EER_REDUNDANCY_STATE_CHANGE)
*Mar 15 16:36:16.558: %RF-5-RF_RELOAD: Peer reload. Reason: EHSA standby down
*Mar 15 16:36:49.365: %REDUNDANCY-5-PEER_MONITOR_EVENT: Active detected a standby insertion
(raw-event=PEER_FOUND(4))
*Mar 15 16:36:49.365: %REDUNDANCY-5-PEER_MONITOR_EVENT: Active detected a standby insertion
(raw-event=PEER_REDUNDANCY_STATE_CHANGE(5))
Notifying running software of updates
 Unblocking peer synchronization of operating information
Unmounting old packages
Cleaning temporary installation files
 Finished update running software

SUCCESS: Finished installing software.
Router#issu commitversion

--- Starting local lock acquisition on R0 ---
Finished local lock acquisition on R0
--- Starting installation changes ---
Cancelling rollback timer
Finished installation changes
SUCCESS: Installation changes committed
Router#issu loadversion rp 0 file
bootflash:221subs/asr1001-{rpbase,sipbase,sipspa,espbase}*03.02.01.S.151-1.S1_2.pkg force
--- Starting local lock acquisition on R0 ---
Finished local lock acquisition on R0
--- Starting file path checking ---
Finished file path checking
--- Starting image file verification ---
Checking image file names
Locating image files and validating name syntax
Verifying image file locations
Inspecting image file types
 WARNING: In-service installation of RP Base package
 WARNING: requires software reboot of target RP
 WARNING: Automatically setting the on-reboot flag
Processing image file constraints
Creating candidate provisioning file
Finished image file verification
--- Starting candidate package set construction ---
Verifying existing software set
Processing candidate provisioning file

```

```

Constructing working set for candidate package set
Constructing working set for running package set
Checking command output
Constructing merge of running and candidate packages
Checking if resulting candidate package set would be complete
Finished candidate package set construction
--- Starting compatibility testing ---
Determining whether candidate package set is compatible
Determining whether installation is valid
Determining whether installation is valid ... skipped
Verifying image type compatibility
Checking IPC compatibility for candidate software
Checking candidate package set infrastructure compatibility
Checking infrastructure compatibility with running software
Checking infrastructure compatibility with running software ... skipped
Checking package specific compatibility
Finished compatibility testing
--- Starting list of software package changes ---
Old files list:
 Removed asr1001-espbase.03.02.01.S.151-1.S1.pkg
 Removed asr1001-rpbase.03.02.01.S.151-1.S1.pkg
 Removed asr1001-sipbase.03.02.01.S.151-1.S1.pkg
 Removed asr1001-sipspa.03.02.01.S.151-1.S1.pkg
New files list:
 Added asr1001-espbase.03.02.01.S.151-1.S1_2.pkg
 Added asr1001-rpbase.03.02.01.S.151-1.S1_2.pkg
 Added asr1001-sipbase.03.02.01.S.151-1.S1_2.pkg
 Added asr1001-sipspa.03.02.01.S.151-1.S1_2.pkg
Finished list of software package changes
--- Starting commit of software changes ---
Updating provisioning rollback files
Creating pending provisioning file
Committing provisioning file
Finished commit of software changes
SUCCESS: Software provisioned. New software will load on reboot.
Router# reload
Router#issu loadversion rp 0 file bootflash:221subs/asr1001-{rpbase,sipspa,espbase}
*20160311_012910_V16_2_0_318_2.SSA.pkg force
--- Starting local lock acquisition on R0 ---
Finished local lock acquisition on R0
--- Starting file path checking ---
Finished file path checking
--- Starting image file verification ---
Checking image file names
Locating image files and validating name syntax
 Found asr1002x-rpbase.BLD_V162_1_THROTTLE_LATEST_20160311_012910_V16_2_0_318_2.SSA.pkg
 Found asr1002x-rpboot.BLD_V162_1_THROTTLE_LATEST_20160311_012910_V16_2_0_318_2.SSA.pkg
 Found asr1002x-sipbase.BLD_V162_1_THROTTLE_LATEST_20160311_012910_V16_2_0_318_2.SSA.pkg
 Found asr1002x-sipspa.BLD_V162_1_THROTTLE_LATEST_20160311_012910_V16_2_0_318_2.SSA.pkg
 Found asr1002x-espbase.BLD_V162_1_THROTTLE_LATEST_20160311_012910_V16_2_0_318_2.SSA.pkg
Verifying image file locations
Inspecting image file types
 WARNING: In-service installation of RP Boot package
 WARNING: requires software reboot of target RP
 WARNING: Automatically setting the on-reboot flag
 WARNING: In-service installation of RP Base package
 WARNING: requires software reboot of target RP
Processing image file constraints
Creating candidate provisioning file
Finished image file verification
--- Starting candidate package set construction ---
Verifying existing software set
Processing candidate provisioning file
Constructing working set for candidate package set

```

```
Constructing working set for running package set
Checking command output
Constructing merge of running and candidate packages
Checking if resulting candidate package set would be complete
Finished candidate package set construction
--- Starting ISSU compatibility verification ---
WARNING:
WARNING: ISSU between engineering builds with release strings in non-standard format.
Skipping ISSU Software Compatibility checks.
WARNING:
WARNING:
WARNING: ISSU between engineering builds with release strings in non-standard format.
Skipping ISSU Software Compatibility checks.
WARNING:
WARNING:
WARNING: ISSU between engineering builds with release strings in non-standard format.
Skipping ISSU Software Compatibility checks.
WARNING:
WARNING:
WARNING: ISSU between engineering builds with release strings in non-standard format.
Skipping ISSU Software Compatibility checks.
WARNING:
WARNING:
WARNING: ISSU between engineering builds with release strings in non-standard format.
Skipping ISSU Software Compatibility checks.
WARNING:
WARNING:
WARNING: ISSU between engineering builds with release strings in non-standard format.
Skipping ISSU Software Compatibility checks.
WARNING:
WARNING:
WARNING: ISSU between engineering builds with release strings in non-standard format.
Skipping ISSU Software Compatibility checks.
WARNING:
WARNING:
WARNING: ISSU between engineering builds with release strings in non-standard format.
Skipping ISSU Software Compatibility checks.
WARNING:
WARNING:
WARNING: ISSU between engineering builds with release strings in non-standard format.
Skipping ISSU Software Compatibility checks.
WARNING:
WARNING:
WARNING: ISSU between engineering builds with release strings in non-standard format.
Skipping ISSU Software Compatibility checks.
WARNING:
WARNING:
WARNING: ISSU between engineering builds with release strings in non-standard format.
Skipping ISSU Software Compatibility checks.
WARNING:
WARNING:
WARNING: ISSU between engineering builds with release strings in non-standard format.
Skipping ISSU Software Compatibility checks.
WARNING:
WARNING:
WARNING: ISSU between engineering builds with release strings in non-standard format.
Skipping ISSU Software Compatibility checks.
WARNING:
WARNING:
WARNING: ISSU between engineering builds with release strings in non-standard format.
Skipping ISSU Software Compatibility checks.
WARNING:
WARNING:
WARNING: ISSU between engineering builds with release strings in non-standard format.
Skipping ISSU Software Compatibility checks.
WARNING:
WARNING:
WARNING: ISSU between engineering builds with release strings in non-standard format.
Skipping ISSU Software Compatibility checks.
WARNING:
WARNING:
WARNING: ISSU between engineering builds with release strings in non-standard format.
Skipping ISSU Software Compatibility checks.
WARNING:
WARNING:
WARNING: ISSU between engineering builds with release strings in non-standard format.
Skipping ISSU Software Compatibility checks.
```



```
Skipping ISSU Software Compatibility checks.
WARNING:
WARNING:
WARNING: ISSU between engineering builds with release strings in non-standard format.
Skipping ISSU Software Compatibility checks.
WARNING:
WARNING:
WARNING: ISSU between engineering builds with release strings in non-standard format.
Skipping ISSU Software Compatibility checks.
WARNING:
WARNING:
WARNING: ISSU between engineering builds with release strings in non-standard format.
Skipping ISSU Software Compatibility checks.
WARNING:
WARNING:
WARNING: ISSU between engineering builds with release strings in non-standard format.
Skipping ISSU Software Compatibility checks.
WARNING:
WARNING:
WARNING: ISSU between engineering builds with release strings in non-standard format.
Skipping ISSU Software Compatibility checks.
WARNING:
WARNING:
WARNING: ISSU between engineering builds with release strings in non-standard format.
Skipping ISSU Software Compatibility checks.
WARNING:
Verifying image type compatibility
Checking IPC compatibility for candidate software
Checking candidate package set infrastructure compatibility
Checking infrastructure compatibility with running software
Checking infrastructure compatibility with running software ... skipped
Checking package specific compatibility
Finished ISSU compatibility verification
--- Starting list of software package changes ---
Old files list:
 Removed asr1002x-espbase.BLD_V162_1_THROTTLE_LATEST_20160311_012910_V16_2_0_318.SSA.pkg
 Removed asr1002x-rpbase.BLD_V162_1_THROTTLE_LATEST_20160311_012910_V16_2_0_318.SSA.pkg
 Removed asr1002x-rpboot.BLD_V162_1_THROTTLE_LATEST_20160311_012910_V16_2_0_318.SSA.pkg
 Removed asr1002x-sipbase.BLD_V162_1_THROTTLE_LATEST_20160311_012910_V16_2_0_318.SSA.pkg
 Removed asr1002x-sipspsa.BLD_V162_1_THROTTLE_LATEST_20160311_012910_V16_2_0_318.SSA.pkg
New files list:
 Added asr1002x-espbase.BLD_V162_1_THROTTLE_LATEST_20160311_012910_V16_2_0_318_2.SSA.pkg
 Added asr1002x-rpbase.BLD_V162_1_THROTTLE_LATEST_20160311_012910_V16_2_0_318_2.SSA.pkg
 Added asr1002x-rpboot.BLD_V162_1_THROTTLE_LATEST_20160311_012910_V16_2_0_318_2.SSA.pkg
 Added asr1002x-sipbase.BLD_V162_1_THROTTLE_LATEST_20160311_012910_V16_2_0_318_2.SSA.pkg
 Added asr1002x-sipspsa.BLD_V162_1_THROTTLE_LATEST_20160311_012910_V16_2_0_318_2.SSA.pkg
Finished list of software package changes
--- Starting commit of software changes ---
Updating provisioning rollback files
Creating pending provisioning file
Committing provisioning file
Finished commit of software changes
SUCCESS: Software provisioned. New software will load on reboot.
```

## Using Subpackages for Software Upgrade on a Cisco ASR 1002 Router or Cisco ASR 1004 Router (software upgrade Command Set)

This section provides instructions on using software upgrade for Cisco ASR 1002 or 1004 Router running subpackages. Cisco ASR 1002 Router is not supported on Polaris 16.x.x release.

These instructions assume two IOS processes are active on the RP and that the router is already running using subpackages.



**Note** Step 17, 18, and 19 does not have to be performed immediately, and can be done at a convenient time.

## SUMMARY STEPS

1. **show version**
2. **redundancy**
3. **mkdir** *URL-to-directory-name*
4. **ip tftp** *source-interface gigabitethernet port*
5. **copy tftp:** *URL-to-target-location*
6. **request platform software package expand file** *URL-to-consolidated-package*
7. **dir** *target-URL*
8. **copy** *file-system:asr1000rp2-espbase.version.pkg URL-to-directory-of-sub-packages-active-RP*
9. **issu loadversion rp 0 file***file-system:asr1000rp2-{rpaccess,rpios,rpcontrol}\*version-string\*.pkg baystandby-bayforce*
10. **issu commitversion**
11. **redundancy force-switchover**
12. **show platform**
13. **issu loadversion rp 0 file***file-system:asr1000rp2-{rpaccess,rpios,rpcontrol}\*version-string\*.pkg baystandby-bayforce*
14. **issu commitversion**
15. **issu loadversion rp 0 file** *file-system:asr1000rp2-{sipbase,sipsa}\*version\*.pkg slot SIP-slot-number force*
16. **issu loadversion rp 0 file** *file-system:asr1000rp2-{elcbase,elcspa}\*version\*.pkg slot SIP-slot-number force*
17. **issu loadversion rp 0 file** *file-system:asr1000rp2-esp\*version\*.pkg force*
18. **issu loadversion rp 0 file***file-system:asr1000rp\*version\*.pkg*
19. **show version installed**
20. **reload**
21. **request platform software package clean**

## DETAILED STEPS

|        | Command or Action                                                                                                                                                                                   | Purpose                                                                                                                                                                                                                                                                                                                                                                                                                                                                                  |
|--------|-----------------------------------------------------------------------------------------------------------------------------------------------------------------------------------------------------|------------------------------------------------------------------------------------------------------------------------------------------------------------------------------------------------------------------------------------------------------------------------------------------------------------------------------------------------------------------------------------------------------------------------------------------------------------------------------------------|
| Step 1 | <pre>show version</pre> <p><b>Example:</b></p> <pre>show version installed</pre> <p><b>Example:</b></p> <pre>dir filesystem:&lt;directory&gt;</pre> <p><b>Example:</b></p> <pre>show platform</pre> | <p>(Optional) Use the following commands to confirm the current router configuration, as follows:</p> <ul style="list-style-type: none"> <li>• <b>show version</b> and <b>show version active-rp installed</b>—Verify the running version of the Cisco IOS XE software on the router, and which file was used to boot the router, and where that file is stored.</li> <li>• <b>dir</b>—Confirm that the files that were used to boot the router are located in the directory.</li> </ul> |

|               | Command or Action                                                                                                                                                                                                                                                                                                                                                     | Purpose                                                                                                                                                                                                                                                                            |
|---------------|-----------------------------------------------------------------------------------------------------------------------------------------------------------------------------------------------------------------------------------------------------------------------------------------------------------------------------------------------------------------------|------------------------------------------------------------------------------------------------------------------------------------------------------------------------------------------------------------------------------------------------------------------------------------|
|               | <p><b>Example:</b></p> <pre>show redundancy-states</pre> <p><b>Example:</b></p> <pre>Router# show version</pre> <p><b>Example:</b></p> <pre>Router# show version r0 installed</pre> <p><b>Example:</b></p> <pre>Router# dir bootflash:</pre> <p><b>Example:</b></p> <pre>Router# show platform</pre> <p><b>Example:</b></p> <pre>Router# show redundancy-states</pre> | <ul style="list-style-type: none"> <li>• <b>show platform</b>—Confirm the current status of the active and standby RPs.</li> <li>• <b>show redundancy states</b>—Confirm the operational and configured redundancy states.</li> </ul>                                              |
| <b>Step 2</b> | <p><b>redundancy</b></p> <p><b>Example:</b></p> <pre>mode sso</pre> <p><b>Example:</b></p> <pre>Router(config)# redundancy</pre> <p><b>Example:</b></p> <pre>Router(config-red)# mode sso</pre>                                                                                                                                                                       | <p>Configure SSO if it is not already configured.</p> <p><b>Note</b> Save the configuration after making this configuration step.</p>                                                                                                                                              |
| <b>Step 3</b> | <p><b>mkdir</b> <i>URL-to-directory-name</i></p> <p><b>Example:</b></p> <pre>Router# mkdir usb0:221subs</pre>                                                                                                                                                                                                                                                         | <p>Create a directory to store the consolidated package and subpackages.</p> <p>This directory must be created in most cases because the consolidated packages and subpackages have to be separated from the subpackages that booted the router at this step of the procedure.</p> |
| <b>Step 4</b> | <p><b>ip tftp</b> <i>source-interface gigabitethernet port</i></p> <p><b>Example:</b></p> <pre>Router(config)# ip tftp source-interface gigabitethernet 0</pre>                                                                                                                                                                                                       | <p>Specifies the Gigabit Ethernet TFTP source-interface to be configured:</p> <p>slot/port—Specifies the location of the TFTP source-interface.</p>                                                                                                                                |

|               | Command or Action                                                                                                                                                                                                                                                                                                                                                                          | Purpose                                                                                                                                                                                                                                                                                                                                                                                                                                                                                                                                     |
|---------------|--------------------------------------------------------------------------------------------------------------------------------------------------------------------------------------------------------------------------------------------------------------------------------------------------------------------------------------------------------------------------------------------|---------------------------------------------------------------------------------------------------------------------------------------------------------------------------------------------------------------------------------------------------------------------------------------------------------------------------------------------------------------------------------------------------------------------------------------------------------------------------------------------------------------------------------------------|
|               |                                                                                                                                                                                                                                                                                                                                                                                            | <p><b>Note</b> To copy a file using TFTP through the Management Ethernet interface, the <b>ip tftp source-interface GigabitEthernet 0</b> command must be entered before entering the <b>copy tftp</b> command.</p>                                                                                                                                                                                                                                                                                                                         |
| <b>Step 5</b> | <p><b>copy tftp:</b> <i>URL-to-target-location</i></p> <p><b>Example:</b></p> <pre>Router# copy tftp: usb0:221subs</pre>                                                                                                                                                                                                                                                                   | <p>Copy the consolidated package file into the directory created in <a href="#">Step 3</a> .</p> <p>The consolidated package in this step should not be copied into the same directory where the subpackages that are currently running your router are stored (the directory containing the packages.conf provisioning file from which the router was booted).</p> <p><b>Tip</b> It is recommended that you copy the package onto a usb: or harddisk: file system for space considerations when performing this step of the procedure.</p> |
| <b>Step 6</b> | <p><b>request platform software package expand file</b><br/><i>URL-to-consolidated-package</i></p> <p><b>Example:</b></p> <p>(Optional) <b>dir</b> <i>target-URL</i></p> <p><b>Example:</b></p> <pre>Router# request platform software package expand file usb0:221subs/asr1000rp2-enterprise9.03.13.00.S.154-3.S-ext.bin</pre> <p><b>Example:</b></p> <pre>Router# dir usb0:221subs</pre> | <p>Extract the subpackages out of the consolidated package file into the temporary directory.</p> <p><b>Note</b> Take extra care to extract the subpackages to a temporary subdirectory and do not delete any of the files currently running the router at this point of the procedure. To erase the files that were running on the router before the ISSU upgrade, enter the <b>request platform software package clean</b> command after the ISSU upgrade has been completed.</p>                                                         |
| <b>Step 7</b> | <p><b>dir</b> <i>target-URL</i></p> <p><b>Example:</b></p> <pre>Router# dir usb0:221subs</pre>                                                                                                                                                                                                                                                                                             | <p>(Optional) Display the directory to confirm that the files were extracted.</p>                                                                                                                                                                                                                                                                                                                                                                                                                                                           |
| <b>Step 8</b> | <p><b>copy file-system:asr1000rp2-espbase.version.pkg</b><br/><i>URL-to-directory-of-sub-packages-active-RP</i></p> <p><b>Example:</b></p> <pre>copy file-system:asr1000rp2-esp86base.version.pkg URL-to-directory-of-sub-packages-active-RP</pre> <p><b>Example:</b></p>                                                                                                                  | <p>Copy the subpackages out of the temporary directory into the directory on the router where the subpackages running the active RP are currently stored.</p>                                                                                                                                                                                                                                                                                                                                                                               |

|  | Command or Action                                                                                                                                                                                                                                                                                                                                                                                                                                                                                                                                                                                                                                                                                                                                                                                                                                                                                                                                                                                                                                                                                                                                                                                                                                                                                                                                                                                                                                                                                                                            | Purpose |
|--|----------------------------------------------------------------------------------------------------------------------------------------------------------------------------------------------------------------------------------------------------------------------------------------------------------------------------------------------------------------------------------------------------------------------------------------------------------------------------------------------------------------------------------------------------------------------------------------------------------------------------------------------------------------------------------------------------------------------------------------------------------------------------------------------------------------------------------------------------------------------------------------------------------------------------------------------------------------------------------------------------------------------------------------------------------------------------------------------------------------------------------------------------------------------------------------------------------------------------------------------------------------------------------------------------------------------------------------------------------------------------------------------------------------------------------------------------------------------------------------------------------------------------------------------|---------|
|  | <p><b>copy</b><br/> <i>file-system: asr1000rp2-rpaccess .version.pkg</i><br/> <i>URL-to-directory-of-sub-packages-active-RP</i></p> <p><b>Example:</b></p> <p><b>copy</b><br/> <i>file-system: asr1000rp2-rpbase .version.pkg</i><br/> <i>URL-to-directory-of-sub-packages-active-RP</i></p> <p><b>Example:</b></p> <p><b>copy</b><br/> <i>file-system: asr1000rp2-rpcontrol .version.pkg</i><br/> <i>URL-to-directory-of-sub-packages-active-RP</i></p> <p><b>Example:</b></p> <p><b>copy</b><br/> <i>file-system: asr1000rp2-rpios .version.pkg</i><br/> <i>URL-to-directory-of-sub-packages-active-RP</i></p> <p><b>Example:</b></p> <p><b>copy</b><br/> <i>file-system: asr1000rp2-sipbase .version.pkg</i><br/> <i>URL-to-directory-of-sub-packages-active-RP</i></p> <p><b>Example:</b></p> <p><b>copy</b><br/> <i>file-system: asr1000rp2-sipsa .version.pkg</i><br/> <i>URL-to-directory-of-sub-packages-active-RP</i></p> <p><b>Example:</b></p> <p><b>copy</b><br/> <i>file-system: asr1000rp2-elcbase .version.pkg</i><br/> <i>URL-to-directory-of-sub-packages-active-RP</i></p> <p><b>Example:</b></p> <p><b>copy</b><br/> <i>file-system: asr1000rp2-elcspa .version.pkg</i><br/> <i>URL-to-directory-of-sub-packages-active-RP</i></p> <p><b>Example:</b></p> <pre>Router# copy usb0:221sub/asr1000rp2-espbase.03.13.00.S.154-3.S-ext.pkg bootflash:</pre> <p><b>Example:</b></p> <pre>Router# copy usb0:221sub/asr1000rp2-espbase.03.13.00.S.154-3.S-ext.pkg bootflash:</pre> <p><b>Example:</b></p> <pre>Router# copy</pre> |         |

|               | Command or Action                                                                                                                                                                                                                                                                                                                                                                                                                                                                                                                                                                                                                                                                                                                                                            | Purpose                                                                     |
|---------------|------------------------------------------------------------------------------------------------------------------------------------------------------------------------------------------------------------------------------------------------------------------------------------------------------------------------------------------------------------------------------------------------------------------------------------------------------------------------------------------------------------------------------------------------------------------------------------------------------------------------------------------------------------------------------------------------------------------------------------------------------------------------------|-----------------------------------------------------------------------------|
|               | <pre>usb0:221subs/asr1000rp2-rpaccess.03.13.00.S.154-3.S-ext.pkg bootflash:  Example:  Router# copy usb0:221subs/asr1000rp2-rpbase.03.13.00.S.154-3.S-ext.pkg bootflash:  Example:  Router# copy usb0:221subs/asr1000rp2-rpcontrol.03.13.00.S.154-3.S-ext.pkg bootflash:  Example:  Router# copy usb0:221subs/asr1000rp2-rpios-enterprise9.03.13.00.S.154-3.S-ext.pkg bootflash:  Example:  Router# copy usb0:221subs/asr1000rp2-sipbase.03.13.00.S.154-3.S-ext.pkg bootflash:  Example:  Router# copy usb0:221subs/asr1000rp2-sipspa.03.13.00.S.154-3.S-ext.pkg bootflash:  Example:  Router# copy usb0:221subs/asr1000rp2-elcbase.03.13.00.S.154-3.S-ext.pkg bootflash:  Example:  Router# copy usb0:221subs/asr1000rp2-elcspa.03.13.00.S.154-3.S-ext.pkg bootflash:</pre> |                                                                             |
| <b>Step 9</b> | <pre>issu loadversion rp 0 file-system:asr1000rp2-{rpaccess,rpios,rpcontrol}*version-string*.pkg baystandby-bayforce  Example:  Router# issu loadversion rp 0 file</pre>                                                                                                                                                                                                                                                                                                                                                                                                                                                                                                                                                                                                     | Upgrade the RPAccess, RPIOS, and RPCControl subpackages in the standby bay. |

|                | Command or Action                                                                                                                                                                                                                                                                                          | Purpose                                                                                                                                                                                                                                                                                                                                                             |
|----------------|------------------------------------------------------------------------------------------------------------------------------------------------------------------------------------------------------------------------------------------------------------------------------------------------------------|---------------------------------------------------------------------------------------------------------------------------------------------------------------------------------------------------------------------------------------------------------------------------------------------------------------------------------------------------------------------|
|                | <del>hotflash100rp2-{raccess,rpios,rpcontrol}*03.13.00.S.154-3.Soft*.pkg<br/>bay 1 force</del>                                                                                                                                                                                                             |                                                                                                                                                                                                                                                                                                                                                                     |
| <b>Step 10</b> | <b>issu commitversion</b><br><b>Example:</b><br>Router# <b>issu commitversion</b>                                                                                                                                                                                                                          | Once the SSO state is reached, commit the software version.                                                                                                                                                                                                                                                                                                         |
| <b>Step 11</b> | <b>redundancy force-switchover</b><br><b>Example:</b><br><b>Example:</b><br>Router# <b>redundancy force-switchover</b>                                                                                                                                                                                     | Force a switchover from the active IOS process to the standby IOS process.<br><b>Note</b> Your connection to the router often drops and is expected behavior at this point of the procedure in many scenarios.If this step drops your connection to the router, wait a few minutes before reconnecting to the router and then continue to <a href="#">Step 12</a> . |
| <b>Step 12</b> | <b>show platform</b><br><b>Example:</b><br>Router# <b>show platform</b>                                                                                                                                                                                                                                    | (Optional) Monitor system state to ensure both IOS processes are active.                                                                                                                                                                                                                                                                                            |
| <b>Step 13</b> | <b>issu loadversion rp 0</b><br><del>file-system:asr1000rp2-{raccess,rpios,rpcontrol}*version-string*.pkg<br/>bay standby-bayforce</del><br><b>Example:</b><br>Router# <b>issu loadversion rp 0 file</b><br><del>hotflash100rp2-{raccess,rpios,rpcontrol}*03.13.00.S.154-3.Soft*.pkg<br/>bay 0 force</del> | Upgrade the RPAccess, RPIOS, and RPCControl subpackages in the standby bay (a different bay than in <a href="#">Step 9</a> ).                                                                                                                                                                                                                                       |
| <b>Step 14</b> | <b>issu commitversion</b><br><b>Example:</b><br>Router# <b>issu commitversion</b>                                                                                                                                                                                                                          | Commit the software version.                                                                                                                                                                                                                                                                                                                                        |
| <b>Step 15</b> | <b>issu loadversion rp 0 file</b><br><i>file-system:asr1000rp2-{sipbase,sipspa}*version*.pkg</i><br><b>slot SIP-slot-number force</b><br><b>Example:</b><br><b>issu commitversion</b>                                                                                                                      | Upgrade the SIP and SPA subpackages for each SIP on the router.<br><b>Note</b> This step must be completed one SIP at a time, and repeated for each SIP installed on the router before performing the next step.                                                                                                                                                    |

|         | Command or Action                                                                                                                                                                                                                                                                                                                                                                                                                                                                                                                                                                                                                                  | Purpose                                                                                                                                                                                                                                                                                                                                                                                                                                                                                                                                                                                                                                                                                                        |
|---------|----------------------------------------------------------------------------------------------------------------------------------------------------------------------------------------------------------------------------------------------------------------------------------------------------------------------------------------------------------------------------------------------------------------------------------------------------------------------------------------------------------------------------------------------------------------------------------------------------------------------------------------------------|----------------------------------------------------------------------------------------------------------------------------------------------------------------------------------------------------------------------------------------------------------------------------------------------------------------------------------------------------------------------------------------------------------------------------------------------------------------------------------------------------------------------------------------------------------------------------------------------------------------------------------------------------------------------------------------------------------------|
|         | <p><b>Example:</b></p> <pre>Router# issu loadversion rp 0 file bootflash:asr1000rp2-{sipspa,sipbase}*03.13.00.S.154-3.S-ext*.pkg slot 0 force</pre> <p><b>Example:</b></p> <pre>Router# issu commitversion</pre> <p><b>Example:</b></p> <pre>Router# issu loadversion rp 0 file bootflash:asr1000rp2-{sipspa,sipbase}*03.13.00.S.154-3.S-ext*.pkg slot 1 force</pre> <p><b>Example:</b></p> <pre>Router# issu commitversion</pre> <p><b>Example:</b></p> <pre>Router# issu loadversion rp 0 file bootflash:asr1000rp2-{sipspa,sipbase}*03.13.00.S.154-3.S-ext*.pkg slot 2 force</pre> <p><b>Example:</b></p> <pre>Router# issu commitversion</pre> | <p><b>Tip</b> You can use the <b>show ip interface brief</b> command to identify which slots contain SIPs and SPAs. The interfaces with three numbers (in the form <i>SIP-number/SPA-number/interface-number</i>) identify the SIP and SPA locations in the router.</p> <p><b>Note</b> The <i>pattern</i> options used in this CLI (<b>sipbase</b> and <b>sipspa</b>) were introduced in Cisco IOS XE Release 2.1.2 and are not available in previous Cisco IOS XE Releases. See the <a href="#">ISSU Procedures (Prior to Cisco IOS XE Release 2.1.2)</a>, on page 157 for pre-Cisco IOS XE Release 2.1.2 ISSU upgrade procedures.</p>                                                                        |
| Step 16 | <pre>issu loadversion rp 0 file file-system:asr1000rp2-{elcbase,elcspa}*version*.pkg slot SIP-slot-number force</pre> <p><b>Example:</b></p> <pre>issu commitversion</pre> <p><b>Example:</b></p> <p>Repeat this step for each ELC installed in your router before proceeding to the next step.</p> <p><b>Example:</b></p> <pre>Router# issu loadversion rp 0 file bootflash:asr1000rp2-{elcspa,elcbase}*03.13.00.S.154-3.S-ext*.pkg slot 0 force</pre> <p><b>Example:</b></p> <pre>Router# issu commitversion</pre> <p><b>Example:</b></p>                                                                                                        | <p>Upgrade the ELC and SPA subpackages for each ELC on the router.</p> <p><b>Note</b> This step must be completed for one ELC at a time, and repeated for each ELC installed on the router before performing the next step.</p> <p><b>Tip</b> You can use the <b>show ip interface brief</b> command to identify which slots contain ELCs and SPAs. The interfaces with three numbers (in the form <i>ELC-number/SPA-number/interface-number</i>) identify the ELC and SPA locations in the router.</p> <p><b>Note</b> The <i>pattern</i> options used in this CLI (<b>elcbase</b> and <b>elcspa</b>) were introduced in Cisco IOS XE Release 3.10Sand are not available in previous Cisco IOS XE Releases</p> |



|                | Command or Action                                                                                                                                                                                                                                                                                                                   | Purpose                                                                                                                                                                                                                                                                                                                                    |
|----------------|-------------------------------------------------------------------------------------------------------------------------------------------------------------------------------------------------------------------------------------------------------------------------------------------------------------------------------------|--------------------------------------------------------------------------------------------------------------------------------------------------------------------------------------------------------------------------------------------------------------------------------------------------------------------------------------------|
|                | <pre>Router# issu loadversion rp 0 file bootflash:asr1000rp2-(elcsp,elcbase)*03.13.00.S.154-3.S-ext*.pkg slot 1 force  Example:  Router# issu commitversion  Example:  Router# issu loadversion rp 0 file bootflash:asr1000rp2-(elcsp,elcbase)*03.13.00.S.154-3.S-ext*.pkg slot 2 force  Example:  Router# issu commitversion</pre> |                                                                                                                                                                                                                                                                                                                                            |
| <b>Step 17</b> | <pre>issu loadversion rp 0 file file-system:asr1000rp2-esp*version*.pkg force  Example:  issu commitversion  Example:  Router# issu loadversion rp 0 file bootflash:asr1000rp2-esp*03.13.00.S.154-3.S-ext*.pkg force  Example:  Router# issu commitversion</pre>                                                                    | Upgrades the ESP Base subpackage and Commits the ESP Base software.                                                                                                                                                                                                                                                                        |
| <b>Step 18</b> | <pre>issu loadversion rp 0 filefile-system:asr1000rp*version*.pkg  Example:  issu commitversion  Example:  Router# issu loadversion rp 0 file bootflash:asr1000rp*03.13.00.S.154-3.S-ext*.pkg  Example:  Router# issu commitversion</pre>                                                                                           | <p>Upgrades all subpackages, including the RPBase subpackage, which is the last subpackage that needs to be upgraded.</p> <p><b>Note</b> This step is required to ensure that all subpackages on the router were upgraded as part of this procedure, and might upgrade some subpackages that would otherwise be missed in the process.</p> |
| <b>Step 19</b> | <pre>show version installed  Example:</pre>                                                                                                                                                                                                                                                                                         | (Optional) Verify that the subpackages are properly installed.                                                                                                                                                                                                                                                                             |

|                | Command or Action                                                 | Purpose                                                                                                                                                                                 |
|----------------|-------------------------------------------------------------------|-----------------------------------------------------------------------------------------------------------------------------------------------------------------------------------------|
|                | Router# <b>show version installed</b>                             |                                                                                                                                                                                         |
| <b>Step 20</b> | <b>reload</b><br><br><b>Example:</b><br><br>Router# <b>reload</b> | Reload the RP.<br><br><b>Tip</b> The router will continue normal operation even without a reload, so you can reload the router during scheduled maintenance or a slower traffic period. |
| <b>Step 21</b> | <b>request platform software package clean</b>                    | (Optional) Removes the unused subpackages from the router.                                                                                                                              |

## Examples

The following example shows the software upgrade for Cisco ASR 1002 or 1004 Router running sub-packages:

```

Router# show version
Cisco IOS Software, IOS-XE Software (X86_64_LINUX_IOSD-ADVENTERPRISEK9-M), Version 15.3(2)S,
 RELEASE SOFTWARE (fc1)
<output removed for brevity>
System image file is "bootflash:Active_Dir/packages.conf"
<output removed for brevity>
Router# show platform

Chassis type: ASR1004
Slot Type State Insert time (ago)

0 ASR1000-2T+20X1GE ok 00:04:19
0/0 BUILT-IN-2T+20X1GE ok 00:02:36
1 ASR1000-SIP10 ok 00:04:19
1/0 SPA-2X1GE-V2 ok 00:03:07
1/1 SPA-10X1GE-V2 ok 00:03:00
R0 ASR1000-RP2 ok 00:04:19
R0/0 ok, active 00:04:19
R0/1 ok, standby 00:02:41
F0 ASR1000-ESP40 ok, active 00:04:19
P0 ASR1004-PWR-AC ok 00:03:28
P1 ASR1004-PWR-AC ps, fail 00:03:28
Slot CPLD Version Firmware Version

0 00200800 15.2(1r)S
1 07091401 15.3(3r)S
R0 08103002 15.3(3r)S
F0 1003190E 15.3(3r)S
Router# show version installed

Package: Provisioning File, version: n/a, status: active
 File: bootflash:Active_Dir/packages.conf, on: RP0
 Built: n/a, by: n/a
 File SHA1 checksum: a624f70f68c60292f4482433f43afd92487a55c4
Package: rpbases, version: 03.12.01.S.154-2.S,
status: active
 File: bootflash:Active_Dir/asr1000rp2-rpbases.03.12.01.S.154-2.S.pkg,
on: RP0 Built: 2013-03-25_18.48, by: mcpre

File SHA1 checksum: 3a9675142898cfac350d4e42f0e37bd9f4e48538
Package: rpcontrol, version: 03.12.01.S.154-2.S,

```

```

status: active

File: bootflash:Active_Dir/asr1000rp2-rpcontrol.03.12.01.S.154-2.S.pkg,
on: RP0/0 Built: 2013-03-25_18.48, by: mcpre

File SHA1 checksum: 87b11f863f67fdf2610ee0769b929baab4c3efad
<output removed for brevity>
Router#show redundancy states
my state = 13 -ACTIVE
peer state = 8 -STANDBY HOT
Mode = Duplex
Unit = Primary
Unit ID = 48
Redundancy Mode (Operational) = sso
Redundancy Mode (Configured) = sso
Redundancy State = sso
Maintenance Mode = Disabled
Manual Swact = enabled
Communications = Up
client count = 107
client_notification_TMR = 30000 milliseconds
RF debug mask = 0x0
Router# mkdir bootflash:harddisk:Target_Subs
Create directory filename [Target_Subs]?
Created dir harddisk:/Target_SubsRouter
Router(config)# ip tftp source-interface gigabitethernet 0
Router# copy tftp: harddisk:Target_Subs
Address or name of remote host []? 202.153.144.25
Source filename []? /auto/tftp-srg-india/asr1000rp2-adventerprisek9.03.13.00.S.154-3.S-ext.bin
destination filename [/Target_Subs/asr1000rp2-adventerprisek9.03.13.00.S.154-3.S-ext.bin]?
accessing
tftp://202.153.144.25//auto/tftp-srg-india/asr1000rp2-adventerprisek9.03.13.00.S.154-3.S-ext.bin...
loading /auto/tftp-srg-india/asr1000rp2-adventerprisek9.03.13.00.S.154-3.S-ext.bin from
202.153.144.25 (via GigabitEthernet0): !!!!!!!
[OK - 569597380 bytes]
569597380 bytes copied in 101.618 secs
(5605280 bytes/sec)
Router# request platform software package expand file
harddisk:/Target_Subs/asr1000rp2-adventerprisek9.03.13.00.S.154-3.S-ext.bin
Verifying parameters
Validating package type
Copying package files
SUCCESS: Finished expanding all-in-one software package.
Router# dir harddisk:Target_Subs
Directory of harddisk:/Target_Subs/
9666562 -rw- 569597380 Aug 3 2013 13:25:06 +05:30
asr1000rp2-adventerprisek9.03.13.00.S.154-3.S-ext.bin
666566 -rw- 37557200 Aug 3 2013 13:27:06 +05:30
asr1000rp2-elcbase.03.13.00.S.154-3.S-ext.pkg
666567 -rw- 51194832 Aug 3 2013 13:27:07 +05:30
asr1000rp2-elcspa.03.13.00.S.154-3.S-ext.pkg
666568 -rw- 80657364 Aug 3 2013 13:27:07 +05:30
asr1000rp2-espbase.03.13.00.S.154-3.S-ext.pkg
666569 -rw- 95446456 Aug 3 2013 13:27:08 +05:30
asr1000rp2-esp86base.03.13.00.S.154-3.S-ext.pkg
666564 -rw- 95449381 Aug 3 2013 13:27:06 +05:30
asr1000rp2-packages-adventerprisek9.03.13.00.S.154-3.S-ext.conf
666570 -rw- 23350232 Aug 3 2013 13:27:08 +05:30
asr1000rp2-rpaccess.03.13.00.S.154-3.S-ext.pkg
666571 -rw- 37694900 Aug 3 2013 13:27:08 +05:30
asr1000rp2-rpbase.03.13.00.S.154-3.S-ext.pkg
666572 -rw- 45536216 Aug 3 2013 13:27:08 +05:30
asr1000rp2-rpcontrol.03.13.00.S.154-3.S-ext.pkg
666573 -rw- 118754284 Aug 3 2013 13:27:08 +05:30

```

```

asr1000rp2-rpios-adventerprisek9.03.13.00.S.154-3.S-ext.pkg
666574 -rw- 38380500 Aug 3 2013 13:27:08 +05:30
asr1000rp2-sipbase.03.13.00.S.154-3.S-ext.pkg
666575 -rw- 61760468 Aug 3 2013 13:27:08 +05:30
asr1000rp2-sipspa.03.13.00.S.154-3.S-ext.pkg
666565 -rw- 10165 Aug 3 2013 13:27:08 +05:30 packages.conf
78704144384 bytes total (47541493760 bytes free)
Router# copy harddisk:Target_Sub/Target_Sub/asr1000rp2-espbase.03.13.00.S.154-3.S-ext.pkg bootflash:
Active_Dir/
Destination filename [Active_Dir/asr1000rp2-espbase.03.13.00.S.154-3.S-ext.pkg]?
copy in
progress...CCCCC
80657364 bytes copied in 12.085 secs (6674172 bytes/sec)
Router# copy harddisk:Target_Sub/Target_Sub/asr1000rp2-espbase.03.13.00.S.154-3.S-ext.pkg bootflash:
Active_Dir/Target_Sub/Target_Sub/asr1000rp2-espbase.03.13.00.S.154-3.S-ext.pkg]?
Copy in progress...CCCCC
95446456 bytes copied in 14.687 secs (6498703 bytes/sec)
Router# copy harddisk:Target_Sub/Target_Sub/asr1000rp2-rpaccess.03.13.00.S.154-3.S-ext.pkg bootflash:
Active_Dir/Target_Sub/Target_Sub/asr1000rp2-rpaccess.03.13.00.S.154-3.S-ext.pkg]?
copy in
progress...CCCCC
23350232 bytes copied in 4.047 secs (5769763 bytes/sec)
Router# copy harddisk:Target_Sub/Target_Sub/asr1000rp2-rpbase.03.13.00.S.154-3.S-ext.pkg bootflash:
Active_Dir/Target_Sub/Target_Sub/asr1000rp2-rpbase.03.13.00.S.154-3.S-ext.pkg]?
copy in
progress...CCCC
37694900 bytes copied in 5.978 secs (6305604 bytes/sec)
Router# copy harddisk:Target_Sub/Target_Sub/asr1000rp2-rpcontrol.03.13.00.S.154-3.S-ext.pkg bootflash:
Active_Dir/Target_Sub/Target_Sub/asr1000rp2-rpcontrol.03.13.00.S.154-3.S-ext.pkg]?
copy in
progress...CCCCC
45536216 bytes copied in 5.970 secs (7627507 bytes/sec)
Router# copy harddisk:Target_Sub/Target_Sub/asr1000rp2-rpios-adventerprisek9.03.13.00.S.154-3.S-ext.pkg
bootflash:
[Active_Dir/Target_Sub/Target_Sub/asr1000rp2-rpios-adventerprisek9.03.13.00.S.154-3.S-ext.pkg]?
copy in
progress...CCCC
118754284 bytes copied in 18.501 secs (6418804 bytes/sec)
Router# copy harddisk:Target_Sub/Target_Sub/asr1000rp2-sipbase.03.13.00.S.154-3.S-ext.pkg bootflash:
Active_Dir/Target_Sub/Target_Sub/asr1000rp2-sipbase.03.13.00.S.154-3.S-ext.pkg]?
copy in
progress...CCCCC38380500 bytes copied in 4.951 secs (7752070 bytes/sec)
Router# copy harddisk:Target_Sub/Target_Sub/asr1000rp2-sipspa.03.13.00.S.154-3.S-ext.pkg bootflash:
Active_Dir/Target_Sub/Target_Sub/asr1000rp2-sipspa.03.13.00.S.154-3.S-ext.pkg]?
copy in
progress...CCCCC61760468 bytes copied in 8.615 secs (7168946 bytes/sec)
Router# copy harddisk:Target_Sub/Target_Sub/asr1000rp2-elcbase.03.13.00.S.154-3.S-ext.pkg bootflash:
Active_Dir/Target_Sub/Target_Sub/asr1000rp2-elcbase.03.13.00.S.154-3.S-ext.pkg]?
copy in
progress...CCCCC37557200 bytes copied in 5.255 secs (7146946 bytes/sec)
Router# copy harddisk:Target_Sub/Target_Sub/asr1000rp2-elcspa.03.13.00.S.154-3.S-ext.pkg bootflash:
Active_Dir/Target_Sub/Target_Sub/asr1000rp2-elcspa.03.13.00.S.154-3.S-ext.pkg]?
copy in
progress...CCCCCCCC
51194832 bytes copied in 7.677 secs (6668599 bytes/sec)2
Router#issu loadversion rp 0 file
bootflash:Active_Dir/Target_Sub/Target_Sub/asr1000rp2-{rpaccess,rpios,rpcontrol}*03.13.00.S.154-3.S-ext*.pkg bay
1 force
---- Starting local lock acquisition on R0----
Finished local lock acquisition on R0
---Starting file path checking---
Finished file path checking

```

```
---Starting image file verification----
Checking image file names
Locating image files and validating name syntax
Found asr1000rp2-rpaccess.03.13.00.S.154-3.S-ext.pkg
Found asr1000rp2-rpios-adventerprisek9.03.13.00.S.154-3.S-ext.pkg
Found asr1000rp2-rpcontrol.03.13.00.S.154-3.S-ext.pkg
Verifying image file locations
Inspecting image file types
Processing image file constraints
Creating candidate provisioning file
Finished image file verification
--- Starting candidate package set construction ---
Verifying existing software set
Processing candidate provisioning file
Constructing working set for candidate package set
Constructing working set for running package set
Checking command output
Constructing merge of running and candidate packages
Checking if resulting candidate package set would be complete
Finished candidate package set construction
--- Starting compatibility testing ---
Determining whether candidate package set is compatible
WARNING:Candidate software combination not found in compatibility database
WARNING:Determining whether installation is valid
Creating matrix_file by locate_latest_matrix_file /tmp/issu/provision/s
WARNING: Candidate software combination not found in compatibility database
WARNING: Candidate software combination not found in compatibility database
WARNING:Software sets are identified as compatible
Verifying image type compatibility
Checking IPC compatibility with running software
Checking candidate package set infrastructure compatibility
Checking infrastructure compatibility with running software
Checking package specific compatibility
Finished compatibility testing
--- Starting impact testing ---
Checking operational impact of change
WARNING: Connection may be lost during installation of IOS package
Finished impact testing
--- Starting list of software package changes ---
No old package files removed
New files list:
 Added asr1000rp2-rpaccess.03.13.00.S.154-3.S-ext.pkg
 Added asr1000rp2-rpcontrol.03.13.00.S.154-3.S-ext.pkg
 Added asr1000rp2-rpios-adventerprisek9.03.13.00.S.154-3.S-ext.pkg
Finished list of software package changes
--- Starting commit of software changes ---
Updating provisioning rollback files
Creating pending provisioning file
Committing provisioning file
Finished commit of software changes
--- Starting analysis of software changes ---
Finished analysis of software changes
--- Starting update running software ---
Blocking peer synchronization of operating information
Creating the command set placeholder directory
 Finding latest command set
 Finding latest command shortlist lookup file
 Finding latest command shortlist file
 Assembling CLI output libraries
 Assembling CLI input libraries
 Assembling Dynamic configuration files
 Applying interim IPC and database definitions
 Replacing running software
 Replacing CLI software
```

```

Restarting software
Restarting IOS PID: 21552, in slot/bay 0/1
Applying final IPC and database definitions
Generating software version information
Notifying running software of updates
Unblocking peer synchronization of operating information
Unmounting old packages
Cleaning temporary installation files
Finished update running software.
SUCCESS: Finished installing software.
Router#issu commitversion
-- Starting local lock acquisition on R0---
Finished local lock acquisition on R0
-- Starting installation changes ---
Cancelling rollback timer
Finished installation changes
SUCCESS: Installation changes committed
Router#redundancy force-switchover
Proceed with switchover to standby RP? [confirm]
Manual Swact = enabled
%IOSXE_INFRA-6-CONSOLE_ACTIVE: R0/1 console active. Press RETURN to get started![OK]
*Aug 3 13:43:52.101 IST: %CMANRP-6-CMHASTATUS: RP switchover, received chassis event to
become active
*Aug 3 13:43:52.193 IST: %REDUNDANCY-3-SWITCHOVER: RP switchover (PEER_NOT_PRESENT)
*Aug 3 13:43:52.194 IST: %REDUNDANCY-3-SWITCHOVER: RP switchover (PEER_DOWN)
*Aug 3 13:43:52.194 IST: %REDUNDANCY-3-SWITCHOVER: RP switchover
(PEER_REDUNDANCY_STATE_CHANGE)
*Aug 3 13:43:51.231 IST: %RF-5-RF_RELOAD: Self reload. Reason: redundancy force-switchover
*Aug 3 13:43:51.461 IST: %SYS-5-SWITCHOVER: Switchover requested by red_switchover_process.
Reason: redundancy force-switchover.
*Aug 3 13:43:52.198 IST: %PLATFORM-6-HASTATUS: RP switchover, sent message became active.

IOS is ready to switch to primary after chassis confirmation
*Aug 3 13:43:52.200 IST: %CMANRP-6-CMHASTATUS: RP switchover, received chassis event became
active
*Aug 3 13:43:52.449 IST: %PLATFORM-6-HASTATUS_DETAIL: RP switchover, received chassis event
became active. Switch to primary (count 1)
*Aug 3 13:43:52.733 IST: %LINEPROTO-5-UPDOWN: Line protocol on Interface GigabitEthernet0,
changed state to down
*Aug 3 13:43:53.098 IST: % Redundancy mode change to SSO
*Aug 3 13:43:53.126 IST: %LINK-3-UPDOWN: Interface Lsmpi0, changed state to up
*Aug 3 13:43:53.127 IST: %LINK-3-UPDOWN: Interface EOBC0, changed state to up
*Aug 3 13:43:53.127 IST: %LINK-3-UPDOWN: Interface LIIN0, changed state to up
*Aug 3 13:43:54.127 IST: %LINEPROTO-5-UPDOWN: Line protocol on Interface Lsmpi0, changed
state to up
*Aug 3 13:43:54.127 IST: %LINEPROTO-5-UPDOWN: Line protocol on Interface EOBC0, changed
state to up
*Aug 3 13:43:54.127 IST: %LINEPROTO-5-UPDOWN: Line protocol on Interface LIIN0, changed
state to up
*Aug 3 13:43:55.117 IST: %LINK-3-UPDOWN: Interface Null10, changed state to up
*Aug 3 13:43:55.117 IST: %LINK-3-UPDOWN: Interface GigabitEthernet0/0/8, changed state to
up
*Aug 3 13:43:55.117 IST: %LINK-3-UPDOWN: Interface GigabitEthernet0/0/10, changed state
to up
*Aug 3 13:43:55.117 IST: %LINK-3-UPDOWN: Interface GigabitEthernet1/0/0, changed state to
up
*Aug 3 13:43:55.119 IST: %LINK-3-UPDOWN: Interface GigabitEthernet1/0/1, changed state to
up
*Aug 3 13:43:55.119 IST: %LINK-3-UPDOWN: Interface GigabitEthernet1/1/0, changed state to
up
*Aug 3 13:43:55.119 IST: %LINK-3-UPDOWN: Interface GigabitEthernet1/1/1, changed state to
up
*Aug 3 13:43:55.119 IST: %LINK-3-UPDOWN: Interface GigabitEthernet1/1/3, changed state to
up

```

```

*Aug 3 13:43:55.119 IST: %LINK-3-UPDOWN: Interface GigabitEthernet1/1/5, changed state to
up
*Aug 3 13:43:55.124 IST: %LINK-5-CHANGED: Interface GigabitEthernet0/0/0, changed state
to administratively down
*Aug 3 13:43:55.124 IST: %LINK-5-CHANGED: Interface GigabitEthernet0/0/1, changed state
to administratively down
*Aug 3 13:43:55.124 IST: %LINK-5-CHANGED: Interface GigabitEthernet0/0/2, changed state
to administratively down
*Aug 3 13:43:55.124 IST: %LINK-5-CHANGED: Interface GigabitEthernet0/0/3, changed state
to administratively down
*Aug 3 13:43:55.124 IST: %LINK-5-CHANGED: Interface GigabitEthernet0/0/4, changed state
to administratively down
*Aug 3 13:43:55.124 IST: %LINK-5-CHANGED: Interface GigabitEthernet0/0/5, changed state
to administratively down
*Aug 3 13:43:55.124 IST: %LINK-5-CHANGED: Interface GigabitEthernet0/0/6, changed state
to administratively down
*Aug 3 13:43:55.124 IST: %LINK-5-CHANGED: Interface GigabitEthernet0/0/7, changed state
to administratively down
*Aug 3 13:43:55.124 IST: %LINK-5-CHANGED: Interface GigabitEthernet0/0/9, changed state
to administratively down
*Aug 3 13:43:55.124 IST: %LINK-5-CHANGED: Interface GigabitEthernet0/0/11, changed state
to administratively down
*Aug 3 13:43:56.118 IST: %LINEPROTO-5-UPDOWN: Line protocol on Interface Null0, changed
state to up
*Aug 3 13:43:56.118 IST: %LINEPROTO-5-UPDOWN: Line protocol on Interface
GigabitEthernet0/0/8, changed state to up
*Aug 3 13:43:56.118 IST: %LINEPROTO-5-UPDOWN: Line protocol on Interface
GigabitEthernet0/0/10, changed state to up
*Aug 3 13:43:56.118 IST: %LINEPROTO-5-UPDOWN: Line protocol on Interface
TenGigabitEthernet0/0/20, changed state to down
*Aug 3 13:43:56.118 IST: %LINEPROTO-5-UPDOWN: Line protocol on Interface
TenGigabitEthernet0/0/21, hanged state to down
*Aug 3 13:43:56.118 IST: %LINEPROTO-5-UPDOWN: Line protocol on Interface
GigabitEthernet1/0/0, changed state to up
*Aug 3 13:43:56.120 IST: %LINEPROTO-5-UPDOWN: Line protocol on Interface
GigabitEthernet1/0/1, changed state to up
*Aug 3 13:43:56.120 IST: %LINEPROTO-5-UPDOWN: Line protocol on Interface
GigabitEthernet1/1/0, changed state to up
*Aug 3 13:43:56.120 IST: %LINEPROTO-5-UPDOWN: Line protocol on Interface
GigabitEthernet1/1/1, changed state to up
*Aug 3 13:43:56.120 IST: %LINEPROTO-5-UPDOWN: Line protocol on Interface
GigabitEthernet1/1/3, changed state to up
*Aug 3 13:44:05.127 IST: %LINK-3-UPDOWN: Interface GigabitEthernet0, changed state to up
*Aug 3 13:44:06.127 IST: %LINEPROTO-5-UPDOWN: Line protocol on Interface GigabitEthernet0,
changed state to up
*Aug 3 13:44:32.069 IST: %REDUNDANCY-5-PEER_MONITOR_EVENT: Active detected a standby
insertion (raw-event=PEER_FOUND(4))
*Aug 3 13:44:32.070 IST: %REDUNDANCY-5-PEER_MONITOR_EVENT: Active detected a standby
insertion (raw-event=PEER_REDUNDANCY_STATE_CHANGE(5))
*Aug 3 13:44:34.969 IST: %REDUNDANCY-3-IPC: IOS versions do not match.
*Aug 3 13:45:40.946 IST: %RF-5-RF_TERMINAL_STATE: Terminal state reached for (SSO)
Router# issu loadversion rp 0 file
bootflash:Active_Dir/asr1000rp2-{rpaccess,rpios,rpcontrol}*03.13.00.S.154-3.S-ext*.pkg bay
0 force
--- Starting local lock acquisition on R0 ---
Finished local lock acquisition on R0
--- Starting file path checking ---
Finished file path checking
---Starting image file verification---
Checking image file names
Locating image files and validating name syntax
Found asr1000rp2-rpaccess.03.13.00.S.154-3.S-ext.pkg
Found asr1000rp2-rpios-adventerprisek9.03.13.00.S.154-3.S-ext.pkg
Found asr1000rp2-rpcontrol.03.13.00.S.154-3.S-ext.pkg

```

```

Verifying image file locations
Inspecting image file types
Processing image file constraints
Creating candidate provisioning file
Finished image file verification
--- Starting candidate package set construction ---
Verifying existing software set
Processing candidate provisioning file
Constructing working set for candidate package set
Constructing working set for running package set
Checking command output
Constructing merge of running and candidate packages
Checking if resulting candidate package set would be complete
Finished candidate package set construction
--- Starting compatibility testing ---
Determining whether candidate package set is compatible
WARNING: Candidate software combination not found in compatibility database
WARNING: Determining whether installation is valid
Creating matrix_file by locate_latest_matrix_file/tmp/issu/provision/sw
Software sets are identified as compatible
Verifying image type compatibility
Checking IPC compatibility with running software
Checking candidate package set infrastructure compatibility
Checking infrastructure compatibility with running software
Checking package specific compatibility
Finished compatibility testing
--- Starting impact testing ---
Checking operational impact of change

WARNING: Connection may be lost during installation of IOS package
Finished impact testing
--- Starting list of software package changes ---
Old files list:
 Removed asr1000rp2-rpaccess.03.12.01.S.154-2.S.pkg
 Removed asr1000rp2-rpcontrol.03.12.01.S.154-2.S.pkg
 Removed asr1000rp2-rpios-adventerprisek9.03.12.01.S.154-2.S.pkg
No new package files added
 Finished list of software package changes
--- Starting commit of software changes ---
Updating provisioning rollback files
Creating pending provisioning file
Committing provisioning file
Finished commit of software changes
--- Starting analysis of software changes ---
Finished analysis of software changes
Starting update running software
Blocking peer synchronization of operating information
Creating the command set placeholder directory
 Finding latest command set
 Finding latest command shortlist lookup file
 Finding latest command shortlist file
 Assembling CLI output libraries
 Assembling CLI input libraries
 Assembling Dynamic configuration files
 Applying interim IPC and database definitions
 Replacing running software
 Replacing CLI software
 Restarting software
 Restarting IOS PID: 25452, in slot/bay 0/0
*Aug 3 13:48:07.051 IST:
%REDUNDANCY-3-STANDBY_LOST: Standby processor fault (PEER_NOT_PRESENT)
*Aug 3 13:48:07.052 IST: %REDUNDANCY-3-STANDBY_LOST: Standby processor fault (PEER_DOWN)
*Aug 3 13:48:07.052 IST: %REDUNDANCY-3-STANDBY_LOST: Standby processor fault
(Peer_REDUNDANCY_STATE_CHANGE)

```



```

*Aug 3 13:48:09.683 IST: %RF-5-RF_RELOAD: Peer reload.
Reason: EHSA standby down
*Aug 3 13:48:09.692 IST: % Redundancy mode change to SSO
*Aug 3 13:48:49.450 IST: %REDUNDANCY-5-PEER_MONITOR_EVENT: Active detected a standby
insertion (raw-event=PEER_FOUND(4))
*Aug 3 13:48:49.451 IST: %REDUNDANCY-5-PEER_MONITOR_EVENT: Active detected a standby
insertion (raw-event=PEER_REDUNDANCY_STATE_CHANGE(5))
*Aug 3 13:48:50.035 IST:
%ISSU-3-PEER_IMAGE_NOT_IN_INCOMP_LIST: Peer image (X86_64_LINUX_IOSD-ADVENTERPRISEK9-M),
version (15.3(3)S) on peer uid (48) is not in the incompatible images list
*Aug 3 13:48:50.036 IST:
%ISSU-3-PEER_IMAGE_NOT_IN_INCOMP_LIST: Peer image (X86_64_LINUX_IOSD-ADVENTERPRISEK9-M),
version (15.3(3)S) on peer uid (48) is not in the incompatible images list
Applying final IPC and database definitions
*Aug 3 13:48:53.521 IST: %DYNCMD-7-CMDSET_UNLOADED:
The Dynamic Command set from the Shell Manager has been unloaded
Generating software version information
 Notifying running software of updates
 Unblocking peer synchronization of operating information
 Unmounting old packages
 Cleaning temporary installation files
 Finished update running software
SUCCESS: Finished installing software.
Router#
*Aug 3 13:49:57.477 IST: %NBAR_HA-5-NBAR_INFO: NBAR sync DONE!
*Aug 3 13:49:57.893 IST: %ISSU-3-PEER_IMAGE_REM_FROM_INCOMP_LIST: Peer image
(X86_64_LINUX_IOSD-ADVENTERPRISEK9-M),
version (15.3(2)S) on peer uid (48) being removed from the incompatibility list
*Aug 3 13:49:57.893 IST: %HA_CONFIG_SYNC-6-BULK_CFGSYNC_SUCCEEDED: Bulk Sync succeeded
*Aug 3 13:49:57.895 IST: %RF-5-RF_TERMINAL_STATE: Terminal state reached for (SSO)
Router# issu commitversion

--- Starting local lock acquisition on R0--
Finished local lock acquisition on R0
Starting installation changes
Cancelling rollback timer
Finished installation changes
SUCCESS: Installation changes committed
Router# issu loadversion rp 0 file
bootflash:Active_Dir/asr1000rp2-(sibase,sipsa)*03.13.00.S.154-3.S-ext*.pkg slot 1 force
--- Starting local lock acquisition on R0 ---
Finished local lock acquisition on R0
--- Starting file path checking ---
Finished file path checking
--- Starting image file verification ---
Checking image file names
Locating image files and validating name syntax
 Found asr1000rp2-sibase.03.13.00.S.154-3.S-ext.pkg
 Found asr1000rp2-sipsa.03.13.00.S.154-3.S-ext.pkg
Verifying image file locations
Inspecting image file types
Processing image file constraints
Creating candidate provisioning file
Finished image file verification
--- Starting candidate package set construction ---
Verifying existing software set
Processing candidate provisioning file
Constructing working set for candidate package set
Constructing working set for running package set
Checking command output
Constructing merge of running and candidate packages
Checking if resulting candidate package set would be complete
Finished candidate package set construction
--- Starting compatibility testing ---

```

```

Determining whether candidate package set is compatible
WARNING: Candidate software combination not found in compatibility database
WARNING:Determining whether installation is valid
Creating matrix_file by locate_latest_matrix_file /tmp/issu/provision/s
WARNING: Candidate software combination not found in compatibility database
WARNING: Candidate software combination not found in compatibility database
WARNING: Software sets are identified as compatible
Verifying image type compatibility
Checking IPC compatibility with running software
Checking candidate package set infrastructure compatibility
Checking infrastructure compatibility with running software
Checking package specific compatibility
Finished compatibility testing
--- Starting impact testing-----
Checking operational impact of change
Finished impact testing
--- Starting list of software package changes---
No old package files removed
New files list:
 Added asr1000rp2-sipbase.03.13.00.S.154-3.S-ext.pkg
 Added asr1000rp2-sipspa.03.13.00.S.154-3.S-ext.pkg
Finished list of software package changes
--- Starting commit of software changes ---
Updating provisioning rollback files
Creating pending provisioning file
Committing provisioning file
Finished commit of software changes
--- Starting analysis of software changes ---
Finished analysis of software changes
--- Starting update running software ---
Blocking peer synchronization of operating information
Creating the command set placeholder directory
 Finding latest command set
 Finding latest command shortlist lookup file
 Finding latest command shortlist file
 Assembling CLI output libraries
 Assembling CLI input libraries
 Assembling Dynamic configuration files
 Applying interim IPC and database definitions
 Replacing running software
 Replacing CLI software
 Restarting software
 Restarting SIP1
 Applying final IPC and database definitions
*Aug 3 13:52:05.767 IST: %IOSXE_OIR-6-OFFLINECARD: Card (cc) offline in slot 1
*Aug 3 13:52:05.770 IST: %IOSXE_OIR-6-REMSPA: SPA removed from subslot 1/0, interfaces
disabled
*Aug 3 13:52:05.770 IST: %IOSXE_OIR-6-REMSPA: SPA removed from subslot 1/1, interfaces
disabled
*Aug 3 13:52:05.778 IST: %SPA_OIR-6-OFFLINECARD: SPA (SPA-2X1GE-V2) offline in subslot 1/0
*Aug 3 13:52:05.786 IST: %SPA_OIR-6-OFFLINECARD: SPA (SPA-10X1GE-V2) offline in subslot
1/1
Generating software version information
Notifying running software of updates
Unblocking peer synchronization of operating information
Unmounting old packages
Cleaning temporary installation files
 Finished update running software
SUCCESS: Finished installing software.
Router#
*Aug 3 13:53:00.262 IST: %IOSXE_OIR-6-ONLINECARD: Card (cc) online in slot 1
*Aug 3 13:53:00.901 IST: %IOSXE_OIR-6-INSSPA: SPA inserted in subslot 1/0
*Aug 3 13:53:01.194 IST: %IOSXE_OIR-6-INSSPA: SPA inserted in subslot 1/1
*Aug 3 13:53:18.148 IST: %LINK-3-UPDOWN: SIP1/0: Interface EOBC1/1, changed state to up

```

```

*Aug 3 13:53:23.978 IST: %SPA_OIR-6-ONLINECARD: SPA (SPA-2X1GE-V2) online in subslot 1/0
*Aug 3 13:53:23.609 IST: %LINK-3-UPDOWN: SIP1/1: Interface EOBC1/1, changed state to up
*Aug 3 13:53:26.288 IST: %LINK-3-UPDOWN: Interface GigabitEthernet1/0/0, changed state to
up
*Aug 3 13:53:26.471 IST: %LINK-3-UPDOWN: Interface GigabitEthernet1/0/1, changed state to
up
*Aug 3 13:53:26.605 IST: %LINK-3-UPDOWN: SIP1/0: Interface GigabitEthernet1/0/0, changed
state to up
*Aug 3 13:53:29.056 IST: %SPA_OIR-6-ONLINECARD: SPA (SPA-10X1GE-V2) online in subslot 1/1
*Aug 3 13:53:31.020 IST: %LINK-3-UPDOWN: Interface GigabitEthernet1/1/1, changed state to
up
*Aug 3 13:53:31.030 IST: %LINK-3-UPDOWN: Interface GigabitEthernet1/1/3, changed state to
up
*Aug 3 13:53:31.042 IST: %LINK-3-UPDOWN: Interface GigabitEthernet1/1/4, changed state to
down
*Aug 3 13:53:31.045 IST: %LINK-3-UPDOWN: Interface GigabitEthernet1/1/5, changed state to
up
*Aug 3 13:53:31.046 IST: %LINK-3-UPDOWN: Interface GigabitEthernet1/1/6, changed state to
down
*Aug 3 13:53:31.048 IST: %LINK-3-UPDOWN: Interface GigabitEthernet1/1/7, changed state to
down
*Aug 3 13:53:31.051 IST: %LINK-3-UPDOWN: Interface GigabitEthernet1/1/8, changed state to
down
*Aug 3 13:53:31.053 IST: %LINK-3-UPDOWN: Interface GigabitEthernet1/1/9, changed state to
down
*Aug 3 13:53:31.312 IST: %LINK-3-UPDOWN: Interface GigabitEthernet1/1/0, changed state to
up
*Aug 3 13:53:32.833 IST: %LINK-3-UPDOWN: SIP1/1: Interface GigabitEthernet1/1/0, changed
state to up
*Aug 3 13:53:33.007 IST: %LINK-3-UPDOWN: SIP1/1: Interface GigabitEthernet1/1/7, changed
state to down
Router# issu commitversion

```

```

--- Starting local lock acquisition on R0 ---
Finished local lock acquisition on R0
Starting installation changes
Cancelling rollback timer
Finished installation changes
SUCCESS: Installation changes committed
Router# issu loadversion rp 0 file
bootflash:Active_Dir/asr1000rp2-{elcbase,elcspa}*03.13.00.S.154-3.S-ext*.pkg slot 0 force
Starting local lock acquisition on R0
---Finished local lock acquisition on R0---
Starting file path checking
---Finished file path checking---
Starting image file verification
---Checking image file names---
Locating image files and validating name syntax
 Found asr1000rp2-elcbase.03.13.00.S.154-3.S-ext.pkg
 Found asr1000rp2-elcspa.03.13.00.S.154-3.S-ext.pkg
Verifying image file locations
Inspecting image file types
Processing image file constraints
Creating candidate provisioning file
Finished image file verification
--- Starting candidate package set construction ---
Verifying existing software set
Processing candidate provisioning file
Constructing working set for candidate package set
Constructing working set for running package set
Checking command output
Constructing merge of running and candidate packages
Checking if resulting candidate package set would be complete
Finished candidate package set construction

```

```

--- Starting compatibility testing ---
Determining whether candidate package set is compatible
WARNING: Candidate software combination not found in compatibility database
WARNING: Determining whether installation is valid
Creating matrix_file by locate_latest_matrix_file /tmp/issu/provision/s
WARNING: Candidate software combination not found in compatibility database
WARNING: Candidate software combination not found in compatibility database
WARNING: Software sets are identified as compatible
Verifying image type compatibility
Checking IPC compatibility with running software
Checking candidate package set infrastructure compatibility
Checking infrastructure compatibility with running software
Checking package specific compatibility
Finished compatibility testing
--- Starting impact testing---
Checking operational impact of change
Finished impact testing
--- Starting list of software package changes ---
No old package files removed
New files list:
 Added asr1000rp2-elcbase.03.13.00.S.154-3.S-ext.pkg
 Added asr1000rp2-elcspa.03.13.00.S.154-3.S-ext.pkg
Finished list of software package changes
--- Starting commit of software changes ---
Updating provisioning rollback files
Creating pending provisioning file
Committing provisioning file
Finished commit of software changes
--- Starting analysis of software changes ---
Finished analysis of software changes
--- Starting update running software ---
Blocking peer synchronization of operating information
Creating the command set placeholder directory
 Finding latest command set
 Finding latest command shortlist lookup file
 Finding latest command shortlist file
 Assembling CLI output libraries
 Assembling CLI input libraries
 Assembling Dynamic configuration files
 Applying interim IPC and database definitions
 Replacing running software
 Replacing CLI software
 Restarting software
 Applying final IPC and database definitions
 Generating software version information
 Notifying running software of updates
 Unblocking peer synchronization of operating information
 Unmounting old packages
 Cleaning temporary installation files
 Finished update running software
SUCCESS: Finished installing software.
Router#issu commitversion
-- Starting local lock acquisition on R0 ---
Finished local lock acquisition on R0
--- Starting installation changes ---
Cancelling rollback timer
Finished installation changes
SUCCESS: Installation changes committed
Router# issu loadversion rp 0 file
bootflash:Active_Dir/asr1000rp2-esp*03.13.00.S.154-3.S-ext*.pkg force
--- Starting local lock acquisition on R0 ---
Finished local lock acquisition on R0
--- Starting file path checking ---
Finished file path checking

```

```
--- Starting image file verification ---
Checking image file names
Locating image files and validating name syntax
 Found asr1000rp2-espbase.03.13.00.S.154-3.S-ext.pkg
 Found asr1000rp2-esp86base.03.13.00.S.154-3.S-ext.pkg
Verifying image file locations
Inspecting image file types
Processing image file constraints
Creating candidate provisioning file
Finished image file verification
--- Starting candidate package set construction --
Verifying existing software set
Processing candidate provisioning file
Constructing working set for candidate package set
Constructing working set for running package set
Checking command output
Constructing merge of running and candidate packages
Checking if resulting candidate package set would be complete
Finished candidate package set construction
--- Starting compatibility testing ---
Determining whether candidate package set is compatible
WARNING: Candidate software combination not found in compatibility database
WARNING: Determining whether installation is valid
Creating matrix_file by locate_latest_matrix_file /tmp/issu/provision/s
WARNING: Candidate software combination not found in compatibility database
WARNING: Candidate software combination not found in compatibility database
WARNING: Software sets are identified as compatible
Verifying image type compatibility
Checking IPC compatibility with running software
Checking candidate package set infrastructure compatibility
Checking infrastructure compatibility with running software
Checking package specific compatibility
Finished compatibility testing
--- Starting impact testing ---
Checking operational impact of change
Finished impact testing
--- Starting list of software package changes ---
Old files list:
 Removed asr1000rp2-espbase.03.12.01.S.154-2.S.pkg
 Removed asr1000rp2- esp86base.03.12.01.S.154-2.S.pkg
New files list:
 Added asr1000rp2-espbase.03.13.00.S.154-3.S-ext.pkg
 Added asr1000rp2-esp86base.03.13.00.S.154-3.S-ext.pkg
Finished list of software package changes
--- Starting commit of software changes ---
Updating provisioning rollback files
Creating pending provisioning file
Committing provisioning file
Finished commit of software changes
Starting analysis of software changes
Finished analysis of software changes---
Starting update running software
Blocking peer synchronization of operating information
Creating the command set placeholder directory
 Finding latest command set
 Finding latest command shortlist lookup file
 Finding latest command shortlist file
 Assembling CLI output libraries
 Assembling CLI input libraries
 Assembling Dynamic configuration files
 Applying interim IPC and database definitions
 Replacing running software
 Replacing CLI software
 Restarting software
```

```

Restarting ESP0
Applying final IPC and database definitions
*Aug 3 14:02:51.450 IST: %IOSXE_OIR-6-OFFLINECARD: Card (fp) offline in slot F0
Generating software version information
Notifying running software of updates
Unblocking peer synchronization of operating information
Unmounting old packages
Cleaning temporary installation files
Finished update running software
SUCCESS: Finished installing software.
Router#
*Aug 3 14:04:49.802 IST: %CPPHA-7-START: F0: cpp_ha: CPP 0
preparing image /tmp/sw/fp/0/0/fpx86/mount/usr/cpp/bin/qfp-ucode-esp40
*Aug 3 14:04:50.172 IST: %CPPHA-7-START: F0: cpp_ha: CPP 0 startup init image
/tmp/sw/fp/0/0/fpx86/mount/usr/cpp/bin/qfp-ucode-esp40
*Aug 3 14:04:50.746 IST: %IOSXE_OIR-6-ONLINECARD: Card (fp) online in slot F0
*Aug 3 14:04:55.480 IST: %CPPHA-7-START: F0: cpp_ha: CPP 0 running init image
/tmp/sw/fp/0/0/fpx86/mount/usr/cpp/bin/qfp-ucode-esp40
*Aug 3 14:04:55.698 IST: %CPPHA-7-READY: F0: cpp_ha: CPP 0 loading and initialization
complete
*Aug 3 14:04:55.837 IST: %IOSXE-6-PLATFORM: F0: cpp_cp: Process
CPP_FILTER_EA_EVENT_API_CALL_REGISTER
Router#issu commitversion
-- Starting local lock acquisition on R0 ---
Finished local lock acquisition on R0
---Starting installation changes ---
Cancelling rollback timer
Finished installation changes
SUCCESS: Installation changes committed
Router# issu loadversion rp 0 file bootflash:Active_Dir/asr1000rp*03.13.00.S.154-3.S-ext*.pkg
-- Starting local lock acquisition on R0
---Finished local lock acquisition on R0
Starting file path checking
Finished file path checking
Starting image file verification
Checking image file names
Locating image files and validating name syntax
Found asr1000rp2-elcbase.03.13.00.S.154-3.S-ext.pkg
Found asr1000rp2-elcspa.03.13.00.S.154-3.S-ext.pkg
Found asr1000rp2-espbase.03.13.00.S.154-3.S-ext.pkg
Found asr1000rp2-esp86base.03.13.00.S.154-3.S-ext.pkg
Found asr1000rp2-rpaccess.03.13.00.S.154-3.S-ext.pkg
Found asr1000rp2-rpbase.03.13.00.S.154-3.S-ext.pkg
Found asr1000rp2-rpcontrol.03.13.00.S.154-3.S-ext.pkg
Found asr1000rp2-rpios-adventerprisek9.03.13.00.S.154-3.S-ext.pkg
Found asr1000rp2-sipbase.03.13.00.S.154-3.S-ext.pkg
Found asr1000rp2-sipspa.03.13.00.S.154-3.S-ext.pkg
Verifying image file locations
Inspecting image file types
WARNING: In-service installation of RP Base package
WARNING: requires software reboot of target RP
WARNING: Automatically setting the on-reboot flag
Processing image file constraints
Creating candidate provisioning file
Finished image file verification
--- Starting candidate package set construction ---
Verifying existing software set
Processing candidate provisioning file
Constructing working set for candidate package set
Constructing working set for running package set
Checking command output
Constructing merge of running and candidate packages
Checking if resulting candidate package set would be complete
Finished candidate package set construction

```

```

--- Starting compatibility testing ---
Determining whether candidate package set is compatible
Determining whether installation is valid
Determining whether installation is valid ... skipped
Verifying image type compatibility
Checking IPC compatibility for candidate software
Checking candidate package set infrastructure compatibility
Checking infrastructure compatibility with running software
Checking infrastructure compatibility with running software ... skipped
Checking package specific compatibility
Finished compatibility testing
--- Starting list of software package changes ---
Old files list:
 Removed asr1000rp2-elcbase.03.12.01.S.154-2.S.pkg
 Removed asr1000rp2-elcspa.03.12.01.S.154-2.S.pkg
 Removed asr1000rp2-rpbase.03.12.01.S.154-2.S.pkg
 Removed asr1000rp2-sipbase.03.12.01.S.154-2.S.pkg
 Removed asr1000rp2-sipspa.03.12.01.S.154-2.S.pkg
New files list:
 Added asr1000rp2-rpbase.03.13.00.S.154-3.S-ext.pkg
Finished list of software package changes
--- Starting commit of software changes ---
Updating provisioning rollback files
Creating pending provisioning file
Committing provisioning file
Finished commit of software changes
SUCCESS: Software provisioned. New software will load on reboot.
Router# show version r0 provisioned

Package: Provisioning File, version: n/a, status: active
File: bootflash:Active_Dir/packages.conf,
on: RP0 Built: n/a, by:n/a
File SHA1 checksum: c79075780592aec1312725f4a2357a034fda2d3b
Package: rpbase,
version: 03.13.00.S.154-3.S-ext, status: n/a
File: bootflash:Active_Dir/asr1000rp2-rpbase.03.13.00.S.154-3.S-ext.pkg,
on: RP0 Built: 2013-07-25_22.55, by: mcpre
File SHA1 checksum: 4f655c54bb95b4dfa24a0d25ebf97cf8527c69e9
Package: rpcontrol, version: 03.13.00.S.154-3.S-ext, status: n/a
File: bootflash:Active_Dir/asr1000rp2-rpcontrol.03.13.00.S.154-3.S-ext.pkg,
on: RP0/0 Built: 2013-07-25_22.55, by: mcpre
 File SHA1 checksum: 8a0a45ea5c7a656c0eef6726174461584f182c78
Package: rpios-adventerprisek9, version: 03.13.00.S.154-3.S-ext, status: n/a
File: bootflash:Active_Dir/asr1000rp2-rpios-adventerprisek9.03.13.00.S.154-3.S-ext.pkg, on:
 RP0/0 Built: 2013-07-25_23.00, by: mcpre
File SHA1 checksum: 85e9eab826bff2194ef568a56c76453625383ad2
Package: rpaccess, version: 03.13.00.S.154-3.S-ext, status: n/a

File: bootflash:Active_Dir/asr1000rp2-rpaccess.03.13.00.S.154-3.S-ext.pkg,
on: RP0/0 Built: 2013-07-25_22.55, by: mcpre
File SHA1 checksum: a360dff0fd76a9b1ae67cda9116c97b62f25ab09
Package: rpcontrol, version: 03.13.00.S.154-3.S-ext, status: n/a
File: bootflash:Active_Dir/asr1000rp2-rpcontrol.03.13.00.S.154-3.S-ext.pkg,
on: RP0/1 Built: 2013-07-25_22.55, by: mcpre
File SHA1 checksum: 8a0a45ea5c7a656c0eef6726174461584f182c78
Package: rpios-adventerprisek9, version: 03.13.00.S.154-3.S-ext, status: n/a
File: bootflash:Active_Dir/asr1000rp2-rpios-adventerprisek9.03.13.00.S.154-3.S-ext.pkg, on:
 RP0/1 Built: 2013-07-25_23.00, by: mcpre
File SHA1 checksum: 85e9eab826bff2194ef568a56c76453625383ad2
Package: rpaccess, version: 03.13.00.S.154-3.S-ext, status: n/a
File: bootflash:Active_Dir/asr1000rp2-rpaccess.03.13.00.S.154-3.S-ext.pkg,
on: RP0/1 Built: 2013-07-25_22.55, by: mcpre
File SHA1 checksum: a360dff0fd76a9b1ae67cda9116c97b62f25ab09
Package: rpbase, version: 03.13.00.S.154-3.S-ext, status: n/a

```

## Examples

```

File: bootflash:Active_Dir/asr1000rp2-rpbase.03.13.00.S.154-3.S-ext.pkg,
on: RP1 Built: 2013-07-25_22.55, by: mcpre
File SHA1 checksum: 4f655c54bb95b4dfa24a0d25ebf97cf8527c69e9
Package:rpcontrol, version: 03.13.00.S.154-3.S-ext, status: n/a
File: bootflash:Active_Dir/asr1000rp2-rpcontrol.03.13.00.S.154-3.S-ext.pkg, on: RP1/0
Built: 2013-07-25_22.55, by: mcpre
File SHA1 checksum: 8a0a45ea5c7a656c0eef6726174461584f182c78
Package: rprios-adventerprisek9, version: 03.13.00.S.154-3.S-ext, status: n/a
File: bootflash:Active_Dir/asr1000rp2-rpios-adventerprisek9.03.13.00.S.154-3.S-ext.pkg,
on: RP1/0 Built: 2013-07-25_23.00, by: mcpre
File SHA1 checksum: 85e9eab826bff2194ef568a56c76453625383ad2
Package: rpaccess, version: 03.13.00.S.154-3.S-ext, status: n/a
File: bootflash:Active_Dir/asr1000rp2-rpaccess.03.13.00.S.154-3.S-ext.pkg,
on: RP1/0 Built: 2013-07-25_22.55, by: mcpre
File SHA1 checksum: a360dff0fd76a9blae67cda9116c97b62f25ab09
Package: rpcontrol, version: 03.13.00.S.154-3.S-ext, status: n/a
File: bootflash:Active_Dir/asr1000rp2-rpcontrol.03.13.00.S.154-3.S-ext.pkg, on: RP1/1
Built: 2013-07-25_22.55, by: mcpre
File SHA1 checksum: 8a0a45ea5c7a656c0eef6726174461584f182c78
Package: rprios-adventerprisek9, version: 03.13.00.S.154-3.S-ext, status:n/a
File: bootflash:Active_Dir/asr1000rp2-rpios-adventerprisek9.03.13.00.S.154-3.S-ext.pkg, on:
RP1/1 Built: 2013-07-25_23.00, by: mcpre
File SHA1 checksum: 85e9eab826bff2194ef568a56c76453625383ad2
Package: rpaccess, version: 03.13.00.S.154-3.S-ext, status: n/a
File: bootflash:Active_Dir/asr1000rp2-rpaccess.03.13.00.S.154-3.S-ext.pkg, on: RP1/1
Built: 2013-07-25_22.55, by: mcpre
File SHA1 checksum: a360dff0fd76a9blae67cda9116c97b62f25ab09
Package:espbases, version: 03.13.00.S.154-3.S-ext, status: n/a
File: bootflash:Active_Dir/asr1000rp2-espbases.03.13.00.S.154-3.S-ext.pkg, on: ESP0
Built: 2013-07-25_21.16, by: mcpre
File SHA1 checksum: 2fe0ede1545e3f8260b7d453653e812500f0d7b0
Package: esp86base, version: 03.13.00.S.154-3.S-ext, status: n/a
File: bootflash:Active_Dir/asr1000rp2-esp86base.03.13.00.S.154-3.S-ext.pkg, on: ESP0
Built: 2013-07-25_22.55, by: mcpre
File SHA1 checksum: 571b8bb3866341badd6e24de677b98409f0c789c
Package:espbases, version: 03.13.00.S.154-3.S-ext, status: n/a
File: bootflash:Active_Dir/asr1000rp2-espbases.03.13.00.S.154-3.S-ext.pkg, on: ESP1
Built: 2013-07-25_21.16, by: mcpre
File SHA1 checksum: 2fe0ede1545e3f8260b7d453653e812500f0d7b0
Package: esp86base, version: 03.13.00.S.154-3.S-ext, status: n/a
File:bootflash:Active_Dir/asr1000rp2-esp86base.03.13.00.S.154-3.S-ext.pkg, on: ESP1
Built: 2013-07-25_22.55, by: mcpre
File SHA1 checksum: 571b8bb3866341badd6e24de677b98409f0c789c
Package: sipbase,
version: 03.13.00.S.154-3.S-ext, status: n/a
File: bootflash:Active_Dir/asr1000rp2-sipbase.03.13.00.S.154-3.S-ext.pkg, on: SIP0
Built: 2013-07-25_21.16, by: mcpre
File SHA1 checksum: 3b6a4838972840a995ff22e73fd2bae910b268a7
Package: elcbases, version: 03.13.00.S.154-3.S-ext, status: n/a
File: bootflash:Active_Dir/asr1000rp2-elcbases.03.13.00.S.154-3.S-ext.pkg, on: SIP0
Built: 2013-07-25_21.16, by: mcpre
File SHA1 checksum: 99f8dc925083b118626a4e82d93079050db96826
Package: sipspa, version: 03.13.00.S.154-3.S-ext, status: n/a
File: bootflash:Active_Dir/asr1000rp2-sipspa.03.13.00.S.154-3.S-ext.pkg, on: SIP0/0
Built: 2013-07-25_21.16, by: mcpre
File SHA1 checksum: 6d12280b5cc33d17d752f475bf340b77ef3451ca
Package: elcspas, version: 03.13.00.S.154-3.S-ext, status: n/a
File: bootflash:Active_Dir/asr1000rp2-elcspas.03.13.00.S.154-3.S-ext.pkg, on: SIP0/0
Built: 2013-07-25_21.16, by: mcpre
File SHA1 checksum: 94763274fc807489410e299a45fd73fce9d67499
Package: sipspa, version: 03.13.00.S.154-3.S-ext, status: n/a
File: bootflash:Active_Dir/asr1000rp2-sipspa.03.13.00.S.154-3.S-ext.pkg, on: SIP0/1
Built: 2013-07-25_21.16, by: mcpre
File SHA1 checksum: 6d12280b5cc33d17d752f475bf340b77ef3451ca

```



```
Package: elcspa, version: 03.13.00.S.154-3.S-ext, status: n/a
File: bootflash:Active_Dir/asr1000rp2-elcspa.03.13.00.S.154-3.S-ext.pkg, on: SIP0/1
Built: 2013-07-25_21.16, by: mcpre
File SHA1 checksum: 94763274fc807489410e299a45fd73fce9d67499
Package: sipspa, version: 03.13.00.S.154-3.S-ext, status: n/a
File: bootflash:Active_Dir/asr1000rp2-sipspa.03.13.00.S.154-3.S-ext.pkg, on: SIP0/2
Built: 2013-07-25_21.16, by: mcpre
File SHA1 checksum: 6d12280b5cc33d17d752f475bf340b77ef3451ca
Package: elcspa, version: 03.13.00.S.154-3.S-ext, status: n/a
File: bootflash:Active_Dir/asr1000rp2-elcspa.03.13.00.S.154-3.S-ext.pkg, on: SIP0/2
Built: 2013-07-25_21.16, by: mcpre
File SHA1 checksum: 94763274fc807489410e299a45fd73fce9d67499
Package: sipspa, version: 03.13.00.S.154-3.S-ext, status: n/a
File: bootflash:Active_Dir/asr1000rp2-sipspa.03.13.00.S.154-3.S-ext.pkg, on: SIP0/3
Built: 2013-07-25_21.16, by: mcpre
File SHA1 checksum: 6d12280b5cc33d17d752f475bf340b77ef3451ca
Package: elcspa, version: 03.13.00.S.154-3.S-ext, status: n/a
File: bootflash:Active_Dir/asr1000rp2-elcspa.03.13.00.S.154-3.S-ext.pkg, on: SIP0/3
Built: 2013-07-25_21.16, by: mcpre
File SHA1 checksum: 94763274fc807489410e299a45fd73fce9d67499
Package: sipbase, version: 03.13.00.S.154-3.S-ext, status: n/a
File: bootflash:Active_Dir/asr1000rp2-sipbase.03.13.00.S.154-3.S-ext.pkg, on: SIP1
Built: 2013-07-25_21.16, by: mcpre
File SHA1 checksum: 3b6a4838972840a995ff22e73fd2bae910b268a7
Package: elcbase, version: 03.13.00.S.154-3.S-ext, status: n/a
File: bootflash:Active_Dir/asr1000rp2-elcbase.03.13.00.S.154-3.S-ext.pkg, on: SIP1
Built: 2013-07-25_21.16, by: mcpre
File SHA1 checksum: 99f8dc925083b118626a4e82d93079050db96826
Package: sipspa, version: 03.13.00.S.154-3.S-ext, status: n/a
File: bootflash:Active_Dir/asr1000rp2-sipspa.03.13.00.S.154-3.S-ext.pkg, on: SIP1/0
Built: 2013-07-25_21.16, by: mcpre
File SHA1 checksum: 6d12280b5cc33d17d752f475bf340b77ef3451ca
Package: elcspa, version: 03.13.00.S.154-3.S-ext, status: n/a
File: bootflash:Active_Dir/asr1000rp2-elcspa.03.13.00.S.154-3.S-ext.pkg, on: SIP1/0
Built: 2013-07-25_21.16, by: mcpre
File SHA1 checksum: 94763274fc807489410e299a45fd73fce9d67499
Package: sipspa, version: 03.13.00.S.154-3.S-ext, status: n/a
File: bootflash:Active_Dir/asr1000rp2-sipspa.03.13.00.S.154-3.S-ext.pkg, on: SIP1/1
Built: 2013-07-25_21.16, by: mcpre
File SHA1 checksum: 6d12280b5cc33d17d752f475bf340b77ef3451ca
Package: elcspa, version: 03.13.00.S.154-3.S-ext, status: n/a
File: bootflash:Active_Dir/asr1000rp2-elcspa.03.13.00.S.154-3.S-ext.pkg, on: SIP1/1
Built: 2013-07-25_21.16, by: mcpre
File SHA1 checksum: 94763274fc807489410e299a45fd73fce9d67499
Package: sipspa, version: 03.13.00.S.154-3.S-ext, status: n/a
File: bootflash:Active_Dir/asr1000rp2-sipspa.03.13.00.S.154-3.S-ext.pkg, on: SIP1/2
Built: 2013-07-25_21.16, by: mcpre
File SHA1 checksum: 6d12280b5cc33d17d752f475bf340b77ef3451ca
Package: elcspa, version: 03.13.00.S.154-3.S-ext, status: n/a
File: bootflash:Active_Dir/asr1000rp2-elcspa.03.13.00.S.154-3.S-ext.pkg, on: SIP1/2
Built: 2013-07-25_21.16, by: mcpre
File SHA1 checksum: 94763274fc807489410e299a45fd73fce9d67499
Package: sipspa, version: 03.13.00.S.154-3.S-ext, status: n/a
File: bootflash:Active_Dir/asr1000rp2-sipspa.03.13.00.S.154-3.S-ext.pkg, on: SIP1/3
Built: 2013-07-25_21.16, by: mcpre
File SHA1 checksum: 6d12280b5cc33d17d752f475bf340b77ef3451ca
Package: elcspa, version: 03.13.00.S.154-3.S-ext, status: n/a
File: bootflash:Active_Dir/asr1000rp2-elcspa.03.13.00.S.154-3.S-ext.pkg, on: SIP1/3
Built: 2013-07-25_21.16, by: mcpre
File SHA1 checksum: 94763274fc807489410e299a45fd73fce9d67499
Package: sipbase, version: 03.13.00.S.154-3.S-ext, status: n/a
File: bootflash:Active_Dir/asr1000rp2-sipbase.03.13.00.S.154-3.S-ext.pkg, on: SIP2
Built: 2013-07-25_21.16, by: mcpre
File SHA1 checksum: 3b6a4838972840a995ff22e73fd2bae910b268a7
```

## Examples

```

Package: elcbase, version: 03.13.00.S.154-3.S-ext, status: n/a
File: bootflash:Active_Dir/asr1000rp2-elcbase.03.13.00.S.154-3.S-ext.pkg, on: SIP2
Built: 2013-07-25_21.16, by: mcpre
File SHA1 checksum: 99f8dc925083b118626a4e82d93079050db96826
Package: sipspa, version: 03.13.00.S.154-3.S-ext, status: n/a
File: bootflash:Active_Dir/asr1000rp2-sipspa.03.13.00.S.154-3.S-ext.pkg, on: SIP2/0
Built: 2013-07-25_21.16, by: mcpre
File SHA1 checksum: 6d12280b5cc33d17d752f475bf340b77ef3451ca
Package: elcspa, version: 03.13.00.S.154-3.S-ext, status: n/a
File: bootflash:Active_Dir/asr1000rp2-elcspa.03.13.00.S.154-3.S-ext.pkg, on: SIP2/0
Built: 2013-07-25_21.16, by: mcpre
File SHA1 checksum: 94763274fc807489410e299a45fd73fce9d67499
Package: sipspa, version: 03.13.00.S.154-3.S-ext, status: n/a
File: bootflash:Active_Dir/asr1000rp2-sipspa.03.13.00.S.154-3.S-ext.pkg, on: SIP2/1
Built: 2013-07-25_21.16, by: mcpre
File SHA1 checksum: 6d12280b5cc33d17d752f475bf340b77ef3451ca
Package: elcspa, version: 03.13.00.S.154-3.S-ext, status: n/a
File: bootflash:Active_Dir/asr1000rp2-elcspa.03.13.00.S.154-3.S-ext.pkg, on: SIP2/1
Built: 2013-07-25_21.16, by: mcpre
File SHA1 checksum: 94763274fc807489410e299a45fd73fce9d67499
Package: sipspa, version: 03.13.00.S.154-3.S-ext, status: n/a
File: bootflash:Active_Dir/asr1000rp2-sipspa.03.13.00.S.154-3.S-ext.pkg, on: SIP2/2
Built: 2013-07-25_21.16, by: mcpre
File SHA1 checksum: 6d12280b5cc33d17d752f475bf340b77ef3451ca
Package: elcspa, version: 03.13.00.S.154-3.S-ext, status: n/a
File: bootflash:Active_Dir/asr1000rp2-elcspa.03.13.00.S.154-3.S-ext.pkg, on: SIP2/2
Built: 2013-07-25_21.16, by: mcpre
File SHA1 checksum: 94763274fc807489410e299a45fd73fce9d67499
Package: sipspa, version: 03.13.00.S.154-3.S-ext, status: n/a
File: bootflash:Active_Dir/asr1000rp2-sipspa.03.13.00.S.154-3.S-ext.pkg, on: SIP2/3
Built: 2013-07-25_21.16, by: mcpre
File SHA1 checksum: 6d12280b5cc33d17d752f475bf340b77ef3451ca
Package: elcspa, version: 03.13.00.S.154-3.S-ext, status: n/a
File: bootflash:Active_Dir/asr1000rp2-elcspa.03.13.00.S.154-3.S-ext.pkg, on: SIP2/3
Built: 2013-07-25_21.16, by: mcpre
File SHA1 checksum: 94763274fc807489410e299a45fd73fce9d67499
Package: sipbase, version: 03.13.00.S.154-3.S-ext, status: n/a
File: bootflash:Active_Dir/asr1000rp2-sipbase.03.13.00.S.154-3.S-ext.pkg, on: SIP3
Built: 2013-07-25_21.16, by: mcpre
File SHA1 checksum: 3b6a4838972840a995ff22e73fd2bae910b268a7
Package: elcbase, version: 03.13.00.S.154-3.S-ext, status: n/a
File: bootflash:Active_Dir/asr1000rp2-lcbase.03.13.00.S.154-3.S-ext.pkg, on: SIP3
Built: 2013-07-25_21.16, by: mcpre
File SHA1 checksum: 99f8dc925083b118626a4e82d93079050db96826
Package: sipspa, version: 03.13.00.S.154-3.S-ext, status: n/a
File: bootflash:Active_Dir/asr1000rp2-sipspa.03.13.00.S.154-3.S-ext.pkg, on: SIP3/0
Built: 2013-07-25_21.16, by: mcpre
File SHA1 checksum: 6d12280b5cc33d17d752f475bf340b77ef3451ca
Package: elcspa, version: 03.13.00.S.154-3.S-ext, status: n/a
File: bootflash:Active_Dir/asr1000rp2-elcspa.03.13.00.S.154-3.S-ext.pkg, on: SIP3/0
Built: 2013-07-25_21.16, by: mcpre
File SHA1 checksum: 94763274fc807489410e299a45fd73fce9d67499
Package: sipspa, version: 03.13.00.S.154-3.S-ext, status: n/a
File: bootflash:Active_Dir/asr1000rp2-sipspa.03.13.00.S.154-3.S-ext.pkg, on: SIP3/1
Built: 2013-07-25_21.16, by: mcpre
File SHA1 checksum: 6d12280b5cc33d17d752f475bf340b77ef3451ca
Package: elcspa, version: 03.13.00.S.154-3.S-ext, status: n/a
File: bootflash:Active_Dir/asr1000rp2-elcspa.03.13.00.S.154-3.S-ext.pkg, on: SIP3/1
Built: 2013-07-25_21.16, by: mcpre
File SHA1 checksum: 94763274fc807489410e299a45fd73fce9d67499
Package: sipspa, version: 03.13.00.S.154-3.S-ext, status: n/a
File: bootflash:Active_Dir/asr1000rp2-sipspa.03.13.00.S.154-3.S-ext.pkg, on: SIP3/2
Built: 2013-07-25_21.16, by: mcpre
File SHA1 checksum: 6d12280b5cc33d17d752f475bf340b77ef3451ca

```

```
Package: elcspa, version: 03.13.00.S.154-3.S-ext, status: n/a
File: bootflash:Active_Dir/asr1000rp2-elcspa.03.13.00.S.154-3.S-ext.pkg, on: SIP3/2
Built: 2013-07-25_21.16, by: mcpre
File SHA1 checksum: 94763274fc807489410e299a45fd73fce9d67499
Package: sipspa, version: 03.13.00.S.154-3.S-ext, status: n/a
File: bootflash:Active_Dir/asr1000rp2-sipspa.03.13.00.S.154-3.S-ext.pkg, on: SIP3/3
Built: 2013-07-25_21.16, by: mcpre
File SHA1 checksum: 6d12280b5cc33d17d752f475bf340b77ef3451ca
Package: elcspa, version: 03.13.00.S.154-3.S-ext, status: n/a
File: bootflash:Active_Dir/asr1000rp2-elcspa.03.13.00.S.154-3.S-ext.pkg, on: SIP3/3
Built: 2013-07-25_21.16, by: mcpre
File SHA1 checksum: 94763274fc807489410e299a45fd73fce9d67499
Package: sipbase, version: 03.13.00.S.154-3.S-ext, status: n/a
File: bootflash:Active_Dir/asr1000rp2-sipbase.03.13.00.S.154-3.S-ext.pkg, on: SIP4
Built: 2013-07-25_21.16, by: mcpre
File SHA1 checksum: 3b6a4838972840a995ff22e73fd2bae910b268a7
Package: elcbase, version: 03.13.00.S.154-3.S-ext, status: n/a
File: bootflash:Active_Dir/asr1000rp2-elcbase.03.13.00.S.154-3.S-ext.pkg, on: SIP4
Built: 2013-07-25_21.16, by: mcpre
File SHA1 checksum: 99f8dc925083b118626a4e82d93079050db96826
Package: sipspa, version: 03.13.00.S.154-3.S-ext, status: n/a
File: bootflash:Active_Dir/asr1000rp2-sipspa.03.13.00.S.154-3.S-ext.pkg, on: SIP4/0
Built: 2013-07-25_21.16, by: mcpre
File SHA1 checksum: 6d12280b5cc33d17d752f475bf340b77ef3451ca
Package: elcspa, version: 03.13.00.S.154-3.S-ext, status: n/a
File: bootflash:Active_Dir/asr1000rp2-elcspa.03.13.00.S.154-3.S-ext.pkg, on: SIP4/0
Built: 2013-07-25_21.16, by: mcpre
File SHA1 checksum: 94763274fc807489410e299a45fd73fce9d67499
Package: sipspa, version: 03.13.00.S.154-3.S-ext, status: n/a
File: bootflash:Active_Dir/asr1000rp2-sipspa.03.13.00.S.154-3.S-ext.pkg, on: SIP4/1
Built: 2013-07-25_21.16, by: mcpre
File SHA1 checksum: 6d12280b5cc33d17d752f475bf340b77ef3451ca
Package: elcspa, version: 03.13.00.S.154-3.S-ext, status: n/a
File: bootflash:Active_Dir/asr1000rp2-elcspa.03.13.00.S.154-3.S-ext.pkg, on: SIP4/1
Built: 2013-07-25_21.16, by: mcpre
File SHA1 checksum: 94763274fc807489410e299a45fd73fce9d67499
Package: sipspa, version: 03.13.00.S.154-3.S-ext, status: n/a
File: bootflash:Active_Dir/asr1000rp2-sipspa.03.13.00.S.154-3.S-ext.pkg, on: SIP4/2
Built: 2013-07-25_21.16, by: mcpre
File SHA1 checksum: 6d12280b5cc33d17d752f475bf340b77ef3451ca
Package: elcspa, version: 03.13.00.S.154-3.S-ext, status: n/a
File: bootflash:Active_Dir/asr1000rp2-elcspa.03.13.00.S.154-3.S-ext.pkg, on: SIP4/2
Built: 2013-07-25_21.16, by: mcpre
File SHA1 checksum: 94763274fc807489410e299a45fd73fce9d67499
Package: sipspa, version: 03.13.00.S.154-3.S-ext, status: n/a
File: bootflash:Active_Dir/asr1000rp2-sipspa.03.13.00.S.154-3.S-ext.pkg, on: SIP4/3
Built: 2013-07-25_21.16, by: mcpre
File SHA1 checksum: 6d12280b5cc33d17d752f475bf340b77ef3451ca
Package: elcspa, version: 03.13.00.S.154-3.S-ext, status: n/a
File: bootflash:Active_Dir/asr1000rp2-elcspa.03.13.00.S.154-3.S-ext.pkg, on: SIP4/3
Built: 2013-07-25_21.16, by: mcpre
File SHA1 checksum: 94763274fc807489410e299a45fd73fce9d67499
Package: sipbase, version: 03.13.00.S.154-3.S-ext, status: n/a
File: bootflash:Active_Dir/asr1000rp2-sipbase.03.13.00.S.154-3.S-ext.pkg, on: SIP5
Built: 2013-07-25_21.16, by: mcpre
File SHA1 checksum: 3b6a4838972840a995ff22e73fd2bae910b268a7
Package: elcbase, version: 03.13.00.S.154-3.S-ext, status: n/a
File: bootflash:Active_Dir/asr1000rp2-elcbase.03.13.00.S.154-3.S-ext.pkg, on: SIP5
Built: 2013-07-25_21.16, by: mcpre
File SHA1 checksum: 99f8dc925083b118626a4e82d93079050db96826
Package: sipspa, version: 03.13.00.S.154-3.S-ext, status: n/a
File: bootflash:Active_Dir/asr1000rp2-sipspa.03.13.00.S.154-3.S-ext.pkg, on: SIP5/0
Built: 2013-07-25_21.16, by: mcpre
File SHA1 checksum: 6d12280b5cc33d17d752f475bf340b77ef3451ca
```

```

Package: elcspa, version: 03.13.00.S.154-3.S-ext, status: n/a
File: bootflash:Active_Dir/asr1000rp2-elcspa.03.13.00.S.154-3.S-ext.pkg, on: SIP5/0
Built: 2013-07-25_21.16, by: mcpre
File SHA1 checksum: 94763274fc807489410e299a45fd73fce9d67499
Package: sipspa, version: 03.13.00.S.154-3.S-ext, status: n/a
File: bootflash:Active_Dir/asr1000rp2-sipspa.03.13.00.S.154-3.S-ext.pkg, on: SIP5/1
Built: 2013-07-25_21.16, by: mcpre
File SHA1 checksum: 6d12280b5cc33d17d752f475bf340b77ef3451ca
Package: elcspa, version: 03.13.00.S.154-3.S-ext, status: n/a
File: bootflash:Active_Dir/asr1000rp2-elcspa.03.13.00.S.154-3.S-ext.pkg, on: SIP5/1
Built: 2013-07-25_21.16, by: mcpre
File SHA1 checksum: 94763274fc807489410e299a45fd73fce9d67499
Package: sipspa, version: 03.13.00.S.154-3.S-ext, status: n/a
File: bootflash:Active_Dir/asr1000rp2-sipspa.03.13.00.S.154-3.S-ext.pkg, on: SIP5/2
Built: 2013-07-25_21.16, by: mcpre
File SHA1 checksum: 6d12280b5cc33d17d752f475bf340b77ef3451ca
Package: elcspa, version: 03.13.00.S.154-3.S-ext, status: n/a
File: bootflash:Active_Dir/asr1000rp2-elcspa.03.13.00.S.154-3.S-ext.pkg, on: SIP5/2
Built: 2013-07-25_21.16, by: mcpre
File SHA1 checksum: 94763274fc807489410e299a45fd73fce9d67499
Package: sipspa, version: 03.13.00.S.154-3.S-ext, status: n/a
File: bootflash:Active_Dir/asr1000rp2-sipspa.03.13.00.S.154-3.S-ext.pkg, on: SIP5/3
Built: 2013-07-25_21.16, by: mcpre
File SHA1 checksum: 6d12280b5cc33d17d752f475bf340b77ef3451ca
Package: elcspa, version: 03.13.00.S.154-3.S-ext, status: n/a
File: bootflash:Active_Dir/asr1000rp2-elcspa.03.13.00.S.154-3.S-ext.pkg, on: SIP5/3
Built: 2013-07-25_21.16, by: mcpre
File SHA1 checksum: 94763274fc807489410e299a45fd73fce9d67499
Router# reload
<some output removed for brevity>
Router# request platform software package clean
Cleaning up unnecessary package files
No path specified, will use booted path bootflash:Active_Dir/packages.conf
Cleaning bootflash:Active_Dir
 Scanning boot directory for packages ... done.
 Preparing packages list to delete ...
 asr1000rp2-elcbase.03.13.00.S.154-3.S-ext.pkg

File is in use, will not delete.
 asr1000rp2-elcspa.03.13.00.S.154-3.S-ext.pkg

File is in use, will not delete.
 asr1000rp2-espbase.03.13.00.S.154-3.S-ext.pkg

File is in use, will not delete.
 asr1000rp2-esp86base.03.13.00.S.154-3.S-ext.pkg

File is in use, will not delete.
 asr1000rp2-rpaccess.03.13.00.S.154-3.S-ext.pkg

File is in use, will not delete.
 asr1000rp2-rpbase.03.13.00.S.154-3.S-ext.pkg

File is in use, will not delete.
 asr1000rp2-rpcontrol.03.13.00.S.154-3.S-ext.pkg

File is in use, will not delete.
 asr1000rp2-rpios-adventerprise9.03.13.00.S.154-3.S-ext.pkg

File is in use, will not delete.
 asr1000rp2-sipbase.03.13.00.S.154-3.S-ext.pkg
File is in use, will not delete.
 asr1000rp2-sipspa.03.13.00.S.154-3.S-ext.pkg

```

```

File is in use, will not delete.
 packages.conf

File is in use, will not delete.
done.
Files that will be deleted:
 asr1000rp2-elcbase.03.12.01.S.154-2.S.pkg
 asr1000rp2-elcspa.03.12.01.S.154-2.S.pkg
 asr1000rp2-espbase.03.12.01.S.154-2.S.pkg
 asr1000rp2-esp86base.03.12.01.S.154-2.S.pkg
 asr1000rp2-packages-adventerprisek9.03.12.01.S.154-2.S.conf
 asr1000rp2-rpaccess.03.12.01.S.154-2.S.pkg
 asr1000rp2-rpbase.03.12.01.S.154-2.S.pkg
 asr1000rp2-rpcontrol.03.12.01.S.154-2.S.pkg
 asr1000rp2-rpios-adventerprisek9.03.12.01.S.154-2.S.pkg
 asr1000rp2-sipbase.03.12.01.S.154-2.S.pkg
 asr1000rp2-sipspa.03.12.01.S.154-2.S.pkg
 packages.conf.00-
 packages.conf.01-
 packages.conf.02-
 packages.conf.03-
 packages.conf.04-
 packages.conf.05-
Do you want to proceed? [confirm]y
 Deleting file bootflash:Active_Dir/asr1000rp2-elcbase.03.12.01.S.154-2.S.pkg ... done.
 Deleting file bootflash:Active_Dir/asr1000rp2-elcspa.03.12.01.S.154-2.S.pkg ... done.
 Deleting file bootflash:Active_Dir/asr1000rp2-espbase.03.12.01.S.154-2.S.pkg ... done.
 Deleting file bootflash:Active_Dir/asr1000rp2-esp86base.03.12.01.S.154-2.S.pkg ... doe.
 Deleting file
bootflash:Active_Dir/asr1000rp2-packages-adventerprisek9.03.12.01.S.154-2.S.conf ... done.
 Deleting file bootflash:Active_Dir/asr1000rp2-rpaccess.03.12.01.S.154-2.S.pkg ... done.
 Deleting file bootflash:Active_Dir/asr1000rp2-rpbase.03.12.01.S.154-2.S.pkg ... done.
 Deleting file bootflash:Active_Dir/asr1000rp2-rpcontrol.03.12.01.S.154-2.S.pkg ... done.
 Deleting file bootflash:Active_Dir/asr1000rp2-rpios-adventerprisek9.03.12.01.S.154-2.S.pkg
... done.
 Deleting file bootflash:Active_Dir/asr1000rp2-sipbase.03.12.01.S.154-2.S.pkg ... done.
 Deleting file bootflash:Active_Dir/asr1000rp2-sipspa.03.12.01.S.154-2.S.pkg ... done.
 Deleting file bootflash:Active_Dir/packages.conf.00- ... done.
 Deleting file bootflash:Active_Dir/packages.conf.01- ... done.
 Deleting file bootflash:Active_Dir/packages.conf.02- ... done.
 Deleting file bootflash:Active_Dir/packages.conf.03- ... done.
 Deleting file bootflash:Active_Dir/packages.conf.04- ... done.
 Deleting file bootflash:Active_Dir/packages.conf.05- ... done.
SUCCESS: Files deleted.

```

## Using Subpackages for Software Upgrade on a Cisco ASR 1002 Router or Cisco ASR 1004 Router (request platform Command Set)

This section provides instructions on using software upgrade for Cisco ASR 1002 or 1004 Router running subpackages using the **request platform** command set. Cisco ASR 1002 Router is not supported on Polaris 16.x.x release.

These instructions assume two IOS processes are active on the RP and that the router is already running using subpackages.



**Note** Step 17, 18, and 19 does not have to be performed immediately, and can be done at a convenient time.

## SUMMARY STEPS

1. **show version**
2. **redundancy**
3. **mkdir** *URL-to-directory-name*
4. **ip tftp** *source-interface gigabitethernet port*
5. **copy tftp:** *URL-to-target-location*
6. **request platform software package expand file** *URL-to-consolidated-package*
7. **dir** *target-URL*
8. **copy** *file-system:asr1000rp2-espbase.version.pkg URL-to-directory-of-sub-packages-active-RP*
9. **request platform software package install rp 0**  
*filefile-system:asr1000rp2-{rpaccess,rpios,rpcontrol}\*version-string\*.pkg baystandby-bayforce*
10. **redundancy force-switchover**
11. (Optional) **show platform**
12. **request platform software package install rp 0**  
*filefile-system:asr1000rp2-{rpaccess,rpios,rpcontrol}\*version-string\*.pkg baystandby-bayforce*
13. **request platform software package install rp 0 file**  
*file-system:asr1000rp2-{sipbase,sipspace}\*version\*.pkg slot SIP-slot-number force*
14. **request platform software package install rp 0 file**  
*file-system:asr1000rp2-{elcase,elcspa}\*version\*.pkg slot SIP-slot-number force*
15. **request platform software package install rp 0 file** *file-system:asr1000rp2-esp\*version\*.pkg force*
16. **request platform software package install rp 0 file** *file-system:asr1000rp\*version\*.pkg*
17. **show version installed**
18. **reload**
19. **request platform software package clean**

## DETAILED STEPS

|        | Command or Action                                                                                                                                                                                                                                                                                                                                                                          | Purpose                                                                                                                                                                                                                                                                                                                                                                                                                                                                                                                                                                                                                                                                               |
|--------|--------------------------------------------------------------------------------------------------------------------------------------------------------------------------------------------------------------------------------------------------------------------------------------------------------------------------------------------------------------------------------------------|---------------------------------------------------------------------------------------------------------------------------------------------------------------------------------------------------------------------------------------------------------------------------------------------------------------------------------------------------------------------------------------------------------------------------------------------------------------------------------------------------------------------------------------------------------------------------------------------------------------------------------------------------------------------------------------|
| Step 1 | <p><b>show version</b></p> <p><b>Example:</b></p> <pre>show version installed</pre> <p><b>Example:</b></p> <pre>dir filesystem:&lt;directory&gt;</pre> <p><b>Example:</b></p> <pre>show platform</pre> <p><b>Example:</b></p> <pre>show redundancy-states</pre> <p><b>Example:</b></p> <pre>Router# show version</pre> <p><b>Example:</b></p> <pre>Router# show version r0 installed</pre> | <p>(Optional) Use the following commands to confirm the current router configuration, as follows:</p> <ul style="list-style-type: none"> <li>• <b>show version</b> and <b>show version active-rp installed</b>—Verify the running version of the Cisco IOS XE software on the router, and which file was used to boot the router, and where that file is stored.</li> <li>• <b>dir</b>—Confirm that the files that were used to boot the router are located in the directory.</li> <li>• <b>show platform</b>—Confirm the current status of the active and standby RPs.</li> <li>• <b>show redundancy states</b>—Confirm the operational and configured redundancy states.</li> </ul> |

|               | Command or Action                                                                                                                                                                               | Purpose                                                                                                                                                                                                                                                                                                                                                                 |
|---------------|-------------------------------------------------------------------------------------------------------------------------------------------------------------------------------------------------|-------------------------------------------------------------------------------------------------------------------------------------------------------------------------------------------------------------------------------------------------------------------------------------------------------------------------------------------------------------------------|
|               | <p><b>Example:</b></p> <pre>Router# dir bootflash:</pre> <p><b>Example:</b></p> <pre>Router# show platform</pre> <p><b>Example:</b></p> <pre>Router# show redundancy-states</pre>               |                                                                                                                                                                                                                                                                                                                                                                         |
| <b>Step 2</b> | <p><b>redundancy</b></p> <p><b>Example:</b></p> <pre>mode sso</pre> <p><b>Example:</b></p> <pre>Router(config)# redundancy</pre> <p><b>Example:</b></p> <pre>Router(config-red)# mode sso</pre> | <p>Configure SSO if it is not already configured.</p> <p><b>Note</b> Save the configuration after making this configuration step.</p>                                                                                                                                                                                                                                   |
| <b>Step 3</b> | <p><b>mkdir</b> <i>URL-to-directory-name</i></p> <p><b>Example:</b></p> <pre>Router# mkdir usb0:221subs</pre>                                                                                   | <p>Create a directory to store the consolidated package and subpackages.</p> <p>This directory must be created in most cases because the consolidated packages and subpackages have to be separated from the subpackages that booted the router at this step of the procedure.</p>                                                                                      |
| <b>Step 4</b> | <p><b>ip tftp</b> <i>source-interface gigabitethernet port</i></p> <p><b>Example:</b></p> <pre>Router(config)# ip tftp source-interface gigabitethernet 0</pre>                                 | <p>Specifies the Gigabit Ethernet TFTP source-interface to be configured:</p> <p>slot/port—Specifies the location of the TFTP source-interface.</p> <p><b>Note</b> To copy a file using TFTP through the Management Ethernet interface, the <b>ip tftp source-interface GigabitEthernet 0</b> command must be entered before entering the <b>copy tftp</b> command.</p> |
| <b>Step 5</b> | <p><b>copy tftp:</b> <i>URL-to-target-location</i></p> <p><b>Example:</b></p> <pre>Router# copy tftp: usb0:221subs</pre>                                                                        | <p>Copy the consolidated package file into the directory created in <a href="#">Step 3</a>.</p> <p>The consolidated package in this step should not be copied into the same directory where the subpackages that are currently running your router are stored (the directory containing the packages.conf provisioning file from which the router was booted).</p>      |

|               | Command or Action                                                                                                                                                                                                                                                                                                                                                                                                                                                                                                                                                                                                                                                                                                                                                                              | Purpose                                                                                                                                                                                                                                                                                                                                                                                                                                                                             |
|---------------|------------------------------------------------------------------------------------------------------------------------------------------------------------------------------------------------------------------------------------------------------------------------------------------------------------------------------------------------------------------------------------------------------------------------------------------------------------------------------------------------------------------------------------------------------------------------------------------------------------------------------------------------------------------------------------------------------------------------------------------------------------------------------------------------|-------------------------------------------------------------------------------------------------------------------------------------------------------------------------------------------------------------------------------------------------------------------------------------------------------------------------------------------------------------------------------------------------------------------------------------------------------------------------------------|
|               |                                                                                                                                                                                                                                                                                                                                                                                                                                                                                                                                                                                                                                                                                                                                                                                                | <p><b>Tip</b> It is recommended that you copy the package onto a usb: or harddisk: file system for space considerations when performing this step of the procedure.</p>                                                                                                                                                                                                                                                                                                             |
| <b>Step 6</b> | <p><b>request platform software package expand file</b><br/><i>URL-to-consolidated-package</i></p> <p><b>Example:</b></p> <pre>Router# request platform software package expand file usb0:221subs/asr1000rp2-enterprise9.03.13.00.S.154-3-set.bin</pre>                                                                                                                                                                                                                                                                                                                                                                                                                                                                                                                                        | <p>Extract the subpackages out of the consolidated package file into the temporary directory.</p> <p><b>Note</b> Take extra care to extract the subpackages to a temporary subdirectory and do not delete any of the files currently running the router at this point of the procedure. To erase the files that were running on the router before the ISSU upgrade, enter the <b>request platform software package clean</b> command after the ISSU upgrade has been completed.</p> |
| <b>Step 7</b> | <p><b>dir target-URL</b></p> <p><b>Example:</b></p> <pre>Router# dir usb0:221subs</pre>                                                                                                                                                                                                                                                                                                                                                                                                                                                                                                                                                                                                                                                                                                        | (Optional) Display the directory to confirm that the files were extracted.                                                                                                                                                                                                                                                                                                                                                                                                          |
| <b>Step 8</b> | <p><b>copy file-system:asr1000rp2-espbase.version.pkg</b><br/><i>URL-to-directory-of-sub-packages-active-RP</i></p> <p><b>Example:</b></p> <pre>copy file-system:asr1000rp2-espx86base.version.pkg URL-to-directory-of-sub-packages-active-RP</pre> <p><b>Example:</b></p> <pre>copy file-system:asr1000rp2-rpaccess.version.pkg URL-to-directory-of-sub-packages-active-RP</pre> <p><b>Example:</b></p> <pre>copy file-system:asr1000rp2-rpbase.version.pkg URL-to-directory-of-sub-packages-active-RP</pre> <p><b>Example:</b></p> <pre>copy file-system:asr1000rp2-rpcontrol.version.pkg URL-to-directory-of-sub-packages-active-RP</pre> <p><b>Example:</b></p> <pre>copy file-system:asr1000rp2-rpios.version.pkg URL-to-directory-of-sub-packages-active-RP</pre> <p><b>Example:</b></p> | <p>Copy the subpackages out of the temporary directory into the directory on the router where the subpackages running the active RP are currently stored.</p> <p><b>Note</b> From Polaris release 16.x.x, two new packages: rpboot and webui are introduced.</p>                                                                                                                                                                                                                    |



|  | Command or Action                                                                                                                                                                                                                                                                                                                                                                                                                                                                                                                                                                                                                                                                                                                                                                                                                                                                                                                                                                                                                                                                                                                                                                                                                                             | Purpose |
|--|---------------------------------------------------------------------------------------------------------------------------------------------------------------------------------------------------------------------------------------------------------------------------------------------------------------------------------------------------------------------------------------------------------------------------------------------------------------------------------------------------------------------------------------------------------------------------------------------------------------------------------------------------------------------------------------------------------------------------------------------------------------------------------------------------------------------------------------------------------------------------------------------------------------------------------------------------------------------------------------------------------------------------------------------------------------------------------------------------------------------------------------------------------------------------------------------------------------------------------------------------------------|---------|
|  | <p><b>copy</b><br/> <i>file-system:asr1000rp2-sipbase.version.pkg</i><br/> <i>URL-to-directory-of-sub-packages-active-RP</i></p> <p><b>Example:</b></p> <p><b>copy</b><br/> <i>file-system:asr1000rp2-sipspa.version.pkg</i><br/> <i>URL-to-directory-of-sub-packages-active-RP</i></p> <p><b>Example:</b></p> <p><b>copy</b><br/> <i>file-system:asr1000rp2-elcbase.version.pkg</i><br/> <i>URL-to-directory-of-sub-packages-active-RP</i></p> <p><b>Example:</b></p> <p><b>copy</b><br/> <i>file-system:asr1000rp2-elcspa.version.pkg</i><br/> <i>URL-to-directory-of-sub-packages-active-RP</i></p> <p><b>Example:</b></p> <pre>Router# copy usb0:221subs/asr1000rp2-esbase.03.13.00.S.154-3.S-ext.pkg bootflash:</pre> <p><b>Example:</b></p> <pre>Router# copy usb0:221subs/asr1000rp2-esbase.03.13.00.S.154-3.S-ext.pkg bootflash:</pre> <p><b>Example:</b></p> <pre>Router# copy usb0:221subs/asr1000rp2-rpaccess.03.13.00.S.154-3.S-ext.pkg bootflash:</pre> <p><b>Example:</b></p> <pre>Router# copy usb0:221subs/asr1000rp2-rbase.03.13.00.S.154-3.S-ext.pkg bootflash:</pre> <p><b>Example:</b></p> <pre>Router# copy usb0:221subs/asr1000rp2-rpcontrol.03.13.00.S.154-3.S-ext.pkg bootflash:</pre> <p><b>Example:</b></p> <pre>Router# copy</pre> |         |

|                | Command or Action                                                                                                                                                                                                                                                                                                                                                                                                                                                             | Purpose                                                                                                                                                                                                                                                                                                                                                                        |
|----------------|-------------------------------------------------------------------------------------------------------------------------------------------------------------------------------------------------------------------------------------------------------------------------------------------------------------------------------------------------------------------------------------------------------------------------------------------------------------------------------|--------------------------------------------------------------------------------------------------------------------------------------------------------------------------------------------------------------------------------------------------------------------------------------------------------------------------------------------------------------------------------|
|                | <pre>usb0:221subs/asr1000rp2-rpic-ent-erisk.03.13.00.S.154-3.S-ext.pkg bootflash:  Example:  Router# copy usb0:221subs/asr1000rp2-sipbase.03.13.00.S.154-3.S-ext.pkg bootflash:  Example:  Router# copy usb0:221subs/asr1000rp2-sipspa.03.13.00.S.154-3.S-ext.pkg bootflash:  Example:  Router# copy usb0:221subs/asr1000rp2-elcbase.03.13.00.S.154-3.S-ext.pkg bootflash:  Example:  Router# copy usb0:221subs/asr1000rp2-elcspa.03.13.00.S.154-3.S-ext.pkg bootflash:</pre> |                                                                                                                                                                                                                                                                                                                                                                                |
| <b>Step 9</b>  | <pre>request platform software package install rp 0 file-system:asr1000rp2-(raccess,rpios,rpcontrol)*version-string*.pkg baystandby-bayforce  Example:  Router# request platform software package install rp 0 file bootflash:asr1000rp2-(raccess,rpios,rpcontrol)*03.13.00.S.154-3.S-ext.pkg bay 1 force</pre>                                                                                                                                                               | Upgrade the RPAccess, RPIOS, and RPControl subpackages in the standby bay.                                                                                                                                                                                                                                                                                                     |
| <b>Step 10</b> | <pre>redundancy force-switchover  Example:  Router# redundancy force-switchover</pre>                                                                                                                                                                                                                                                                                                                                                                                         | <p>Force a switchover from the active IOS process to the standby IOS process.</p> <p><b>Note</b> Your connection to the router often drops and is expected behavior at this point of the procedure in many scenarios.If this step drops your connection to the router, wait a few minutes before reconnecting to the router and then continue to <a href="#">Step 11</a> .</p> |
| <b>Step 11</b> | <pre>(Optional) show platform  Example:  Router# show platform</pre>                                                                                                                                                                                                                                                                                                                                                                                                          | (Optional) Monitor system state to ensure both IOS processes are active.                                                                                                                                                                                                                                                                                                       |

|         | Command or Action                                                                                                                                                                                                                                                                                                                                                                                                                                                                                                                                                                                                                                                                                                | Purpose                                                                                                                                                                                                                                                                                                                                                                                                                                                                                                                                                                                                                                                                                                                                                                                                                                                             |
|---------|------------------------------------------------------------------------------------------------------------------------------------------------------------------------------------------------------------------------------------------------------------------------------------------------------------------------------------------------------------------------------------------------------------------------------------------------------------------------------------------------------------------------------------------------------------------------------------------------------------------------------------------------------------------------------------------------------------------|---------------------------------------------------------------------------------------------------------------------------------------------------------------------------------------------------------------------------------------------------------------------------------------------------------------------------------------------------------------------------------------------------------------------------------------------------------------------------------------------------------------------------------------------------------------------------------------------------------------------------------------------------------------------------------------------------------------------------------------------------------------------------------------------------------------------------------------------------------------------|
| Step 12 | <p><b>request platform software package install rp 0</b><br/> <i>file-system:asr1000rp2-{raccess,rpios,rpcontrol}*version-string*.pkg</i><br/> <b>bay standby-bay force</b></p> <p><b>Example:</b></p> <pre>Router# request platform software package install rp 0 file bootflash:asr1000rp2-{raccess,rpios,rpcontrol}*03.13.00.S.154-3.S-ext*.pkg bay 0 force</pre>                                                                                                                                                                                                                                                                                                                                             | <p>Upgrade the RPAccess, RPIOS, and RPControl subpackages in the standby bay, which in this context is the opposite bay used in <a href="#">Step 9</a>.</p> <p><b>Note</b> The <i>pattern</i> options used in this CLI (<b>raccess</b>, <b>rpios</b>, and <b>rpcontrol</b>) were introduced in Cisco IOS XE Release 2.1.2 and are not available in previous Cisco IOS XE Releases. See the <a href="#">ISSU Procedures (Prior to Cisco IOS XE Release 2.1.2)</a>, on page 157 for pre-Cisco IOS XE Release 2.1.2 ISSU upgrade procedures.</p>                                                                                                                                                                                                                                                                                                                       |
| Step 13 | <p><b>request platform software package install rp 0 file</b><br/> <i>file-system:asr1000rp2-{sipbase,sipspa}*version*.pkg</i><br/> <b>slot SIP-slot-number force</b></p> <p><b>Example:</b></p> <pre>Router# request platform software package install rp 0 file bootflash:asr1000rp2-{sipspa,sipbase}*03.13.00.S.154-3.S-ext*.pkg slot 0 force</pre> <p><b>Example:</b></p> <pre>Router# request platform software package install rp 0 file bootflash:asr1000rp2-{sipspa,sipbase}*03.13.00.S.154-3.S-ext*.pkg slot 1 force</pre> <p><b>Example:</b></p> <pre>Router# request platform software package install rp 0 file bootflash:asr1000rp2-{sipspa,sipbase}*03.13.00.S.154-3.S-ext*.pkg slot 2 force</pre> | <p>Upgrade the SIP and SPA subpackages for each SIP on the router.</p> <p><b>Note</b> This step must be completed one SIP at a time, and repeated for each SIP installed on the router before performing the next step.</p> <p><b>Tip</b> You can use the <b>show ip interface brief</b> command to identify which slots contain SIPs and SPAs. The interfaces with three numbers (in the form <i>SIP-number/SPA-number/interface-number</i>) identify the SIP and SPA locations in the router.</p> <p><b>Note</b> The <i>pattern</i> options used in this CLI (<b>sipbase</b> and <b>sipspa</b>) were introduced in Cisco IOS XE Release 2.1.2 and are not available in previous Cisco IOS XE Releases. See the <a href="#">ISSU Procedures (Prior to Cisco IOS XE Release 2.1.2)</a>, on page 157 for pre-Cisco IOS XE Release 2.1.2 ISSU upgrade procedures.</p> |
| Step 14 | <p><b>request platform software package install rp 0 file</b><br/> <i>file-system:asr1000rp2-{elcase,elcspa}*version*.pkg</i><br/> <b>SIP-slot-number force</b></p> <p><b>Example:</b></p> <p>Repeat this step for each ELC installed in your router before proceeding to the next step.</p> <p><b>Example:</b></p> <pre>Router# request platform software package install rp 0 file bootflash:asr1000rp2-{elcspa,elcase}*03.13.00.S.154-3.S-ext*.pkg slot 0 force</pre>                                                                                                                                                                                                                                         | <p>Upgrade the ELC and SPA subpackages for each ELC on the router.</p> <p><b>Note</b> This step must be completed for one ELC at a time, and repeated for each ELC installed on the router before performing the next step.</p> <p><b>Tip</b> You can use the <b>show ip interface brief</b> command to identify which slots contain SIPs and SPAs. The interfaces with three numbers (in the form <i>ELC-number/SPA-number/interface-number</i>) identify the ELC and SPA locations in the router.</p>                                                                                                                                                                                                                                                                                                                                                             |

|                | Command or Action                                                                                                                                                                                                                                                                                                                                       | Purpose                                                                                                                                                                                                                                                                                                                                   |
|----------------|---------------------------------------------------------------------------------------------------------------------------------------------------------------------------------------------------------------------------------------------------------------------------------------------------------------------------------------------------------|-------------------------------------------------------------------------------------------------------------------------------------------------------------------------------------------------------------------------------------------------------------------------------------------------------------------------------------------|
|                | <p><b>Example:</b></p> <pre>Router# request platform software package install rp 0 file bootflash:asr1000rp2-(elcsp,elcbase)*03.13.00.S.154-3.S-ext*.pkg slot 1 force</pre> <p><b>Example:</b></p> <pre>Router# request platform software package install rp 0 file bootflash:asr1000rp2-(elcsp,elcbase)*03.13.00.S.154-3.S-ext*.pkg slot 2 force</pre> | <p><b>Note</b> The <i>pattern</i> options used in this CLI (<b>elcbase</b> and <b>elcspa</b>) were introduced in Cisco IOS XE Release 3.10S and are not available in previous Cisco IOS XE Releases</p>                                                                                                                                   |
| <b>Step 15</b> | <pre>request platform software package install rp 0 file file-system:asr1000rp2-esp*version*.pkg force</pre> <p><b>Example:</b></p> <pre>Router# request platform software package install rp 0 file bootflash:asr1000rp2-esp*03.13.00.S.154-3.S-ext*.pkg force</pre>                                                                                   | Upgrade the ESP Base subpackage.                                                                                                                                                                                                                                                                                                          |
| <b>Step 16</b> | <pre>request platform software package install rp 0 filefile-system:asr1000rp*version*.pkg</pre> <p><b>Example:</b></p> <pre>Router# request platform software package install rp 0 file bootflash:asr1000rp*03.13.00.S.154-3.S-ext*.pkg</pre>                                                                                                          | <p>Upgrade all subpackages, including the RPBase subpackage, which is the last subpackage that needs to be upgraded.</p> <p><b>Note</b> This step is required to ensure that all subpackages on the router were upgraded as part of this procedure, and might upgrade some subpackages that would otherwise be missed in the process.</p> |
| <b>Step 17</b> | <pre>show version installed</pre> <p><b>Example:</b></p> <pre>Router# show version installed</pre>                                                                                                                                                                                                                                                      | (Optional) Verify that the subpackages are properly installed.                                                                                                                                                                                                                                                                            |
| <b>Step 18</b> | <pre>reload</pre> <p><b>Example:</b></p> <pre>Router# reload</pre>                                                                                                                                                                                                                                                                                      | <p>Reload the RP.</p> <p><b>Tip</b> The router will continue normal operation even without a reload, so you can reload the router during scheduled maintenance or a slower traffic period.</p>                                                                                                                                            |
| <b>Step 19</b> | <pre>request platform software package clean</pre>                                                                                                                                                                                                                                                                                                      | (Optional) Removes the unused subpackages from the router.                                                                                                                                                                                                                                                                                |

## Examples

The following example shows the software upgrade for Cisco ASR 1002 or 1004 Router running sub-packages:

```

Router# show version
Cisco IOS Software, IOS-XE Software (X86_64_LINUX_IOSD-ADVENTERPRISEK9-M), Version 15.3(2)S,
 RELEASE SOFTWARE (fcl)
<output removed for brevity>
System image file is "bootflash:Active_Dir/packages.conf"
<output removed for brevity>
cisco ASR1004 (RP2) processor with 1546489K/6147K bytes of memory.
Processor board ID FOX1339G0QJ
32 Gigabit Ethernet interfaces
2 Ten Gigabit Ethernet interfaces
32768K bytes of non-volatile configuration memory.
388608K bytes of physical memory.
933311K bytes of eUSB flash at bootflash:.
78085207K bytes of SATA hard disk at harddisk:
Configuration register is 0x2102
Router# show version installed
Package: Provisioning File, version: n/a, status: active
 File: bootflash:Active_Dir/packages.conf, on: RP0
 Built: n/a, by: n/a
 File SHA1 checksum: a624f70f68c60292f4482433f43afd92487a55c4
 Package: rpbase, version: 03.12.01.S.154-2.S, status: active

File: bootflash:Active_Dir/asr1000rp2-rpbase.03.12.01.S.154-2.S.pkg, on: RP0
 Built: 2013-03-25_18.48, by: mcpre
 File SHA1 checksum: 3a9675142898cfac350d4e42f0e37bd9f4e48538
 Package: rpcontrol, version: 03.12.01.S.154-2.S, status: active
File: bootflash:Active_Dir/asr1000rp2-rpcontrol.03.12.01.S.154-2.S.pkg, on: RP0/0
 Built: 2013-03-25_18.48, by: mcpre
 File SHA1 checksum: 87b11f863f67fdf2610ee0769b929baab4c3efad
<output removed for brevity>
Router# show redundancy states
my state = 13 -ACTIVE
 peer state = 8 -STANDBY HOT
 Mode = Duplex
 Unit = Primary
 Unit ID = 48
Redundancy Mode (Operational) = sso
Redundancy Mode (Configured) = sso
Redundancy State = sso
Maintenance Mode = Disabled
Manual Swact = enabled
Communications = Up
client count = 107
client_notification_TMR = 30000 milliseconds
RF debug mask = 0x0
Router# show platform

Chassis type: ASR1004

```

| Slot | Type               | State       | Insert time (ago) |
|------|--------------------|-------------|-------------------|
| 0    | ASR1000-2T+20X1GE  | ok          | 00:04:19          |
| 0/0  | BUILT-IN-2T+20X1GE | ok          | 00:02:36          |
| 1    | ASR1000-SIP10      | ok          | 00:04:19          |
| 1/0  | SPA-2X1GE-V2       | ok          | 00:03:07          |
| 1/1  | SPA-10X1GE-V2      | ok          | 00:03:00          |
| R0   | ASR1000-RP2        | ok          | 00:04:19          |
| R0/0 |                    | ok, active  | 00:04:19          |
| R0/1 |                    | ok, standby | 00:02:41          |
| F0   | ASR1000-ESP40      | ok, active  | 00:04:19          |

## Examples

```

P0 ASR1004-PWR-AC ok 00:03:28
P1 ASR1004-PWR-AC ps, fail 00:03:28
Slot CPLD Version Firmware Version

0 00200800 15.2(1r)S
1 07091401 15.3(3r)S
R0 08103002 15.3(3r)S
F0 1003190E 15.3(3r)S
Router# mkdir bootflash:harddisk:TargetS_Sub
Create directory filename [Target_Sub]?
Created dir harddisk:/Target_Sub
Router# conf t
Enter configuration commands, one per line. End with CNTL/Z.
Router(config)# ip tftp source-interface GigabitEthernet 0
Router(config)# end
Router#copy tftp: harddisk:Target_Sub
Address or name of remote host []? 202.153.144.25
Source filename []? /auto/tftp-srg-india/asr1000rp2-adventerprisek9.03.13.00.S.154-3.S-ext.bin
Destination filename [/Target_Sub/asr1000rp2-adventerprisek9.03.13.00.S.154-3.S-ext.bin]?
Accessing
tftp://202.153.144.25//auto/tftp-srg-india/asr1000rp2-adventerprisek9.03.13.00.S.154-3.S-ext.bin...
Loading /auto/tftp-srg-india/asr1000rp2-adventerprisek9.03.13.00.S.154-3.S-ext.bin from
202.153.144.25 (via GigabitEthernet0): !!!!
[OK - 569597380 bytes]
569597380 bytes copied in 101.618 secs (5605280 bytes/sec)
Router# request platform software package expand file
harddisk:/Target_Sub/asr1000rp2-adventerprisek9.03.13.00.S.154-3.S-ext.bin
Verifying parameters
Validating package type
Copying package files
SUCCESS: Finished expanding all-in-one software package.
Router# dir harddisk:Target_Sub
Directory of harddisk:/Target_Sub
9666562 -rw- 569597380 Aug 3 2013 13:25:06 +05:30
asr1000rp2-adventerprisek9.03.13.00.S.154-3.S-ext.bin
9666566 -rw- 37557200 Aug 3 2013 13:27:06 +05:30
asr1000rp2-elcbase.03.13.00.S.154-3.S-ext.pkg
9666567 -rw- 51194832 Aug 3 2013 13:27:07 +05:30
asr1000rp2-elcspa.03.13.00.S.154-3.S-ext.pkg
9666568 -rw- 80657364 Aug 3 2013 13:27:07 +05:30
asr1000rp2-espbase.03.13.00.S.154-3.S-ext.pkg
9666569 -rw- 95446456 Aug 3 2013 13:27:08 +05:30
asr1000rp2-esp86base.03.13.00.S.154-3.S-ext.pkg
9666564 -rw- 9381 Aug 3 2013 13:27:06 +05:30
asr1000rp2-packages-adventerprisek9.03.13.00.S.154-3.S-ext.conf
9666570 -rw- 23350232 Aug 3 2013 13:27:08 +05:30
asr1000rp2-rpaccess.03.13.00.S.154-3.S-ext.pkg
9666571 -rw- 37694900 Aug 3 2013 13:27:08 +05:30
asr1000rp2-rpbase.03.13.00.S.154-3.S-ext.pkg
9666572 -rw- 45536216 Aug 3 2013 13:27:08 +05:30
asr1000rp2-rpcontrol.03.13.00.S.154-3.S-ext.pkg
9666573 -rw- 118754284 Aug 3 2013 13:27:08 +05:30
asr1000rp2-rpios-adventerprisek9.03.13.00.S.154-3.S-ext.pkg
9666574 -rw- 38380500 Aug 3 2013 13:27:08 +05:30
asr1000rp2-sipbase.03.13.00.S.154-3.S-ext.pkg
9666575 -rw- 61760468 Aug 3 2013 13:27:08 +05:30
asr1000rp2-sipspa.03.13.00.S.154-3.S-ext.pkg
9666565 -rw- 10165 Aug 3 2013 13:27:08 +05:30 packages.conf
78704144384 bytes total (47541493760 bytes free)
Router# copy harddisk:Target_Sub/asr1000rp2-espbase.03.13.00.S.154-3.S-ext.pkg bootflash:
Active_Dir/Destination filename [Active_Dir/asr1000rp2-espbase.03.13.00.S.154-3.S-ext.pkg]?
Copy in
progress...CCCCC
80657364 bytes copied in 12.085 secs (6674172 bytes/sec)

```

```

Router# copy harddisk:Target_Sub/ asr1000rp2-esp86base.03.13.00.S.154-3.S-ext.pkg bootflash:
Active_Dir/Destination filename [Active_Dir/asr1000rp2-esp86base.03.13.00.S.154-3.S-ext.pkg]?
Copy in
progress...CCCC
95446456 bytes copied in 14.687 secs (6498703 bytes/sec)
Router# copy harddisk:Target_Sub/ asr1000rp2-rpaccess.03.13.00.S.154-3.S-ext.pkg bootflash:
Active_Dir/Destination filename [Active_Dir/asr1000rp2-rpaccess.03.13.00.S.154-3.S-ext.pkg]?
Copy in
progress...CCCCC
3350232 bytes copied in 4.047 secs (5769763 bytes/sec)
Router# copy harddisk:Target_Sub/ asr1000rp2-rpbase.03.13.00.S.154-3.S-ext.pkg bootflash:
Active_Dir/Destination filename [Active_Dir/asr1000rp2-rpbase.03.13.00.S.154-3.S-ext.pkg]?
Copy in
progress...CCCCC
7694900 bytes copied in 5.978 secs (6305604 bytes/sec)
Router# copy harddisk:Target_Sub/ asr1000rp2-rpcontrol.03.13.00.S.154-3.S-ext.pkg bootflash:
Active_Dir/Destination filename [Active_Dir/asr1000rp2-rpcontrol.03.13.00.S.154-3.S-ext.pkg]?
Copy in
progress...CCCC
5536216 bytes copied in 5.970 secs (7627507 bytes/sec)
Router# copy harddisk: Target_Sub/ asr1000rp2-rpios-adventerprisek9.03.13.00.S.154-3.S-ext.pkg
bootflash:
Active_Dir/Destination filename
[Active_Dir/asr1000rp2-rpios-adventerprisek9.03.13.00.S.154-3.S-ext.pkg]?
Copy in
progress...CCCC
118754284 bytes copied in 18.501 secs (6418804 bytes/sec)
Router# copy harddisk:Target_Sub/ asr1000rp2-sipbase.03.13.00.S.154-3.S-ext.pkg bootflash:
Active_Dir/Destination filename [Active_Dir/asr1000rp2-sipbase.03.13.00.S.154-3.S-ext.pkg]?
Copy in
progress...CCCC
8380500 bytes copied in 4.951 secs (7752070 bytes/sec)
Router# copy harddisk:Target_Sub/ asr1000rp2-sipspa.03.13.00.S.154-3.S-ext.pkg bootflash:
Active_Dir/
Destination filename [Active_Dir/asr1000rp2-sipspa.03.13.00.S.154-3.S-ext.pkg]?
Copy in
progress...CCCCC
1760468 bytes copied in 8.615 secs (7168946 bytes/sec)
Router# copy harddisk:Target_Sub/ asr1000rp2-elcbase.03.13.00.S.154-3.S-ext.pkg bootflash:
Active_Dir/Destination filename [Active_Dir/asr1000rp2-elcbase.03.13.00.S.154-3.S-ext.pkg]?
Copy in
progress...CCCCC
7557200 bytes copied in 5.255 secs (7146946 bytes/sec)
Router# copy harddisk:Target_Sub/ asr1000rp2-elcspa.03.13.00.S.154-3.S-ext.pkg bootflash:
Active_Dir/Destination filename [Active_Dir/asr1000rp2-elcspa.03.13.00.S.154-3.S-ext.pkg]?
Copy in
progress...CCCC
1194832 bytes copied in 7.677 secs (6668599 bytes/sec)
Router# request platform software package install rp 0 file
bootflash:Active_Dir/asr1000rp2-{rpaccess,rpios,rpcontrol}*03.13.00.S.154-3.S-ext*.pkg bay
1 force
--- Starting local lock acquisition on R0 ---
Finished local lock acquisition on R0
--- Starting file path checking ---
Finished file path checking
--- Starting image file verification ---
Checking image file names
Locating image files and validating name
 Found asr1000rp2-rpaccess.03.13.00.S.154-3.S-ext.pkg
 Found asr1000rp2-rpios-adventerprisek9.03.13.00.S.154-3.S-ext.pkg
 Found asr1000rp2-rpcontrol.03.13.00.S.154-3.S-ext.pkg
Verifying image file locations
Inspecting image file types
Processing image file constraints

```

```

Creating candidate provisioning file
Finished image file verification
--- Starting candidate package set construction ---
Verifying existing software set
Processing candidate provisioning file
Constructing working set for candidate package set
Constructing working set for running package set
Checking command output
Constructing merge of running and candidate packages
Checking if resulting candidate package set would be complete
Finished candidate package set construction
--- Starting compatibility testing ---
Determining whether candidate package set is compatible
WARNING:
WARNING: Candidate software combination not found in compatibility database
WARNING:
Determining whether installation is valid
Creating matrix_file by locate_latest_matrix_file /tmp/issu/provision/s
WARNING:
WARNING: Candidate software combination not found in compatibility database
WARNING:
WARNING:
WARNING: Candidate software combination not found in compatibility database
WARNING:
Software sets are identified as compatible
Verifying image type compatibility
Checking IPC compatibility with running software
Checking candidate package set infrastructure compatibility
Checking infrastructure compatibility with running software
Checking package specific compatibility
Finished compatibility testing
--- Starting impact testing---
Checking operational impact of change

WARNING: Connection may be lost during installation of IOS package
Finished impact testing
--- Starting list of software package changes ---
No old package files removed
New files list:
 Added asr1000rp2-rpaccess.03.13.00.S.154-3.S-ext.pkg
 Added asr1000rp2-rpcontrol.03.13.00.S.154-3.S-ext.pkg
 Added asr1000rp2-rpios-adventerprisek9.03.13.00.S.154-3.S-ext.pkg
Finished list of software package changes
--- Starting commit of software changes ---
Updating provisioning rollback files
Creating pending provisioning file
Committing provisioning file
Finished commit of software changes
--- Starting analysis of software changes ---
Finished analysis of software changes
--- Starting update running software --
Blocking peer synchronization of operating information
Creating the command set placeholder directory
 Finding latest command set
 Finding latest command shortlist lookup file
 Finding latest command shortlist file
 Assembling CLI output libraries
 Assembling CLI input libraries
 Assembling Dynamic configuration files
 Applying interim IPC and database definitions
 Replacing running software
 Replacing CLI software
 Restarting software
 Restarting IOS PID: 21552, in slot/bay 0/1

```



```

Applying final IPC and database definitions
Generating software version information
Notifying running software of updates
Unblocking peer synchronization of operating information
Unmounting old packages
Cleaning temporary installation files
Finished update running software
SUCCESS: Finished installing software.
Router# redundancy force-switchover
Proceed with switchover to standby RP? [confirm]
Manual Swact = enabled
%IOSXE_INFRA-6-CONSOLE_ACTIVE: R0/1 console active.
Press RETURN to get started!
[OK]
*Aug 3 13:43:52.101 IST: %CMANRP-6-CMHASTATUS: RP switchover, received chassis event to
become active
*Aug 3 13:43:52.193 IST: %REDUNDANCY-3-SWITCHOVER: RP switchover (PEER_NOT_PRESENT)
*Aug 3 13:43:52.194 IST: %REDUNDANCY-3-SWITCHOVER: RP switchover (PEER_DOWN)
*Aug 3 13:43:52.194 IST: %REDUNDANCY-3-SWITCHOVER: RP switchover
(PEER_REDUNDANCY_STATE_CHANGE)
*Aug 3 13:43:51.231 IST: %RF-5-RF_RELOAD: Self reload. Reason: redundancy force-switchover
*Aug 3 13:43:51.461 IST: %SYS-5-SWITCHOVER: Switchover requested by red_switchover_process.
Reason: redundancy force-switchover.
*Aug 3 13:43:52.198 IST: %PLATFORM-6-HASTATUS: RP switchover, sent message became active.
IOS is ready to switch to primary after chassis confirmation
*Aug 3 13:43:52.200 IST: %CMANRP-6-CMHASTATUS: RP switchover, received chassis event became
active
*Aug 3 13:43:52.449 IST: %PLATFORM-6-HASTATUS_DETAIL: RP switchover, received chassis event
became active. Switch to primary (count 1)
*Aug 3 13:43:52.733 IST: %LINEPROTO-5-UPDOWN: Line protocol on Interface GigabitEthernet0,
changed state to down
*Aug 3 13:43:53.098 IST: % Redundancy mode change to SSO
*Aug 3 13:43:53.126 IST: %LINK-3-UPDOWN: Interface Lsmpi0, changed state to up
*Aug 3 13:43:53.127 IST: %LINK-3-UPDOWN: Interface EOBC0, changed state to up
*Aug 3 13:43:53.127 IST: %LINK-3-UPDOWN: Interface LIIN0, changed state to up
*Aug 3 13:43:54.127 IST: %LINEPROTO-5-UPDOWN: Line protocol on Interface Lsmpi0, changed
state to up
*Aug 3 13:43:54.127 IST: %LINEPROTO-5-UPDOWN: Line protocol on Interface EOBC0, changed
state to up
*Aug 3 13:43:54.127 IST: %LINEPROTO-5-UPDOWN: Line protocol on Interface LIIN0, changed
state to up
*Aug 3 13:43:55.117 IST: %LINK-3-UPDOWN: Interface Null0, changed state to up
*Aug 3 13:43:55.117 IST: %LINK-3-UPDOWN: Interface GigabitEthernet0/0/8, changed state to
up
*Aug 3 13:43:55.117 IST: %LINK-3-UPDOWN: Interface GigabitEthernet0/0/10, changed state
to up
*Aug 3 13:43:55.117 IST: %LINK-3-UPDOWN: Interface GigabitEthernet1/0/0, changed state to
up
*Aug 3 13:43:55.119 IST: %LINK-3-UPDOWN: Interface GigabitEthernet1/0/1, changed state to
up
*Aug 3 13:43:55.119 IST: %LINK-3-UPDOWN: Interface GigabitEthernet1/1/0, changed state to
up
*Aug 3 13:43:55.119 IST: %LINK-3-UPDOWN: Interface GigabitEthernet1/1/1, changed state to
up
*Aug 3 13:43:55.119 IST: %LINK-3-UPDOWN: Interface GigabitEthernet1/1/3, changed state to
up
*Aug 3 13:43:55.119 IST: %LINK-3-UPDOWN: Interface GigabitEthernet1/1/5, changed state to
up
*Aug 3 13:43:55.124 IST: %LINK-5-CHANGED: Interface GigabitEthernet0/0/0, changed state
to administratively down
*Aug 3 13:43:55.124 IST: %LINK-5-CHANGED: Interface GigabitEthernet0/0/1, changed state
to administratively down
*Aug 3 13:43:55.124 IST: %LINK-5-CHANGED: Interface GigabitEthernet0/0/2, changed state
to administratively down

```

## Examples

```

*Aug 3 13:43:55.124 IST: %LINK-5-CHANGED: Interface GigabitEthernet0/0/3, changed state
to administratively down
*Aug 3 13:43:55.124 IST: %LINK-5-CHANGED: Interface GigabitEthernet0/0/4, changed state
to administratively down
*Aug 3 13:43:55.124 IST: %LINK-5-CHANGED: Interface GigabitEthernet0/0/5, changed state
to administratively down
*Aug 3 13:43:55.124 IST: %LINK-5-CHANGED: Interface GigabitEthernet0/0/6, changed state
to administratively down
*Aug 3 13:43:55.124 IST: %LINK-5-CHANGED: Interface GigabitEthernet0/0/7, changed state
to administratively down
*Aug 3 13:43:55.124 IST: %LINK-5-CHANGED: Interface GigabitEthernet0/0/9, changed state
to administratively down
*Aug 3 13:43:55.124 IST: %LINK-5-CHANGED: Interface GigabitEthernet0/0/11, changed state
to administratively down
*Aug 3 13:43:56.118 IST: %LINEPROTO-5-UPDOWN: Line protocol on Interface Null0, changed
state to up
*Aug 3 13:43:56.118 IST: %LINEPROTO-5-UPDOWN: Line protocol on Interface
GigabitEthernet0/0/8, changed state to up
*Aug 3 13:43:56.118 IST: %LINEPROTO-5-UPDOWN: Line protocol on Interface
GigabitEthernet0/0/10, changed state to up
*Aug 3 13:43:56.118 IST: %LINEPROTO-5-UPDOWN: Line protocol on Interface
TenGigabitEthernet0/0/20, changed state to down
*Aug 3 13:43:56.118 IST: %LINEPROTO-5-UPDOWN: Line protocol on Interface
TenGigabitEthernet0/0/21, changed state to down
*Aug 3 13:43:56.118 IST: %LINEPROTO-5-UPDOWN: Line protocol on Interface
GigabitEthernet1/0/0, changed state to up
*Aug 3 13:43:56.120 IST: %LINEPROTO-5-UPDOWN: Line protocol on Interface
GigabitEthernet1/0/1, changed state to up
*Aug 3 13:43:56.120 IST: %LINEPROTO-5-UPDOWN: Line protocol on Interface
GigabitEthernet1/1/0, changed state to up
*Aug 3 13:43:56.120 IST: %LINEPROTO-5-UPDOWN: Line protocol on Interface
GigabitEthernet1/1/1, changed state to up
*Aug 3 13:43:56.120 IST: %LINEPROTO-5-UPDOWN: Line protocol on Interface
GigabitEthernet1/1/3, changed state to up
*Aug 3 13:44:05.127 IST: %LINK-3-UPDOWN: Interface GigabitEthernet0, changed state to up
*Aug 3 13:44:06.127 IST: %LINEPROTO-5-UPDOWN: Line protocol on Interface GigabitEthernet0,
changed state to up
*Aug 3 13:44:32.069 IST: %REDUNDANCY-5-PEER_MONITOR_EVENT: Active detected a standby
insertion (raw-event=PEER_FOUND(4))
*Aug 3 13:44:32.070 IST: %REDUNDANCY-5-PEER_MONITOR_EVENT: Active detected a standby
insertion (raw-event=PEER_REDUNDANCY_STATE_CHANGE(5))
*Aug 3 13:44:34.969 IST: %REDUNDANCY-3-IPC: IOS versions do not match.
*Aug 3 13:45:40.946 IST: %RF-5-RF_TERMINAL_STATE: Terminal state reached for (SSO)

```

Router# **show platform**

Chassis type: ASR1004

| Slot | Type               | State            | Insert time (ago) |
|------|--------------------|------------------|-------------------|
| 0    | ASR1000-2T+20X1GE  | ok               | 00:29:33          |
| 0/0  | BUILT-IN-2T+20X1GE | ok               | 00:05:28          |
| 1    | ASR1000-SIP10      | ok               | 00:29:33          |
| 1/0  | SPA-2X1GE-V2       | ok               | 00:05:28          |
| 1/1  | SPA-10X1GE-V2      | ok               | 00:05:28          |
| R0   | ASR1000-RP2        | ok               | 00:29:33          |
| R0/0 |                    | ok, standby      | 00:01:46          |
| R0/1 |                    | ok, active       | 00:06:12          |
| F0   | ASR1000-ESP40      | ok, active       | 00:29:33          |
| P0   | ASR1004-PWR-AC     | ok               | 00:28:42          |
| P1   | ASR1004-PWR-AC     | ps, fail         | 00:28:42          |
| Slot | CPLD Version       | Firmware Version |                   |
| 0    | 00200800           | 15.2(1r)S        |                   |
| 1    | 07091401           | 15.3(3r)S        |                   |
| R0   | 08103002           | 15.3(3r)S        |                   |
| F0   | 1003190E           | 15.3(3r)S        |                   |

```

Router# request platform software package install rp 0 file
bootflash:Active_Dir/asr1000rp2-{rpaccess,rprios,rpcontrol}*03.13.00.S.154-3.S-ext*.pkg bay
0 force
--- Starting local lock acquisition on R0 ---
Finished local lock acquisition on R0
--- Starting file path checking---
Finished file path checking
--- Starting image file verification ---
Checking image file names
Locating image files and validating name syntax
 Found asr1000rp2-rpaccess.03.13.00.S.154-3.S-ext.pkg
 Found asr1000rp2-rpios-adventerprisek9.03.13.00.S.154-3.S-ext.pkg
 Found asr1000rp2-rpcontrol.03.13.00.S.154-3.S-ext.pkg
Verifying image file locations
Inspecting image file types
Processing image file constraints
Creating candidate provisioning file
Finished image file verification
--- Starting candidate package set construction ---
Verifying existing software set
Processing candidate provisioning file
Constructing working set for candidate package set
Constructing working set for running package set
Checking command output
Constructing merge of running and candidate packages
Checking if resulting candidate package set would be complete
Finished candidate package set construction
--- Starting compatibility testing ---
Determining whether candidate package set is compatible
WARNING:
WARNING: Candidate software combination not found in compatibility database
WARNING:Determining whether installation is valid
Creating matrix_file by locate_latest_matrix_file /tmp/issu/provision/sw
Software sets are identified as compatible
Verifying image type compatibility
Checking IPC compatibility with running software
Checking candidate package set infrastructure compatibility
Checking infrastructure compatibility with running software
Checking package specific compatibility
Finished compatibility testing
--- Starting impact testing ---
Checking operational impact of change
WARNING: Connection may be lost during installation of IOS package
Finished impact testing
--- Starting list of software package changes ---
Old files list:
Removed asr1000rp2-rpaccess.03.12.01.S.154-2.S.pkg
Removed asr1000rp2-rpcontrol.03.12.01.S.154-2.S.pkg
Removed asr1000rp2-rpios-adventerprisek9.03.12.01.S.154-2.S.pkg
No new package files added
Finished list of software package changes
--- Starting commit of software changes ---
Updating provisioning rollback files
Creating pending provisioning file
Committing provisioning file
Finished commit of software changes
--- Starting analysis of software changes ---
Finished analysis of software changes
--- Starting update running software ---
Blocking peer synchronization of operating information
Creating the command set placeholder directory
 Finding latest command set
 Finding latest command shortlist lookup file
 Finding latest command shortlist file

```

```

Assembling CLI output libraries
Assembling CLI input libraries
Assembling Dynamic configuration files
Applying interim IPC and database definitions
Replacing running software
Replacing CLI software
Restarting software
Restarting IOS PID: 25452, in slot/bay 0/0
*Aug 3 13:48:07.051 IST: %REDUNDANCY-3-STANDBY_LOST: Standby processor fault
(PEER_NOT_PRESENT)
*Aug 3 13:48:07.052 IST: %REDUNDANCY-3-STANDBY_LOST: Standby processor fault (PEER_DOWN)
*Aug 3 13:48:07.052 IST: %REDUNDANCY-3-STANDBY_LOST: Standby processor fault
(PEER_REDUNDANCY_STATE_CHANGE)
*Aug 3 13:48:09.683 IST: %RF-5-RF_RELOAD: Peer reload. Reason: EHSA standby down
*Aug 3 13:48:09.692 IST: % Redundancy mode change to SSO
**Aug 3 13:48:49.450 IST: %REDUNDANCY-5-PEER_MONITOR_EVENT: Active detected a standby
insertion (raw-event=PEER_FOUND(4))
*Aug 3 13:48:49.451 IST: %REDUNDANCY-5-PEER_MONITOR_EVENT: Active detected a standby
insertion (raw-event=PEER_REDUNDANCY_STATE_CHANGE(5))
*Aug 3 13:48:50.035 IST: %ISSU-3-PEER_IMAGE_NOT_IN_INCOMP_LIST: Peer image
(X86_64_LINUX_IOSD-ADVENTERPRISEK9-M), version (15.3(3)S) on peer uid (48) is not
in the incompatible images list
*Aug 3 13:48:50.036 IST: %ISSU-3-PEER_IMAGE_NOT_IN_INCOMP_LIST: Peer image
(X86_64_LINUX_IOSD-ADVENTERPRISEK9-M), version (15.3(3)S) on peer uid (48) is not
in the incompatible images list Applying final IPC and database definitions
*Aug 3 13:48:53.521 IST: %DYNCMD-7-CMDSET_UNLOADED: The Dynamic Command set from the Shell
Manager has been unloaded
Generating software version information
Notifying running software of updates
Unblocking peer synchronization of operating information
Unmounting old packages
cleaning temporary installation files
Finished update running software
SUCCESS: Finished installing software.
*Aug 3 13:49:57.477 IST: %NBAR HA-5-NBAR_INFO: NBAR sync DONE!
*Aug 3 13:49:57.893 IST: %ISSU-3-PEER_IMAGE_REM_FROM_INCOMP_LIST: Peer image
(X86_64_LINUX_IOSD-ADVENTERPRISEK9-M), version (15.3(2)S) on peer uid (48)
being removed from the incompatibility list
*Aug 3 13:49:57.893 IST: %HA_CONFIG_SYNC-6-BULK_CFGSYNC_SUCCEEDED: Bulk Sync succeeded
*Aug 3 13:49:57.895 IST: %RF-5-RF_TERMINAL_STATE: Terminal state reached for (SSO)
Router # issu commitversion
--- Starting local lock acquisition on R0 ---
Finished local lock acquisition on R0
--- Starting installation changes ---
Cancelling rollback timer
Finished installation changes
SUCCESS: Installation changes committed
Router# request platform software package install rp 0 file
bootflash:Active_Dir/asr1000rp2-{sipbase,sipspa}*03.13.00.S.154-3.S-ext*.pkg slot 1 force
--- Starting local lock acquisition on R0 ---
Finished local lock acquisition on R0
--- Starting file path checking ---
Finished file path checking
--- Starting image file verification---
Checking image file names
Locating image files and validating name syntax
Found asr1000rp2-sipbase.03.13.00.S.154-3.S-ext.pkg
Found asr1000rp2-sipspa.03.13.00.S.154-3.S-ext.pkg
Verifying image file locations
Inspecting image file types
Processing image file constraints
Creating candidate provisioning file
Finished image file verification
-- Starting candidate package set construction ---

```

```

Verifying existing software set
Processing candidate provisioning file
Constructing working set for candidate package set
Constructing working set for running package set
Checking command output
Constructing merge of running and candidate packages
Checking if resulting candidate package set would be complete
Finished candidate package set construction
--- Starting compatibility testing ---
Determining whether candidate package set is compatible
WARNING: Candidate software combination not found in compatibility database
WARNING: Determining whether installation is valid
Creating matrix_file by locate_latest_matrix_file /tmp/issu/provision/s
WARNING: Candidate software combination not found in compatibility database
WARNING: Candidate software combination not found in compatibility database
WARNING: Software sets are identified as compatible
Verifying image type compatibility
Checking IPC compatibility with running software
Checking candidate package set infrastructure compatibility
Checking infrastructure compatibility with running software
Checking package specific compatibility
Finished compatibility testing
--- Starting impact testing ---
Checking operational impact of change
Finished impact testing
--- Starting list of software package changes---
No old package files removed
New files list:
 Added asr1000rp2-sipbase.03.13.00.S.154-3.S-ext.pkg
 Added asr1000rp2-sipspa.03.13.00.S.154-3.S-ext.pkg
Finished list of software package changes
--- Starting commit of software changes ---
Updating provisioning rollback files
Creating pending provisioning file
Committing provisioning file
Finished commit of software changes
--- Starting analysis of software changes ---
Finished analysis of software changes
--- Starting update running software ---
Blocking peer synchronization of operating information
Creating the command set placeholder directory
 Finding latest command set
 Finding latest command shortlist lookup file
 Finding latest command shortlist file
 Assembling CLI output libraries
 Assembling CLI input libraries
 Assembling Dynamic configuration files
Applying interim IPC and database definitions
Replacing running software
Replacing CLI software
Restarting software
Restarting SIP1
Applying final IPC and database definitions
*Aug 3 13:52:05.767 IST: %IOSXE_OIR-6-OFFLINECARD: Card (cc) offline in slot 1
*Aug 3 13:52:05.770 IST: %IOSXE_OIR-6-REMSPA: SPA removed from subslot 1/0, interfaces
disabled
*Aug 3 13:52:05.770 IST: %IOSXE_OIR-6-REMSPA: SPA removed from subslot 1/1, interfaces
disabled
*Aug 3 13:52:05.778 IST: %SPA_OIR-6-OFFLINECARD: SPA (SPA-2X1GE-V2) offline in subslot 1/0
*Aug 3 13:52:05.786 IST: %SPA_OIR-6-OFFLINECARD: SPA (SPA-10X1GE-V2) offline in subslot
1/1
Generating software version information
Notifying running software of updates
Unblocking peer synchronization of operating information

```

```

Unmounting old packages
Cleaning temporary installation files
Finished update running software
SUCCESS: Finished installing software.
*Aug 3 13:53:00.262 IST: %IOSXE_OIR-6-ONLINECARD: Card (cc) online in slot 1
*Aug 3 13:53:00.901 IST: %IOSXE_OIR-6-INSSPA: SPA inserted in subslot 1/0
*Aug 3 13:53:01.194 IST: %IOSXE_OIR-6-INSSPA: SPA inserted in subslot 1/1
*Aug 3 13:53:18.148 IST: %LINK-3-UPDOWN: SIPl/0: Interface EOBC1/1, changed state to up
*Aug 3 13:53:23.978 IST: %SPA_OIR-6-ONLINECARD: SPA (SPA-2X1GE-V2) online in subslot 1/0
*Aug 3 13:53:23.609 IST: %LINK-3-UPDOWN: SIPl/1: Interface EOBC1/1, changed state to up
*Aug 3 13:53:26.288 IST: %LINK-3-UPDOWN: Interface GigabitEthernet1/0/0,changed state to
up
*Aug 3 13:53:26.471 IST: %LINK-3-UPDOWN: Interface GigabitEthernet1/0/1, changed state to
up
*Aug 3 13:53:26.605 IST: %LINK-3-UPDOWN: SIPl/0: Interface GigabitEthernet1/0/0, changed
state to up
*Aug 3 13:53:29.056 IST: %SPA_OIR-6-ONLINECARD: SPA (SPA-10X1GE-V2) online in subslot 1/1
*Aug 3 13:53:31.020 IST: %LINK-3-UPDOWN: Interface GigabitEthernet1/1/1, changed state to
up
*Aug 3 13:53:31.030 IST: %LINK-3-UPDOWN: Interface GigabitEthernet1/1/3, changed state to
up
*Aug 3 13:53:31.042 IST: %LINK-3-UPDOWN: Interface GigabitEthernet1/1/4, changed state to
down
*Aug 3 13:53:31.045 IST: %LINK-3-UPDOWN: Interface GigabitEthernet1/1/5, changed state to
up
*Aug 3 13:53:31.046 IST: %LINK-3-UPDOWN: Interface GigabitEthernet1/1/6, changed state to
down
*Aug 3 13:53:31.048 IST: %LINK-3-UPDOWN: Interface GigabitEthernet1/1/7, changed state to
down
*Aug 3 13:53:31.051 IST: %LINK-3-UPDOWN: Interface GigabitEthernet1/1/8, changed state to
down
*Aug 3 13:53:31.053 IST: %LINK-3-UPDOWN: Interface GigabitEthernet1/1/9, changed state to
down
*Aug 3 13:53:31.312 IST: %LINK-3-UPDOWN: Interface GigabitEthernet1/1/0, changed state to
up
*Aug 3 13:53:32.833 IST: %LINK-3-UPDOWN: SIPl/1: Interface GigabitEthernet1/1/0, changed
state to up
*Aug 3 13:53:33.007 IST: %LINK-3-UPDOWN: SIPl/1: Interface GigabitEthernet1/1/7, changed
state to down
Router# issu commitversion
-- Starting local lock acquisition on R0 ---
Finished local lock acquisition on R0
--- Starting installation changes ---
Cancelling rollback timer
Finished installation changes
SUCCESS: Installation changes committed
Router#
Router# request platform software package install rp 0 file
bootflash:Active_Dir/asr1000rp2-{elcbase,elcspa}*03.13.00.S.154-3.S-ext*.pkg slot 0 force
---- Starting local lock acquisition on R0 ---
Finished local lock acquisition on R0
-- Starting file path checking ---
Finished file path checking
--- Starting image file verification ---
Checking image file names
Locating image files and validating name syntax
 Found asr1000rp2-elcbase.03.13.00.S.154-3.S-ext.pkg
 Found asr1000rp2-elcspa.03.13.00.S.154-3.S-ext.pkg
Verifying image file locations
Inspecting image file types
Processing image file constraints
Creating candidate provisioning file
Finished image file verification
---Starting candidate package set construction ---

```

```
Verifying existing software set
Processing candidate provisioning file
Constructing working set for candidate package set
Constructing working set for running package set
Checking command output
Constructing merge of running and candidate packages
Checking if resulting candidate package set would be complete
Finished candidate package set construction
--- Starting compatibility testing ---
Determining whether candidate package set is compatible
WARNING: Candidate software combination not found in compatibility database
WARNING: Determining whether installation is valid
Creating matrix_file by locate_latest_matrix_file /tmp/issu/provision/s
WARNING: Candidate software combination not found in compatibility database
WARNING: Candidate software combination not found in compatibility database
WARNING: Software sets are identified as compatible
Verifying image type compatibility
Checking IPC compatibility with running software
Checking candidate package set infrastructure compatibility
Checking infrastructure compatibility with running software
Checking package specific compatibility
Finished compatibility testing
--- Starting impact testing ---
Checking operational impact of change
Finished impact testing
--- Starting list of software package changes --
No old package files removed
New files list:
 Added asr1000rp2-elcbase.03.13.00.S.154-3.S-ext.pkg
 Added asr1000rp2-elcspa.03.13.00.S.154-3.S-ext.pkg
 Finished list of software package changes
--- Starting commit of software changes ---
Updating provisioning rollback files
Creating pending provisioning file
Committing provisioning file
Finished commit of software changes
--Starting analysis of software changes ---
Finished analysis of software changes
--- Starting update running software ---
Blocking peer synchronization of operating information
Creating the command set placeholder directory
 Finding latest command set
 Finding latest command shortlist lookup file
 Finding latest command shortlist file
 Assembling CLI output libraries
 Assembling CLI input libraries
 Assembling Dynamic configuration files
 Applying interim IPC and database definitions
 Replacing running software
 Replacing CLI software
 Restarting software
 Applying final IPC and database definitions
 Generating software version information
 Notifying running software of updates
 Unblocking peer synchronization of operating information
 Unmounting old packages
 Cleaning temporary installation files
 Finished update running software
SUCCESS: Finished installing software.
Router# issu commitversion
--- Starting locallock acquisition on R0 ---
Finished local lock acquisition on R0
--- Starting installation changes ---
Cancelling rollback timer
```

```

Finished installation changes
SUCCESS: Installation changes committed
Router# request platform software package install rp 0 file
bootflash:Active_Dir/asr1000rp2-esp*03.13.00.S.154-3.S-ext*.pkg force
--- Starting local lock acquisition on R0
---Finished local lock acquisition on R0
--- Starting file path checking ---
Finished file path checking
---Starting image file verification---
Checking image file names
Locating image files and validating name syntax
 Found asr1000rp2-espbase.03.13.00.S.154-3.S-ext.pkg
 Found asr1000rp2-esp86base.03.13.00.S.154-3.S-ext.pkg
 Verifying image file locations
 Inspecting image file types
 Processing image file constraint
 Creating candidate provisioning file
 Finished image file verification
--- Starting candidate package set construction ---
Verifying existing software set
Processing candidate provisioning file
Constructing working set for candidate package set
Constructing working set for running package set
Checking command output
Constructing merge of running and candidate packages
Checking if resulting candidate package set would be complete
Finished candidate package set construction
--- Starting compatibility testing ---
Determining whether candidate package set is compatible
WARNING: Candidate software combination not found in compatibility database
WARNING: Determining whether installation is valid
Creating matrix_file by locate_latest_matrix_file /tmp/issu/provision/s
WARNING: Candidate software combination not found in compatibility database
WARNING: Candidate software combination not found in compatibility database
WARNING: Software sets are identified as compatible
Verifying image type compatibility
Checking IPC compatibility with running software
Checking candidate package set infrastructure compatibility
Checking infrastructure compatibility with running software
Checking package specific compatibility
Finished compatibility testing
--- Starting impact testing ---
Checking operational impact of change
Finished impact testing
--- Starting list of software package changes ---
Old files list:
 Removed asr1000rp2-espbase.03.12.01.S.154-2.S.pkg
 Removed asr1000rp2-esp86base.03.12.01.S.154-2.S.pkg
New files list:
 Added asr1000rp2-espbase.03.13.00.S.154-3.S-ext.pkg
 Added asr1000rp2-esp86base.03.13.00.S.154-3.S-ext.pkg
 Finished list of software package changes
--- Starting commit of software changes ---
Updating provisioning rollback files
Creating pending provisioning file
Committing provisioning file
Finished commit of software changes
--- Starting analysis of software changes ---
Finished analysis of software changes
--- Starting update running software ---
Blocking peer synchronization of operating information
Creating the command set placeholder directory
 Finding latest command set
 Finding latest command shortlist lookup file

```



```

Finding latest command shortlist file
Assembling CLI output libraries
Assembling CLI input libraries
Assembling Dynamic configuration files
Applying interim IPC and database definitions
Replacing running software
Replacing CLI software
Restarting software
Restarting ESPO
Applying final IPC and database definitions
*Aug 3 14:02:51.450 IST: %IOSXE_OIR-6-OFFLINECARD: Card (fp) offline in slot F0
Generating software version information
Notifying running software of updates
Unblocking peer synchronization of operating information
Unmounting old packages
Cleaning temporary installation files
Finished update running software
SUCCESS: Finished installing software.
*Aug 3 14:04:49.802 IST: %CPPHA-7-START: F0: cpp_ha: CPP 0 preparing
image/tmp/sw/fp/0/0/fpx86/mount/usr/cpp/bin/qfp-ucode-esp40
*Aug 3 14:04:50.172 IST: %CPPHA-7-START: F0: cpp_ha: CPP 0 startup init image
/tmp/sw/fp/0/0/fpx86/mount/usr/cpp/bin/qfp-ucode-esp40
*Aug 3 14:04:50.746 IST: %IOSXE_OIR-6-ONLINECARD: Card (fp) online in slot F0
*Aug 3 14:04:55.480 IST: %CPPHA-7-START: F0: cpp_ha: CPP 0 running init image
/tmp/sw/fp/0/0/fpx86/mount/usr/cpp/bin/qfp-ucode-esp40
*Aug 3 14:04:55.698 IST: %CPPHA-7-READY: F0: cpp_ha: CPP 0 loading and initialization
complete
*Aug 3 14:04:55.837 IST: %IOSXE-6-PLATFORM: F0: cpp_cp: Process
CPP_PFILTER_EA_EVENT_API_CALL_REGISTER
Router# issu commitversion
--- Starting local lock acquisition on R0 ---
Finished local lock acquisition on R0
--- Starting installation changes ---
Cancelling rollback timer
Finished installation changes
SUCCESS: Installation changes committed
Router# request platform software package install rp 0 file
bootflash:Active_Dir/asr1000rp*03.13.00.S.154-3.S-ext*.pkg
--- Starting local lock acquisition on R0 ---
Finished local lock acquisition on R0
--- Starting file path checking ---
Finished file path checking
--- Starting image file verification ---
Checking image file names
Locating image files and validating name syntax
Found asr1000rp2-elcbase.03.13.00.S.154-3.S-ext.pkg
Found asr1000rp2-elcspace.03.13.00.S.154-3.S-ext.pkg
Found asr1000rp2-espbase.03.13.00.S.154-3.S-ext.pkg
Found asr1000rp2-esp86base.03.13.00.S.154-3.S-ext.pkg
Found asr1000rp2-rpaccess.03.13.00.S.154-3.S-ext.pkg
Found asr1000rp2-rpbase.03.13.00.S.154-3.S-ext.pkg
Found asr1000rp2-rpcontrol.03.13.00.S.154-3.S-ext.pkg
Found asr1000rp2-rpios-adventerprisek9.03.13.00.S.154-3.S-ext.pkg
Found asr1000rp2-sipbase.03.13.00.S.154-3.S-ext.pkg
Found asr1000rp2-sipspace.03.13.00.S.154-3.S-ext.pkg
Verifying image file locations
Inspecting image file types
WARNING: In-service installation of RP Base package
WARNING: requires software reboot of target RP
WARNING: Automatically setting the on-reboot flag
Processing image file constraints
Creating candidate provisioning file
Finished image file verification
--- Starting candidate package set construction ---

```

```

Verifying existing software set
Processing candidate provisioning file
Constructing working set for candidate package set
Constructing working set for running package set
Checking command output
Constructing merge of running and candidate packages
Checking if resulting candidate package set would be complete
Finished candidate package set construction
--- Starting compatibility testing ---
Determining whether candidate package set is compatible
Determining whether installation is valid
Determining whether installation is valid ... skipped
Verifying image type compatibility
Checking IPC compatibility for candidate software
Checking candidate package set infrastructure compatibility
Checking infrastructure compatibility with running software
Checking infrastructure compatibility with running software ... skipped
Checking package specific compatibility
Finished compatibility testing
--- Starting list of software package changes ---
Old files list:
 Removed asr1000rp2-elcbase.03.12.01.S.154-2.S.pkg
 Removed asr1000rp2-elcspa.03.12.01.S.154-2.S.pkg
 Removed asr1000rp2-rpbase.03.12.01.S.154-2.S.pkg
 Removed asr1000rp2-sipbase.03.12.01.S.154-2.S.pkg
 Removed asr1000rp2-sipspa.03.12.01.S.154-2.S.pkg
New files list:
 Added asr1000rp2-rpbase.03.13.00.S.154-3.S-ext.pkg
Finished list of software package changes
--- Starting commit of software changes ---
Updating provisioning rollback files
Creating pending provisioning file
Committing provisioning file
Finished commit of software changes
SUCCESS: Software provisioned.
New software will load on reboot.
Router# show version provisioned
Package: Provisioning File, version: n/a, status: active
 File: bootflash:Active_Dir/packages.conf, on: RP0
 Built: n/a, by: n/a
 File SHA1 checksum: c79075780592aec1312725f4a2357a034fda2d3b
Package: rpbase, version: 03.13.00.S.154-3.S-ext, status: n/a
 File: bootflash:Active_Dir/asr1000rp2-rpbase.03.13.00.S.154-3.S-ext.pkg, on: RP0
 Built: 2013-07-25_22.55, by: mcpre
 File SHA1 checksum: 4f655c54bb95b4dfa24a0d25ebf97cf8527c69e9
Package: rpcontrol, version: 03.13.00.S.154-3.S-ext, status: n/a
 File: bootflash:Active_Dir/asr1000rp2-rpcontrol.03.13.00.S.154-3.S-ext.pkg, on: RP0/0
 Built: 2013-07-25_22.55, by: mcpre
 File SHA1 checksum: 8a0a45ea5c7a656c0eef6726174461584f182c78
Package: rpios-adventerprisek9, version: 03.13.00.S.154-3.S-ext, status: n/a
 File: bootflash:Active_Dir/asr1000rp2-rpios-adventerprisek9.03.13.00.S.154-3.S-ext.pkg,
on: RP0/0
 Built: 2013-07-25_23.00, by: mcpre
 File SHA1 checksum: 85e9eab826bfff2194ef568a56c76453625383ad2
Package: rpaccess, version: 03.13.00.S.154-3.S-ext, status: n/a
 File: bootflash:Active_Dir/asr1000rp2-rpaccess.03.13.00.S.154-3.S-ext.pkg, on: RP0/0
 Built: 2013-07-25_22.55, by: mcpre
 File SHA1 checksum: a360dff0fd76a9b1ae67cda9116c97b62f25ab09
Package: rpcontrol, version: 03.13.00.S.154-3.S-ext, status: n/a
 File: bootflash:Active_Dir/asr1000rp2-rpcontrol.03.13.00.S.154-3.S-ext.pkg, on: RP0/1
 Built: 2013-07-25_22.55, by: mcpre
 File SHA1 checksum: 8a0a45ea5c7a656c0eef6726174461584f182c78
Package: rpios-adventerprisek9, version: 03.13.00.S.154-3.S-ext, status: n/a
 File: bootflash:Active_Dir/asr1000rp2-rpios-adventerprisek9.03.13.00.S.154-3.S-ext.pkg,

```

```

on: RP0/1
 Built: 2013-07-25_23.00, by: mcpre
 File SHA1 checksum: 85e9eab826bfff2194ef568a56c76453625383ad2
Package: rpaccess, version: 03.13.00.S.154-3.S-ext, status: n/a
 File: bootflash:Active_Dir/asr1000rp2-rpaccess.03.13.00.S.154-3.S-ext.pkg, on: RP0/1
 Built: 2013-07-25_22.55, by: mcpre
 File SHA1 checksum: a360dff0fd76a9b1ae67cda9116c97b62f25ab09
Package: rpbase, version: 03.13.00.S.154-3.S-ext, status: n/a
 File: bootflash:Active_Dir/asr1000rp2-rpbase.03.13.00.S.154-3.S-ext.pkg, on: RP1
 Built: 2013-07-25_22.55, by: mcpre
 File SHA1 checksum: 4f655c54bb95b4dfa24a0d25ebf97cf8527c69e9
Package: rpcontrol, version: 03.13.00.S.154-3.S-ext, status: n/a
 File: bootflash:Active_Dir/asr1000rp2-rpcontrol.03.13.00.S.154-3.S-ext.pkg, on: RP1/0
 Built: 2013-07-25_22.55, by: mcpre
 File SHA1 checksum: 8a0a45ea5c7a656c0eef6726174461584f182c78
Package: rpios-adventerprisek9, version: 03.13.00.S.154-3.S-ext, status: n/a
 File: bootflash:Active_Dir/asr1000rp2-rpios-adventerprisek9.03.13.00.S.154-3.S-ext.pkg,
on: RP1/0
 Built: 2013-07-25_23.00, by: mcpre
 File SHA1 checksum: 85e9eab826bfff2194ef568a56c76453625383ad2
Package: rpaccess, version: 03.13.00.S.154-3.S-ext, status: n/a
 File: bootflash:Active_Dir/asr1000rp2-rpaccess.03.13.00.S.154-3.S-ext.pkg, on: RP1/0
 Built: 2013-07-25_22.55, by: mcpre
 File SHA1 checksum: a360dff0fd76a9b1ae67cda9116c97b62f25ab09
Package: rpcontrol, version: 03.13.00.S.154-3.S-ext, status: n/a
 File: bootflash:Active_Dir/asr1000rp2-rpcontrol.03.13.00.S.154-3.S-ext.pkg, on: RP1/1
 Built: 2013-07-25_22.55, by: mcpre
 File SHA1 checksum: 8a0a45ea5c7a656c0eef6726174461584f182c78
Package: rpios-adventerprisek9, version: 03.13.00.S.154-3.S-ext, status: n/a
 File: bootflash:Active_Dir/asr1000rp2-rpios-adventerprisek9.03.13.00.S.154-3.S-ext.pkg,
on: RP1/1
 Built: 2013-07-25_23.00, by: mcpre
 File SHA1 checksum: 85e9eab826bfff2194ef568a56c76453625383ad2
Package: rpaccess, version: 03.13.00.S.154-3.S-ext, status: n/a
 File: bootflash:Active_Dir/asr1000rp2-rpaccess.03.13.00.S.154-3.S-ext.pkg, on: RP1/1
 Built: 2013-07-25_22.55, by: mcpre
 File SHA1 checksum: a360dff0fd76a9b1ae67cda9116c97b62f25ab09
Package: espbase, version: 03.13.00.S.154-3.S-ext, status: n/a
 File: bootflash:Active_Dir/asr1000rp2-espbase.03.13.00.S.154-3.S-ext.pkg, on: ESP0
 Built: 2013-07-25_21.16, by: mcpre
 File SHA1 checksum: 2fe0ede1545e3f8260b7d453653e812500f0d7b0
Package: espx86base, version: 03.13.00.S.154-3.S-ext, status: n/a
 File: bootflash:Active_Dir/asr1000rp2-espx86base.03.13.00.S.154-3.S-ext.pkg, on: ESP0
 Built: 2013-07-25_22.55, by: mcpre
 File SHA1 checksum: 571b8bb3866341badd6e24de677b98409f0c789c
Package: espbase, version: 03.13.00.S.154-3.S-ext, status: n/a
 File: bootflash:Active_Dir/asr1000rp2-espbase.03.13.00.S.154-3.S-ext.pkg, on: ESP1
 Built: 2013-07-25_21.16, by: mcpre
 File SHA1 checksum: 2fe0ede1545e3f8260b7d453653e812500f0d7b0
Package: spx86base, version: 03.13.00.S.154-3.S-ext, status: n/a
 File: bootflash:Active_Dir/asr1000rp2-espx86base.03.13.00.S.154-3.S-ext.pkg, on: ESP1
 Built: 2013-07-25_22.55, by: mcpre
 File SHA1 checksum: 571b8bb3866341badd6e24de677b98409f0c789c
Package: sipbase, version: 03.13.00.S.154-3.S-ext, status: n/a
 File: bootflash:Active_Dir/asr1000rp2-sipbase.03.13.00.S.154-3.S-ext.pkg, on: SIP0
 Built: 2013-07-25_21.16, by: mcpre
 File SHA1 checksum: 3b6a4838972840a995ff22e73fd2bae910b268a7
Package: elcbase, version: 03.13.00.S.154-3.S-ext, status: n
 File: bootflash:Active_Dir/asr1000rp2-elcbase.03.13.00.S.154-3.S-ext.pkg, on: SIP0
 Built: 2013-07-25_21.16, by: mcpre
 File SHA1 checksum: 99f8dc925083b118626a4e82d93079050db96826
Package: sipspa, version: 03.13.00.S.154-3.S-ext, status: n/a
 File: bootflash:Active_Dir/asr1000rp2-sipspa.03.13.00.S.154-3.S-ext.pkg, on: SIP0/0
 Built: 2013-07-25_21.16, by: mcpre

```

## Examples

```

File SHA1 checksum: 6d12280b5cc33d17d752f475bf340b77ef3451ca
Package: elcspa, version: 03.13.00.S.154-3.S-ext, status: n/a
File: bootflash:Active_Dir/asr1000rp2-elcspa.03.13.00.S.154-3.S-ext.pkg, on: SIP0/0
Built: 2013-07-25_21.16, by: mcpre
File SHA1 checksum: 94763274fc807489410e299a45fd73fce9d67499
Package: sipspa, version: 03.13.00.S.154-3.S-ext, status: n/a
File: bootflash:Active_Dir/asr1000rp2-sipspa.03.13.00.S.154-3.S-ext.pkg, on: SIP0/1
Built: 2013-07-25_21.16, by: mcpre
File SHA1 checksum: 6d12280b5cc33d17d752f475bf340b77ef3451ca
Package: elcspa, version: 03.13.00.S.154-3.S-ext, status: n/a
File: bootflash:Active_Dir/asr1000rp2-elcspa.03.13.00.S.154-3.S-ext.pkg, on: SIP0/1
Built: 2013-07-25_21.16, by: mcpre
File SHA1 checksum: 94763274fc807489410e299a45fd73fce9d67499
Package: sipspa, version: 03.13.00.S.154-3.S-ext, status: n/a
File: bootflash:Active_Dir/asr1000rp2-sipspa.03.13.00.S.154-3.S-ext.pkg, on: SIP0/2
Built: 2013-07-25_21.16, by: mcpre
File SHA1 checksum: 6d12280b5cc33d17d752f475bf340b77ef3451ca
Package: elcspa, version: 03.13.00.S.154-3.S-ext, status: n/a
File: bootflash:Active_Dir/asr1000rp2-elcspa.03.13.00.S.154-3.S-ext.pkg, on: SIP0/2
Built: 2013-07-25_21.16, by: mcpre
File SHA1 checksum: 94763274fc807489410e299a45fd73fce9d67499
Package: sipspa, version: 03.13.00.S.154-3.S-ext, status: n/a
File: bootflash:Active_Dir/asr1000rp2-sipspa.03.13.00.S.154-3.S-ext.pkg, on: SIP0/3
Built: 2013-07-25_21.16, by: mcpre
File SHA1 checksum: 6d12280b5cc33d17d752f475bf340b77ef3451ca
Package: elcspa, version: 03.13.00.S.154-3.S-ext, status: n/a
File: bootflash:Active_Dir/asr1000rp2-elcspa.03.13.00.S.154-3.S-ext.pkg, on: SIP0/3
Built: 2013-07-25_21.16, by: mcpre
File SHA1 checksum: 94763274fc807489410e299a45fd73fce9d67499
Package: sipbase, version: 03.13.00.S.154-3.S-ext, status: n/a
File: bootflash:Active_Dir/asr1000rp2-sipbase.03.13.00.S.154-3.S-ext.pkg, on: SIP1
Built: 2013-07-25_21.16, by: mcpre
File SHA1 checksum: 3b6a4838972840a995ff22e73fd2bae910b268a7
Package: elcbase, version: 03.13.00.S.154-3.S-ext, status: n/a
File: bootflash:Active_Dir/asr1000rp2-elcbase.03.13.00.S.154-3.S-ext.pkg, on: SIP1
Built: 2013-07-25_21.16, by: mcpre
File SHA1 checksum: 99f8dc925083b118626a4e82d93079050db96826
Package: sipspa, version: 03.13.00.S.154-3.S-ext, status: n/a
File: bootflash:Active_Dir/asr1000rp2-sipspa.03.13.00.S.154-3.S-ext.pkg, on: SIP1/0
Built: 2013-07-25_21.16, by: mcpre
File SHA1 checksum: 6d12280b5cc33d17d752f475bf340b77ef3451ca
Package: elcspa, version: 03.13.00.S.154-3.S-ext, status: n/a
File: bootflash:Active_Dir/asr1000rp2-elcspa.03.13.00.S.154-3.S-ext.pkg, on: SIP1/0
Built: 2013-07-25_21.16, by: mcpre
File SHA1 checksum: 94763274fc807489410e299a45fd73fce9d67499
Package: sipspa, version: 03.13.00.S.154-3.S-ext, status: n/a
File: bootflash:Active_Dir/asr1000rp2-sipspa.03.13.00.S.154-3.S-ext.pkg, on: SIP1/1
Built: 2013-07-25_21.16, by: mcpre
File SHA1 checksum: 6d12280b5cc33d17d752f475bf340b77ef3451ca
Package: elcspa, version: 03.13.00.S.154-3.S-ext, status: n/a
File: bootflash:Active_Dir/asr1000rp2-elcspa.03.13.00.S.154-3.S-ext.pkg, on: SIP1/1
Built: 2013-07-25_21.16, by: mcpre
File SHA1 checksum: 94763274fc807489410e299a45fd73fce9d67499
Package: sipspa, version: 03.13.00.S.154-3.S-ext, status: n/a
File: bootflash:Active_Dir/asr1000rp2-sipspa.03.13.00.S.154-3.S-ext.pkg, on: SIP1/2
Built: 2013-07-25_21.16, by: mcpre
File SHA1 checksum: 6d12280b5cc33d17d752f475bf340b77ef3451ca
Package: elcspa, version: 03.13.00.S.154-3.S-ext, status: n/a
File: bootflash:Active_Dir/asr1000rp2-elcspa.03.13.00.S.154-3.S-ext.pkg, on: SIP1/2
Built: 2013-07-25_21.16, by: mcpre
File SHA1 checksum: 94763274fc807489410e299a45fd73fce9d67499
Package: sipspa, version: 03.13.00.S.154-3.S-ext, status: n/a
File: bootflash:Active_Dir/asr1000rp2-sipspa.03.13.00.S.154-3.S-ext.pkg, on: SIP1/3
Built: 2013-07-25_21.16, by: mcpre

```

```
File SHA1 checksum: 6d12280b5cc33d17d752f475bf340b77ef3451ca
Package: elcspa, version: 03.13.00.S.154-3.S-ext, status: n/a
File: bootflash:Active_Dir/asr1000rp2-elcspa.03.13.00.S.154-3.S-ext.pkg, on: SIP1/3
Built: 2013-07-25_21.16, by: mcpre
File SHA1 checksum: 94763274fc807489410e299a45fd73fce9d67499
Package: sipbase, version: 03.13.00.S.154-3.S-ext, status: n/a
File: bootflash:Active_Dir/asr1000rp2-sipbase.03.13.00.S.154-3.S-ext.pkg, on: SIP2
Built: 2013-07-25_21.16, by: mcpre
File SHA1 checksum: 3b6a4838972840a995ff22e73fd2bae910b268a7
Package: elcbase, version: 03.13.00.S.154-3.S-ext, status: n/a
File: bootflash:Active_Dir/asr1000rp2-elcbase.03.13.00.S.154-3.S-ext.pkg, on: SIP2
Built: 2013-07-25_21.16, by: mcpre
File SHA1 checksum: 99f8dc925083b118626a4e82d93079050db96826
Package: sipspa, version: 03.13.00.S.154-3.S-ext, status: n/a
File: bootflash:Active_Dir/asr1000rp2-sipspa.03.13.00.S.154-3.S-ext.pkg, on: SIP2/0
Built: 2013-07-25_21.16, by: mcpre
File SHA1 checksum: 6d12280b5cc33d17d752f475bf340b77ef3451ca
Package: elcspa, version: 03.13.00.S.154-3.S-ext, status: n/a
File: bootflash:Active_Dir/asr1000rp2-elcspa.03.13.00.S.154-3.S-ext.pkg, on: SIP2/0
Built: 2013-07-25_21.16, by: mcpre
File SHA1 checksum: 94763274fc807489410e299a45fd73fce9d67499
Package: sipspa, version: 03.13.00.S.154-3.S-ext, status: n/a
File: bootflash:Active_Dir/asr1000rp2-sipspa.03.13.00.S.154-3.S-ext.pkg, on: SIP2/1
Built: 2013-07-25_21.16, by: mcpre
File SHA1 checksum: 6d12280b5cc33d17d752f475bf340b77ef3451ca
Package: elcspa, version: 03.13.00.S.154-3.S-ext, status: n/a
File: bootflash:Active_Dir/asr1000rp2-elcspa.03.13.00.S.154-3.S-ext.pkg, on: SIP2/1
Built: 2013-07-25_21.16, by: mcpre
File SHA1 checksum: 94763274fc807489410e299a45fd73fce9d67499
Package: sipspa, version: 03.13.00.S.154-3.S-ext, status: n/a
File: bootflash:Active_Dir/asr1000rp2-sipspa.03.13.00.S.154-3.S-ext.pkg, on: SIP2/2
Built: 2013-07-25_21.16, by: mcpre
File SHA1 checksum: 6d12280b5cc33d17d752f475bf340b77ef3451ca
Package: elcspa, version: 03.13.00.S.154-3.S-ext, status: n/a
File: bootflash:Active_Dir/asr1000rp2-elcspa.03.13.00.S.154-3.S-ext.pkg, on: SIP2/2
Built: 2013-07-25_21.16, by: mcpre
File SHA1 checksum: 94763274fc807489410e299a45fd73fce9d67499
Package: sipspa, version: 03.13.00.S.154-3.S-ext, status: n/a
File: bootflash:Active_Dir/asr1000rp2-sipspa.03.13.00.S.154-3.S-ext.pkg, on: SIP2/3
Built: 2013-07-25_21.16, by: mcpre
File SHA1 checksum: 6d12280b5cc33d17d752f475bf340b77ef3451ca
Package: elcspa, version: 03.13.00.S.154-3.S-ext, status: n/a
File: bootflash:Active_Dir/asr1000rp2-elcspa.03.13.00.S.154-3.S-ext.pkg, on: SIP2/3
Built: 2013-07-25_21.16, by: mcpre
File SHA1 checksum: 94763274fc807489410e299a45fd73fce9d67499
Package: sipbase, version: 03.13.00.S.154-3.S-ext, status: n/a
File: bootflash:Active_Dir/asr1000rp2-sipbase.03.13.00.S.154-3.S-ext.pkg, on: SIP3
Built: 2013-07-25_21.16, by: mcpre
File SHA1 checksum: 3b6a4838972840a995ff22e73fd2bae910b268a7
Package: elcbase, version: 03.13.00.S.154-3.S-ext, status: n/a
File: bootflash:Active_Dir/asr1000rp2-elcbase.03.13.00.S.154-3.S-ext.pkg, on: SIP3
Built: 2013-07-25_21.16, by: mcpre
File SHA1 checksum: 99f8dc925083b118626a4e82d93079050db96826
Package: sipspa, version: 03.13.00.S.154-3.S-ext, status: n/a
File: bootflash:Active_Dir/asr1000rp2-sipspa.03.13.00.S.154-3.S-ext.pkg, on: SIP3/0
Built: 2013-07-25_21.16, by: mcpre
File SHA1 checksum: 6d12280b5cc33d17d752f475bf340b77ef3451ca
Package: elcspa, version: 03.13.00.S.154-3.S-ext, status: n/a
File: bootflash:Active_Dir/asr1000rp2-elcspa.03.13.00.S.154-3.S-ext.pkg, on: SIP3/0
Built: 2013-07-25_21.16, by: mcpre
File SHA1 checksum: 94763274fc807489410e299a45fd73fce9d67499
Package: sipspa, version: 03.13.00.S.154-3.S-ext, status: n/a
File: bootflash:Active_Dir/asr1000rp2-sipspa.03.13.00.S.154-3.S-ext.pkg, on: SIP3/1
Built: 2013-07-25_21.16, by: mcpre
```

## Examples

```

File SHA1 checksum: 6d12280b5cc33d17d752f475bf340b77ef3451ca
Package: elcspa, version: 03.13.00.S.154-3.S-ext, status: n/a
File: bootflash:Active_Dir/asr1000rp2-elcspa.03.13.00.S.154-3.S-ext.pkg, on: SIP3/1
Built: 2013-07-25_21.16, by: mcpre
File SHA1 checksum: 94763274fc807489410e299a45fd73fce9d67499
Package: sipspa, version: 03.13.00.S.154-3.S-ext, status: n/a
File: bootflash:Active_Dir/asr1000rp2-sipspa.03.13.00.S.154-3.S-ext.pkg, on: SIP3/2
Built: 2013-07-25_21.16, by: mcpre
File SHA1 checksum: 6d12280b5cc33d17d752f475bf340b77ef3451ca
Package: elcspa, version: 03.13.00.S.154-3.S-ext, status: n/a
File: bootflash:Active_Dir/asr1000rp2-elcspa.03.13.00.S.154-3.S-ext.pkg, on: SIP3/2
Built: 2013-07-25_21.16, by: mcpre
File SHA1 checksum: 94763274fc807489410e299a45fd73fce9d67499
Package: sipspa, version: 03.13.00.S.154-3.S-ext, status: n/a
File: bootflash:Active_Dir/asr1000rp2-sipspa.03.13.00.S.154-3.S-ext.pkg, on: SIP3/3
Built: 2013-07-25_21.16, by: mcpre
File SHA1 checksum: 6d12280b5cc33d17d752f475bf340b77ef3451ca
Package: elcspa, version: 03.13.00.S.154-3.S-ext, status: n/a
File: bootflash:Active_Dir/asr1000rp2-elcspa.03.13.00.S.154-3.S-ext.pkg, on: SIP3/3
Built: 2013-07-25_21.16, by: mcpre
File SHA1 checksum: 94763274fc807489410e299a45fd73fce9d67499
Package: sipbase, version: 03.13.00.S.154-3.S-ext, status: n/a
File: bootflash:Active_Dir/asr1000rp2-sipbase.03.13.00.S.154-3.S-ext.pkg, on: SIP4
Built: 2013-07-25_21.16, by: mcpre
File SHA1 checksum: 3b6a4838972840a995ff22e73fd2bae910b268a7
Package: elcbase, version: 03.13.00.S.154-3.S-ext, status: n/a
File: bootflash:Active_Dir/asr1000rp2-elcbase.03.13.00.S.154-3.S-ext.pkg, on: SIP4
Built: 2013-07-25_21.16, by: mcpre
File SHA1 checksum: 99f8dc925083b118626a4e82d93079050db96826
Package: sipspa, version: 03.13.00.S.154-3.S-ext, status: n/a
File: bootflash:Active_Dir/asr1000rp2-sipspa.03.13.00.S.154-3.S-ext.pkg, on: SIP4/0
Built: 2013-07-25_21.16, by: mcpre
File SHA1 checksum: 6d12280b5cc33d17d752f475bf340b77ef3451ca
Package: elcspa, version: 03.13.00.S.154-3.S-ext, status: n/a
File: bootflash:Active_Dir/asr1000rp2-elcspa.03.13.00.S.154-3.S-ext.pkg, on: SIP4/0
Built: 2013-07-25_21.16, by: mcpre
File SHA1 checksum: 94763274fc807489410e299a45fd73fce9d67499
Package: sipspa, version: 03.13.00.S.154-3.S-ext, status: n/a
File: bootflash:Active_Dir/asr1000rp2-sipspa.03.13.00.S.154-3.S-ext.pkg, on: SIP4/1
Built: 2013-07-25_21.16, by: mcpre
File SHA1 checksum: 6d12280b5cc33d17d752f475bf340b77ef3451ca
Package: elcspa, version: 03.13.00.S.154-3.S-ext, status: n/a
File: bootflash:Active_Dir/asr1000rp2-elcspa.03.13.00.S.154-3.S-ext.pkg, on: SIP4/1
Built: 2013-07-25_21.16, by: mcpre
File SHA1 checksum: 94763274fc807489410e299a45fd73fce9d67499
Package: sipspa, version: 03.13.00.S.154-3.S-ext, status: n/a
File: bootflash:Active_Dir/asr1000rp2-sipspa.03.13.00.S.154-3.S-ext.pkg, on: SIP4/2
Built: 2013-07-25_21.16, by: mcpre
File SHA1 checksum: 6d12280b5cc33d17d752f475bf340b77ef3451ca
Package: elcspa, version: 03.13.00.S.154-3.S-ext, status: n/a
File: bootflash:Active_Dir/asr1000rp2-elcspa.03.13.00.S.154-3.S-ext.pkg, on: SIP4/2
Built: 2013-07-25_21.16, by: mcpre
File SHA1 checksum: 94763274fc807489410e299a45fd73fce9d67499
Package: sipspa, version: 03.13.00.S.154-3.S-ext, status: n/a
File: bootflash:Active_Dir/asr1000rp2-sipspa.03.13.00.S.154-3.S-ext.pkg, on: SIP4/3
Built: 2013-07-25_21.16, by: mcpre
File SHA1 checksum: 6d12280b5cc33d17d752f475bf340b77ef3451ca
Package: elcspa, version: 03.13.00.S.154-3.S-ext, status: n/a
File: bootflash:Active_Dir/asr1000rp2-elcspa.03.13.00.S.154-3.S-ext.pkg, on: SIP4/3
Built: 2013-07-25_21.16, by: mcpre
File SHA1 checksum: 94763274fc807489410e299a45fd73fce9d67499
Package: sipbase, version: 03.13.00.S.154-3.S-ext, status: n/a
File: bootflash:Active_Dir/asr1000rp2-sipbase.03.13.00.S.154-3.S-ext.pkg, on: SIP5
Built: 2013-07-25_21.16, by: mcpre

```

```

File SHA1 checksum: 3b6a4838972840a995ff22e73fd2bae910b268a7
Package: elcbase, version: 03.13.00.S.154-3.S-ext, status: n/a
File: bootflash:Active_Dir/asr1000rp2-elcbase.03.13.00.S.154-3.S-ext.pkg, on: SIP5
Built: 2013-07-25_21.16, by: mcpre
File SHA1 checksum: 99f8dc925083b118626a4e82d93079050db96826
Package: sipspa, version: 03.13.00.S.154-3.S-ext, status: n/a
File: bootflash:Active_Dir/asr1000rp2-sipspa.03.13.00.S.154-3.S-ext.pkg, on: SIP5/0
Built: 2013-07-25_21.16, by: mcpre
File SHA1 checksum: 6d12280b5cc33d17d752f475bf340b77ef3451ca
Package: elcspa, version: 03.13.00.S.154-3.S-ext, status: n/a
File: bootflash:Active_Dir/asr1000rp2-elcspa.03.13.00.S.154-3.S-ext.pkg, on: SIP5/0
Built: 2013-07-25_21.16, by: mcpre
File SHA1 checksum: 94763274fc807489410e299a45fd73fce9d67499
Package: sipspa, version: 03.13.00.S.154-3.S-ext, status: n/a
File: bootflash:Active_Dir/asr1000rp2-sipspa.03.13.00.S.154-3.S-ext.pkg, on: SIP5/1
Built: 2013-07-25_21.16, by: mcpre
File SHA1 checksum: 6d12280b5cc33d17d752f475bf340b77ef3451ca
Package: elcspa, version: 03.13.00.S.154-3.S-ext, status: n/a
File: bootflash:Active_Dir/asr1000rp2-elcspa.03.13.00.S.154-3.S-ext.pkg, on: SIP5/1
Built: 2013-07-25_21.16, by: mcpre
File SHA1 checksum: 94763274fc807489410e299a45fd73fce9d67499
Package: sipspa, version: 03.13.00.S.154-3.S-ext, status: n/a
File: bootflash:Active_Dir/asr1000rp2-sipspa.03.13.00.S.154-3.S-ext.pkg, on: SIP5/2
Built: 2013-07-25_21.16, by: mcpre
File SHA1 checksum: 6d12280b5cc33d17d752f475bf340b77ef3451ca
Package: elcspa, version: 03.13.00.S.154-3.S-ext, status: n/a
File: bootflash:Active_Dir/asr1000rp2-elcspa.03.13.00.S.154-3.S-ext.pkg, on: SIP5/2
Built: 2013-07-25_21.16, by: mcpre
File SHA1 checksum: 94763274fc807489410e299a45fd73fce9d67499
Package: sipspa, version: 03.13.00.S.154-3.S-ext, status: n/a
File: bootflash:Active_Dir/asr1000rp2-sipspa.03.13.00.S.154-3.S-ext.pkg, on: SIP5/3
Built: 2013-07-25_21.16, by: mcpre
File SHA1 checksum: 6d12280b5cc33d17d752f475bf340b77ef3451ca
Package: elcspa, version: 03.13.00.S.154-3.S-ext, status: n/a
File: bootflash:Active_Dir/asr1000rp2-elcspa.03.13.00.S.154-3.S-ext.pkg, on: SIP5/3
Built: 2013-07-25_21.16, by: mcpre
File SHA1 checksum: 94763274fc807489410e299a45fd73fce9d67499
Router# reload
<some output removed for brevity>
Router# request platform software package clean
Cleaning up unnecessary package files
No path specified, will use booted path bootflash:Active_Dir/packages.conf
Cleaning bootflash:Active_Dir
Scanning boot directory for packages ... done.
Preparing packages list to delete ...asr1000rp2-elcbase.03.13.00.S.154-3.S-ext.pkg

File is in use, will not delete... asr1000rp2-elcspa.03.13.00.S.154-3.S-ext.pkg
File is in use, will not delete...asr1000rp2-espbase.03.13.00.S.154-3.S-ext.pkg
File is in use, will not delete...asr1000rp2-esp86base.03.13.00.S.154-3.S-ext.pkg
File is in use, will not delete...asr1000rp2-rpaccess.03.13.00.S.154-3.S-ext.pkg
File is in use, will not delete...asr1000rp2-rpbase.03.13.00.S.154-3.S-ext.pkg
File is in use, will not delete...asr1000rp2-rpcontrol.03.13.00.S.154-3.S-ext.pkg
File is in use, will not
delete...asr1000rp2-rpios-dventerprise9.03.13.00.S.154-3.S-ext.pkg
File is in use, will not delete...asr1000rp2-sipbase.03.13.00.S.154-3.S-ext.pkg
File is in use, will not delete...sr1000rp2-sipspa.03.13.00.S.154-3.S-ext.pkg
File is in use, will not delete... packages.conf
File is in use, will not delete...done.
Files that will be deleted:
asr1000rp2-elcbase.03.12.01.S.154-2.S.pkg
asr1000rp2-elcspa.03.12.01.S.154-2.S.pkg
asr1000rp2-espbase.03.12.01.S.154-2.S.pkg
asr1000rp2-esp86base.03.12.01.S.154-2.S.pkg
asr1000rp2-packages-adventerprise9.03.12.01.S.154-2.S.conf

```

```

asr1000rp2-rpaccess.03.12.01.S.154-2.S.pkg
asr1000rp2-rpbase.03.12.01.S.154-2.S.pkg
asr1000rp2-rpcontrol.03.12.01.S.154-2.S.pkg
asr1000rp2-rpios-adventerprisek9.03.12.01.S.154-2.S.pkg
asr1000rp2-sipbase.03.12.01.S.154-2.S.pkg
asr1000rp2-sipspa.03.12.01.S.154-2.S.pkg
packages.conf.00-
packages.conf.01-
packages.conf.02-
packages.conf.03-
packages.conf.04-
packages.conf.05-
Do you want to proceed? [confirm]y
Deleting file bootflash:Active_Dir/asr1000rp2-elcbase.03.12.01.S.154-2.S.pkg ... done.
Deleting file bootflash:Active_Dir/asr1000rp2-elcspa.03.12.01.S.154-2.S.pkg ... done.
Deleting file bootflash:Active_Dir/asr1000rp2-espbase.03.12.01.S.154-2.S.pkg ... done.
Deleting file bootflash:Active_Dir/asr1000rp2-esp86base.03.12.01.S.154-2.S.pkg ... done.
Deleting file
bootflash:Active_Dir/asr1000rp2-packages-adventerprisek9.03.12.01.S.154-2.S.conf ... done.
Deleting file bootflash:Active_Dir/asr1000rp2-rpaccess.03.12.01.S.154-2.S.pkg ... done.
Deleting file bootflash:Active_Dir/asr1000rp2-rpbase.03.12.01.S.154-2.S.pkg ... done.
Deleting file bootflash:Active_Dir/asr1000rp2-rpcontrol.03.12.01.S.154-2.S.pkg ... done.
Deleting file bootflash:Active_Dir/asr1000rp2-rpios-adventerprisek9.03.12.01.S.154-2.S.pkg
... done.
Deleting file bootflash:Active_Dir/asr1000rp2-sipbase.03.12.01.S.154-2.S.pkg ... done.
Deleting file bootflash:Active_Dir/asr1000rp2-sipspa.03.12.01.S.154-2.S.pkg ... done.
Deleting file bootflash:Active_Dir/packages.conf.00- ... done.
Deleting file bootflash:Active_Dir/packages.conf.01- ... done.
Deleting file bootflash:Active_Dir/packages.conf.02- ... done.
Deleting file bootflash:Active_Dir/packages.conf.03- ... done.
Deleting file bootflash:Active_Dir/packages.conf.04- ... done.
Deleting file bootflash:Active_Dir/packages.conf.05- ... done.
SUCCESS: Files deleted.

```

## Minimal Disruptive Restart ISSU

A software upgrade of a SIP in any mode results in the SIP being reset and the occurrence of minimal outage during the upgrade. Minimal Disruptive Restart (MDR) minimizes traffic disruption during a software upgrade and supports consolidated package software upgrade and subpackage software upgrade for SIP-40.

The software upgrade of a SIP using MDR is supported only on the Cisco ASR 1000 Series Aggregation Services routers running Cisco IOS XE Release 3.8S and later.



---

**Note** MDR upgrades (both consolidated and subpackage upgrades) are supported only on hardware-redundant dual route processor (RP) and Enhanced Services Processors (ESP) platforms.

---

MDR reduces the downtime (time during which the data plane is unavailable) due to ISSU of a SIP and the SPA(s) within it. The downtime is reduced from 100 seconds to not more than 25 seconds on a SIP reload and from 30 seconds to not more than 10 seconds on a SPA reload. The reload time of a SIP or SPA using a MDR or a non-MDR upgrade remains the same.

MDR for a SIP is permitted if following conditions are met:

- Chassis is hardware redundant (dual RP and dual ESP)
- SIP-type supports MDR.
- At least one MDR-compatible SPA in the SIP should be present for the MDR process.



- All the SPAs associated with the SIP support MDR.
- Both the current software version and the upgrade software version must be ISSU and MDR compatible for both the SIPBase and SIPSPA subpackages for each SPA type that is present.

The following SPAs support MDR:

- SPA-2X1GE-V2
- SPA-5X1GE-V2
- SPA-8X1GE-V2
- SPA-10X1GE-V2
- SPA-1X10GE-L-V2

Starting with IOS XE release 3.10S and later, MDR support has been extended to include the following SPAs:

- SPA-2XOC3-POS
- SPA-4XOC3-POS
- SPA-4XOC3-POS-V2
- SPA-8XOC3-POS
- SPA-1XOC12-POS
- SPA-2XOC12-POS
- SPA-4XOC12-POS
- SPA-8XOC12-POS

Effective from Cisco IOS XE Release 3.12S, the Cisco ASR 1000 Series Fixed Ethernet Line Card (ASR1000-2T+20X1GE) supports Minimal Disruptive Restart (MDR) for ELBase and ELCSA packages. MDR support for ASR1000-2T+20X1GE is specifically available on the Cisco ASR 1006 Router and the Cisco ASR 1013 Router with Route Processor 2 (RP2).

For more information on the Cisco ASR 1000 Series Fixed Ethernet Line Card (ASR1000-2T+20X1GE), see the following documents:

[Cisco ASR 1000 Series Fixed Ethernet Line Card Hardware Installation Guide](#)

[Cisco ASR 1000 Fixed Ethernet Line Card Software Configuration Guide](#)

Use the **request platform software package verify** and **issu checkversion** commands with the **mdr** option to verify the MDR upgrade compatibility of a consolidated package or an individual subpackage.

When performing an ISSU upgrade, you can specify whether the upgrade should use MDR. If you do not specify this, the ISSU upgrade process will remain unchanged.

## Restrictions and Limitations

- MDR is not supported on non-hardware-redundant platforms, such as, Cisco ASR 1001 Router, Cisco ASR 1001-X Router, Cisco ASR 1002 Router, Cisco ASR 1002-X Router, or Cisco ASR 1004 Router, and on hardware-redundant platforms without redundant hardware, such as, Cisco ASR 1006 router, or Cisco ASR 1013 router with only a single RP or ESP.
- MDR is not supported on Polaris 16.x.x release.
- MDR is not supported on SIP10.
- MDR does not support software downgrade.
- To use MDR, both the current software and the upgrade software must be ISSU and MDR compatible.
- If a SIP is performing an MDR upgrade the following events cannot be handled during the upgrade:

- Fast Reroute (FRR)
- Automatic protection switching (APS)
- Ethernet over Multiprotocol Label Switching (EoMPLS) and pseudoWire (PW) down that require an attachment circuit (AC) port to be shut.
- Interface flaps and interface errors
- Interface-specific or linecard-specific configuration changes
- SPA Online Insertion and Removal (OIR)
- Transceiver OIR
- Line alarms
- Statistics—Error counts will be reset

## High-Availability Considerations

Any high-availability (HA) failover that occurs during MDR-process terminates the process. This includes failures such as active RP IOS failover during the MDR upgrade process or active RP FRU failure in a chassis with redundant hardware during subpackage upgrade.

For MDR upgrade using consolidated packages, upgrade is initiated by the upgraded active RP after the ESP software has been upgraded.

## Using ISSU to Perform a Consolidated Package Upgrade in a Dual Route Processor Configuration with MDR

Consolidated packages can only be upgraded using ISSU in dual Route Processor configurations. ISSU is not supported for consolidated package upgrades in single Route Processor configurations.

If you want the RPs on your Cisco ASR 1000 Series router to be running using a consolidated package with MDR after the ISSU upgrade is complete, use the following instructions:



---

**Note** This procedure will only work if the current RPs are already running consolidated packages.

---

### SUMMARY STEPS

1. **ip tftp** *source-interface gigabitethernet slot/port*
2. **copy tftp:** *URL-to-target-location*
3. **copy** *source-file-system:filename standby-destination-filesystem*
4. **dir** *URL-to-target-location*
5. **issu checkversion rp** *upgrade-rp-number file URL mdr {force}*
6. **product="kwdname="issu loadversion rp** *upgrade-rp-number file standby-file-system:filename mdr {force}*
7. **issu runversion**
8. **telnetip-addressport**
9. **issu acceptversion**
10. **issu commitversion**

11. `show version`
12. `hw-module slot RP-slot reload`

## DETAILED STEPS

|        | Command or Action                                                                                                                                                                                                         | Purpose                                                                                                                                                                                                                                                                                                                                                                 |
|--------|---------------------------------------------------------------------------------------------------------------------------------------------------------------------------------------------------------------------------|-------------------------------------------------------------------------------------------------------------------------------------------------------------------------------------------------------------------------------------------------------------------------------------------------------------------------------------------------------------------------|
| Step 1 | <p><b>ip tftp</b> <i>source-interface gigabitethernet slot/port</i></p> <p><b>Example:</b></p> <pre>Router(config)# ip tftp source-interface gigabitethernet 0</pre>                                                      | <p>Specifies the Gigabit Ethernet TFTP source-interface to be configured:</p> <p>slot/port—Specifies the location of the TFTP source-interface.</p> <p><b>Note</b> To copy a file using TFTP through the Management Ethernet interface, the <b>ip tftp source-interface GigabitEthernet 0</b> command must be entered before entering the <b>copy tftp</b> command.</p> |
| Step 2 | <p><b>copy tftp:</b> <i>URL-to-target-location</i></p> <p><b>Example:</b></p> <pre>copy source-file-system:filename standby-destination-filesystem</pre> <p><b>Example:</b></p> <pre>Router# copy tftp bootflash:</pre>   | Copy the consolidated package onto the active RP.                                                                                                                                                                                                                                                                                                                       |
| Step 3 | <p><b>copy</b> <i>source-file-system:filename</i><br/><i>standby-destination-filesystem</i></p> <p><b>Example:</b></p> <pre>Router# copy bootflash:asr1000-2-enterprise9.03.13.00.S.154-3.S-ext.bin stby-bootflash:</pre> | Copy the consolidated package onto the standby RP.                                                                                                                                                                                                                                                                                                                      |
| Step 4 | <p><b>dir</b> <i>URL-to-target-location</i></p> <p><b>Example:</b></p> <pre>dir URL-to-target-stby-location</pre> <p><b>Example:</b></p> <pre>Router# dir bootflash:</pre>                                                | (Optional) Display the contents of the target directories to confirm the successful copy of the file package.                                                                                                                                                                                                                                                           |

|               | Command or Action                                                                                                                                                                                                                                                               | Purpose                                                                                                                                                                                                                                                                                                                                                                                                                                                                                                                                                                                                                                                                                                  |
|---------------|---------------------------------------------------------------------------------------------------------------------------------------------------------------------------------------------------------------------------------------------------------------------------------|----------------------------------------------------------------------------------------------------------------------------------------------------------------------------------------------------------------------------------------------------------------------------------------------------------------------------------------------------------------------------------------------------------------------------------------------------------------------------------------------------------------------------------------------------------------------------------------------------------------------------------------------------------------------------------------------------------|
|               | <p><b>Example:</b></p> <pre>Router# dir stby-bootflash:</pre>                                                                                                                                                                                                                   |                                                                                                                                                                                                                                                                                                                                                                                                                                                                                                                                                                                                                                                                                                          |
| <b>Step 5</b> | <pre>issu checkversion rp upgrade-rp-number file URL mdr {force}</pre> <p><b>Example:</b></p> <p><b>Example:</b></p> <pre>Router#issu checkversion rp 1 file stby-bootflash:as1000r2-enterprise9.03.13.00.S.154-3.S-ext.bin mdr</pre>                                           | Checks the ISSU MDR software packaging compatibility on the standby Route Processor (RP).                                                                                                                                                                                                                                                                                                                                                                                                                                                                                                                                                                                                                |
| <b>Step 6</b> | <pre>product="kwdname="issu loadversion rp upgrade-rp-number file standby-file-system:filename mdr {force}</pre> <p><b>Example:</b></p> <p><b>Example:</b></p> <pre>Router# issu loadversion rp 1 file stby-bootflash:as1000r2-enterprise9.03.13.00.S.154-3.S-ext.bin mdr</pre> | <p>Load the target consolidated package onto the standby RP.</p> <p>After you receive the message indicating that the terminal state has been reached continue with Step 7.</p>                                                                                                                                                                                                                                                                                                                                                                                                                                                                                                                          |
| <b>Step 7</b> | <pre>issu runversion</pre> <p><b>Example:</b></p> <p><b>Example:</b></p> <pre>Router# issu runversion</pre>                                                                                                                                                                     | <p>Run the consolidated package that was loaded in Step 6 .</p> <p><b>Note</b> If this command is entered before the terminal state is reached, a “ peer is not online ” or “ Standby RP is not in terminal state ” error message will be seen and the <b>issu runversion</b> command will not work. If the <b>issu runversion</b> command does not run for these reasons, wait for the “ terminal state is reached ” message to appear and retry the <b>issu runversion</b> command. You can also monitor the terminal state using the <b>show platform</b> command.</p> <p>After ISSU runversion is completed, a switchover will automatically occur and the standby RP will become the active RP.</p> |
| <b>Step 8</b> | <pre>telnetip-addressport</pre> <p><b>Example:</b></p> <p><b>Example:</b></p>                                                                                                                                                                                                   | Log in to the RP being upgraded, preferably using the RP’s console port, to complete the upgrade. (This is the new active RP, that was the standby RP prior to the ISSU process.)                                                                                                                                                                                                                                                                                                                                                                                                                                                                                                                        |

|                | Command or Action                                                                                                                                                                                                                                                                                                  | Purpose                                                                                                                                                                                                                                                                                                                                                                                                                                                                                                                        |
|----------------|--------------------------------------------------------------------------------------------------------------------------------------------------------------------------------------------------------------------------------------------------------------------------------------------------------------------|--------------------------------------------------------------------------------------------------------------------------------------------------------------------------------------------------------------------------------------------------------------------------------------------------------------------------------------------------------------------------------------------------------------------------------------------------------------------------------------------------------------------------------|
|                | <pre>[unix-server-1 ~]\$ telnet 198.51.100.157 2003</pre> <p><b>Example:</b></p> <pre>User Access Verification</pre> <p><b>Example:</b></p> <p><b>Example:</b></p> <pre>Username: user</pre> <p><b>Example:</b></p> <pre>Password: *****</pre> <p><b>Example:</b></p> <p><b>Example:</b></p> <pre>Router&gt;</pre> | <p><b>Note</b> Ensure the hostname does not end in “-stby” after logging into the RP, as this indicates that the RP being accessed is still the standby RP.</p> <p>There are many ways to log on to a console port. The example shows access to the console port from a UNIX host using telnet.</p>                                                                                                                                                                                                                            |
| <b>Step 9</b>  | <pre>issu acceptversion</pre> <p><b>Example:</b></p> <p><b>Example:</b></p> <pre>Router# issu acceptversion</pre>                                                                                                                                                                                                  | <p>(Optional) Stops the ISSU rollback timer.</p> <p>This step is optional as long as Step 10 is completed before the rollback timer expires.</p>                                                                                                                                                                                                                                                                                                                                                                               |
| <b>Step 10</b> | <pre>issu commitversion</pre> <p><b>Example:</b></p> <p><b>Example:</b></p> <pre>Router# issu commitversion</pre>                                                                                                                                                                                                  | <p>Completes the ISSU upgrade.</p>                                                                                                                                                                                                                                                                                                                                                                                                                                                                                             |
| <b>Step 11</b> | <pre>show version</pre> <p><b>Example:</b></p> <pre>show version active-RP running</pre> <p><b>Example:</b></p> <pre>show version active-RP provisioned</pre> <p><b>Example:</b></p> <pre>show platform</pre> <p><b>Example:</b></p>                                                                               | <p>(Optional) Enter the <b>show version</b>, <b>show platform</b>, or <b>show running-configuration</b> commands to confirm that the upgrade completed successfully, as follows:</p> <ul style="list-style-type: none"> <li>• <b>show version</b>—Confirm that the correct software version is running on your router and that the RP was booted from the correct file.</li> <li>• <b>show running-configuration</b>—Confirm that the booting configuration, in particular the boot system statements, are correct.</li> </ul> |

|                | Command or Action                                                                                                                            | Purpose                                                                                                                                                                                                                                                                                                                 |
|----------------|----------------------------------------------------------------------------------------------------------------------------------------------|-------------------------------------------------------------------------------------------------------------------------------------------------------------------------------------------------------------------------------------------------------------------------------------------------------------------------|
|                | <b>show running-configuration</b>                                                                                                            | <p><b>Tip</b> Use the <b>show running-config   include boot</b> command to display only the boot statements from the <b>show running-configuration</b> output.</p> <ul style="list-style-type: none"> <li>• <b>show platform</b>— Confirm that both RP0 and RP1 are correctly running as active and standby.</li> </ul> |
| <b>Step 12</b> | <p><b>hw-module slot <i>RP-slot</i> reload</b></p> <p><b>Example:</b></p> <p><b>Example:</b></p> <pre>Router# hw-module slot R0 reload</pre> | Reload the new software on the Standby RP.                                                                                                                                                                                                                                                                              |

## Examples

The following example shows how to perform consolidated package upgrade in a dual route processor configuration:

```
Router(config)# ip tftp source-interface gigabitethernet 0
Router#copy tftp: bootflash
:
Address or name of remote host []? 198.51.100.81
Source filename []? asr1000rp2-adventerprisek9.03.12.01.S.154-2.S1.bin
Destination filename [asr1000rp2-adventerprisek9.03.12.01.S.154-2.S1.bin]?
Accessing tftp://198.51.100.81/asr1000rp2-adventerprisek9.03.12.01.S.154-2.S1.bin...
Loading asr1000rp2-adventerprisek9.03.12.01.S.154-2.S1.bin from 198.51.100.81 (via
GigabitEthernet0/0/0): !!!!!!!!
[OK - 577420028 bytes]
577420028 bytes copied in 317.985 secs (1815872 bytes/sec)
Router#copy bootflash: stby-bootflash:

Source filename []? asr1000rp2-adventerprisek9.03.12.01.S.154-2.S1.bin
Destination filename [asr1000rp2-adventerprisek9.03.12.01.S.154-2.S1.bin]
?
Copy in progress...CCCCC<output removed for brevity>
577420028 bytes copied in 154.951 secs (3726469 bytes/sec)
Router#dir bootflash:
Directory of bootflash:/
 11 drwx 16384 Sep 26 2011 00:30:14 +00:00 lost+found
208833 drwx 4096 Sep 26 2011 00:30:57 +00:00 .ssh
48193 drwx 4096 Mar 12 2013 20:03:38 +00:00 .prst_sync
128513 drwx 4096 Sep 23 2012 19:08:45 +00:00 .rollback_timer
192770 drwx 4096 Sep 23 2012 19:08:45 +00:00 .installer
 16 -r-- 680 Oct 10 2012 20:27:21 +00:00 debug.conf
 22 -rw- 1135306 Nov 30 2012 02:15:24 +00:00 policy-250.pkg
224897 drwx 4096 Mar 12 2013 17:32:24 +00:00 vman_fdb
 13 -r-- 577995644 Mar 12 2013 21:17:20 +00:00
asr1000rp2-adventerprisek9.03.08.00.S.153-1.S.bin
 14 -r-- 577420028 Mar 12 2013 21:34:48 +00:00
asr1000rp2-adventerprisek9.03.12.01.S.154-2.S1.bin
192769 drwx 4096 May 30 2012 03:36:18 +00:00 virt_strg_pool_bf
```

```

 25 -rw- 0 Feb 26 2012 16:16:36 +00:00 virtual-instance-upgrade.conf
1940303872 bytes total (683945984 bytes free)
Router# dir stby-bootflash:
Directory of stby-bootflash:/
 11 drwx 16384 Apr 28 2009 03:43:50 +00:00 lost+found
 16065 drwx 4096 Mar 12 2013 18:26:02 +00:00 .installer
 208833 drwx 4096 May 30 2012 03:36:52 +00:00 virt_strg_pool_bf
 48193 drwx 4096 Mar 12 2013 22:39:32 +00:00 .prst_sync
 64257 drwx 4096 Mar 12 2013 18:26:02 +00:00 .rollback_timer
 224897 drwx 4096 Mar 12 2013 18:18:18 +00:00 vman_fdb
 112449 drwx 4096 Jan 26 2011 16:57:39 +00:00 .ssh
 12 -r-- 577995644 Mar 12 2013 21:17:47 +00:00
asr1000rp2-adventerprisek9.03.08.00.S.153-1.S.bin
 14 -r-- 680 Sep 4 2012 23:29:00 +00:00 debug.conf
 13 -r-- 577420028 Mar 12 2013 21:18:12 +00:00
asr1000rp2-adventerprisek9.03.12.01.S.154-2.S1.bin
 20 -rw- 0 Feb 26 2012 16:16:36 +00:00 virtual-instance-upgrade.conf
1940303872 bytes total (685084672 bytes free)
Router#issu checkversion rp 1 file
stby-bootflash:asr1000rp2-adventerprisek9.03.12.01.S.154-2.S1.bin mdr
--- Starting local lock acquisition on R0 ---
Finished local lock acquisition on R0
--- Starting installation state synchronization ---
Finished installation state synchronization
--- Starting local lock acquisition on R1 ---
Finished local lock acquisition on R1
--- Starting file path checking ---
Finished file path checking
--- Starting system installation readiness checking ---
Finished system installation readiness checking
--- Starting image verification ---
Compatibility check with running software on active RP
WARNING:
WARNING: Candidate software combination not found in compatibility database
WARNING:
WARNING:
WARNING: Candidate software combination not found in compatibility database
WARNING:
Software sets are identified as compatible
Finished image verification
--- Starting mdr compatibility verification ---
Extracting consolidated package content
Checking and verifying packages contained in consolidated package
Creating candidate provisioning file
Processing candidate provisioning file
Finished mdr compatibility verification
SUCCESS: Software is ISSU MDR compatible.
Router# issu loadversion rp 1 file stby-bootflash:
asr1000rp2-adventerprisek9.03.12.01.S.154-2.S1.bin mdr

--- Starting local lock acquisition on R0 ---
Finished local lock acquisition on R0
--- Starting installation state synchronization ---
Finished installation state synchronization
--- Starting local lock acquisition on R1 ---
Finished local lock acquisition on R1
--- Starting file path checking ---
Finished file path checking
--- Starting system installation readiness checking ---
Finished system installation readiness checking
--- Starting image verification ---
Compatibility check with running software on active RP
WARNING:
WARNING: Candidate software combination not found in compatibility database

```

```

WARNING:
WARNING:
WARNING: Candidate software combination not found in compatibility database
WARNING:
Software sets are identified as compatible
Finished image verification
--- Starting mdr compatibility verification ---
Extracting consolidated package content
Checking and verifying packages contained in consolidated package
Creating candidate provisioning file
Processing candidate provisioning file
Finished mdr compatibility verification
--- Starting installation changes ---
Setting up image to boot on next reset
Starting automatic rollback timer
Finished installation changes
SUCCESS: Software will now load.
*Mar 14 19:55:44.264: %IOSXE_OIR-6-OFFLINECARD: Card (rp) offline in slot R1
*Mar 14 19:55:44.288: %REDUNDANCY-3-STANDBY_LOST: Standby processor fault (PEER_NOT_PRESENT)
*Mar 14 19:55:44.288: %REDUNDANCY-3-STANDBY_LOST: Standby processor fault (PEER_DOWN)
*Mar 14 19:55:44.288: %REDUNDANCY-3-STANDBY_LOST: Standby processor fault
(Peer_REDUNDANCY_STATE_CHANGE)
*Mar 14 19:55:46.347: %RF-5-RF_RELOAD: Peer reload. Reason: EHSA standby down
*Mar 14 19:55:46.357: % Redundancy mode change to SSO
Router#
*Mar 14 19:59:37.523: %IOSXE_OIR-6-ONLINECARD: Card (rp) online in slot R1
*Mar 14 19:59:46.889: %REDUNDANCY-5-PEER_MONITOR_EVENT: Active detected a standby insertion
(raw-event=PEER_FOUND(4))
*Mar 14 19:59:46.889: %REDUNDANCY-5-PEER_MONITOR_EVENT: Active detected a standby insertion
(raw-event=PEER_REDUNDANCY_STATE_CHANGE(5))
*Mar 14 19:59:49.794: %REDUNDANCY-3-IPC: IOS versions do not match.

*Mar 14 20:00:58.364: %NBAR_HA-5-NBAR_INFO: NBAR sync DONE!
*Mar 14 20:00:58.777: %HA_CONFIG_SYNC-6-BULK_CFGSYNC_SUCCEEDED: Bulk Sync succeeded
*Mar 14 20:00:59.778: %RF-5-RF_TERMINAL_STATE: Terminal state reached for (SSO)
Router# issu runversion
--- Starting local lock acquisition on R0 ---
Finished local lock acquisition on R0
--- Starting installation state synchronization ---
Finished installation state synchronization
--- Starting local lock acquisition on R1 ---
Finished local lock acquisition on R1
--- Starting switchover readiness checking ---
Finished switchover readiness checking
SUCCESS: Standby RP will now become active
Initiating active RP failover
Mar 14 20:02:19.797 R0/0: %PMAN-5-EXITACTION: Process manager is exiting: reload fru action
requested
Initializing Hardware ...
Calculating the ROMMON CRC ... CRC is correct
System Bootstrap, Version 15.2(1r)S, RELEASE SOFTWARE
Copyright (c) 1994-2011 by Cisco Systems, Inc.
Current image running: Boot ROM0
Last reset cause: LocalSoft
[Output removed for brevity]
Press RETURN to get started!
*Mar 14 20:08:51.197: %REDUNDANCY-3-PEER_MONITOR: PEER_FOUND event on standby
*Mar 14 20:09:53.509: %SYS-5-RESTART: System restarted --
Cisco IOS Software, IOS-XE Software (X86_64_LINUX_IOSD-ADVENTERPRISEK9-M), Version 15.3(1)S,
RELEASE SOFTWARE (fc4)
Technical Support: http://www.cisco.com/techsupport
Copyright (c) 1986-2012 by Cisco Systems, Inc.
Compiled Tue 27-Nov-12 11:13 by mcpre

```



```
*Mar 14 20:10:00.174: %PLATFORM-6-RF_PROG_SUCCESS: RF state STANDBY HOT
Router-stby>
```

At this point of the procedure, use your UNIX client to log in to the other RP:

```
[unix-server-1 ~]$ telnet 198.51.100.157 2013
User Access Verification
Username: user
Password: *****
Router>
*Mar 14 20:02:15.767: %LINK-3-UPDOWN: Interface Lsmpi0, changed state to up
*Mar 14 20:02:15.768: %LINK-3-UPDOWN: Interface EOBC0, changed state to up
*Mar 14 20:02:15.768: %LINK-3-UPDOWN: Interface LIIN0, changed state to up
*Mar 14 20:02:16.768: %LINEPROTO-5-UPDOWN: Line protocol on Interface Lsmpi0, changed state
to up
*Mar 14 20:02:16.768: %LINEPROTO-5-UPDOWN: Line protocol on Interface EOBC0, changed state
to up
*Mar 14 20:02:16.768: %LINEPROTO-5-UPDOWN: Line protocol on Interface GigabitEthernet0,
changed state to down
*Mar 14 20:02:16.768: %LINEPROTO-5-UPDOWN: Line protocol on Interface LIIN0, changed state
to up
*Mar 14 20:02:17.498: %CRYPTO-6-ISAKMP_ON_OFF: ISAKMP is OFF
*Mar 14 20:02:17.498: %CRYPTO-6-GDOI_ON_OFF: GDOI is OFF
*Mar 14 20:02:17.756: %LINK-3-UPDOWN: Interface Null0, changed state to up
*Mar 14 20:02:17.757: %LINK-3-UPDOWN: Interface GigabitEthernet0/0/0, changed state to up
*Mar 14 20:02:17.757: %LINEPROTO-5-UPDOWN: Line protocol on Interface Loopback0, changed
state to up
*Mar 14 20:02:17.757: %LINK-3-UPDOWN: Interface Loopback0, changed state to up
*Mar 14 20:02:17.765: %LINK-5-CHANGED: Interface GigabitEthernet0/0/1, changed state to
administratively down
*Mar 14 20:02:17.765: %LINK-5-CHANGED: Interface GigabitEthernet0/0/2, changed state to
administratively down
*Mar 14 20:02:17.765: %LINK-5-CHANGED: Interface GigabitEthernet0/0/3, changed state to
administratively down
*Mar 14 20:02:17.765: %LINK-5-CHANGED: Interface GigabitEthernet0/0/4, changed state to
administratively down
*Mar 14 20:02:17.765: %LINK-5-CHANGED: Interface GigabitEthernet0/0/5, changed state to
administratively down
*Mar 14 20:02:17.765: %LINK-5-CHANGED: Interface GigabitEthernet0/0/6, changed state to
administratively down
*Mar 14 20:02:17.765: %LINK-5-CHANGED: Interface GigabitEthernet0/0/7, changed state to
administratively down
*Mar 14 20:02:17.765: %LINK-5-CHANGED: Interface GigabitEthernet0/1/0, changed state to
administratively down
*Mar 14 20:02:17.765: %LINK-5-CHANGED: Interface GigabitEthernet0/1/1, changed state to
administratively down
*Mar 14 20:02:18.756: %LINEPROTO-5-UPDOWN: Line protocol on Interface Null0, changed state
to up
*Mar 14 20:02:18.757: %LINEPROTO-5-UPDOWN: Line protocol on Interface GigabitEthernet0/0/0,
changed state to up
*Mar 14 20:04:05.534: %CPPHA-7-START: F1: cpp_ha: CPP 0 preparing image
/tmp/sw/fp/1/0/fpx86/mount/usr/cpp/bin/qfp-ucode-esp40
*Mar 14 20:04:05.863: %CPPHA-7-START: F1: cpp_ha: CPP 0 startup init image
/tmp/sw/fp/1/0/fpx86/mount/usr/cpp/bin/qfp-ucode-esp40
*Mar 14 20:04:07.781: %IOSXE_OIR-6-ONLINECARD: Card (fp) online in slot F1
*Mar 14 20:04:11.123: %CPPHA-7-START: F1: cpp_ha: CPP 0 running init image
/tmp/sw/fp/1/0/fpx86/mount/usr/cpp/bin/qfp-ucode-esp40
*Mar 14 20:04:11.342: %CPPHA-7-READY: F1: cpp_ha: CPP 0 loading and initialization complete
*Mar 14 20:04:11.472: %IOSXE-6-PLATFORM: F1: cpp_cp: Process
CPP_FILTER_EA_EVENT_API_CALL_REGISTER
*Mar 14 20:04:19.443: %PLATFORM-5-RESETCARD: R1/0: card_reset: ESP0 reset to acquire
provisioned software
*Mar 14 20:04:19.458: %IOSXE_OIR-6-OFFLINECARD: Card (fp) offline in slot F0
*Mar 14 20:04:21.546: %MDR-5-CARD_RESTART: R1/0: card_mdr: Minimal Disruptive Restart SIP0
```

## Examples

```

to acquire provisioned software
*Mar 14 20:04:29.266: %CMCC-5-SPA_MDR_INIT: SIP0: cmcc: SPA0 initiated Minimal Disruptive
Restart
*Mar 14 20:04:29.269: %CMCC-5-SPA_MDR_INIT: SIP0: cmcc: SPA1 initiated Minimal Disruptive
Restart
*Mar 14 20:04:29.270: %CMCC-5-SPA_MDR_INIT: SIP0: cmcc: SPA2 initiated Minimal Disruptive
Restart
*Mar 14 20:05:17.807: %IOSXE_OIR-6-ONLINECARD: Card (cc) online in slot 0
*Mar 14 20:05:21.287: %IOSXE_OIR-6-INSSPA: SPA inserted in subslot 0/0
*Mar 14 20:05:21.630: %IOSXE_OIR-6-INSSPA: SPA inserted in subslot 0/1
*Mar 14 20:05:21.896: %IOSXE_OIR-6-INSSPA: SPA inserted in subslot 0/2
*Mar 14 20:05:29.364: %LINK-3-UPDOWN: SIP0/0: Interface EOBC0/1, changed state to up
*Mar 14 20:05:34.058: %SPA_OIR-6-ONLINECARD: SPA (SPA-8X1GE-V2) online in subslot 0/0
*Mar 14 20:05:33.064: %CMCC-5-SPA_MDR_DONE: SIP0: cmcc: SPA0 completed Minimal Disruptive
Restart
*Mar 14 20:05:34.093: %LINK-3-UPDOWN: SIP0/1: Interface EOBC0/1, changed state to up
*Mar 14 20:05:35.125: %SPA_OIR-6-ONLINECARD: SPA (SPA-8X1GE-V2) online in subslot 0/1
*Mar 14 20:05:34.130: %CMCC-5-SPA_MDR_DONE: SIP0: cmcc: SPA1 completed Minimal Disruptive
Restart
*Mar 14 20:05:34.099: %TRANSCEIVER-6-INSERTED: SIP0/1: transceiver module inserted in
GigabitEthernet0/1/0
*Mar 14 20:05:35.046: %LINK-3-UPDOWN: SIP0/0: Interface GigabitEthernet0/0/0, changed state
to up
*Mar 14 20:05:37.996: %LINK-3-UPDOWN: SIP0/2: Interface EOBC0/1, changed state to up
*Mar 14 20:05:43.230: %SPA_OIR-6-ONLINECARD: SPA (SPA-8X1GE-V2) online in subslot 0/2
*Mar 14 20:05:42.239: %CMCC-5-SPA_MDR_DONE: SIP0: cmcc: SPA2 completed Minimal Disruptive
Restart
*Mar 14 20:06:10.368: %CPPHA-7-START: F0: cpp_ha: CPP 0 preparing image
/tmp/sw/fp/0/0/fpx86/mount/usr/cpp/bin/qfp-ucode-esp40
*Mar 14 20:06:10.697: %CPPHA-7-START: F0: cpp_ha: CPP 0 startup init image
/tmp/sw/fp/0/0/fpx86/mount/usr/cpp/bin/qfp-ucode-esp40
*Mar 14 20:06:12.158: %IOSXE_OIR-6-ONLINECARD: Card (fp) online in slot F0
*Mar 14 20:06:15.940: %CPPHA-7-START: F0: cpp_ha: CPP 0 running init image
/tmp/sw/fp/0/0/fpx86/mount/usr/cpp/bin/qfp-ucode-esp40
*Mar 14 20:06:16.158: %CPPHA-7-READY: F0: cpp_ha: CPP 0 loading and initialization complete
*Mar 14 20:06:16.290: %IOSXE-6-PLATFORM: F0: cpp_cp: Process
CPP_FILTER_EA_EVENT_API_CALL_REGISTER
*Mar 14 20:08:41.564: %IOSXE_OIR-6-ONLINECARD: Card (rp) online in slot R0
*Mar 14 20:08:51.188: %REDUNDANCY-5-PEER_MONITOR_EVENT: Active detected a standby insertion
(raw-event=PEER_FOUND(4))
*Mar 14 20:08:51.188: %REDUNDANCY-5-PEER_MONITOR_EVENT: Active detected a standby insertion
(raw-event=PEER_REDUNDANCY_STATE_CHANGE(5))
*Mar 14 20:08:54.115: %REDUNDANCY-3-IPC: IOS versions do not match.
*Mar 14 20:10:00.611: %NBAR_HA-5-NBAR_INFO: NBAR sync DONE!
*Mar 14 20:10:01.026: %HA_CONFIG_SYNC-6-BULK_CFGSYNC_SUCCEED: Bulk Sync succeeded
*Mar 14 20:10:02.027: %RF-5-RF_TERMINAL_STATE: Terminal state reached for (SSO)
Router>enable

```

```

Router# issu acceptversion
--- Starting local lock acquisition on R1 ---
Finished local lock acquisition on R1
Cancelling rollback timer
SUCCESS: Rollback timer cancelled
Router# issu commitversion
--- Starting local lock acquisition on R1 ---
Finished local lock acquisition on R1
--- Starting commit readiness checking ---
Finished commit readiness checking
--- Starting installation changes ---
Cancelling rollback timer
Saving image changes
Finished installation changes

```

Building configuration...

[OK]

SUCCESS: version committed: bootflash:asr1000rp2-adventerprisek9.03.12.01.S.154-2.S1.bin

After you confirm the software versions and configuration, reload the RP as shown in the following example:

```
Router# hw-module slot R0 reload
 Proceed with reload of module? [confirm]
*Mar 14 20:31:05.511: %IOSXE_OIR-6-OFFLINECARD: Card (rp) offline in slot R0
*Mar 14 20:31:05.587: %REDUNDANCY-3-STANDBY_LOST: Standby processor fault (PEER_NOT_PRESENT)
*Mar 14 20:31:05.588: %REDUNDANCY-3-STANDBY_LOST: Standby processor fault (PEER_DOWN)
*Mar 14 20:31:05.588: %REDUNDANCY-3-STANDBY_LOST: Standby processor fault
(Peer_Redundancy_State_Change)
*Mar 14 20:31:07.622: %RF-5-RF_RELOAD: Peer reload. Reason: EHSa standby down
*Mar 14 20:31:07.632: % Redundancy mode change to SSO
*Mar 14 20:34:29.337: %IOSXE_OIR-6-ONLINECARD: Card (rp) online in slot R0
*Mar 14 20:34:38.988: %REDUNDANCY-5-PEER_MONITOR_EVENT: Active detected a standby insertion
(raw-event=PEER_FOUND(4))
*Mar 14 20:34:38.988: %REDUNDANCY-5-PEER_MONITOR_EVENT: Active detected a standby insertion
(raw-event=PEER_REDUNDANCY_STATE_CHANGE(5))
*Mar 14 20:35:47.610: %NBAR_HA-5-NBAR_INFO: NBAR sync DONE!
*Mar 14 20:35:48.023: %HA_CONFIG_SYNC-6-BULK_CFGSYNC_SUCCEEDED: Bulk Sync succeeded
*Mar 14 20:35:49.025: %RF-5-RF_TERMINAL_STATE: Terminal state reached for (SSO)
```

## Using ISSU to Upgrade the Subpackages on a Cisco ASR 1006 Router and Cisco ASR 1013 Router (issu Command Set) with MDR

### SUMMARY STEPS

1. **show version**
2. **copy running-config startup-config**
3. **mkdir *URL-to-directory-name***
4. **ip tftp source-interface gigabitethernet *port***
5. **copy tftp: *URL-to-target-location***
6. **request platform software package expand file *URL-to-consolidated-package***
7. **dir *target-URL***
8. **copy file-system:asr1000rp2-esppbase.*version*.pkg *URL-to-directory-of-sub-packages-active-RP***
9. **copy file-system:asr1000rp2-esppbase.*version*.pkg *URL-to-directory-of-sub-packages-standby-RP***
10. **product="kwname="issu checkversion rp *standby-RP* product="name="> file *standby-file-system:asr1000rp\*version\*.pkg mdr {force}***
11. **issu loadversion rp *standby-RP* file *target-standbyRP-URL-for-sub-packages:asr1000rp\*version\*.pkg* product="name=">force**
12. **hw-module slot *standby-RP* reload**
13. **issu loadversion rp *active-RP* file *URL-to-active-file-system:asr1000rp2-{sipbase,sipspa}\*version\*.pkg* slot*SIP-slot-number* product="name=">mdr {force}**
14. **issu loadversion rp *active-RP* file *URL-to-active-file-system:asr1000rp2-{elcbase,elcspa}\*version\*.pkg* slot*ELC-slot-number* mdr product="name=">{force}**

15. **issu loadversion rp** *active-RP* **file** *URL-to-active-file-system:asr1000rp2-esp\*version\*.pkg slot standby-ESP-slot*
16. **issu loadversion rp** *active-RP* **file** *URL-to-active-file-system:asr1000rp\*version\*.pkg force*
17. **show version** *active-RP* **provisioned**
18. **redundancy force-switchover**
19. **request platform software package clean**

## DETAILED STEPS

|        | Command or Action                                                                                                                                                                                                                                                                                                                                                                                                                                                                                                                                                                                      | Purpose                                                                                                                                                                                                                                                                                                                                                                                                                                                                                                                                                                                                                                                                               |
|--------|--------------------------------------------------------------------------------------------------------------------------------------------------------------------------------------------------------------------------------------------------------------------------------------------------------------------------------------------------------------------------------------------------------------------------------------------------------------------------------------------------------------------------------------------------------------------------------------------------------|---------------------------------------------------------------------------------------------------------------------------------------------------------------------------------------------------------------------------------------------------------------------------------------------------------------------------------------------------------------------------------------------------------------------------------------------------------------------------------------------------------------------------------------------------------------------------------------------------------------------------------------------------------------------------------------|
| Step 1 | <p><b>show version</b></p> <p><b>Example:</b></p> <pre>show version active-rp installed</pre> <p><b>Example:</b></p> <pre>dir filesystem: directory</pre> <p><b>Example:</b></p> <pre>show platform</pre> <p><b>Example:</b></p> <pre>show redundancy states</pre> <p><b>Example:</b></p> <p><b>Example:</b></p> <pre>Router# show version</pre> <p><b>Example:</b></p> <pre>Router# show version r0 installed</pre> <p><b>Example:</b></p> <pre>Router# dir bootflash:</pre> <p><b>Example:</b></p> <pre>Router# show platform</pre> <p><b>Example:</b></p> <pre>Router# show redundancy states</pre> | <p>(Optional) Use the following commands to confirm the current router configuration, as follows:</p> <ul style="list-style-type: none"> <li>• <b>show version</b> and <b>show version active-rp installed</b>—Verify the running version of the Cisco IOS XE software on the router, and which file was used to boot the router, and where that file is stored.</li> <li>• <b>dir</b>—Confirm that the files that were used to boot the router are located in the directory.</li> <li>• <b>show platform</b>—Confirm the current status of the active and standby RPs.</li> <li>• <b>show redundancy states</b>—Confirm the operational and configured redundancy states.</li> </ul> |
| Step 2 | <p><b>copy running-config startup-config</b></p> <p><b>Example:</b></p> <p><b>Example:</b></p>                                                                                                                                                                                                                                                                                                                                                                                                                                                                                                         | <p>After you have confirmed that the system states are acceptable, save the current configuration to the startup configuration.</p>                                                                                                                                                                                                                                                                                                                                                                                                                                                                                                                                                   |

|               | Command or Action                                                                                                                                                                                                                                                          | Purpose                                                                                                                                                                                                                                                                                                                                                                                                                                                                                                                                                       |
|---------------|----------------------------------------------------------------------------------------------------------------------------------------------------------------------------------------------------------------------------------------------------------------------------|---------------------------------------------------------------------------------------------------------------------------------------------------------------------------------------------------------------------------------------------------------------------------------------------------------------------------------------------------------------------------------------------------------------------------------------------------------------------------------------------------------------------------------------------------------------|
|               | Router# <b>copy running-config startup-config</b>                                                                                                                                                                                                                          |                                                                                                                                                                                                                                                                                                                                                                                                                                                                                                                                                               |
| <b>Step 3</b> | <p><b>mkdir</b> <i>URL-to-directory-name</i></p> <p><b>Example:</b></p> <p><b>Example:</b></p> <pre>Router# mkdir bootflash:tmp</pre> <p><b>Example:</b></p>                                                                                                               | <p>Create a directory to store the consolidated package and subpackages.</p> <p>This directory must be created in most cases because the consolidated packages and subpackages have to be separated from the subpackages that booted the router at this step of the procedure.</p>                                                                                                                                                                                                                                                                            |
| <b>Step 4</b> | <p><b>ip tftp source-interface</b> <i>gigabitethernet port</i></p> <p><b>Example:</b></p> <pre>Router(config)# ip tftp source-interface gigabitethernet 0</pre>                                                                                                            | <p>Specifies the Gigabit Ethernet TFTP source-interface to be configured:</p> <p>slot/port—Specifies the location of the TFTP source-interface.</p> <p><b>Note</b> To copy a file using TFTP through the Management Ethernet interface, the <b>ip tftp source-interface GigabitEthernet 0</b> command must be entered before entering the <b>copy tftp</b> command.</p>                                                                                                                                                                                       |
| <b>Step 5</b> | <p><b>copy tftp:</b> <i>URL-to-target-location</i></p> <p><b>Example:</b></p> <p><b>Example:</b></p> <pre>Router# copy tftp: bootflash:tmp</pre>                                                                                                                           | <p>Copy the consolidated package file into the directory created in <a href="#">Step 3</a>.</p> <p>The consolidated package in this step should not be copied into the same directory where the subpackages that are currently running your router are stored (the directory containing the packages.conf provisioning file from which the router was booted).</p> <p><b>Note</b> type="tip"</p> <p>It is recommended that you copy the package onto a usb: or harddisk: file system for space considerations when performing this step of the procedure.</p> |
| <b>Step 6</b> | <p><b>request platform software package expand file</b> <i>URL-to-consolidated-package</i></p> <p><b>Example:</b></p> <p><b>Example:</b></p> <pre>Router# request platform software package expand file bootflash:tmp/as1000p2-enterprise.9.03.13.00.S.154-3-Set.bin</pre> | <p>Extract the subpackages out of the consolidated package file into the temporary directory.</p> <p><b>Note</b> Take extra care to extract the subpackages to a temporary subdirectory and do not delete any of the files currently running the router at this point of the procedure. To erase the files that were running on the router before the ISSU upgrade, enter the <b>request platform software package clean</b> command after the ISSU upgrade has been completed.</p>                                                                           |

|               | Command or Action                                                                                                                                                                                                                                                                                                                                                                                                                                                                                                                                                                                                                                                                                                                                                                                                                                                                                                                                                                                                                                                                                                                                                      | Purpose                                                                                                                                                |
|---------------|------------------------------------------------------------------------------------------------------------------------------------------------------------------------------------------------------------------------------------------------------------------------------------------------------------------------------------------------------------------------------------------------------------------------------------------------------------------------------------------------------------------------------------------------------------------------------------------------------------------------------------------------------------------------------------------------------------------------------------------------------------------------------------------------------------------------------------------------------------------------------------------------------------------------------------------------------------------------------------------------------------------------------------------------------------------------------------------------------------------------------------------------------------------------|--------------------------------------------------------------------------------------------------------------------------------------------------------|
|               | <b>Example:</b>                                                                                                                                                                                                                                                                                                                                                                                                                                                                                                                                                                                                                                                                                                                                                                                                                                                                                                                                                                                                                                                                                                                                                        |                                                                                                                                                        |
| <b>Step 7</b> | <p><b>dir</b> <i>target-URL</i></p> <p><b>Example:</b></p> <p><b>Example:</b></p> <pre>Router# dir bootflash:tmp</pre>                                                                                                                                                                                                                                                                                                                                                                                                                                                                                                                                                                                                                                                                                                                                                                                                                                                                                                                                                                                                                                                 | (Optional) Display the directory to confirm that the files were extracted.                                                                             |
| <b>Step 8</b> | <p><b>copy</b> <i>file-system:asr1000rp2-espbase.version.pkg</i><br/><i>URL-to-directory-of-sub-packages-active-RP</i></p> <p><b>Example:</b></p> <pre>copy file-system:asr1000rp2-espx86base.version.pkg URL-to-directory-of-sub-packages-active-RP</pre> <p><b>Example:</b></p> <pre>copy file-system:asr1000rp2-rpaccess.version.pkg URL-to-directory-of-sub-packages-active-RP</pre> <p><b>Example:</b></p> <pre>copy file-system:asr1000rp2-rpbase.version.pkg URL-to-directory-of-sub-packages-active-RP</pre> <p><b>Example:</b></p> <pre>copy file-system:asr1000rp2-rpcontrol.version.pkg URL-to-directory-of-sub-packages-active-RP</pre> <p><b>Example:</b></p> <pre>copy file-system:asr1000rp2-rpios.version.pkg URL-to-directory-of-sub-packages-active-RP</pre> <p><b>Example:</b></p> <pre>copy file-system:asr1000rp2-sipbase.version.pkg URL-to-directory-of-sub-packages-active-RP</pre> <p><b>Example:</b></p> <pre>copy file-system:asr1000rp2-sipspace.version.pkg URL-to-directory-of-sub-packages-active-RP</pre> <p><b>Example:</b></p> <pre>copy file-system:asr1000rp2-elcbase.version.pkg URL-to-directory-of-sub-packages-active-RP</pre> | Copy the subpackages out of the temporary directory into the directory on the router where the subpackages running the active RP are currently stored. |

|  | Command or Action                                                                                                                                                                                                                                                                                                                                                                                                                                                                                                                                                                                                                                                                                                                                                                                                                                                                                       | Purpose |
|--|---------------------------------------------------------------------------------------------------------------------------------------------------------------------------------------------------------------------------------------------------------------------------------------------------------------------------------------------------------------------------------------------------------------------------------------------------------------------------------------------------------------------------------------------------------------------------------------------------------------------------------------------------------------------------------------------------------------------------------------------------------------------------------------------------------------------------------------------------------------------------------------------------------|---------|
|  | <p><b>Example:</b></p> <pre>copy file-system: asr1000rp2-elcspa.version.pkg URL-to-directory-of-sub-packages-active-RP</pre> <p><b>Example:</b></p> <pre>Router# copy bootflash: ttp/asr1000rp2-espbase.03.13.00.S.154-3.S-ext.pkg bootflash:</pre> <p><b>Example:</b></p> <pre>Router# copy bootflash: ttp/asr1000rp2-espbase.03.13.00.S.154-3.S-ext.pkg bootflash:</pre> <p><b>Example:</b></p> <pre>Router# copy bootflash: ttp/asr1000rp2-rpaccess.03.13.00.S.154-3.S-ext.pkg bootflash:</pre> <p><b>Example:</b></p> <pre>Router# copy bootflash: ttp/asr1000rp2-rpbase.03.13.00.S.154-3.S-ext.pkg bootflash:</pre> <p><b>Example:</b></p> <pre>Router# copy bootflash: ttp/asr1000rp2-rpcontrol.03.13.00.S.154-3.S-ext.pkg bootflash:</pre> <p><b>Example:</b></p> <pre>Router# copy bootflash: ttp/asr1000rp2-rpic-enterprise.03.13.00.S.154-3.S-ext.pkg bootflash:</pre> <p><b>Example:</b></p> |         |

|        | Command or Action                                                                                                                                                                                                                                                                                                                                                                                                                                                                                                                | Purpose                                                                                                                                                 |
|--------|----------------------------------------------------------------------------------------------------------------------------------------------------------------------------------------------------------------------------------------------------------------------------------------------------------------------------------------------------------------------------------------------------------------------------------------------------------------------------------------------------------------------------------|---------------------------------------------------------------------------------------------------------------------------------------------------------|
|        | <p><b>Example:</b></p> <pre>Router# copy bootflash:tmp/asr1000rp2-sipbase.03.13.00.S.154-3.S-ext.pkg bootflash:</pre> <p><b>Example:</b></p> <p><b>Example:</b></p> <pre>Router# copy bootflash:tmp/asr1000rp2-sipspa.03.13.00.S.154-3.S-ext.pkg bootflash:</pre> <p><b>Example:</b></p> <pre>Router# copy bootflash:tmp/asr1000rp2-elcbase.03.13.00.S.154-3.S-ext.pkg bootflash:</pre> <p><b>Example:</b></p> <pre>Router# copy bootflash:tmp/asr1000rp2-elcspa.03.13.00.S.154-3.S-ext.pkg bootflash:</pre>                     |                                                                                                                                                         |
| Step 9 | <p><b>copy file-system:asr1000rp2-espbase.version.pkg<br/>URL-to-directory-of-sub-packages-standby-RP</b></p> <p><b>Example:</b></p> <pre>copy file-system:asr1000rp2-esp86base.version.pkg URL-to-directory-of-sub-packages-standby-RP</pre> <p><b>Example:</b></p> <pre>copy file-system:asr1000rp2-rpaccess.version.pkg URL-to-directory-of-sub-packages-standby-RP</pre> <p><b>Example:</b></p> <pre>copy file-system:asr1000rp2-rpbase.version.pkg URL-to-directory-of-sub-packages-standby-RP</pre> <p><b>Example:</b></p> | Copy the subpackages out of the temporary directory into the directory on the router where the subpackages running the standby RP are currently stored. |



|  | Command or Action                                                                                                                                                                                                                                                                                                                                                                                                                                                                                                                                                                                                                                                                                                                                                                                                                                                                                                                                                                                                                                                                                                                                                                                                                                                                                                                    | Purpose |
|--|--------------------------------------------------------------------------------------------------------------------------------------------------------------------------------------------------------------------------------------------------------------------------------------------------------------------------------------------------------------------------------------------------------------------------------------------------------------------------------------------------------------------------------------------------------------------------------------------------------------------------------------------------------------------------------------------------------------------------------------------------------------------------------------------------------------------------------------------------------------------------------------------------------------------------------------------------------------------------------------------------------------------------------------------------------------------------------------------------------------------------------------------------------------------------------------------------------------------------------------------------------------------------------------------------------------------------------------|---------|
|  | <p><b>copy</b><br/> <i>file-system: asr1000rp2-rpcontrol.version.pkg</i><br/> <i>URL-to-directory-of-sub-packages-standby-RP</i></p> <p><b>Example:</b></p> <p><b>copy</b><br/> <i>file-system: asr1000rp2-rpios.version.pkg</i><br/> <i>URL-to-directory-of-sub-packages-standby-RP</i></p> <p><b>Example:</b></p> <p><b>copy</b><br/> <i>file-system: asr1000rp2-sipbase.version.pkg</i><br/> <i>URL-to-directory-of-sub-packages-standby-RP</i></p> <p><b>Example:</b></p> <p><b>copy</b><br/> <i>file-system: asr1000rp2-sipspa.version.pkg</i><br/> <i>URL-to-directory-of-sub-packages-standby-RP</i></p> <p><b>Example:</b></p> <p><b>copy</b><br/> <i>file-system: asr1000rp2-elcbase.version.pkg</i><br/> <i>URL-to-directory-of-sub-packages-standby-RP</i></p> <p><b>Example:</b></p> <p><b>copy</b><br/> <i>file-system: asr1000rp2-elcspa.version.pkg</i><br/> <i>URL-to-directory-of-sub-packages-standby-RP</i></p> <p><b>Example:</b></p> <p><b>Examples:</b></p> <p><b>Example:</b></p> <pre>Router# copy bootflash:tmp/asr1000rp2-elcbase.03.13.00.S.154-3.S-ext.pkg stby-bootflash:</pre> <p><b>Example:</b></p> <p><b>Example:</b></p> <pre>Router# copy bootflash:tmp/asr1000rp2-elcbase.03.13.00.S.154-3.S-ext.pkg stby-bootflash:</pre> <p><b>Example:</b></p> <p><b>Example:</b></p> <pre>Router# copy</pre> |         |

| Command or Action                                                                                                                                                                                                                                                                                                                                                                                                                                                                                                                                                                                                                                                                               | Purpose |
|-------------------------------------------------------------------------------------------------------------------------------------------------------------------------------------------------------------------------------------------------------------------------------------------------------------------------------------------------------------------------------------------------------------------------------------------------------------------------------------------------------------------------------------------------------------------------------------------------------------------------------------------------------------------------------------------------|---------|
| <pre> bootflash:tmp/asr1000r2-rpaccess.03.13.00.S.154-3.S-ext.pkg stby-bootflash:  Example:  Example:  Router# copy bootflash:tmp/asr1000r2-rpbase.03.13.00.S.154-3.S-ext.pkg stby-bootflash:  Example:  Example:  Router# copy bootflash:tmp/asr1000r2-rpcontrol.03.13.00.S.154-3.S-ext.pkg stby-bootflash:  Example:  Example:  Router# copy bootflash:tmp/asr1000r2-rpicadentepic.03.13.00.S.154-3.S-ext.pkg stby-bootflash:  Example:  Example:  Router# copy bootflash:tmp/asr1000r2-rpspa.03.13.00.S.154-3.S-ext.pkg stby-bootflash:  Example:  Example:  Router# ccopy bootflash:tmp/asr1000r2-rpspa.03.13.00.S.154-3.S-ext.pkg stby-bootflash:  Example:  Example:  Router# copy </pre> |         |

|         | Command or Action                                                                                                                                                                                                                                                       | Purpose                                                                                                                                                   |
|---------|-------------------------------------------------------------------------------------------------------------------------------------------------------------------------------------------------------------------------------------------------------------------------|-----------------------------------------------------------------------------------------------------------------------------------------------------------|
|         | <pre>bootflash:tmp/asr1000rp2-elcspa.03.13.00.S.154-3.S-ext.pkg stby-bootflash:  Example:  Example:  Router# ccopy bootflash:tmp/asr1000rp2-elcspa.03.13.00.S.154-3.S-ext.pkg stby-bootflash:</pre>                                                                     |                                                                                                                                                           |
| Step 10 | <pre>product="kwname="issu checkversion rp standby-RP product="name="&gt; file standby-file-system:asr1000rp*version*.pkg mdr {force}  Example:  Example:  Example:  Router#issu checkversion rp 1 file stby-bootflash:asr1000rp2-*03.13.00.S.154-3.S-ext*pkg mdr</pre> | Checks the ISSU MDR software packaging compatibility on the standby Route Processor (RP).                                                                 |
| Step 11 | <pre>issu loadversion rp standby-RP file target-standbyRP-URL-for-sub-packages:asr1000rp*version*.pkg product="name="&gt;force  Example:  Example:  Router# issu loadversion rp 1 file stby-bootflash:asr1000rp2-*03.13.00.S.154-3.S-ext*pkg force</pre>                | Upgrade the RP subpackages on the standby RP, where the “rp*” wildcard is specified to capture all of the RP subpackages for the desired upgrade release. |
| Step 12 | <pre>hw-module slot standby-RP reload  Example:  Example:  Router# hw-module slot R1 reload</pre>                                                                                                                                                                       | Reload the standby RP.                                                                                                                                    |
| Step 13 | <pre>issu loadversion rp active-RP file URL-to-active-file-system:asr1000rp2-{sibase,sipsa}*version*.pkg slotSIP-slot-number product="name="&gt;mdr {force}</pre>                                                                                                       | Upgrade the SIP and SPA subpackages for each SIP on the router using MDR.                                                                                 |

|                | Command or Action                                                                                                                                                                                                                                                                                                                                                                                                                                                                                                       | Purpose                                                                                                                                                                                                                                                                                                                                                                                                                                                                                                                                                                                                                                                                                                                                                        |
|----------------|-------------------------------------------------------------------------------------------------------------------------------------------------------------------------------------------------------------------------------------------------------------------------------------------------------------------------------------------------------------------------------------------------------------------------------------------------------------------------------------------------------------------------|----------------------------------------------------------------------------------------------------------------------------------------------------------------------------------------------------------------------------------------------------------------------------------------------------------------------------------------------------------------------------------------------------------------------------------------------------------------------------------------------------------------------------------------------------------------------------------------------------------------------------------------------------------------------------------------------------------------------------------------------------------------|
|                | <p><b>Example:</b></p> <pre>issu commitversion</pre> <p><b>Example:</b></p> <p><b>Example:</b></p> <p><b>Example:</b></p> <p><b>Example:</b></p> <pre>Router# issu loadversion rp 0 file bootflash:asr1000rp2-{sipbase,sipspa}*03.13.00*pkg mdr</pre> <p><b>Example:</b></p> <pre>Router# issu commitversion</pre>                                                                                                                                                                                                      | <p><b>Note</b> This step must be completed one SIP at a time, and repeated for each SIP installed on the router before performing the next step.</p> <p><b>Note</b> type="tip"</p> <p>You can use the <b>show ip interface brief</b> command to identify which slots contain SIPs and SPAs. The interfaces with three numbers (in the form <i>SIP-number/SPA-number/interface-number</i>) identify the SIP and SPA locations in the router.</p> <p><b>Note</b> The <i>pattern</i> options used in this CLI (<b>sipbase</b> and <b>sipspa</b>) were introduced in Cisco IOS XE Release 2.1.2 and are not available in previous Cisco IOS XE Releases.</p>                                                                                                       |
| <b>Step 14</b> | <p><b>issu loadversion rp active-RP file</b><br/> <i>URL-to-active-file-system:asr1000rp2-{elcbase,elcspa}*version*.pkg</i><br/> <b>slot</b> <i>ELC-slot-number</i> mdr <b>product="name="&gt;{force}</b></p> <p><b>Example:</b></p> <pre>issu commitversion</pre> <p><b>Example:</b></p> <p><b>Example:</b></p> <p><b>Example:</b></p> <pre>Router# issu loadversion rp 0 file bootflash:asr1000rp2-{elcbase,elcspa}*03.13.00.S.154-3.S-ext.pkg mdr</pre> <p><b>Example:</b></p> <pre>Router# issu commitversion</pre> | <p>Upgrade the Ethernet Line Card (ELC) and SPA subpackages for each ELC on the router using MDR.</p> <p><b>Note</b> This step must be completed one ELC at a time, and repeated for each ELC installed on the router before performing the next step.</p> <p><b>Note</b> type="tip"</p> <p>You can use the <b>show ip interface brief</b> command to identify which slots contain ELCs and SPAs. The interfaces with three numbers (in the form <i>ELC-number/SPA-number/interface-number</i>) identify the ELC and SPA locations in the router.</p> <p><b>Note</b> The <i>pattern</i> options used in this CLI (<b>elcbase</b> and <b>elcspa</b>) were introduced in Cisco IOS XE Release 3.10S and are not available in previous Cisco IOS XE Releases.</p> |
| <b>Step 15</b> | <p><b>issu loadversion rp active-RP file</b><br/> <i>URL-to-active-file-system:asr1000rp2-esp*version*.pkg</i><br/> <b>slot</b> <i>standby-ESP-slot</i></p> <p><b>Example:</b></p> <pre>issu commitversion</pre> <p><b>Example:</b></p>                                                                                                                                                                                                                                                                                 | <p>Upgrade the ESP Base subpackage on the standby and the active ESPs.</p> <p>After entering the <b>issu loadversion rp</b> command on the active RP, the ESP switchover will occur automatically. Minimal traffic interruption will occur as a result of this switchover.</p>                                                                                                                                                                                                                                                                                                                                                                                                                                                                                 |

|                | Command or Action                                                                                                                                                                                                                                                                                                                                                                                                                                                                                                                                                                                                    | Purpose                                                                                                                                                                                                                                                                  |
|----------------|----------------------------------------------------------------------------------------------------------------------------------------------------------------------------------------------------------------------------------------------------------------------------------------------------------------------------------------------------------------------------------------------------------------------------------------------------------------------------------------------------------------------------------------------------------------------------------------------------------------------|--------------------------------------------------------------------------------------------------------------------------------------------------------------------------------------------------------------------------------------------------------------------------|
|                | <pre> <b>issu loadversion rp</b> <i>active-RP</i> <b>file</b> <i>URL-to-active-file-system:asr1000rp2-esp*version*.pkg</i> <b>slot</b> <i>active-ESP-slot</i>  <b>Example:</b> <b>issu commitversion</b>  <b>Example:</b>  <b>Example:</b>  Router# <b>issu loadversion rp 0 file</b> <b>bootflash:asr1000rp2-esp*03.13.00.S.154-3.S-ext*.pkg</b> <b>slot 1</b>  <b>Example:</b>  Router# <b>issu commitversion</b>  <b>Example:</b>  Router# <b>issu loadversion rp 0 file</b> <b>bootflash:asr1000rp2-esp*03.13.00.S.154-3.S-ext*.pkg</b> <b>slot 0</b>  <b>Example:</b>  Router# <b>issu commitversion</b> </pre> |                                                                                                                                                                                                                                                                          |
| <b>Step 16</b> | <pre> <b>issu loadversion rp</b> <i>active-RP</i> <b>file</b> <i>URL-to-active-file-system:asr1000rp*version*.pkg force</i>  <b>Example:</b>  <b>Example:</b>  Router# <b>issu loadversion rp 0 file</b> <b>bootflash:asr1000rp2*03.13.00.S.154-3.S-ext*.pkg</b> <b>force</b> </pre>                                                                                                                                                                                                                                                                                                                                 | <p>Upgrade all of the subpackages on the active RP.</p> <p><b>Note</b> This step is required to ensure that all subpackages on the router were upgraded as part of this procedure, and might upgrade some subpackages that would otherwise be missed in the process.</p> |
| <b>Step 17</b> | <pre> <b>show version</b> <i>active-RP</i> <b>provisioned</b>  <b>Example:</b> <b>show version</b> <i>active-RP</i> <b>installed</b>  <b>Example:</b>  <b>Example:</b> </pre>                                                                                                                                                                                                                                                                                                                                                                                                                                        | (Optional) Confirm that the subpackages are provisioned and installed.                                                                                                                                                                                                   |

|                | Command or Action                                                                                                                              | Purpose                                                          |
|----------------|------------------------------------------------------------------------------------------------------------------------------------------------|------------------------------------------------------------------|
|                | Router# <b>show version r0 provisioned</b><br><b>Example:</b><br>Router# <b>show version r0 installed</b>                                      |                                                                  |
| <b>Step 18</b> | <b>redundancy force-switchover</b><br><b>Example:</b><br><b>Example:</b><br>Router# <b>redundancy force-switchover</b>                         | Force an RP switchover to complete the upgrade.                  |
| <b>Step 19</b> | <b>request platform software package clean</b><br><b>Example:</b><br><b>Example:</b><br>Router# <b>request platform software package clean</b> | (Optional) Removes all unused subpackages files from the router. |

## Examples

The following example shows ISSU upgrade using subpackages on a Cisco ASR 1006 router or ASR 1013 router with a dual RP setup using the **issu** command set

```

Router# show version
Cisco IOS Software, IOS-XE Software (X86_64_LINUX_IOSD-ADVENTERPRISEK9-M), Version 15.3(2)S,
 RELEASE SOFTWARE (fc1)
<output removed for brevity>
System image file is bootflash:Active_Dir/packages.conf
<output removed for brevity>
cisco ASR1013 (RP2) processor with 4208889K/6147K bytes of memory.
Processor board ID FOX1343GJGC
20 Gigabit Ethernet interfaces
6 Ten Gigabit Ethernet interfaces
32768K bytes of non-volatile configuration memory.
8388608K bytes of physical memory.
1925119K bytes of eUSB flash at bootflash:.
78085207K bytes of SATA hard disk at harddisk:.
Configuration register is 0x2102
Router# show platform
Chassis type: ASR1013
Slot Type State Insert time (ago)

2 ASR1000-SIP40 ok 1d03h
2/0 SPA-1X10GE-L-V2 ok 1d03h
2/1 SPA-1X10GE-L-V2 ok 1d03h
2/2 SPA-1X10GE-L-V2 ok 1d03h
2/3 SPA-1X10GE-L-V2 ok 1d03h
4 ASR1000-2T+20X1GE ok 1d03h
4/0 BUILT-IN-2T+20X1GE ok 1d03h

```

```

R0 ASR1000-RP2 ok, active 1d03h
R1 ASR1000-RP2 ok, standby 1d03h
F0 ASR1000-ESP100 ok, active 1d03h
F1 ASR1000-ESP100 ok, standby 1d03h
P0 ASR1013-PWR-AC ok 1d03h
P1 ASR1013-PWR-AC ok 1d03h
P2 ASR1013-PWR-AC ok 1d03h
P3 ASR1013-PWR-AC ps, fail 1d03h
Slot CPLD Version Firmware Version

2 00200800 15.3(3r)S
4 00200800 15.3(1r)S
R0 10021901 15.3(3r)S
R1 10021901 15.3(3r)S
F0 12071700 15.3(3r)S
F1 12071700 15.3(3r)S
Router# show version r0 installed
Package: Provisioning File, version: n/a, status: active
File: bootflash:Active_Dir/packages.conf, on: RP0
Built: n/a, by: n/a
File SHA1 checksum: a624f70f68c60292f4482433f43afd92487a55c4
Package: rpbase, version: 03.12.01.S.154-2.S, status: active
File: bootflash:Active_Dir/asr1000rp2-rpbase.03.12.01.S.154-2.S.pkg, on: RP0
Built: 2013-03-25_18.48, by: mcpre
File SHA1 checksum: 3a9675142898cfac350d4e42f0e37bd9f4e48538
Package: rpcontrol, version: 03.12.01.S.154-2.S, status: active
File: bootflash:Active_Dir/asr1000rp2-rpcontrol.03.12.01.S.154-2.S.pkg, on: RP0/0
Built: 2013-03-25_18.48, by: mcpre
File SHA1 checksum: 87b11f863f67fdf2610ee0769b929baab4c3efad
<output removed for brevity>
Router# dir bootflash:Active_Dir
Directory of bootflash:/Active_Dir/
 20 -rw- 41104112 Aug 3 2013 15:05:40 +05:30
asr1000rp2-elcbase.03.12.01.S.154-2.S.pkg
 21 -rw- 50285296 Aug 3 2013 15:05:40 +05:30 asr1000rp2-elcspa.03.12.01.S.154-2.S.pkg

 22 -rw- 82514676 Aug 3 2013 15:05:40 +05:30
asr1000rp2-espbase.03.12.01.S.154-2.S.pkg
 23 -rw- 101084628 Aug 3 2013 15:05:40 +05:30
asr1000rp2-esp86base.03.12.01.S.154-2.S.pkg
 17 -rw- 9059 Aug 3 2013 15:05:40 +05:30
asr1000rp2-packages-adventerprisek9.03.12.01.S.154-2.S.conf
 24 -rw- 29012724 Aug 3 2013 15:05:40 +05:30
asr1000rp2-rpaccess.03.12.01.S.154-2.S.pkg
 25 -rw- 49898964 Aug 3 2013 15:05:40 +05:30 asr1000rp2-rpbase.03.12.01.S.154-2.S.pkg

 26 -rw- 46557940 Aug 3 2013 15:05:40 +05:30
asr1000rp2-rpcontrol.03.12.01.S.154-2.S.pkg
 27 -rw- 114612988 Aug 3 2013 15:05:41 +05:30
asr1000rp2-rpios-adventerprisek9.03.12.01.S.154-2.S.pkg
 28 -rw- 41954036 Aug 3 2013 15:05:41 +05:30
asr1000rp2-sipbase.03.12.01.S.154-2.S.pkg
 29 -rw- 60957428 Aug 3 2013 15:05:41 +05:30 asr1000rp2-sipspa.03.12.01.S.154-2.S.pkg

 19 -rw- 9838 Aug 3 2013 15:05:41 +05:30 packages.conf
1940303872 bytes total (503164928 bytes free)
Router# show redundancy states
my state = 13 -ACTIVE
peer state = 8 -STANDBY HOT
Mode = Duplex
Unit = Primary
Unit ID = 48
Redundancy Mode (Operational) = sso
Redundancy Mode (Configured) = sso

```

```

Redundancy State = sso
 Maintenance Mode = Disabled
 Manual Swact = enabled
 Communications = Up
 client count = 108
 client_notification_TMR = 30000 milliseconds
 RF debug mask = 0x0

Router# copy running-config startup-config
Destination filename [startup-config]?
Building configuration...
[OK]
Router# mkdir harddisk:Target_Subs
Create directory filename [Target_Subs]?
Created dir harddisk:/Target_Subs
Router#
Router#
Router#
Router# request platform software package expand file
harddisk:Target_Subs/asr1000rp2-adventerprisek9.03.13.00.S.154-3.S-ext.bin to
harddisk:Target_Subs
Verifying parameters
Validating package type
Copying package files
SUCCESS: Finished expanding all-in-one software package.
Router#
Router#
Router# dir harddisk:Target_Subs
Directory of harddisk:/Target_Subs/
3358722 -rw- 569597380 Aug 4 2013 18:45:38 +05:30
asr1000rp2-adventerprisek9.03.13.00.S.154-3.S-ext.bin
7684099 -rw- 37557200 Aug 4 2013 18:46:43 +05:30
asr1000rp2-elcbase.03.13.00.S.154-3.S-ext.pkg
7684100 -rw- 51194832 Aug 4 2013 18:46:43 +05:30
asr1000rp2-elcspa.03.13.00.S.154-3.S-ext.pkg
7684101 -rw- 80657364 Aug 4 2013 18:46:43 +05:30
asr1000rp2-espbase.03.13.00.S.154-3.S-ext.pkg
7684102 -rw- 95446456 Aug 4 2013 18:46:43 +05:30
asr1000rp2-esp86base.03.13.00.S.154-3.S-ext.pkg
7684097 -rw- 9381 Aug 4 2013 18:46:43 +05:30
asr1000rp2-packages-adventerprisek9.03.13.00.S.154-3.S-ext.conf
7684103 -rw- 23350232 Aug 4 2013 18:46:43 +05:30
asr1000rp2-rpaccess.03.13.00.S.154-3.S-ext.pkg
7684104 -rw- 37694900 Aug 4 2013 18:46:44 +05:30
asr1000rp2-rpbase.03.13.00.S.154-3.S-ext.pkg
7684105 -rw- 45536216 Aug 4 2013 18:46:44 +05:30
asr1000rp2-rpcontrol.03.13.00.S.154-3.S-ext.pkg
7684106 -rw- 118754284 Aug 4 2013 18:46:44 +05:30
asr1000rp2-rpios-adventerprisek9.03.13.00.S.154-3.S-ext.pkg
7684107 -rw- 38380500 Aug 4 2013 18:46:44 +05:30
asr1000rp2-sipbase.03.13.00.S.154-3.S-ext.pkg
7684108 -rw- 61760468 Aug 4 2013 18:46:44 +05:30
asr1000rp2-sipspa.03.13.00.S.154-3.S-ext.pkg
7684098 -rw- 10165 Aug 4 2013 18:46:44 +05:30 packages.conf
78704144384 bytes total (9254879232 bytes free)
Router# copy harddisk:Target_Subs/asr1000rp2-espbase.03.13.00.S.154-3.S-ext.pkg
bootflash:Active_Dir/
Destination filename [Active_Dir/asr1000rp2-espbase.03.13.00.S.154-3.S-ext.pkg]?
Copy in progress...CCCC80657364 bytes copied in 11.951 secs (6749005 bytes/sec)
Router#
Router# copy harddisk:Target_Subs/asr1000rp2-esp86base.03.13.00.S.154-3.S-ext.pkg
bootflash:Active_Dir/
Destination filename [Active_Dir/asr1000rp2-esp86base.03.13.00.S.154-3.S-ext.pkg]?
Copy in progress...CCCC
95446456 bytes copied in 14.213 secs (6715433 bytes/sec)

```



```

Router#
Router# copy harddisk:Target_Sub/Target_Sub/asr1000rp2-rpaccess.03.13.00.S.154-3.S-ext.pkg
bootflash:Active_Dir/
Destination filename [Active_Dir/asr1000rp2-rpaccess.03.13.00.S.154-3.S-ext.pkg]?
Copy in progress...CCCCC
23350232 bytes copied in 3.441 secs (6785885 bytes/sec)
Router#
Router# copy harddisk:Target_Sub/Target_Sub/asr1000rp2-rpbase.03.13.00.S.154-3.S-ext.pkg
bootflash:Active_Dir/
Destination filename [Active_Dir/asr1000rp2-rpbase.03.13.00.S.154-3.S-ext.pkg]?
Copy in progress...CCCCC37694900 bytes copied in 5.598 secs (6733637 bytes/sec)
Router#
Router# copy harddisk:Target_Sub/Target_Sub/asr1000rp2-rpcontrol.03.13.00.S.154-3.S-ext.pkg
bootflash:Active_Dir/
Destination filename [Active_Dir/asr1000rp2-rpcontrol.03.13.00.S.154-3.S-ext.pkg]?
Copy in progress...CCCCC45536216 bytes copied in 6.797 secs (6699458 bytes/sec)
Router#
Router# copy harddisk:Target_Sub/Target_Sub/asr1000rp2-rpios-adventerprisek9.03.13.00.S.154-3.S-ext.pkg
bootflash:Active_Dir/
Destination filename [Active_Dir/asr1000rp2-rpios-adventerprisek9.03.13.00.S.154-3.S-ext.pkg]?

Copy in progress...CCCCCC118754284 bytes copied in 17.798 secs (6672339 bytes/sec)
Router#
Router# copy harddisk:Target_Sub/Target_Sub/asr1000rp2-sipbase.03.13.00.S.154-3.S-ext.pkg
bootflash:Active_Dir/
Destination filename [Active_Dir/asr1000rp2-sipbase.03.13.00.S.154-3.S-ext.pkg]?
Copy in progress...CC38380500 bytes copied in 5.962 secs (6437521 bytes/sec)
Router#
Router# copy harddisk:Target_Sub/Target_Sub/asr1000rp2-sipspa.03.13.00.S.154-3.S-ext.pkg
bootflash:Active_Dir/
Destination filename [Active_Dir/asr1000rp2-sipspa.03.13.00.S.154-3.S-ext.pkg]?
Copy in progress...CCCCCCCC61760468 bytes copied in 9.408 secs (6564676 bytes/sec)
Router#
Router# copy harddisk:Target_Sub/Target_Sub/asr1000rp2-elcbase.03.13.00.S.154-3.S-ext.pkg
bootflash:Active_Dir/
Destination filename [Active_Dir/asr1000rp2-elcbase.03.13.00.S.154-3.S-ext.pkg]?
Copy in progress...CCCCCC37557200 bytes copied in 5.650 secs (6647292 bytes/sec)
Router# copy harddisk:Target_Sub/Target_Sub/asr1000rp2-elcspa.03.13.00.S.154-3.S-ext.pkg
bootflash:Active_Dir/
Destination filename [Active_Dir/asr1000rp2-elcspa.03.13.00.S.154-3.S-ext.pkg]?
Copy in progress...CCCCCC51194832 bytes copied in 7.397 secs (6921026 bytes/sec)
Router#
Router# copy harddisk:Target_Sub/Target_Sub/asr1000rp2-espbase.03.13.00.S.154-3.S-ext.pkg
stby-bootflash:Active_Dir/
Destination filename [Active_Dir/asr1000rp2-espbase.03.13.00.S.154-3.S-ext.pkg]?
Copy in progress...CCCCC80657364 bytes copied in 132.765 secs (607520 bytes/sec)
Router#
Router# copy harddisk:Target_Sub/Target_Sub/asr1000rp2-esp86base.03.13.00.S.154-3.S-ext.pkg
stby-bootflash:Active_Dir/
Destination filename [Active_Dir/asr1000rp2-esp86base.03.13.00.S.154-3.S-ext.pkg]?
Copy in progress...CCCC95446456 bytes copied in 177.587 secs (537463 bytes/sec)
Router#
Router# copy harddisk:Target_Sub/Target_Sub/asr1000rp2-rpaccess.03.13.00.S.154-3.S-ext.pkg
stby-bootflash:Active_Dir/
Destination filename [Active_Dir/asr1000rp2-rpaccess.03.13.00.S.154-3.S-ext.pkg]?
Copy in progress...CCCCC23350232 bytes copied in 55.396 secs (421515 bytes/sec)
Router#
Router# copy harddisk:Target_Sub/Target_Sub/asr1000rp2-rpbase.03.13.00.S.154-3.S-ext.pkg
stby-bootflash:Active_Dir/
Destination filename [Active_Dir/asr1000rp2-rpbase.03.13.00.S.154-3.S-ext.pkg]?
Copy in progress...CCCCC
37694900 bytes copied in 86.199 secs (437301 bytes/sec)
Router#

```

```

Router# copy harddisk:Target_Sub/asr1000rp2-rpcontrol.03.13.00.S.154-3.S-ext.pkg
stby-bootflash:Active_Dir/
Destination filename [Active_Dir/asr1000rp2-rpcontrol.03.13.00.S.154-3.S-ext.pkg]?
Copy in progress...CCCCC
45536216 bytes copied in 101.527 secs (448513 bytes/sec)
Router#
Router# copy harddisk:Target_Sub/asr1000rp2-rpios-adventerprisek9.03.13.00.S.154-3.S-ext.pkg
stby-bootflash:Active_Dir/
Destination filename [Active_Dir/asr1000rp2-rpios-adventerprisek9.03.13.00.S.154-3.S-ext.pkg]?

Copy in progress...CCCCC118754284 bytes copied in 212.646 secs (558460 bytes/sec)
Router#
Router# copy harddisk:Target_Sub/asr1000rp2-sipbase.03.13.00.S.154-3.S-ext.pkg
stby-bootflash:Active_Dir/
Destination filename [Active_Dir/asr1000rp2-sipbase.03.13.00.S.154-3.S-ext.pkg]?
Copy in progress...CCCCC38380500 bytes copied in 83.162 secs (461515 bytes/sec)
Router#
Router# copy harddisk:Target_Sub/asr1000rp2-sipspa.03.13.00.S.154-3.S-ext.pkg
stby-bootflash:Active_Dir/
Destination filename [Active_Dir/asr1000rp2-sipspa.03.13.00.S.154-3.S-ext.pkg]?
Copy in progress...CCCCC61760468 bytes copied in 119.391 secs (517296 bytes/sec)
Router#
Router# copy harddisk:Target_Sub/asr1000rp2-elcbase.03.13.00.S.154-3.S-ext.pkg
stby-bootflash:Active_Dir/
Destination filename [Active_Dir/asr1000rp2-elcbase.03.13.00.S.154-3.S-ext.pkg]?
Copy in progress...CCCCC37557200 bytes copied in 57.106 secs (657675 bytes/sec)
Router#
Router# copy harddisk:Target_Sub/asr1000rp2-elcspa.03.13.00.S.154-3.S-ext.pkg
stby-bootflash:Active_Dir/
Destination filename [Active_Dir/asr1000rp2-elcspa.03.13.00.S.154-3.S-ext.pkg]?
Copy in progress...CCCCCC51194832 bytes copied in 87.453 secs (585398 bytes/sec)
Router#
Router# issu checkversion rp 1 file
stby-bootflash:Active_Dir/asr1000rp*03.13.00.S.154-3.S-ext*.pkg mdr force
--- Starting local lock acquisition on R0 ---
Finished local lock acquisition on R0
--- Starting installation state synchronization ---
Finished installation state synchronization
--- Starting local lock acquisition on R1 ---
Finished local lock acquisition on R1
--- Starting file path checking ---
Finished file path checking
--- Starting image file verification ---
Checking image file names
Locating image files and validating name syntax
 Found asr1000rp2-elcbase.03.13.00.S.154-3.S-ext.pkg
 Found asr1000rp2-elcspa.03.13.00.S.154-3.S-ext.pkg
 Found asr1000rp2-espbase.03.13.00.S.154-3.S-ext.pkg
 Found asr1000rp2-esp86base.03.13.00.S.154-3.S-ext.pkg
 Found asr1000rp2-rpaccess.03.13.00.S.154-3.S-ext.pkg
 Found asr1000rp2-rpbase.03.13.00.S.154-3.S-ext.pkg
 Found asr1000rp2-rpcontrol.03.13.00.S.154-3.S-ext.pkg
 Found asr1000rp2-rpios-adventerprisek9.03.13.00.S.154-3.S-ext.pkg
 Found asr1000rp2-sipbase.03.13.00.S.154-3.S-ext.pkg
 Found asr1000rp2-sipspa.03.13.00.S.154-3.S-ext.pkg
Verifying image file locations
Inspecting image file types
 WARNING: In-service installation of IOSD package
 WARNING: requires software redundancy on target RP
 WARNING: or on-reboot parameter
 WARNING: Automatically setting the on-reboot flag
 WARNING: In-service installation of RP Base package
 WARNING: requires software reboot of target RP
Processing image file constraints

```

```

Creating candidate provisioning file
Finished image file verification
--- Starting candidate package set construction ---
Verifying existing software set
Processing candidate provisioning file
Constructing working set for candidate package set
Constructing working set for running package set
Checking command output
Constructing merge of running and candidate packages
Checking if resulting candidate package set would be complete
Finished candidate package set construction
--- Starting compatibility testing ---
Determining whether candidate package set is compatible
Determining whether installation is valid
Determining whether installation is valid ... skipped
Verifying image type compatibility
Checking IPC compatibility for candidate software
Checking candidate package set infrastructure compatibility
Checking infrastructure compatibility with running software
Checking infrastructure compatibility with running software ... skipped
Checking package specific compatibility
Finished compatibility testing
--- Starting mdr compatibility verification ---
Finished mdr compatibility verification
SUCCESS: Software is ISSU MDR compatible.
Router#
Router#
Router# issu loadversion rp 1 file
stby-bootflash:Active_Dir/asr1000rp*03.13.00.S.154-3.S-ext*.pkg force
--- Starting local lock acquisition on R0 ---
Finished local lock acquisition on R0
--- Starting installation state synchronization ---
Finished installation state synchronization
--- Starting local lock acquisition on R1 ---
Finished local lock acquisition on R1
--- Starting file path checking ---
Finished file path checking
--- Starting image file verification ---
Checking image file names
Locating image files and validating name syntax
 Found asr1000rp2-elcbase.03.13.00.S.154-3.S-ext.pkg
 Found asr1000rp2-elcspa.03.13.00.S.154-3.S-ext.pkg
 Found asr1000rp2-espbase.03.13.00.S.154-3.S-ext.pkg
 Found asr1000rp2-esp86base.03.13.00.S.154-3.S-ext.pkg
 Found asr1000rp2-rpaccess.03.13.00.S.154-3.S-ext.pkg
 Found asr1000rp2-rpbase.03.13.00.S.154-3.S-ext.pkg
 Found asr1000rp2-rpcontrol.03.13.00.S.154-3.S-ext.pkg
 Found asr1000rp2-rpios-adventerprisek9.03.13.00.S.154-3.S-ext.pkg
 Found asr1000rp2-sipbase.03.13.00.S.154-3.S-ext.pkg
 Found asr1000rp2-sipspa.03.13.00.S.154-3.S-ext.pkg
Verifying image file locations
Inspecting image file types
 WARNING: In-service installation of IOSD package
 WARNING: requires software redundancy on target RP
 WARNING: or on-reboot parameter
 WARNING: Automatically setting the on-reboot flag
 WARNING: In-service installation of RP Base package
 WARNING: requires software reboot of target RP
Processing image file constraints
Creating candidate provisioning file
Finished image file verification
--- Starting candidate package set construction ---
Verifying existing software set
Processing candidate provisioning file

```

```

Constructing working set for candidate package set
Constructing working set for running package set
Checking command output
Constructing merge of running and candidate packages
Checking if resulting candidate package set would be complete
Finished candidate package set construction
--- Starting compatibility testing ---
Determining whether candidate package set is compatible
Determining whether installation is valid
Determining whether installation is valid ... skipped
Verifying image type compatibility
Checking IPC compatibility for candidate software
Checking candidate package set infrastructure compatibility
Checking infrastructure compatibility with running software
Checking infrastructure compatibility with running software ... skipped
Checking package specific compatibility
Finished compatibility testing
--- Starting list of software package changes ---
Old files list:
 Removed asr1000rp2-elcbase.03.12.01.S.154-2.S.pkg
 Removed asr1000rp2-elcspa.03.12.01.S.154-2.S.pkg
 Removed asr1000rp2-espbase.03.12.01.S.154-2.S.pkg
 Removed asr1000rp2-esp86base.03.12.01.S.154-2.S.pkg
 Removed asr1000rp2-rpaccess.03.12.01.S.154-2.S.pkg
 Removed asr1000rp2-rpbase.03.12.01.S.154-2.S.pkg
 Removed asr1000rp2-rpcontrol.03.12.01.S.154-2.S.pkg
 Removed asr1000rp2-rpios-adventerprisek9.03.12.01.S.154-2.S.pkg
 Removed asr1000rp2-sipbase.03.12.01.S.154-2.S.pkg
 Removed asr1000rp2-sipsa.03.12.01.S.154-2.S.pkg
New files list:
 Added asr1000rp2-elcbase.03.13.00.S.154-3.S-ext.pkg
 Added asr1000rp2-elcspa.03.13.00.S.154-3.S-ext.pkg
 Added asr1000rp2-espbase.03.13.00.S.154-3.S-ext.pkg
 Added asr1000rp2-esp86base.03.13.00.S.154-3.S-ext.pkg
 Added asr1000rp2-rpaccess.03.13.00.S.154-3.S-ext.pkg
 Added asr1000rp2-rpbase.03.13.00.S.154-3.S-ext.pkg
 Added asr1000rp2-rpcontrol.03.13.00.S.154-3.S-ext.pkg
 Added asr1000rp2-rpios-adventerprisek9.03.13.00.S.154-3.S-ext.pkg
 Added asr1000rp2-sipbase.03.13.00.S.154-3.S-ext.pkg
 Added asr1000rp2-sipsa.03.13.00.S.154-3.S-ext.pkg
Finished list of software package changes
--- Starting commit of software changes ---
Updating provisioning rollback files
Creating pending provisioning file
Committing provisioning file
Finished commit of software changes
SUCCESS: Software provisioned. New software will load on reboot.
Router#
Router#
Router# hw-module slot r1 reload
Proceed with reload of module? [confirm]Y
Router#
*Aug 4 19:14:01.721 IST: %IOSXE_OIR-6-OFFLINECARD: Card (rp) offline in slot R1
*Aug 4 19:14:01.761 IST: %REDUNDANCY-3-STANDBY_LOST: Standby processor fault
(P_EER_NOT_PRESENT)
*Aug 4 19:14:01.761 IST: %REDUNDANCY-3-STANDBY_LOST: Standby processor fault (P_EER_DOWN)
*Aug 4 19:14:01.761 IST: %REDUNDANCY-3-STANDBY_LOST: Standby processor fault
(P_EER_REDUNDANCY_STATE_CHANGE)
*Aug 4 19:14:03.584 IST: %RF-5-RF_RELOAD: Peer reload. Reason: EHSa standby down
*Aug 4 19:14:03.594 IST: % Redundancy mode change to SSO
Router#
*Aug 4 19:17:35.443 IST: %IOSXE_OIR-6-ONLINECARD: Card (rp) online in slot R1
Router#
*Aug 4 19:17:48.061 IST: %REDUNDANCY-5-P_EER_MONITOR_EVENT: Active detected a standby

```

```

insertion (raw-event=PEER_FOUND(4))
*Aug 4 19:17:48.061 IST: %REDUNDANCY-5-PEER_MONITOR_EVENT: Active detected a standby
insertion (raw-event=PEER_REDUNDANCY_STATE_CHANGE(5))
*Aug 4 19:17:51.003 IST: %REDUNDANCY-3-IPC: IOS versions do not match.

*Aug 4 19:19:08.380 IST: %NBAR_HA-5-NBAR_INFO: NBAR sync DONE!
*Aug 4 19:19:08.797 IST: %HA_CONFIG_SYNC-6-BULK_CFGSYNC_SUCCEED: Bulk Sync succeeded
*Aug 4 19:19:08.798 IST: %RF-5-RF_TERMINAL_STATE: Terminal state reached for (SSO)
Router#
Router# issu loadversion rp 0 file
bootflash:Active_Dir/asr1000rp2-{sibase,sipsa}*03.13.00.S.154-3.S-ext*.pkg slot 2 mdr
force
--- Starting local lock acquisition on R0 ---
Finished local lock acquisition on R0
--- Starting installation state synchronization ---
Finished installation state synchronization
--- Starting file path checking ---
Finished file path checking
--- Starting image file verification ---
Checking image file names
Locating image files and validating name syntax
 Found asr1000rp2-sibase.03.13.00.S.154-3.S-ext.pkg
 Found asr1000rp2-sipsa.03.13.00.S.154-3.S-ext.pkg
Verifying image file locations
Inspecting image file types
Processing image file constraints
Creating candidate provisioning file
Finished image file verification
--- Starting candidate package set construction ---
Verifying existing software set
Processing candidate provisioning file
Constructing working set for candidate package set
Constructing working set for running package set
Checking command output
Constructing merge of running and candidate packages
Checking if resulting candidate package set would be complete
Finished candidate package set construction
--- Starting compatibility testing ---
Determining whether candidate package set is compatible
WARNING:
WARNING: Candidate software combination not found in compatibility database
WARNING:
Determining whether installation is valid
Creating matrix_file by locate_latest_matrix_file /tmp/issu/provision/sw
WARNING:
WARNING: Candidate software combination not found in compatibility database
WARNING:
WARNING:
WARNING: Candidate software combination not found in compatibility database
WARNING:
Software sets are identified as compatible
Verifying image type compatibility
Checking IPC compatibility with running software
Checking candidate package set infrastructure compatibility
Checking infrastructure compatibility with running software
Checking package specific compatibility
Finished compatibility testing
--- Starting mdr compatibility verification ---
Finished mdr compatibility verification
--- Starting impact testing ---
Checking operational impact of change
Finished impact testing
--- Starting list of software package changes ---
No old package files removed

```

```

New files list:
 Added asr1000rp2-sipbase.03.13.00.S.154-3.S-ext.pkg
 Added asr1000rp2-sipspa.03.13.00.S.154-3.S-ext.pkg
Finished list of software package changes
--- Starting commit of software changes ---
Updating provisioning rollback files
Creating pending provisioning file
Committing provisioning file
Finished commit of software changes
--- Starting analysis of software changes ---
Finished analysis of software changes
--- Starting update running software ---
Blocking peer synchronization of operating information
Creating the command set placeholder directory
 Finding latest command set
 Finding latest command shortlist lookup file
 Finding latest command shortlist file
 Assembling CLI output libraries
 Assembling CLI input libraries
 Assembling Dynamic configuration files
 Applying interim IPC and database definitions
 Replacing running software
 Replacing CLI software
 Restarting software
Aug 4 19:20:48.949 IST: %MDR-5-CARD_RESTART: R0/0: card_mdr: Minimal Disruptive Restart
SIP2 to acquire provisioned software Applying final IPC and database definitions
*Aug 4 19:20:58.013 IST: %CMCC-5-SPA_MDR_INIT: SIP2: cmcc: SPA0 initiated Minimal Disruptive
Restart
*Aug 4 19:20:58.017 IST: %CMCC-5-SPA_MDR_INIT: SIP2: cmcc: SPA1 initiated Minimal Disruptive
Restart
*Aug 4 19:20:58.018 IST: %CMCC-5-SPA_MDR_INIT: SIP2: cmcc: SPA2 initiated Minimal Disruptive
Restart
*Aug 4 19:20:58.019 IST: %CMCC-5-SPA_MDR_INIT: SIP2: cmcc: SPA3 initiated Minimal Disruptive
Restart Generating software version information
 Notifying running software of updates
 Unblocking peer synchronization of operating information
Unmounting old packages
Cleaning temporary installation files
 Finished update running software

SUCCESS: Finished installing software.
Router#
*Aug 4 19:21:45.424 IST: %IOSXE_OIR-6-ONLINECARD: Card (cc) online in slot 2
*Aug 4 19:21:48.382 IST: %IOSXE_OIR-6-INSSPA: SPA inserted in subslot 2/0
*Aug 4 19:21:48.733 IST: %IOSXE_OIR-6-INSSPA: SPA inserted in subslot 2/1
*Aug 4 19:21:49.083 IST: %IOSXE_OIR-6-INSSPA: SPA inserted in subslot 2/2
*Aug 4 19:21:49.430 IST: %IOSXE_OIR-6-INSSPA: SPA inserted in subslot 2/3
*Aug 4 19:21:58.121 IST: %LINK-3-UPDOWN: SIP2/0: Interface EOBC2/1, changed state to up
*Aug 4 19:22:02.302 IST: %SPA_OIR-6-ONLINECARD: SPA (SPA-1X10GE-L-V2) online in subslot
2/0
*Aug 4 19:22:02.312 IST: %CMCC-5-SPA_MDR_DONE: SIP2: cmcc: SPA0 completed Minimal Disruptive
Restart
*Aug 4 19:22:02.282 IST: %TRANSCEIVER-6-INSERTED: SIP2/0: transceiver module inserted in
TenGigabitEthernet2/0/0
*Aug 4 19:22:02.518 IST: %LINK-3-UPDOWN: SIP2/1: Interface EOBC2/1, changed state to up
*Aug 4 19:22:06.113 IST: %SPA_OIR-6-ONLINECARD: SPA (SPA-1X10GE-L-V2) online in subslot
2/1
*Aug 4 19:22:06.126 IST: %CMCC-5-SPA_MDR_DONE: SIP2: cmcc: SPA1 completed Minimal Disruptive
Restart
*Aug 4 19:22:06.082 IST: %TRANSCEIVER-6-INSERTED: SIP2/1: transceiver module inserted in
TenGigabitEthernet2/1/0
*Aug 4 19:22:08.080 IST: %LINK-3-UPDOWN: SIP2/2: Interface EOBC2/1, changed state to up
*Aug 4 19:22:11.627 IST: %SPA_OIR-6-ONLINECARD: SPA (SPA-1X10GE-L-V2) online in subslot
2/2

```

```

*Aug 4 19:22:11.637 IST: %CMCC-5-SPA_MDR_DONE: SIP2: cmcc: SPA2 completed Minimal Disruptive
Restart
*Aug 4 19:22:11.616 IST: %TRANSCEIVER-6-INSERTED: SIP2/2: transceiver module inserted in
TenGigabitEthernet2/2/0
*Aug 4 19:22:12.523 IST: %LINK-3-UPDOWN: SIP2/3: Interface EOBC2/1, changed state to up
*Aug 4 19:22:16.657 IST: %SPA_OIR-6-ONLINECARD: SPA (SPA-1X10GE-L-V2) online in subslot
2/3
*Aug 4 19:22:16.668 IST: %CMCC-5-SPA_MDR_DONE: SIP2: cmcc: SPA3 completed Minimal Disruptive
Restart
*Aug 4 19:22:16.648 IST: %TRANSCEIVER-6-INSERTED: SIP2/3: transceiver module inserted in
TenGigabitEthernet2/3/0
Router#
Router#
Router# issu commitversion
--- Starting local lock acquisition on R0 ---
Finished local lock acquisition on R0
--- Starting installation changes ---
Cancelling rollback timer
Finished installation changes
SUCCESS: Installation changes committed
Router#
Router#
Router#
Router#issu loadversion rp 0 file
harddisk:boot_dir/asr1000rp2-{elcbase,elcspa}*03.13.00.S.154-3.S.pkg slot 4 mdr
--- Starting local lock acquisition on R0 ---
Finished local lock acquisition on R0
--- Starting installation state synchronization ---
Finished installation state synchronization
--- Starting file path checking ---
Finished file path checking
--- Starting image file verification ---
Checking image file names
Locating image files and validating name syntax
 Found asr1000rp2-elcbase.03.13.00.S.154-3.pkg
 Found asr1000rp2-elcspa.03.13.00.S.154-3.pkg
Verifying image file locations
Inspecting image file types
Processing image file constraints
Creating candidate provisioning file
Finished image file verification
--- Starting candidate package set construction ---
Verifying existing software set
Processing candidate provisioning file
Constructing working set for candidate package set
Constructing working set for running package set
Checking command output
Constructing merge of running and candidate packages
Checking if resulting candidate package set would be complete
Finished candidate package set construction
--- Starting compatibility testing ---
Determining whether candidate package set is compatible
WARNING:
WARNING: Candidate software combination not found in compatibility database
WARNING:
Determining whether installation is valid
Creating matrix_file by locate_latest_matrix_file /tmp/issu/provision/sw
WARNING:
WARNING: Candidate software combination not found in compatibility database
WARNING:
WARNING:
WARNING: Candidate software combination not found in compatibility database
WARNING:
Software sets are identified as compatible

```

```

Verifying image type compatibility
Checking IPC compatibility with running software
Checking candidate package set infrastructure compatibility
Checking infrastructure compatibility with running software
Checking package specific compatibility
Finished compatibility testing
--- Starting mdr compatibility verification ---
WARNING:
WARNING: ISSU between engineering builds with release strings in non-standard format.
Skipping MDR Software Compatibility checks.
WARNING:
WARNING:
WARNING: ISSU between engineering builds with release strings in non-standard format.
Skipping MDR Software Compatibility checks.
WARNING:
Finished mdr compatibility verification
--- Starting impact testing ---
Checking operational impact of change
Finished impact testing
--- Starting list of software package changes ---
No old package files removed
New files list:
 Added asr1000rp2-elcbase.03.13.00.S.154-3.pkg
 Added asr1000rp2-elcspa.03.13.00.S.154-3.pkg
Finished list of software package changes
--- Starting commit of software changes ---
Updating provisioning rollback files
Creating pending provisioning file
Committing provisioning file
Finished commit of software changes
--- Starting analysis of software changes ---
Finished analysis of software changes
--- Starting update running software ---
Blocking peer synchronization of operating information
Creating the command set placeholder directory
 Finding latest command set
 Finding latest command shortlist lookup file
 Finding latest command shortlist file
 Assembling CLI output libraries
 Assembling CLI input libraries
 Assembling Dynamic configuration files
 Applying interim IPC and database definitions
 Replacing running software
 Replacing CLI software
 Restarting software
 Applying final IPC and database definitions
*Jan 13 00:41:37.778 PST: %MDR-5-CARD_RESTART: R0/0: card_mdr: Minimal Disruptive Restart
SIP0 to acquire provisioned software
*Jan 13 00:41:47.894 PST: %CMCC-5-SPA_MDR_INIT: SIP0: cmcc: SPA0 initiated Minimal Disruptive
Restart Generating softwareversion information
 Notifying running software of updates
 Unblocking peer synchronization of operating information
Unmounting old packages
Cleaning temporary installation files
 Finished update running software
SUCCESS: Finished installing software.
Router#
Router#

Disruptive Restart
Router#
Router#
Router#
Router#
Router#issu commitversion

```



```
--- Starting local lock acquisition on R0 ---
Finished local lock acquisition on R0
--- Starting installation changes ---
Cancelling rollback timer
Finished installation changes
SUCCESS: Installation changes committed
Router#
Router#
Router# issu loadversion rp 0 file
bootflash:Active_Dir/asr1000rp2-esp*03.13.00.S.154-3.S-ext*.pkg slot 1
--- Starting local lock acquisition on R0 ---
Finished local lock acquisition on R0
--- Starting installation state synchronization ---
Finished installation state synchronization
--- Starting file path checking ---
Finished file path checking
--- Starting image file verification ---
Checking image file names
Locating image files and validating name syntax
 Found asr1000rp2-espbase.03.13.00.S.154-3.S-ext.pkg
 Found asr1000rp2-esp86base.03.13.00.S.154-3.S-ext.pkg
Verifying image file locations
Inspecting image file types
Processing image file constraints
Creating candidate provisioning file
Finished image file verification
--- Starting candidate package set construction ---
Verifying existing software set
Processing candidate provisioning file
Constructing working set for candidate package set
Constructing working set for running package set
Checking command output
Constructing merge of running and candidate packages
Checking if resulting candidate package set would be complete
Finished candidate package set construction
--- Starting compatibility testing ---
Determining whether candidate package set is compatible
WARNING:
WARNING: Candidate software combination not found in compatibility database
WARNING:
Determining whether installation is valid
Creating matrix_file by locate_latest_matrix_file /tmp/issu/provision/sw
WARNING:
WARNING: Candidate software combination not found in compatibility database
WARNING:
WARNING:
WARNING: Candidate software combination not found in compatibility database
WARNING:
Software sets are identified as compatible
Verifying image type compatibility
Checking IPC compatibility with running software
Checking candidate package set infrastructure compatibility
Checking infrastructure compatibility with running software
Checking package specific compatibility
Finished compatibility testing
--- Starting impact testing ---
Checking operational impact of change
Finished impact testing
--- Starting list of software package changes ---
No old package files removed
New files list:
 Added asr1000rp2-espbase.03.13.00.S.154-3.S-ext.pkg
 Added asr1000rp2-esp86base.03.13.00.S.154-3.S-ext.pkg
Finished list of software package changes
```

```

--- Starting commit of software changes ---
Updating provisioning rollback files
Creating pending provisioning file
Committing provisioning file
Finished commit of software changes
--- Starting analysis of software changes ---
Finished analysis of software changes
--- Starting update running software ---
Blocking peer synchronization of operating information
Creating the command set placeholder directory
 Finding latest command set
 Finding latest command shortlist lookup file
 Finding latest command shortlist file
 Assembling CLI output libraries
 Assembling CLI input libraries
 Assembling Dynamic configuration files
 Applying interim IPC and database definitions
 Replacing running software
 Replacing CLI software
 Restarting software
 Restarting ESP1
 Applying final IPC and database definitions
Aug 4 19:29:16.751 IST: %IOSXE_OIR-6-OFFLINECARD: Card (fp) offline in slot F1
*Aug 4 19:29:18.172 IST: %CMRP-6-FP_HA_STATUS: R0/0: cmand: F0 redundancy state is Active
with no Standby Generating software version information
 Notifying running software of updates
 Unblocking peer synchronization of operating information
Unmounting old packages
Cleaning temporary installation files
 Finished update running software

SUCCESS: Finished installing software.
Router#
*Aug 4 19:30:50.972 IST: %CPPHA-7-START: F1: cpp_ha: CPP 0 preparing image
/tmp/sw/fp/1/0/fpx86/mount/usr/cpp/bin/qfp-ucode-esp40
*Aug 4 19:30:51.362 IST: %CPPHA-7-START: F1: cpp_ha: CPP 0 startup init image
/tmp/sw/fp/1/0/fpx86/mount/usr/cpp/bin/qfp-ucode-esp40
*Aug 4 19:30:53.088 IST: %IOSXE_OIR-6-ONLINECARD: Card (fp) online in slot F1
Router#
Router# issu commitversion
--- Starting local lock acquisition on R0 ---
Finished local lock acquisition on R0
--- Starting installation changes ---
Cancelling rollback timer
Finished installation changes
SUCCESS: Installation changes committed
Router#
Router#
Router# issu loadversion rp 0 file
bootflash:Active_Dir/asr1000rp2-esp*03.13.00.S.154-3.S-ext*.pkg slot 0
--- Starting local lock acquisition on R0 ---
Finished local lock acquisition on R0
--- Starting installation state synchronization ---
Finished installation state synchronization
--- Starting file path checking ---
Finished file path checking
--- Starting image file verification ---
Checking image file names
Locating image files and validating name syntax
 Found asr1000rp2-espbase.03.13.00.S.154-3.S-ext.pkg
 Found asr1000rp2-esp86base.03.13.00.S.154-3.S-ext.pkg
Verifying image file locations
Inspecting image file types
Processing image file constraints

```

```

Creating candidate provisioning file
Aug 4 19:31:14.730 IST: %CPPHA-7-START: F1: cpp_ha: CPP 0 running init image
/tmp/sw/fp/1/0/fpx86/mount/usr/cpp/bin/qfp-ucode-esp40
*Aug 4 19:31:15.079 IST: %CPPHA-7-READY: F1: cpp_ha: CPP 0 loading and initialization
completeFinished image file verification
--- Starting candidate package set construction ---
Verifying existing software set
*Aug 4 19:31:15.309 IST: %IOSXE-6-PLATFORM: F1: cpp_cp: Process
CPP_PFILTER_EA_EVENT_API_CALL_REGISTERProcessing candidate provisioning file
*Aug 4 19:31:18.010 IST: %CMRP-6-FP_HA_STATUS: R0/0: cmand: F0 redundancy state is Active
with ready StandbyConstructing working set for candidate package set
Constructing working set for running package set
Checking command output
Constructing merge of running and candidate packages
Checking if resulting candidate package set would be complete
Finished candidate package set construction
--- Starting compatibility testing ---
Determining whether candidate package set is compatible
WARNING:
WARNING: Candidate software combination not found in compatibility database
WARNING:
Determining whether installation is valid
Creating matrix_file by locate_latest_matrix_file /tmp/issu/provision/sw
Software sets are identified as compatible
Verifying image type compatibility
Checking IPC compatibility with running software
Checking candidate package set infrastructure compatibility
Checking infrastructure compatibility with running software
Checking package specific compatibility
Finished compatibility testing
--- Starting impact testing ---
Checking operational impact of change
Finished impact testing
--- Starting list of software package changes ---
Old files list:
 Removed asr1000rp2-espbase.03.12.01.S.154-2.S.pkg
 Removed asr1000rp2-esp86base.03.12.01.S.154-2.S.pkg
No new package files added
Finished list of software package changes
--- Starting commit of software changes ---
Updating provisioning rollback files
Creating pending provisioning file
Committing provisioning file
Finished commit of software changes
--- Starting analysis of software changes ---
Finished analysis of software changes
--- Starting update running software ---
Blocking peer synchronization of operating information
Creating the command set placeholder directory
 Finding latest command set
 Finding latest command shortlist lookup file
 Finding latest command shortlist file
 Assembling CLI output libraries
 Assembling CLI input libraries
 Assembling Dynamic configuration files
 Applying interim IPC and database definitions
 Replacing running software
 Replacing CLI software
 Restarting software
 Restarting ESP0
 Applying final IPC and database definitions
*Aug 4 19:32:46.187 IST: %IOSXE_OIR-6-OFFLINECARD: Card (fp) offline in slot F0
*Aug 4 19:32:46.539 IST: %CMRP-6-FP_HA_STATUS: R0/0: cmand: F1 redundancy state is Active
 Generating software version information

```

## Examples

```

 Notifying running software of updates
 Unblocking peer synchronization of operating information
Unmounting old packages
Cleaning temporary installation files
 Finished update running software

SUCCESS: Finished installing software.
Router#
*Aug 4 19:34:19.748 IST: %CPPHA-7-START: F0: cpp_ha: CPP 0 preparing image
/tmp/sw/fp/0/0/fpx86/mount/usr/cpp/bin/qfp-ucode-esp40
*Aug 4 19:34:20.139 IST: %CPPHA-7-START: F0: cpp_ha: CPP 0 startup init image
/tmp/sw/fp/0/0/fpx86/mount/usr/cpp/bin/qfp-ucode-esp40
*Aug 4 19:34:21.858 IST: %IOSXE_OIR-6-ONLINECARD: Card (fp) online in slot F0
*Aug 4 19:34:43.609 IST: %CPPHA-7-START: F0: cpp_ha: CPP 0 running init image
/tmp/sw/fp/0/0/fpx86/mount/usr/cpp/bin/qfp-ucode-esp40
*Aug 4 19:34:43.958 IST: %CPPHA-7-READY: F0: cpp_ha: CPP 0 loading and initialization
complete
*Aug 4 19:34:44.190 IST: %IOSXE-6-PLATFORM: F0: cpp_cp: Process
CPP_PFILTER_EA_EVENT_API_CALL_REGISTER
*Aug 4 19:34:46.890 IST: %CMRP-6-FP_HA_STATUS: R0/0: cmand: F0 redundancy state is Standby
Router#
Router# show platform
Chassis type: ASR1013

```

| Slot | Type               | State            | Insert time (ago) |
|------|--------------------|------------------|-------------------|
| 2    | ASR1000-SIP40      | ok               | 1d04h             |
| 2/0  | SPA-1X10GE-L-V2    | ok               | 1d04h             |
| 2/1  | SPA-1X10GE-L-V2    | ok               | 1d04h             |
| 2/2  | SPA-1X10GE-L-V2    | ok               | 1d04h             |
| 2/3  | SPA-1X10GE-L-V2    | ok               | 1d04h             |
| 4    | ASR1000-2T+20X1GE  | ok               | 1d04h             |
| 4/0  | BUILT-IN-2T+20X1GE | ok               | 1d04h             |
| R0   | ASR1000-RP2        | ok, active       | 1d04h             |
| R1   | ASR1000-RP2        | ok, standby      | 1d04h             |
| F0   | ASR1000-ESP100     | ok, standby      | 1d04h             |
| F1   | ASR1000-ESP100     | ok, active       | 1d04h             |
| P0   | ASR1013-PWR-AC     | ok               | 1d04h             |
| P1   | ASR1013-PWR-AC     | ok               | 1d04h             |
| P2   | ASR1013-PWR-AC     | ok               | 1d04h             |
| P3   | ASR1013-PWR-AC     | ps, fail         | 1d04h             |
| Slot | CPLD Version       | Firmware Version |                   |
| 2    | 00200800           | 15.3(3r)S        |                   |
| 4    | 00200800           | 15.3(1r)S        |                   |
| R0   | 10021901           | 15.3(3r)S        |                   |
| R1   | 10021901           | 15.3(3r)S        |                   |
| F0   | 12071700           | 15.3(3r)S        |                   |
| F1   | 12071700           | 15.3(3r)S        |                   |

```

Router#
Router# issu commitversion
--- Starting local lock acquisition on R0 ---
Finished local lock acquisition on R0
--- Starting installation changes ---
Cancelling rollback timer
Finished installation changes
SUCCESS: Installation changes committed
Router#
Router#
Router#issu loadversion rp 0 file bootflash:Active_Dir/asr1000rp2*03.13.00.S.154-3.S-ext*.pkg
force
--- Starting local lock acquisition on R0 ---
Finished local lock acquisition on R0
--- Starting installation state synchronization ---
Finished installation state synchronization

```

```

--- Starting file path checking ---
Finished file path checking
--- Starting image file verification ---
Checking image file names
Locating image files and validating name syntax
 Found asr1000rp2-elcbase.03.13.00.S.154-3.S-ext.pkg
 Found asr1000rp2-elcspa.03.13.00.S.154-3.S-ext.pkg
 Found asr1000rp2-espbase.03.13.00.S.154-3.S-ext.pkg
 Found asr1000rp2-esp86base.03.13.00.S.154-3.S-ext.pkg
 Found asr1000rp2-rpaccess.03.13.00.S.154-3.S-ext.pkg
 Found asr1000rp2-rpbase.03.13.00.S.154-3.S-ext.pkg
 Found asr1000rp2-rpcontrol.03.13.00.S.154-3.S-ext.pkg
 Found asr1000rp2-rpios-adventerprisek9.03.13.00.S.154-3.S-ext.pkg
 Found asr1000rp2-sipbase.03.13.00.S.154-3.S-ext.pkg
 Found asr1000rp2-sipspa.03.13.00.S.154-3.S-ext.pkg
Verifying image file locations
Inspecting image file types
 WARNING: In-service installation of IOSD package
 WARNING: requires software redundancy on target RP
 WARNING: or on-reboot parameter
 WARNING: Automatically setting the on-reboot flag
 WARNING: In-service installation of RP Base package
 WARNING: requires software reboot of target RP
Processing image file constraints
Creating candidate provisioning file
Finished image file verification
--- Starting candidate package set construction ---
Verifying existing software set
Processing candidate provisioning file
Constructing working set for candidate package set
Constructing working set for running package set
Checking command output
Constructing merge of running and candidate packages
Checking if resulting candidate package set would be complete
Finished candidate package set construction
--- Starting compatibility testing ---
Determining whether candidate package set is compatible
Determining whether installation is valid
Determining whether installation is valid ... skipped
Verifying image type compatibility
Checking IPC compatibility for candidate software
Checking candidate package set infrastructure compatibility
Checking infrastructure compatibility with running software
Checking infrastructure compatibility with running software ... skipped
Checking package specific compatibility
Finished compatibility testing
--- Starting list of software package changes ---
Old files list:
 Removed asr1000rp2-elcbase.03.12.01.S.154-2.S.pkg
 Removed asr1000rp2-elcspa.03.12.01.S.154-2.S.pkg
 Removed asr1000rp2-rpaccess.03.12.01.S.154-2.S.pkg
 Removed asr1000rp2-rpbase.03.12.01.S.154-2.S.pkg
 Removed asr1000rp2-rpcontrol.03.12.01.S.154-2.S.pkg
 Removed asr1000rp2-rpios-adventerprisek9.03.12.01.S.154-2.S.pkg
 Removed asr1000rp2-sipbase.03.12.01.S.154-2.S.pkg
 Removed asr1000rp2-sipspa.03.12.01.S.154-2.S.pkg
New files list:
 Added asr1000rp2-rpaccess.03.13.00.S.154-3.S-ext.pkg
 Added asr1000rp2-rpbase.03.13.00.S.154-3.S-ext.pkg
 Added asr1000rp2-rpcontrol.03.13.00.S.154-3.S-ext.pkg
 Added asr1000rp2-rpios-adventerprisek9.03.13.00.S.154-3.S-ext.pkg
Finished list of software package changes
--- Starting commit of software changes ---
Updating provisioning rollback files

```

```

Creating pending provisioning file
Committing provisioning file
Finished commit of software changes
SUCCESS: Software provisioned. New software will load on reboot.
Router#
Router#
Router# show version R0 provisioned
Package: Provisioning File, version: n/a, status: active
 File: bootflash:Active_Dir/packages.conf, on: RP0
 Built: n/a, by: n/a
 File SHA1 checksum: c79075780592aec1312725f4a2357a034fda2d3b
Package: rpbase, version: 03.13.00.S.154-3.S-ext, status: n/a
 File: bootflash:Active_Dir/asr1000rp2-rpbase.03.13.00.S.154-3.S-ext.pkg, on: RP0
 Built: 2013-07-25_22.55, by: mcpre
 File SHA1 checksum: 4f655c54bb95b4dfa24a0d25ebf97cf8527c69e9
Package: rpcontrol, version: 03.13.00.S.154-3.S-ext, status: n/a
 File: bootflash:Active_Dir/asr1000rp2-rpcontrol.03.13.00.S.154-3.S-ext.pkg, on: RP0/0
 Built: 2013-07-25_22.55, by: mcpre
 File SHA1 checksum: 8a0a45ea5c7a656c0eef6726174461584f182c78
Package: rpios-adventerprisek9, version: 03.13.00.S.154-3.S-ext, status: n/a
 File: bootflash:Active_Dir/asr1000rp2-rpios-adventerprisek9.03.13.00.S.154-3.S-ext.pkg,
on: RP0/0
 Built: 2013-07-25_23.00, by: mcpre
 File SHA1 checksum: 85e9eab826bfff2194ef568a56c76453625383ad2
Package: rpaccess, version: 03.13.00.S.154-3.S-ext, status: n/a
 File: bootflash:Active_Dir/asr1000rp2-rpaccess.03.13.00.S.154-3.S-ext.pkg, on: RP0/0
 Built: 2013-07-25_22.55, by: mcpre
 File SHA1 checksum: a360dff0fd76a9b1ae67cda9116c97b62f25ab09
Package: rpcontrol, version: 03.13.00.S.154-3.S-ext, status: n/a
 File: bootflash:Active_Dir/asr1000rp2-rpcontrol.03.13.00.S.154-3.S-ext.pkg, on: RP0/1
 Built: 2013-07-25_22.55, by: mcpre
 File SHA1 checksum: 8a0a45ea5c7a656c0eef6726174461584f182c78
Package: rpios-adventerprisek9, version: 03.13.00.S.154-3.S-ext, status: n/a
 File: bootflash:Active_Dir/asr1000rp2-rpios-adventerprisek9.03.13.00.S.154-3.S-ext.pkg,
on: RP0/1
 Built: 2013-07-25_23.00, by: mcpre
 File SHA1 checksum: 85e9eab826bfff2194ef568a56c76453625383ad2
Package: rpaccess, version: 03.13.00.S.154-3.S-ext, status: n/a
 File: bootflash:Active_Dir/asr1000rp2-rpaccess.03.13.00.S.154-3.S-ext.pkg, on: RP0/1
 Built: 2013-07-25_22.55, by: mcpre
 File SHA1 checksum: a360dff0fd76a9b1ae67cda9116c97b62f25ab09
Package: rpbase, version: 03.13.00.S.154-3.S-ext, status: n/a
 File: bootflash:Active_Dir/asr1000rp2-rpbase.03.13.00.S.154-3.S-ext.pkg, on: RP1
 Built: 2013-07-25_22.55, by: mcpre
 File SHA1 checksum: 4f655c54bb95b4dfa24a0d25ebf97cf8527c69e9
Package: rpcontrol, version: 03.13.00.S.154-3.S-ext, status: n/a
 File: bootflash:Active_Dir/asr1000rp2-rpcontrol.03.13.00.S.154-3.S-ext.pkg, on: RP1/0
 Built: 2013-07-25_22.55, by: mcpre
 File SHA1 checksum: 8a0a45ea5c7a656c0eef6726174461584f182c78
Package: rpios-adventerprisek9, version: 03.13.00.S.154-3.S-ext, status: n/a
 File: bootflash:Active_Dir/asr1000rp2-rpios-adventerprisek9.03.13.00.S.154-3.S-ext.pkg,
on: RP1/0
 Built: 2013-07-25_23.00, by: mcpre
 File SHA1 checksum: 85e9eab826bfff2194ef568a56c76453625383ad2
Package: rpaccess, version: 03.13.00.S.154-3.S-ext, status: n/a
 File: bootflash:Active_Dir/asr1000rp2-rpaccess.03.13.00.S.154-3.S-ext.pkg, on: RP1/0
 Built: 2013-07-25_22.55, by: mcpre
 File SHA1 checksum: a360dff0fd76a9b1ae67cda9116c97b62f25ab09
Package: rpcontrol, version: 03.13.00.S.154-3.S-ext, status: n/a
 File: bootflash:Active_Dir/asr1000rp2-rpcontrol.03.13.00.S.154-3.S-ext.pkg, on: RP1/1
 Built: 2013-07-25_22.55, by: mcpre
 File SHA1 checksum: 8a0a45ea5c7a656c0eef6726174461584f182c78
Package: rpios-adventerprisek9, version: 03.13.00.S.154-3.S-ext, status: n/a
 File: bootflash:Active_Dir/asr1000rp2-rpios-adventerprisek9.03.13.00.S.154-3.S-ext.pkg,

```

```

on: RP1/1
 Built: 2013-07-25_23.00, by: mcpre
 File SHA1 checksum: 85e9eab826bfff2194ef568a56c76453625383ad2
Package: rpaccess, version: 03.13.00.S.154-3.S-ext, status: n/a
 File: bootflash:Active_Dir/asr1000rp2-rpaccess.03.13.00.S.154-3.S-ext.pkg, on: RP1/1
 Built: 2013-07-25_22.55, by: mcpre
 File SHA1 checksum: a360dff0fd76a9b1ae67cda9116c97b62f25ab09
Package: espbase, version: 03.13.00.S.154-3.S-ext, status: n/a
 File: bootflash:Active_Dir/asr1000rp2-espbase.03.13.00.S.154-3.S-ext.pkg, on: ESP0
 Built: 2013-07-25_21.16, by: mcpre
 File SHA1 checksum: 2fe0ede1545e3f8260b7d453653e812500f0d7b0
Package: esp86base, version: 03.13.00.S.154-3.S-ext, status: n/a
 File: bootflash:Active_Dir/asr1000rp2-esp86base.03.13.00.S.154-3.S-ext.pkg, on: ESP0
 Built: 2013-07-25_22.55, by: mcpre
 File SHA1 checksum: 571b8bb3866341badd6e24de677b98409f0c789c
Package: espbase, version: 03.13.00.S.154-3.S-ext, status: n/a
 File: bootflash:Active_Dir/asr1000rp2-espbase.03.13.00.S.154-3.S-ext.pkg, on: ESP1
 Built: 2013-07-25_21.16, by: mcpre
 File SHA1 checksum: 2fe0ede1545e3f8260b7d453653e812500f0d7b0
Package: esp86base, version: 03.13.00.S.154-3.S-ext, status: n/a
 File: bootflash:Active_Dir/asr1000rp2-esp86base.03.13.00.S.154-3.S-ext.pkg, on: ESP1
 Built: 2013-07-25_22.55, by: mcpre
 File SHA1 checksum: 571b8bb3866341badd6e24de677b98409f0c789c
Package: sipbase, version: 03.13.00.S.154-3.S-ext, status: n/a
 File: bootflash:Active_Dir/asr1000rp2-sipbase.03.13.00.S.154-3.S-ext.pkg, on: SIP0
 Built: 2013-07-25_21.16, by: mcpre
 File SHA1 checksum: 3b6a4838972840a995ff22e73fd2bae910b268a7
Package: elcbase, version: 03.13.00.S.154-3.S-ext, status: n/a
 File: bootflash:Active_Dir/asr1000rp2-elcbase.03.13.00.S.154-3.S-ext.pkg, on: SIP0
 Built: 2013-07-25_21.16, by: mcpre
 File SHA1 checksum: 99f8dc925083b118626a4e82d93079050db96826
Package: sipspa, version: 03.13.00.S.154-3.S-ext, status: n/a
 File: bootflash:Active_Dir/asr1000rp2-sipspa.03.13.00.S.154-3.S-ext.pkg, on: SIP0/0
 Built: 2013-07-25_21.16, by: mcpre
 File SHA1 checksum: 6d12280b5cc33d17d752f475bf340b77ef3451ca
Package: elcspa, version: 03.13.00.S.154-3.S-ext, status: n/a
 File: bootflash:Active_Dir/asr1000rp2-elcspa.03.13.00.S.154-3.S-ext.pkg, on: SIP0/0
 Built: 2013-07-25_21.16, by: mcpre
 File SHA1 checksum: 94763274fc807489410e299a45fd73fce9d67499
Package: sipspa, version: 03.13.00.S.154-3.S-ext, status: n/a
 File: bootflash:Active_Dir/asr1000rp2-sipspa.03.13.00.S.154-3.S-ext.pkg, on: SIP0/1
 Built: 2013-07-25_21.16, by: mcpre
 File SHA1 checksum: 6d12280b5cc33d17d752f475bf340b77ef3451ca
Package: elcspa, version: 03.13.00.S.154-3.S-ext, status: n/a
 File: bootflash:Active_Dir/asr1000rp2-elcspa.03.13.00.S.154-3.S-ext.pkg, on: SIP0/1
 Built: 2013-07-25_21.16, by: mcpre
 File SHA1 checksum: 94763274fc807489410e299a45fd73fce9d67499
Package: sipspa, version: 03.13.00.S.154-3.S-ext, status: n/a
 File: bootflash:Active_Dir/asr1000rp2-sipspa.03.13.00.S.154-3.S-ext.pkg, on: SIP0/2
 Built: 2013-07-25_21.16, by: mcpre
 File SHA1 checksum: 6d12280b5cc33d17d752f475bf340b77ef3451ca
Package: elcspa, version: 03.13.00.S.154-3.S-ext, status: n/a
 File: bootflash:Active_Dir/asr1000rp2-elcspa.03.13.00.S.154-3.S-ext.pkg, on: SIP0/2
 Built: 2013-07-25_21.16, by: mcpre
 File SHA1 checksum: 94763274fc807489410e299a45fd73fce9d67499
Package: sipspa, version: 03.13.00.S.154-3.S-ext, status: n/a
 File: bootflash:Active_Dir/asr1000rp2-sipspa.03.13.00.S.154-3.S-ext.pkg, on: SIP0/3
 Built: 2013-07-25_21.16, by: mcpre
 File SHA1 checksum: 6d12280b5cc33d17d752f475bf340b77ef3451ca
Package: elcspa, version: 03.13.00.S.154-3.S-ext, status: n/a
 File: bootflash:Active_Dir/asr1000rp2-elcspa.03.13.00.S.154-3.S-ext.pkg, on: SIP0/3
 Built: 2013-07-25_21.16, by: mcpre
 File SHA1 checksum: 94763274fc807489410e299a45fd73fce9d67499
Package: sipbase, version: 03.13.00.S.154-3.S-ext, status: n/a

```

```

File: bootflash:Active_Dir/asr1000rp2-sipbase.03.13.00.S.154-3.S-ext.pkg, on: SIP1
Built: 2013-07-25_21.16, by: mcpre
File SHA1 checksum: 3b6a4838972840a995ff22e73fd2bae910b268a7
Package: elcbase, version: 03.13.00.S.154-3.S-ext, status: n/a
File: bootflash:Active_Dir/asr1000rp2-elcbase.03.13.00.S.154-3.S-ext.pkg, on: SIP1
Built: 2013-07-25_21.16, by: mcpre
File SHA1 checksum: 99f8dc925083b118626a4e82d93079050db96826
Package: sipspa, version: 03.13.00.S.154-3.S-ext, status: n/a
File: bootflash:Active_Dir/asr1000rp2-sipspa.03.13.00.S.154-3.S-ext.pkg, on: SIP1/0
Built: 2013-07-25_21.16, by: mcpre
File SHA1 checksum: 6d12280b5cc33d17d752f475bf340b77ef3451ca
Package: elcspa, version: 03.13.00.S.154-3.S-ext, status: n/a
File: bootflash:Active_Dir/asr1000rp2-elcspa.03.13.00.S.154-3.S-ext.pkg, on: SIP1/0
Built: 2013-07-25_21.16, by: mcpre
File SHA1 checksum: 94763274fc807489410e299a45fd73fce9d67499
Package: sipspa, version: 03.13.00.S.154-3.S-ext, status: n/a
File: bootflash:Active_Dir/asr1000rp2-sipspa.03.13.00.S.154-3.S-ext.pkg, on: SIP1/1
Built: 2013-07-25_21.16, by: mcpre
File SHA1 checksum: 6d12280b5cc33d17d752f475bf340b77ef3451ca
Package: elcspa, version: 03.13.00.S.154-3.S-ext, status: n/a
File: bootflash:Active_Dir/asr1000rp2-elcspa.03.13.00.S.154-3.S-ext.pkg, on: SIP1/1
Built: 2013-07-25_21.16, by: mcpre
File SHA1 checksum: 94763274fc807489410e299a45fd73fce9d67499
Package: sipspa, version: 03.13.00.S.154-3.S-ext, status: n/a
File: bootflash:Active_Dir/asr1000rp2-sipspa.03.13.00.S.154-3.S-ext.pkg, on: SIP1/2
Built: 2013-07-25_21.16, by: mcpre
File SHA1 checksum: 6d12280b5cc33d17d752f475bf340b77ef3451ca
Package: elcspa, version: 03.13.00.S.154-3.S-ext, status: n/a
File: bootflash:Active_Dir/asr1000rp2-elcspa.03.13.00.S.154-3.S-ext.pkg, on: SIP1/2
Built: 2013-07-25_21.16, by: mcpre
File SHA1 checksum: 94763274fc807489410e299a45fd73fce9d67499
Package: sipspa, version: 03.13.00.S.154-3.S-ext, status: n/a
File: bootflash:Active_Dir/asr1000rp2-sipspa.03.13.00.S.154-3.S-ext.pkg, on: SIP1/3
Built: 2013-07-25_21.16, by: mcpre
File SHA1 checksum: 6d12280b5cc33d17d752f475bf340b77ef3451ca
Package: elcspa, version: 03.13.00.S.154-3.S-ext, status: n/a
File: bootflash:Active_Dir/asr1000rp2-elcspa.03.13.00.S.154-3.S-ext.pkg, on: SIP1/3
Built: 2013-07-25_21.16, by: mcpre
File SHA1 checksum: 94763274fc807489410e299a45fd73fce9d67499
Package: sipbase, version: 03.13.00.S.154-3.S-ext, status: n/a
File: bootflash:Active_Dir/asr1000rp2-sipbase.03.13.00.S.154-3.S-ext.pkg, on: SIP2
Built: 2013-07-25_21.16, by: mcpre
File SHA1 checksum: 3b6a4838972840a995ff22e73fd2bae910b268a7
Package: elcbase, version: 03.13.00.S.154-3.S-ext, status: n/a
File: bootflash:Active_Dir/asr1000rp2-elcbase.03.13.00.S.154-3.S-ext.pkg, on: SIP2
Built: 2013-07-25_21.16, by: mcpre
File SHA1 checksum: 99f8dc925083b118626a4e82d93079050db96826
Package: sipspa, version: 03.13.00.S.154-3.S-ext, status: n/a
File: bootflash:Active_Dir/asr1000rp2-sipspa.03.13.00.S.154-3.S-ext.pkg, on: SIP2/0
Built: 2013-07-25_21.16, by: mcpre
File SHA1 checksum: 6d12280b5cc33d17d752f475bf340b77ef3451ca
Package: elcspa, version: 03.13.00.S.154-3.S-ext, status: n/a
File: bootflash:Active_Dir/asr1000rp2-elcspa.03.13.00.S.154-3.S-ext.pkg, on: SIP2/0
Built: 2013-07-25_21.16, by: mcpre
File SHA1 checksum: 94763274fc807489410e299a45fd73fce9d67499
Package: sipspa, version: 03.13.00.S.154-3.S-ext, status: n/a
File: bootflash:Active_Dir/asr1000rp2-sipspa.03.13.00.S.154-3.S-ext.pkg, on: SIP2/1
Built: 2013-07-25_21.16, by: mcpre
File SHA1 checksum: 6d12280b5cc33d17d752f475bf340b77ef3451ca
Package: elcspa, version: 03.13.00.S.154-3.S-ext, status: n/a
File: bootflash:Active_Dir/asr1000rp2-elcspa.03.13.00.S.154-3.S-ext.pkg, on: SIP2/1
Built: 2013-07-25_21.16, by: mcpre
File SHA1 checksum: 94763274fc807489410e299a45fd73fce9d67499
Package: sipspa, version: 03.13.00.S.154-3.S-ext, status: n/a

```



```
File: bootflash:Active_Dir/asr1000rp2-sipspa.03.13.00.S.154-3.S-ext.pkg, on: SIP2/2
Built: 2013-07-25_21.16, by: mcpre
File SHA1 checksum: 6d12280b5cc33d17d752f475bf340b77ef3451ca
Package: elcspa, version: 03.13.00.S.154-3.S-ext, status: n/a
File: bootflash:Active_Dir/asr1000rp2-elcspa.03.13.00.S.154-3.S-ext.pkg, on: SIP2/2
Built: 2013-07-25_21.16, by: mcpre
File SHA1 checksum: 94763274fc807489410e299a45fd73fce9d67499
Package: sipspa, version: 03.13.00.S.154-3.S-ext, status: n/a
File: bootflash:Active_Dir/asr1000rp2-sipspa.03.13.00.S.154-3.S-ext.pkg, on: SIP2/3
Built: 2013-07-25_21.16, by: mcpre
File SHA1 checksum: 6d12280b5cc33d17d752f475bf340b77ef3451ca
Package: elcspa, version: 03.13.00.S.154-3.S-ext, status: n/a
File: bootflash:Active_Dir/asr1000rp2-elcspa.03.13.00.S.154-3.S-ext.pkg, on: SIP2/3
Built: 2013-07-25_21.16, by: mcpre
File SHA1 checksum: 94763274fc807489410e299a45fd73fce9d67499
Package: sipbase, version: 03.13.00.S.154-3.S-ext, status: n/a
File: bootflash:Active_Dir/asr1000rp2-sipbase.03.13.00.S.154-3.S-ext.pkg, on: SIP3
Built: 2013-07-25_21.16, by: mcpre
File SHA1 checksum: 3b6a4838972840a995ff22e73fd2bae910b268a7
Package: elcbase, version: 03.13.00.S.154-3.S-ext, status: n/a
File: bootflash:Active_Dir/asr1000rp2-elcbase.03.13.00.S.154-3.S-ext.pkg, on: SIP3
Built: 2013-07-25_21.16, by: mcpre
File SHA1 checksum: 99f8dc925083b118626a4e82d93079050db96826
Package: sipspa, version: 03.13.00.S.154-3.S-ext, status: n/a
File: bootflash:Active_Dir/asr1000rp2-sipspa.03.13.00.S.154-3.S-ext.pkg, on: SIP3/0
Built: 2013-07-25_21.16, by: mcpre
File SHA1 checksum: 6d12280b5cc33d17d752f475bf340b77ef3451ca
Package: elcspa, version: 03.13.00.S.154-3.S-ext, status: n/a
File: bootflash:Active_Dir/asr1000rp2-elcspa.03.13.00.S.154-3.S-ext.pkg, on: SIP3/0
Built: 2013-07-25_21.16, by: mcpre
File SHA1 checksum: 94763274fc807489410e299a45fd73fce9d67499
Package: sipspa, version: 03.13.00.S.154-3.S-ext, status: n/a
File: bootflash:Active_Dir/asr1000rp2-sipspa.03.13.00.S.154-3.S-ext.pkg, on: SIP3/1
Built: 2013-07-25_21.16, by: mcpre
File SHA1 checksum: 6d12280b5cc33d17d752f475bf340b77ef3451ca
Package: elcspa, version: 03.13.00.S.154-3.S-ext, status: n/a
File: bootflash:Active_Dir/asr1000rp2-elcspa.03.13.00.S.154-3.S-ext.pkg, on: SIP3/1
Built: 2013-07-25_21.16, by: mcpre
File SHA1 checksum: 94763274fc807489410e299a45fd73fce9d67499
Package: sipspa, version: 03.13.00.S.154-3.S-ext, status: n/a
File: bootflash:Active_Dir/asr1000rp2-sipspa.03.13.00.S.154-3.S-ext.pkg, on: SIP3/2
Built: 2013-07-25_21.16, by: mcpre
File SHA1 checksum: 6d12280b5cc33d17d752f475bf340b77ef3451ca
Package: elcspa, version: 03.13.00.S.154-3.S-ext, status: n/a
File: bootflash:Active_Dir/asr1000rp2-elcspa.03.13.00.S.154-3.S-ext.pkg, on: SIP3/2
Built: 2013-07-25_21.16, by: mcpre
File SHA1 checksum: 94763274fc807489410e299a45fd73fce9d67499
Package: sipspa, version: 03.13.00.S.154-3.S-ext, status: n/a
File: bootflash:Active_Dir/asr1000rp2-sipspa.03.13.00.S.154-3.S-ext.pkg, on: SIP3/3
Built: 2013-07-25_21.16, by: mcpre
File SHA1 checksum: 6d12280b5cc33d17d752f475bf340b77ef3451ca
Package: elcspa, version: 03.13.00.S.154-3.S-ext, status: n/a
File: bootflash:Active_Dir/asr1000rp2-elcspa.03.13.00.S.154-3.S-ext.pkg, on: SIP3/3
Built: 2013-07-25_21.16, by: mcpre
File SHA1 checksum: 94763274fc807489410e299a45fd73fce9d67499
Package: sipbase, version: 03.13.00.S.154-3.S-ext, status: n/a
File: bootflash:Active_Dir/asr1000rp2-sipbase.03.13.00.S.154-3.S-ext.pkg, on: SIP4
Built: 2013-07-25_21.16, by: mcpre
File SHA1 checksum: 3b6a4838972840a995ff22e73fd2bae910b268a7
Package: elcbase, version: 03.13.00.S.154-3.S-ext, status: n/a
File: bootflash:Active_Dir/asr1000rp2-elcbase.03.13.00.S.154-3.S-ext.pkg, on: SIP4
Built: 2013-07-25_21.16, by: mcpre
File SHA1 checksum: 99f8dc925083b118626a4e82d93079050db96826
Package: sipspa, version: 03.13.00.S.154-3.S-ext, status: n/a
```

```

File: bootflash:Active_Dir/asr1000rp2-sipspa.03.13.00.S.154-3.S-ext.pkg, on: SIP4/0
Built: 2013-07-25_21.16, by: mcpre
File SHA1 checksum: 6d12280b5cc33d17d752f475bf340b77ef3451ca
Package: elcspa, version: 03.13.00.S.154-3.S-ext, status: n/a
File: bootflash:Active_Dir/asr1000rp2-elcspa.03.13.00.S.154-3.S-ext.pkg, on: SIP4/0
Built: 2013-07-25_21.16, by: mcpre
File SHA1 checksum: 94763274fc807489410e299a45fd73fce9d67499
Package: sipspa, version: 03.13.00.S.154-3.S-ext, status: n/a
File: bootflash:Active_Dir/asr1000rp2-sipspa.03.13.00.S.154-3.S-ext.pkg, on: SIP4/1
Built: 2013-07-25_21.16, by: mcpre
File SHA1 checksum: 6d12280b5cc33d17d752f475bf340b77ef3451ca
Package: elcspa, version: 03.13.00.S.154-3.S-ext, status: n/a
File: bootflash:Active_Dir/asr1000rp2-elcspa.03.13.00.S.154-3.S-ext.pkg, on: SIP4/1
Built: 2013-07-25_21.16, by: mcpre
File SHA1 checksum: 94763274fc807489410e299a45fd73fce9d67499
Package: sipspa, version: 03.13.00.S.154-3.S-ext, status: n/a
File: bootflash:Active_Dir/asr1000rp2-sipspa.03.13.00.S.154-3.S-ext.pkg, on: SIP4/2
Built: 2013-07-25_21.16, by: mcpre
File SHA1 checksum: 6d12280b5cc33d17d752f475bf340b77ef3451ca
Package: elcspa, version: 03.13.00.S.154-3.S-ext, status: n/a
File: bootflash:Active_Dir/asr1000rp2-elcspa.03.13.00.S.154-3.S-ext.pkg, on: SIP4/2
Built: 2013-07-25_21.16, by: mcpre
File SHA1 checksum: 94763274fc807489410e299a45fd73fce9d67499
Package: sipspa, version: 03.13.00.S.154-3.S-ext, status: n/a
File: bootflash:Active_Dir/asr1000rp2-sipspa.03.13.00.S.154-3.S-ext.pkg, on: SIP4/3
Built: 2013-07-25_21.16, by: mcpre
File SHA1 checksum: 6d12280b5cc33d17d752f475bf340b77ef3451ca
Package: elcspa, version: 03.13.00.S.154-3.S-ext, status: n/a
File: bootflash:Active_Dir/asr1000rp2-elcspa.03.13.00.S.154-3.S-ext.pkg, on: SIP4/3
Built: 2013-07-25_21.16, by: mcpre
File SHA1 checksum: 94763274fc807489410e299a45fd73fce9d67499
Package: sipbase, version: 03.13.00.S.154-3.S-ext, status: n/a
File: bootflash:Active_Dir/asr1000rp2-sipbase.03.13.00.S.154-3.S-ext.pkg, on: SIP5
Built: 2013-07-25_21.16, by: mcpre
File SHA1 checksum: 3b6a4838972840a995ff22e73fd2bae910b268a7
Package: elcbase, version: 03.13.00.S.154-3.S-ext, status: n/a
File: bootflash:Active_Dir/asr1000rp2-elcbase.03.13.00.S.154-3.S-ext.pkg, on: SIP5
Built: 2013-07-25_21.16, by: mcpre
File SHA1 checksum: 99f8dc925083b118626a4e82d93079050db96826
Package: sipspa, version: 03.13.00.S.154-3.S-ext, status: n/a
File: bootflash:Active_Dir/asr1000rp2-sipspa.03.13.00.S.154-3.S-ext.pkg, on: SIP5/0
Built: 2013-07-25_21.16, by: mcpre
File SHA1 checksum: 6d12280b5cc33d17d752f475bf340b77ef3451ca
Package: elcspa, version: 03.13.00.S.154-3.S-ext, status: n/a
File: bootflash:Active_Dir/asr1000rp2-elcspa.03.13.00.S.154-3.S-ext.pkg, on: SIP5/0
Built: 2013-07-25_21.16, by: mcpre
File SHA1 checksum: 94763274fc807489410e299a45fd73fce9d67499
Package: sipspa, version: 03.13.00.S.154-3.S-ext, status: n/a
File: bootflash:Active_Dir/asr1000rp2-sipspa.03.13.00.S.154-3.S-ext.pkg, on: SIP5/1
Built: 2013-07-25_21.16, by: mcpre
File SHA1 checksum: 6d12280b5cc33d17d752f475bf340b77ef3451ca
Package: elcspa, version: 03.13.00.S.154-3.S-ext, status: n/a
File: bootflash:Active_Dir/asr1000rp2-elcspa.03.13.00.S.154-3.S-ext.pkg, on: SIP5/1
Built: 2013-07-25_21.16, by: mcpre
File SHA1 checksum: 94763274fc807489410e299a45fd73fce9d67499
Package: sipspa, version: 03.13.00.S.154-3.S-ext, status: n/a
File: bootflash:Active_Dir/asr1000rp2-sipspa.03.13.00.S.154-3.S-ext.pkg, on: SIP5/2
Built: 2013-07-25_21.16, by: mcpre
File SHA1 checksum: 6d12280b5cc33d17d752f475bf340b77ef3451ca
Package: elcspa, version: 03.13.00.S.154-3.S-ext, status: n/a
File: bootflash:Active_Dir/asr1000rp2-elcspa.03.13.00.S.154-3.S-ext.pkg, on: SIP5/2
Built: 2013-07-25_21.16, by: mcpre
File SHA1 checksum: 94763274fc807489410e299a45fd73fce9d67499
Package: sipspa, version: 03.13.00.S.154-3.S-ext, status: n/a

```

```

File: bootflash:Active_Dir/asr1000rp2-sipspa.03.13.00.S.154-3.S-ext.pkg, on: SIP5/3
Built: 2013-07-25_21.16, by: mcpre
File SHA1 checksum: 6d12280b5cc33d17d752f475bf340b77ef3451ca
Package: elcspa, version: 03.13.00.S.154-3.S-ext, status: n/a
File: bootflash:Active_Dir/asr1000rp2-elcspa.03.13.00.S.154-3.S-ext.pkg, on: SIP5/3
Built: 2013-07-25_21.16, by: mcpre
File SHA1 checksum: 94763274fc807489410e299a45fd73fce9d67499
Router#
Router#
Router# show version R0 provisioned
Package: Provisioning File, version: n/a, status: active
File: bootflash:Active_Dir/packages.conf, on: RP0
Built: n/a, by: n/a
File SHA1 checksum: c79075780592aec1312725f4a2357a034fda2d3b
Package: rpbase, version: 03.12.01.S.154-2.S, status: active
File: bootflash:Active_Dir/asr1000rp2-rpbase.03.12.01.S.154-2.S.pkg, on: RP0
Built: 2013-03-25_18.48, by: mcpre
File SHA1 checksum: 3a9675142898cfac350d4e42f0e37bd9f4e48538
Package: rpcontrol, version: 03.12.01.S.154-2.S, status: active
File: bootflash:Active_Dir/asr1000rp2-rpcontrol.03.12.01.S.154-2.S.pkg, on: RP0/0
Built: 2013-03-25_18.48, by: mcpre
File SHA1 checksum: 87b11f863f67fdf2610ee0769b929baab4c3efad
Package: rpios-adventerprisek9, version: 03.12.01.S.154-2.S, status: active
File: bootflash:Active_Dir/asr1000rp2-rpios-adventerprisek9.03.12.01.S.154-2.S.pkg, on:
RP0/0
Built: 2013-03-25_18.51, by: mcpre
File SHA1 checksum: b487136319da0a327844d353c77e533c53c56053
Package: rpaccess, version: 03.12.01.S.154-2.S, status: active
File: bootflash:Active_Dir/asr1000rp2-rpaccess.03.12.01.S.154-2.S.pkg, on: RP0/0
Built: 2013-03-25_18.48, by: mcpre
File SHA1 checksum: 032bea36f74b19977b363243c99f02413b54104d
Package: rpcontrol, version: 03.12.01.S.154-2.S, status: n/a
File: bootflash:Active_Dir/asr1000rp2-rpcontrol.03.12.01.S.154-2.S.pkg, on: RP0/1
Built: 2013-03-25_18.48, by: mcpre
File SHA1 checksum: 87b11f863f67fdf2610ee0769b929baab4c3efad
Package: rpios-adventerprisek9, version: 03.12.01.S.154-2.S, status: n/a
File: bootflash:Active_Dir/asr1000rp2-rpios-adventerprisek9.03.12.01.S.154-2.S.pkg, on:
RP0/1
Built: 2013-03-25_18.51, by: mcpre
File SHA1 checksum: b487136319da0a327844d353c77e533c53c56053
Package: rpaccess, version: 03.12.01.S.154-2.S, status: n/a
File: bootflash:Active_Dir/asr1000rp2-rpaccess.03.12.01.S.154-2.S.pkg, on: RP0/1
Built: 2013-03-25_18.48, by: mcpre
File SHA1 checksum: 032bea36f74b19977b363243c99f02413b54104d
Package: rpbase, version: 03.12.01.S.154-2.S, status: n/a
File: bootflash:Active_Dir/asr1000rp2-rpbase.03.12.01.S.154-2.S.pkg, on: RP1
Built: 2013-03-25_18.48, by: mcpre
File SHA1 checksum: 3a9675142898cfac350d4e42f0e37bd9f4e48538
Package: rpcontrol, version: 03.12.01.S.154-2.S, status: n/a
File: bootflash:Active_Dir/asr1000rp2-rpcontrol.03.12.01.S.154-2.S.pkg, on: RP1/0
Built: 2013-03-25_18.48, by: mcpre
File SHA1 checksum: 87b11f863f67fdf2610ee0769b929baab4c3efad
Package: rpios-adventerprisek9, version: 03.12.01.S.154-2.S, status: n/a
File: bootflash:Active_Dir/asr1000rp2-rpios-adventerprisek9.03.12.01.S.154-2.S.pkg, on:
RP1/0
Built: 2013-03-25_18.51, by: mcpre
File SHA1 checksum: b487136319da0a327844d353c77e533c53c56053
Package: rpaccess, version: 03.12.01.S.154-2.S, status: n/a
File: bootflash:Active_Dir/asr1000rp2-rpaccess.03.12.01.S.154-2.S.pkg, on: RP1/0
Built: 2013-03-25_18.48, by: mcpre
File SHA1 checksum: 032bea36f74b19977b363243c99f02413b54104d
Package: rpcontrol, version: 03.12.01.S.154-2.S, status: n/a
File: bootflash:Active_Dir/asr1000rp2-rpcontrol.03.12.01.S.154-2.S.pkg, on: RP1/1
Built: 2013-03-25_18.48, by: mcpre

```

## Examples

```

File SHA1 checksum: 87b11f863f67fdf2610ee0769b929baab4c3efad
Package: rpios-adventerprisek9, version: 03.12.01.S.154-2.S, status: n/a
File: bootflash:Active_Dir/asr1000rp2-rpios-adventerprisek9.03.12.01.S.154-2.S.pkg, on:
RP1/1
 Built: 2013-03-25_18.51, by: mcpre
 File SHA1 checksum: b487136319da0a327844d353c77e533c53c56053
Package: rpaccess, version: 03.12.01.S.154-2.S, status: n/a
File: bootflash:Active_Dir/asr1000rp2-rpaccess.03.12.01.S.154-2.S.pkg, on: RP1/1
 Built: 2013-03-25_18.48, by: mcpre
 File SHA1 checksum: 032bea36f74b19977b363243c99f02413b54104d
Package: espbase, version: 03.13.00.S.154-3.S-ext, status: inactive
File: bootflash:Active_Dir/asr1000rp2-espbase.03.13.00.S.154-3.S-ext.pkg, on: ESP0
 Built: 2013-07-25_21.16, by: mcpre
 File SHA1 checksum: 2fe0ede1545e3f8260b7d453653e812500f0d7b0
Package: esp86base, version: 03.13.00.S.154-3.S-ext, status: active
File: bootflash:Active_Dir/asr1000rp2-esp86base.03.13.00.S.154-3.S-ext.pkg, on: ESP0
 Built: 2013-07-25_22.55, by: mcpre
 File SHA1 checksum: 571b8bb3866341badd6e24de677b98409f0c789c
Package: espbase, version: 03.13.00.S.154-3.S-ext, status: inactive
File: bootflash:Active_Dir/asr1000rp2-espbase.03.13.00.S.154-3.S-ext.pkg, on: ESP1
 Built: 2013-07-25_21.16, by: mcpre
 File SHA1 checksum: 2fe0ede1545e3f8260b7d453653e812500f0d7b0
Package: esp86base, version: 03.13.00.S.154-3.S-ext, status: active
File: bootflash:Active_Dir/asr1000rp2-esp86base.03.13.00.S.154-3.S-ext.pkg, on: ESP1
 Built: 2013-07-25_22.55, by: mcpre
 File SHA1 checksum: 571b8bb3866341badd6e24de677b98409f0c789c
Package: sipbase, version: 03.12.01.S.154-2.S, status: inactive
File: bootflash:Active_Dir/asr1000rp2-sipbase.03.12.01.S.154-2.S.pkg, on: SIP0
 Built: 2013-03-25_17.28, by: mcpre
 File SHA1 checksum: fb815b5cbaf5fd20a0a0e2aeabd2687347c6921d
Package: elcbase, version: 03.12.01.S.154-2.S, status: inactive
File: bootflash:Active_Dir/asr1000rp2-elcbase.03.12.01.S.154-2.S.pkg, on: SIP0
 Built: 2013-03-25_17.28, by: mcpre
 File SHA1 checksum: fb1d6abd055b191909bc78ccac23b964de15ab8e
Package: sipspa, version: 03.12.01.S.154-2.S, status: n/a
File: bootflash:Active_Dir/asr1000rp2-sipspa.03.12.01.S.154-2.S.pkg, on: SIP0/0
 Built: 2013-03-25_17.28, by: mcpre
 File SHA1 checksum: 644364aeea8ccebddd4af5b8d29367db50fc82b17
Package: elcspa, version: 03.12.01.S.154-2.S, status: n/a
File: bootflash:Active_Dir/asr1000rp2-elcspa.03.12.01.S.154-2.S.pkg, on: SIP0/0
 Built: 2013-03-25_17.28, by: mcpre
 File SHA1 checksum: 2e6b6b1949261873ce5ce189ec19440abffd71c6
Package: sipspa, version: 03.12.01.S.154-2.S, status: n/a
File: bootflash:Active_Dir/asr1000rp2-sipspa.03.12.01.S.154-2.S.pkg, on: SIP0/1
 Built: 2013-03-25_17.28, by: mcpre
 File SHA1 checksum: 644364aeea8ccebddd4af5b8d29367db50fc82b17
Package: elcspa, version: 03.12.01.S.154-2.S, status: n/a
File: bootflash:Active_Dir/asr1000rp2-elcspa.03.12.01.S.154-2.S.pkg, on: SIP0/1
 Built: 2013-03-25_17.28, by: mcpre
 File SHA1 checksum: 2e6b6b1949261873ce5ce189ec19440abffd71c6
Package: sipspa, version: 03.12.01.S.154-2.S, status: n/a
File: bootflash:Active_Dir/asr1000rp2-sipspa.03.12.01.S.154-2.S.pkg, on: SIP0/2
 Built: 2013-03-25_17.28, by: mcpre
 File SHA1 checksum: 644364aeea8ccebddd4af5b8d29367db50fc82b17
Package: elcspa, version: 03.12.01.S.154-2.S, status: n/a
File: bootflash:Active_Dir/asr1000rp2-elcspa.03.12.01.S.154-2.S.pkg, on: SIP0/2
 Built: 2013-03-25_17.28, by: mcpre
 File SHA1 checksum: 2e6b6b1949261873ce5ce189ec19440abffd71c6
Package: sipspa, version: 03.12.01.S.154-2.S, status: n/a
File: bootflash:Active_Dir/asr1000rp2-sipspa.03.12.01.S.154-2.S.pkg, on: SIP0/3
 Built: 2013-03-25_17.28, by: mcpre
 File SHA1 checksum: 644364aeea8ccebddd4af5b8d29367db50fc82b17
Package: elcspa, version: 03.12.01.S.154-2.S, status: n/a
File: bootflash:Active_Dir/asr1000rp2-elcspa.03.12.01.S.154-2.S.pkg, on: SIP0/3

```

```

 Built: 2013-03-25_17.28, by: mcpre
 File SHA1 checksum: 2e6b6b1949261873ce5ce189ec19440abffd71c6
Package: sipbase, version: 03.12.01.S.154-2.S, status: inactive
 File: bootflash:Active_Dir/asr1000rp2-sipbase.03.12.01.S.154-2.S.pkg, on: SIP1
 Built: 2013-03-25_17.28, by: mcpre
 File SHA1 checksum: fb815b5cbaf5fd20a0a0e2aeabd2687347c6921d
Package: elcbase, version: 03.12.01.S.154-2.S, status: inactive
 File: bootflash:Active_Dir/asr1000rp2-elcbase.03.12.01.S.154-2.S.pkg, on: SIP1
 Built: 2013-03-25_17.28, by: mcpre
 File SHA1 checksum: fb1d6abd055b191909bc78ccac23b964de15ab8e
Package: sipspa, version: 03.12.01.S.154-2.S, status: n/a
 File: bootflash:Active_Dir/asr1000rp2-sipspa.03.12.01.S.154-2.S.pkg, on: SIP1/0
 Built: 2013-03-25_17.28, by: mcpre
 File SHA1 checksum: 644364aeea8ccebddd4af5b8d29367db50fc82b17
Package: elcspa, version: 03.12.01.S.154-2.S, status: n/a
 File: bootflash:Active_Dir/asr1000rp2-elcspa.03.12.01.S.154-2.S.pkg, on: SIP1/0
 Built: 2013-03-25_17.28, by: mcpre
 File SHA1 checksum: 2e6b6b1949261873ce5ce189ec19440abffd71c6
Package: sipspa, version: 03.12.01.S.154-2.S, status: n/a
 File: bootflash:Active_Dir/asr1000rp2-sipspa.03.12.01.S.154-2.S.pkg, on: SIP1/1
 Built: 2013-03-25_17.28, by: mcpre
 File SHA1 checksum: 644364aeea8ccebddd4af5b8d29367db50fc82b17
Package: elcspa, version: 03.12.01.S.154-2.S, status: n/a
 File: bootflash:Active_Dir/asr1000rp2-elcspa.03.12.01.S.154-2.S.pkg, on: SIP1/1
 Built: 2013-03-25_17.28, by: mcpre
 File SHA1 checksum: 2e6b6b1949261873ce5ce189ec19440abffd71c6
Package: sipspa, version: 03.12.01.S.154-2.S, status: n/a
 File: bootflash:Active_Dir/asr1000rp2-sipspa.03.12.01.S.154-2.S.pkg, on: SIP1/2
 Built: 2013-03-25_17.28, by: mcpre
 File SHA1 checksum: 644364aeea8ccebddd4af5b8d29367db50fc82b17
Package: elcspa, version: 03.12.01.S.154-2.S, status: n/a
 File: bootflash:Active_Dir/asr1000rp2-elcspa.03.12.01.S.154-2.S.pkg, on: SIP1/2
 Built: 2013-03-25_17.28, by: mcpre
 File SHA1 checksum: 2e6b6b1949261873ce5ce189ec19440abffd71c6
Package: sipspa, version: 03.12.01.S.154-2.S, status: n/a
 File: bootflash:Active_Dir/asr1000rp2-sipspa.03.12.01.S.154-2.S.pkg, on: SIP1/3
 Built: 2013-03-25_17.28, by: mcpre
 File SHA1 checksum: 644364aeea8ccebddd4af5b8d29367db50fc82b17
Package: elcspa, version: 03.12.01.S.154-2.S, status: n/a
 File: bootflash:Active_Dir/asr1000rp2-elcspa.03.12.01.S.154-2.S.pkg, on: SIP1/3
 Built: 2013-03-25_17.28, by: mcpre
 File SHA1 checksum: 2e6b6b1949261873ce5ce189ec19440abffd71c6
Package: sipbase, version: 03.13.00.S.154-3.S-ext, status: active
 File: bootflash:Active_Dir/asr1000rp2-sipbase.03.13.00.S.154-3.S-ext.pkg, on: SIP2
 Built: 2013-07-25_21.16, by: mcpre
 File SHA1 checksum: 3b6a4838972840a995ff22e73fd2bae910b268a7
Package: elcbase, version: 03.12.01.S.154-2.S, status: inactive
 File: bootflash:Active_Dir/asr1000rp2-elcbase.03.12.01.S.154-2.S.pkg, on: SIP2
 Built: 2013-03-25_17.28, by: mcpre
 File SHA1 checksum: fb1d6abd055b191909bc78ccac23b964de15ab8e
Package: sipspa, version: 03.13.00.S.154-3.S-ext, status: active
 File: bootflash:Active_Dir/asr1000rp2-sipspa.03.13.00.S.154-3.S-ext.pkg, on: SIP2/0
 Built: 2013-07-25_21.16, by: mcpre
 File SHA1 checksum: 6d12280b5cc33d17d752f475bf340b77ef3451ca
Package: elcspa, version: 03.12.01.S.154-2.S, status: inactive
 File: bootflash:Active_Dir/asr1000rp2-elcspa.03.12.01.S.154-2.S.pkg, on: SIP2/0
 Built: 2013-03-25_17.28, by: mcpre
 File SHA1 checksum: 2e6b6b1949261873ce5ce189ec19440abffd71c6
Package: sipspa, version: 03.13.00.S.154-3.S-ext, status: active
 File: bootflash:Active_Dir/asr1000rp2-sipspa.03.13.00.S.154-3.S-ext.pkg, on: SIP2/1
 Built: 2013-07-25_21.16, by: mcpre
 File SHA1 checksum: 6d12280b5cc33d17d752f475bf340b77ef3451ca
Package: elcspa, version: 03.12.01.S.154-2.S, status: inactive
 File: bootflash:Active_Dir/asr1000rp2-elcspa.03.12.01.S.154-2.S.pkg, on: SIP2/1

```

## Examples

```

 Built: 2013-03-25_17.28, by: mcpre
 File SHA1 checksum: 2e6b6b1949261873ce5ce189ec19440abffd71c6
Package: sipspa, version: 03.13.00.S.154-3.S-ext, status: active
 File: bootflash:Active_Dir/asr1000rp2-sipspa.03.13.00.S.154-3.S-ext.pkg, on: SIP2/2
 Built: 2013-07-25_21.16, by: mcpre
 File SHA1 checksum: 6d12280b5cc33d17d752f475bf340b77ef3451ca
Package: elcspa, version: 03.12.01.S.154-2.S, status: inactive
 File: bootflash:Active_Dir/asr1000rp2-elcspa.03.12.01.S.154-2.S.pkg, on: SIP2/2
 Built: 2013-03-25_17.28, by: mcpre
 File SHA1 checksum: 2e6b6b1949261873ce5ce189ec19440abffd71c6
Package: sipspa, version: 03.13.00.S.154-3.S-ext, status: active
 File: bootflash:Active_Dir/asr1000rp2-sipspa.03.13.00.S.154-3.S-ext.pkg, on: SIP2/3
 Built: 2013-07-25_21.16, by: mcpre
 File SHA1 checksum: 6d12280b5cc33d17d752f475bf340b77ef3451ca
Package: elcspa, version: 03.12.01.S.154-2.S, status: inactive
 File: bootflash:Active_Dir/asr1000rp2-elcspa.03.12.01.S.154-2.S.pkg, on: SIP2/3
 Built: 2013-03-25_17.28, by: mcpre
 File SHA1 checksum: 2e6b6b1949261873ce5ce189ec19440abffd71c6
Package: sipbase, version: 03.12.01.S.154-2.S, status: inactive
 File: bootflash:Active_Dir/asr1000rp2-sipbase.03.12.01.S.154-2.S.pkg, on: SIP3
 Built: 2013-03-25_17.28, by: mcpre
 File SHA1 checksum: fb815b5cbaf5fd20a0a0e2aeabd2687347c6921d
Package: elcbase, version: 03.12.01.S.154-2.S, status: inactive
 File: bootflash:Active_Dir/asr1000rp2-elcbase.03.12.01.S.154-2.S.pkg, on: SIP3
 Built: 2013-03-25_17.28, by: mcpre
 File SHA1 checksum: fb1d6abd055b191909bc78ccac23b964de15ab8e
Package: sipspa, version: 03.12.01.S.154-2.S, status: n/a
 File: bootflash:Active_Dir/asr1000rp2-sipspa.03.12.01.S.154-2.S.pkg, on: SIP3/0
 Built: 2013-03-25_17.28, by: mcpre
 File SHA1 checksum: 644364aeea8ccebddd4af5b8d29367db50fc82b17
Package: elcspa, version: 03.12.01.S.154-2.S, status: n/a
 File: bootflash:Active_Dir/asr1000rp2-elcspa.03.12.01.S.154-2.S.pkg, on: SIP3/0
 Built: 2013-03-25_17.28, by: mcpre
 File SHA1 checksum: 2e6b6b1949261873ce5ce189ec19440abffd71c6
Package: sipspa, version: 03.12.01.S.154-2.S, status: n/a
 File: bootflash:Active_Dir/asr1000rp2-sipspa.03.12.01.S.154-2.S.pkg, on: SIP3/1
 Built: 2013-03-25_17.28, by: mcpre
 File SHA1 checksum: 644364aeea8ccebddd4af5b8d29367db50fc82b17
Package: elcspa, version: 03.12.01.S.154-2.S, status: n/a
 File: bootflash:Active_Dir/asr1000rp2-elcspa.03.12.01.S.154-2.S.pkg, on: SIP3/1
 Built: 2013-03-25_17.28, by: mcpre
 File SHA1 checksum: 2e6b6b1949261873ce5ce189ec19440abffd71c6
Package: sipspa, version: 03.12.01.S.154-2.S, status: n/a
 File: bootflash:Active_Dir/asr1000rp2-sipspa.03.12.01.S.154-2.S.pkg, on: SIP3/2
 Built: 2013-03-25_17.28, by: mcpre
 File SHA1 checksum: 644364aeea8ccebddd4af5b8d29367db50fc82b17
Package: elcspa, version: 03.12.01.S.154-2.S, status: n/a
 File: bootflash:Active_Dir/asr1000rp2-elcspa.03.12.01.S.154-2.S.pkg, on: SIP3/2
 Built: 2013-03-25_17.28, by: mcpre
 File SHA1 checksum: 2e6b6b1949261873ce5ce189ec19440abffd71c6
Package: sipspa, version: 03.12.01.S.154-2.S, status: n/a
 File: bootflash:Active_Dir/asr1000rp2-sipspa.03.12.01.S.154-2.S.pkg, on: SIP3/3
 Built: 2013-03-25_17.28, by: mcpre
 File SHA1 checksum: 644364aeea8ccebddd4af5b8d29367db50fc82b17
Package: elcspa, version: 03.12.01.S.154-2.S, status: n/a
 File: bootflash:Active_Dir/asr1000rp2-elcspa.03.12.01.S.154-2.S.pkg, on: SIP3/3
 Built: 2013-03-25_17.28, by: mcpre
 File SHA1 checksum: 2e6b6b1949261873ce5ce189ec19440abffd71c6
Package: sipbase, version: 03.12.01.S.154-2.S, status: inactive
 File: bootflash:Active_Dir/asr1000rp2-sipbase.03.12.01.S.154-2.S.pkg, on: SIP4
 Built: 2013-03-25_17.28, by: mcpre
 File SHA1 checksum: fb815b5cbaf5fd20a0a0e2aeabd2687347c6921d
Package: elcbase, version: 03.13.00.S.154-3.S-ext, status: active
 File: bootflash:Active_Dir/asr1000rp2-elcbase.03.13.00.S.154-3.S-ext.pkg, on: SIP4

```

```

Built: 2013-07-25_21.16, by: mcpre
File SHA1 checksum: 99f8dc925083b118626a4e82d93079050db96826
Package: sipspa, version: 03.12.01.S.154-2.S, status: inactive
File: bootflash:Active_Dir/asr1000rp2-sipspa.03.12.01.S.154-2.S.pkg, on: SIP4/0
Built: 2013-03-25_17.28, by: mcpre
File SHA1 checksum: 644364aeea8ccebddd4af5b8d29367db50fc82b17
Package: elcspa, version: 03.13.00.S.154-3.S-ext, status: active
File: bootflash:Active_Dir/asr1000rp2-elcspa.03.13.00.S.154-3.S-ext.pkg, on: SIP4/0
Built: 2013-07-25_21.16, by: mcpre
File SHA1 checksum: 94763274fc807489410e299a45fd73fce9d67499
Package: sipspa, version: 03.12.01.S.154-2.S, status: n/a
File: bootflash:Active_Dir/asr1000rp2-sipspa.03.12.01.S.154-2.S.pkg, on: SIP4/1
Built: 2013-03-25_17.28, by: mcpre
File SHA1 checksum: 644364aeea8ccebddd4af5b8d29367db50fc82b17
Package: elcspa, version: 03.13.00.S.154-3.S-ext, status: n/a
File: bootflash:Active_Dir/asr1000rp2-elcspa.03.13.00.S.154-3.S-ext.pkg, on: SIP4/1
Built: 2013-07-25_21.16, by: mcpre
File SHA1 checksum: 94763274fc807489410e299a45fd73fce9d67499
Package: sipspa, version: 03.12.01.S.154-2.S, status: n/a
File: bootflash:Active_Dir/asr1000rp2-sipspa.03.12.01.S.154-2.S.pkg, on: SIP4/2
Built: 2013-03-25_17.28, by: mcpre
File SHA1 checksum: 644364aeea8ccebddd4af5b8d29367db50fc82b17
Package: elcspa, version: 03.13.00.S.154-3.S-ext, status: n/a
File: bootflash:Active_Dir/asr1000rp2-elcspa.03.13.00.S.154-3.S-ext.pkg, on: SIP4/2
Built: 2013-07-25_21.16, by: mcpre
File SHA1 checksum: 94763274fc807489410e299a45fd73fce9d67499
Package: sipspa, version: 03.12.01.S.154-2.S, status: n/a
File: bootflash:Active_Dir/asr1000rp2-sipspa.03.12.01.S.154-2.S.pkg, on: SIP4/3
Built: 2013-03-25_17.28, by: mcpre
File SHA1 checksum: 644364aeea8ccebddd4af5b8d29367db50fc82b17
Package: elcspa, version: 03.13.00.S.154-3.S-ext, status: n/a
File: bootflash:Active_Dir/asr1000rp2-elcspa.03.13.00.S.154-3.S-ext.pkg, on: SIP4/3
Built: 2013-07-25_21.16, by: mcpre
File SHA1 checksum: 94763274fc807489410e299a45fd73fce9d67499
Package: sipbase, version: 03.12.01.S.154-2.S, status: inactive
File: bootflash:Active_Dir/asr1000rp2-sipbase.03.12.01.S.154-2.S.pkg, on: SIP5
Built: 2013-03-25_17.28, by: mcpre
File SHA1 checksum: fb815b5cbaf5fd20a0a0e2aeabd2687347c6921d
Package: elcbase, version: 03.12.01.S.154-2.S, status: inactive
File: bootflash:Active_Dir/asr1000rp2-elcbase.03.12.01.S.154-2.S.pkg, on: SIP5
Built: 2013-03-25_17.28, by: mcpre
File SHA1 checksum: fb1d6abd055b191909bc78ccac23b964de15ab8e
Package: sipspa, version: 03.12.01.S.154-2.S, status: n/a
File: bootflash:Active_Dir/asr1000rp2-sipspa.03.12.01.S.154-2.S.pkg, on: SIP5/0
Built: 2013-03-25_17.28, by: mcpre
File SHA1 checksum: 644364aeea8ccebddd4af5b8d29367db50fc82b17
Package: elcspa, version: 03.12.01.S.154-2.S, status: n/a
File: bootflash:Active_Dir/asr1000rp2-elcspa.03.12.01.S.154-2.S.pkg, on: SIP5/0
Built: 2013-03-25_17.28, by: mcpre
File SHA1 checksum: 2e6b6b1949261873ce5ce189ec19440abffd71c6
Package: sipspa, version: 03.12.01.S.154-2.S, status: n/a
File: bootflash:Active_Dir/asr1000rp2-sipspa.03.12.01.S.154-2.S.pkg, on: SIP5/1
Built: 2013-03-25_17.28, by: mcpre
File SHA1 checksum: 644364aeea8ccebddd4af5b8d29367db50fc82b17
Package: elcspa, version: 03.12.01.S.154-2.S, status: n/a
File: bootflash:Active_Dir/asr1000rp2-elcspa.03.12.01.S.154-2.S.pkg, on: SIP5/1
Built: 2013-03-25_17.28, by: mcpre
File SHA1 checksum: 2e6b6b1949261873ce5ce189ec19440abffd71c6
Package: sipspa, version: 03.12.01.S.154-2.S, status: n/a
File: bootflash:Active_Dir/asr1000rp2-sipspa.03.12.01.S.154-2.S.pkg, on: SIP5/2
Built: 2013-03-25_17.28, by: mcpre
File SHA1 checksum: 644364aeea8ccebddd4af5b8d29367db50fc82b17
Package: elcspa, version: 03.12.01.S.154-2.S, status: n/a
File: bootflash:Active_Dir/asr1000rp2-elcspa.03.12.01.S.154-2.S.pkg, on: SIP5/2

```

```

 Built: 2013-03-25_17.28, by: mcpre
 File SHA1 checksum: 2e6b6b1949261873ce5ce189ec19440abffd71c6
Package: sipspa, version: 03.12.01.S.154-2.S, status: n/a
 File: bootflash:Active_Dir/asr1000rp2-sipspa.03.12.01.S.154-2.S.pkg, on: SIP5/3
 Built: 2013-03-25_17.28, by: mcpre
 File SHA1 checksum: 644364aeea8ccebddd4af5b8d29367db50fc82b17
Package: elcspa, version: 03.12.01.S.154-2.S, status: n/a
 File: bootflash:Active_Dir/asr1000rp2-elcspa.03.12.01.S.154-2.S.pkg, on: SIP5/3
 Built: 2013-03-25_17.28, by: mcpre
 File SHA1 checksum: 2e6b6b1949261873ce5ce189ec19440abffd71c6
Router#
Router# redundancy force-switchover
Proceed with switchover to standby RP? [confirm]
<output removed for brevity>
Router#
Router# request platform software package clean
Cleaning up unnecessary package files
No path specified, will use booted path bootflash:Active_Dir/packages.conf
Cleaning bootflash:Active_Dir
 Scanning boot directory for packages ... done.
 Preparing packages list to delete ...
 asr1000rp2-elcbase.03.13.00.S.154-3.S-ext.pkg
 File is in use, will not delete.
 asr1000rp2-elcspa.03.13.00.S.154-3.S-ext.pkg
 File is in use, will not delete.
 asr1000rp2-espbase.03.13.00.S.154-3.S-ext.pkg
 File is in use, will not delete.
 asr1000rp2-esp86base.03.13.00.S.154-3.S-ext.pkg
 File is in use, will not delete.
 asr1000rp2-rpaccess.03.13.00.S.154-3.S-ext.pkg
 File is in use, will not delete.
 asr1000rp2-rpbase.03.13.00.S.154-3.S-ext.pkg
 File is in use, will not delete.
 asr1000rp2-rpcontrol.03.13.00.S.154-3.S-ext.pkg
 File is in use, will not delete.
 asr1000rp2-rpios-adventerprisek9.03.13.00.S.154-3.S-ext.pkg
 File is in use, will not delete.
 asr1000rp2-sipbase.03.13.00.S.154-3.S-ext.pkg
 File is in use, will not delete.
 asr1000rp2-sipspa.03.13.00.S.154-3.S-ext.pkg
 File is in use, will not delete.
 packages.conf
 File is in use, will not delete.
done.

Files that will be deleted:
asr1000rp2-elcbase.03.12.01.S.154-2.S.pkg
asr1000rp2-elcspa.03.12.01.S.154-2.S.pkg
asr1000rp2-espbase.03.12.01.S.154-2.S.pkg
asr1000rp2-esp86base.03.12.01.S.154-2.S.pkg
asr1000rp2-packages-adventerprisek9.03.12.01.S.154-2.S.conf
asr1000rp2-rpaccess.03.12.01.S.154-2.S.pkg
asr1000rp2-rpbase.03.12.01.S.154-2.S.pkg
asr1000rp2-rpcontrol.03.12.01.S.154-2.S.pkg
asr1000rp2-rpios-adventerprisek9.03.12.01.S.154-2.S.pkg
asr1000rp2-sipbase.03.12.01.S.154-2.S.pkg
asr1000rp2-sipspa.03.12.01.S.154-2.S.pkg
packages.conf.00-
Do you want to proceed? [confirm]y
Deleting file bootflash:Active_Dir/asr1000rp2-elcbase.03.12.01.S.154-2.S.pkg ... done.
Deleting file bootflash:Active_Dir/asr1000rp2-elcspa.03.12.01.S.154-2.S.pkg ... done.
Deleting file bootflash:Active_Dir/asr1000rp2-espbase.03.12.01.S.154-2.S.pkg ... done.
Deleting file bootflash:Active_Dir/asr1000rp2-esp86base.03.12.01.S.154-2.S.pkg ... done.

```



```

Deleting file
bootflash:Active_Dir/asr1000rp2-packages-adventerprisek9.03.12.01.S.154-2.S.conf ... done.
Deleting file bootflash:Active_Dir/asr1000rp2-rpaccess.03.12.01.S.154-2.S.pkg ... done.
Deleting file bootflash:Active_Dir/asr1000rp2-rpbase.03.12.01.S.154-2.S.pkg ... done.
Deleting file bootflash:Active_Dir/asr1000rp2-rpcontrol.03.12.01.S.154-2.S.pkg ... done.
Deleting file bootflash:Active_Dir/asr1000rp2-rpios-adventerprisek9.03.12.01.S.154-2.S.pkg
... done.
Deleting file bootflash:Active_Dir/asr1000rp2-sipbase.03.12.01.S.154-2.S.pkg ... done.
Deleting file bootflash:Active_Dir/asr1000rp2-sipsa.03.12.01.S.154-2.S.pkg ... done.
Deleting file bootflash:Active_Dir/packages.conf.00- ... done.
SUCCESS: Files deleted.

```

## Using ISSU to Upgrade Subpackages on a Cisco ASR 1006 Router or Cisco ASR 1013 Router (request platform command set) with MDR

This procedure can only be performed if the current ASR 1006 router or ASR 1013 router has two active RPs and both RPs are running subpackages.

To perform an ISSU upgrade with MDR using subpackages on a Cisco ASR 1006 router or ASR 1013 router with a dual RP setup using the **request platform** command set, follow the following instructions.

### SUMMARY STEPS

1. **show version**
2. **mkdir** *URL-to-directory-name*
3. **ip tftp source-interface gigabitethernet** *port*
4. **copy tftp:** *URL-to-target-location*
5. **request platform software package expand file** *URL-to-consolidated-package*
6. **dir** *target-URL*
7. **copy file-system:asr1000rp2-espbase.version.pkg** *URL-to-directory-of-sub-packages-active-RP*
8. **copy file-system:asr1000rp2-espbase.version.pkg** *URL-to-directory-of-sub-packages-standby-RP*
9. **product="name=">request platform software package verify rp** *slot file URL mdr {force*
10. **request platform software package install rp** *standby-RP file target-standbyRP-URL-for-sub-packages:asr1000rp\*version\*.pkg force*
11. **hw-module slot** *standby-RP* **reload**
12. **request platform software package install rp** *active-RP file URL-to-active-file-system:asr1000rp2-{sipbase,sipsa}\*version\*.pkg slotSIP-slot-number product="name=">mdr {force*
13. **request platform software package install rp** *active-RP file URL-to-active-file-system:asr1000rp2-{elcbase,elcspa}\*version\*.pkg slotELC-slot-number mdr product="name=">{force*
14. **request platform software package install rp** *active-RP file URL-to-active-file-system:asr1000rp2-esp\*version\*.pkg slot standby-ESP-slot*
15. **request platform software package install rp** *active-RP file URL-to-active-file-system:asr1000rp\*version\*.pkg force*
16. **show version** *active-RP* **provisioned**
17. **redundancy force-switchover**

## 18. request platform software package clean

## DETAILED STEPS

|        | Command or Action                                                                                                                                                                                                                                                                                                                                                                                                                                                                                                                                                                                    | Purpose                                                                                                                                                                                                                                                                                                                                                                                                                                                                                                                                                                            |
|--------|------------------------------------------------------------------------------------------------------------------------------------------------------------------------------------------------------------------------------------------------------------------------------------------------------------------------------------------------------------------------------------------------------------------------------------------------------------------------------------------------------------------------------------------------------------------------------------------------------|------------------------------------------------------------------------------------------------------------------------------------------------------------------------------------------------------------------------------------------------------------------------------------------------------------------------------------------------------------------------------------------------------------------------------------------------------------------------------------------------------------------------------------------------------------------------------------|
| Step 1 | <p><b>show version</b></p> <p><b>Example:</b></p> <pre>show version active-rp installed</pre> <p><b>Example:</b></p> <pre>show version standby-rp installed</pre> <p><b>Example:</b></p> <pre>dir filesystem:&lt;directory&gt;</pre> <p><b>Example:</b></p> <pre>show platform</pre> <p><b>Example:</b></p> <pre>Router# show version</pre> <p><b>Example:</b></p> <pre>Router# show version r0 installed</pre> <p><b>Example:</b></p> <pre>Router# show version r1 installed</pre> <p><b>Example:</b></p> <pre>Router# dir bootflash:</pre> <p><b>Example:</b></p> <pre>Router# show platform</pre> | <p>(Optional) Use the following commands to confirm the current router configuration, as follows:</p> <ul style="list-style-type: none"> <li>• <b>show version</b> and <b>show version active-rp installed</b>—Verify the running version of the Cisco IOS XE software on the router, and which file was used to boot the router, and where that file is stored.</li> <li>• <b>dir</b>—Confirm that the files that were used to boot the router are located in the directory.</li> <li>• <b>show platform</b>—Confirm the current status of the active and standby RPs.</li> </ul> |
| Step 2 | <p><b>mkdir URL-to-directory-name</b></p> <p><b>Example:</b></p> <pre>Router# mkdir bootflash:tmp</pre>                                                                                                                                                                                                                                                                                                                                                                                                                                                                                              | <p>Creates a directory to store the consolidated package and subpackages.</p> <p>This directory must be created in most cases because the consolidated packages and subpackages have to be separated from the subpackages that booted the router at this step of the procedure.</p>                                                                                                                                                                                                                                                                                                |
| Step 3 | <p><b>ip tftp source-interface gigabitethernet port</b></p> <p><b>Example:</b></p> <pre>Router(config)# ip tftp source-interface gigabitethernet 0</pre>                                                                                                                                                                                                                                                                                                                                                                                                                                             | <p>Specifies the Gigabit Ethernet TFTP source-interface to be configured:</p> <p>slot/port—Specifies the location of the TFTP source-interface.</p>                                                                                                                                                                                                                                                                                                                                                                                                                                |

|               | Command or Action                                                                                                                                                                                                                                                                                                                                                                                       | Purpose                                                                                                                                                                                                                                                                                                                                                                                                                                                                                                                      |
|---------------|---------------------------------------------------------------------------------------------------------------------------------------------------------------------------------------------------------------------------------------------------------------------------------------------------------------------------------------------------------------------------------------------------------|------------------------------------------------------------------------------------------------------------------------------------------------------------------------------------------------------------------------------------------------------------------------------------------------------------------------------------------------------------------------------------------------------------------------------------------------------------------------------------------------------------------------------|
|               |                                                                                                                                                                                                                                                                                                                                                                                                         | <p><b>Note</b> To copy a file using TFTP through the Management Ethernet interface, the <b>ip tftp source-interface GigabitEthernet 0</b> command must be entered before entering the <b>copy tftp</b> command.</p>                                                                                                                                                                                                                                                                                                          |
| <b>Step 4</b> | <p><b>copy tftp:</b> <i>URL-to-target-location</i></p> <p><b>Example:</b></p> <pre>Router# copy tftp: bootflash:tmp</pre>                                                                                                                                                                                                                                                                               | <p>Copies the consolidated package file into the directory created in Step 2.</p> <p>The consolidated package in this step should not be copied into the same directory where the subpackages that are currently running your router are stored (the directory containing the packages.conf provisioning file from which the router was booted).</p> <p><b>Tip</b> It is recommended that you copy the package onto a usb: or harddisk: file system for space considerations when performing this step of the procedure.</p> |
| <b>Step 5</b> | <p><b>request platform software package expand file</b><br/><i>URL-to-consolidated-package</i></p> <p><b>Example:</b></p> <pre>Router# request platform software package expand file bootflash:tmp/asr1000rp2-enterprise9.03.13.00.S.154-3.Sec.bin</pre>                                                                                                                                                | <p>Extracts the subpackages out of the consolidated package file into the temporary directory.</p> <p><b>Note</b> Take extra care to extract the subpackages to a temporary subdirectory and do not delete any of the files currently running the router at this point of the procedure. To erase the files that were running on the router before the ISSU upgrade, enter the <b>request platform software package clean</b> command after the ISSU upgrade has been completed.</p>                                         |
| <b>Step 6</b> | <p><b>dir</b> <i>target-URL</i></p> <p><b>Example:</b></p> <pre>Router# dir bootflash:tmp</pre>                                                                                                                                                                                                                                                                                                         | (Optional) Displays the directory to confirm that the files were extracted.                                                                                                                                                                                                                                                                                                                                                                                                                                                  |
| <b>Step 7</b> | <p><b>copy file-system:asr1000rp2-espbase.version.pkg</b><br/><i>URL-to-directory-of-sub-packages-active-RP</i></p> <p><b>Example:</b></p> <pre>copy file-system:asr1000rp2-esp86base.version.pkg URL-to-directory-of-sub-packages-active-RP</pre> <p><b>Example:</b></p> <pre>copy file-system:asr1000rp2-rpaccess.version.pkg URL-to-directory-of-sub-packages-active-RP</pre> <p><b>Example:</b></p> | Copies the subpackages out of the temporary directory into the directory on the router where the subpackages running the active RP are currently stored.                                                                                                                                                                                                                                                                                                                                                                     |

| Command or Action                                                                                                                                                                                                                                                                                                                                                                                                                                                                                                                                                                                                                                                                                                                                                                                                                                                                                                                                                                                                                                                                                                                                                                                                                                                                          | Purpose |
|--------------------------------------------------------------------------------------------------------------------------------------------------------------------------------------------------------------------------------------------------------------------------------------------------------------------------------------------------------------------------------------------------------------------------------------------------------------------------------------------------------------------------------------------------------------------------------------------------------------------------------------------------------------------------------------------------------------------------------------------------------------------------------------------------------------------------------------------------------------------------------------------------------------------------------------------------------------------------------------------------------------------------------------------------------------------------------------------------------------------------------------------------------------------------------------------------------------------------------------------------------------------------------------------|---------|
| <pre> <b>copy</b> file-system: <b>asr1000rp2-rpbase.version.pkg</b> URL-to-directory-of-sub-packages-active-RP  <b>Example:</b>  <b>copy</b> file-system: <b>asr1000rp2-rpcontrol.version.pkg</b> URL-to-directory-of-sub-packages-active-RP  <b>Example:</b>  <b>copy</b> file-system: <b>asr1000rp2-rpios.version.pkg</b> URL-to-directory-of-sub-packages-active-RP  <b>Example:</b>  <b>copy</b> file-system: <b>asr1000rp2-sipbase.version.pkg</b> URL-to-directory-of-sub-packages-active-RP  <b>Example:</b>  <b>copy</b> file-system: <b>asr1000rp2-sipspace.version.pkg</b> URL-to-directory-of-sub-packages-active-RP  <b>Example:</b>  <b>copy</b> file-system: <b>asr1000rp2-elcbase.version.pkg</b> URL-to-directory-of-sub-packages-active-RP  <b>Example:</b>  <b>copy</b> file-system: <b>asr1000rp2-elcspa.version.pkg</b> URL-to-directory-of-sub-packages-active-RP  <b>Example:</b>  Router# <b>copy</b> bootflash: <del>tmp/asr1000rp2-espbase.03.13.00.S.154-3.S-ext.pkg</del> bootflash:  <b>Example:</b>  Router# <b>copy</b> bootflash: <del>tmp/asr1000rp2-espbase.03.13.00.S.154-3.S-ext.pkg</del> bootflash:  <b>Example:</b>  Router# <b>copy</b> bootflash: <del>tmp/asr1000rp2-rpaccess.03.13.00.S.154-3.S-ext.pkg</del> bootflash:  <b>Example:</b> </pre> |         |

|               | Command or Action                                                                                                                                                                                                                                                                                                                                                                                                                                                                                                                                                                                                                                                                               | Purpose                                                                                                                                                   |
|---------------|-------------------------------------------------------------------------------------------------------------------------------------------------------------------------------------------------------------------------------------------------------------------------------------------------------------------------------------------------------------------------------------------------------------------------------------------------------------------------------------------------------------------------------------------------------------------------------------------------------------------------------------------------------------------------------------------------|-----------------------------------------------------------------------------------------------------------------------------------------------------------|
|               | <pre>Router# copy bootflash:tmp/asr1000rp2-rpbase.03.13.00.S.154-3.S-ext.pkg bootflash:  Example:  Router# copy bootflash:tmp/asr1000rp2-rpcontrol.03.13.00.S.154-3.S-ext.pkg bootflash:  Example:  Router# copy bootflash:tmp/asr1000rp2-rpic-adenterprise9.03.12.01.S.154-2.S1.pkg bootflash:  Example:  Router# copy bootflash:tmp/asr1000rp2-sipbase.03.13.00.S.154-3.S-ext.pkg bootflash:  Example:  Router# copy bootflash:tmp/asr1000rp2-sipspa.03.13.00.S.154-3.S-ext.pkg bootflash:  Example:  Router# copy bootflash:tmp/asr1000rp2-elcbase.03.13.00.S.154-3.S-ext.pkg bootflash:  Example:  Router# copy bootflash:tmp/asr1000rp2-elcspa.03.13.00.S.154-3.S-ext.pkg bootflash:</pre> |                                                                                                                                                           |
| <b>Step 8</b> | <pre>copy file-system::asr1000rp2-espbase.version.pkg URL-to-directory-of-sub-packages-standby-RP  Example:  copy file-system::asr1000rp2-esp86base.version.pkg URL-to-directory-of-sub-packages-standby-RP  Example:  copy file-system::asr1000rp2-rpaccess.version.pkg URL-to-directory-of-sub-packages-standby-RP</pre>                                                                                                                                                                                                                                                                                                                                                                      | Copies the subpackages out of the temporary directory into the directory on the router where the subpackages running the standby RP are currently stored. |

| Command or Action                                                                                                                                                                                                                                                                                                                                                                                                                                                                                                                                                                                                                                                                                                                                                                                                                                                                                                                                                                                                                                                                                                                                                                                                                                                                                                                     | Purpose |
|---------------------------------------------------------------------------------------------------------------------------------------------------------------------------------------------------------------------------------------------------------------------------------------------------------------------------------------------------------------------------------------------------------------------------------------------------------------------------------------------------------------------------------------------------------------------------------------------------------------------------------------------------------------------------------------------------------------------------------------------------------------------------------------------------------------------------------------------------------------------------------------------------------------------------------------------------------------------------------------------------------------------------------------------------------------------------------------------------------------------------------------------------------------------------------------------------------------------------------------------------------------------------------------------------------------------------------------|---------|
| <p><b>Example:</b></p> <pre>copy file-system: asr1000rp2-rpbase . version . pkg URL-to-directory-of-sub-packages-standby-RP</pre> <p><b>Example:</b></p> <pre>copy file-system: asr1000rp2-rpcontrol . version . pkg URL-to-directory-of-sub-packages-standby-RP</pre> <p><b>Example:</b></p> <pre>copy file-system: asr1000rp2-rpios . version . pkg URL-to-directory-of-sub-packages-standby-RP</pre> <p><b>Example:</b></p> <pre>copy file-system: asr1000rp2-sipbase . version . pkg URL-to-directory-of-sub-packages-standby-RP</pre> <p><b>Example:</b></p> <pre>copy file-system: asr1000rp2-sipspace . version . pkg URL-to-directory-of-sub-packages-standby-RP</pre> <p><b>Example:</b></p> <pre>copy file-system: asr1000rp2-elcbase . version . pkg URL-to-directory-of-sub-packages-standby-RP</pre> <p><b>Example:</b></p> <pre>copy file-system: asr1000rp2-elcspa . version . pkg URL-to-directory-of-sub-packages-standby-RP</pre> <p><b>Example:</b></p> <pre>Router# copy bootflash:tmp/asr1000rp2-elcbase.03.13.00.S.154-3.S-ext.pkg stby-bootflash:</pre> <p><b>Example:</b></p> <pre>Router# copy bootflash:tmp/asr1000rp2-elcbase.03.13.00.S.154-3.S-ext.pkg stby-bootflash:</pre> <p><b>Example:</b></p> <pre>Router# copy bootflash:tmp/asr1000rp2-rpaccess.03.13.00.S.154-3.S-ext.pkg stby-bootflash:</pre> |         |

|        | Command or Action                                                                                                                                                                                                                                                                                                                                                                                                                                                                                                                                                                                                                                                                                                                                                                                                                                                                    | Purpose                                                                                                                                                    |
|--------|--------------------------------------------------------------------------------------------------------------------------------------------------------------------------------------------------------------------------------------------------------------------------------------------------------------------------------------------------------------------------------------------------------------------------------------------------------------------------------------------------------------------------------------------------------------------------------------------------------------------------------------------------------------------------------------------------------------------------------------------------------------------------------------------------------------------------------------------------------------------------------------|------------------------------------------------------------------------------------------------------------------------------------------------------------|
|        | <p><b>Example:</b></p> <pre>Router# copy bootflash:tmp/asr1000rp2-rpbase.03.13.00.S.154-3.S-ext.pkg stby-bootflash:</pre> <p><b>Example:</b></p> <pre>Router# ccopy bootflash:tmp/asr1000rp2-rpcontrol.03.13.00.S.154-3.S-ext.pkg stby-bootflash:</pre> <p><b>Example:</b></p> <pre>Router# copy bootflash:tmp/asr1000rp2-rpic-enterprise9.03.13.00.S.154-3.S-ext.pkg</pre> <p><b>Example:</b></p> <pre>Router# copy bootflash:tmp/asr1000rp2-sipbase.03.13.00.S.154-3.S-ext.pkg stby-bootflash:</pre> <p><b>Example:</b></p> <pre>Router# copy bootflash:tmp/asr1000rp2-sipsca.03.13.00.S.154-3.S-ext.pkg stby-bootflash:</pre> <p><b>Example:</b></p> <pre>Router# copy bootflash:tmp/asr1000rp2-elbase.03.13.00.S.154-3.S-ext.pkg stby-bootflash:</pre> <p><b>Example:</b></p> <pre>Router# copy bootflash:tmp/asr1000rp2-elcsca.03.13.00.S.154-3.S-ext.pkg stby-bootflash:</pre> |                                                                                                                                                            |
| Step 9 | <p><b>product="name="&gt;request platform software package<br/>verify rp slot file URL mdr {force</b></p> <p><b>Example:</b></p> <p><b>Example:</b></p> <pre>Router# request platform software package verify rp 1 file</pre>                                                                                                                                                                                                                                                                                                                                                                                                                                                                                                                                                                                                                                                        | Verifies the RP subpackages on the standby RP, where the “rp*” wildcard is specified to capture all of the RP subpackages for the desired upgrade release. |

|                | Command or Action                                                                                                                                                                                                                                                                                                                                                                                         | Purpose                                                                                                                                                                                                                                                                                                                                                                                                                                                                                                                                                                                                                                                                                                                 |
|----------------|-----------------------------------------------------------------------------------------------------------------------------------------------------------------------------------------------------------------------------------------------------------------------------------------------------------------------------------------------------------------------------------------------------------|-------------------------------------------------------------------------------------------------------------------------------------------------------------------------------------------------------------------------------------------------------------------------------------------------------------------------------------------------------------------------------------------------------------------------------------------------------------------------------------------------------------------------------------------------------------------------------------------------------------------------------------------------------------------------------------------------------------------------|
|                | <pre>stby-bootflash:asr1000rp2-*03.13.00.S.154-3.S-ext*.pkg mdr</pre>                                                                                                                                                                                                                                                                                                                                     |                                                                                                                                                                                                                                                                                                                                                                                                                                                                                                                                                                                                                                                                                                                         |
| <b>Step 10</b> | <p><b>request platform software package install rp <i>standby-RP</i> file</b><br/> <i>target-standbyRP-URL-for-sub-packages:asr1000rp*version*.pkg</i><br/> <b>force</b></p> <p><b>Example:</b></p> <p><b>Example:</b></p> <pre>Router# request platform software package install rp 1 file stby-bootflash:asr1000rp2-*03.13.00.S.154-3.S-ext*.pkg force</pre>                                            | Upgrades the RP subpackages on the standby RP, where the “rp*” wildcard is specified to capture all of the RP subpackages for the desired upgrade release.                                                                                                                                                                                                                                                                                                                                                                                                                                                                                                                                                              |
| <b>Step 11</b> | <p><b>hw-module slot <i>standby-RP</i> reload</b></p> <p><b>Example:</b></p> <pre>Router# hw-module slot R1 reload</pre>                                                                                                                                                                                                                                                                                  | Reloads the standby RP.                                                                                                                                                                                                                                                                                                                                                                                                                                                                                                                                                                                                                                                                                                 |
| <b>Step 12</b> | <p><b>request platform software package install rp <i>active-RP</i> file</b><br/> <i>URL-to-active-file-system:asr1000rp2-{sipbase,sipspa}*version*.pkg</i><br/> <b>slot</b><i>SIP-slot-number</i> <b>product="name="&gt;mdr {force</b></p> <p><b>Example:</b></p> <pre>Router# request platform software package install rp 0 file bootflash:asr1000rp2-{sipbase,sipspa}*03.13.00.S.154-3*.pkg mdr</pre> | <p>Upgrades the SIP and SPA subpackages for each SIP on the router using MDR.</p> <p><b>Note</b> This step must be completed one SIP at a time, and repeated for each SIP installed on the router before performing the next step.</p> <p><b>Tip</b> You can use the <b>show ip interface brief</b> command to identify which slots contain SIPs and SPAs. The interfaces with three numbers (in the form <i>SIP-number/SPA-number/interface-number</i>) identify the SIP and SPA locations in the router.</p> <p><b>Note</b> The <i>pattern</i> options used in this CLI (<b>sipbase</b> and <b>sipspa</b>) were introduced in Cisco IOS XE Release 2.1.2 and are not available in previous Cisco IOS XE Releases.</p> |
| <b>Step 13</b> | <p><b>request platform software package install rp <i>active-RP</i> file</b><br/> <i>URL-to-active-file-system:asr1000rp2-{elcbase,elcspa}*version*.pkg</i><br/> <b>slot</b><i>ELC-slot-number</i> <b>mdr product="name="&gt;{force</b></p> <p><b>Example:</b></p> <pre>Router# request platform software package</pre>                                                                                   | <p>Upgrades the ELC and SPA subpackages for each ELC on the router using MDR.</p> <p><b>Note</b> This step must be completed for one ELC at a time, and repeated for each ELC installed on the router before performing the next step.</p>                                                                                                                                                                                                                                                                                                                                                                                                                                                                              |



|                | Command or Action                                                                                                                                                                                                                                                                                                                                                                                                                                                                                                                                                                                                                                                          | Purpose                                                                                                                                                                                                                                                                                                                                                                                                                                                                          |
|----------------|----------------------------------------------------------------------------------------------------------------------------------------------------------------------------------------------------------------------------------------------------------------------------------------------------------------------------------------------------------------------------------------------------------------------------------------------------------------------------------------------------------------------------------------------------------------------------------------------------------------------------------------------------------------------------|----------------------------------------------------------------------------------------------------------------------------------------------------------------------------------------------------------------------------------------------------------------------------------------------------------------------------------------------------------------------------------------------------------------------------------------------------------------------------------|
|                | <pre>install rp 0 file bootflash:asr1000rp2-(elcbase,elcspa)*03.13.00.S.154-3*.pkg mdr</pre>                                                                                                                                                                                                                                                                                                                                                                                                                                                                                                                                                                               | <p><b>Tip</b> You can use the <b>show ip interface brief</b> command to identify which slots contain ELCs and SPAs. The interfaces with three numbers (in the form <i>ELC-number/SPA-number/interface-number</i>) identify the ELC and SPA locations in the router.</p> <p><b>Note</b> The <i>pattern</i> options used in this CLI (<b>elcbase</b> and <b>elcspa</b>) were introduced in Cisco IOS XE Release 3.10S and are not available in previous Cisco IOS XE Releases.</p> |
| <b>Step 14</b> | <p><b>request platform software package install rp active-RP file</b><br/> <i>URL-to-active-file-system:asr1000rp2-esp*version*.pkg</i><br/> <b>slot standby-ESP-slot</b></p> <p><b>Example:</b></p> <pre>request platform software package install rp active-RP file URL-to-active-file-system:asr1000rp2-esp*version*.pkg slot active-ESP-slot</pre> <p><b>Example:</b></p> <pre>Router# request platform software package install rp 0 file bootflash:asr1000rp2-esp*03.13.00.S.154-3.S-ext*.pkg slot 1</pre> <p><b>Example:</b></p> <pre>Router# request platform software package install rp 0 file bootflash:asr1000rp2-esp*03.13.00.S.154-3.S-ext*.pkg slot 0</pre> | <p>Upgrades the ESP Base subpackage on the standby and the active ESPs.</p> <p>After entering the <b>issu loadversion rp</b> command on the active RP, the ESP switchover will occur automatically. Minimal traffic interruption will occur as a result of this switchover.</p>                                                                                                                                                                                                  |
| <b>Step 15</b> | <p><b>request platform software package install rp active-RP file</b><br/> <i>URL-to-active-file-system:asr1000rp*version*.pkg</i><br/> <b>force</b></p> <p><b>Example:</b></p> <pre>Router# request platform software package install rp 0 file bootflash:asr1000rp2-*03.13.00.S.154-3.S-ext*.pkg force</pre>                                                                                                                                                                                                                                                                                                                                                             | <p>Upgrades all of the sub-packages on the active RP.</p> <p><b>Note</b> This step is required to ensure that all subpackages on the router were upgraded as part of this procedure, and might upgrade some subpackages that would otherwise be missed in the process.</p>                                                                                                                                                                                                       |
| <b>Step 16</b> | <p><b>show version active-RP provisioned</b></p> <p><b>Example:</b></p>                                                                                                                                                                                                                                                                                                                                                                                                                                                                                                                                                                                                    | <p>(Optional) Confirms the subpackages are provisioned and installed.</p>                                                                                                                                                                                                                                                                                                                                                                                                        |

|                | Command or Action                                                                                                                                                                     | Purpose                                                         |
|----------------|---------------------------------------------------------------------------------------------------------------------------------------------------------------------------------------|-----------------------------------------------------------------|
|                | <b>show version</b> <i>active-RP</i> <b>installed</b><br><b>Example:</b><br>Router# <b>show version r0 provisioned</b><br><b>Example:</b><br>Router# <b>show version r0 installed</b> |                                                                 |
| <b>Step 17</b> | <b>redundancy force-switchover</b><br><b>Example:</b><br>Router# <b>redundancy force-switchover</b>                                                                                   | Forces an RP switchover to complete the upgrade.                |
| <b>Step 18</b> | <b>request platform software package clean</b>                                                                                                                                        | (Optional) Removes all unused subpackage files from the router. |

## Examples

This example shows ISSU upgrade using subpackages on a Cisco ASR 1006 router or ASR 1013 router with a dual RP setup:

```

Router# show version
Cisco IOS Software, IOS-XE Software (X86_64_LINUX_IOSD-ADVENTERPRISEK9-M), Version 15.3(2)S,
 RELEASE SOFTWARE (fc1)
<output removed for brevity>
System image file is "bootflash:Active_Dir/packages.conf"
<output removed for brevity>
cisco ASR1013 (RP2) processor with 4208889K/6147K bytes of memory.
Processor board ID FOX1343GJGC
20 Gigabit Ethernet interfaces
6 Ten Gigabit Ethernet interfaces
32768K bytes of non-volatile configuration memory.
8388608K bytes of physical memory.
1925119K bytes of eUSB flash at bootflash:.
78085207K bytes of SATA hard disk at harddisk:.
Configuration register is 0x2102
Router# show platform
Chassis type: ASR1013
Slot Type State Insert time (ago)

2 ASR1000-SIP40 ok 1d03h
2/0 SPA-1X10GE-L-V2 ok 1d03h
2/1 SPA-1X10GE-L-V2 ok 1d03h
2/2 SPA-1X10GE-L-V2 ok 1d03h
2/3 SPA-1X10GE-L-V2 ok 1d03h
4 ASR1000-2T+20X1GE ok 1d03h
4/0 BUILT-IN-2T+20X1GE ok 1d03h
R0 ASR1000-RP2 ok, active 1d03h
R1 ASR1000-RP2 ok, standby 1d03h
F0 ASR1000-ESP100 ok, active 1d03h
F1 ASR1000-ESP100 ok, standby 1d03h
P0 ASR1013-PWR-AC ok 1d03h
P1 ASR1013-PWR-AC ok 1d03h

```

```

P2 ASR1013-PWR-AC ok 1d03h
P3 ASR1013-PWR-AC ps, fail 1d03h
Slot CPLD Version Firmware Version

2 00200800 15.3(3r)S
4 00200800 15.3(1r)S
R0 10021901 15.3(3r)S
R1 10021901 15.3(3r)S
F0 12071700 15.3(3r)S
F1 12071700 15.3(3r)S
Router# show version r0 installed
Package: Provisioning File, version: n/a, status: active
 File: bootflash:Active_Dir/packages.conf, on: RP0
 Built: n/a, by: n/a
 File SHA1 checksum: a624f70f68c60292f4482433f43afd92487a55c4
Package: rpbase, version: 03.12.01.S.154-2.S, status: active
 File: bootflash:Active_Dir/asr1000rp2-rpbase.03.12.01.S.154-2.S.pkg, on: RP0
 Built: 2013-03-25_18.48, by: mcpre
 File SHA1 checksum: 3a9675142898cfac350d4e42f0e37bd9f4e48538
Package: rpcontrol, version: 03.12.01.S.154-2.S, status: active
 File: bootflash:Active_Dir/asr1000rp2-rpcontrol.03.12.01.S.154-2.S.pkg, on: RP0/0
 Built: 2013-03-25_18.48, by: mcpre
 File SHA1 checksum: 87b11f863f67fdf2610ee0769b929baab4c3efad
<output removed for brevity>
Router# dir bootflash:Active_Dir
Directory of bootflash:/Active_Dir/
 20 -rw- 41104112 Aug 3 2013 15:05:40 +05:30
asr1000rp2-elcbase.03.12.01.S.154-2.S.pkg
 21 -rw- 50285296 Aug 3 2013 15:05:40 +05:30 asr1000rp2-elcspa.03.12.01.S.154-2.S.pkg

 22 -rw- 82514676 Aug 3 2013 15:05:40 +05:30
asr1000rp2-espbase.03.12.01.S.154-2.S.pkg
 23 -rw- 101084628 Aug 3 2013 15:05:40 +05:30
asr1000rp2-esp86base.03.12.01.S.154-2.S.pkg
 17 -rw- 9059 Aug 3 2013 15:05:40 +05:30
asr1000rp2-packages-adventerprisek9.03.12.01.S.154-2.S.conf
 24 -rw- 29012724 Aug 3 2013 15:05:40 +05:30
asr1000rp2-rpaccess.03.12.01.S.154-2.S.pkg
 25 -rw- 49898964 Aug 3 2013 15:05:40 +05:30 asr1000rp2-rpbase.03.12.01.S.154-2.S.pkg

 26 -rw- 46557940 Aug 3 2013 15:05:40 +05:30
asr1000rp2-rpcontrol.03.12.01.S.154-2.S.pkg
 27 -rw- 114612988 Aug 3 2013 15:05:41 +05:30
asr1000rp2-rpios-adventerprisek9.03.12.01.S.154-2.S.pkg
 28 -rw- 41954036 Aug 3 2013 15:05:41 +05:30
asr1000rp2-sipbase.03.12.01.S.154-2.S.pkg
 29 -rw- 60957428 Aug 3 2013 15:05:41 +05:30 asr1000rp2-sipspa.03.12.01.S.154-2.S.pkg

 19 -rw- 9838 Aug 3 2013 15:05:41 +05:30 packages.conf
1940303872 bytes total (503164928 bytes free)
Router#
Router# show redundancy states
 my state = 13 -ACTIVE
 peer state = 8 -STANDBY HOT
 Mode = Duplex
 Unit = Primary
 Unit ID = 48
Redundancy Mode (Operational) = sso
Redundancy Mode (Configured) = sso
Redundancy State = sso
 Maintenance Mode = Disabled
 Manual Swact = enabled
Communications = Up
 client count = 108

```

```

client_notification_TMR = 30000 milliseconds
RF debug mask = 0x0
Router# copy running-config startup-config
Destination filename [startup-config]?
Building configuration...
[OK]
Router# mkdir harddisk:Target_Subs
Create directory filename [Target_Subs]?
Created dir harddisk:/Target_Subs
Router#
Router#
Router#
Router# request platform software package expand file
harddisk:Target_Subs/asr1000rp2-adventerprisek9.03.13.00.S.154-3.S-ext.bin to
harddisk:Target_Subs
Verifying parameters
Validating package type
Copying package files
SUCCESS: Finished expanding all-in-one software package.
Router#
Router#
Router# dir harddisk:Target_Subs
Directory of harddisk:/Target_Subs/
3358722 -rw- 569597380 Aug 4 2013 18:45:38 +05:30
asr1000rp2-adventerprisek9.03.13.00.S.154-3.S-ext.bin
7684099 -rw- 37557200 Aug 4 2013 18:46:43 +05:30
asr1000rp2-elcbase.03.13.00.S.154-3.S-ext.pkg
7684100 -rw- 51194832 Aug 4 2013 18:46:43 +05:30
asr1000rp2-elcspa.03.13.00.S.154-3.S-ext.pkg
7684101 -rw- 80657364 Aug 4 2013 18:46:43 +05:30
asr1000rp2-espbase.03.13.00.S.154-3.S-ext.pkg
7684102 -rw- 95446456 Aug 4 2013 18:46:43 +05:30
asr1000rp2-esp86base.03.13.00.S.154-3.S-ext.pkg
7684097 -rw- 9381 Aug 4 2013 18:46:43 +05:30
asr1000rp2-packages-adventerprisek9.03.13.00.S.154-3.S-ext.conf
7684103 -rw- 23350232 Aug 4 2013 18:46:43 +05:30
asr1000rp2-rpaccess.03.13.00.S.154-3.S-ext.pkg
7684104 -rw- 37694900 Aug 4 2013 18:46:44 +05:30
asr1000rp2-rpbase.03.13.00.S.154-3.S-ext.pkg
7684105 -rw- 45536216 Aug 4 2013 18:46:44 +05:30
asr1000rp2-rpcontrol.03.13.00.S.154-3.S-ext.pkg
7684106 -rw- 118754284 Aug 4 2013 18:46:44 +05:30
asr1000rp2-rpios-adventerprisek9.03.13.00.S.154-3.S-ext.pkg
7684107 -rw- 38380500 Aug 4 2013 18:46:44 +05:30
asr1000rp2-sipbase.03.13.00.S.154-3.S-ext.pkg
7684108 -rw- 61760468 Aug 4 2013 18:46:44 +05:30
asr1000rp2-sipspa.03.13.00.S.154-3.S-ext.pkg
7684098 -rw- 10165 Aug 4 2013 18:46:44 +05:30 packages.conf
78704144384 bytes total (9254879232 bytes free)
Router# copy harddisk:Target_Subs/asr1000rp2-espbase.03.13.00.S.154-3.S-ext.pkg
bootflash:Active_Dir/
Destination filename [Active_Dir/asr1000rp2-espbase.03.13.00.S.154-3.S-ext.pkg]?
Copy in progress...CCCCC80657364 bytes copied in 11.951 secs (6749005 bytes/sec)
Router#
Router# copy harddisk:Target_Subs/asr1000rp2-esp86base.03.13.00.S.154-3.S-ext.pkg
bootflash:Active_Dir/
Destination filename [Active_Dir/asr1000rp2-esp86base.03.13.00.S.154-3.S-ext.pkg]?
Copy in progress...CCCCC95446456 bytes copied in 14.213 secs (6715433 bytes/sec)
Router#
Router# copy harddisk:Target_Subs/asr1000rp2-rpaccess.03.13.00.S.154-3.S-ext.pkg
bootflash:Active_Dir/
Destination filename [Active_Dir/asr1000rp2-rpaccess.03.13.00.S.154-3.S-ext.pkg]?
Copy in progress...CCCCCC23350232 bytes copied in 3.441 secs (6785885 bytes/sec)
Router#

```

```

Router# copy harddisk:Target_Sub/Target_Sub/asr1000rp2-rpbase.03.13.00.S.154-3.S-ext.pkg
bootflash:Active_Dir/
Destination filename [Active_Dir/asr1000rp2-rpbase.03.13.00.S.154-3.S-ext.pkg]?
Copy in progress...CCCC37694900 bytes copied in 5.598 secs (6733637 bytes/sec)
Router#
Router# copy harddisk:Target_Sub/Target_Sub/asr1000rp2-rpcontrol.03.13.00.S.154-3.S-ext.pkg
bootflash:Active_Dir/
Destination filename [Active_Dir/asr1000rp2-rpcontrol.03.13.00.S.154-3.S-ext.pkg]?
Copy in progress...CCCC45536216 bytes copied in 6.797 secs (6699458 bytes/sec)
Router#
Router# copy harddisk:Target_Sub/Target_Sub/asr1000rp2-rpios-adventerprisek9.03.13.00.S.154-3.S-ext.pkg
bootflash:Active_Dir/
Destination filename [Active_Dir/asr1000rp2-rpios-adventerprisek9.03.13.00.S.154-3.S-ext.pkg]?

Copy in progress...CCCC
118754284 bytes copied in 17.798 secs (6672339 bytes/sec)
Router#
Router# copy harddisk:Target_Sub/Target_Sub/asr1000rp2-sipbase.03.13.00.S.154-3.S-ext.pkg
bootflash:Active_Dir/
Destination filename [Active_Dir/asr1000rp2-sipbase.03.13.00.S.154-3.S-ext.pkg]?
Copy in progress...CCCC38380500 bytes copied in 5.962 secs (6437521 bytes/sec)
Router#
Router# copy harddisk:Target_Sub/Target_Sub/asr1000rp2-sipspace.03.13.00.S.154-3.S-ext.pkg
bootflash:Active_Dir/
Destination filename [Active_Dir/asr1000rp2-sipspace.03.13.00.S.154-3.S-ext.pkg]?
Copy in progress...CCCC61760468 bytes copied in 9.408 secs (6564676 bytes/sec)
Router#
Router# copy harddisk:Target_Sub/Target_Sub/asr1000rp2-elcbase.03.13.00.S.154-3.S-ext.pkg
bootflash:Active_Dir/
Destination filename [Active_Dir/asr1000rp2-elcbase.03.13.00.S.154-3.S-ext.pkg]?
Copy in progress...CCCCC37557200 bytes copied in 5.650 secs (6647292 bytes/sec)
Router# copy harddisk:Target_Sub/Target_Sub/asr1000rp2-elcspa.03.13.00.S.154-3.S-ext.pkg
bootflash:Active_Dir/
Destination filename [Active_Dir/asr1000rp2-elcspa.03.13.00.S.154-3.S-ext.pkg]?
Copy in progress...CCCC51194832 bytes copied in 7.397 secs (6921026 bytes/sec)
Router#
Router# copy harddisk:Target_Sub/Target_Sub/asr1000rp2-espbase.03.13.00.S.154-3.S-ext.pkg
stby-bootflash:Active_Dir/
Destination filename [Active_Dir/asr1000rp2-espbase.03.13.00.S.154-3.S-ext.pkg]?
Copy in progress...CCCC80657364 bytes copied in 132.765 secs (607520 bytes/sec)
Router#
Router# copy harddisk:Target_Sub/Target_Sub/asr1000rp2-esp86base.03.13.00.S.154-3.S-ext.pkg
stby-bootflash:Active_Dir/
Destination filename [Active_Dir/asr1000rp2-esp86base.03.13.00.S.154-3.S-ext.pkg]?
Copy in progress...CCCCC95446456 bytes copied in 177.587 secs (537463 bytes/sec)
Router#
Router# copy harddisk:Target_Sub/Target_Sub/asr1000rp2-rpaccess.03.13.00.S.154-3.S-ext.pkg
stby-bootflash:Active_Dir/
Destination filename [Active_Dir/asr1000rp2-rpaccess.03.13.00.S.154-3.S-ext.pkg]?
Copy in progress...CCCCC
23350232 bytes copied in 55.396 secs (421515 bytes/sec)
Router#
Router# copy harddisk:Target_Sub/Target_Sub/asr1000rp2-rpbase.03.13.00.S.154-3.S-ext.pkg
stby-bootflash:Active_Dir/
Destination filename [Active_Dir/asr1000rp2-rpbase.03.13.00.S.154-3.S-ext.pkg]?
Copy in progress...CCCC37694900 bytes copied in 86.199 secs (437301 bytes/sec)
Router#
Router# copy harddisk:Target_Sub/Target_Sub/asr1000rp2-rpcontrol.03.13.00.S.154-3.S-ext.pkg
stby-bootflash:Active_Dir/
Destination filename [Active_Dir/asr1000rp2-rpcontrol.03.13.00.S.154-3.S-ext.pkg]?
Copy in progress...CCCC45536216 bytes copied in 101.527 secs (448513 bytes/sec)
Router#
Router# copy harddisk:Target_Sub/Target_Sub/asr1000rp2-rpios-adventerprisek9.03.13.00.S.154-3.S-ext.pkg

```

```

stby-bootflash:Active_Dir/
Destination filename [Active_Dir/asr1000rp2-rpios-adventerprisek9.03.13.00.S.154-3.S-ext.pkg]?

Copy in progress...CCCC118754284 bytes copied in 212.646 secs (558460 bytes/sec)
Router#
Router# copy harddisk:Target_Sub/asr1000rp2-sipbase.03.13.00.S.154-3.S-ext.pkg
stby-bootflash:Active_Dir/
Destination filename [Active_Dir/asr1000rp2-sipbase.03.13.00.S.154-3.S-ext.pkg]?
Copy in progress...CCCC38380500 bytes copied in 83.162 secs (461515 bytes/sec)
Router#
Router# copy harddisk:Target_Sub/asr1000rp2-sipsa.03.13.00.S.154-3.S-ext.pkg
stby-bootflash:Active_Dir/
Destination filename [Active_Dir/asr1000rp2-sipsa.03.13.00.S.154-3.S-ext.pkg]?
Copy in progress...CCC61760468 bytes copied in 119.391 secs (517296 bytes/sec)
Router#
Router# copy harddisk:Target_Sub/asr1000rp2-elcbase.03.13.00.S.154-3.S-ext.pkg
stby-bootflash:Active_Dir/
Destination filename [Active_Dir/asr1000rp2-elcbase.03.13.00.S.154-3.S-ext.pkg]?
Copy in progress...CCCC37557200 bytes copied in 57.106 secs (657675 bytes/sec)
Router#
Router# copy harddisk:Target_Sub/asr1000rp2-elcspa.03.13.00.S.154-3.S-ext.pkg
stby-bootflash:Active_Dir/
Destination filename [Active_Dir/asr1000rp2-elcspa.03.13.00.S.154-3.S-ext.pkg]?
Copy in progress...CCCCCCC51194832 bytes copied in 87.453 secs (585398 bytes/sec)
Router# request platform software package verify rp 1 file
stby-bootflash:Active_Dir/asr1000rp*03.13.00.S.154-3.S-ext*.pkg mdr force
--- Starting local lock acquisition on R0 ---
Finished local lock acquisition on R0
--- Starting installation state synchronization ---
Finished installation state synchronization
--- Starting local lock acquisition on R1 ---
Finished local lock acquisition on R1
--- Starting file path checking ---
Finished file path checking
--- Starting image file verification ---
Checking image file names
Locating image files and validating name syntax
 Found asr1000rp2-elcbase.03.13.00.S.154-3.S-ext.pkg
 Found asr1000rp2-elcspa.03.13.00.S.154-3.S-ext.pkg
 Found asr1000rp2-espbase.03.13.00.S.154-3.S-ext.pkg
 Found asr1000rp2-esp86base.03.13.00.S.154-3.S-ext.pkg
 Found asr1000rp2-rpaccess.03.13.00.S.154-3.S-ext.pkg
 Found asr1000rp2-rpbase.03.13.00.S.154-3.S-ext.pkg
 Found asr1000rp2-rpcontrol.03.13.00.S.154-3.S-ext.pkg
 Found asr1000rp2-rpios-adventerprisek9.03.13.00.S.154-3.S-ext.pkg
 Found asr1000rp2-sipbase.03.13.00.S.154-3.S-ext.pkg
 Found asr1000rp2-sipsa.03.13.00.S.154-3.S-ext.pkg
Verifying image file locations
Inspecting image file types
 WARNING: In-service installation of IOSD package
 WARNING: requires software redundancy on target RP
 WARNING: or on-reboot parameter
 WARNING: Automatically setting the on-reboot flag
 WARNING: In-service installation of RP Base package
 WARNING: requires software reboot of target RP
Processing image file constraints
Creating candidate provisioning file
Finished image file verification
--- Starting candidate package set construction ---
Verifying existing software set
Processing candidate provisioning file
Constructing working set for candidate package set
Constructing working set for running package set
Checking command output

```

```

Constructing merge of running and candidate packages
Checking if resulting candidate package set would be complete
Finished candidate package set construction
--- Starting compatibility testing ---
Determining whether candidate package set is compatible
Determining whether installation is valid
Determining whether installation is valid ... skipped
Verifying image type compatibility
Checking IPC compatibility for candidate software
Checking candidate package set infrastructure compatibility
Checking infrastructure compatibility with running software
Checking infrastructure compatibility with running software ... skipped
Checking package specific compatibility
Finished compatibility testing
--- Starting mdr compatibility verification ---
MDR for CC type [0x762] located at slot [4] not supported by running package version
[03.12.01.S.154-2.S]
As SIP4 does not support MDR none of the SPA's within in may be upgraded using MDR
MDR compatibility failed - proceeding with forced MDR-upgrade - some traffic will be impacted
during the upgrade
Finished mdr compatibility verification
SUCCESS: Software is ISSU MDR compatible.
Router# request platform software package install rp 1 file
stby-bootflash:Active_Dir/asr1000rp*03.13.00.S.154-3.S-ext*.pkg force
--- Starting local lock acquisition on R0 ---
Finished local lock acquisition on R0
--- Starting installation state synchronization ---
Finished installation state synchronization
--- Starting local lock acquisition on R1 ---
Finished local lock acquisition on R1
--- Starting file path checking ---
Finished file path checking
--- Starting image file verification ---
Checking image file names
Locating image files and validating name syntax
 Found asr1000rp2-elcbase.03.13.00.S.154-3.S-ext.pkg
 Found asr1000rp2-elcspa.03.13.00.S.154-3.S-ext.pkg
 Found asr1000rp2-espbase.03.13.00.S.154-3.S-ext.pkg
 Found asr1000rp2-esp86base.03.13.00.S.154-3.S-ext.pkg
 Found asr1000rp2-rpaccess.03.13.00.S.154-3.S-ext.pkg
 Found asr1000rp2-rpbase.03.13.00.S.154-3.S-ext.pkg
 Found asr1000rp2-rpcontrol.03.13.00.S.154-3.S-ext.pkg
 Found asr1000rp2-rpios-adventerprisek9.03.13.00.S.154-3.S-ext.pkg
 Found asr1000rp2-sipbase.03.13.00.S.154-3.S-ext.pkg
 Found asr1000rp2-sipspa.03.13.00.S.154-3.S-ext.pkg
Verifying image file locations
Inspecting image file types
 WARNING: In-service installation of IOSD package
 WARNING: requires software redundancy on target RP
 WARNING: or on-reboot parameter
 WARNING: Automatically setting the on-reboot flag
 WARNING: In-service installation of RP Base package
 WARNING: requires software reboot of target RP
Processing image file constraints
Creating candidate provisioning file
Finished image file verification
--- Starting candidate package set construction ---
Verifying existing software set
Processing candidate provisioning file
Constructing working set for candidate package set
Constructing working set for running package set
Checking command output
Constructing merge of running and candidate packages
Checking if resulting candidate package set would be complete

```

```

Finished candidate package set construction
--- Starting compatibility testing ---
Determining whether candidate package set is compatible
Determining whether installation is valid
Determining whether installation is valid ... skipped
Verifying image type compatibility
Checking IPC compatibility for candidate software
Checking candidate package set infrastructure compatibility
Checking infrastructure compatibility with running software
Checking infrastructure compatibility with running software ... skipped
Checking package specific compatibility
Finished compatibility testing
--- Starting list of software package changes ---
Old files list:
 Removed asr1000rp2-elcbase.03.12.01.S.154-2.S.pkg
 Removed asr1000rp2-elcspa.03.12.01.S.154-2.S.pkg
 Removed asr1000rp2-espbase.03.12.01.S.154-2.S.pkg
 Removed asr1000rp2-esp86base.03.12.01.S.154-2.S.pkg
 Removed asr1000rp2-rpaccess.03.12.01.S.154-2.S.pkg
 Removed asr1000rp2-rpbase.03.12.01.S.154-2.S.pkg
 Removed asr1000rp2-rpcontrol.03.12.01.S.154-2.S.pkg
 Removed asr1000rp2-rpios-adventerprisek9.03.12.01.S.154-2.S.pkg
 Removed asr1000rp2-sipbase.03.12.01.S.154-2.S.pkg
 Removed asr1000rp2-sipsa.03.12.01.S.154-2.S.pkg
New files list:
 Added asr1000rp2-elcbase.03.13.00.S.154-3.S-ext.pkg
 Added asr1000rp2-elcspa.03.13.00.S.154-3.S-ext.pkg
 Added asr1000rp2-espbase.03.13.00.S.154-3.S-ext.pkg
 Added asr1000rp2-esp86base.03.13.00.S.154-3.S-ext.pkg
 Added asr1000rp2-rpaccess.03.13.00.S.154-3.S-ext.pkg
 Added asr1000rp2-rpbase.03.13.00.S.154-3.S-ext.pkg
 Added asr1000rp2-rpcontrol.03.13.00.S.154-3.S-ext.pkg
 Added asr1000rp2-rpios-adventerprisek9.03.13.00.S.154-3.S-ext.pkg
 Added asr1000rp2-sipbase.03.13.00.S.154-3.S-ext.pkg
 Added asr1000rp2-sipsa.03.13.00.S.154-3.S-ext.pkg
Finished list of software package changes
--- Starting commit of software changes ---
Updating provisioning rollback files
Creating pending provisioning file
Committing provisioning file
Finished commit of software changes
SUCCESS: Software provisioned. New software will load on reboot.
Router# hw-module slot r1 reload
Proceed with reload of module? [confirm]
Router#
*Aug 4 19:14:01.721 IST: %IOSXE_OIR-6-OFFLINECARD: Card (rp) offline in slot R1
*Aug 4 19:14:01.761 IST: %REDUNDANCY-3-STANDBY_LOST: Standby processor fault
(P_EER_NOT_PRESENT)
*Aug 4 19:14:01.761 IST: %REDUNDANCY-3-STANDBY_LOST: Standby processor fault (P_EER_DOWN)
*Aug 4 19:14:01.761 IST: %REDUNDANCY-3-STANDBY_LOST: Standby processor fault
(P_EER_REDUNDANCY_STATE_CHANGE)
*Aug 4 19:14:03.584 IST: %RF-5-RF_RELOAD: Peer reload. Reason: E_HSA standby down
*Aug 4 19:14:03.594 IST: % Redundancy mode change to SSO
Router#
*Aug 4 19:17:35.443 IST: %IOSXE_OIR-6-ONLINECARD: Card (rp) online in slot R1
Router#
*Aug 4 19:17:48.061 IST: %REDUNDANCY-5-P_EER_MONITOR_EVENT: Active detected a standby
insertion (raw-event=P_EER_FOUND(4))
*Aug 4 19:17:48.061 IST: %REDUNDANCY-5-P_EER_MONITOR_EVENT: Active detected a standby
insertion (raw-event=P_EER_REDUNDANCY_STATE_CHANGE(5))
*Aug 4 19:17:51.003 IST: %REDUNDANCY-3-IPC: IOS versions do not match.

*Aug 4 19:19:08.380 IST: %NBAR_HA-5-NBAR_INFO: NBAR sync DONE!
*Aug 4 19:19:08.797 IST: %H_A_CONFIG_SYNC-6-BULK_CFGSYNC_SUCCEED: Bulk Sync succeeded

```



```

*Aug 4 19:19:08.798 IST: %RF-5-RF_TERMINAL_STATE: Terminal state reached for (SSO)
Router#
Router#request platform software package install rp 0 file
bootflash:Active_Dir/asr1000rp2-{sipbase,sipspa}*03.13.00.S.154-3.S-ext*.pkg slot 2 mdr
force
--- Starting local lock acquisition on R0 ---
Finished local lock acquisition on R0
--- Starting installation state synchronization ---
Finished installation state synchronization
--- Starting file path checking ---
Finished file path checking
--- Starting image file verification ---
Checking image file names
Locating image files and validating name syntax
 Found asr1000rp2-sipbase.03.13.00.S.154-3.S-ext.pkg
 Found asr1000rp2-sipspa.03.13.00.S.154-3.S-ext.pkg
Verifying image file locations
Inspecting image file types
Processing image file constraints
Creating candidate provisioning file
Finished image file verification
--- Starting candidate package set construction ---
Verifying existing software set
Processing candidate provisioning file
Constructing working set for candidate package set
Constructing working set for running package set
Checking command output
Constructing merge of running and candidate packages
Checking if resulting candidate package set would be complete
Finished candidate package set construction
--- Starting compatibility testing ---
Determining whether candidate package set is compatible
WARNING:
WARNING: Candidate software combination not found in compatibility database
WARNING:
Determining whether installation is valid
Creating matrix_file by locate_latest_matrix_file /tmp/issu/provision/sw
WARNING:
WARNING: Candidate software combination not found in compatibility database
WARNING:
WARNING:
WARNING: Candidate software combination not found in compatibility database
WARNING:
Software sets are identified as compatible
Verifying image type compatibility
Checking IPC compatibility with running software
Checking candidate package set infrastructure compatibility
Checking infrastructure compatibility with running software
Checking package specific compatibility
Finished compatibility testing
--- Starting mdr compatibility verification ---
Finished mdr compatibility verification
--- Starting impact testing ---
Checking operational impact of change
Finished impact testing
--- Starting list of software package changes ---
No old package files removed
New files list:
 Added asr1000rp2-sipbase.03.13.00.S.154-3.S-ext.pkg
 Added asr1000rp2-sipspa.03.13.00.S.154-3.S-ext.pkg
Finished list of software package changes
--- Starting commit of software changes ---
Updating provisioning rollback files
Creating pending provisioning file

```

```

Committing provisioning file
Finished commit of software changes
--- Starting analysis of software changes ---
Finished analysis of software changes
--- Starting update running software ---
Blocking peer synchronization of operating information
Creating the command set placeholder directory
 Finding latest command set
 Finding latest command shortlist lookup file
 Finding latest command shortlist file
 Assembling CLI output libraries
 Assembling CLI input libraries
 Assembling Dynamic configuration files
 Applying interim IPC and database definitions
 Replacing running software
 Replacing CLI software
 Restarting software
*Aug 4 19:20:48.949 IST: %MDR-5-CARD_RESTART: R0/0: card_mdr: Minimal Disruptive Restart
SIP2 to acquire provisioned software Applying final IPC and database definitions
*Aug 4 19:20:58.013 IST: %CMCC-5-SPA_MDR_INIT: SIP2: cmcc: SPA0 initiated Minimal Disruptive
Restart
*Aug 4 19:20:58.017 IST: %CMCC-5-SPA_MDR_INIT: SIP2: cmcc: SPA1 initiated Minimal Disruptive
Restart
*Aug 4 19:20:58.018 IST: %CMCC-5-SPA_MDR_INIT: SIP2: cmcc: SPA2 initiated Minimal Disruptive
Restart
*Aug 4 19:20:58.019 IST: %CMCC-5-SPA_MDR_INIT: SIP2: cmcc: SPA3 initiated Minimal Disruptive
Restart Generating software version information
 Notifying running software of updates
 Unblocking peer synchronization of operating information
Unmounting old packages
Cleaning temporary installation files
 Finished update running software

SUCCESS: Finished installing software.
Router#
*Aug 4 19:21:45.424 IST: %IOSXE_OIR-6-ONLINECARD: Card (cc) online in slot 2
*Aug 4 19:21:48.382 IST: %IOSXE_OIR-6-INSSPA: SPA inserted in subslot 2/0
*Aug 4 19:21:48.733 IST: %IOSXE_OIR-6-INSSPA: SPA inserted in subslot 2/1
*Aug 4 19:21:49.083 IST: %IOSXE_OIR-6-INSSPA: SPA inserted in subslot 2/2
*Aug 4 19:21:49.430 IST: %IOSXE_OIR-6-INSSPA: SPA inserted in subslot 2/3
*Aug 4 19:21:58.121 IST: %LINK-3-UPDOWN: SIP2/0: Interface EOBC2/1, changed state to up
*Aug 4 19:22:02.302 IST: %SPA_OIR-6-ONLINECARD: SPA (SPA-1X10GE-L-V2) online in subslot
2/0
*Aug 4 19:22:02.312 IST: %CMCC-5-SPA_MDR_DONE: SIP2: cmcc: SPA0 completed Minimal Disruptive
Restart
*Aug 4 19:22:02.282 IST: %TRANSCEIVER-6-INSERTED: SIP2/0: transceiver module inserted in
TenGigabitEthernet2/0/0
*Aug 4 19:22:02.518 IST: %LINK-3-UPDOWN: SIP2/1: Interface EOBC2/1, changed state to up
*Aug 4 19:22:06.113 IST: %SPA_OIR-6-ONLINECARD: SPA (SPA-1X10GE-L-V2) online in subslot
2/1
*Aug 4 19:22:06.126 IST: %CMCC-5-SPA_MDR_DONE: SIP2: cmcc: SPA1 completed Minimal Disruptive
Restart
*Aug 4 19:22:06.082 IST: %TRANSCEIVER-6-INSERTED: SIP2/1: transceiver module inserted in
TenGigabitEthernet2/1/0
*Aug 4 19:22:08.080 IST: %LINK-3-UPDOWN: SIP2/2: Interface EOBC2/1, changed state to up
*Aug 4 19:22:11.627 IST: %SPA_OIR-6-ONLINECARD: SPA (SPA-1X10GE-L-V2) online in subslot
2/2
*Aug 4 19:22:11.637 IST: %CMCC-5-SPA_MDR_DONE: SIP2: cmcc: SPA2 completed Minimal Disruptive
Restart
*Aug 4 19:22:11.616 IST: %TRANSCEIVER-6-INSERTED: SIP2/2: transceiver module inserted in
TenGigabitEthernet2/2/0
*Aug 4 19:22:12.523 IST: %LINK-3-UPDOWN: SIP2/3: Interface EOBC2/1, changed state to up
*Aug 4 19:22:16.657 IST: %SPA_OIR-6-ONLINECARD: SPA (SPA-1X10GE-L-V2) online in subslot
2/3

```

```

*Aug 4 19:22:16.668 IST: %CMCC-5-SPA_MDR_DONE: SIP2: cmcc: SPA3 completed Minimal Disruptive
Restart
*Aug 4 19:22:16.648 IST: %TRANSCEIVER-6-INSERTED: SIP2/3: transceiver module inserted in
TenGigabitEthernet2/3/0
Router#
Router#
Router#issu commitversion
--- Starting local lock acquisition on R0 ---
Finished local lock acquisition on R0
--- Starting installation changes ---
Cancelling rollback timer
Finished installation changes
SUCCESS: Installation changes committed
Router#
Router#
Router#request platform software package install rp 0 file
bootflash:Active_Dir/asr1000rp2-{elcbase,elcspa}*03.13.00.S.154-3.S-ext*.pkg slot 4
--- Starting local lock acquisition on R0 ---
Finished local lock acquisition on R0
--- Starting installation state synchronization ---
Finished installation state synchronization
--- Starting file path checking ---
Finished file path checking
--- Starting image file verification ---
Checking image file names
Locating image files and validating name syntax
 Found asr1000rp2-elcbase.03.13.00.S.154-3.S-ext.pkg
 Found asr1000rp2-elcspa.03.13.00.S.154-3.S-ext.pkg
Verifying image file locations
Inspecting image file types
Processing image file constraints
Creating candidate provisioning file
Finished image file verification
--- Starting candidate package set construction ---
Verifying existing software set
Processing candidate provisioning file
Constructing working set for candidate package set
Constructing working set for running package set
Checking command output
Constructing merge of running and candidate packages
Checking if resulting candidate package set would be complete
Finished candidate package set construction
--- Starting compatibility testing ---
Determining whether candidate package set is compatible
WARNING:
WARNING: Candidate software combination not found in compatibility database
WARNING:
Determining whether installation is valid
Creating matrix_file by locate_latest_matrix_file /tmp/issu/provision/sw
WARNING:
WARNING: Candidate software combination not found in compatibility database
WARNING:
WARNING:
WARNING: Candidate software combination not found in compatibility database
WARNING:
Software sets are identified as compatible
Verifying image type compatibility
Checking IPC compatibility with running software
Checking candidate package set infrastructure compatibility
Checking infrastructure compatibility with running software
Checking package specific compatibility
Finished compatibility testing
--- Starting impact testing ---
Checking operational impact of change

```

```

Finished impact testing
--- Starting list of software package changes ---
No old package files removed
New files list:
 Added asr1000rp2-elcbase.03.13.00.S.154-3.S-ext.pkg
 Added asr1000rp2-elcspa.03.13.00.S.154-3.S-ext.pkg
Finished list of software package changes
--- Starting commit of software changes ---
Updating provisioning rollback files
Creating pending provisioning file
Committing provisioning file
Finished commit of software changes
--- Starting analysis of software changes ---
Finished analysis of software changes
--- Starting update running software ---
Blocking peer synchronization of operating information
Creating the command set placeholder directory
 Finding latest command set
 Finding latest command shortlist lookup file
 Finding latest command shortlist file
 Assembling CLI output libraries
 Assembling CLI input libraries
 Assembling Dynamic configuration files
 Applying interim IPC and database definitions
 Replacing running software
 Replacing CLI software
 Restarting software
 Applying final IPC and database definitions
*Aug 4 19:41:12.290 IST: %MDR-5-CARD_RESTART: R0/0: card_mdr: Minimal Disruptive Restart
 SIP4 to acquire provisioned software
*Aug 4 19:41:22.408 IST: %CMCC-5-SPA_MDR_INIT: SIP4: cmcc: SPA0 initiated Minimal Disruptive
Restart Generating software version information
 Notifying running software of updates
 Unblocking peer synchronization of operating information
Unmounting old packages
Cleaning temporary installation files
 Finished update running software

SUCCESS: Finished installing software.
*Aug 4 19:42:53.778 IST: %IOSXE_OIR-6-ONLINECARD: Card (cc) online in slot 4
*Aug 4 19:42:57.364 IST: %IOSXE_OIR-6-INSSPA: SPA inserted in subslot 4/0
*Aug 4 19:43:17.541 IST: %LINK-3-UPDOWN: SIP4/0: Interface EOBC0/1, changed state to up
*Aug 4 19:43:25.251 IST: %SPA_OIR-6-ONLINECARD: SPA (BUILT-IN-2T+20X1GE) online in subslot
4/0
*Aug 4 19:43:25.291 IST: %CMCC-5-SPA_MDR_DONE: SIP4: cmcc: SPA0 completed Minimal Disruptive
Restart
*Aug 4 19:43:26.815 IST: %LINK-3-UPDOWN: SIP4/0: Interface GigabitEthernet4/0/0, changed
state to up
*Aug 4 19:43:28.267 IST: %LINK-3-UPDOWN: SIP4/0: Interface GigabitEthernet4/0/1, changed
state to up
Router# issu commitversion
--- Starting local lock acquisition on R0 ---
Finished local lock acquisition on R0
--- Starting installation changes ---
Cancelling rollback timer
Finished installation changes
SUCCESS: Installation changes committed
Router#
Router#
Router# request platform software package install rp 0 file
bootflash:Active_Dir/asr1000rp2-esp*03.13.00.S.154-3.S-ext*.pkg slot 1
--- Starting local lock acquisition on R0 ---
Finished local lock acquisition on R0
--- Starting installation state synchronization ---

```

```
Finished installation state synchronization
--- Starting file path checking ---
Finished file path checking
--- Starting image file verification ---
Checking image file names
Locating image files and validating name syntax
 Found asr1000rp2-espbase.03.13.00.S.154-3.S-ext.pkg
 Found asr1000rp2-esp86base.03.13.00.S.154-3.S-ext.pkg
Verifying image file locations
Inspecting image file types
Processing image file constraints
Creating candidate provisioning file
Finished image file verification
--- Starting candidate package set construction ---
Verifying existing software set
Processing candidate provisioning file
Constructing working set for candidate package set
Constructing working set for running package set
Checking command output
Constructing merge of running and candidate packages
Checking if resulting candidate package set would be complete
Finished candidate package set construction
--- Starting compatibility testing ---
Determining whether candidate package set is compatible
WARNING:
WARNING: Candidate software combination not found in compatibility database
WARNING:
Determining whether installation is valid
Creating matrix_file by locate_latest_matrix_file /tmp/issu/provision/sw
WARNING:
WARNING: Candidate software combination not found in compatibility database
WARNING:
WARNING:
WARNING: Candidate software combination not found in compatibility database
WARNING:
Software sets are identified as compatible
Verifying image type compatibility
Checking IPC compatibility with running software
Checking candidate package set infrastructure compatibility
Checking infrastructure compatibility with running software
Checking package specific compatibility
Finished compatibility testing
--- Starting impact testing ---
Checking operational impact of change
Finished impact testing
--- Starting list of software package changes ---
No old package files removed
New files list:
 Added asr1000rp2-espbase.03.13.00.S.154-3.S-ext.pkg
 Added asr1000rp2-esp86base.03.13.00.S.154-3.S-ext.pkg
Finished list of software package changes
--- Starting commit of software changes ---
Updating provisioning rollback files
Creating pending provisioning file
Committing provisioning file
Finished commit of software changes
--- Starting analysis of software changes ---
Finished analysis of software changes
--- Starting update running software ---
Blocking peer synchronization of operating information
Creating the command set placeholder directory
 Finding latest command set
 Finding latest command shortlist lookup file
 Finding latest command shortlist file
```

```

Assembling CLI output libraries
Assembling CLI input libraries
Assembling Dynamic configuration files
Applying interim IPC and database definitions
Replacing running software
Replacing CLI software
Restarting software
 Restarting ESP1
Applying final IPC and database definitions
*Aug 4 19:29:16.751 IST: %IOSXE_OIR-6-OFFLINECARD: Card (fp) offline in slot F1
*Aug 4 19:29:18.172 IST: %CMRP-6-FP_HA_STATUS: R0/0: cmand: F0 redundancy state is Active
with no Standby Generating software version information
 Notifying running software of updates
 Unblocking peer synchronization of operating information
Unmounting old packages
Cleaning temporary installation files
 Finished update running software

SUCCESS: Finished installing software.
Router#
*Aug 4 19:30:50.972 IST: %CPPHA-7-START: F1: cpp_ha: CPP 0 preparing image
/tmp/sw/fp/1/0/fpx86/mount/usr/cpp/bin/qfp-ucode-esp40
*Aug 4 19:30:51.362 IST: %CPPHA-7-START: F1: cpp_ha: CPP 0 startup init image
/tmp/sw/fp/1/0/fpx86/mount/usr/cpp/bin/qfp-ucode-esp40
*Aug 4 19:30:53.088 IST: %IOSXE_OIR-6-ONLINECARD: Card (fp) online in slot F1
Router#
Router# issu commitversion
--- Starting local lock acquisition on R0 ---
Finished local lock acquisition on R0
--- Starting installation changes ---
Cancelling rollback timer
Finished installation changes
SUCCESS: Installation changes committed
Router#
Router#
Router# request platform software package install rp 0 file
bootflash:Active_Dir/asr1000rp2-esp*03.13.00.S.154-3.S-ext*.pkg slot 0
--- Starting local lock acquisition on R0 ---
Finished local lock acquisition on R0
--- Starting installation state synchronization ---
Finished installation state synchronization
--- Starting file path checking ---
Finished file path checking
--- Starting image file verification ---
Checking image file names
Locating image files and validating name syntax
 Found asr1000rp2-espbase.03.13.00.S.154-3.S-ext.pkg
 Found asr1000rp2-esp86base.03.13.00.S.154-3.S-ext.pkg
Verifying image file locations
Inspecting image file types
Processing image file constraints
Creating candidate provisioning file
*Aug 4 19:31:14.730 IST: %CPPHA-7-START: F1: cpp_ha: CPP 0 running init image
/tmp/sw/fp/1/0/fpx86/mount/usr/cpp/bin/qfp-ucode-esp40
*Aug 4 19:31:15.079 IST: %CPPHA-7-READY: F1: cpp_ha: CPP 0 loading and initialization
completeFinished image file verification
--- Starting candidate package set construction ---
Verifying existing software set
*Aug 4 19:31:15.309 IST: %IOSXE-6-PLATFORM: F1: cpp_cp: Process
CPP_PFILTER_EA_EVENT_API_CALL_REGISTERProcessing candidate provisioning file
*Aug 4 19:31:18.010 IST: %CMRP-6-FP_HA_STATUS: R0/0: cmand: F0 redundancy state is Active
with ready StandbyConstructing working set for candidate package set
Constructing working set for running package set
Checking command output

```

```

Constructing merge of running and candidate packages
Checking if resulting candidate package set would be complete
Finished candidate package set construction
--- Starting compatibility testing ---
Determining whether candidate package set is compatible
WARNING:
WARNING: Candidate software combination not found in compatibility database
WARNING:
Determining whether installation is valid
Creating matrix_file by locate_latest_matrix_file /tmp/issu/provision/sw
Software sets are identified as compatible
Verifying image type compatibility
Checking IPC compatibility with running software
Checking candidate package set infrastructure compatibility
Checking infrastructure compatibility with running software
Checking package specific compatibility
Finished compatibility testing
--- Starting impact testing ---
Checking operational impact of change
Finished impact testing
--- Starting list of software package changes ---
Old files list:
 Removed asr1000rp2-espbase.03.12.01.S.154-2.S.pkg
 Removed asr1000rp2-esp86base.03.12.01.S.154-2.S.pkg
No new package files added
Finished list of software package changes
--- Starting commit of software changes ---
Updating provisioning rollback files
Creating pending provisioning file
Committing provisioning file
Finished commit of software changes
--- Starting analysis of software changes ---
Finished analysis of software changes
--- Starting update running software ---
Blocking peer synchronization of operating information
Creating the command set placeholder directory
 Finding latest command set
 Finding latest command shortlist lookup file
 Finding latest command shortlist file
 Assembling CLI output libraries
 Assembling CLI input libraries
 Assembling Dynamic configuration files
 Applying interim IPC and database definitions
 Replacing running software
 Replacing CLI software
 Restarting software
 Restarting ESP0
 Applying final IPC and database definitions
*Aug 4 19:32:46.187 IST: %IOSXE_OIR-6-OFFLINECARD: Card (fp) offline in slot F0
*Aug 4 19:32:46.539 IST: %CMRP-6-FP_HA_STATUS: R0/0: cmand: F1 redundancy state is Active
 Generating software version information
 Notifying running software of updates
 Unblocking peer synchronization of operating information
Unmounting old packages
Cleaning temporary installation files
 Finished update running software

SUCCESS: Finished installing software.
Router#
*Aug 4 19:34:19.748 IST: %CPPHA-7-START: F0: cpp_ha: CPP 0 preparing image
/tmp/sw/fp/0/0/fpx86/mount/usr/cpp/bin/qfp-ucode-esp40
*Aug 4 19:34:20.139 IST: %CPPHA-7-START: F0: cpp_ha: CPP 0 startup init image
/tmp/sw/fp/0/0/fpx86/mount/usr/cpp/bin/qfp-ucode-esp40
*Aug 4 19:34:21.858 IST: %IOSXE_OIR-6-ONLINECARD: Card (fp) online in slot F0

```

## Examples

```

*Aug 4 19:34:43.609 IST: %CPPHA-7-START: F0: cpp_ha: CPP 0 running init image
/tmp/sw/fp/0/0/fpx86/mount/usr/cpp/bin/qfp-ucode-esp40
*Aug 4 19:34:43.958 IST: %CPPHA-7-READY: F0: cpp_ha: CPP 0 loading and initialization
complete
*Aug 4 19:34:44.190 IST: %IOSXE-6-PLATFORM: F0: cpp_cp: Process
CPP_FILTER_EA_EVENT_API_CALL_REGISTER
*Aug 4 19:34:46.890 IST: %CMRP-6-FP_HA_STATUS: R0/0: cmdand: F0 redundancy state is Standby
Router#
Router#
Chassis type: ASR1013
Slot Type State Insert time (ago)

2 ASR1000-SIP40 ok 1d04h
2/0 SPA-1X10GE-L-V2 ok 1d04h
2/1 SPA-1X10GE-L-V2 ok 1d04h
2/2 SPA-1X10GE-L-V2 ok 1d04h
2/3 SPA-1X10GE-L-V2 ok 1d04h
4 ASR1000-2T+20X1GE ok 1d04h
4/0 BUILT-IN-2T+20X1GE ok 1d04h
R0 ASR1000-RP2 ok, active 1d04h
R1 ASR1000-RP2 ok, standby 1d04h
F0 ASR1000-ESP100 ok, standby 1d04h
F1 ASR1000-ESP100 ok, active 1d04h
P0 ASR1013-PWR-AC ok 1d04h
P1 ASR1013-PWR-AC ok 1d04h
P2 ASR1013-PWR-AC ok 1d04h
P3 ASR1013-PWR-AC ps, fail 1d04h
Slot CPLD Version Firmware Version

2 00200800 15.3(3r)S
4 00200800 15.3(3r)S
R0 10021901 15.3(3r)S
R1 10021901 15.3(3r)S
F0 12071700 15.3(3r)S
F1 12071700 15.3(3r)S
Router#
Router# issu commitversion
--- Starting local lock acquisition on R0 ---
Finished local lock acquisition on R0
--- Starting installation changes ---
Cancelling rollback timer
Finished installation changes
SUCCESS: Installation changes committed
Router#
Router#
Router# request platform software package install rp 0 file
bootflash:Active_Dir/asr1000rp2*03.13.00.S.154-3.S-ext*.pkg force
--- Starting local lock acquisition on R0 ---
Finished local lock acquisition on R0
--- Starting installation state synchronization ---
Finished installation state synchronization
--- Starting file path checking ---
Finished file path checking
--- Starting image file verification ---
Checking image file names
Locating image files and validating name syntax
Found asr1000rp2-elcbase.03.13.00.S.154-3.S-ext.pkg
Found asr1000rp2-elcspa.03.13.00.S.154-3.S-ext.pkg
Found asr1000rp2-espbase.03.13.00.S.154-3.S-ext.pkg
Found asr1000rp2-esp86base.03.13.00.S.154-3.S-ext.pkg
Found asr1000rp2-rpaccess.03.13.00.S.154-3.S-ext.pkg
Found asr1000rp2-rpbase.03.13.00.S.154-3.S-ext.pkg
Found asr1000rp2-rpcontrol.03.13.00.S.154-3.S-ext.pkg
Found asr1000rp2-rpios-adventerprise9.03.13.00.S.154-3.S-ext.pkg

```



```

Found asr1000rp2-sipbase.03.13.00.S.154-3.S-ext.pkg
Found asr1000rp2-sipspa.03.13.00.S.154-3.S-ext.pkg
Verifying image file locations
Inspecting image file types
 WARNING: In-service installation of IOSD package
 WARNING: requires software redundancy on target RP
 WARNING: or on-reboot parameter
 WARNING: Automatically setting the on-reboot flag
 WARNING: In-service installation of RP Base package
 WARNING: requires software reboot of target RP
Processing image file constraints
Creating candidate provisioning file
Finished image file verification
--- Starting candidate package set construction ---
Verifying existing software set
Processing candidate provisioning file
Constructing working set for candidate package set
Constructing working set for running package set
Checking command output
Constructing merge of running and candidate packages
Checking if resulting candidate package set would be complete
Finished candidate package set construction
--- Starting compatibility testing ---
Determining whether candidate package set is compatible
Determining whether installation is valid
Determining whether installation is valid ... skipped
Verifying image type compatibility
Checking IPC compatibility for candidate software
Checking candidate package set infrastructure compatibility
Checking infrastructure compatibility with running software
Checking infrastructure compatibility with running software ... skipped
Checking package specific compatibility
Finished compatibility testing
--- Starting list of software package changes ---
Old files list:
 Removed asr1000rp2-elcbase.03.12.01.S.154-2.S.pkg
 Removed asr1000rp2-elcspa.03.12.01.S.154-2.S.pkg
 Removed asr1000rp2-rpaccess.03.12.01.S.154-2.S.pkg
 Removed asr1000rp2-rpbase.03.12.01.S.154-2.S.pkg
 Removed asr1000rp2-rpcontrol.03.12.01.S.154-2.S.pkg
 Removed asr1000rp2-rpios-adventerprisek9.03.12.01.S.154-2.S.pkg
 Removed asr1000rp2-sipbase.03.12.01.S.154-2.S.pkg
 Removed asr1000rp2-sipspa.03.12.01.S.154-2.S.pkg
New files list:
 Added asr1000rp2-rpaccess.03.13.00.S.154-3.S-ext.pkg
 Added asr1000rp2-rpbase.03.13.00.S.154-3.S-ext.pkg
 Added asr1000rp2-rpcontrol.03.13.00.S.154-3.S-ext.pkg
 Added asr1000rp2-rpios-adventerprisek9.03.13.00.S.154-3.S-ext.pkg
Finished list of software package changes
--- Starting commit of software changes ---
Updating provisioning rollback files
Creating pending provisioning file
Committing provisioning file
Finished commit of software changes
SUCCESS: Software provisioned. New software will load on reboot.
Router#
Router#
Router# show version R0 provisioned
Package: Provisioning File, version: n/a, status: active
 File: bootflash:Active_Dir/packages.conf, on: RP0
 Built: n/a, by: n/a
 File SHA1 checksum: c79075780592aec1312725f4a2357a034fda2d3b
Package: rpbase, version: 03.13.00.S.154-3.S-ext, status: n/a
 File: bootflash:Active_Dir/asr1000rp2-rpbase.03.13.00.S.154-3.S-ext.pkg, on: RP0

```

## Examples

```

 Built: 2013-07-25_22.55, by: mcpre
 File SHA1 checksum: 4f655c54bb95b4dfa24a0d25ebf97cf8527c69e9
Package: rpcontrol, version: 03.13.00.S.154-3.S-ext, status: n/a
 File: bootflash:Active_Dir/asr1000rp2-rpcontrol.03.13.00.S.154-3.S-ext.pkg, on: RP0/0
 Built: 2013-07-25_22.55, by: mcpre
 File SHA1 checksum: 8a0a45ea5c7a656c0eef6726174461584f182c78
Package: rpios-adventerprisek9, version: 03.13.00.S.154-3.S-ext, status: n/a
 File: bootflash:Active_Dir/asr1000rp2-rpios-adventerprisek9.03.13.00.S.154-3.S-ext.pkg,
on: RP0/0
 Built: 2013-07-25_23.00, by: mcpre
 File SHA1 checksum: 85e9eab826bff2194ef568a56c76453625383ad2
Package: rpaccess, version: 03.13.00.S.154-3.S-ext, status: n/a
 File: bootflash:Active_Dir/asr1000rp2-rpaccess.03.13.00.S.154-3.S-ext.pkg, on: RP0/0
 Built: 2013-07-25_22.55, by: mcpre
 File SHA1 checksum: a360dff0fd76a9b1ae67cda9116c97b62f25ab09
Package: rpcontrol, version: 03.13.00.S.154-3.S-ext, status: n/a
 File: bootflash:Active_Dir/asr1000rp2-rpcontrol.03.13.00.S.154-3.S-ext.pkg, on: RP0/1
 Built: 2013-07-25_22.55, by: mcpre
 File SHA1 checksum: 8a0a45ea5c7a656c0eef6726174461584f182c78
Package: rpios-adventerprisek9, version: 03.13.00.S.154-3.S-ext, status: n/a
 File: bootflash:Active_Dir/asr1000rp2-rpios-adventerprisek9.03.13.00.S.154-3.S-ext.pkg,
on: RP0/1
 Built: 2013-07-25_23.00, by: mcpre
 File SHA1 checksum: 85e9eab826bff2194ef568a56c76453625383ad2
Package: rpaccess, version: 03.13.00.S.154-3.S-ext, status: n/a
 File: bootflash:Active_Dir/asr1000rp2-rpaccess.03.13.00.S.154-3.S-ext.pkg, on: RP0/1
 Built: 2013-07-25_22.55, by: mcpre
 File SHA1 checksum: a360dff0fd76a9b1ae67cda9116c97b62f25ab09
Package: rpbase, version: 03.13.00.S.154-3.S-ext, status: n/a
 File: bootflash:Active_Dir/asr1000rp2-rpbase.03.13.00.S.154-3.S-ext.pkg, on: RP1
 Built: 2013-07-25_22.55, by: mcpre
 File SHA1 checksum: 4f655c54bb95b4dfa24a0d25ebf97cf8527c69e9
Package: rpcontrol, version: 03.13.00.S.154-3.S-ext, status: n/a
 File: bootflash:Active_Dir/asr1000rp2-rpcontrol.03.13.00.S.154-3.S-ext.pkg, on: RP1/0
 Built: 2013-07-25_22.55, by: mcpre
 File SHA1 checksum: 8a0a45ea5c7a656c0eef6726174461584f182c78
Package: rpios-adventerprisek9, version: 03.13.00.S.154-3.S-ext, status: n/a
 File: bootflash:Active_Dir/asr1000rp2-rpios-adventerprisek9.03.13.00.S.154-3.S-ext.pkg,
on: RP1/0
 Built: 2013-07-25_23.00, by: mcpre
 File SHA1 checksum: 85e9eab826bff2194ef568a56c76453625383ad2
Package: rpaccess, version: 03.13.00.S.154-3.S-ext, status: n/a
 File: bootflash:Active_Dir/asr1000rp2-rpaccess.03.13.00.S.154-3.S-ext.pkg, on: RP1/0
 Built: 2013-07-25_22.55, by: mcpre
 File SHA1 checksum: a360dff0fd76a9b1ae67cda9116c97b62f25ab09
Package: rpcontrol, version: 03.13.00.S.154-3.S-ext, status: n/a
 File: bootflash:Active_Dir/asr1000rp2-rpcontrol.03.13.00.S.154-3.S-ext.pkg, on: RP1/1
 Built: 2013-07-25_22.55, by: mcpre
 File SHA1 checksum: 8a0a45ea5c7a656c0eef6726174461584f182c78
Package: rpios-adventerprisek9, version: 03.13.00.S.154-3.S-ext, status: n/a
 File: bootflash:Active_Dir/asr1000rp2-rpios-adventerprisek9.03.13.00.S.154-3.S-ext.pkg,
on: RP1/1
 Built: 2013-07-25_23.00, by: mcpre
 File SHA1 checksum: 85e9eab826bff2194ef568a56c76453625383ad2
Package: rpaccess, version: 03.13.00.S.154-3.S-ext, status: n/a
 File: bootflash:Active_Dir/asr1000rp2-rpaccess.03.13.00.S.154-3.S-ext.pkg, on: RP1/1
 Built: 2013-07-25_22.55, by: mcpre
 File SHA1 checksum: a360dff0fd76a9b1ae67cda9116c97b62f25ab09
Package: espbase, version: 03.13.00.S.154-3.S-ext, status: n/a
 File: bootflash:Active_Dir/asr1000rp2-espbase.03.13.00.S.154-3.S-ext.pkg, on: ESP0
 Built: 2013-07-25_21.16, by: mcpre
 File SHA1 checksum: 2fe0ede1545e3f8260b7d453653e812500f0d7b0
Package: esp86base, version: 03.13.00.S.154-3.S-ext, status: n/a
 File: bootflash:Active_Dir/asr1000rp2-esp86base.03.13.00.S.154-3.S-ext.pkg, on: ESP0

```

```

Built: 2013-07-25_22.55, by: mcpre
File SHA1 checksum: 571b8bb3866341badd6e24de677b98409f0c789c
Package: espbase, version: 03.13.00.S.154-3.S-ext, status: n/a
File: bootflash:Active_Dir/asr1000rp2-espbase.03.13.00.S.154-3.S-ext.pkg, on: ESP1
Built: 2013-07-25_21.16, by: mcpre
File SHA1 checksum: 2fe0ede1545e3f8260b7d453653e812500f0d7b0
Package: esp86base, version: 03.13.00.S.154-3.S-ext, status: n/a
File: bootflash:Active_Dir/asr1000rp2-esp86base.03.13.00.S.154-3.S-ext.pkg, on: ESP1
Built: 2013-07-25_22.55, by: mcpre
File SHA1 checksum: 571b8bb3866341badd6e24de677b98409f0c789c
Package: sipbase, version: 03.13.00.S.154-3.S-ext, status: n/a
File: bootflash:Active_Dir/asr1000rp2-sipbase.03.13.00.S.154-3.S-ext.pkg, on: SIP0
Built: 2013-07-25_21.16, by: mcpre
File SHA1 checksum: 3b6a4838972840a995ff22e73fd2bae910b268a7
Package: elcbase, version: 03.13.00.S.154-3.S-ext, status: n/a
File: bootflash:Active_Dir/asr1000rp2-elcbase.03.13.00.S.154-3.S-ext.pkg, on: SIP0
Built: 2013-07-25_21.16, by: mcpre
File SHA1 checksum: 99f8dc925083b118626a4e82d93079050db96826
Package: sipspa, version: 03.13.00.S.154-3.S-ext, status: n/a
File: bootflash:Active_Dir/asr1000rp2-sipspa.03.13.00.S.154-3.S-ext.pkg, on: SIP0/0
Built: 2013-07-25_21.16, by: mcpre
File SHA1 checksum: 6d12280b5cc33d17d752f475bf340b77ef3451ca
Package: elcspa, version: 03.13.00.S.154-3.S-ext, status: n/a
File: bootflash:Active_Dir/asr1000rp2-elcspa.03.13.00.S.154-3.S-ext.pkg, on: SIP0/0
Built: 2013-07-25_21.16, by: mcpre
File SHA1 checksum: 94763274fc807489410e299a45fd73fce9d67499
Package: sipspa, version: 03.13.00.S.154-3.S-ext, status: n/a
File: bootflash:Active_Dir/asr1000rp2-sipspa.03.13.00.S.154-3.S-ext.pkg, on: SIP0/1
Built: 2013-07-25_21.16, by: mcpre
File SHA1 checksum: 6d12280b5cc33d17d752f475bf340b77ef3451ca
Package: elcspa, version: 03.13.00.S.154-3.S-ext, status: n/a
File: bootflash:Active_Dir/asr1000rp2-elcspa.03.13.00.S.154-3.S-ext.pkg, on: SIP0/1
Built: 2013-07-25_21.16, by: mcpre
File SHA1 checksum: 94763274fc807489410e299a45fd73fce9d67499
Package: sipspa, version: 03.13.00.S.154-3.S-ext, status: n/a
File: bootflash:Active_Dir/asr1000rp2-sipspa.03.13.00.S.154-3.S-ext.pkg, on: SIP0/2
Built: 2013-07-25_21.16, by: mcpre
File SHA1 checksum: 6d12280b5cc33d17d752f475bf340b77ef3451ca
Package: elcspa, version: 03.13.00.S.154-3.S-ext, status: n/a
File: bootflash:Active_Dir/asr1000rp2-elcspa.03.13.00.S.154-3.S-ext.pkg, on: SIP0/2
Built: 2013-07-25_21.16, by: mcpre
File SHA1 checksum: 94763274fc807489410e299a45fd73fce9d67499
Package: sipspa, version: 03.13.00.S.154-3.S-ext, status: n/a
File: bootflash:Active_Dir/asr1000rp2-sipspa.03.13.00.S.154-3.S-ext.pkg, on: SIP0/3
Built: 2013-07-25_21.16, by: mcpre
File SHA1 checksum: 6d12280b5cc33d17d752f475bf340b77ef3451ca
Package: elcspa, version: 03.13.00.S.154-3.S-ext, status: n/a
File: bootflash:Active_Dir/asr1000rp2-elcspa.03.13.00.S.154-3.S-ext.pkg, on: SIP0/3
Built: 2013-07-25_21.16, by: mcpre
File SHA1 checksum: 94763274fc807489410e299a45fd73fce9d67499
Package: sipbase, version: 03.13.00.S.154-3.S-ext, status: n/a
File: bootflash:Active_Dir/asr1000rp2-sipbase.03.13.00.S.154-3.S-ext.pkg, on: SIP1
Built: 2013-07-25_21.16, by: mcpre
File SHA1 checksum: 3b6a4838972840a995ff22e73fd2bae910b268a7
Package: elcbase, version: 03.13.00.S.154-3.S-ext, status: n/a
File: bootflash:Active_Dir/asr1000rp2-elcbase.03.13.00.S.154-3.S-ext.pkg, on: SIP1
Built: 2013-07-25_21.16, by: mcpre
File SHA1 checksum: 99f8dc925083b118626a4e82d93079050db96826
Package: sipspa, version: 03.13.00.S.154-3.S-ext, status: n/a
File: bootflash:Active_Dir/asr1000rp2-sipspa.03.13.00.S.154-3.S-ext.pkg, on: SIP1/0
Built: 2013-07-25_21.16, by: mcpre
File SHA1 checksum: 6d12280b5cc33d17d752f475bf340b77ef3451ca
Package: elcspa, version: 03.13.00.S.154-3.S-ext, status: n/a
File: bootflash:Active_Dir/asr1000rp2-elcspa.03.13.00.S.154-3.S-ext.pkg, on: SIP1/0

```

## Examples

```

Built: 2013-07-25_21.16, by: mcpre
File SHA1 checksum: 94763274fc807489410e299a45fd73fce9d67499
Package: sipspa, version: 03.13.00.S.154-3.S-ext, status: n/a
File: bootflash:Active_Dir/asr1000rp2-sipspa.03.13.00.S.154-3.S-ext.pkg, on: SIP1/1
Built: 2013-07-25_21.16, by: mcpre
File SHA1 checksum: 6d12280b5cc33d17d752f475bf340b77ef3451ca
Package: elcspa, version: 03.13.00.S.154-3.S-ext, status: n/a
File: bootflash:Active_Dir/asr1000rp2-elcspa.03.13.00.S.154-3.S-ext.pkg, on: SIP1/1
Built: 2013-07-25_21.16, by: mcpre
File SHA1 checksum: 94763274fc807489410e299a45fd73fce9d67499
Package: sipspa, version: 03.13.00.S.154-3.S-ext, status: n/a
File: bootflash:Active_Dir/asr1000rp2-sipspa.03.13.00.S.154-3.S-ext.pkg, on: SIP1/2
Built: 2013-07-25_21.16, by: mcpre
File SHA1 checksum: 6d12280b5cc33d17d752f475bf340b77ef3451ca
Package: elcspa, version: 03.13.00.S.154-3.S-ext, status: n/a
File: bootflash:Active_Dir/asr1000rp2-elcspa.03.13.00.S.154-3.S-ext.pkg, on: SIP1/2
Built: 2013-07-25_21.16, by: mcpre
File SHA1 checksum: 94763274fc807489410e299a45fd73fce9d67499
Package: sipspa, version: 03.13.00.S.154-3.S-ext, status: n/a
File: bootflash:Active_Dir/asr1000rp2-sipspa.03.13.00.S.154-3.S-ext.pkg, on: SIP1/3
Built: 2013-07-25_21.16, by: mcpre
File SHA1 checksum: 6d12280b5cc33d17d752f475bf340b77ef3451ca
Package: elcspa, version: 03.13.00.S.154-3.S-ext, status: n/a
File: bootflash:Active_Dir/asr1000rp2-elcspa.03.13.00.S.154-3.S-ext.pkg, on: SIP1/3
Built: 2013-07-25_21.16, by: mcpre
File SHA1 checksum: 94763274fc807489410e299a45fd73fce9d67499
Package: sipbase, version: 03.13.00.S.154-3.S-ext, status: n/a
File: bootflash:Active_Dir/asr1000rp2-sipbase.03.13.00.S.154-3.S-ext.pkg, on: SIP2
Built: 2013-07-25_21.16, by: mcpre
File SHA1 checksum: 3b6a4838972840a995ff22e73fd2bae910b268a7
Package: elcbase, version: 03.13.00.S.154-3.S-ext, status: n/a
File: bootflash:Active_Dir/asr1000rp2-elcbase.03.13.00.S.154-3.S-ext.pkg, on: SIP2
Built: 2013-07-25_21.16, by: mcpre
File SHA1 checksum: 99f8dc925083b118626a4e82d93079050db96826
Package: sipspa, version: 03.13.00.S.154-3.S-ext, status: n/a
File: bootflash:Active_Dir/asr1000rp2-sipspa.03.13.00.S.154-3.S-ext.pkg, on: SIP2/0
Built: 2013-07-25_21.16, by: mcpre
File SHA1 checksum: 6d12280b5cc33d17d752f475bf340b77ef3451ca
Package: elcspa, version: 03.13.00.S.154-3.S-ext, status: n/a
File: bootflash:Active_Dir/asr1000rp2-elcspa.03.13.00.S.154-3.S-ext.pkg, on: SIP2/0
Built: 2013-07-25_21.16, by: mcpre
File SHA1 checksum: 94763274fc807489410e299a45fd73fce9d67499
Package: sipspa, version: 03.13.00.S.154-3.S-ext, status: n/a
File: bootflash:Active_Dir/asr1000rp2-sipspa.03.13.00.S.154-3.S-ext.pkg, on: SIP2/1
Built: 2013-07-25_21.16, by: mcpre
File SHA1 checksum: 6d12280b5cc33d17d752f475bf340b77ef3451ca
Package: elcspa, version: 03.13.00.S.154-3.S-ext, status: n/a
File: bootflash:Active_Dir/asr1000rp2-elcspa.03.13.00.S.154-3.S-ext.pkg, on: SIP2/1
Built: 2013-07-25_21.16, by: mcpre
File SHA1 checksum: 94763274fc807489410e299a45fd73fce9d67499
Package: sipspa, version: 03.13.00.S.154-3.S-ext, status: n/a
File: bootflash:Active_Dir/asr1000rp2-sipspa.03.13.00.S.154-3.S-ext.pkg, on: SIP2/2
Built: 2013-07-25_21.16, by: mcpre
File SHA1 checksum: 6d12280b5cc33d17d752f475bf340b77ef3451ca
Package: elcspa, version: 03.13.00.S.154-3.S-ext, status: n/a
File: bootflash:Active_Dir/asr1000rp2-elcspa.03.13.00.S.154-3.S-ext.pkg, on: SIP2/2
Built: 2013-07-25_21.16, by: mcpre
File SHA1 checksum: 94763274fc807489410e299a45fd73fce9d67499
Package: sipspa, version: 03.13.00.S.154-3.S-ext, status: n/a
File: bootflash:Active_Dir/asr1000rp2-sipspa.03.13.00.S.154-3.S-ext.pkg, on: SIP2/3
Built: 2013-07-25_21.16, by: mcpre
File SHA1 checksum: 6d12280b5cc33d17d752f475bf340b77ef3451ca
Package: elcspa, version: 03.13.00.S.154-3.S-ext, status: n/a
File: bootflash:Active_Dir/asr1000rp2-elcspa.03.13.00.S.154-3.S-ext.pkg, on: SIP2/3

```

```

Built: 2013-07-25_21.16, by: mcpre
File SHA1 checksum: 94763274fc807489410e299a45fd73fce9d67499
Package: sipbase, version: 03.13.00.S.154-3.S-ext, status: n/a
File: bootflash:Active_Dir/asr1000rp2-sipbase.03.13.00.S.154-3.S-ext.pkg, on: SIP3
Built: 2013-07-25_21.16, by: mcpre
File SHA1 checksum: 3b6a4838972840a995ff22e73fd2bae910b268a7
Package: elcbase, version: 03.13.00.S.154-3.S-ext, status: n/a
File: bootflash:Active_Dir/asr1000rp2-elcbase.03.13.00.S.154-3.S-ext.pkg, on: SIP3
Built: 2013-07-25_21.16, by: mcpre
File SHA1 checksum: 99f8dc925083b118626a4e82d93079050db96826
Package: sipspa, version: 03.13.00.S.154-3.S-ext, status: n/a
File: bootflash:Active_Dir/asr1000rp2-sipspa.03.13.00.S.154-3.S-ext.pkg, on: SIP3/0
Built: 2013-07-25_21.16, by: mcpre
File SHA1 checksum: 6d12280b5cc33d17d752f475bf340b77ef3451ca
Package: elcspa, version: 03.13.00.S.154-3.S-ext, status: n/a
File: bootflash:Active_Dir/asr1000rp2-elcspa.03.13.00.S.154-3.S-ext.pkg, on: SIP3/0
Built: 2013-07-25_21.16, by: mcpre
File SHA1 checksum: 94763274fc807489410e299a45fd73fce9d67499
Package: sipspa, version: 03.13.00.S.154-3.S-ext, status: n/a
File: bootflash:Active_Dir/asr1000rp2-sipspa.03.13.00.S.154-3.S-ext.pkg, on: SIP3/1
Built: 2013-07-25_21.16, by: mcpre
File SHA1 checksum: 6d12280b5cc33d17d752f475bf340b77ef3451ca
Package: elcspa, version: 03.13.00.S.154-3.S-ext, status: n/a
File: bootflash:Active_Dir/asr1000rp2-elcspa.03.13.00.S.154-3.S-ext.pkg, on: SIP3/1
Built: 2013-07-25_21.16, by: mcpre
File SHA1 checksum: 94763274fc807489410e299a45fd73fce9d67499
Package: sipspa, version: 03.13.00.S.154-3.S-ext, status: n/a
File: bootflash:Active_Dir/asr1000rp2-sipspa.03.13.00.S.154-3.S-ext.pkg, on: SIP3/2
Built: 2013-07-25_21.16, by: mcpre
File SHA1 checksum: 6d12280b5cc33d17d752f475bf340b77ef3451ca
Package: elcspa, version: 03.13.00.S.154-3.S-ext, status: n/a
File: bootflash:Active_Dir/asr1000rp2-elcspa.03.13.00.S.154-3.S-ext.pkg, on: SIP3/2
Built: 2013-07-25_21.16, by: mcpre
File SHA1 checksum: 94763274fc807489410e299a45fd73fce9d67499
Package: sipspa, version: 03.13.00.S.154-3.S-ext, status: n/a
File: bootflash:Active_Dir/asr1000rp2-sipspa.03.13.00.S.154-3.S-ext.pkg, on: SIP3/3
Built: 2013-07-25_21.16, by: mcpre
File SHA1 checksum: 6d12280b5cc33d17d752f475bf340b77ef3451ca
Package: elcspa, version: 03.13.00.S.154-3.S-ext, status: n/a
File: bootflash:Active_Dir/asr1000rp2-elcspa.03.13.00.S.154-3.S-ext.pkg, on: SIP3/3
Built: 2013-07-25_21.16, by: mcpre
File SHA1 checksum: 94763274fc807489410e299a45fd73fce9d67499
Package: sipbase, version: 03.13.00.S.154-3.S-ext, status: n/a
File: bootflash:Active_Dir/asr1000rp2-sipbase.03.13.00.S.154-3.S-ext.pkg, on: SIP4
Built: 2013-07-25_21.16, by: mcpre
File SHA1 checksum: 3b6a4838972840a995ff22e73fd2bae910b268a7
Package: elcbase, version: 03.13.00.S.154-3.S-ext, status: n/a
File: bootflash:Active_Dir/asr1000rp2-elcbase.03.13.00.S.154-3.S-ext.pkg, on: SIP4
Built: 2013-07-25_21.16, by: mcpre
File SHA1 checksum: 99f8dc925083b118626a4e82d93079050db96826
Package: sipspa, version: 03.13.00.S.154-3.S-ext, status: n/a
File: bootflash:Active_Dir/asr1000rp2-sipspa.03.13.00.S.154-3.S-ext.pkg, on: SIP4/0
Built: 2013-07-25_21.16, by: mcpre
File SHA1 checksum: 6d12280b5cc33d17d752f475bf340b77ef3451ca
Package: elcspa, version: 03.13.00.S.154-3.S-ext, status: n/a
File: bootflash:Active_Dir/asr1000rp2-elcspa.03.13.00.S.154-3.S-ext.pkg, on: SIP4/0
Built: 2013-07-25_21.16, by: mcpre
File SHA1 checksum: 94763274fc807489410e299a45fd73fce9d67499
Package: sipspa, version: 03.13.00.S.154-3.S-ext, status: n/a
File: bootflash:Active_Dir/asr1000rp2-sipspa.03.13.00.S.154-3.S-ext.pkg, on: SIP4/1
Built: 2013-07-25_21.16, by: mcpre
File SHA1 checksum: 6d12280b5cc33d17d752f475bf340b77ef3451ca
Package: elcspa, version: 03.13.00.S.154-3.S-ext, status: n/a
File: bootflash:Active_Dir/asr1000rp2-elcspa.03.13.00.S.154-3.S-ext.pkg, on: SIP4/1

```

## Examples

```

 Built: 2013-07-25_21.16, by: mcpre
 File SHA1 checksum: 94763274fc807489410e299a45fd73fce9d67499
Package: sipspa, version: 03.13.00.S.154-3.S-ext, status: n/a
 File: bootflash:Active_Dir/asr1000rp2-sipspa.03.13.00.S.154-3.S-ext.pkg, on: SIP4/2
 Built: 2013-07-25_21.16, by: mcpre
 File SHA1 checksum: 6d12280b5cc33d17d752f475bf340b77ef3451ca
Package: elcspa, version: 03.13.00.S.154-3.S-ext, status: n/a
 File: bootflash:Active_Dir/asr1000rp2-elcspa.03.13.00.S.154-3.S-ext.pkg, on: SIP4/2
 Built: 2013-07-25_21.16, by: mcpre
 File SHA1 checksum: 94763274fc807489410e299a45fd73fce9d67499
Package: sipspa, version: 03.13.00.S.154-3.S-ext, status: n/a
 File: bootflash:Active_Dir/asr1000rp2-sipspa.03.13.00.S.154-3.S-ext.pkg, on: SIP4/3
 Built: 2013-07-25_21.16, by: mcpre
 File SHA1 checksum: 6d12280b5cc33d17d752f475bf340b77ef3451ca
Package: elcspa, version: 03.13.00.S.154-3.S-ext, status: n/a
 File: bootflash:Active_Dir/asr1000rp2-elcspa.03.13.00.S.154-3.S-ext.pkg, on: SIP4/3
 Built: 2013-07-25_21.16, by: mcpre
 File SHA1 checksum: 94763274fc807489410e299a45fd73fce9d67499
Package: sipbase, version: 03.13.00.S.154-3.S-ext, status: n/a
 File: bootflash:Active_Dir/asr1000rp2-sipbase.03.13.00.S.154-3.S-ext.pkg, on: SIP5
 Built: 2013-07-25_21.16, by: mcpre
 File SHA1 checksum: 3b6a4838972840a995ff22e73fd2bae910b268a7
Package: elcbase, version: 03.13.00.S.154-3.S-ext, status: n/a
 File: bootflash:Active_Dir/asr1000rp2-elcbase.03.13.00.S.154-3.S-ext.pkg, on: SIP5
 Built: 2013-07-25_21.16, by: mcpre
 File SHA1 checksum: 99f8dc925083b118626a4e82d93079050db96826
Package: sipspa, version: 03.13.00.S.154-3.S-ext, status: n/a
 File: bootflash:Active_Dir/asr1000rp2-sipspa.03.13.00.S.154-3.S-ext.pkg, on: SIP5/0
 Built: 2013-07-25_21.16, by: mcpre
 File SHA1 checksum: 6d12280b5cc33d17d752f475bf340b77ef3451ca
Package: elcspa, version: 03.13.00.S.154-3.S-ext, status: n/a
 File: bootflash:Active_Dir/asr1000rp2-elcspa.03.13.00.S.154-3.S-ext.pkg, on: SIP5/0
 Built: 2013-07-25_21.16, by: mcpre
 File SHA1 checksum: 94763274fc807489410e299a45fd73fce9d67499
Package: sipspa, version: 03.13.00.S.154-3.S-ext, status: n/a
 File: bootflash:Active_Dir/asr1000rp2-sipspa.03.13.00.S.154-3.S-ext.pkg, on: SIP5/1
 Built: 2013-07-25_21.16, by: mcpre
 File SHA1 checksum: 6d12280b5cc33d17d752f475bf340b77ef3451ca
Package: elcspa, version: 03.13.00.S.154-3.S-ext, status: n/a
 File: bootflash:Active_Dir/asr1000rp2-elcspa.03.13.00.S.154-3.S-ext.pkg, on: SIP5/1
 Built: 2013-07-25_21.16, by: mcpre
 File SHA1 checksum: 94763274fc807489410e299a45fd73fce9d67499
Package: sipspa, version: 03.13.00.S.154-3.S-ext, status: n/a
 File: bootflash:Active_Dir/asr1000rp2-sipspa.03.13.00.S.154-3.S-ext.pkg, on: SIP5/2
 Built: 2013-07-25_21.16, by: mcpre
 File SHA1 checksum: 6d12280b5cc33d17d752f475bf340b77ef3451ca
Package: elcspa, version: 03.13.00.S.154-3.S-ext, status: n/a
 File: bootflash:Active_Dir/asr1000rp2-elcspa.03.13.00.S.154-3.S-ext.pkg, on: SIP5/2
 Built: 2013-07-25_21.16, by: mcpre
 File SHA1 checksum: 94763274fc807489410e299a45fd73fce9d67499
Package: sipspa, version: 03.13.00.S.154-3.S-ext, status: n/a
 File: bootflash:Active_Dir/asr1000rp2-sipspa.03.13.00.S.154-3.S-ext.pkg, on: SIP5/3
 Built: 2013-07-25_21.16, by: mcpre
 File SHA1 checksum: 6d12280b5cc33d17d752f475bf340b77ef3451ca
Package: elcspa, version: 03.13.00.S.154-3.S-ext, status: n/a
 File: bootflash:Active_Dir/asr1000rp2-elcspa.03.13.00.S.154-3.S-ext.pkg, on: SIP5/3
 Built: 2013-07-25_21.16, by: mcpre
 File SHA1 checksum: 94763274fc807489410e299a45fd73fce9d67499
Router#
Router#
Router# show version R0 provisioned
Package: Provisioning File, version: n/a, status: active
 File: bootflash:Active_Dir/packages.conf, on: RP0
 Built: n/a, by: n/a

```

```

File SHA1 checksum: c79075780592aec1312725f4a2357a034fda2d3b
Package: rpbases, version: 03.12.01.S.154-2.S, status: active
File: bootflash:Active_Dir/asr1000rp2-rpbases.03.12.01.S.154-2.S.pkg, on: RP0
Built: 2013-03-25_18.48, by: mcpre
File SHA1 checksum: 3a9675142898cfac350d4e42f0e37bd9f4e48538
Package: rpcontrol, version: 03.12.01.S.154-2.S, status: active
File: bootflash:Active_Dir/asr1000rp2-rpcontrol.03.12.01.S.154-2.S.pkg, on: RP0/0
Built: 2013-03-25_18.48, by: mcpre
File SHA1 checksum: 87b11f863f67fdf2610ee0769b929baab4c3efad
Package: rpios-adventerprisek9, version: 03.12.01.S.154-2.S, status: active
File: bootflash:Active_Dir/asr1000rp2-rpios-adventerprisek9.03.12.01.S.154-2.S.pkg, on:
RP0/0
Built: 2013-03-25_18.51, by: mcpre
File SHA1 checksum: b487136319da0a327844d353c77e533c53c56053
Package: rpaccess, version: 03.12.01.S.154-2.S, status: active
File: bootflash:Active_Dir/asr1000rp2-rpaccess.03.12.01.S.154-2.S.pkg, on: RP0/0
Built: 2013-03-25_18.48, by: mcpre
File SHA1 checksum: 032bea36f74b19977b363243c99f02413b54104d
Package: rpcontrol, version: 03.12.01.S.154-2.S, status: n/a
File: bootflash:Active_Dir/asr1000rp2-rpcontrol.03.12.01.S.154-2.S.pkg, on: RP0/1
Built: 2013-03-25_18.48, by: mcpre
File SHA1 checksum: 87b11f863f67fdf2610ee0769b929baab4c3efad
Package: rpios-adventerprisek9, version: 03.12.01.S.154-2.S, status: n/a
File: bootflash:Active_Dir/asr1000rp2-rpios-adventerprisek9.03.12.01.S.154-2.S.pkg, on:
RP0/1
Built: 2013-03-25_18.51, by: mcpre
File SHA1 checksum: b487136319da0a327844d353c77e533c53c56053
Package: rpaccess, version: 03.12.01.S.154-2.S, status: n/a
File: bootflash:Active_Dir/asr1000rp2-rpaccess.03.12.01.S.154-2.S.pkg, on: RP0/1
Built: 2013-03-25_18.48, by: mcpre
File SHA1 checksum: 032bea36f74b19977b363243c99f02413b54104d
Package: rpbases, version: 03.12.01.S.154-2.S, status: n/a
File: bootflash:Active_Dir/asr1000rp2-rpbases.03.12.01.S.154-2.S.pkg, on: RP1
Built: 2013-03-25_18.48, by: mcpre
File SHA1 checksum: 3a9675142898cfac350d4e42f0e37bd9f4e48538
Package: rpcontrol, version: 03.12.01.S.154-2.S, status: n/a
File: bootflash:Active_Dir/asr1000rp2-rpcontrol.03.12.01.S.154-2.S.pkg, on: RP1/0
Built: 2013-03-25_18.48, by: mcpre
File SHA1 checksum: 87b11f863f67fdf2610ee0769b929baab4c3efad
Package: rpios-adventerprisek9, version: 03.12.01.S.154-2.S, status: n/a
File: bootflash:Active_Dir/asr1000rp2-rpios-adventerprisek9.03.12.01.S.154-2.S.pkg, on:
RP1/0
Built: 2013-03-25_18.51, by: mcpre
File SHA1 checksum: b487136319da0a327844d353c77e533c53c56053
Package: rpaccess, version: 03.12.01.S.154-2.S, status: n/a
File: bootflash:Active_Dir/asr1000rp2-rpaccess.03.12.01.S.154-2.S.pkg, on: RP1/0
Built: 2013-03-25_18.48, by: mcpre
File SHA1 checksum: 032bea36f74b19977b363243c99f02413b54104d
Package: rpcontrol, version: 03.12.01.S.154-2.S, status: n/a
File: bootflash:Active_Dir/asr1000rp2-rpcontrol.03.12.01.S.154-2.S.pkg, on: RP1/1
Built: 2013-03-25_18.48, by: mcpre
File SHA1 checksum: 87b11f863f67fdf2610ee0769b929baab4c3efad
Package: rpios-adventerprisek9, version: 03.12.01.S.154-2.S, status: n/a
File: bootflash:Active_Dir/asr1000rp2-rpios-adventerprisek9.03.12.01.S.154-2.S.pkg, on:
RP1/1
Built: 2013-03-25_18.51, by: mcpre
File SHA1 checksum: b487136319da0a327844d353c77e533c53c56053
Package: rpaccess, version: 03.12.01.S.154-2.S, status: n/a
File: bootflash:Active_Dir/asr1000rp2-rpaccess.03.12.01.S.154-2.S.pkg, on: RP1/1
Built: 2013-03-25_18.48, by: mcpre
File SHA1 checksum: 032bea36f74b19977b363243c99f02413b54104d
Package: espbase, version: 03.13.00.S.154-3.S-ext, status: inactive
File: bootflash:Active_Dir/asr1000rp2-espbase.03.13.00.S.154-3.S-ext.pkg, on: ESP0
Built: 2013-07-25_21.16, by: mcpre

```

## Examples

```

File SHA1 checksum: 2fe0ede1545e3f8260b7d453653e812500f0d7b0
Package: esp86base, version: 03.13.00.S.154-3.S-ext, status: active
File: bootflash:Active_Dir/asr1000rp2-esp86base.03.13.00.S.154-3.S-ext.pkg, on: ESP0
Built: 2013-07-25_22.55, by: mcpre
File SHA1 checksum: 571b8bb3866341badd6e24de677b98409f0c789c
Package: espbase, version: 03.13.00.S.154-3.S-ext, status: inactive
File: bootflash:Active_Dir/asr1000rp2-espbase.03.13.00.S.154-3.S-ext.pkg, on: ESP1
Built: 2013-07-25_21.16, by: mcpre
File SHA1 checksum: 2fe0ede1545e3f8260b7d453653e812500f0d7b0
Package: esp86base, version: 03.13.00.S.154-3.S-ext, status: active
File: bootflash:Active_Dir/asr1000rp2-esp86base.03.13.00.S.154-3.S-ext.pkg, on: ESP1
Built: 2013-07-25_22.55, by: mcpre
File SHA1 checksum: 571b8bb3866341badd6e24de677b98409f0c789c
Package: sipbase, version: 03.12.01.S.154-2.S, status: inactive
File: bootflash:Active_Dir/asr1000rp2-sipbase.03.12.01.S.154-2.S.pkg, on: SIP0
Built: 2013-03-25_17.28, by: mcpre
File SHA1 checksum: fb815b5cbaf5fd20a0a0e2aeabd2687347c6921d
Package: elcbase, version: 03.12.01.S.154-2.S, status: inactive
File: bootflash:Active_Dir/asr1000rp2-elcbase.03.12.01.S.154-2.S.pkg, on: SIP0
Built: 2013-03-25_17.28, by: mcpre
File SHA1 checksum: fb1d6abd055b191909bc78ccac23b964de15ab8e
Package: sipspa, version: 03.12.01.S.154-2.S, status: n/a
File: bootflash:Active_Dir/asr1000rp2-sipspa.03.12.01.S.154-2.S.pkg, on: SIP0/0
Built: 2013-03-25_17.28, by: mcpre
File SHA1 checksum: 644364aeea8ccebddd4af5b8d29367db50fc82b17
Package: elcspa, version: 03.12.01.S.154-2.S, status: n/a
File: bootflash:Active_Dir/asr1000rp2-elcspa.03.12.01.S.154-2.S.pkg, on: SIP0/0
Built: 2013-03-25_17.28, by: mcpre
File SHA1 checksum: 2e6b6b1949261873ce5ce189ec19440abffd71c6
Package: sipspa, version: 03.12.01.S.154-2.S, status: n/a
File: bootflash:Active_Dir/asr1000rp2-sipspa.03.12.01.S.154-2.S.pkg, on: SIP0/1
Built: 2013-03-25_17.28, by: mcpre
File SHA1 checksum: 644364aeea8ccebddd4af5b8d29367db50fc82b17
Package: elcspa, version: 03.12.01.S.154-2.S, status: n/a
File: bootflash:Active_Dir/asr1000rp2-elcspa.03.12.01.S.154-2.S.pkg, on: SIP0/1
Built: 2013-03-25_17.28, by: mcpre
File SHA1 checksum: 2e6b6b1949261873ce5ce189ec19440abffd71c6
Package: sipspa, version: 03.12.01.S.154-2.S, status: n/a
File: bootflash:Active_Dir/asr1000rp2-sipspa.03.12.01.S.154-2.S.pkg, on: SIP0/2
Built: 2013-03-25_17.28, by: mcpre
File SHA1 checksum: 644364aeea8ccebddd4af5b8d29367db50fc82b17
Package: elcspa, version: 03.12.01.S.154-2.S, status: n/a
File: bootflash:Active_Dir/asr1000rp2-elcspa.03.12.01.S.154-2.S.pkg, on: SIP0/2
Built: 2013-03-25_17.28, by: mcpre
File SHA1 checksum: 2e6b6b1949261873ce5ce189ec19440abffd71c6
Package: sipspa, version: 03.12.01.S.154-2.S, status: n/a
File: bootflash:Active_Dir/asr1000rp2-sipspa.03.12.01.S.154-2.S.pkg, on: SIP0/3
Built: 2013-03-25_17.28, by: mcpre
File SHA1 checksum: 644364aeea8ccebddd4af5b8d29367db50fc82b17
Package: elcspa, version: 03.12.01.S.154-2.S, status: n/a
File: bootflash:Active_Dir/asr1000rp2-elcspa.03.12.01.S.154-2.S.pkg, on: SIP0/3
Built: 2013-03-25_17.28, by: mcpre
File SHA1 checksum: 2e6b6b1949261873ce5ce189ec19440abffd71c6
Package: sipbase, version: 03.12.01.S.154-2.S, status: inactive
File: bootflash:Active_Dir/asr1000rp2-sipbase.03.12.01.S.154-2.S.pkg, on: SIP1
Built: 2013-03-25_17.28, by: mcpre
File SHA1 checksum: fb815b5cbaf5fd20a0a0e2aeabd2687347c6921d
Package: elcbase, version: 03.12.01.S.154-2.S, status: inactive
File: bootflash:Active_Dir/asr1000rp2-elcbase.03.12.01.S.154-2.S.pkg, on: SIP1
Built: 2013-03-25_17.28, by: mcpre
File SHA1 checksum: fb1d6abd055b191909bc78ccac23b964de15ab8e
Package: sipspa, version: 03.12.01.S.154-2.S, status: n/a
File: bootflash:Active_Dir/asr1000rp2-sipspa.03.12.01.S.154-2.S.pkg, on: SIP1/0
Built: 2013-03-25_17.28, by: mcpre

```



```

File SHA1 checksum: 644364aeea8ccebddd4af5b8d29367db50fc82b17
Package: elcspa, version: 03.12.01.S.154-2.S, status: n/a
File: bootflash:Active_Dir/asr1000rp2-elcspa.03.12.01.S.154-2.S.pkg, on: SIP1/0
Built: 2013-03-25_17.28, by: mcpre
File SHA1 checksum: 2e6b6b1949261873ce5ce189ec19440abffd71c6
Package: sipspa, version: 03.12.01.S.154-2.S, status: n/a
File: bootflash:Active_Dir/asr1000rp2-sipspa.03.12.01.S.154-2.S.pkg, on: SIP1/1
Built: 2013-03-25_17.28, by: mcpre
File SHA1 checksum: 644364aeea8ccebddd4af5b8d29367db50fc82b17
Package: elcspa, version: 03.12.01.S.154-2.S, status: n/a
File: bootflash:Active_Dir/asr1000rp2-elcspa.03.12.01.S.154-2.S.pkg, on: SIP1/1
Built: 2013-03-25_17.28, by: mcpre
File SHA1 checksum: 2e6b6b1949261873ce5ce189ec19440abffd71c6
Package: sipspa, version: 03.12.01.S.154-2.S, status: n/a
File: bootflash:Active_Dir/asr1000rp2-sipspa.03.12.01.S.154-2.S.pkg, on: SIP1/2
Built: 2013-03-25_17.28, by: mcpre
File SHA1 checksum: 644364aeea8ccebddd4af5b8d29367db50fc82b17
Package: elcspa, version: 03.12.01.S.154-2.S, status: n/a
File: bootflash:Active_Dir/asr1000rp2-elcspa.03.12.01.S.154-2.S.pkg, on: SIP1/2
Built: 2013-03-25_17.28, by: mcpre
File SHA1 checksum: 2e6b6b1949261873ce5ce189ec19440abffd71c6
Package: sipspa, version: 03.12.01.S.154-2.S, status: n/a
File: bootflash:Active_Dir/asr1000rp2-sipspa.03.12.01.S.154-2.S.pkg, on: SIP1/3
Built: 2013-03-25_17.28, by: mcpre
File SHA1 checksum: 644364aeea8ccebddd4af5b8d29367db50fc82b17
Package: elcspa, version: 03.12.01.S.154-2.S, status: n/a
File: bootflash:Active_Dir/asr1000rp2-elcspa.03.12.01.S.154-2.S.pkg, on: SIP1/3
Built: 2013-03-25_17.28, by: mcpre
File SHA1 checksum: 2e6b6b1949261873ce5ce189ec19440abffd71c6
Package: sipbase, version: 03.13.00.S.154-3.S-ext, status: active
File: bootflash:Active_Dir/asr1000rp2-sipbase.03.13.00.S.154-3.S-ext.pkg, on: SIP2
Built: 2013-07-25_21.16, by: mcpre
File SHA1 checksum: 3b6a4838972840a995ff22e73fd2bae910b268a7
Package: elcbase, version: 03.12.01.S.154-2.S, status: inactive
File: bootflash:Active_Dir/asr1000rp2-elcbase.03.12.01.S.154-2.S.pkg, on: SIP2
Built: 2013-03-25_17.28, by: mcpre
File SHA1 checksum: fb1d6abd055b191909bc78ccac23b964de15ab8e
Package: sipspa, version: 03.13.00.S.154-3.S-ext, status: active
File: bootflash:Active_Dir/asr1000rp2-sipspa.03.13.00.S.154-3.S-ext.pkg, on: SIP2/0
Built: 2013-07-25_21.16, by: mcpre
File SHA1 checksum: 6d12280b5cc33d17d752f475bf340b77ef3451ca
Package: elcspa, version: 03.12.01.S.154-2.S, status: inactive
File: bootflash:Active_Dir/asr1000rp2-elcspa.03.12.01.S.154-2.S.pkg, on: SIP2/0
Built: 2013-03-25_17.28, by: mcpre
File SHA1 checksum: 2e6b6b1949261873ce5ce189ec19440abffd71c6
Package: sipspa, version: 03.13.00.S.154-3.S-ext, status: active
File: bootflash:Active_Dir/asr1000rp2-sipspa.03.13.00.S.154-3.S-ext.pkg, on: SIP2/1
Built: 2013-07-25_21.16, by: mcpre
File SHA1 checksum: 6d12280b5cc33d17d752f475bf340b77ef3451ca
Package: elcspa, version: 03.12.01.S.154-2.S, status: inactive
File: bootflash:Active_Dir/asr1000rp2-elcspa.03.12.01.S.154-2.S.pkg, on: SIP2/1
Built: 2013-03-25_17.28, by: mcpre
File SHA1 checksum: 2e6b6b1949261873ce5ce189ec19440abffd71c6
Package: sipspa, version: 03.13.00.S.154-3.S-ext, status: active
File: bootflash:Active_Dir/asr1000rp2-sipspa.03.13.00.S.154-3.S-ext.pkg, on: SIP2/2
Built: 2013-07-25_21.16, by: mcpre
File SHA1 checksum: 6d12280b5cc33d17d752f475bf340b77ef3451ca
Package: elcspa, version: 03.12.01.S.154-2.S, status: inactive
File: bootflash:Active_Dir/asr1000rp2-elcspa.03.12.01.S.154-2.S.pkg, on: SIP2/2
Built: 2013-03-25_17.28, by: mcpre
File SHA1 checksum: 2e6b6b1949261873ce5ce189ec19440abffd71c6
Package: sipspa, version: 03.13.00.S.154-3.S-ext, status: active
File: bootflash:Active_Dir/asr1000rp2-sipspa.03.13.00.S.154-3.S-ext.pkg, on: SIP2/3
Built: 2013-07-25_21.16, by: mcpre

```

## Examples

```

File SHA1 checksum: 6d12280b5cc33d17d752f475bf340b77ef3451ca
Package: elcspa, version: 03.12.01.S.154-2.S, status: inactive
File: bootflash:Active_Dir/asr1000rp2-elcspa.03.12.01.S.154-2.S.pkg, on: SIP2/3
Built: 2013-03-25_17.28, by: mcpre
File SHA1 checksum: 2e6b6b1949261873ce5ce189ec19440abffd71c6
Package: sipbase, version: 03.12.01.S.154-2.S, status: inactive
File: bootflash:Active_Dir/asr1000rp2-sipbase.03.12.01.S.154-2.S.pkg, on: SIP3
Built: 2013-03-25_17.28, by: mcpre
File SHA1 checksum: fb815b5cbaf5fd20a0a0e2aeabd2687347c6921d
Package: elcbase, version: 03.12.01.S.154-2.S, status: inactive
File: bootflash:Active_Dir/asr1000rp2-elcbase.03.12.01.S.154-2.S.pkg, on: SIP3
Built: 2013-03-25_17.28, by: mcpre
File SHA1 checksum: fb1d6abd055b191909bc78ccac23b964de15ab8e
Package: sipspa, version: 03.12.01.S.154-2.S, status: n/a
File: bootflash:Active_Dir/asr1000rp2-sipspa.03.12.01.S.154-2.S.pkg, on: SIP3/0
Built: 2013-03-25_17.28, by: mcpre
File SHA1 checksum: 644364aeea8ccebddd4af5b8d29367db50fc82b17
Package: elcspa, version: 03.12.01.S.154-2.S, status: n/a
File: bootflash:Active_Dir/asr1000rp2-elcspa.03.12.01.S.154-2.S.pkg, on: SIP3/0
Built: 2013-03-25_17.28, by: mcpre
File SHA1 checksum: 2e6b6b1949261873ce5ce189ec19440abffd71c6
Package: sipspa, version: 03.12.01.S.154-2.S, status: n/a
File: bootflash:Active_Dir/asr1000rp2-sipspa.03.12.01.S.154-2.S.pkg, on: SIP3/1
Built: 2013-03-25_17.28, by: mcpre
File SHA1 checksum: 644364aeea8ccebddd4af5b8d29367db50fc82b17
Package: elcspa, version: 03.12.01.S.154-2.S, status: n/a
File: bootflash:Active_Dir/asr1000rp2-elcspa.03.12.01.S.154-2.S.pkg, on: SIP3/1
Built: 2013-03-25_17.28, by: mcpre
File SHA1 checksum: 2e6b6b1949261873ce5ce189ec19440abffd71c6
Package: sipspa, version: 03.12.01.S.154-2.S, status: n/a
File: bootflash:Active_Dir/asr1000rp2-sipspa.03.12.01.S.154-2.S.pkg, on: SIP3/2
Built: 2013-03-25_17.28, by: mcpre
File SHA1 checksum: 644364aeea8ccebddd4af5b8d29367db50fc82b17
Package: elcspa, version: 03.12.01.S.154-2.S, status: n/a
File: bootflash:Active_Dir/asr1000rp2-elcspa.03.12.01.S.154-2.S.pkg, on: SIP3/2
Built: 2013-03-25_17.28, by: mcpre
File SHA1 checksum: 2e6b6b1949261873ce5ce189ec19440abffd71c6
Package: sipspa, version: 03.12.01.S.154-2.S, status: n/a
File: bootflash:Active_Dir/asr1000rp2-sipspa.03.12.01.S.154-2.S.pkg, on: SIP3/3
Built: 2013-03-25_17.28, by: mcpre
File SHA1 checksum: 644364aeea8ccebddd4af5b8d29367db50fc82b17
Package: elcspa, version: 03.12.01.S.154-2.S, status: n/a
File: bootflash:Active_Dir/asr1000rp2-elcspa.03.12.01.S.154-2.S.pkg, on: SIP3/3
Built: 2013-03-25_17.28, by: mcpre
File SHA1 checksum: 2e6b6b1949261873ce5ce189ec19440abffd71c6
Package: sipbase, version: 03.12.01.S.154-2.S, status: inactive
File: bootflash:Active_Dir/asr1000rp2-sipbase.03.12.01.S.154-2.S.pkg, on: SIP4
Built: 2013-03-25_17.28, by: mcpre
File SHA1 checksum: fb815b5cbaf5fd20a0a0e2aeabd2687347c6921d
Package: elcbase, version: 03.13.00.S.154-3.S-ext, status: active
File: bootflash:Active_Dir/asr1000rp2-elcbase.03.13.00.S.154-3.S-ext.pkg, on: SIP4
Built: 2013-07-25_21.16, by: mcpre
File SHA1 checksum: 99f8dc925083b118626a4e82d93079050db96826
Package: sipspa, version: 03.12.01.S.154-2.S, status: inactive
File: bootflash:Active_Dir/asr1000rp2-sipspa.03.12.01.S.154-2.S.pkg, on: SIP4/0
Built: 2013-03-25_17.28, by: mcpre
File SHA1 checksum: 644364aeea8ccebddd4af5b8d29367db50fc82b17
Package: elcspa, version: 03.13.00.S.154-3.S-ext, status: active
File: bootflash:Active_Dir/asr1000rp2-elcspa.03.13.00.S.154-3.S-ext.pkg, on: SIP4/0
Built: 2013-07-25_21.16, by: mcpre
File SHA1 checksum: 94763274fc807489410e299a45fd73fce9d67499
Package: sipspa, version: 03.12.01.S.154-2.S, status: n/a
File: bootflash:Active_Dir/asr1000rp2-sipspa.03.12.01.S.154-2.S.pkg, on: SIP4/1
Built: 2013-03-25_17.28, by: mcpre

```

```

File SHA1 checksum: 644364aeea8ccebddd4af5b8d29367db50fc82b17
Package: elcspa, version: 03.13.00.S.154-3.S-ext, status: n/a
File: bootflash:Active_Dir/asr1000rp2-elcspa.03.13.00.S.154-3.S-ext.pkg, on: SIP4/1
Built: 2013-07-25_21.16, by: mcpre
File SHA1 checksum: 94763274fc807489410e299a45fd73fce9d67499
Package: sipspa, version: 03.12.01.S.154-2.S, status: n/a
File: bootflash:Active_Dir/asr1000rp2-sipspa.03.12.01.S.154-2.S.pkg, on: SIP4/2
Built: 2013-03-25_17.28, by: mcpre
File SHA1 checksum: 644364aeea8ccebddd4af5b8d29367db50fc82b17
Package: elcspa, version: 03.13.00.S.154-3.S-ext, status: n/a
File: bootflash:Active_Dir/asr1000rp2-elcspa.03.13.00.S.154-3.S-ext.pkg, on: SIP4/2
Built: 2013-07-25_21.16, by: mcpre
File SHA1 checksum: 94763274fc807489410e299a45fd73fce9d67499
Package: sipspa, version: 03.12.01.S.154-2.S, status: n/a
File: bootflash:Active_Dir/asr1000rp2-sipspa.03.12.01.S.154-2.S.pkg, on: SIP4/3
Built: 2013-03-25_17.28, by: mcpre
File SHA1 checksum: 644364aeea8ccebddd4af5b8d29367db50fc82b17
Package: elcspa, version: 03.13.00.S.154-3.S-ext, status: n/a
File: bootflash:Active_Dir/asr1000rp2-elcspa.03.13.00.S.154-3.S-ext.pkg, on: SIP4/3
Built: 2013-07-25_21.16, by: mcpre
File SHA1 checksum: 94763274fc807489410e299a45fd73fce9d67499
Package: sipbase, version: 03.12.01.S.154-2.S, status: inactive
File: bootflash:Active_Dir/asr1000rp2-sipbase.03.12.01.S.154-2.S.pkg, on: SIP5
Built: 2013-03-25_17.28, by: mcpre
File SHA1 checksum: fb815b5cbaf5fd20a0a0e2aeabd2687347c6921d
Package: elcbase, version: 03.12.01.S.154-2.S, status: inactive
File: bootflash:Active_Dir/asr1000rp2-elcbase.03.12.01.S.154-2.S.pkg, on: SIP5
Built: 2013-03-25_17.28, by: mcpre
File SHA1 checksum: fb1d6abd055b191909bc78ccac23b964de15ab8e
Package: sipspa, version: 03.12.01.S.154-2.S, status: n/a
File: bootflash:Active_Dir/asr1000rp2-sipspa.03.12.01.S.154-2.S.pkg, on: SIP5/0
Built: 2013-03-25_17.28, by: mcpre
File SHA1 checksum: 644364aeea8ccebddd4af5b8d29367db50fc82b17
Package: elcspa, version: 03.12.01.S.154-2.S, status: n/a
File: bootflash:Active_Dir/asr1000rp2-elcspa.03.12.01.S.154-2.S.pkg, on: SIP5/0
Built: 2013-03-25_17.28, by: mcpre
File SHA1 checksum: 2e6b6b1949261873ce5ce189ec19440abffd71c6
Package: sipspa, version: 03.12.01.S.154-2.S, status: n/a
File: bootflash:Active_Dir/asr1000rp2-sipspa.03.12.01.S.154-2.S.pkg, on: SIP5/1
Built: 2013-03-25_17.28, by: mcpre
File SHA1 checksum: 644364aeea8ccebddd4af5b8d29367db50fc82b17
Package: elcspa, version: 03.12.01.S.154-2.S, status: n/a
File: bootflash:Active_Dir/asr1000rp2-elcspa.03.12.01.S.154-2.S.pkg, on: SIP5/1
Built: 2013-03-25_17.28, by: mcpre
File SHA1 checksum: 2e6b6b1949261873ce5ce189ec19440abffd71c6
Package: sipspa, version: 03.12.01.S.154-2.S, status: n/a
File: bootflash:Active_Dir/asr1000rp2-sipspa.03.12.01.S.154-2.S.pkg, on: SIP5/2
Built: 2013-03-25_17.28, by: mcpre
File SHA1 checksum: 644364aeea8ccebddd4af5b8d29367db50fc82b17
Package: elcspa, version: 03.12.01.S.154-2.S, status: n/a
File: bootflash:Active_Dir/asr1000rp2-elcspa.03.12.01.S.154-2.S.pkg, on: SIP5/2
Built: 2013-03-25_17.28, by: mcpre
File SHA1 checksum: 2e6b6b1949261873ce5ce189ec19440abffd71c6
Package: sipspa, version: 03.12.01.S.154-2.S, status: n/a
File: bootflash:Active_Dir/asr1000rp2-sipspa.03.12.01.S.154-2.S.pkg, on: SIP5/3
Built: 2013-03-25_17.28, by: mcpre
File SHA1 checksum: 644364aeea8ccebddd4af5b8d29367db50fc82b17
Package: elcspa, version: 03.12.01.S.154-2.S, status: n/a
File: bootflash:Active_Dir/asr1000rp2-elcspa.03.12.01.S.154-2.S.pkg, on: SIP5/3
Built: 2013-03-25_17.28, by: mcpre
File SHA1 checksum: 2e6b6b1949261873ce5ce189ec19440abffd71c6
Router#
Router#redundancy force-switchover
Proceed with switchover to standby RP? [confirm]

```

```

<output removed for brevity>
Router#
Router# request platform software package clean
Cleaning up unnecessary package files
No path specified, will use booted path bootflash:Active_Dir/packages.conf
Cleaning bootflash:Active_Dir
 Scanning boot directory for packages ... done.
 Preparing packages list to delete ...
 asr1000rp2-elcbase.03.13.00.S.154-3.S-ext.pkg
 File is in use, will not delete.
 asr1000rp2-elcspa.03.13.00.S.154-3.S-ext.pkg
 File is in use, will not delete.
 asr1000rp2-espbase.03.13.00.S.154-3.S-ext.pkg
 File is in use, will not delete.
 asr1000rp2-esp86base.03.13.00.S.154-3.S-ext.pkg
 File is in use, will not delete.
 asr1000rp2-rpaccess.03.13.00.S.154-3.S-ext.pkg
 File is in use, will not delete.
 asr1000rp2-rpbase.03.13.00.S.154-3.S-ext.pkg
 File is in use, will not delete.
 asr1000rp2-rpcontrol.03.13.00.S.154-3.S-ext.pkg
 File is in use, will not delete.
 asr1000rp2-rpios-adventerprisek9.03.13.00.S.154-3.S-ext.pkg
 File is in use, will not delete.
 asr1000rp2-sipbase.03.13.00.S.154-3.S-ext.pkg
 File is in use, will not delete.
 asr1000rp2-sipspa.03.13.00.S.154-3.S-ext.pkg
 File is in use, will not delete.
 packages.conf
 File is in use, will not delete.
 done.

Files that will be deleted:
 asr1000rp2-elcbase.03.12.01.S.154-2.S.pkg
 asr1000rp2-elcspa.03.12.01.S.154-2.S.pkg
 asr1000rp2-espbase.03.12.01.S.154-2.S.pkg
 asr1000rp2-esp86base.03.12.01.S.154-2.S.pkg
 asr1000rp2-packages-adventerprisek9.03.12.01.S.154-2.S.conf
 asr1000rp2-rpaccess.03.12.01.S.154-2.S.pkg
 asr1000rp2-rpbase.03.12.01.S.154-2.S.pkg
 asr1000rp2-rpcontrol.03.12.01.S.154-2.S.pkg
 asr1000rp2-rpios-adventerprisek9.03.12.01.S.154-2.S.pkg
 asr1000rp2-sipbase.03.12.01.S.154-2.S.pkg
 asr1000rp2-sipspa.03.12.01.S.154-2.S.pkg
 packages.conf.00-
Do you want to proceed? [confirm]y
 Deleting file bootflash:Active_Dir/asr1000rp2-elcbase.03.12.01.S.154-2.S.pkg ... done.
 Deleting file bootflash:Active_Dir/asr1000rp2-elcspa.03.12.01.S.154-2.S.pkg ... done.
 Deleting file bootflash:Active_Dir/asr1000rp2-espbase.03.12.01.S.154-2.S.pkg ... done.
 Deleting file bootflash:Active_Dir/asr1000rp2-esp86base.03.12.01.S.154-2.S.pkg ... done.

 Deleting file
bootflash:Active_Dir/asr1000rp2-packages-adventerprisek9.03.12.01.S.154-2.S.conf ... done.
 Deleting file bootflash:Active_Dir/asr1000rp2-rpaccess.03.12.01.S.154-2.S.pkg ... done.
 Deleting file bootflash:Active_Dir/asr1000rp2-rpbase.03.12.01.S.154-2.S.pkg ... done.
 Deleting file bootflash:Active_Dir/asr1000rp2-rpcontrol.03.12.01.S.154-2.S.pkg ... done.
 Deleting file bootflash:Active_Dir/asr1000rp2-rpios-adventerprisek9.03.12.01.S.154-2.S.pkg
... done.
 Deleting file bootflash:Active_Dir/asr1000rp2-sipbase.03.12.01.S.154-2.S.pkg ... done.
 Deleting file bootflash:Active_Dir/asr1000rp2-sipspa.03.12.01.S.154-2.S.pkg ... done.
 Deleting file bootflash:Active_Dir/packages.conf.00- ... done.
SUCCESS: Files deleted.
Router#
Router#

```

# Additional References

The following sections provide references related to the Software Upgrade Process feature.

## Related Documents

| Related Topic                             | Title                                                                          |
|-------------------------------------------|--------------------------------------------------------------------------------|
| Performing an In Service Software Upgrade | <a href="#">High Availability Configuration Guide, Cisco IOS XE Release 3S</a> |

## Standards

| Standard                                                                                                                              | Title |
|---------------------------------------------------------------------------------------------------------------------------------------|-------|
| No new or modified standards are supported by this feature, and support for existing standards has not been modified by this feature. | —     |

## MIBs

| MIB  | MIBs Link                                                                                                                                                                                                                          |
|------|------------------------------------------------------------------------------------------------------------------------------------------------------------------------------------------------------------------------------------|
| None | To locate and download MIBs for selected platforms, Cisco IOS XE software releases, and feature sets, use Cisco MIB Locator found at the following URL:<br><a href="http://www.cisco.com/go/mibs">http://www.cisco.com/go/mibs</a> |

## RFCs

| RFC                                                                                                                         | Title |
|-----------------------------------------------------------------------------------------------------------------------------|-------|
| No new or modified RFCs are supported by this feature, and support for existing RFCs has not been modified by this feature. | —     |

**Technical Assistance**

| Description                                                                                                                                                                                                                                                                                                                                                                                                                                                                                                                                                             | Link                                                                                                              |
|-------------------------------------------------------------------------------------------------------------------------------------------------------------------------------------------------------------------------------------------------------------------------------------------------------------------------------------------------------------------------------------------------------------------------------------------------------------------------------------------------------------------------------------------------------------------------|-------------------------------------------------------------------------------------------------------------------|
| <p>The Cisco Support website provides extensive online resources, including documentation and tools for troubleshooting and resolving technical issues with Cisco products and technologies.</p> <p>To receive security and technical information about your products, you can subscribe to various services, such as the Product Alert Tool (accessed from Field Notices), the Cisco Technical Services Newsletter, and Really Simple Syndication (RSS) Feeds.</p> <p>Access to most tools on the Cisco Support website requires a Cisco.com user ID and password.</p> | <a href="http://www.cisco.com/cisco/web/support/index.html">http://www.cisco.com/cisco/web/support/index.html</a> |

## Feature Information for Software Upgrade Process

[Table 16: Feature Information for Software Upgrade Process, on page 320](#) lists the release history for this feature on the Cisco ASR 1000 Series Routers.

For information on a feature in this technology that is not documented here, see the [Cisco ASR 1000 Series Aggregation Services Routers Documentation Roadmap](#).

Use Cisco Feature Navigator to find information about platform support and software image support. Cisco Feature Navigator enables you to determine which Cisco IOS XE software images support a specific software release, feature set, or platform. To access Cisco Feature Navigator, go to <http://www.cisco.com/go/cfn>. An account on Cisco.com is not required.



**Note** [Table 16: Feature Information for Software Upgrade Process, on page 320](#) lists only the Cisco IOS XE software releases that introduced support for a given feature in a given Cisco IOS XE software release train. Unless noted otherwise, subsequent releases of that Cisco IOS XE software release train also support that feature.

**Table 16: Feature Information for Software Upgrade Process**

| Feature Name                                                   | Releases                   | Feature Information                                                                                                        |
|----------------------------------------------------------------|----------------------------|----------------------------------------------------------------------------------------------------------------------------|
| MDR Support for Cisco ASR 1000 Series Fixed Ethernet Line Card | Cisco IOS XE Release 3.12S | This feature was introduced. Added MDR support for the Cisco ASR 1000 Series Fixed Ethernet Line Card (ASR1000-2T+20X1GE). |

| Feature Name                                  | Releases                   | Feature Information                                                                                                                                                                                                                                                                                         |
|-----------------------------------------------|----------------------------|-------------------------------------------------------------------------------------------------------------------------------------------------------------------------------------------------------------------------------------------------------------------------------------------------------------|
| Cisco ASR1000 Series Fixed Ethernet Line Card | Cisco IOS XE Release 3.10S | This feature was introduced.<br>Added support for the Cisco ASR 1000 Series Fixed Ethernet Line Card.                                                                                                                                                                                                       |
| Minimal Disruptive Restart ISSU               | Cisco IOS XE Release 3.8S  | This feature was introduced.<br>Added support for the following GigabitEthernet SPAs to the Minimal Disruptive Restart (MDR) feature on Cisco ASR 1000 Series Router with SIP40:<br>-SPA-2X1GE-V2<br>-SPA-5X1GE-V2<br>-SPA-8X1GE-V2<br>-SPA-10X1GE-V2<br>-SPA-1X10GE-L-V2                                   |
| Software Upgrade Process                      | Cisco IOS XE Release 2.6   | This feature was introduced.<br>Cisco ASR 1000 Series Routers support the following software upgrade procedures: <ul style="list-style-type: none"> <li>• In Service Software Upgrades (ISSU) for redundant platforms</li> <li>• Upgrade process with service impact for nonredundant platforms.</li> </ul> |







## CHAPTER 9

# Software Upgrade Process Using `install` Commands

---

Cisco ASR 1000 Series Aggregation Services Routers support In-Service Software Upgrades (ISSU) procedure to upgrade software. The ISSU-using-install-cmds-for-ASR1k feature introduces a new method of software upgrade process by using the `install` command for Dual RP and Dual IOS routers on Cisco ASR 1000 Series Aggregation Services Routers.

- [Prerequisites for Software Upgrade Process Using `install` Commands, on page 323](#)
- [Restrictions for Software Upgrade Process Using `install` Commands, on page 323](#)
- [Information About Software Upgrade Process Using `install` Commands, on page 324](#)
- [How to Upgrade Software Using `install` Commands, on page 330](#)
- [Additional References for Software Upgrade Process Using `install` Commands, on page 341](#)
- [Feature Information for Software Upgrade Process Using `install` Commands, on page 341](#)

## Prerequisites for Software Upgrade Process Using `install` Commands

- Configure Stateful Switchover (SSO) and ensure that the standby supervisor is in the hot state.
- Enable autoboot when using the `install` command so that the device is automatically reloaded with the configuration registry using the `boot system` command.

## Restrictions for Software Upgrade Process Using `install` Commands

- Simultaneous upgrade of hardware and software is not supported. One upgrade operation can only be performed at a time.
- Minimum Disruptive Restart (MDR) and linecard-delay functionality are not supported on for consolidated platforms.

# Information About Software Upgrade Process Using install Commands

## Introduction to install Commands

Effective with Cisco IOS XE Fuji 16.7.1, a new method of software upgrade process is available for Cisco ASR 1000 Aggregation Services Routers. You can use the **install** command for Dual RP and Dual IOS routers on Cisco ASR 1000 Series Routers by enabling the `ISSU-using-install-cmds-for-ASR1k` feature. This feature upgrades the software without files names for Dual RP and Dual IOS routers thereby enhancing the system to intelligently handle packages for Dual RP and Dual IOS routers in the Cisco ASR 1000 Series family. This feature also enables each model in the Cisco ASR 1000 Series to handle packages depending on the slot type and uses APIs to provision and identify ELC, SIP, and ESP on the devices.

When performing software process upgrade for consolidated platforms (Cisco ASR 1001-X Router, Cisco ASR 1001-HX Router, Cisco ASR 1002-X Router, and Cisco ASR 1002-HX Router), you can defer the RP upgrade as the last step to a maintenance window to minimize disruption during normal operating hours.

## Software Upgrade Process Modes, Options, and Workflows using install Commands

The `ISSU-using-install-cmds-for-ASR1k` feature includes the following software upgrade modes:

- Super Package install—Applicable to Dual RP
- Sub-package install—Applicable to Dual RP
- Sub-package install—Applicable to 4RU or consolidated platforms on Dual IOSD

Depending on the choice of commands, there are different options to upgrade the software for each of the above mode on Cisco ASR 1000 Series. The ways to upgrade the software are as follows:

- Super Package Upgrade—Step-by-step
- Super Package Upgrade—One step
- Sub Package Upgrade—Step-by-step
- Sub Package Upgrade—One step
- Dual IOSD

The following table provides information about the number of workflows for Dual RP and Dual IOS devices on Cisco ASR 1000 Series Routers.

**Table 17: Cisco ASR 1000 Device Types and Workflows**

| Cisco ASR 1000 Device Type | Image Mode   | Workflows                                                                                          |
|----------------------------|--------------|----------------------------------------------------------------------------------------------------|
| Dual RP                    | Consolidated | <ul style="list-style-type: none"> <li>• One step</li> <li>• 3 steps</li> <li>• 5 steps</li> </ul> |

| Cisco ASR 1000 Device Type | Image Mode | Workflows                                                                                                                           |
|----------------------------|------------|-------------------------------------------------------------------------------------------------------------------------------------|
| Dual RP                    | Subpackage | <ul style="list-style-type: none"> <li>• One step</li> <li>• 3 steps</li> <li>• 8 steps</li> </ul>                                  |
| Dual IOS                   | Subpackage | <ul style="list-style-type: none"> <li>• 7 steps for Cisco ASR 1004 Router</li> <li>• 5 steps for consolidated platforms</li> </ul> |

## Guidelines for Software Upgrade Process When Using install Commands

- Perform software upgrade process during a maintenance window.
- Do not enable new features during software upgrade process because new features might require change in configurations.

## Super Package Upgrade Process

Super package upgrade can be performed either in a single step or multiple steps. The sequence is as follows:

1. Copy image to standby RP.
2. Load a new software version on standby RP.
3. Wait for the standby RP to be active with the new software.
4. Run version on the active RP. This switches over the active RP, thereby running the new software on the new active RP while the new standby RP has the old software.
5. Perform upgrades during a maintenance window.
6. Restart the new standby to be up with new software.

The following table provides information about the commands used for super package upgrade process before and after Cisco IOS XE Fuji 16.7.1.

**Table 18: ISSU Process for Super Package Upgrade Before and After Cisco IOS XE Fuji 16.7.1**

| ISSU Command Before Cisco IOS XE Fuji 16.7.1                        | ISSU Command After Cisco IOS XE Fuji 16.7.1             |
|---------------------------------------------------------------------|---------------------------------------------------------|
| <code>copy tftp: URL-to-target-location</code>                      | <code>install add file tftp/ftp/flash/disk:*.bin</code> |
| <code>issu loadversion rp 1 file stby-harddisk: target image</code> | <code>install activate location standby</code>          |
| <code>issu runversion</code>                                        | <code>redundancy force-switchover</code>                |
| <code>issu acceptversion</code>                                     | <code>install abort-timer stop</code>                   |
| <code>issu commitversion</code>                                     | Not required                                            |

| ISSU Command Before Cisco IOS XE Fuji 16.7.1 | ISSU Command After Cisco IOS XE Fuji 16.7.1 |
|----------------------------------------------|---------------------------------------------|
| hw-module slot R0 reload                     | Not required                                |
| Not applicable                               | install activate location standby           |
| Not applicable                               | install commit                              |

Table 19: ISSU Process for Super Package Upgrade—One step Before and After Cisco IOS XE Fuji 16.7.1

| ISSU Command Before Cisco IOS XE Fuji 16.7.1                                                    | ISSU Command After Cisco IOS XE Fuji 16.7.1                                                 |
|-------------------------------------------------------------------------------------------------|---------------------------------------------------------------------------------------------|
| request platform software package install node file bootflash<br>[interface-module-delay [mdr]] | install add file tftp/ftp/flash/disk:*.bin activate issu<br>[linecard-delay seconds] commit |

## Super Package Upgrade Use Cases

| Work Flow # | Use Case                                                                                                                                                                                                                                                                                                                                                                                                                                                                                                                                                                                                                                                                                                           |
|-------------|--------------------------------------------------------------------------------------------------------------------------------------------------------------------------------------------------------------------------------------------------------------------------------------------------------------------------------------------------------------------------------------------------------------------------------------------------------------------------------------------------------------------------------------------------------------------------------------------------------------------------------------------------------------------------------------------------------------------|
| 3-Step      | This workflow involves three steps—add, activate, and commit. After activation, all cards are upgraded to new software version except that the software is not committed automatically but must be performed manually via the <b>install commit</b> command. The advantage of this approach is the system can be rolled back to a previous software version. The system automatically rolls back if the roll back timer is not stopped using the install abort-timer-stop command. If the roll back timer is stopped, the new software version could be run on the device for any duration and then roll back to the previous version. The upgrade time is faster because this workflow involves two reloads only. |
| 5-Step      | There are three reloads involved in this workflow. In this workflow, the upgraded software is available on the active RP for sometime allowing you to validate the software before committing the upgrade. In addition to this the rollback to previous version is much faster because there is already an earlier version of the software on the standby RP.                                                                                                                                                                                                                                                                                                                                                      |
| 1-Step      | This workflow helps in optimization and saving a reload. You cannot roll back as the upgrade is committed automatically.                                                                                                                                                                                                                                                                                                                                                                                                                                                                                                                                                                                           |

## Subpackage Upgrade Process

The subpackage upgrade can be performed in either a single step or using multiple steps. This document discusses both methodologies. The sequence for a subpackage upgrade is as follows:

1. Copy an image to the standby RP.
2. Unzip the file and copy packages on both RPs.
3. Install packages on the standby RP.
4. Restart the standby RP.
5. Install SIP—sipsa and sipbase—packages on the active RP.
6. Install ELC—elcspa and elcbase—packages on the active RP.
7. Install ESP (fp) package on the active RP (standby ESP followed by active ESP).
8. In case of one step or one shot ISSU, do the following:

- a. Install RP packages on the active RP.
  - b. Restart the active RP and switchover the standby to new active RP. After the switchover, the new standby RP will be up with the new software. The new software version is already installed on the new active RP, hence ISSU is completed.
9. In case of multiple step ISSU, do the following:
- a. Initiate the switchover. The active RP is running with new software and standby RP will come back with old software.
  - b. Provision the standby RP with new software. The new standby RP reloads with new software version and reaches SSO state.
10. Restart the new standby to be up with new software.

The following table provides information about different commands used for super package upgrade before and after Cisco IOS XE Fuji 16.7.1.

**Table 20: ISSU Process for SubPackage Upgrade Before and After Cisco IOS XE Fuji 16.7.1**

| ISSU Command Before Cisco IOS XE Fuji 16.7.1                                                                                                                                   | ISSU Command After Cisco IOS XE Fuji 16.7.1                                         |
|--------------------------------------------------------------------------------------------------------------------------------------------------------------------------------|-------------------------------------------------------------------------------------|
| <b>show version</b><br><b>show version active-rp installed</b><br><b>dir filesystem:</b> <i>directory</i><br><b>show platform</b><br><b>show redundancy-states</b>             | Similar                                                                             |
| <b>copy running-configuration startup-configuration</b>                                                                                                                        | Similar                                                                             |
| <b>mkdir</b> <i>URL-to-directory-name</i>                                                                                                                                      | Not required                                                                        |
| <b>copy tftp:</b> <i>URL-to-target-location</i>                                                                                                                                | Not required                                                                        |
| <b>request platform software package expand file</b><br><i>URL-to-consolidated-package</i>                                                                                     | <b>install add</b> <i>tftp/ftp/flash/disk.*.bin</i>                                 |
| <b>dir</b> <i>URL-to-consolidated-package</i>                                                                                                                                  | Not required                                                                        |
| <b>copy tftp:</b> <i>URL-to-target-location</i>                                                                                                                                | <b>install add</b> <i>tftp/ftp/flash/disk.*.bin</i>                                 |
| <b>issu loadversion rp</b> <i>standby-RP file URL-to-standby-file-system:</i><br><b>asr1000rp*</b> <i>version *.pkg force</i>                                                  | <b>install activate location standby</b>                                            |
| <b>hw-module slot</b> <i>standby-RP reload</i>                                                                                                                                 | Not required. Optionally, use the <b>install activate location standby</b> command. |
| <b>issu loadversion rp</b> <i>active-RP file URL-to-active-file-system:</i><br><b>asr1000rpx6-{sibase,sipsa}</b> * <i>version *.pkg slot SIP-slot-number force</i>             | <b>install activate locationslot</b>                                                |
| <b>issu loadversion rp</b> <i>active-RP file</i><br><i>URL-to-active-file-system:asr1000rpx86-{elcbase,elcspa}</i> * <i>version *.pkg</i><br><i>slot ELC-slot-number force</i> | <b>install activate locationslot</b>                                                |

| ISSU Command Before Cisco IOS XE Fuji 16.7.1                                                                                    | ISSU Command After Cisco IOS XE Fuji 16.7.1                                                        |
|---------------------------------------------------------------------------------------------------------------------------------|----------------------------------------------------------------------------------------------------|
| <b>issu commitversion</b>                                                                                                       | Not required. Optionally, use the <b>install auto abort-time stop</b> command.                     |
| <b>issu loadversion rp</b> <i>active-RP file URL-to-active-file-system : asr1000rp2-esp* version *.pkg slot active-ESP-slot</i> | <b>install activate location esp standby</b>                                                       |
| <b>issu commitversion</b>                                                                                                       | Not required. Optionally, use the <b>install auto abort-time stop</b> command.                     |
| <b>issu loadversion rp</b> <i>active-RP file URL-to-active-file-system : asr1000rp2-esp* version *.pkg slot active-ESP-slot</i> | <b>install activate location esp active</b>                                                        |
| <b>issu commitversion</b>                                                                                                       | Not required. Optionally, use the <b>install auto abort-time stop</b> command.                     |
| Not applicable.                                                                                                                 | <b>redundancy force-switchover</b>                                                                 |
| <b>issu loadversion rp</b> <i>active-RP file URL-to-active-file-system:asr1000rp2* version *.pkg force</i>                      | <b>install activate location standby</b> (triggers action per redundancy force-switchover command) |
| <b>issu commitversion</b>                                                                                                       | <b>install commit</b>                                                                              |
| <b>show version</b> <i>active-RP</i> <b>provisioned</b><br><b>show version</b> <i>active-RP</i> <b>installed</b>                | Similar                                                                                            |
| <b>redundancy force-switchover</b>                                                                                              | Not required because it has been executed earlier.                                                 |
| <b>request platform software package clean</b>                                                                                  | Not required. Included in the <b>install commit</b> command.                                       |

## Subpackage Upgrade Use Cases

| Work Flow # | Use Case                                                                                                                                                                                                                                                                                                                                                                                                                                                                                                                                                                                                                                                                                                                      |
|-------------|-------------------------------------------------------------------------------------------------------------------------------------------------------------------------------------------------------------------------------------------------------------------------------------------------------------------------------------------------------------------------------------------------------------------------------------------------------------------------------------------------------------------------------------------------------------------------------------------------------------------------------------------------------------------------------------------------------------------------------|
| 3-Step      | This workflow involves three steps—add, activate, and commit. After activation, all cards are upgraded to new software version except that the software is not committed automatically but must be performed manually through the <b>install commit</b> command. The advantage of this approach is the system can be rolled back to a previous software version. The system automatically rolls back if the roll back timer is not stopped using the <b>install abort-timer-stop</b> command. If the roll back timer is stopped, the new software version could be run on the device for any duration and then roll back to the previous version. The upgrade time is faster because this workflow involves two reloads only. |
| 8-Step      | There are three reloads involved in this workflow. In this workflow, the upgraded software is available on the active RP for sometime allowing you to validate the software before committing the upgrade. In addition to this the rollback to previous version is much faster as we have already previous version of the software running as standby RP.                                                                                                                                                                                                                                                                                                                                                                     |
| 1-Step      | This workflow helps in optimization and saving a reload. You cannot roll back as the upgrade is committed automatically.                                                                                                                                                                                                                                                                                                                                                                                                                                                                                                                                                                                                      |

## Crash Handling and Rollback

If a device crashes during an ISSU upgrade, the device will return to the initial state before the start of an ISSU operation. During an ISSU upgrade, a single fault scenario is handled and system is restored to the original state. The double faults may or may not restore the system back to the original state.

The system can be rolled back before a commit. A device can be rolled back to the initial stage by using the **install abort issu** command or after the expiry of the rollback timer before the **install commit** command is used. If the install commit command is used, no rollback is allowed. Rollback involves the following steps:

- Provision and reset the standby RP
- Provision and reset the active RP

If the roll back timer is not stopped by using the **install abort stop-timer** command, the device rolls back to an older software version on expiry of the rollback timer. The default value of the rollback timer is 120 minutes.

The rollback timer value can be set via the **install activate location standby auto-abort-timer seconds** command.

## Auto Upgrade on ASR 1000 Series Routers

The Install: Auto Upgrade for ASR1k feature detects mismatched software versions on the standby route processor (RP) and synchronizes the software version on the standby route processor with active route processor. The synchronization occurs by copying the software version from the active RP to the standby RP and upgrading the software version on the standby RP.

This feature is enabled by default. If disabled, you can enable this feature through **software auto-upgrade enable** or **install autoupgrade** commands in the global configuration mode and privileged EXEC mode, respectively.

Auto upgrade works in subpackage mode only. If the device is in bundle mode, neither does auto upgrade work, nor can you execute the install autoupgrade command. If a route processor with bundle boot image is added to a modular device, the route processor is converted to install mode to synchronize with the active RP.



---

**Note** When a standby RP has a software version different than the active RP, the standby RP is synchronized with the software on active RP even if the software version on standby RP is newer than the software on active RP.

---

By enabling the **install autoupgrade** command in privileged EXEC mode the older image is selected and deleted without any intervention. The Install: Auto Upgrade for ASR1k feature is independent of ISSU and is disabled during ISSU process because there would be a temporary state of version mismatch between the active and standby RPs when ISSU process is in progress. Similarly, when auto upgrade is performed on the standby RP, ISSU process cannot triggered. The two processes are mutually exclusive.

After ISSU process is complete, auto upgrade is reenabled as configured before the ISSU process. In other words, this feature disables itself during ISSU process and reactivates itself after ISSU process.

# How to Upgrade Software Using install Commands

## Upgrading Software Using 3-Step Super Package Workflow on Consolidated Platforms

### Before you begin

The device must be booted with the consolidated image.

### SUMMARY STEPS

1. enable
2. install add file {bootflash: | flash: | ftp: | http: | https: | rcp: | scp: | tftp: | webui:}
3. install activate issu [linecard-delay *seconds*]
4. install commit

### DETAILED STEPS

|               | Command or Action                                                                                                                                              | Purpose                                                                                                                                                                                                                                                                                                                                                         |
|---------------|----------------------------------------------------------------------------------------------------------------------------------------------------------------|-----------------------------------------------------------------------------------------------------------------------------------------------------------------------------------------------------------------------------------------------------------------------------------------------------------------------------------------------------------------|
| <b>Step 1</b> | <b>enable</b><br><b>Example:</b><br>Router> enable                                                                                                             | Enables privileged EXEC mode. <ul style="list-style-type: none"> <li>• Enter your password if prompted.</li> </ul>                                                                                                                                                                                                                                              |
| <b>Step 2</b> | <b>install add file {bootflash:   flash:   ftp:   http:   https:   rcp:   scp:   tftp:   webui:}</b><br><b>Example:</b><br>Router# install add tftp bootflash: | Downloads the image into the bootflash. The image is copied to the boot directory (boot_dir), the location where Route Processors (RPs) are booted.                                                                                                                                                                                                             |
| <b>Step 3</b> | <b>install activate issu [linecard-delay <i>seconds</i>]</b><br><b>Example:</b><br>Router# install activate issu                                               | Provisions the standby RP with the new software and reloads with the new software version. <ul style="list-style-type: none"> <li>• <b>linecard-delay <i>seconds</i></b>—Waits for a specified duration before upgrading the next slot</li> <li>• The rollback timer will be restarted.</li> </ul>                                                              |
| <b>Step 4</b> | <b>install commit</b><br><b>Example:</b><br>Router# install commit                                                                                             | Saves the configuration, performs the necessary clean up, enables the new software as permanent (removing the older version of the software) and stops the rollback timer. <ul style="list-style-type: none"> <li>• Any reboot after the commit will boot with new software.</li> </ul> <p><b>Note</b>      There is no rollback when this command is used.</p> |



# Upgrading Software Using 5-Step Super Package Workflow on Consolidated Platforms

Perform this task to upgrade the software on consolidated platforms, such as, Cisco ASR 1001-X Router, Cisco ASR 1001-HX Router, Cisco ASR 1002-X Router, and Cisco ASR 1002-HX Router.

## Before you begin

The device must be booted with the consolidated image.

## SUMMARY STEPS

1. **enable**
2. **install add file {bootflash: | flash: | ftp: | http: | https: | rcp: | scp: | tftp: | webui:}**
3. **install activate location standby**
4. **redundancy force-switchover**
5. **install activate location standby**
6. **install commit**

## DETAILED STEPS

|        | Command or Action                                                                                                                                                     | Purpose                                                                                                                                                   |
|--------|-----------------------------------------------------------------------------------------------------------------------------------------------------------------------|-----------------------------------------------------------------------------------------------------------------------------------------------------------|
| Step 1 | <b>enable</b><br><b>Example:</b><br>Router> <b>enable</b>                                                                                                             | Enables privileged EXEC mode. <ul style="list-style-type: none"> <li>• Enter your password if prompted.</li> </ul>                                        |
| Step 2 | <b>install add file {bootflash:   flash:   ftp:   http:   https:   rcp:   scp:   tftp:   webui:}</b><br><b>Example:</b><br>Router# <b>install add tftp bootflash:</b> | Downloads the image into the bootflash. The image is copied to the boot directory (boot_dir), the location where Route Processors (RPs) are booted.       |
| Step 3 | <b>install activate location standby</b><br><b>Example:</b><br>Router# <b>install activate location standby</b>                                                       | Installs the software on the standby RP and reloads the device. <ul style="list-style-type: none"> <li>• The rollback timer will be restarted.</li> </ul> |
| Step 4 | <b>redundancy force-switchover</b><br><b>Example:</b><br>Router# <b>redundancy force-switchover</b>                                                                   | Enables the standby RP to assume the role of the active RP.                                                                                               |
| Step 5 | <b>install activate location standby</b><br><b>Example:</b><br>Router# <b>install activate location standby</b>                                                       | Installs the software on the standby RP and reloads the device. <ul style="list-style-type: none"> <li>• The rollback timer will be restarted.</li> </ul> |

|               | Command or Action                                                  | Purpose                                                                                                                                                                                                                                                                                                                                           |
|---------------|--------------------------------------------------------------------|---------------------------------------------------------------------------------------------------------------------------------------------------------------------------------------------------------------------------------------------------------------------------------------------------------------------------------------------------|
| <b>Step 6</b> | <b>install commit</b><br><b>Example:</b><br>Router# install commit | Saves the configuration, performs the necessary clean up, enables the new software as permanent (removing the older version of the software) and stops the rollback timer. <ul style="list-style-type: none"> <li>Any reboot after the commit will boot with new software.</li> </ul> <b>Note</b> There is no rollback when this command is used. |

## Upgrading Software Using 1-Step Super Package Workflow on Consolidated Platforms

Perform this task to upgrade the software on consolidated platforms, such as, Cisco ASR 1001-X Router, Cisco ASR 1001-HX Router, Cisco ASR 1002-X Router, and Cisco ASR 1002-HX Router.

### Before you begin

The device must be booted with the consolidated image.

### SUMMARY STEPS

- enable
- install add file {bootflash: | flash: | ftp: | http: | https: | rcp: | scp: | tftp: | webui:} activate issu [linecard-delay *seconds*] commit

### DETAILED STEPS

|               | Command or Action                                                                                                                                                                                                                        | Purpose                                                                                                                                                                                                                                                                                                                                                                                                                                                                                                                                                                               |
|---------------|------------------------------------------------------------------------------------------------------------------------------------------------------------------------------------------------------------------------------------------|---------------------------------------------------------------------------------------------------------------------------------------------------------------------------------------------------------------------------------------------------------------------------------------------------------------------------------------------------------------------------------------------------------------------------------------------------------------------------------------------------------------------------------------------------------------------------------------|
| <b>Step 1</b> | <b>enable</b><br><b>Example:</b><br>Router> enable                                                                                                                                                                                       | Enables privileged EXEC mode. <ul style="list-style-type: none"> <li>Enter your password if prompted.</li> </ul>                                                                                                                                                                                                                                                                                                                                                                                                                                                                      |
| <b>Step 2</b> | <b>install add file {bootflash:   flash:   ftp:   http:   https:   rcp:   scp:   tftp:   webui:} activate issu [linecard-delay <i>seconds</i>] commit</b><br><b>Example:</b><br>Router# install add tftp bootflash: activate issu commit | Enables the standby RP with new software and triggers the standby RP to become active RP with new software version. <ul style="list-style-type: none"> <li><b>linecard-delay <i>seconds</i></b>—Waits for the specified duration before upgrading the next slot</li> <li><b>commit</b>—Saves the configuration, performs the necessary clean up, enables the new software as permanent (removing the older version of the software) and stops the rollback timer. Any reboot after the commit will boot with new software. There is no rollback when this keyword is used.</li> </ul> |

## Upgrading Software Using 3-Step Subpackage Workflow on Dual RP Devices

Perform this task to upgrade the software on Dual RP devices.

### Before you begin

The device must be booted with the consolidated image.

### SUMMARY STEPS

1. `enable`
2. `install add file {bootflash: | flash: | ftp: | http: | https: | rcp: | scp: | tftp: | webui:}`
3. `install activate issu [linecard-delay seconds]`
4. `install commit`

### DETAILED STEPS

|        | Command or Action                                                                                                                                                                       | Purpose                                                                                                                                                                                                                                                                                                                                                           |
|--------|-----------------------------------------------------------------------------------------------------------------------------------------------------------------------------------------|-------------------------------------------------------------------------------------------------------------------------------------------------------------------------------------------------------------------------------------------------------------------------------------------------------------------------------------------------------------------|
| Step 1 | <p><code>enable</code></p> <p><b>Example:</b></p> <pre>Router&gt; enable</pre>                                                                                                          | <p>Enables privileged EXEC mode.</p> <ul style="list-style-type: none"> <li>• Enter your password if prompted.</li> </ul>                                                                                                                                                                                                                                         |
| Step 2 | <p><code>install add file {bootflash:   flash:   ftp:   http:   https:   rcp:   scp:   tftp:   webui:}</code></p> <p><b>Example:</b></p> <pre>Router# install add tftp bootflash:</pre> | <p>Downloads the image into the bootflash. The image is copied to the boot directory (boot_dir), the location where Route Processors (RPs) are booted.</p>                                                                                                                                                                                                        |
| Step 3 | <p><code>install activate issu [linecard-delay seconds]</code></p> <p><b>Example:</b></p> <pre>Router# install activate issu</pre>                                                      | <p>Provisions the standby RP with the new software and reloads with the new software version.</p> <ul style="list-style-type: none"> <li>• <b>linecard-delay seconds</b>—Waits for a specified duration before upgrading the next slot</li> <li>• The rollback timer will be restarted.</li> </ul>                                                                |
| Step 4 | <p><code>install commit</code></p> <p><b>Example:</b></p> <pre>Router# install commit</pre>                                                                                             | <p>Saves the configuration, performs the necessary clean up, enables the new software as permanent (removing the older version of the software) and stops the rollback timer.</p> <ul style="list-style-type: none"> <li>• Any reboot after the commit will boot with new software.</li> </ul> <p><b>Note</b> There is no rollback when this command is used.</p> |

## Upgrading Software Using 8-Step Subpackage Workflow on Dual RP Devices

Perform this task to upgrade the software on Dual RP devices.

**Before you begin**

The device must be booted with the packages mode.

**SUMMARY STEPS**

1. enable
2. install add file {bootflash: | flash: | ftp: | http: | https: | rcp: | scp: | tftp: | webui:}
3. install activate location standby
4. install activate location linecard [*linecard-delay seconds*]
5. install activate location esp standby
6. install activate location esp active
7. redundancy force-switchover
8. install activate location standby
9. install commit

**DETAILED STEPS**

|               | Command or Action                                                                                                                                                 | Purpose                                                                                                                                                                                                                                                                                                                                             |
|---------------|-------------------------------------------------------------------------------------------------------------------------------------------------------------------|-----------------------------------------------------------------------------------------------------------------------------------------------------------------------------------------------------------------------------------------------------------------------------------------------------------------------------------------------------|
| <b>Step 1</b> | <b>enable</b><br><b>Example:</b><br>Router> enable                                                                                                                | Enables privileged EXEC mode. <ul style="list-style-type: none"> <li>• Enter your password if prompted.</li> </ul>                                                                                                                                                                                                                                  |
| <b>Step 2</b> | <b>install add file {bootflash:   flash:   ftp:   http:   https:   rcp:   scp:   tftp:   webui:}</b><br><b>Example:</b><br>Router# install add tftp bootflash:    | Downloads the image into the bootflash. The image is copied to the boot directory (boot_dir), the location where Route Processors (RPs) are booted.                                                                                                                                                                                                 |
| <b>Step 3</b> | <b>install activate location standby</b><br><b>Example:</b><br>Router# install activate location standby                                                          | Installs the software on the standby RP and reloads the device. <ul style="list-style-type: none"> <li>• The rollback timer will be restarted.</li> </ul>                                                                                                                                                                                           |
| <b>Step 4</b> | <b>install activate location linecard [<i>linecard-delay seconds</i>]</b><br><b>Example:</b><br>Router# install activate location linecard 1<br>linecard-delay 60 | Installs the software on the standby RP and makes the new software as permanent. Any reboot after the commit will boot with new software. <ul style="list-style-type: none"> <li>• <b>linecard linecard-delay seconds</b>—Waits for a specified duration before upgrading the next slot</li> <li>• The rollback timer will be restarted.</li> </ul> |
| <b>Step 5</b> | <b>install activate location esp standby</b><br><b>Example:</b><br>Router# install activate location esp standby                                                  | Loads the standby embedded services processors (ESP) cards with the packages. <ul style="list-style-type: none"> <li>• The rollback timer will be restarted.</li> </ul>                                                                                                                                                                             |
| <b>Step 6</b> | <b>install activate location esp active</b><br><b>Example:</b>                                                                                                    | Loads the active embedded services processors (ESP) cards with the packages.                                                                                                                                                                                                                                                                        |

|               | Command or Action                                                                                                     | Purpose                                                                                                                                                                                                                                                                                                                                                  |
|---------------|-----------------------------------------------------------------------------------------------------------------------|----------------------------------------------------------------------------------------------------------------------------------------------------------------------------------------------------------------------------------------------------------------------------------------------------------------------------------------------------------|
|               | Router# <code>install activate location esp active</code>                                                             | <ul style="list-style-type: none"> <li>The rollback timer will be restarted.</li> </ul>                                                                                                                                                                                                                                                                  |
| <b>Step 7</b> | <b>redundancy force-switchover</b><br><b>Example:</b><br>Router# <code>redundancy force-switchover</code>             | Enables the standby RP to assume the role of the active RP.                                                                                                                                                                                                                                                                                              |
| <b>Step 8</b> | <b>install activate location standby</b><br><b>Example:</b><br>Router# <code>install activate location standby</code> | Installs the software on the standby RP and reloads the device. <ul style="list-style-type: none"> <li>The rollback timer will be restarted.</li> </ul>                                                                                                                                                                                                  |
| <b>Step 9</b> | <b>install commit</b><br><b>Example:</b><br>Router# <code>install commit</code>                                       | Saves the configuration, performs the necessary clean up, enables the new software as permanent (removing the older version of the software) and stops the rollback timer. <ul style="list-style-type: none"> <li>Any reboot after the commit will boot with new software.</li> </ul> <p><b>Note</b> There is no rollback when this command is used.</p> |

## Upgrading Software Using 1-Step Subpackage Workflow on Dual RP Devices

Perform this task to upgrade the software on Dual RP devices.

### Before you begin

The device must be booted with the consolidated image.

### SUMMARY STEPS

- enable
- `install add file {bootflash: | flash: | ftp: | http: | https: | rcp: | scp: | tftp: | webui:} activate issu [linecard-delay seconds] commit`

### DETAILED STEPS

|               | Command or Action                                                                                                                                                     | Purpose                                                                                                                                                                                                                                                           |
|---------------|-----------------------------------------------------------------------------------------------------------------------------------------------------------------------|-------------------------------------------------------------------------------------------------------------------------------------------------------------------------------------------------------------------------------------------------------------------|
| <b>Step 1</b> | <b>enable</b><br><b>Example:</b><br>Router> <code>enable</code>                                                                                                       | Enables privileged EXEC mode. <ul style="list-style-type: none"> <li>Enter your password if prompted.</li> </ul>                                                                                                                                                  |
| <b>Step 2</b> | <b>install add file {bootflash:   flash:   ftp:   http:   https:   rcp:   scp:   tftp:   webui:} activate issu [linecard-delay seconds] commit</b><br><b>Example:</b> | Enables the standby RP with new software and triggers the standby RP to become active RP with new software version. <ul style="list-style-type: none"> <li><b>linecard-delay seconds</b>—Waits for a specified duration before upgrading the next slot</li> </ul> |

| Command or Action                                           | Purpose                                                                                                                                                                                                                                                                                                                                               |
|-------------------------------------------------------------|-------------------------------------------------------------------------------------------------------------------------------------------------------------------------------------------------------------------------------------------------------------------------------------------------------------------------------------------------------|
| Router# install add tftp bootflash: activate issu<br>commit | <ul style="list-style-type: none"> <li>• <b>commit</b>—Saves the configuration, performs the necessary clean up, enables the new software as permanent (removing the older version of the software) and stops the rollback timer. Any reboot after the commit will boot with new software. There is no rollback when this keyword is used.</li> </ul> |

## Upgrading Software on Cisco ASR 1001-X Router, Cisco ASR 1001-HX Router, Cisco ASR 1002-X Router, and Cisco ASR 1002-HX Router

Perform this task to upgrade the software on Cisco ASR 1001-X Router, Cisco ASR 1001-HX Router, Cisco ASR 1002-X Router, and Cisco ASR 1002-HX Router.



**Note** Perform this task during maintenance window to minimize the traffic loss. Cisco ASR 1001-X Router and Cisco ASR 1002-X Router has sipspa and sipbase, while Cisco ASR 1001-HX Router and Cisco 1002-HX Router has elcbase elcspa.

### Before you begin

Cisco ASR 1001-HX Router and Cisco ASR 1002-HX Router must be booted with the consolidated image.

### SUMMARY STEPS

1. enable
2. install add file {bootflash: | flash: | ftp: | http: | https: | rcp: | scp: | tftp: | webui:}
3. install activate location standby
4. redundancy force-switchover
5. install activate location standby
6. install commit

### DETAILED STEPS

| Command or Action                                                                                                                                                               | Purpose                                                                                                                                             |
|---------------------------------------------------------------------------------------------------------------------------------------------------------------------------------|-----------------------------------------------------------------------------------------------------------------------------------------------------|
| <b>Step 1</b><br><b>enable</b><br><b>Example:</b><br>Router> enable                                                                                                             | Enables privileged EXEC mode. <ul style="list-style-type: none"> <li>• Enter your password if prompted.</li> </ul>                                  |
| <b>Step 2</b><br><b>install add file {bootflash:   flash:   ftp:   http:   https:   rcp:   scp:   tftp:   webui:}</b><br><b>Example:</b><br>Router# install add tftp bootflash: | Downloads the image into the bootflash. The image is copied to the boot directory (boot_dir), the location where Route Processors (RPs) are booted. |

|        | Command or Action                                                                                                   | Purpose                                                                                                                                                                                                                                                                                                                                                                                                                                                          |
|--------|---------------------------------------------------------------------------------------------------------------------|------------------------------------------------------------------------------------------------------------------------------------------------------------------------------------------------------------------------------------------------------------------------------------------------------------------------------------------------------------------------------------------------------------------------------------------------------------------|
| Step 3 | <b>install activate location standby</b><br><b>Example:</b><br><pre>Router# install activate location standby</pre> | Installs the software on the standby RP and reloads the device. <ul style="list-style-type: none"> <li>The rollback timer will be restarted.</li> </ul> <b>Note</b> This step can be performed only when both bays are in stateful switchover (SSO) state.                                                                                                                                                                                                       |
| Step 4 | <b>redundancy force-switchover</b><br><b>Example:</b><br><pre>Router# redundancy force-switchover</pre>             | Enables the standby RP to assume the role of the active RP. <b>Note</b> During the switchover, connection to the router drops. Wait for a few seconds before reconnecting to the router and then continue.                                                                                                                                                                                                                                                       |
| Step 5 | <b>install activate location standby</b><br><b>Example:</b><br><pre>Router# install activate location standby</pre> | Installs the software on the standby RP and reloads the device. <ul style="list-style-type: none"> <li>The rollback timer will be restarted.</li> </ul> <b>Note</b> This step can be performed only when both bays are in stateful switchover (SSO) state.                                                                                                                                                                                                       |
| Step 6 | <b>install commit</b><br><b>Example:</b><br><pre>Router# install commit</pre>                                       | Saves the configuration, performs the necessary clean up, enables the new software as permanent (removing the older version of the software) and stops the rollback timer. <ul style="list-style-type: none"> <li>Any reboot after the commit will boot with new software.</li> </ul> <b>Note</b> There is no rollback when this command is used. Perform this task during maintenance window to minimize the traffic loss because this step reloads the router. |

## Upgrading Software on Cisco ASR 1004 Router

Perform this task to upgrade the software on Cisco ASR 1004 Router.



**Note** Perform this task during maintenance window to minimize the traffic loss.

### Before you begin

The device must be booted with the consolidated image.

### SUMMARY STEPS

1. enable

2. `install add file {bootflash: | flash: | ftp: | http: | https: | rcp: | scp: | tftp: | webui:}`
3. `install activate location standby`
4. `redundancy force-switchover`
5. `install activate location standby`
6. `install activate location [linecard slot]`
7. `install activate location esp active`
8. `install commit`

## DETAILED STEPS

|               | Command or Action                                                                                                                                                                       | Purpose                                                                                                                                                                                                                                                                                                         |
|---------------|-----------------------------------------------------------------------------------------------------------------------------------------------------------------------------------------|-----------------------------------------------------------------------------------------------------------------------------------------------------------------------------------------------------------------------------------------------------------------------------------------------------------------|
| <b>Step 1</b> | <p><code>enable</code></p> <p><b>Example:</b></p> <pre>Router&gt; enable</pre>                                                                                                          | <p>Enables privileged EXEC mode.</p> <ul style="list-style-type: none"> <li>• Enter your password if prompted.</li> </ul>                                                                                                                                                                                       |
| <b>Step 2</b> | <p><code>install add file {bootflash:   flash:   ftp:   http:   https:   rcp:   scp:   tftp:   webui:}</code></p> <p><b>Example:</b></p> <pre>Router# install add tftp bootflash:</pre> | <p>Downloads the image into the bootflash. The image is copied to the boot directory (boot_dir), the location where Route Processors (RPs) are booted.</p>                                                                                                                                                      |
| <b>Step 3</b> | <p><code>install activate location standby</code></p> <p><b>Example:</b></p> <pre>Router# install activate location standby</pre>                                                       | <p>Installs the software on the standby RP and reloads the device.</p> <ul style="list-style-type: none"> <li>• The rollback timer will be restarted.</li> </ul> <p><b>Note</b> This step can be performed only when both bays are in stateful switchover (SSO) state.</p>                                      |
| <b>Step 4</b> | <p><code>redundancy force-switchover</code></p> <p><b>Example:</b></p> <pre>Router# redundancy force-switchover</pre>                                                                   | <p>Enables the standby RP to assume the role of the active RP.</p> <p><b>Note</b> During the switchover, connection to the router drops. Wait for a few seconds before reconnecting to the router and then continue.</p>                                                                                        |
| <b>Step 5</b> | <p><code>install activate location standby</code></p> <p><b>Example:</b></p> <pre>Router# install activate location standby</pre>                                                       | <p>Installs the software on the standby RP and reloads the device.</p> <ul style="list-style-type: none"> <li>• The rollback timer will be restarted.</li> </ul> <p><b>Note</b> This step can be performed only when both bays are in stateful switchover (SSO) state.</p>                                      |
| <b>Step 6</b> | <p><code>install activate location [linecard slot]</code></p> <p><b>Example:</b></p> <pre>Router# install activate location</pre>                                                       | <p>Upgrades SPA interface processor (SIP) and shared port adapter (SPA), Ethernet line card (ELC) and SPA subpackages for each SIP or ELC on the device.</p> <ul style="list-style-type: none"> <li>• Repeat this step for all SIP on the device, one at a time, before proceeding to the next step.</li> </ul> |



|               | Command or Action                                                                                                                 | Purpose                                                                                                                                                                                                                                                                                                                                                                                                                                                                          |
|---------------|-----------------------------------------------------------------------------------------------------------------------------------|----------------------------------------------------------------------------------------------------------------------------------------------------------------------------------------------------------------------------------------------------------------------------------------------------------------------------------------------------------------------------------------------------------------------------------------------------------------------------------|
|               |                                                                                                                                   | <ul style="list-style-type: none"> <li>• Perform this task during maintenance window to minimize the traffic loss.</li> <li>• The rollback timer will be restarted.</li> </ul> <p><b>Note</b> Use the show ip interface brief command to identify the slots for SIP and SPA. The SPA and ELC interface will go down during the upgrade.</p>                                                                                                                                      |
| <b>Step 7</b> | <p><b>install activate location esp active</b></p> <p><b>Example:</b></p> <pre>Router# install activate location esp active</pre> | <p>Loads the active embedded services processors (ESP) cards with the packages. The following message appears:</p> <pre>Forwarding Interruption until upgrade is completed. Router is still accessible. No reboot required.</pre> <ul style="list-style-type: none"> <li>• Perform this task during maintenance window to minimize the traffic loss.</li> <li>• The rollback timer will be restarted.</li> </ul>                                                                 |
| <b>Step 8</b> | <p><b>install commit</b></p> <p><b>Example:</b></p> <pre>Router# install commit</pre>                                             | <p>Saves the configuration, performs the necessary clean up, enables the new software as permanent (removing the older version of the software) and stops the rollback timer.</p> <ul style="list-style-type: none"> <li>• Any reboot after the commit will boot with new software.</li> </ul> <p><b>Note</b> There is no rollback when this command is used. Perform this task during maintenance window to minimize the traffic loss because this step reloads the router.</p> |

## Tracking Software Upgrade Process

The ISSU progress can be tracked via the **show issu state detail** command. This command also displays the remaining duration in rollback timer. The following is a sample output of the **show issu state detail** command.

```
Device# show issu state detail
--- Starting local lock acquisition on R1 ---
Finished local lock acquisition on R1

Operation type: One-shot ISSU
Install type : Image installation using ISSU
Current state : Activated state
Last operation : Commit

Completed operations:

Operation Start time

Activate location standby R1 2017-09-28:11:37:29
Activate location active R0 2017-09-28:11:43:30
Switchover 2017-09-28:11:45:09
```

```
Commit 2017-09-28:11:51:25

State transition: Added -> Standby activated -> Active switched-over -> Activated

Auto abort timer: inactive
Running image: flash:packages.conf
Operating mode: sso, terminal state reached
```

## Enable Auto Upgrade Using Install Command

### SUMMARY STEPS

1. enable
2. install autoupgrade

### DETAILED STEPS

|               | Command or Action                                                    | Purpose                                                                                                            |
|---------------|----------------------------------------------------------------------|--------------------------------------------------------------------------------------------------------------------|
| <b>Step 1</b> | enable<br><b>Example:</b><br>Device> enable                          | Enables privileged EXEC mode. <ul style="list-style-type: none"> <li>• Enter your password if prompted.</li> </ul> |
| <b>Step 2</b> | install autoupgrade<br><b>Example:</b><br>Device# configure terminal | Initiates autoupgrades on all standby RPs.                                                                         |

## Enable Auto Upgrade (Global Configuration)

### SUMMARY STEPS

1. enable
2. configure terminal
3. software auto-upgrade
4. end

### DETAILED STEPS

|               | Command or Action                                                   | Purpose                                                                                                            |
|---------------|---------------------------------------------------------------------|--------------------------------------------------------------------------------------------------------------------|
| <b>Step 1</b> | enable<br><b>Example:</b><br>Device> enable                         | Enables privileged EXEC mode. <ul style="list-style-type: none"> <li>• Enter your password if prompted.</li> </ul> |
| <b>Step 2</b> | configure terminal<br><b>Example:</b><br>Device# configure terminal | Enters global configuration mode.                                                                                  |

|        | Command or Action                                                                               | Purpose                                                                                         |
|--------|-------------------------------------------------------------------------------------------------|-------------------------------------------------------------------------------------------------|
| Step 3 | <b>software auto-upgrade</b><br><b>Example:</b><br>Device(config)# software auto-upgrade enable | Enables auto upgrade and specifies the location of the software to install during auto upgrade. |
| Step 4 | <b>end</b><br><b>Example:</b><br>Device(config)# end                                            | Exits global configuration mode and returns to privileged EXEC mode.                            |

## Additional References for Software Upgrade Process Using install Commands

### Related Documents

| Related Topic      | Document Title                                                                                                                                        |
|--------------------|-------------------------------------------------------------------------------------------------------------------------------------------------------|
| Cisco IOS commands | <a href="http://www.cisco.com/en/US/docs/ios/mcl/allreleasemcl/all_book.html">http://www.cisco.com/en/US/docs/ios/mcl/allreleasemcl/all_book.html</a> |

### Technical Assistance

| Description                                                                                                                                                                                                                                                                                                                                                                           | Link                                                                                                              |
|---------------------------------------------------------------------------------------------------------------------------------------------------------------------------------------------------------------------------------------------------------------------------------------------------------------------------------------------------------------------------------------|-------------------------------------------------------------------------------------------------------------------|
| The Cisco Support and Documentation website provides online resources to download documentation, software, and tools. Use these resources to install and configure the software and to troubleshoot and resolve technical issues with Cisco products and technologies. Access to most tools on the Cisco Support and Documentation website requires a Cisco.com user ID and password. | <a href="http://www.cisco.com/cisco/web/support/index.html">http://www.cisco.com/cisco/web/support/index.html</a> |

## Feature Information for Software Upgrade Process Using install Commands

The following table provides release information about the feature or features described in this module. This table lists only the software release that introduced support for a given feature in a given software release train. Unless noted otherwise, subsequent releases of that software release train also support that feature.

Use Cisco Feature Navigator to find information about platform support and Cisco software image support. To access Cisco Feature Navigator, go to [www.cisco.com/go/cfn](http://www.cisco.com/go/cfn). An account on Cisco.com is not required.

Table 21: Feature Information for Software Upgrade Process Using install Commands

| Feature Name                      | Releases                 | Feature Information                                                                                                                                                                                                                                                                                                                                                                                                                                                                                                                                                                                                                                                                                                                                                                                     |
|-----------------------------------|--------------------------|---------------------------------------------------------------------------------------------------------------------------------------------------------------------------------------------------------------------------------------------------------------------------------------------------------------------------------------------------------------------------------------------------------------------------------------------------------------------------------------------------------------------------------------------------------------------------------------------------------------------------------------------------------------------------------------------------------------------------------------------------------------------------------------------------------|
| ISSU-using-install-cmds-for-ASR1k | Cisco IOS XE Fuji 16.7.1 | <p>Cisco ASR 1000 Series Aggregation Services Routers supports In-Service Software Upgrades (ISSU) procedure to upgrade software. The ISSU-using-install-cmds-for-ASR1k feature introduces a new method of software upgrade process by using the <b>install</b> command for Dual RP and Dual IOS routers on Cisco ASR 1000 Series Aggregation Services Routers.</p> <p>The following commands were introduced or modified: <b>install activate issu, install activate location esp active, install activate location esp standby, install activate location linecard, install activate location standby, install add file, install commit, redundancy force-switchover, show issu comp-matrix, show issu rollback-timer, show issu state detail, show platform, show redundancy, show version</b> .</p> |



## CHAPTER 10

# Support for Security-Enhanced Linux

---

This chapter describes the SELinux feature, and includes the following sections:

- [Overview, on page 343](#)
- [Prerequisites for SELinux, on page 343](#)
- [Restrictions for SELinux, on page 343](#)
- [Information About SELinux, on page 343](#)
- [Configuring SELinux, on page 344](#)
- [Verifying SELinux Enablement, on page 346](#)
- [Troubleshooting SELinux, on page 347](#)

## Overview

Security-Enhanced Linux (SELinux) is a solution composed of Linux kernel security module and system utilities to incorporate a strong, flexible Mandatory Access Control (MAC) architecture into Cisco IOS-XE platforms.

SELinux provides an enhanced mechanism to enforce the separation of information, based on confidentiality and integrity requirements, which addresses threats of tampering and bypassing of application security mechanisms and enables the confinement of damage that malicious or flawed applications can cause.

## Prerequisites for SELinux

There are no specific prerequisites for this feature.

## Restrictions for SELinux

There are no specific restrictions for this feature.

## Information About SELinux

SELinux enforces mandatory access control policies that confine user programs and system services to the minimum privilege required to perform their assigned functionality. This reduces or eliminates the ability of

these programs and daemons to cause harm when compromised (for example, through buffer overflows or misconfigurations). This is a practical implementation of principle of least privilege by enforcing MAC on Cisco IOS-XE platforms. This confinement mechanism works independently of the traditional Linux access control mechanisms. SELinux provides the capability to define policies to control the access from an application process to any resource object, thereby allowing for the clear definition and confinement of process behavior.

SELinux can operate either in **Permissive mode** or **Enforcing mode** when enabled on a system.

- In Permissive mode, SELinux does not enforce the policy, and only generates system logs for any denials caused by violation of the resource access policy. The operation is not denied, but only logged for resource access policy violation.
- In Enforcing mode, the SELinux policy is enabled and enforced. It denies resource access based on the access policy rules, and generates system logs.

From Cisco IOS XE 17.13.1a, SELinux is enabled in Enforcing mode by default on supported Cisco IOS XE platforms. In the Enforcing mode, any system resource access that does not have the necessary allow policy is treated as a violation, and the operation is denied. The violating operation fails when a denial occurs, and system logs are generated. In Enforcing mode, the solution works in access-violation prevention mode.

## Supported Platforms

From Cisco IOS XE 17.13.1a, SELinux is enabled on the following platforms:

- Cisco 1000 Series Aggregation Services Routers
- Cisco 1000 Series Integrated Services Routers
- Cisco 4000 Series Integrated Services Routers
- Cisco Catalyst 8000v Edge Software
- Cisco Catalyst 8200 Series Edge Platforms
- Cisco Catalyst 8300 Series Edge Platforms
- Cisco Catalyst 8500 and 8500L/8530L Series Edge Platforms
- Cisco VG Series Gateways: VG400, VG410, VG420, and VG450
- Cisco 1100 Terminal Services Gateway

## Configuring SELinux

There are no additional requirements or configuration steps needed to enable or use the SELinux feature in Enforcing mode.

The following commands are introduced as part of the SELinux feature:

```
set platform software selinux {default | enforcing | permissive}
platform security selinux {enforcing | permissive}
show platform software selinux
```



---

**Note** These new commands are implemented as **service internal** commands.

---

## Configuring SELinux (EXEC Mode)

Use the **set platform software selinux** command to configure SELinux in EXEC mode.

The following example shows SELinux configuration in EXEC mode:

```
Device# set platform software selinux ?

default Set SELinux mode to default
enforcing Set SELinux mode to enforcing
permissive Set SELinux mode to permissive
```

## Configuring SELinux (CONFIG Mode)

Use the **platform security selinux** command to configure SELinux in configuration mode.

The following example shows SELinux configuration in CONFIG mode:

```
Device(config)# platform security selinux

enforcing Set SELinux policy to Enforcing mode
permissive Set SELinux policy to Permissive mode

Device(config)# platform security selinux permissive

Device(config)#
*Oct 20 21:52:45.155: %IOSXE-1-PLATFORM: R0/0:
SELINUX_MODE_PROG: Platform Selinux confinement mode downgraded to permissive!

Device(config)#
```

## Examples for SELinux

The following example shows the output for changing the mode from Enforcing to Permissive:

```
**Oct 20 21:44:03.609: %IOSXE-1-PLATFORM: R0/0:
SELINUX_MODE_PROG: Platform Selinux confinement mode downgraded to permissive!"
```

The following example shows the output for changing the mode from Permissive to Enforcing:

```
**Oct 20 21:44:34.160: %IOSXE-1-PLATFORM: R0/0:
SELINUX_MODE_PROG: Platform Selinux confinement mode upgraded to enforcing!"
```



---

**Note** If the SELinux mode is changed, this change is considered a system security event, and a system log message is generated.

---

## SysLog Message Reference

|                                   |                                                                                                                                                                                                                                                                                                                                                                                                                                                                                                      |
|-----------------------------------|------------------------------------------------------------------------------------------------------------------------------------------------------------------------------------------------------------------------------------------------------------------------------------------------------------------------------------------------------------------------------------------------------------------------------------------------------------------------------------------------------|
| <b>Facility-Severity-Mnemonic</b> | <b>%SELINUX-1-VIOLATION</b>                                                                                                                                                                                                                                                                                                                                                                                                                                                                          |
| Severity-Meaning                  | Alert Level Log                                                                                                                                                                                                                                                                                                                                                                                                                                                                                      |
| Message                           | N/A                                                                                                                                                                                                                                                                                                                                                                                                                                                                                                  |
| Message Explanation               | Resource access was made by the process for which a resource access policy does not exist. The operation was flagged, and resource access was denied. A system log was generated with information that process resource access has been denied.                                                                                                                                                                                                                                                      |
| Component                         | SELINUX                                                                                                                                                                                                                                                                                                                                                                                                                                                                                              |
| Recommended Action                | <p>Contact Cisco TAC with the following relevant information as attachments:</p> <ul style="list-style-type: none"> <li>• The exact message as it appears on the console or in the system</li> <li>• Output of the <b>show tech-support</b> command (text file)</li> <li>• Archive of Btrace files from the box using the following command:<br/><b>request platform software trace archive target &lt;URL&gt;</b></li> <li>• Output of the <b>show platform software selinux</b> command</li> </ul> |

The following examples demonstrate sample syslog messages:

### Example 1:

```
*Nov 14 00:09:04.943: %SELINUX-1-VIOLATION: R0/0: audispd: type=AVC
msg=audit(1699927057.934:129): avc: denied { getattr } for pid=5899 comm="ls"
path="/root/test" dev="rootfs" ino=25839
scontext=system_u:system_r:polaris_iosd_t:s0
tcontext=system_u:object_r:admin_home_t:s0 tclass=file permissive=0
```

### Example 2:

```
*Nov 14 00:09:04.947: %SELINUX-1-VIOLATION: R0/0: audispd: t type=AVC
msg=audit(1699927198.486:130): avc: denied { write } for pid=6012 comm="echo"
path="/root/test" dev="rootfs" ino=25839
scontext=system_u:system_r:polaris_iosd_t:s0
tcontext=system_u:object_r:admin_home_t:s0 tclass=file permissive= 0
```

## Verifying SELinux Enablement

Use the **show platform software selinux** command to view the SELinux configuration mode:



```
Device# show platform software selinux
=====
IOS-XE SELINUX STATUS
=====
SElinux Status : Enabled
Current Mode : Enforcing
Config file Mode : Enforcing
```

## Troubleshooting SELinux

If there is an instance of an SELinux violation on your device or network, please reach out to Cisco TAC with the following details:

- The message exactly as it appears on the console or in the system log. For example:

```
device#request platform software trace archive target
flash:selinux_btrace_logs
```

- Output of the **show tech-support** command (text file)
- Archive of Btrace files from the box using the following command:  
**request platform software trace archive target <URL>**
- Output of the **show platform software selinux** command





# CHAPTER 11

## Factory Reset

This chapter describes Factory Reset feature and how it can be used to protect or restore a router to an earlier, fully functional state.

- [Feature Information for Factory Reset](#), on page 349
- [Information About Factory Reset](#), on page 350
- [Software and Hardware Support for Factory Reset](#), on page 351
- [Prerequisites for Performing Factory Reset](#), on page 351
- [Restrictions for Performing a Factory Reset](#), on page 352
- [When to Perform Factory Reset](#), on page 352
- [How to Perform a Factory Reset](#), on page 352
- [What Happens after a Factory Reset](#), on page 353

## Feature Information for Factory Reset

The following table provides release information about the feature or features described in this module. This table lists only the software release that introduced support for a given feature in a given software release train. Unless noted otherwise, subsequent releases of that software release train also support that feature.

Use Cisco Feature Navigator to find information about platform support and Cisco software image support. To access Cisco Feature Navigator, go to <https://cfng.cisco.com/>. An account on Cisco.com is not required.

**Table 22: Feature Information for Factory Reset**

| Feature Name                                                                                               | Releases                      | Feature Information                                |
|------------------------------------------------------------------------------------------------------------|-------------------------------|----------------------------------------------------|
| Factory Reset                                                                                              | Cisco IOS XE Fuji 16.7.1      | This feature was introduced.                       |
| Option to retain RUM reports, SLR, and HSEC key using the <b>factory-reset keep-licensing-info</b> command | Cisco IOS XE Bengaluru 17.5.1 | This feature was introduced.                       |
| Secure Factory Reset                                                                                       | Cisco IOS XE Bengaluru 17.6.1 | Added the <b>factory-reset all secure</b> command. |

## Information About Factory Reset

Factory Reset is a process of clearing the current running and start-up configuration information on a device, and resetting the device to an earlier, fully-functional state.

The factory reset process uses the **factory-reset all** command to take backup of existing configuration, and then reset the router to an earlier, fully functional state. In a high availability setup, the factory reset process is executed on the active Route Processor (RP), and then synchronized to the standby RP. The duration of the factory reset process is dependent on the storage size of the router. It can vary between 30 minutes on an ASR1000 consolidated platform, and up to 3 hours on a high availability setup.

From Cisco IOS XE Bengaluru 17.6 release and later, you can use the **factory-reset all secure** command to reset the router and securely clear the files stored in the bootflash memory.

**Table 23: Data Erased or Retained during Factory Reset**

| Command Name                    | Data Erased                                                                                                                                                                                                                    | Data Retained                                                                                                                  |
|---------------------------------|--------------------------------------------------------------------------------------------------------------------------------------------------------------------------------------------------------------------------------|--------------------------------------------------------------------------------------------------------------------------------|
| <b>factory-reset all secure</b> | Non-volatile random-access memory (NVRAM) data                                                                                                                                                                                 | Data from remote field-replaceable units (FRUs).                                                                               |
|                                 | OBFL (Onboard Failure Logging) logs                                                                                                                                                                                            | Value of configuration register                                                                                                |
|                                 | Licenses                                                                                                                                                                                                                       | Contents of USB                                                                                                                |
|                                 | User data, startup, and running configuration                                                                                                                                                                                  | Credentials (Secure Unique Device Identifier [SUDI] certificates, public key infrastructure (PKI) keys, and FIPS-related keys) |
|                                 | ROMMON variables                                                                                                                                                                                                               |                                                                                                                                |
|                                 | All writeable file systems and personal data.<br><br><b>Note</b> If the current boot image is a remote image or stored on a USB, NIM-SSD, or such, ensure that you take a backup of the image before performing factory reset. |                                                                                                                                |

| Command Name                             | Data Erased                                                                                                                                                                                              | Data Retained                                                                                                                                                                                                                                                                                                                                                                                                                                       |
|------------------------------------------|----------------------------------------------------------------------------------------------------------------------------------------------------------------------------------------------------------|-----------------------------------------------------------------------------------------------------------------------------------------------------------------------------------------------------------------------------------------------------------------------------------------------------------------------------------------------------------------------------------------------------------------------------------------------------|
| <b>factory-reset keep-licensing-info</b> | <ul style="list-style-type: none"> <li>• License Boot level configuration</li> <li>• Throughput level configuration</li> <li>• Smart license transport type</li> <li>• Smart license URL data</li> </ul> | <ul style="list-style-type: none"> <li>• Real User Monitoring (RUM) Reports (open/unacknowledged license usage report)</li> <li>• Usage reporting details (last ACK received, next ACK scheduled, last/next report push)</li> <li>• Unique Device Identification (UDI) trust codes</li> <li>• Customer policy received from CSSM</li> <li>• SLAC, SLR authorization codes return codes</li> <li>• Factory installed purchase information</li> </ul> |

After the factory reset process is complete, the router reboots to ROMMON mode. If you have the zero-touch provisioning (ZTP) capability setup, after the router completes the factory reset procedure, the router reboots with ZTP configuration.

## Software and Hardware Support for Factory Reset

- This feature is supported on all Cisco ASR 1000 platforms, Cisco ASR 1000 Series Route Processor 2 (RP2), and Cisco ASR 1000 Series Route Processor 3 (RP3).
- Factory Reset process is supported on standalone routers as well as on routers configured for high availability.

## Prerequisites for Performing Factory Reset

- Ensure that all the software images, configurations and personal data is backed up before performing factory reset.
- Ensure that there is uninterrupted power supply when factory reset is in progress.
- The factory reset process takes a backup of the boot image if the system is booted from an image stored locally (bootflash or hard disk). If the current boot image is a remote image or stored on an USB, NIM-SSD or such, ensure that you take a backup of the image before performing factory reset.
- The **factory-reset all secure** command erases all files, including the boot image, even if the image is stored locally. If the current boot image is a remote image or stored on a USB, NIM-SSD, or such, ensure that you take a backup of the image before performing secure factory reset.

- Ensure that ISSU/ISSD (In- Service Software Upgrade or Downgrade) is not in progress before performing factory reset.

## Restrictions for Performing a Factory Reset

- Any software patches that are installed on the router are not restored after the factory reset operation.
- If the factory reset command is issued through a Virtual Teletype (VTY) session, the session is not restored after the completion of the factory reset process.

## When to Perform Factory Reset

- Return Material Authorization (RMA): If a router is returned back to Cisco for RMA, it is important that all sensitive information is removed.
- Router is compromised: If the router data is compromised due to a malicious attack, the router must be reset to factory configuration and then reconfigured once again for further use.
- Repurposing: The router needs to be moved to a new topology or market from the existing site to a different site.

## How to Perform a Factory Reset

### Before you begin

Refer Table 2 to determine which information is going to be deleted and retained. Based on the information you require, execute the appropriate command mentioned below.

**Step 1** Log in to a Cisco 1000 ASR device.

**Important** If the current boot image is a remote image or is stored in a USB or a NIM-SSD, ensure that you take a backup of the image before starting the factory reset process.

**Step 2** This step is divided into two parts (a and b). If you need to retain the licensing information while performing the **factory-reset** command, follow step 2. a. If you do not need to retain the licensing information and want all the data to be erased, perform step 2. b.

a) Execute **factory-reset keep-licensing-info** command to retain the licensing data.

The system displays the following message when you use the **factory-reset keep-licensing-info** command:

```
Router# factory-reset keep-licensing-info
```

```
The factory reset operation is irreversible for Keeping license usage. Are you sure? [confirm]
This operation may take 20 minutes or more. Please do not power cycle.
```

```
Dec 1 20:58:38.205: %PMAN-5-EXITACTION: R0/0: pvp: Process manager is exiting: process exit with
reload chassis code
/bootflash failed to mount
```

```
Dec 01 20:59:44.264: Factory reset operation completed.
Initializing Hardware ...
```

```
Current image running: Boot ROM1
```

```
Last reset cause: LocalSoft
```

```
ISR4331/K9 platform with 4194304 Kbytes of main memory
rommon 1
```

- b) Execute the **factory-reset all secure 3-pass** command to securely erase all data.

The system displays the following message when you use the **factory-reset all secure 3-pass** command:

```
Router# factory-reset all secure 3-pass
```

```
The factory reset operation is irreversible for securely reset all. Are you sure? [confirm]
This operation may take hours. Please do not power cycle.
```

```
*Jun 19 00:53:33.385: %SYS-5-RELOAD: Reload requested by Exec. Reload Reason: Factory Reset.Jun
19 00:53:42.856: %PMAN-5-EXITACTION:
```

```
Enabling factory reset for this reload cycle
```

```
Jun 19 00:54:06.914: Factory reset secure operation. Write 0s. Please do not power cycle.
```

```
Jun 19 01:18:36.040: Factory reset secure operation. Write 1s. Please do not power cycle.
```

```
Jun 19 01:43:49.263: Factory reset secure operation. Write random. Please do not power cycle.
```

```
Jun 19 02:40:29.770: Factory reset secure operation completed.
```

```
Initializing Hardware
```

**Step 3** Enter **confirm** to proceed with the factory reset.

**Note** The duration of the factory reset process depends on the storage size of the router. It can extend between 30 minutes and up to 3 hours on a high availability setup. If you want to quit the factory reset process, press the **Escape** key.

## What Happens after a Factory Reset

After the factory reset is successfully completed, the router boots up. However, before the factory reset process started, if the configuration register was set to manually boot from ROMMON, the router stops at ROMMON.

After you configure Smart Licensing, execute the **#show license status** command, to check whether Smart Licensing is enabled for your instance.



**Note** If you had Specific License Reservation enabled before you performed the factory reset, use the same license and enter the same license key that you received from the smart agent.







## CHAPTER 12

# High Availability Overview

Cisco High Availability (HA) enables network-wide protection by providing fast recovery from faults that may occur in any part of the network. With Cisco High Availability, network hardware and software work together and enable rapid recovery from disruptions to ensure fault transparency to users and network applications.

The unique hardware and software architecture of the Cisco ASR 1000 Series Routers is designed to maximize router uptime during any network event, and thereby provide maximum uptime and resilience within any network scenario.

This guide covers the aspects of High Availability that are unique to the Cisco ASR 1000 Series Routers. It is not intended as a comprehensive guide to High Availability, nor is it intended to provide information on High Availability features that are available on other Cisco routers that are configured and implemented identically on the Cisco ASR 1000 Series Routers. The Cisco IOS feature documents and guides should be used in conjunction with this chapter to gather information about High Availability-related features that are available on multiple Cisco platforms and work identically on the Cisco ASR 1000 Series Routers.

- [Finding Feature Information in This Module, on page 355](#)
- [Contents, on page 356](#)
- [Hardware Redundancy Overview on the Cisco ASR 1000 Series Routers, on page 356](#)
- [Software Redundancy on the Cisco ASR 1000 Series Routers, on page 357](#)
- [Route Processor Redundancy, on page 360](#)
- [Stateful Switchover, on page 360](#)
- [IPsec Failover, on page 361](#)
- [Bidirectional Forwarding Detection, on page 361](#)
- [Additional References, on page 362](#)
- [Feature Information for High Availability Overview, on page 363](#)

## Finding Feature Information in This Module

Your software release might not support all the features documented in this module. For the latest feature information and caveats, see the release notes for your platform and software release. To find information about the features documented in this module, and to see a list of the releases in which each feature is supported, see the [Feature Information for High Availability Overview, on page 363](#).

Use Cisco Feature Navigator to find information about platform support and Cisco software image support. To access Cisco Feature Navigator, go to <http://www.cisco.com/go/cfn>. An account on Cisco.com is not required.

## Contents

This section discusses various aspects of High Availability on the Cisco ASR 1000 Series Routers and contains the following sections:

## Hardware Redundancy Overview on the Cisco ASR 1000 Series Routers

Some models of the Cisco ASR 1000 Series Routers offer hardware redundancy within the same Cisco ASR 1000 Series Router through the following methods:

- Allowing two Route Processors (RPs) in the same Cisco ASR 1000 Series Router
- Allowing two Enhanced Services Processors (ESPs) in the same Cisco ASR 1000 Series Router

No hardware redundancy is supported for the following hardware:

- SPA interface processors (SIPs)—A SIP must be reloaded, and traffic briefly interrupted, for a SIP upgrade to complete.
- Shared port adapters (SPAs)—A SPA must be reloaded, which will briefly interrupt traffic to that SPA, for a SPA software subpackage update to complete.

Hardware redundancy on the Cisco ASR 1000 Series Routers gives users the following benefits:

- A failover option—If a processor fails, the standby processor immediately becomes the active processor with little or no delay. The failover happens completely within the same router, so a second standby router is not needed.
- No downtime upgrades—Using features like ISSU, a software upgrade can be handled on the standby processor while the active processor continues normal operation.

Hardware redundancy is available on the Cisco ASR 1006-X and ASR 1009-X Router only at this time provides a hardware redundancy overview.

**Table 24: Hardware Redundancy Overview**

| Hardware                    | Support for Dual Hardware Configuration on Cisco ASR 1001-X, Cisco ASR 1001-HX Router | Support for Dual Hardware Configuration on Cisco ASR1002-X, ASR1002-HX Router | Support for Dual Hardware Configuration on Cisco ASR 1004 Router | Support for Dual Hardware Configuration on Cisco ASR 1006-X and Cisco ASR 1009-X and Router | Failover Behavior                                                                                                                                                                                                                                                                                   |
|-----------------------------|---------------------------------------------------------------------------------------|-------------------------------------------------------------------------------|------------------------------------------------------------------|---------------------------------------------------------------------------------------------|-----------------------------------------------------------------------------------------------------------------------------------------------------------------------------------------------------------------------------------------------------------------------------------------------------|
| Enhanced Services Processor | No                                                                                    | No                                                                            | No                                                               | Yes                                                                                         | If an active ESP experiences a hardware or software event that makes it unable to forward traffic (such as a hardware failure, an OIR, or a manual switch) and a standby ESP is configured, the standby ESP becomes the active ESP with the possibility of a minor interruption (less than 200 ms). |

| Hardware        | Support for Dual Hardware Configuration on Cisco ASR 1001-X, Cisco ASR 1001-HX Router | Support for Dual Hardware Configuration on Cisco ASR1002-X, ASR1002-HX Router | Support for Dual Hardware Configuration on Cisco ASR 1004 Router | Support for Dual Hardware Configuration on Cisco ASR 1006-X and Cisco ASR 1009-X and Router | Failover Behavior                                                                                                                                                                                                                             |
|-----------------|---------------------------------------------------------------------------------------|-------------------------------------------------------------------------------|------------------------------------------------------------------|---------------------------------------------------------------------------------------------|-----------------------------------------------------------------------------------------------------------------------------------------------------------------------------------------------------------------------------------------------|
| Route Processor | No                                                                                    | No                                                                            | No                                                               | Yes                                                                                         | If an active RP experiences an event that makes it unable to forward traffic (such as a hardware failure, a software failure, an OIR, or a manual switch) and a standby RP is configured, the standby RP immediately becomes the active RP.   |
| SPA             | No                                                                                    | No                                                                            | No                                                               | No                                                                                          | No standby configurations are available for SPAs. If a SPA fails, that particular SPA is down and unable to forward traffic.<br><br>In the event of a SPA shutdown, all other SIPs and SPAs on the router continue to be fully operational.   |
| SIP             | No                                                                                    | No                                                                            | No                                                               | No                                                                                          | No standby configurations are available for SIPs. If a SIP fails, all SPAs in that SIP are down and unable to forward traffic.<br><br>In the event of a SIP shutdown, all other SIPs and SPAs on the router continue to be fully operational. |

## Software Redundancy on the Cisco ASR 1000 Series Routers

This section covers the following topics:

### Software Redundancy Overview

On the Cisco ASR 1000 Series Routers, IOS runs as one of many processes within the operating system. This is different than on traditional Cisco IOS, where all processes are run within Cisco IOS. See the [“IOS as a Process” section on page 2-7](#) for more information regarding IOS as a process on the Cisco ASR 1000 Series Router.

This architecture allows for software redundancy opportunities that are not available on other platforms that run Cisco IOS software. Specifically, a standby IOS process can be available on the same Route Processor as the active IOS process. This standby IOS process can be switched to in the event of an IOS failure, and can also be used to upgrade subpackage software in some scenarios as the standby IOS process in a software upgrade.

On the Cisco ASR1006-X and ASR1009-X Router, the second IOS process can run only on the standby Route Processor. Two IOS processes on the same Router Processor are not possible for any Cisco ASR 1000 Series Router that supports dual RP hardware redundancy configurations since the second Route Processor can support a standby IOS process. An overview of software redundancy is shown in [Table 25: Software Redundancy Overview, on page 358](#).

Table 25: Software Redundancy Overview

| Router                                                   | Support for Two IOS Processes on Same Route Processor | Support for a Second IOS Process on Standby Route Processor | Explanation                                                                                                                                      |
|----------------------------------------------------------|-------------------------------------------------------|-------------------------------------------------------------|--------------------------------------------------------------------------------------------------------------------------------------------------|
| Cisco ASR 1001-X, Cisco ASR 1001-HX Router <sup>15</sup> | Yes                                                   | N/A                                                         | Cisco ASR 1001-X, Cisco ASR 1001-HX Router only supports one RP, so dual IOS processes run on the lone RP.                                       |
| Cisco ASR 1002-X, Cisco ASR 1002-HX Router               | Yes                                                   | N/A                                                         | Cisco ASR 1002-X, Cisco ASR 1002-HX Router only supports one RP, so dual IOS processes run on the lone RP.                                       |
| Cisco ASR 1004 Router                                    | Yes                                                   | N/A                                                         | The Cisco ASR 1004 Router only supports one RP, so dual IOS processes run on the lone RP.                                                        |
| Cisco ASR 1006-X, Cisco ASR 1009-X Router                | No                                                    | Yes                                                         | The Cisco ASR 1006-X, Cisco ASR 1009-X supports a second Route Processor, so the second IOS process can only run on the standby Route Processor. |

<sup>15</sup> If a critical process, such as the ESP or the SIP fails on the Cisco ASR1001-X, ASR1001-HX router, then the entire chassis reloads.

## Second IOS Process on a Cisco ASR 1002-X, Cisco ASR 1002-HX or Cisco 1004 Router

For Cisco ASR 1002-X, Cisco ASR 1002-HX or Cisco 1004 routers, Route Processor Redundancy and Stateful Switchover can be used to switch between IOS processes. RPR and SSO need to be configured by the user, however, because a second IOS process is not available by default on Cisco ASR 1002-X, Cisco ASR 1002-HX or Cisco 1004 router.

Table 2 summarizes the software redundancy opportunities available with the second IOS process for the Cisco ASR 1002-X, Cisco ASR 1002-HX or Cisco 1004 Router.

Table 26: Software Redundancy Options for Cisco ASR 1002-X, Cisco ASR 1002-HX or Cisco 1004 Router

| Router                              | Default HA Setting | Options with 2 GB or DRAM | Options with 4 GB or DRAM |
|-------------------------------------|--------------------|---------------------------|---------------------------|
| Cisco ASR 1002-X, Cisco ASR 1002-HX | None               | None                      | None, RPR, SSO            |
| Cisco ASR 1004 Router               | None               | None                      | None, RPR, SSO            |

ISSU cannot be used to upgrade consolidated packages on Cisco ASR 1002-X, Cisco ASR 1002-HX or Cisco 1004 Router, and only a few subpackages can be upgraded individually using ISSU through the use of dual

IOS processes on the same Route Processor. See the [Route Processor Redundancy, on page 360](#) for more information on which subpackages can be upgraded using ISSU in a dual RP setup.

## Configuring two Cisco IOS process on one RP

On the Cisco ASR 1000 Series Routers, Cisco IOS runs as one of the many processes. This architecture supports software redundancy opportunities. Specifically, a standby Cisco IOS process is available on the same Route Processor as the active Cisco IOS process. In the event of a Cisco IOS failure, the system switches to the standby Cisco IOS process. It also supports software upgrade of subpackages when the standby Cisco IOS process is performing an ISSU upgrade.

This section describes how to configure two Cisco IOS process on one RP.

### SUMMARY STEPS

1. enable
2. **configure terminal**
3. redundancy
4. mode SSO
5. **exit**
6. reload

### DETAILED STEPS

|               | Command or Action                                                              | Purpose                                                                                                                   |
|---------------|--------------------------------------------------------------------------------|---------------------------------------------------------------------------------------------------------------------------|
| <b>Step 1</b> | enable<br><b>Example:</b><br><br>Router> enable                                | Enables privileged EXEC mode.<br><br>• Enter your password if prompted.                                                   |
| <b>Step 2</b> | <b>configure terminal</b><br><b>Example:</b><br><br>Router# configure terminal | Enters global configuration mode.                                                                                         |
| <b>Step 3</b> | redundancy<br><b>Example:</b><br><br>Router(config)# redundancy                | Enters redundancy configuration mode.                                                                                     |
| <b>Step 4</b> | mode SSO<br><b>Example:</b><br><br>Router(config)# mode SSO                    | Configures SSO. When this command is entered, the redundant supervisor engine is reloaded and begins to work in SSO mode. |
| <b>Step 5</b> | <b>exit</b><br><b>Example:</b><br><br>Router(config)# exit                     | Exits configuration mode and returns to global configuration mode.                                                        |

## Example

|               | Command or Action                            | Purpose      |
|---------------|----------------------------------------------|--------------|
|               | <b>Example:</b><br>Router #                  |              |
| <b>Step 6</b> | reload<br><b>Example:</b><br>Router # reload | Reloads IOS. |

## Example

```

Router# configure terminal
Router(config)# redundancy
Router(config)# mode SSO
Router(config)# exit
Router# reload

```

## Route Processor Redundancy

Route Processor Redundancy (RPR) allows you to configure a standby RP. When you configure RPR, the standby RP loads the Cisco IOS software on bootup and initializes itself in standby mode. In the event of a fatal error on the active RP, the system switches to the standby RP, which reinitializes itself as the active RP. In this event, the entire system is rebooted, so the switchover with RPR is slower than with other High Availability switchover features such as Nonstop Forwarding/Stateful Switchover (NSF/SSO).

On the Cisco ASR 1000 Series Router, RPR can also be used to enable a second IOS process on a single RP for a Cisco ASR1002-X, ASR1002-HX or Cisco 1004 Router. See the [Second IOS Process on a Cisco ASR 1002-X, Cisco ASR 1002-HX or Cisco 1004 Router, on page 358](#) for additional information on the second IOS process.

For the Cisco ASR 1000 Series Routers, RPR introduces the following functionality:

- Startup configuration synchronization between the active and standby RP or IOS process. It is important to note, however, that changes in the running configuration are not synchronized using RPR.
- Warm Reload—The Warm Reload feature allows users to reload their routers without reading images from storage; that is, the router reboots by restoring the read-write data from a previously saved copy in the RAM and by starting execution without either copying the software from flash to RAM or self-decompression of the image.

It is important to note that in most cases, Stateful Switchover (SSO) requires less downtime for switchover and upgrades than RPR. RPR should only be used when there is a compelling reason to not use SSO.

It is important to note RPR is supported on the Cisco ASR 1000 Series Routers while RPR+ is not.

## Stateful Switchover

The Stateful Switchover (SSO) feature takes advantage of processor redundancy by establishing one of the processors as the active processor while the other RP is designated as the standby processor, and then

synchronizing critical state information between them. Following an initial synchronization between the two processors, SSO dynamically maintains RP state information between the dual processors.

Stateful Switchover is particularly useful in conjunction with Nonstop Forwarding. SSO allows the dual processors to maintain state at all times, and Nonstop Forwarding lets a switchover happen seamlessly when a switchover occurs.

On the Cisco ASR 1000 Series Router, SSO can also be used to enable a second IOS process on a single RP for a Cisco ASR 1002-X, Cisco ASR 1002-HX or Cisco 1004 Router. See the [Second IOS Process on a Cisco ASR 1002-X, Cisco ASR 1002-HX or Cisco 1004 Router, on page 358](#) for additional information on the second IOS process.

It is important to note that in most cases, SSO requires less downtime for switchover and upgrades than RPR. RPR should only be used when there is a compelling reason to not use SSO.

For additional information on NSF/SSO, see the [Cisco Nonstop Forwarding](#) document.

## SSO-Aware Protocol and Applications

SSO-supported line protocols and applications must be SSO-aware. A feature or protocol is SSO-aware if it maintains, either partially or completely, undisturbed operation through an RP switchover. State information for SSO-aware protocols and applications is synchronized from active to standby to achieve stateful switchover for those protocols and applications.

The dynamically created state of SSO-unaware protocols and applications is lost on switchover and must be reinitialized and restarted on switchover.

To see which protocols are SSO-aware on your router, use the following commands **show redundancy client** or **show redundancy history**.

## IPsec Failover

IPSec failover is a feature that increases the total uptime (or availability) of a customer's IPSec network. Traditionally, this is accomplished by employing a redundant (standby) router in addition to the original (active) router. If the active router becomes unavailable for any reason, the standby router takes over the processing of IKE and IPSec. IPSec failover falls into two categories: stateless failover and stateful failover.

The IPSec on the Cisco ASR 1000 Series Router supports only stateless failover. Stateless failover uses protocols such as the Hot Standby Router Protocol (HSRP) to provide primary to secondary cutover and also allows the active and standby VPN gateways to share a common virtual IP address.

## Bidirectional Forwarding Detection

Bidirectional Forwarding Detection (BFD) is a detection protocol designed to provide fast forwarding path failure detection times for all media types, encapsulations, topologies, and routing protocols. In addition to fast forwarding path failure detection, BFD provides a consistent failure detection method for network administrators. Because the network administrator can use BFD to detect forwarding path failures at a uniform rate rather than the variable rates for different routing protocol hello mechanisms, network profiling and planning is easier, and reconvergence time is consistent and predictable.

On the Cisco ASR 1000 Series Routers, BFD for IPv4 Static Routes and BFD for BGP are supported.

For more information on BFD, see the [Bidirectional Forwarding Detection](#) document.

## Additional References

### Related Documents

| Related Topic                           | Document Title                                                        |
|-----------------------------------------|-----------------------------------------------------------------------|
| Bidirectional Forwarding Detection      | <i>IP Routing BFD Configuration Guide, Cisco IOS XE Release 3S</i>    |
| High Availability Configurations        | <i>High Availability Configuration Guide, Cisco IOS XE Release 3S</i> |
| Software Upgrade Process Configurations | Software Upgrade Process Configuration Guide                          |

### Standards

| Standard | Title |
|----------|-------|
| None     | —     |

### MIBs

| MIB  | MIBs Link                                                                                                                                                                                                     |
|------|---------------------------------------------------------------------------------------------------------------------------------------------------------------------------------------------------------------|
| None | To locate and download MIBs for selected platforms, Cisco IOS releases, and feature sets, use Cisco MIB Locator found at this URL:<br><a href="http://www.cisco.com/go/mibs">http://www.cisco.com/go/mibs</a> |

### RFCs

| RFC  | Title |
|------|-------|
| None | —     |

### Technical Assistance

| Description                                                                                                                                                                                                                                                                                                                                                                           | Link                                                                                                              |
|---------------------------------------------------------------------------------------------------------------------------------------------------------------------------------------------------------------------------------------------------------------------------------------------------------------------------------------------------------------------------------------|-------------------------------------------------------------------------------------------------------------------|
| The Cisco Support and Documentation website provides online resources to download documentation, software, and tools. Use these resources to install and configure the software and to troubleshoot and resolve technical issues with Cisco products and technologies. Access to most tools on the Cisco Support and Documentation website requires a Cisco.com user ID and password. | <a href="http://www.cisco.com/cisco/web/support/index.html">http://www.cisco.com/cisco/web/support/index.html</a> |



# Feature Information for High Availability Overview

[Table 27: Feature Information for High Availability Overview](#), on page 363 lists the features in this module and provides links to specific configuration information.

Use Cisco Feature Navigator to find information about platform support and software image support. Cisco Feature Navigator enables you to determine which software images support a specific software release, feature set, or platform. To access Cisco Feature Navigator, go to <http://www.cisco.com/go/cfn>. An account on Cisco.com is not required.



**Note** [Table 27: Feature Information for High Availability Overview](#), on page 363 lists only the software release that introduced support for a given feature in a given software release train. Unless noted otherwise, subsequent releases of that software release train also support that feature.

**Table 27: Feature Information for High Availability Overview**

| Feature Name               | Releases          | Feature Information                                                                            |
|----------------------------|-------------------|------------------------------------------------------------------------------------------------|
| High Availability Overview | Cisco IOS XE 2.1S | In Cisco IOS XE Release 2.1S, this feature was introduced on the Cisco ASR 1000 Series Router. |





# CHAPTER 13

## Broadband Scalability and Performance

The infrastructure of a service provider must be capable of supporting the services that an enterprise customer or Internet service provider (ISP) wants to offer its subscribers. The service provider must also be able to scale up to an expanding subscriber base. You can configure the Cisco ASR1000 Series Routers for high broadband scalability.

- [Finding Feature Information in This Module, on page 365](#)
- [Contents, on page 365](#)
- [PPP Sessions and L2TP Tunnel Scaling, on page 365](#)
- [Configuring the Cisco ASR 1000 Series Router for High Scalability, on page 366](#)
- [Using the cisco avpair lcp interface config RADIUS Attribute, on page 369](#)
- [Additional References, on page 371](#)
- [Feature Information for Broadband Scalability and Performance, on page 372](#)

### Finding Feature Information in This Module

Your software release might not support all the features documented in this module. For the latest feature information and caveats, see the release notes for your platform and software release. To find information about the features documented in this module, and to see a list of the releases in which each feature is supported, see the [Feature Information for Broadband Scalability and Performance, on page 372](#).

Use Cisco Feature Navigator to find information about platform support and Cisco software image support. To access Cisco Feature Navigator, go to <http://www.cisco.com/go/cfn>. An account on Cisco.com is not required.

### Contents

This guide provides information about the following topics:

### PPP Sessions and L2TP Tunnel Scaling

The ASR 1000 Series Routers are deployed in a variety of broadband deployment models for terminating Point-to-Point Protocol (PPP) Sessions and initiating or terminating Layer 2 Tunneling Protocol (L2TP) tunnels. The maximum number of PPP sessions and L2TP tunnels is dependent on the hardware combination.

## Restrictions for PPP Sessions and L2TP Tunnel Scaling

This section lists the restrictions for the PPP sessions and L2TP tunnel scalability.

- To achieve maximum scaling for the 1001, 1002, and 1004 chassis, we recommend software redundancy be disabled for broadband applications, and only hardware redundancy be configured.
- Restrictions on 48000 session scaling with RP2 and ESP-40G include:
  - Intelligent Services Gateway (ISG) Services are not supported
  - Point-to-Point Protocol over ATM (PPPoA) and Point-to-Point Protocol over Ethernet (PPPoEoA) sessions are not supported
  - RP2 requires 16 GB DRAM to support 48000 sessions



---

**Note** If any of the listed restrictions is not met, the router scales to a maximum of 32000 sessions only.

---

- Restrictions on the 64000 session scaling with RP2 and ESP-40G:
  - ISG services are not supported
  - PPPoA and PPPoEoA sessions are not supported
  - Per-session QoS with queuing actions (for example, shaping) is not supported
  - RP2 requires 16 GB DRAM to support 64000 sessions



---

**Note** If any of the listed restrictions is not met, the router scales to a maximum of 32000 sessions or 48000 sessions only.

---

- Restrictions on 64000 L2TP tunnel scaling with RP2 and ESP-40G:
  - ISG services are not supported
  - Per-session QoS is not supported
  - RP2 requires 16 GB DRAM
  - High Availability (SSO) is not supported



---

**Note** If any of the listed restrictions is not met, the router scales to a maximum of 16000 L2TP tunnels.

---

- The RP2 and ESP10 hardware combination is not supported for broadband.
- RP1 with 2GB of DRAM is not recommended for broadband deployment.

## Configuring the Cisco ASR 1000 Series Router for High Scalability

The Cisco ASR 1000 Series Routers provide powerful performance and scalability for embedded services.

To achieve maximum scaling on the 1001, 1002, and 1004 chassis, IOS software redundancy must be disabled.

To ensure high scalability on the Cisco ASR 1000 Series Aggregation Services Router, perform the following configuration tasks:

## Configuring Call Admission Control

The Call Admission Control (CAC) feature is configured to protect the ASR 1000 processing resources that must be configured. CAC can restrict the media bandwidth dedicated to active calls when CPU utilization exceeds the configured threshold.

This section provides the following examples for configuring CAC:

### Configuring a PPPoE Session

```
router(config)# call admission new-model
router(config)# call admission limit 1000
router(config)# call admission cpu-limit 80
router(config)# call admission pppoe 10 1
```

### Configuring a PPPoA Session

```
router(config)# call admission new-model
router(config)# call admission limit 1000
router(config)# call admission cpu-limit 80
router(config)# call admission pppoa 10 1
```

### Configuring a VPDN Session

```
router(config)# call admission new-model
router(config)# call admission limit 1000
router(config)# call admission cpu-limit 80
router(config)# call admission vpdn 10 1
```

## Control Plane Policing

The Control Plane Policing feature allows you to configure a QoS filter that manages the traffic flow of control plane packets to protect the control plane of Cisco IOS XE routers and switches against reconnaissance and denial-of-service (DoS) attacks. The control plane thus helps maintain packet forwarding and protocol states despite an attack or heavy traffic load on the router or switch.

For examples about configuring the Control Plane Policing feature, see the “Control Plane Policing” section in the *Quality of Service Solutions Configuration Guide* located at:

[http://www.cisco.com/en/US/docs/ios-xml/ios/qos\\_plcshp/configuration/xe-3s/qos-plcshp-ctrl-pln-plc.html](http://www.cisco.com/en/US/docs/ios-xml/ios/qos_plcshp/configuration/xe-3s/qos-plcshp-ctrl-pln-plc.html)

## VPDN Group Session Limiting

Using the Virtual Private Dialup Network (VPDN) Group Session Limiting feature, you can limit the number of VPDN sessions allowed per VPDN group. VPDN session limits can increase performance and reduce latency for routers that are otherwise forced to operate at high capacity.

For more information about VPDN Group Session Limiting, see the feature documentation at:

<http://www.cisco.com/en/US/docs/ios-xml/ios/vpdn/configuration/xe-3s/vpd-tunnel-mgmt.html>

## PPPoE Session Limiting

The PPPoE Session Limit Support feature prevents the router from using too much memory for virtual access by limiting the number of PPPoE sessions that can be created on a router or on all Ethernet interfaces and subinterfaces as well as ATM interfaces and subinterfaces.

For more information about PPPoE session limiting, see the feature documentation at:

<http://www.cisco.com/en/US/docs/ios-xml/ios/bbds1/configuration/xe-3s/bba-limit-legcfg-xe.html>

## Monitoring PPP Sessions Using the SNMP Management Tools

To prevent the virtual access subinterfaces from being registered with the Simple Network Management Protocol (SNMP) functionality of the router and using up the memory, do not use the SNMP management tools of the router to monitor PPP sessions. Use SNMP views to isolate the bulk queries and accidental requests.

Use the **no virtual-template snmp** command to disable the SNMP management tools:

```
Router(config)# no virtual-template snmp
```

## Configuring the Access Interface Input and Output Hold Queue

The default value of Gigabit Ethernet and 10 Gigabit Ethernet interfaces is 375 packets for the input and output hold queues. If the interfaces are required to handle a high rate of control packets, such as LCP, IPCP, PPP, L2TP, and DHCP, the default value may not be sufficient. To ensure high scalability, set the access interface input and output hold queue to 4096:

```
Router(config)# interface gig1/0/0
Router(config-if)# hold-queue 4096 in
```

## Configuring the keepalive Command

For PPP sessions, the **keepalive** command sets the keepalive timer for a specific interface. To ensure proper scaling and to minimize CPU utilization, set the timer for 60 seconds or longer. The default value is 10 seconds:

```
interface Virtual-Template1
 ip unnumbered Loopback1
 keepalive 60
 no peer default ip address
 ppp authentication pap
```



**Note** For IP sessions, the keepalives are not enabled by default. Enabling keepalives for IP sessions provides the same capability as PPP keepalives except that ICMP or ARP is used to test the presence of subscribers. For more information about Using ARP for Keepalive Messages and Using ICMP for Keepalive Messages, see the feature documentation at: [http://www.cisco.com/en/US/docs/ios-xml/ios/isg/configuration/xe-3s/Configuring\\_ISG\\_Policies\\_for\\_Session\\_Maintenance.html](http://www.cisco.com/en/US/docs/ios-xml/ios/isg/configuration/xe-3s/Configuring_ISG_Policies_for_Session_Maintenance.html)

## Scaling the L2TP Tunnel Configurations

To prevent head-of-the-line blocking of the IP input process and save system resources, configure the `vpdn ip udp ignore checksum` command:

```
Router(config)# vpdn ip udp ignore checksum
```

When you configure this command, the router directly queues the L2TP Hello packets and Hello acknowledgements to the L2TP control process. We recommend that you configure this command in all the scaled LAC and LNS L2TP tunnel configurations.

If you do not configure the `vpdn ip udp ignore checksum` command, the L2TP software sends the packets to UDP to validate the checksum. When too many packets are queued to the IP input process, the router starts Selective Packet Discard (SPD) mechanism that causes IP packets to be dropped.



---

**Note** Head-of-the-line blocking of the IP input process might occur in other nonL2TP configurations. A flush occurring on an input interface indicates that the SPD mechanism is discarding packets.

---

## Using the cisco avpair lcp interface config RADIUS Attribute

When you use the `lcp:interface-config RADIUS` attribute to reconfigure the virtual access subscriber interface, call setup rate could be reduced on the Cisco ASR 1000 Series Aggregation Services Routers because the `lcp:interface-config` command syntax includes an IOS interface configuration command. This command is any valid IOS command that can be applied to an interface. When the `lcp:interface-config` attribute is downloaded from the RADIUS server to the Cisco ASR 1000 Series Aggregation Services Routers, the command parser is activated to configure the interface according to AV-pair, determining if the option is valid and then applying the configuration to the virtual access interface (VAI).

The subscriber session scaling on the Cisco ASR 1000 Series Aggregation Services Routers is not impacted by using the `lcp:interface-config RADIUS` attribute any more than if the equivalent IOS interface command was applied directly onto the virtual-template configuration and was cloned onto the VAI using that method. Using either the `lcp:interface-config RADIUS` attribute or the virtual-template to apply configuration onto the VAI it is the type of configuration being applied which may in a few cases affect the maximum subscriber session scale of the Cisco ASR 1000 Series Aggregation Services Routers.

## Enhancing the Scalability of Per-User Configurations

To enhance scalability of per-user configurations without changing the router configuration, use the `ip:vrf-id` and `ip:ip-unnumbered` RADIUS attributes. These per-user vendor-specific attributes (VSAs) are used to map sessions to VRFs and IP unnumbered interfaces. The VSAs are applied to virtual access subinterfaces and are processed during PPP authorization.

The `ip:vrf-id` attribute is used to map sessions to VRFs. Any profile that uses the `ip:vrf-id` VSA must also use the `ip:ip-unnumbered` VSA to install IP configurations on the VAI that is to be created. The PPP that is used on a VAI to be created requires the `ip:ip-unnumbered` VSA. An Internet Protocol Control Protocol (IPCP) session is not established if IP is not configured on the interface. You must configure either the `ip address` command or the `ip unnumbered` command on the interface so that these configurations are present on the VAI that is to be created. However, specifying the `ip address` and `ip unnumbered` commands on a virtual template interface is not required because pre-existing IP configurations, if any, are removed when the `ip:ip-vrf` VSA

is installed on the VAI. Therefore, any profile that uses the `ip:vrf-id` VSA must also use the `ip:ip-unnumbered` VSA to install IP configurations on the VAI that is to be created.

These per-user VSAs can be applied to VAIs. Therefore, the per-user authorization process does not require the creation of full VAIs, which improves scalability.

## Setting the VRF and IP Unnumbered Interface Configurations in User Profiles

Although the Cisco ASR 1000 Series Aggregation Services Router continues to support the `lcp:interface-config` VSA, the `ip:vrf-id` and `ip:ip-unnumbered` VSAs provide another way to set the VRF and IP unnumbered interface configurations in user profiles. The `ip:vrf-id` and `ip:ip-unnumbered` VSAs have the following syntax:

```
Cisco:Cisco-Avpair = "ip:vrf-id=vrf-name"
Cisco:Cisco-Avpair = "ip:ip-unnumbered=interface-name"
```

You should specify only one `ip:vrf-id` and one `ip:ip-unnumbered` value in a user profile. However, if the profile configuration includes multiple values, the Cisco ASR 1000 Series Aggregation Services Router applies the value of the last VSA received, and creates a virtual access subinterface. If the profile includes the `lcp:interface-config` VSA, the router always applies the value of the `lcp:interface-config` VSA.

## Setting the VRF and IP Unnumbered Interface Configurations in Virtual Interface Templates

You can specify one VSA value in a user profile on RADIUS and another value locally in the virtual template interface. The Cisco ASR 1000 Series Aggregation Services Router clones the template and then applies the values configured in the profiles it receives from RADIUS, resulting in the removal of any IP configurations when the router applies the profile values.

## Redefining User Profiles to Use the `ip:vrf-id` and `ip:ip-unnumbered` VSAs

The requirement of a full virtual access interface when using the `lcp:interface-config` VSA in user profiles can result in scalability issues, such as increased memory consumption. This situation is especially true when the Cisco ASR 1000 Series Aggregation Services Router attempts to apply a large number of per-user profiles that include the `lcp:interface-config` VSA. Therefore, when updating your user profiles, we recommend that you redefine the `lcp:interface-config` VSA to the scalable `ip:vrf-id` and `ip:ip-unnumbered` VSAs.

The following example shows how to redefine a VRF named `newyork` using the `ip:vrf-id` VSA:

```
Change:
Cisco:Cisco-Avpair = "lcp:interface-config=ip vrf forwarding newyork"
To:
Cisco:Cisco-Avpair = "ip:vrf-id=newyork"
```

The following example shows how to redefine the Loopback 0 interface using the `ip:ip-unnumbered` VSA.

```
Change:
Cisco:Cisco-Avpair = "lcp:interface-config=ip unnumbered Loopback 0"
To:
Cisco:Cisco-Avpair = "ip:ip-unnumbered=Loopback 0"
```



# Additional References

## Related Documents

| Related Topic                                                          | Document Title                                                           |
|------------------------------------------------------------------------|--------------------------------------------------------------------------|
| Control Plane Policing                                                 | <i>Quality of Service Solutions Configuration Guide</i>                  |
| VPDN Group Session Limiting                                            | <i>VPDN Configuration Guide, Cisco IOS XE Release 3S</i>                 |
| PPPoE session limiting                                                 | Configuring PPP over Ethernet Session Limit Support Feature Guide        |
| Using ARP for Keepalive Messages and Using ICMP for Keepalive Messages | Intelligent Services Gateway Configuration Guide Cisco IOS XE Release 3S |

## Standards

| Standard | Title |
|----------|-------|
| None     | —     |

## MIBs

| MIB  | MIBs Link                                                                                                                                                                                                     |
|------|---------------------------------------------------------------------------------------------------------------------------------------------------------------------------------------------------------------|
| None | To locate and download MIBs for selected platforms, Cisco IOS releases, and feature sets, use Cisco MIB Locator found at this URL:<br><a href="http://www.cisco.com/go/mibs">http://www.cisco.com/go/mibs</a> |

## RFCs

| RFC  | Title |
|------|-------|
| None | —     |

## Technical Assistance

| Description                                                                                                                                                                                                                                                                                                                                                                           | Link                                                                                                              |
|---------------------------------------------------------------------------------------------------------------------------------------------------------------------------------------------------------------------------------------------------------------------------------------------------------------------------------------------------------------------------------------|-------------------------------------------------------------------------------------------------------------------|
| The Cisco Support and Documentation website provides online resources to download documentation, software, and tools. Use these resources to install and configure the software and to troubleshoot and resolve technical issues with Cisco products and technologies. Access to most tools on the Cisco Support and Documentation website requires a Cisco.com user ID and password. | <a href="http://www.cisco.com/cisco/web/support/index.html">http://www.cisco.com/cisco/web/support/index.html</a> |

## Feature Information for Broadband Scalability and Performance

The table below lists the features in this module and provides links to specific configuration information.

Use Cisco Feature Navigator to find information about platform support and software image support. Cisco Feature Navigator enables you to determine which software images support a specific software release, feature set, or platform. To access Cisco Feature Navigator, go to <http://www.cisco.com/go/cfn>. An account on Cisco.com is not required.



**Note** The below table lists only the software release that introduced support for a given feature in a given software release train. Unless noted otherwise, subsequent releases of that software release train also support that feature.

**Table 28: Feature Information for Broadband Scalability and Performance**

| Feature Name                          | Releases          | Feature Information                                                                            |
|---------------------------------------|-------------------|------------------------------------------------------------------------------------------------|
| High Availability Overview            | Cisco IOS XE 2.1S | In Cisco IOS XE Release 2.1S, this feature was introduced on the Cisco ASR 1000 Series Router. |
| Walk-by User Support for PWLAN in ISG | Cisco IOS XE 3.7S | In Cisco IOS XE Release 3.7S, this feature was introduced on the Cisco ASR 1000 Series Router. |



## CHAPTER 14

# UniDirectional Link Detection (UDLD) Protocol

First Published: March 28, 2013

This document describes how to configure the UniDirectional Link Detection (UDLD) protocol on the Cisco ASR 1000 Series Aggregation Services Routers.

- [Finding Feature Information, on page 373](#)
- [Contents, on page 373](#)
- [Restrictions for the UDLD Protocol, on page 373](#)
- [Information About the UDLD Protocol, on page 374](#)
- [How to Configure the UDLD Protocol, on page 375](#)
- [Configuration Examples for UDLD Protocol, on page 381](#)
- [Additional References, on page 382](#)
- [Feature Information for Configuring UDLD on Cisco ASR 1000 Series Aggregation Services Routers, on page 383](#)

## Finding Feature Information

Your software release may not support all the features documented in this module. For the latest information about features and caveats, see the release notes document pertaining to your platform and software release. To find information about the features documented in this module and to view a list of the releases in which each feature is supported, see the [Feature Information for Configuring UDLD on Cisco ASR 1000 Series Aggregation Services Routers, on page 383](#).

Use the Cisco Feature Navigator to find information about platform support and Cisco IOS and Cisco Catalyst operating system software image support. To access the Cisco Feature Navigator, go to <http://www.cisco.com/go/cfn>. An account on Cisco.com is not required.

## Contents

## Restrictions for the UDLD Protocol

Currently, the UDLD protocol on the Cisco ASR 1000 Series Aggregation Services Routers has the following limitations:

- High Availability (HA) is not supported, but when the Ethernet port is up and UDLD is enabled on the port, the UDLD automatically performs the detection.
- Only Gigabit Ethernet, 10 Gigabit Ethernet, and Fast Ethernet interfaces are supported.
- Supports only the basic UDLD functions.

## Information About the UDLD Protocol

These sections describe how UDLD works:

### UDLD Overview

The Cisco-proprietary UDLD protocol allows the devices connected through fiber optic or copper (for example, Category 5 cabling) Ethernet cables that are connected to the LAN ports to monitor the physical configuration of the cables and detect whether a unidirectional link exists. When a unidirectional link is detected, the UDLD shuts down the affected LAN port and alerts the corresponding user, because unidirectional links cause a variety of problems, including spanning tree topology loops.

UDLD is a Layer 2 protocol that works with the Layer 1 protocols to determine the physical status of a link. In Layer 1, auto negotiation takes care of physical signaling and fault detection. UDLD performs tasks that auto negotiation cannot perform, such as detecting the identities of neighbors and shutting down misconnected LAN ports. When you enable both auto negotiation and UDLD, the Layer 1 and Layer 2 detections work together to prevent physical and logical unidirectional connections and the malfunctioning of other protocols.

A unidirectional link occurs whenever the traffic transmitted by a local device over a link is received by a neighbor, but traffic transmitted from the neighbor is not received by the local device. If one of the fiber strands in a pair is disconnected, the link does not stay up as long as the auto negotiation is active. In such a scenario, the logical link is undetermined, and the UDLD does not take any action. If both the fibers are working normally in Layer 1, the UDLD in Layer 2 determines whether those fibers are connected correctly and whether the traffic is flowing bidirectionally between the correct neighbors. This check cannot be performed by auto negotiation because auto negotiation operates in Layer 1.

The Cisco ASR 1000 Series Aggregation Services Routers periodically transmit the UDLD packets to the neighbor devices on LAN ports where UDLD is enabled. If the packets are echoed back within a specific timeframe and they are lacking a specific acknowledgment (echo), the link is flagged as unidirectional and the LAN port is shut down. Devices on both ends of the link must support UDLD for the protocol to successfully identify and disable the unidirectional links.



---

**Note** By default, the UDLD is disabled on all ports to avoid sending unnecessary traffic.

---

The following figure shows an example of a unidirectional link condition. Switch B successfully receives traffic from Switch A on the port. However, Switch A does not receive traffic from Switch B on the same port. UDLD detects the problem and disables the port.

Figure 1: Unidirectional Link

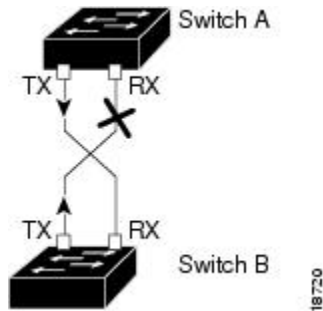

## Configuring the UDLD Aggressive Mode

Configure the UDLD aggressive mode only on the point-to-point link between the network devices that support the UDLD aggressive mode. With UDLD aggressive mode enabled, a port on a bidirectional link that has a UDLD neighbor relationship established stops receiving the UDLD packets. The UDLD tries to re-establish the connection with the neighbor; the port is disabled after eight failed retries.

To prevent spanning tree loops, nonaggressive UDLD with the default interval of 15 seconds is fast enough to shut down a unidirectional link before a blocking port transitions to the forwarding state (with default spanning tree parameters).

When the UDLD aggressive mode is enabled, the UDLD will error disable the ports on the link to prevent the traffic from being discarded under the following scenarios:

- One side of a link has a port (either Tx and Rx) stuck.
- One side of a link remains up while the other side of the link has gone down.

## Default UDLD Configuration

The following table shows the default UDLD configuration.

Table 29: UDLD Default Configuration

| Feature                                                    | Default Value                                             |
|------------------------------------------------------------|-----------------------------------------------------------|
| UDLD global enable state                                   | Globally disabled                                         |
| UDLD aggressive mode                                       | Disabled                                                  |
| UDLD per-port enable state for fiber-optic media           | Disabled                                                  |
| UDLD per-port enable state for twisted-pair (copper) media | Disabled on all Ethernet 10/100 and 1000BASE-TX LAN ports |

## How to Configure the UDLD Protocol

These sections describe how to configure the UDLD protocol:

## Enabling UDLD Globally

To globally enable the UDLD on all fiber-optic LAN ports, perform this task:

### SUMMARY STEPS

1. **enable**
2. **configure terminal**
3. **udld {enable | aggressive}**

### DETAILED STEPS

|               | Command or Action                                                                                                                              | Purpose                                                                                                                                                                                                                                                                                       |
|---------------|------------------------------------------------------------------------------------------------------------------------------------------------|-----------------------------------------------------------------------------------------------------------------------------------------------------------------------------------------------------------------------------------------------------------------------------------------------|
| <b>Step 1</b> | <b>enable</b><br><b>Example:</b><br>Router# enable                                                                                             | Enables the privileged EXEC mode.<br>Enter your password, if prompted.                                                                                                                                                                                                                        |
| <b>Step 2</b> | <b>configure terminal</b><br><b>Example:</b><br>Router# configure terminal                                                                     | Enters the global configuration mode.                                                                                                                                                                                                                                                         |
| <b>Step 3</b> | <b>udld {enable   aggressive}</b><br><b>Example:</b><br>no udld {enable   aggressive}<br><b>Example:</b><br>Router(config)# <b>udld enable</b> | Enables the UDLD globally on fiber-optic LAN ports.<br><b>Note</b> This command configures only the fiber-optic LAN ports. Individual LAN port configuration overrides the setting of this command.<br>Use the no form of this command to disable the UDLD globally on fiber-optic LAN ports. |

## Enabling UDLD on Individual LAN Interfaces

To enable the UDLD on individual LAN interfaces, perform this task:

### SUMMARY STEPS

1. **enable**
2. **configure terminal**
3. **interface type slot/port**
4. **udld port [aggressive]**

### DETAILED STEPS

|               | Command or Action | Purpose                           |
|---------------|-------------------|-----------------------------------|
| <b>Step 1</b> | <b>enable</b>     | Enables the privileged EXEC mode. |

|               | Command or Action                                                                                                                               | Purpose                                                                                                                                                                                                                                                                                                                                                                                                                                                 |
|---------------|-------------------------------------------------------------------------------------------------------------------------------------------------|---------------------------------------------------------------------------------------------------------------------------------------------------------------------------------------------------------------------------------------------------------------------------------------------------------------------------------------------------------------------------------------------------------------------------------------------------------|
|               | <b>Example:</b><br>Router> enable                                                                                                               | Enter your password, if prompted.                                                                                                                                                                                                                                                                                                                                                                                                                       |
| <b>Step 2</b> | configure terminal<br><b>Example:</b><br>Router# <b>configure terminal</b>                                                                      | Enters the global configuration mode.                                                                                                                                                                                                                                                                                                                                                                                                                   |
| <b>Step 3</b> | <b>interface</b> <i>type slot/port</i><br><b>Example:</b><br>Router(config)# <i>interface gigabitethernet2/2</i>                                | Selects the LAN port to configure.                                                                                                                                                                                                                                                                                                                                                                                                                      |
| <b>Step 4</b> | <b>udld port [aggressive]</b><br><b>Example:</b><br>no udld port [aggressive]<br><b>Example:</b><br>Router(config)# <i>udld port aggressive</i> | Enables UDLD on a specific LAN port. Enter the aggressive keyword to enable the aggressive mode. On a fiber-optic LAN port, this command overrides the udld enable global configuration command setting.<br><br>Use the no form of this command to disable the UDLD on a nonfiber-optic LAN port.<br><br>On fiber-optic LAN ports, the no udld port command reverts the LAN port configuration to the udld enable global configuration command setting. |

## Disabling UDLD on Fiber-Optic LAN Interfaces

To disable the UDLD on individual fiber-optic LAN ports, perform this task:

### SUMMARY STEPS

1. enable
2. configure terminal
3. **interface** *type slot/port*
4. **udld port disable**

### DETAILED STEPS

|               | Command or Action                           | Purpose                                                                    |
|---------------|---------------------------------------------|----------------------------------------------------------------------------|
| <b>Step 1</b> | enable<br><b>Example:</b><br>Router> enable | Enables the privileged EXEC mode.<br><br>Enter your password, if prompted. |
| <b>Step 2</b> | configure terminal<br><b>Example:</b>       | Enters the global configuration mode.                                      |

|               | Command or Action                                                                                                                         | Purpose                                                                                                                                                                                                                                   |
|---------------|-------------------------------------------------------------------------------------------------------------------------------------------|-------------------------------------------------------------------------------------------------------------------------------------------------------------------------------------------------------------------------------------------|
|               | Router# <b>configure terminal</b>                                                                                                         |                                                                                                                                                                                                                                           |
| <b>Step 3</b> | <b>interface</b> <i>type slot/port</i><br><b>Example:</b><br><i>Router(config)# interface gigabitethernet2/2</i>                          | Selects the LAN port to configure.                                                                                                                                                                                                        |
| <b>Step 4</b> | <b>udld port disable</b><br><b>Example:</b><br><i>no udld port disable</i><br><b>Example:</b><br><i>Router(config)# udld port disable</i> | Disables UDLD on a fiber-optic LAN port.<br><br>Use the no form of this command to revert to the <b>udld enable</b> global configuration command setting.<br><br><b>Note</b> This command is supported only on the fiber-optic LAN ports. |

## Configuring the UDLD Probe Message Interval

To configure the time between UDLD probe messages on ports that are in the advertisement mode and are currently determined to be bidirectional, perform this task:

### SUMMARY STEPS

1. **enable**
2. **configure terminal**
3. **udld message time** *interval*

### DETAILED STEPS

|               | Command or Action                                                                                        | Purpose                                                                                                                                                                                                                                                                          |
|---------------|----------------------------------------------------------------------------------------------------------|----------------------------------------------------------------------------------------------------------------------------------------------------------------------------------------------------------------------------------------------------------------------------------|
| <b>Step 1</b> | <b>enable</b><br><b>Example:</b><br><i>Router&gt; enable</i>                                             | <b>Enables the privileged EXEC mode.</b><br><br><b>Enter your password, if prompted.</b>                                                                                                                                                                                         |
| <b>Step 2</b> | <b>configure terminal</b><br><b>Example:</b><br><i>Router# configure terminal</i>                        | Enters the global configuration mode.                                                                                                                                                                                                                                            |
| <b>Step 3</b> | <b>udld message time</b> <i>interval</i><br><b>Example:</b><br><i>no udld message</i><br><b>Example:</b> | Configures the time between the UDLD probe messages on the ports that are in the advertisement mode and are currently determined to be bidirectional. Valid values are from 7 to 90 seconds.<br><br>Use the no form of this command to return to the default value (15 seconds). |



|  | Command or Action                                 | Purpose |
|--|---------------------------------------------------|---------|
|  | <code>Router(config)# udld message time 60</code> |         |

## Resetting the Disabled LAN Interfaces Manually

To reset all the LAN ports that have been shut down by UDLD, perform this task:

### SUMMARY STEPS

1. `enable`
2. `udld reset`

### DETAILED STEPS

|               | Command or Action                                                             | Purpose                                                                              |
|---------------|-------------------------------------------------------------------------------|--------------------------------------------------------------------------------------|
| <b>Step 1</b> | <code>enable</code><br><b>Example:</b><br><code>Router&gt; enable</code>      | <b>Enables the privileged EXEC mode.</b><br><b>Enter your password, if prompted.</b> |
| <b>Step 2</b> | <code>udld reset</code><br><b>Example:</b><br><code>Router# udld reset</code> | Resets all the LAN ports that have been shut down by UDLD.                           |

## Resetting the Disabled LAN Interfaces Automatically

To automatically reset all the LAN ports that have been shut down by UDLD, perform this task:

### SUMMARY STEPS

1. `enable`
2. `configure terminal`
3. `udld recovery`
4. `udld recovery interval interval`

### DETAILED STEPS

|               | Command or Action                                                        | Purpose                                                                              |
|---------------|--------------------------------------------------------------------------|--------------------------------------------------------------------------------------|
| <b>Step 1</b> | <code>enable</code><br><b>Example:</b><br><code>Router&gt; enable</code> | <b>Enables the privileged EXEC mode.</b><br><b>Enter your password, if prompted.</b> |
| <b>Step 2</b> | <code>configure terminal</code><br><b>Example:</b>                       | Enters the global configuration mode.                                                |

|               | Command or Action                                                                                                                                    | Purpose                                                                                                                                                                                         |
|---------------|------------------------------------------------------------------------------------------------------------------------------------------------------|-------------------------------------------------------------------------------------------------------------------------------------------------------------------------------------------------|
|               | Router# <b>configure terminal</b>                                                                                                                    |                                                                                                                                                                                                 |
| <b>Step 3</b> | udd recovery<br><b>Example:</b><br>no udd recovery<br><b>Example:</b><br>Router(config)# <b>udd recovery</b>                                         | Enables the recovery timer for the UDLD error disabled state.<br><br>Use the no form of this command to disable the recovery timer for the UDLD error disabled state.                           |
| <b>Step 4</b> | udd recovery interval interval<br><b>Example:</b><br>no udd recovery interval<br><b>Example:</b><br>Router(config)# <b>udd recovery interval 100</b> | Specifies the time to recover from a UDLD error disabled state. Valid values are from 30 to 86400 seconds.<br><br>Use the no form of this command to return to the default value (300 seconds). |

## Debugging UDLD

To enable the debugging of an UDLD activity, perform this task:

### SUMMARY STEPS

1. **enable**
2. **debug udd** {events | packets | registries}

### DETAILED STEPS

|               | Command or Action                                                                                                                                              | Purpose                                                                                                                                                                                         |
|---------------|----------------------------------------------------------------------------------------------------------------------------------------------------------------|-------------------------------------------------------------------------------------------------------------------------------------------------------------------------------------------------|
| <b>Step 1</b> | enable<br><b>Example:</b><br>Router> <b>enable</b>                                                                                                             | Enables the privileged EXEC mode.<br><br>Enter your password, if prompted.                                                                                                                      |
| <b>Step 2</b> | debug udd {events   packets   registries}<br><b>Example:</b><br>no debug udd {events   packets   registries}<br><b>Example:</b><br>Router#<br>debug udd events | Enables the debugging of UDLD process events, packets, or registry events.<br><br>Use the no form of this command to disable the debugging of UDLD process events, packets, or registry events. |

# Configuration Examples for UDLD Protocol

The section provides the following configuration examples:

[Example: Verifying a UDLD Configuration, on page 381](#)

[Example: Verifying Information About Neighbors, on page 381](#)

[Example: Displaying all the UDLD Interface Statuses, on page 381](#)

## Example: Verifying a UDLD Configuration

The following example shows how to use the show command to verify an UDLD configuration:

### Sample Output for the show udld interface-id Command

```
Router# show udld gigabitethernet2/2
Interface Gi2/2

Port enable administrative configuration setting: Follows device default
Port enable operational state: Enabled
Current bidirectional state: Bidirectional
Current operational state: Advertisement
Message interval: 60
Time out interval: 5
No multiple neighbors detected

Entry 1

Expiration time: 146
Device ID: 1
Current neighbor state: Bidirectional
Device name: 0050e2826000
Port ID: 2/1
Neighbor echo 1 device: SAD03160954
Neighbor echo 1 port: Gi1/1
Message interval: 5
CDP Device name: 066527791
```

## Example: Verifying Information About Neighbors

The following example shows how to view the information pertaining to neighbors:

### Sample Output for the show udld neighbors Command

```
Router# show udld neighbors
Port Device Name Device ID Port-ID OperState

Gi3/1 SAL0734K5R2 1 Gi4/1 Bidirectional
Gi4/1 SAL0734K5R2 1 Gi3/1 Bidirectional
```

## Example: Displaying all the UDLD Interface Statuses

The following example shows how to display all the UDLD interface statuses:

### Sample Output for the show udld Command

```

Router# show udld
Interface Gi0/0/0

Port enable administrative configuration setting: Follows device default
Port enable operational state: Disabled
Current bidirectional state: Unknown
Interface Gi0/0/1

Port enable administrative configuration setting: Follows device default
Port enable operational state: Disabled
Current bidirectional state: Unknown
Interface Fa0/1/0

Port enable administrative configuration setting: Disabled
Port enable operational state: Disabled
Current bidirectional state: Unknown
Interface Fa0/1/1

Port enable administrative configuration setting: Disabled
Port enable operational state: Disabled
.
.
.

```

## Additional References

The following sections provide references related to the UniDirectional Link Detection (UDLD) protocol on the Cisco ASR 1000 Series Aggregation Services Routers.

### Related Documents

| Related Topic                        | Document Title                                                         |
|--------------------------------------|------------------------------------------------------------------------|
| Cisco IOS Configuration Fundamentals | <a href="#">Cisco IOS Configuration Fundamentals Command Reference</a> |

### Standards

| Standard                                                    | Title |
|-------------------------------------------------------------|-------|
| No new or modified standards are supported by this feature. | —     |

### MIBs

| MIB  | MIBs Link                                                                                                                                                                                                                      |
|------|--------------------------------------------------------------------------------------------------------------------------------------------------------------------------------------------------------------------------------|
| None | To locate and download MIBs for selected platforms, Cisco IOS releases, and feature sets, use the Cisco MIB Locator found at the following URL:<br><br><a href="http://www.cisco.com/go/mibs">http://www.cisco.com/go/mibs</a> |

**RFCs**

| RFC <sup>16</sup> | Title                                                       |
|-------------------|-------------------------------------------------------------|
| RFC 5171          | Cisco Systems UniDirectional Link Detection (UDLD) Protocol |

<sup>16</sup> Not all the supported RFCs are listed.

**Technical Assistance**

| Description                                                                                                                                                                                                                                                                                                                                                                                                                                                                                                                                                             | Link                                                                                                                     |
|-------------------------------------------------------------------------------------------------------------------------------------------------------------------------------------------------------------------------------------------------------------------------------------------------------------------------------------------------------------------------------------------------------------------------------------------------------------------------------------------------------------------------------------------------------------------------|--------------------------------------------------------------------------------------------------------------------------|
| <p>The Cisco Support website provides extensive online resources, including documentation and tools for troubleshooting and resolving technical issues with Cisco products and technologies.</p> <p>To receive security and technical information about your products, you can subscribe to various services, such as the Product Alert Tool (accessed from Field Notices), the Cisco Technical Services Newsletter, and Really Simple Syndication (RSS) Feeds.</p> <p>Access to most tools on the Cisco Support website requires a Cisco.com user ID and password.</p> | <p><a href="http://www.cisco.com/cisco/web/support/index.html">http://www.cisco.com/cisco/web/support/index.html</a></p> |

## Feature Information for Configuring UDLD on Cisco ASR 1000 Series Aggregation Services Routers

The following table lists the features in this module and provides links to specific configuration information. Only features that were introduced or modified in Cisco IOS Release 3.9S or later appear in the table.

Not all commands may be available in your Cisco IOS software release. For release information about a specific command, see the corresponding command reference documentation.

Use the Cisco Feature Navigator to find information about platform support and software image support. The Cisco Feature Navigator enables you to determine which Cisco IOS and Cisco Catalyst operating system software images support a specific software release, feature set, or platform. To access the Cisco Feature Navigator, go to <http://www.cisco.com/go/cfn>. An account on Cisco.com is not required.

Table 30: Feature Information for Configuring UDLD on Cisco ASR 1000 Series Aggregation Services Routers

| Feature Name                                  | Releases | Feature Information                                                                                                                                                                                                                                                                                                                                                                                                                                                                                                                                                                                                                                                           |
|-----------------------------------------------|----------|-------------------------------------------------------------------------------------------------------------------------------------------------------------------------------------------------------------------------------------------------------------------------------------------------------------------------------------------------------------------------------------------------------------------------------------------------------------------------------------------------------------------------------------------------------------------------------------------------------------------------------------------------------------------------------|
| UniDirectional Link Detection (UDLD) protocol | 3.9S     | <p>The Cisco-proprietary UDLD protocol allows devices connected through fiber-optic or copper (for example, Category 5 cabling) Ethernet cables connected to LAN ports to monitor the physical configuration of the cables and detect when a unidirectional link exists. When a unidirectional link is detected, UDLD shuts down the affected LAN port and alerts users. Unidirectional links can cause a variety of problems, including spanning tree topology loops.</p> <p>In Cisco IOS XE Release 3.9S, this feature was implemented on the Cisco ASR 1000 Series Aggregation Services Routers.</p> <p>The following sections provide information about this feature:</p> |



## CHAPTER 15

# Using the Management Ethernet Interface

The Cisco ASR 1000 Series Routers have one Gigabit Ethernet Management Ethernet interface on each Route Processor.

- [Finding Feature Information in This Module, on page 385](#)
- [Contents, on page 385](#)
- [Gigabit Ethernet Management Interface Overview, on page 385](#)
- [Gigabit Ethernet Port Numbering, on page 386](#)
- [IP Address Handling in ROMmon and the Management Ethernet Port, on page 386](#)
- [Gigabit Ethernet Management Interface VRF, on page 387](#)
- [Common Ethernet Management Tasks, on page 387](#)
- [Additional References, on page 391](#)
- [Feature Information for Using the Management Ethernet Interface, on page 392](#)

## Finding Feature Information in This Module

Your software release might not support all the features documented in this module. For the latest feature information and caveats, see the release notes for your platform and software release. To find information about the features documented in this module, and to see a list of the releases in which each feature is supported, see the [Feature Information for Using the Management Ethernet Interface, on page 392](#).

Use Cisco Feature Navigator to find information about platform support and Cisco software image support. To access Cisco Feature Navigator, go to <http://www.cisco.com/go/cfn>. An account on Cisco.com is not required.

## Contents

This guide covers the following topics:

## Gigabit Ethernet Management Interface Overview

The purpose of this interface is to allow users to perform management tasks on the router; it is basically an interface that should not and often cannot forward network traffic but can otherwise access the router, often

via Telnet and SSH, and perform most management tasks on the router. The interface is most useful before a router has begun routing, or in troubleshooting scenarios when the SPA interfaces are inactive.

The following aspects of the Management Ethernet interface should be noted:

- Each RP has a Management Ethernet interface, but only the active RP has an accessible Management Ethernet interface (the standby RP can be accessed using the console port, however).
- IPv4, IPv6, and ARP are the only routed protocols supported for the interface.
- The interface provides a method of access to the router even if the SPA interfaces or the IOS processes are down.
- The Ethernet Management Interface cannot be used as a Lawful Intercept MD source interface.
- The Management Ethernet interface is part of its own VRF. This is discussed in more detail in the [Gigabit Ethernet Management Interface VRF, on page 387](#).



---

**Note** Several Cisco platforms, NIMs, and SM cards support configuring multiple-rate SFPs on same interface, e.g., 1G SFP or 10G SFP+ on a 10G port.

In a port-channel bundle, all member interfaces should be of same speed, and duplex. It is recommended to use duplex interfaces of the same speed as member interfaces for configuring a port-channel.

For more information about interfaces that support multiple-rate SFPs, see the corresponding datasheets.

---

## Gigabit Ethernet Port Numbering

The Gigabit Ethernet Management port is always GigabitEthernet0.

In a dual RP configuration, the Management Ethernet interface on the active RP will always be Gigabit Ethernet 0, while the Management Ethernet interface on the standby RP will not be accessible using the Cisco IOS CLI in the same telnet session. The standby RP can be telnetted to through the console port, however.

The port can be accessed in configuration mode like any other port on the Cisco ASR 1000 Series Routers:

```
Router#config t
Enter configuration commands, one per line. End with CNTL/Z.
Router (config)#interface gigabitethernet0
Router (config-if)#
```

## IP Address Handling in ROMmon and the Management Ethernet Port

On the Cisco ASR 1000 Series Routers, IP addresses can be configured in ROMmon (the **IP\_ADDRESS=** and **IP\_SUBNET\_MASK=** commands) and through the use of the IOS command-line interface (the **ip address** command in interface configuration mode).

Assuming the IOS process has not begun running on the Cisco ASR 1000 Series Router, the IP address that was set in ROMmon acts as the IP address of the Management Ethernet interface. In cases where the IOS



process is running and has taken control of the Management Ethernet interface, the IP address specified when configuring the Gigabit Ethernet 0 interface in the IOS CLI becomes the IP address of the Management Ethernet interface. The ROMmon-defined IP address is only used as the interface address when the IOS process is inactive.

For this reason, the IP addresses specified in ROMmon and in the IOS CLI can be identical and the Management Ethernet interface will function properly in single RP configurations.

In dual RP configurations, however, users should never configure the IP address in the ROMmon on either RP0 or RP1 to match each other or the IP address as defined by the IOS CLI. Configuring matching IP addresses introduces the possibility for an active and standby Management Ethernet interface having the same IP address with different MAC addresses, which will lead to unpredictable traffic treatment.

## Gigabit Ethernet Management Interface VRF

The Gigabit Ethernet Management interface is automatically part of its own VRF. This VRF, which is named “Mgmt-intf,” is automatically configured on the Cisco ASR 1000 Series Router and is dedicated to the Management Ethernet interface; no other interfaces can join this VRF. Therefore, this VRF does not participate in the MPLS VPN VRF or any other network-wide VRF. The Mgmt-intf VRF supports loopback interface.

Placing the management ethernet interface in its own VRF has the following effects on the Management Ethernet interface:

- Many features must be configured or used inside the VRF, so the CLI may be different for certain Management Ethernet functions on the Cisco ASR 1000 Series Routers than on Management Ethernet interfaces on other routers.
- Prevents transit traffic from traversing the router. Because all of the SPA interfaces and the Management Ethernet interface are automatically in different VRFs, no transit traffic can enter the Management Ethernet interface and leave a SPA interface, or vice versa.
- Improved security of the interface. Because the Mgmt-intf VRF has its own routing table as a result of being in its own VRF, routes can only be added to the routing table of the Management Ethernet interface if explicitly entered by a user.

The Management Ethernet interface VRF supports both IPv4 and IPv6 address families.

## Common Ethernet Management Tasks

Because users can perform most tasks on a router through the Management Ethernet interface, many tasks can be done by accessing the router through the Management Ethernet interface.

This section documents tasks that might be common or slightly tricky on the Cisco ASR 1000 Series Routers. It is not intended as a comprehensive list of all tasks that can be done using the Management Ethernet interface.

This section covers the following processes:

### Viewing the VRF Configuration

The VRF configuration for the Management Ethernet interface is viewable using the **show running-config vrf** command.

This example shows the default VRF configuration:

```
Router# show running-config vrf
Building configuration...
Current configuration : 351 bytes
vrf definition Mgmt-intf
!
 address-family ipv4
 exit-address-family
!
 address-family ipv6
 exit-address-family
!
(some output removed for brevity)
```

## Viewing Detailed VRF Information for the Management Ethernet VRF

To see detailed information about the Management Ethernet VRF, enter the **show vrf detail Mgmt-intf** command:

```
Router# show vrf detail Mgmt-intf
VRF Mgmt-intf (VRF Id = 4085); default RD <not set>; default VPNID <not set>
 Interfaces:
 Gi0
 Address family ipv4 (Table ID = 4085 (0xFF5)):
 No Export VPN route-target communities
 No Import VPN route-target communities
 No import route-map
 No export route-map
 VRF label distribution protocol: not configured
 VRF label allocation mode: per-prefix
 Address family ipv6 (Table ID = 503316481 (0x1E000001)):
 No Export VPN route-target communities
 No Import VPN route-target communities
 No import route-map
 No export route-map
 VRF label distribution protocol: not configured
 VRF label allocation mode: per-prefix
```

## Setting a Default Route in the Management Ethernet Interface VRF

To set a default route in the Management Ethernet Interface VRF, enter the following command

```
ip route vrf Mgmt-intf 0.0.0.0 0.0.0.0 next-hop-IP-address
```

## Setting the Management Ethernet IP Address

The IP address of the Management Ethernet port is set like the IP address on any other interface.

Below are two simple examples of configuring an IPv4 address and an IPv6 address on the Management Ethernet interface.

### IPv4 Example

```
Router(config)# interface GigabitEthernet 0
Router(config-if)# ip address
A.B.C.D A.B.C.D
```

### IPv6 Example

```
Router(config)# interface GigabitEthernet 0
Router(config-if)# ipv6 address X:X:X:X::X
```

## Telnetting over the Management Ethernet Interface

Telnetting can be done through the VRF using the Management Ethernet interface.

In the following example, the router telnets to 198.51.100.1 through the Management Ethernet interface VRF:

```
Router# telnet 198.51.100.1 /vrf Mgmt-intf
```

## Pinging over the Management Ethernet Interface

Pinging other interfaces using the Management Ethernet interface is done through the VRF.

In the following example, the router pings the interface with the IP address of 198.51.100.1 through the Management Ethernet interface:

```
Router# ping vrf Mgmt-intf 198.51.100.1

Type escape sequence to abort.
Sending 5, 100-byte ICMP Echos to 198.51.100.1, timeout is 2 seconds:
.!!!!
Success rate is 80 percent (4/5), round-trip min/avg/max = 1/1/1 ms
```

## Copy Using TFTP or FTP

To copy a file using TFTP through the Management Ethernet interface, the **ip tftp source-interface GigabitEthernet 0** command must be entered before entering the **copy tftp** command because the **copy tftp** command has no option of specifying a VRF name.

Similarly, to copy a file using FTP through the Management Ethernet interface, the **ip ftp source-interface GigabitEthernet 0** command must be entered before entering the **copy ftp** command because the **copy ftp** command has no option of specifying a VRF name.

### TFTP Example

```
Router(config)# ip tftp source-interface gigabitethernet 0
```

### FTP Example

```
Router(config)# ip ftp source-interface gigabitethernet 0
```

## NTP Server

To allow the software clock to be synchronized by a Network Time Protocol (NTP) time server over the Management Ethernet interface, enter the **ntp server vrf Mgmt-intf** command and specify the IP address of the device providing the update.

The following CLI provides an example of this procedure.

```
Router(config)# ntp server vrf Mgmt-intf 198.51.100.1
```

## SYSLOG Server

To specify the Management Ethernet interface as the source IP or IPv6 address for logging purposes, enter the **logging host <ip-address> vrf Mgmt-intf** command.

The following CLI provides an example of this procedure.

```
Router(config)# logging host <ip-address> vrf Mgmt-intf
```

From the Cisco IOS XE Release 17.7.1a, the syslog feature captures the LINK down reason from Cisco ASR 1000 Series ASIC MAC, PHY, and optics device blocks. This feature is supported on all the Cisco ASR 1000 series platforms that has built-in or pluggable 1G, 10G, 40G, or 100G EPAs.

## SNMP-Related Services

To specify the Management Ethernet interface as the source of all SNMP trap messages, enter the **snmp-server source-interface traps gigabitEthernet 0** command.

The following CLI provides an example of this procedure:

```
Router(config)# snmp-server source-interface traps gigabitEthernet 0
```

## Domain Name Assignment

The IP domain name assignment for the Management Ethernet interface is done through the VRF.

To define the default domain name as the Management Ethernet VRF interface, enter the **ip domain-name vrf Mgmt-intf domain** command.

```
Router(config)# ip domain-name vrf Mgmt-intf cisco.com
```

## DNS service

To specify the Management Ethernet interface VRF as a name server, enter the **ip name-server vrf Mgmt-intf IPv4-or-IPv6-address** command.

```
Router(config)# ip name-server vrf Mgmt-intf
IPv4-or-IPv6-address
```

## RADIUS or TACACS+ Server

To group the Management VRF as part of a AAA server group, enter the **ip vrf forward Mgmt-intf** command when configuring the AAA server group.

The same concept is true for configuring a TACACS+ server group. To group the Management VRF as part of a TACACS+ server group, enter the **ip vrf forwarding Mgmt-intf** command when configuring the TACACS+ server group.

### RADIUS Server Group Configuration

```
Router(config)# aaa group server radius hello
Router(config-sg-radius)# ip vrf forwarding Mgmt-intf
```

### TACACS+ Server Group Example

```
outer(config)# aaa group server tacacs+ hello
Router(config-sg-tacacs+)# ip vrf forwarding Mgmt-intf
```

## VTY lines with ACL

To ensure an access control list (ACL) is attached to vty lines that are and are not using VRF, use the **vrf-also** option when attaching the ACL to the vty lines.

```
Router(config)# line vty 0 4
Router(config-line)# access-class 90 in vrf-also
```

## Additional References

### Standards

| Standard | Title |
|----------|-------|
| None     | —     |

### MIBs

| MIB  | MIBs Link                                                                                                                                                                                                     |
|------|---------------------------------------------------------------------------------------------------------------------------------------------------------------------------------------------------------------|
| None | To locate and download MIBs for selected platforms, Cisco IOS releases, and feature sets, use Cisco MIB Locator found at this URL:<br><a href="http://www.cisco.com/go/mibs">http://www.cisco.com/go/mibs</a> |

### RFCs

| RFC  | Title |
|------|-------|
| None | —     |

**Technical Assistance**

| Description                                                                                                                                                                                                                                                                                                                                                                           | Link                                                                                                              |
|---------------------------------------------------------------------------------------------------------------------------------------------------------------------------------------------------------------------------------------------------------------------------------------------------------------------------------------------------------------------------------------|-------------------------------------------------------------------------------------------------------------------|
| The Cisco Support and Documentation website provides online resources to download documentation, software, and tools. Use these resources to install and configure the software and to troubleshoot and resolve technical issues with Cisco products and technologies. Access to most tools on the Cisco Support and Documentation website requires a Cisco.com user ID and password. | <a href="http://www.cisco.com/cisco/web/support/index.html">http://www.cisco.com/cisco/web/support/index.html</a> |

## Feature Information for Using the Management Ethernet Interface

Table 31: Feature Information for Using the Management Ethernet Interface , on page 392 lists the features in this module and provides links to specific configuration information.

Use Cisco Feature Navigator to find information about platform support and software image support. Cisco Feature Navigator enables you to determine which software images support a specific software release, feature set, or platform. To access Cisco Feature Navigator, go to <http://www.cisco.com/go/cfn> . An account on Cisco.com is not required.



**Note** Table 31: Feature Information for Using the Management Ethernet Interface , on page 392 lists only the software release that introduced support for a given feature in a given software release train. Unless noted otherwise, subsequent releases of that software release train also support that feature.

**Table 31: Feature Information for Using the Management Ethernet Interface**

| Feature Name                            | Releases          | Feature Information          |
|-----------------------------------------|-------------------|------------------------------|
| Using the Management Ethernet Interface | Cisco IOS XE 2.1S | This feature was introduced. |



## CHAPTER 16

# Network Synchronization Support

---

Most of the services that are provided over networks must be fully synchronized with one another in order to operate efficiently. If the network devices that constitute a network do not operate at the same clock rates, there is an overall decrease in the performance of the network and a consequent degradation in the quality of the services offered by the network. This document explains how to configure network synchronization on the Cisco ASR 1000 Series Aggregation Services Routers.

- [Finding Feature Information, on page 393](#)
- [Contents, on page 393](#)
- [Prerequisites for Network Synchronization Support, on page 394](#)
- [Network Synchronization Overview, on page 394](#)
- [Synchronization Status Message and Ethernet Synchronization Messaging Channel, on page 398](#)
- [Restrictions for Network Synchronization, on page 399](#)
- [Configuring Network Synchronization, on page 400](#)
- [Additional References, on page 416](#)
- [Feature Information for Network Synchronization Support, on page 417](#)

## Finding Feature Information

Your software release might not support all the features documented in this module. For the latest feature information and caveats, see the release notes for your platform and software release. To find information about the features documented in this module, and to see a list of the releases in which each feature is supported, see the [Feature Information for Network Synchronization Support, on page 417](#).

Use Cisco Feature Navigator to find information about platform support and Cisco software image support. To access Cisco Feature Navigator, go to <http://www.cisco.com/go/cfn>. An account on Cisco.com is not required.

## Contents

This guide covers the following topics:

## Prerequisites for Network Synchronization Support

The following goals must be taken into account while designing the synchronization plan for a network:

- Synchronize the greatest number of network elements to the smallest number of independent clock sources. Ideally, all the network elements should be synchronized to a single clock source.
- Use clock sources of the highest quality (in terms of stability and long-term accuracy).
- To ensure resiliency of synchronization, plan for possible failure of the clock sources, network elements, and network trunks.

## Network Synchronization Overview

Synchronous Ethernet (SyncE), which is defined by the Telecommunication Standardization Sector (ITU-T) standards, such as G.8261 and G.8262, leverages the PHY layer of the Ethernet to transmit clock information to remote sites.

SyncE provides a cost-effective alternative to the Synchronous Optical Networking (SONET) networks. For SyncE to work, each network element along the synchronization path must support SyncE. To implement SyncE, the bit clock of the Ethernet is aligned to a reliable clock that is traceable to the Primary Reference Clock (PRC).

The following EPAs and line cards support Synchronous Ethernet:

**Table 32: Synchronous Ethernet Support for EPA and Line cards**

| EPA                                     | Line cards        |
|-----------------------------------------|-------------------|
| EPA-10X10GE                             | ASR1000-6TE       |
| EPA-18X1GE                              | ASR1000-2T+20X1GE |
| EPA-40X2GE                              |                   |
| EPA-100X1GE                             |                   |
| Built-in EPAs on ASR1001-HX, ASR1002-HX |                   |



**Note** The 2-Port Gigabit Synchronous Ethernet SPA (SPA-2X1GE-SYNCE) is not supported on ASR 1002-x chassis.

## Features Supported on ASR 1000 Platforms

| Platform Support | Features Supported                                                                            | Features Not Supported |
|------------------|-----------------------------------------------------------------------------------------------|------------------------|
| ASR 1001-X       | Synchronous Ethernet Feature is supported with Built-in Gigabit and 10-Gigabit Ethernet Ports | NetClk Feature         |



| Platform Support | Features Supported                                                              | Features Not Supported                     |
|------------------|---------------------------------------------------------------------------------|--------------------------------------------|
| ASR1002-X        | Synchronous Ethernet Feature is supported with Built-in Gigabit Ethernet Ports. | NetClk Feature                             |
| ASR1001          | —                                                                               | NetClk and Network Synchronization Feature |



**Note** Network-Clocking feature is not supported with SFP-GE-T on any of the ASR1000 platforms.

Cisco ASR 1000 Series Aggregation Services Routers have a dedicated external interface known as BITS interface to recover clocking information from a Synchronization Supply Unit (SSU). They use this clock for SyncE. The BITS interface supports E1 (European SSUs) and T1 (American BITS) framing.



**Note** The Cisco ASR 1001-X Router does not have an on-board BITS port, hence it does not support those features that use BITS ports.

The below table lists the framing modes for a BITS port on the Cisco ASR 1002-X Router.

**Table 33: Framing Modes for a BITS or SSU Port on the Cisco ASR 1002-X Router**

| BITS or SSU Port Support Matrix | Framing Modes Supported | SSM or QL Support | Tx Port | Rx Port |
|---------------------------------|-------------------------|-------------------|---------|---------|
| T1                              | T1 ESF                  | Yes               | Yes     | Yes     |
| T1                              | T1 SF                   | Yes               | Yes     | Yes     |
| T1                              | T1 D4                   | Yes               | Yes     | Yes     |
| E1                              | E1 CRC4                 | Yes               | Yes     | Yes     |
| E1                              | E1 FAS                  | Yes               | Yes     | Yes     |
| E1                              | E1 CAS                  | Yes               | Yes     | Yes     |
| E1                              | E1 CAS CRC4             | Yes               | Yes     | Yes     |
| 2048 kHz                        | 2048 kHz                | Yes               | Yes     | Yes     |

The below table lists the framing modes for a BITS port on the other Cisco ASR 1000 Series Aggregation Services Routers.

**Table 34: Framing Modes for a BITS or SSU Port on the Other Cisco ASR 1000 Series Aggregation Services Routers**

| BITS or SSU Port Support Matrix | Framing Modes Supported | SSM or QL Support | Tx Port | Rx Port |
|---------------------------------|-------------------------|-------------------|---------|---------|
| T1                              | T1 ESF                  | No                | No      | Yes     |

| <b>BITS or SSU Port Support Matrix</b> | <b>Framing Modes Supported</b> | <b>SSM or QL Support</b> | <b>Tx Port</b> | <b>Rx Port</b> |
|----------------------------------------|--------------------------------|--------------------------|----------------|----------------|
| T1                                     | T1 SF                          | No                       | No             | Yes            |
| E1                                     | E1 CRC4                        | No                       | No             | Yes            |
| E1                                     | E1 FAS                         | No                       | No             | Yes            |
| E1                                     | E1 CAS                         | No                       | No             | Yes            |
| E1                                     | E1 CAS CRC4                    | No                       | No             | Yes            |
| 2048 kHz                               | 2048 kHz                       | No                       | No             | Yes            |

You can configure network synchronization on the Cisco ASR 1000 Series Aggregation Services Routers by using one of the following features:

- Clock Recovery from SyncE

When this feature is configured, the system clock is recovered from the SyncE clocking source (SyncE-enabled interfaces only). The router uses this clock as the Tx clock for other supported Shared Port Adapters (SPAs).

- Clock Recovery from an External Interface

When this feature is enabled, the system clock is recovered from a BITS clock source.

- Clock Recovery from a GPS (10M) Source



---

**Note** This feature is supported only on the Cisco ASR 1002-X Router.

---

When this feature is enabled, the system clock is recovered from a GPS (10M) clock source.

- Line to External



---

**Note** This feature is not supported on the Cisco ASR 1002-X Router.

---

When this feature is enabled, the clock received from an Ethernet is forwarded to an external SSU. The SyncE feature provides the clock cleanup functionality. When a router is in the middle of a synchronization chain, the received clock may experience unacceptable wander and jitter. The router recovers the clock from the SyncE interface, converts it to the format required for the BITS interface, and sends it to an SSU through the BITS port. The SSU then performs a cleanup and sends it back to the BITS interface. The cleaned up clock is received from the SSU and is used as the Tx clock for the SyncE ports. In the context of the Cisco ASR 1000 Series Aggregation Services Routers, the interface from which the clock is recovered and the BITS port to the SSU must reside on the same card.

- System to External: The system clock is used as the Tx clock for an external interface. By default, the system clock is not transmitted through the external interface.
- A SyncE-enabled Cisco ASR 1000 Series Router provides the Squelching feature. In this feature, an alarm indication signal (AIS) is sent to the Tx interfaces if the clock source goes down. When the Line to External feature is configured, if the line source goes down at any point of time, an AIS is transmitted

through the external interface to the SSU. System to External: If the router loses all the clock sources, an AIS is sent through the external interface to the SSU.

Snquelching can be performed only on external devices, such as SSUs and PRCs.

You can have a maximum of eight clock sources configured on a Cisco ASR 1000 Series Router. On a router that supports the Network Synchronization feature, you can configure selection of the clock source on the basis of the quality of the clock source. With this feature configured, the clock source that offers the best quality is made the default clock source. If the highest level of quality is offered by more than one clock source, the clock source with the highest priority is made the default clock source. You can also manage synchronization by using the following management options:

- **Hold-Off Time:** If a clock source goes down, the router waits for a specific hold-off time before removing the clock source from the clock selection process. By default, the value of hold-off time is 300 milliseconds (ms).
- **Wait to Restore:** If a SyncE interface comes up, the router waits for a specific period of time before considering the SyncE interface for synchronization source. By default, the value is 300 seconds.
- **Force Switch:** Forcefully selects a synchronization source irrespective of whether the source is available or within the specified range.
- **Manual Switch:** Manually select a synchronization source, provided the clock source has a higher quality level than the currently active clock.

The following table lists the SPAs that support network synchronization.

**Table 35: SPAs supporting Network Synchronization**

| SPA Type                   | SPA Name                                                                                                                           |
|----------------------------|------------------------------------------------------------------------------------------------------------------------------------|
| ASR 1001-X Built-in SPA    | BUILT-IN-2T+6X1GE                                                                                                                  |
| ASR1002-X Built-in SPA     | 6XGE-BUILT-IN                                                                                                                      |
| Synchronous Ethernet       | SPA-2XGE-SYNCE                                                                                                                     |
| Serial and Channelized SPA | SPA-1XCHSTM1/OC3                                                                                                                   |
|                            | SPA-1XCHOC12/DS0                                                                                                                   |
|                            | SPA-8XCHT1/E1-V2 (Supported on the Cisco ASR 1002-X Router and the Cisco ASR1001-X Router, from Cisco IOS XE Release 3.11 onwards) |
| CEOP                       | SPA-1CHOC3-CE-ATM                                                                                                                  |
|                            | SPA-24CHT1-CE-ATM                                                                                                                  |
| ATM                        | SPA-1XOC3-ATM-V2                                                                                                                   |
|                            | SPA-3XOC3-ATM-V2                                                                                                                   |
|                            | SPA-1XOC12-ATM-V2                                                                                                                  |
|                            | SPA-2CHT3-CE-ATM                                                                                                                   |
| POS                        | SPA-2XOC3-POS                                                                                                                      |
|                            | SPA-4XOC3-POS                                                                                                                      |
|                            | SPA-4XOC3-POS-V2                                                                                                                   |

| SPA Type | SPA Name           |
|----------|--------------------|
|          | SPA-8XOC3-POS      |
|          | SPA-1XOC12-POS     |
|          | SPA-1XOC12-POS     |
|          | SPA-4XOC12-POS     |
|          | SPA-8XOC12-POS     |
|          | SPA-1XOC48-POS/RPR |
|          | SPA-2XOC48POS/RPR  |
|          | SPA-4XOC48POS/RPR  |
|          | SPA-OC192POS-XFP   |



**Note** For more information on SPA support matrix see, [http://www.cisco.com/en/US/docs/interfaces\\_modules/shared\\_port\\_adapters/configuration/ASR1000/ASRspasw.html](http://www.cisco.com/en/US/docs/interfaces_modules/shared_port_adapters/configuration/ASR1000/ASRspasw.html)



**Note** Netsync feature on SPA-2XGE-SYNCE is not supported on the Cisco ASR 1001-X Router.

## Synchronization Status Message and Ethernet Synchronization Messaging Channel

Network clocking uses the following mechanisms to exchange the quality level of the clock between the network elements:

### Synchronization Status Message

Network elements use Synchronization Status Messages (SSM) to inform the neighboring elements about the Quality Level (QL) of the clock. Non-Ethernet interfaces, such as optical interfaces and T1 or E1 SPA frames, use SSM. The key benefits of SSMs are:

- Prevents timing loops. Provides fast recovery when a part of the network fails.
- Ensures that a node gets timing from the most reliable clock source.

### Ethernet Synchronization Messaging Channel

In order to maintain a logical communication channel in synchronous network connections, Ethernet relies on a channel called the Ethernet Synchronization Messaging Channel (ESMC), which is based on the IEEE 802.3 Organization-Specific Slow Protocol (OSSP) standards. ESMC relays the SSM code that represents the quality level of the Ethernet Equipment Clock (EEC) in a physical layer.

The ESMC packets are received only for the ports configured as clock sources, and transmitted on all the SyncE interfaces in the system. These packets are then processed by the clock selection algorithm on route processors (RP) and are used to select the best clock. The Tx frame is generated based on the QL value of the selected clock source, and sent to all the enabled SyncE ports.

## Clock Selection Algorithm

The clock selection algorithm selects the best available synchronization source from the nominated sources. This algorithm exhibits nonrevertive behavior among the clock sources with the same QL value, and always selects the signal with the best QL value. For clock option 1, the default is revertive, and for clock option 2, the default is nonrevertive.

The clock selection process works in the following modes:

When multiple selection processes are present in a network element, all the processes work in the same mode.

### QL-Enabled Mode

In QL-enabled mode, the following parameters contribute to the selection process:

- Quality level
- Signal fail via QL-FAILED
- Priority
- External commands.

If no external commands are active, the algorithm selects the reference (for clock selection) with the highest QL that does not experience a signal fail condition. If multiple inputs have the same highest QL, the input with the highest priority is selected. For multiple inputs having the same highest priority and QL, the existing reference is maintained (if it belongs to the highest priority and QL group). Otherwise, an arbitrary reference from the highest priority and QL group is selected.

### QL-Disabled Mode

In QL-disabled mode, the following parameters contribute to the selection process:

- Signal failure
- Priority
- External commands

If no external commands are active, the algorithm selects the reference (for clock selection) with the highest priority that does not experience a signal fail condition. For multiple inputs having the same highest priority, the existing reference is maintained (if it belongs to highest priority group). Otherwise, an arbitrary reference from highest priority group is selected.

**product="name=">Hybrid Mode**

## Restrictions for Network Synchronization

This section lists the restrictions for configuring network synchronization on a router.

- If the network clock algorithm is enabled, use the system clock as the Tx clock (synchronous mode) for the Ethernet interfaces of the corresponding router. You cannot change the synchronous mode on a per-interface basis.
- You can configure up to eight ports as clock sources on a router.

- The SyncE feature coexists with SSO, but is not SSO-compliant. The clock selection algorithm is restarted on a switchover. During switchover, the router goes into holdover mode.
- The SyncE interfaces in the WAN mode cannot be used for QL-enabled clock selection. You must either use them with the system in QL-disabled mode, or disable the ESMC on the interfaces, and use them as QL-disabled interfaces.
- We recommend that you do not configure multiple input sources with the same priority because this impacts the TSM (switching message delay).
- You cannot implement the network clock-based clock selection algorithm and the new algorithm simultaneously. Both these are mutually exclusive.
- The Line to External feature for clock cleanup is supported only if the line interface and the external interface are on the same metronome SPA.



**Note** The Line to External feature is not supported on the Cisco ASR 1002-X Router.

## Configuring Network Synchronization

You can configure network synchronization on the Cisco ASR 1000 Series Aggregation Services Routers by performing one of the following procedures:

### Configuring Clock Recovery from SyncE

This section describes how to configure clock recovery by using the SyncE method.

#### SUMMARY STEPS

1. **configure terminal**
2. **network-clock synchronization automatic**
3. **network-clock synchronization ssm option {1 | 2 {GEN1 | GEN2}}**
4. **interface gigabitethernet slot/card/port**
5. **synchronous mode**
6. **exit**
7. **network-clock input-source priority {interface interface-name slot/card/port | {external slot/card/port}}**
8. **exit**

#### DETAILED STEPS

|               | Command or Action                                                                 | Purpose                                                                                                        |
|---------------|-----------------------------------------------------------------------------------|----------------------------------------------------------------------------------------------------------------|
| <b>Step 1</b> | <b>configure terminal</b><br><b>Example:</b><br>Router# <b>configure terminal</b> | Enters the global configuration mode.                                                                          |
| <b>Step 2</b> | <b>network-clock synchronization automatic</b><br><b>Example:</b>                 | Enables the network clock selection algorithm. This command disables the Cisco-specific network clock process, |

|               | Command or Action                                                                                                                                                                                                                                                                                                                                              | Purpose                                                                                                                                                                                                                                              |
|---------------|----------------------------------------------------------------------------------------------------------------------------------------------------------------------------------------------------------------------------------------------------------------------------------------------------------------------------------------------------------------|------------------------------------------------------------------------------------------------------------------------------------------------------------------------------------------------------------------------------------------------------|
|               | <pre>Router(config)# network-clock synchronization automatic</pre>                                                                                                                                                                                                                                                                                             | and turns on the G.781-based automatic clock selection process.                                                                                                                                                                                      |
| <b>Step 3</b> | <p><b>network-clock synchronization ssm option {1   2 {GEN1   GEN2}}</b></p> <p><b>Example:</b></p> <pre>Router(config)# network-clock synchronization ssm option 2 GEN1</pre>                                                                                                                                                                                 | Configures the equipment to work in a synchronization network. The option_id value 1 refers to a synchronization network design for Europe. This is the default value. The option_id value 2 refers to a synchronization network design for the U.S. |
| <b>Step 4</b> | <p><b>interface gigabitethernet slot/card/port</b></p> <p><b>Example:</b></p> <pre>Router(config)# interface gigabitethernet 0/2/0</pre>                                                                                                                                                                                                                       | Specifies the Gigabit Ethernet interface to be configured: slot/card/port—Specifies the location of the interface.                                                                                                                                   |
| <b>Step 5</b> | <p><b>synchronous mode</b></p> <p><b>Example:</b></p> <pre>Router(config-if)# synchronous mode</pre>                                                                                                                                                                                                                                                           | Sets the mode to synchronous mode.                                                                                                                                                                                                                   |
| <b>Step 6</b> | <p><b>exit</b></p> <p><b>Example:</b></p> <p><b>Example:</b></p> <pre>Router(config)# exit</pre>                                                                                                                                                                                                                                                               | Exits the global configuration mode.                                                                                                                                                                                                                 |
| <b>Step 7</b> | <p><b>network-clock input-source priority {interface interface-name slot/card/port   {external slot/card/port}}</b></p> <p><b>Example:</b></p> <p><b>Example:</b></p> <pre>Router(config)# network-clock input-source 1 interface gigabitethernet 0/2/0</pre> <p><b>Example:</b></p> <pre>Router(config)# network-clock input-source 1 external R0 2048k</pre> | Enables clock recovery from SyncE.<br>The Cisco ASR1006 router supports two RP ports, one active and the other standby.                                                                                                                              |

|               | Command or Action                                             | Purpose                              |
|---------------|---------------------------------------------------------------|--------------------------------------|
| <b>Step 8</b> | <b>exit</b><br><b>Example:</b><br>Router(config)# <b>exit</b> | Exits the global configuration mode. |

## Examples

The following example shows how to configure clock recovery from SyncE:

```
Router# configure terminal
Router(config)# network-clock synchronization automatic
Router(config)# network-clock synchronization ssm option 2 GEN1
Router(config)# interface gigabitethernet 0/2/0
Router(config-if)# synchronous mode
Router(config)# exit
Router(config)# network-clock input-source 1 interface gigabitethernet 0/2/0
Router(config)# exit
```

## Configuring Clock Recovery from a BITS Port

This section describes how to configure clock recovery from a BITS port. BITS port can be configured either as an input-source or an output-source.

### Configuring Clock Recovery with a BITS Port as an Input-Source

This section describes how to configure clock recovery with a BITS port as an input-source.

#### SUMMARY STEPS

1. **enable**
2. **configure terminal**
3. **network-clock synchronization automatic**
4. **network-clock synchronization ssm option {1 | 2 {GEN1 | GEN2}}**
5. **network-clock input-source priority {external slot/card/port}**
6. **exit**

#### DETAILED STEPS

|               | Command or Action                                         | Purpose                                                               |
|---------------|-----------------------------------------------------------|-----------------------------------------------------------------------|
| <b>Step 1</b> | <b>enable</b><br><b>Example:</b><br>Router# <b>enable</b> | Enables the privileged EXEC mode.<br>Enter your password if prompted. |
| <b>Step 2</b> | <b>configure terminal</b><br><b>Example:</b>              | Enters the global configuration mode.                                 |



|               | Command or Action                                                                                                                                                                                                                                                                                                                                                                | Purpose                                                                                                                                                                                                                                                                                 |
|---------------|----------------------------------------------------------------------------------------------------------------------------------------------------------------------------------------------------------------------------------------------------------------------------------------------------------------------------------------------------------------------------------|-----------------------------------------------------------------------------------------------------------------------------------------------------------------------------------------------------------------------------------------------------------------------------------------|
|               | Router# <b>configure terminal</b>                                                                                                                                                                                                                                                                                                                                                |                                                                                                                                                                                                                                                                                         |
| <b>Step 3</b> | <b>network-clock synchronization automatic</b><br><b>Example:</b><br>Router(config)# <b>network-clock synchronization automatic</b>                                                                                                                                                                                                                                              | Enables the network clock selection algorithm. This command disables the Cisco-specific network clock process, and turns on the G.781-based automatic clock selection process.                                                                                                          |
| <b>Step 4</b> | <b>network-clock synchronization ssm option {1   2 {GEN1   GEN2}}</b><br><b>Example:</b><br>Router(config)# <b>network-clock synchronization ssm option 2 GEN1</b>                                                                                                                                                                                                               | Configures the equipment to work in the synchronization network. The option_id value 1 refers to synchronization network design for Europe. This is the default value. The option_id value 2 refers to the synchronization network design for the U.S.                                  |
| <b>Step 5</b> | <b>network-clock input-source priority {external slot/card/port}</b><br><b>Example:</b><br>Router(config)# <b>network-clock input-source 1 External 0/3/0 t1 esf</b><br><b>Example:</b><br>Router(config)# <b>network-clock input-source 1 External R0 t1 esf</b><br><b>Example:</b><br>Router(config)# <b>network-clock input-source 1 external r0 e1 cas crc4 120 linecode</b> | Enables clock recovery from a BITS port.<br><b>Note</b> Routers with dual hardware support, such as the Cisco ASR 1006 Router, can have two RP ports, wherein one RP is active and the other is standby. Both the active and standby RP BITS ports can be configured as output sources. |
| <b>Step 6</b> | <b>exit</b><br><b>Example:</b><br>Router(config)# <b>exit</b>                                                                                                                                                                                                                                                                                                                    | Exits the global configuration mode.                                                                                                                                                                                                                                                    |

## Examples

The following example shows how to configure clock recovery from a BITS port for a Metronome SPA:

```
Router# configure terminal
Router(config)# network-clock synchronization automatic
Router(config)# network-clock synchronization ssm option 2 GEN1
Router(config)# network-clock input-source 1 external 0/3/0 t1 esf
Router(config)# exit
```

The following example shows how to configure clock recovery from a BITS port for RP BITS on Cisco ASR 1000 Series Aggregation Services Routers with dual RP:

```
Router# configure terminal
Router(config)# network-clock synchronization automatic
Router(config)# network-clock synchronization ssm option 2 GEN
Router(config)# network-clock input-source 1 External R0 t1 esf
Router(config)# exit
```

The following example shows how to configure clock recovery with BITS as the input source on the Cisco ASR 1002-X Series Aggregation Services Routers on the E1 Common Channel Signal mode:

```
Router# configure terminal
Router(config)# network-clock synchronization automatic
Router(config)# network-clock synchronization ssm option 2 GEN
Router(config)# network-clock input-source 1 external r0 e1 cas crc4 120 linecode
Router(config)# exit
```

## Configuring a SyncE Using the System-to-External Method

This section describes how to configure SyncE using System-to-External method.

### SUMMARY STEPS

1. enable
2. configure terminal
3. network-clock synchronization automatic
4. network-clock synchronization ssm option {option\_id {GEN1 | GEN2}}
5. *network-clock output-source system priority {external slot/card/port [2m | 10m]}*
6. exit

### DETAILED STEPS

|               | Command or Action                                                                                                     | Purpose                                                                                                                                                                        |
|---------------|-----------------------------------------------------------------------------------------------------------------------|--------------------------------------------------------------------------------------------------------------------------------------------------------------------------------|
| <b>Step 1</b> | <b>enable</b><br><b>Example:</b><br>Router# enable                                                                    | Enables the privileged EXEC mode.<br>Enter your password if prompted.                                                                                                          |
| <b>Step 2</b> | <b>configure terminal</b><br><b>Example:</b><br>Router# configure terminal                                            | Enters the global configuration mode.                                                                                                                                          |
| <b>Step 3</b> | network-clock synchronization automatic<br><b>Example:</b><br>Router(config)# network-clock synchronization automatic | Enables the network clock selection algorithm. This command disables the Cisco-specific network clock process, and turns on the G.781-based automatic clock selection process. |

|               | Command or Action                                                                                                                                                                                                                                 | Purpose                                                                                                                                                                                                                                                |
|---------------|---------------------------------------------------------------------------------------------------------------------------------------------------------------------------------------------------------------------------------------------------|--------------------------------------------------------------------------------------------------------------------------------------------------------------------------------------------------------------------------------------------------------|
| <b>Step 4</b> | <p>network-clock synchronization ssm option {option_id {GEN1   GEN2}}</p> <p><b>Example:</b></p> <p><b>Example:</b></p> <p><b>Example:</b></p> <pre>Router(config)# network-clock synchronization ssm option 2 GEN1</pre>                         | Configures the equipment to work in a synchronization network. The option_id value 1 refers to a synchronization networks design for Europe. This is the default value. The option_id value 2 refers to a synchronization networks design for the U.S. |
| <b>Step 5</b> | <p>network-clock output-source system priority {external slot/card/port [2m   10m]}</p> <p><b>Example:</b></p> <p><b>Example:</b></p> <p><b>Example:</b></p> <pre>Router(config)# network-clock output-source system 1 external 4/0/0 t1 sf</pre> | Configures the system clock to be used on external Tx interfaces.                                                                                                                                                                                      |
| <b>Step 6</b> | <p>exit</p> <p><b>Example:</b></p> <pre>Router(config)# exit</pre>                                                                                                                                                                                | Exits the global configuration mode.                                                                                                                                                                                                                   |

## Examples

The following example shows how to configure SyncE using System-to-External method:

```
Router>enable
Router# configure terminal
Router(config)# network-clock synchronization automatic
Router(config)# network-clock synchronization ssm option 2 GEN1
Router(config)# network-clock input-source 1 External 5/3/0 t1 sf
Router(config)# exit
```

The following example shows how to configure clock cleanup using an SSU:

```
Router(config)# network-clock output-source line 1 interface GigabitEthernet1/0/0 External
1/0/0 t1 sf
Router(config)# network-clock input-source 1 External 5/3/0 t1 sf
```

## Configuring Clock Recovery with a BITS Port as an Output-Source

This section describes how to configure clock recovery from a BITS port as an output-source.



**Note** BITS configuration as output sources is supported only on Cisco ASR 1002-X Router.

## SUMMARY STEPS

1. **enable**
2. **configure terminal**
3. **network-clock synchronization automatic**
4. **network-clock synchronization ssm option {1 | 2 {GEN1 | GEN2}}**
5. **network-clock output-source priority {external slot/card/port}**
6. **exit**

## DETAILED STEPS

|               | Command or Action                                                                                                                                                                                | Purpose                                                                                                                                                                                                                                                                                  |
|---------------|--------------------------------------------------------------------------------------------------------------------------------------------------------------------------------------------------|------------------------------------------------------------------------------------------------------------------------------------------------------------------------------------------------------------------------------------------------------------------------------------------|
| <b>Step 1</b> | <b>enable</b><br><b>Example:</b><br>Router# <b>enable</b>                                                                                                                                        | Enables the privileged EXEC mode.<br>Enter your password if prompted.                                                                                                                                                                                                                    |
| <b>Step 2</b> | <b>configure terminal</b><br><b>Example:</b><br>Router# <b>configure terminal</b>                                                                                                                | Enters the global configuration mode.                                                                                                                                                                                                                                                    |
| <b>Step 3</b> | <b>network-clock synchronization automatic</b><br><b>Example:</b><br>Router(config)# <b>network-clock synchronization automatic</b>                                                              | Enables the network clock selection algorithm. This command disables the Cisco-specific network clock process, and turns on the G.781-based automatic clock selection process.                                                                                                           |
| <b>Step 4</b> | <b>network-clock synchronization ssm option {1   2 {GEN1   GEN2}}</b><br><b>Example:</b><br>Router(config)# <b>network-clock synchronization ssm option 2 GEN1</b>                               | Configures the equipment to work in synchronization network. The option_id value 1 refers to synchronization networks design for Europe. This is the default value. The option_id value 2 refers to the synchronization networks design for the U.S.                                     |
| <b>Step 5</b> | <b>network-clock output-source priority {external slot/card/port}</b><br><b>Example:</b><br>Router(config)# <b>network-clock output-source system 1 External 0/3/0 t1 esf</b><br><b>Example:</b> | Enables clock recovery from a BITS port.<br><b>Note</b> For routers with dual hardware support such as the Cisco ASR 1006 Router can have two RP ports wherein one RP is active and the other is standby. Both the active and standby RP BITS ports can be configured as output sources. |

|               | Command or Action                                                                                                                                                                                                       | Purpose                              |
|---------------|-------------------------------------------------------------------------------------------------------------------------------------------------------------------------------------------------------------------------|--------------------------------------|
|               | <p><b>Example:</b></p> <pre>Router(config)# network-clock output-source 1 External R0 t1 esf</pre> <p><b>Example:</b></p> <pre>Router(config)# network-clock output-source 1 external r0 e1 cas crc4 120 linecode</pre> |                                      |
| <b>Step 6</b> | <p><b>exit</b></p> <p><b>Example:</b></p> <pre>Router(config)# exit</pre>                                                                                                                                               | Exits the global configuration mode. |

## Examples

The following example shows how to configure clock recovery from a BITS port for a Metronome SPA:

```
Router# configure terminal
Router(config)# network-clock synchronization automatic
Router(config)# network-clock synchronization ssm option 2 GEN1
Router(config)# network-clock output-source 1 external 0/3/0 t1 esf
Router(config)# exit
```

The following example shows how to configure clock recovery from a BITS port for RP BITS on Cisco ASR 1000 Series Aggregation Services Routers with dual RP:

```
Router# configure terminal
Router(config)# network-clock synchronization automatic
Router(config)# network-clock synchronization ssm option 2 GEN
Router(config)# network-clock output-source 1 external R0 t1 esf
Router(config)# exit
```

## Configuring a SyncE Using the System-to-External Method

This section describes how to configure SyncE using System-to-External method.

The following example shows how to configure clock recovery with BITS as output-source on Cisco ASR 1002-X Series Aggregation Services Routers on a E1 Common Channel Signal Mode:

```
Router# configure terminal
Router(config)# network-clock synchronization automatic
Router(config)# network-clock synchronization ssm option 2 GEN
Router(config)# network-clock output-source 1 external r0 e1 cas crc4 120 linecode
Router(config)# exit
```

## Configuring SyncE by Using the Line to External Feature

This section describes how to configure network synchronization by using the Line to External feature.



**Note** The Line to External feature is not supported on the Cisco ASR 1002-X Router.

## SUMMARY STEPS

1. **configure terminal**
2. **network-clock synchronization automatic**
3. **network-clock synchronization ssm option {1 | 2 {GEN1 | GEN2}}**
4. **interface gigabitethernet *slot/card/port***
5. **synchronous mode**
6. **exit**
7. **network-clock output-source line *priority* {interface *interface-name*} {external *slot/card/port*}**
8. **exit**

## DETAILED STEPS

|               | Command or Action                                                                                                                                                                     | Purpose                                                                                                                                                                                                                                              |
|---------------|---------------------------------------------------------------------------------------------------------------------------------------------------------------------------------------|------------------------------------------------------------------------------------------------------------------------------------------------------------------------------------------------------------------------------------------------------|
| <b>Step 1</b> | <b>configure terminal</b><br><b>Example:</b><br>Router# <b>configure terminal</b>                                                                                                     | Enters the global configuration mode.                                                                                                                                                                                                                |
| <b>Step 2</b> | <b>network-clock synchronization automatic</b><br><b>Example:</b><br>Router(config)# <b>network-clock synchronization automatic</b>                                                   | Enables the network clock selection algorithm. This command disables the Cisco-specific network clock process, and turns on the G.781-based automatic clock selection process.                                                                       |
| <b>Step 3</b> | <b>network-clock synchronization ssm option {1   2 {GEN1   GEN2}}</b><br><b>Example:</b><br>Router(config)# <b>network-clock synchronization ssm option 2 GEN1</b><br><b>Example:</b> | Configures the equipment to work in a synchronization network. The option_id value 1 refers to a synchronization network design for Europe. This is the default value. The option_id value 2 refers to a synchronization network design for the U.S. |
| <b>Step 4</b> | <b>interface gigabitethernet <i>slot/card/port</i></b><br><b>Example:</b><br>Router(config)# <b>interface gigabitethernet 0/2/0</b>                                                   | Specifies the Gigabit Ethernet interface to be configured: <i>slot/card/port</i> —Specifies the location of the interface.                                                                                                                           |
| <b>Step 5</b> | <b>synchronous mode</b><br><b>Example:</b>                                                                                                                                            | Changes to the synchronous mode.                                                                                                                                                                                                                     |

|               | Command or Action                                                                                                                                                                                                                           | Purpose                                                                                                                             |
|---------------|---------------------------------------------------------------------------------------------------------------------------------------------------------------------------------------------------------------------------------------------|-------------------------------------------------------------------------------------------------------------------------------------|
|               | Router(config-if)# <b>synchronous mode</b>                                                                                                                                                                                                  |                                                                                                                                     |
| <b>Step 6</b> | <b>exit</b><br><b>Example:</b><br>Router(config)# <b>exit</b>                                                                                                                                                                               | Exits the specific configuration mode.                                                                                              |
| <b>Step 7</b> | <b>network-clock output-source line priority {interface interface-name} {external slot/card/port}</b><br><b>Example:</b><br>Router(config-if-srv)# <b>network-clock output-source line 1 interface gigabitethernet 0/2/0 external 0/3/0</b> | Configures the line clock to be used on external Tx interfaces.<br><b>Note</b> This command is supported only on the Metronome SPA. |
| <b>Step 8</b> | <b>exit</b><br><b>Example:</b><br>Router(config)# <b>exit</b>                                                                                                                                                                               | Exits the global configuration mode.                                                                                                |

## Examples

The following example shows how to configure a SyncE using the Line to External method:

```
Router# configure terminal
Router(config)# network-clock synchronization automatic
Router(config)# network-clock synchronization ssm option 2 GEN1
Router(config)# interface gigabitethernet 0/2/0
Router(config-if)# synchronous mode
Router(config)# exit
Router(config)# network-clock output-source line 1 interface gigabitethernet 0/2/0 external
0/3/0
Router(config)# exit
```

## Managing Synchronization

Manage synchronization on a Cisco ASR 1000 Series Aggregation Service Router using the following management commands:

- **network-clock synchronization mode QL-enabled** command

Use the **network-clock synchronization mode QL-enabled** command in the global configuration mode to configure the automatic selection process for the QL-enabled mode. This succeeds only if the SyncE interfaces are capable of sending SSMs.

The following example shows how to configure network clock synchronization (QL-enabled mode) in the global configuration mode:

```
Router(config)# network-clock synchronization mode QL-enabled
```

- **esmc process** command

Use the **esmc process** command in the global configuration mode to enable the ESMC process at system level. The **no** form of this command disables the ESMC process. The **no** form of this command fails if no SyncE-capable interface is installed on the platform.

The following example shows how to enable the ESMC process in the global configuration mode:

```
Router(config)# esmc process
```

- **esmc mode [tx | rx]** command

Use the **esmc mode [tx | rx]** command in the interface configuration mode to enable the ESMC process at the interface level. The **no** form of the command disables the ESMC process.

The following example shows how to enable ESMC in the interface configuration mode:

```
Router(config-if)# esmc mode tx
```

- **network-clock source quality-level** command

Use the **network-clock source quality-level** command in the interface configuration mode to configure the QL value for ESMC on a *gigabit Ethernet* port. The value is based on global interworking options:

- If Option 1 is configured, the available values are QL-PRC, QL-SSU-A, QL-SSU-B, QL-SEC, and QL-DNU.
- If Option 2 is configured with GEN 2, the available values are QL-PRS, QL-STU, QL-ST2, QL-TNC, QL-ST3, QL-SMC, QL-ST4, and QL-DUS.
- If Option 2 is configured with GEN1, the available values are QL-PRS, QL-STU, QL-ST2, QL-SMC, QL-ST4, and QL-DUS

The following example shows how to configure the **network-clock source quality-level** in the interface configuration mode:

```
Router(config-if)# network-clock source quality-level QL-PRC rx
```

Use the **network-clock quality-level** command in the global configuration mode to configure the QL value for the SSMs on a BITS port.

The following example shows how to configure **network-clock quality-level** command in the global configuration mode:

```
Router(config)# network-clock quality-level rx qL-prc external R0 2048k
```

- **network-clock wait-to-restore** command

Use the **network-clock wait-to-restore** timer global command to set the wait-to-restore time. You can configure the wait-to-restore time to any value between 0 to 86400 seconds. The default value is 300 seconds. The wait-to-restore timer can be set in the global configuration mode and the interface configuration mode.

The following example shows how to configure the wait-to-restore timer in the global configuration mode:

```
Router(config)# network-clock wait-to-restore 10 global
```

The following example shows how to configure the wait-to-restore timer in the interface configuration mode:



```
Router(config)# interface gigabitethernet 0/2/0
Router(config-if)# network-clock wait-to-restore 10
```

- network-clock hold-off command

Use the network-clock hold-off timer global command to configure hold-off time. You can configure the hold-off time to either 0 or any value between 50 to 10000 ms. The default value is 300 ms. The network-clock hold-off timer can be set in the global configuration mode and the interface configuration mode.

The following example shows how to configure the hold-off timer:

```
Router(config-if)# network-clock hold-off 50 global
```

- network-clock switch force command

Use the network-clock switch force command to forcefully select a synchronization source irrespective of whether the source is available, and within range.

The following example shows how to configure a force switch:

```
Router# network-clock switch force interface gigabitethernet 0/2/0
```

- network-clock switch manual command

Use the network-clock switch manual command to manually select a synchronization source, provided the clock source has a higher quality level than the currently active clock.

The following example shows how to configure a manual switch:

```
Router# network-clock switch manual interface gigabitethernet 0/2/0
```

- network-clock clear switch controller-id command

Use the network-clock clear switch controller-id command to clear the manual, or switch it on by force.

The following example shows how to clear a switch:

```
Router# network-clock clear switch t0
```

- network-clock set lockout command

Use the network-clock set lockout command to lockout a clock source. A clock source flagged as lockout is not selected for SyncE. To clear the lock-out on a source, use the network-clock clear lockout command.

The following example shows how to lock out a clock source:

```
Router# network-clock set lockout interface gigabitethernet 0/2/0
```

The following example shows how to clear the lock out on a clock source:

```
Router# network-clock clear lockout interface gigabitethernet 0/2/0
```

## Verifying the Network Synchronization Configuration

Use the following commands to verify the network synchronization configuration:

- Use the show network-clock synchronization command to display the output:

```

Router# show network-clock synchronization
Symbols: En - Enable, Dis - Disable, Adis - Admin Disable
 NA - Not Applicable
 * - Synchronization source selected
 # - Synchronization source force selected
 & - Synchronization source manually switched

Automatic selection process : Enable
Equipment Clock : 1544 (EEC-Option2)
Clock Mode : QL-Enable
ESMC : Enabled
SSM Option : GEN1
T0 : External R0 t1 esf
Hold-off (global) : 300 ms
Wait-to-restore (global) : 300 sec
Tsm Delay : 180 ms
Revertive : No
Force Switch: FALSE
Manual Switch: FALSE
Number of synchronization sources: 2
sm(netsync NETCLK_QL_ENABLE), running yes, state 1A
Last transition recorded: (src_rem)-> 1A (src_added)-> 1A (src_rem)-> 1A (src_added)-> 1A
(ql_change)-> 1A (sf_change)-> 1A (force_sw)-> 1C (clear_sw)-> 1A (sf_change)-> 1A
(sf_change)-> 1A

Nominated Interfaces
 Interface SigType Mode/QL Prio QL_IN ESMC Tx ESMC Rx
Internal NA NA/Dis 251 QL-ST3 NA NA
Gil/2/0 NA Sync/En 1 QL-FAILED - -
*External R0 T1 ESF NA/En 2 QL-STU NA NA

```

- Use the show network-clock synchronization detail command to display all the details of network clock synchronization parameters at the global and interface level, as shown in the following example:

```

Router# show network-clock synchronization detail
Symbols: En - Enable, Dis - Disable, Adis - Admin Disable
 NA - Not Applicable
 * - Synchronization source selected
 # - Synchronization source force selected
 & - Synchronization source manually switched

Automatic selection process : Enable
Equipment Clock : 1544 (EEC-Option2)
Clock Mode : QL-Enable
ESMC : Enabled
SSM Option : GEN1
T0 : External R0 t1 esf
Hold-off (global) : 300 ms
Wait-to-restore (global) : 300 sec
Tsm Delay : 180 ms
Revertive : No
Force Switch: FALSE
Manual Switch: FALSE
Number of synchronization sources: 2
sm(netsync NETCLK_QL_ENABLE), running yes, state 1A
Last transition recorded: (src_rem)-> 1A (src_added)-> 1A (src_rem)-> 1A (src_added)-> 1A
(ql_change)-> 1A (sf_change)-> 1A (force_sw)-> 1C (clear_sw)-> 1A (sf_change)-> 1A
(sf_change)-> 1A

Nominated Interfaces
 Interface SigType Mode/QL Prio QL_IN ESMC Tx ESMC Rx
Internal NA NA/Dis 251 QL-ST3 NA NA
Gil/2/0 NA Sync/En 1 QL-FAILED - -
*External R0 T1 ESF NA/En 2 QL-STU NA NA

```

```

Interface:

Local Interface: Internal
Signal Type: NA
Mode: NA(ql-enabled)
SSM Tx: Disable
SSM Rx: Disable
Priority: 251
QL Receive: QL-ST3
QL Receive Configured: -
QL Receive Overrided: -
QL Transmit: -
QL Transmit Configured: -
Hold-off: 0
Wait-to-restore: 0
Lock Out: FALSE
Signal Fail: FALSE
Alarms: FALSE
Slot Disabled: FALSE
Local Interface: Gi1/2/0
Signal Type: NA
Mode: Synchronous(ql-enabled)
ESMC Tx: Disable
ESMC Rx: Enable
Priority: 1
QL Receive: QL-PRS
QL Receive Configured: -
QL Receive Overrided: QL-FAILED
QL Transmit: QL-DUS
QL Transmit Configured: -
Hold-off: 300
Wait-to-restore: 300
Lock Out: FALSE
Signal Fail: FALSE
Alarms: TRUE
Slot Disabled: FALSE
Local Interface: External R0
Signal Type: T1 ESF
Mode: NA(ql-enabled)
SSM Tx: Disable
SSM Rx: Enable
Priority: 2
QL Receive: QL-STU
QL Receive Configured: -
QL Receive Overrided: -
QL Transmit: -
QL Transmit Configured: -
Hold-off: 300
Wait-to-restore: 300
Lock Out: FALSE
Signal Fail: FALSE
Alarms: FALSE
Slot Disabled: FALSE

```

- Use the show esmc command to display the ESMC configuration output:

```

Router# show esmc
Interface: GigabitEthernet0/0/0
 Administrative configurations:
 Mode: Synchronous
 ESMC TX: Enable
 ESMC RX: Enable
 QL TX: -
 QL RX: -

```

```

Operational status:
Port status: UP
QL Receive: QL-PRC
QL Transmit: QL-DNU
QL rx overridden: -
ESMC Information rate: 1 packet/second
ESMC Expiry: 5 second
Interface: GigabitEthernet0/0/0
Administrative configurations:
Mode: Synchronous
ESMC TX: Enable
ESMC RX: Enable
QL TX: -
QL RX: -
Operational status:
Port status: UP
QL Receive: QL-DNU
QL Transmit: QL-DNU
QL rx overridden: QL-DNU
ESMC Information rate: 1 packet/second
ESMC Expiry: 5 second

```

- Use the `show esmc detail` command to display all the details of the ESMC parameters at the global and interface level, as shown in the following example:

```

Router# show esmc detail
Router#show esmc detail
Interface: GigabitEthernet0/0/0
Administrative configurations:
Mode: Synchronous
ESMC TX: Enable
ESMC RX: Enable
QL TX: -
QL RX: QL-PRS
Operational status:
Port status: UP
QL Receive: QL-DUS
QL Transmit: QL-ST3
QL rx overridden: QL-DUS
ESMC Information rate: 1 packet/second
ESMC Expiry: 5 second
ESMC Tx Timer: Running
ESMC Rx Timer: Running
ESMC Tx interval count: 1
ESMC INFO pkts in: 0
ESMC INFO pkts out: 256
ESMC EVENT pkts in: 0
ESMC EVENT pkts out: 0

```

## Troubleshooting the Network Synchronization Configuration



---

**Note** Before you troubleshoot, ensure that all the network synchronization configurations are complete.

---

The following table provides information about troubleshooting scenarios that you may encounter while configuring network synchronization.

Table 36: Troubleshooting Scenarios

| Problem                                                | Solution                                                                                                                                                                                                                                                                                                                                                                                                                                                                                                                                                                                                                                                                                                                                                                                                                                                                                                                                                                                                                                                                                                                                                                                                                                                                                 |
|--------------------------------------------------------|------------------------------------------------------------------------------------------------------------------------------------------------------------------------------------------------------------------------------------------------------------------------------------------------------------------------------------------------------------------------------------------------------------------------------------------------------------------------------------------------------------------------------------------------------------------------------------------------------------------------------------------------------------------------------------------------------------------------------------------------------------------------------------------------------------------------------------------------------------------------------------------------------------------------------------------------------------------------------------------------------------------------------------------------------------------------------------------------------------------------------------------------------------------------------------------------------------------------------------------------------------------------------------------|
| Incorrect clock selection                              | <ul style="list-style-type: none"> <li>• Verify that there are no alarms on the interfaces. Use the show network-clock synchronization detail command to check this.</li> <li>• Ensure that the nonrevertive configurations are in place.</li> </ul>                                                                                                                                                                                                                                                                                                                                                                                                                                                                                                                                                                                                                                                                                                                                                                                                                                                                                                                                                                                                                                     |
| Incorrect QL values                                    | Ensure that there is no framing mismatch with the SSM option.                                                                                                                                                                                                                                                                                                                                                                                                                                                                                                                                                                                                                                                                                                                                                                                                                                                                                                                                                                                                                                                                                                                                                                                                                            |
| Incorrect clock limit set or queue limit disabled mode | <ul style="list-style-type: none"> <li>• Verify that there are no alarms on the interfaces. Use the show network-clock synchronization detail RP command to confirm.</li> <li>• Use the <b>show network-clock synchronization</b> command to confirm if the system is in revertive mode or nonrevertive mode and verify the nonrevertive configurations as shown in this example:</li> </ul> <pre> Router#show network-clock synchronization Symbols: En - Enable, Dis - Disable, Adis - Admin Disable NA - Not Applicable * - Synchronization source selected # - Synchronization source force selected &amp; - Synchronization source manually switched Automatic selection process : Enable Equipment Clock : 1544 (EEC-Option2) Clock Mode : QL-Enable ESMC : Enabled SSM Option : GEN1 T0 : External R0 t1 esf Hold-off (global) : 300 ms Wait-to-restore (global) : 300 sec Tsm Delay : 180 ms Revertive : No Force Switch: FALSE Manual Switch: FALSE Number of synchronization sources: 2 sm(netsync NETCLK_QL_ENABLE), running yes, state 1A Last transition recorded: (src_rem)-&gt; 1A (src_added)-&gt; 1A (src_rem)-&gt; 1A (src_added)-&gt; 1A (ql_change)-&gt; 1A (sf_change)-&gt; 1A (force_sw)-&gt; 1C (clear_sw)-&gt; 1A (sf_change)-&gt; 1A (sf_change)-&gt; 1A </pre> |

| Problem                                                                                                | Solution                                                                                                                                                                                                                                                                                                                                       |
|--------------------------------------------------------------------------------------------------------|------------------------------------------------------------------------------------------------------------------------------------------------------------------------------------------------------------------------------------------------------------------------------------------------------------------------------------------------|
| Incorrect QL values observed when you use the <b>show network-clock synchronization detail</b> command | Use the <b>network-clock synchronization SSM</b> ( <i>option 1</i> / <i>option 2</i> ) command to confirm that there is no framing mismatch. Use the <b>show run interface</b> command to validate the framing for a specific interface. For SSM <i>option 1</i> , framing should be SDH or E1, and for SSM <i>option 2</i> , it should be T1. |
| Mismatched Physical line coding mechanisms between clock source and input source on the router         | To ensure that this feature works correctly, both the ends need to be configured with identical physical line coding mechanism and encapsulation values.                                                                                                                                                                                       |

## Additional References

### Standards

| Standard | Title |
|----------|-------|
| None     | —     |

### MIBs

| MIB  | MIBs Link                                                                                                                                                                                                     |
|------|---------------------------------------------------------------------------------------------------------------------------------------------------------------------------------------------------------------|
| None | To locate and download MIBs for selected platforms, Cisco IOS releases, and feature sets, use Cisco MIB Locator found at this URL:<br><a href="http://www.cisco.com/go/mibs">http://www.cisco.com/go/mibs</a> |

### RFCs

| RFC  | Title |
|------|-------|
| None | —     |

### Technical Assistance

| Description                                                                                                                                                                                                                                                                                                                                                                           | Link                                                                                                              |
|---------------------------------------------------------------------------------------------------------------------------------------------------------------------------------------------------------------------------------------------------------------------------------------------------------------------------------------------------------------------------------------|-------------------------------------------------------------------------------------------------------------------|
| The Cisco Support and Documentation website provides online resources to download documentation, software, and tools. Use these resources to install and configure the software and to troubleshoot and resolve technical issues with Cisco products and technologies. Access to most tools on the Cisco Support and Documentation website requires a Cisco.com user ID and password. | <a href="http://www.cisco.com/cisco/web/support/index.html">http://www.cisco.com/cisco/web/support/index.html</a> |

# Feature Information for Network Synchronization Support

The following table lists the features in this module and provides links to specific configuration information.

Use Cisco Feature Navigator to find information about platform support and software image support. Cisco Feature Navigator enables you to determine which software images support a specific software release, feature set, or platform. To access Cisco Feature Navigator, go to <http://www.cisco.com/go/cfn>. An account on Cisco.com is not required.



**Note** The following table lists only the software release that introduced support for a given feature in a given software release train. Unless noted otherwise, subsequent releases of that software release train also support that feature.

**Table 37: Feature Information for Network Synchronization Support**

| Feature Name                    | Releases           | Feature Information                                                                                                                                         |
|---------------------------------|--------------------|-------------------------------------------------------------------------------------------------------------------------------------------------------------|
| Network Synchronization Support | Cisco IOS XE 3.2S  | In Cisco IOS XE Release 3.2S, this feature was introduced on the Cisco ASR 1000 Series Aggregation Service Routers.                                         |
| Network Synchronization Support | Cisco IOS XE 3.7S  | In Cisco IOS XE Release 3.7S, the commands that are used to configure this feature have been extended with the introduction of the Cisco ASR 1002-X Router. |
| Network Synchronization Support | Cisco IOS XE 3.12S | In Cisco IOS XE Release 3.12S, the commands that are used to configure this feature have been extended to the Cisco ASR 1001-X Router.                      |







## CHAPTER 17

# IEEE 1588v2 PTP Support

IEEE 1588v2 Precision Time Protocol (PTP) is a packet-based two-way message exchange protocol for synchronizing clocks between nodes in a network, thereby enabling an accurate time distribution over a network. This document explains how to configure IEEE 1588v2 PTP on the Cisco ASR 1002-X Routers.

- [Restrictions for IEEE 1588v2 PTP, on page 419](#)
- [Information About IEEE 1588v2 PTP, on page 419](#)
- [Configuring IEEE 1588v2 PTP, on page 427](#)
- [Additional References, on page 438](#)
- [Feature Information for IEEE 1588v2 PTP Support, on page 438](#)

## Restrictions for IEEE 1588v2 PTP

These are the restrictions for configuring IEEE 1588v2 PTP:

- Supports IPv4 unicast mode, but not multicast mode.
- Does not support Dot1q, Q-in-Q, and port-channel interfaces.
- Primary PTP supports only a maximum of 32 secondary PTP.
- PTP boundary clock is supported only in unicast negotiation mode.
- IPv6 and Multiprotocol Label Switching (MPLS) encapsulation are not supported for PTP packet transfer over Cisco ASR 1002-X Routers.
- The time-of-day recovered from a 1588v2 session does not synchronize with the system clock.
- GPS interfaces can be used only for clock recovery. You cannot transmit the system clock on the GPS interface.

## Information About IEEE 1588v2 PTP

IEEE 1588v2 PTP is a packet-based two-way message exchange protocol for synchronizing a local clock with a primary reference clock in a hierarchical primary-secondary architecture. This synchronization is achieved through packets that are transmitted and received in a session between a primary reference clock and a secondary clock. IEEE 1588v2 PTP supports system-wide synchronization accuracy in the sub-microsecond range with little use of network and local clock-computing resources.

The following sections describe the terminologies used for better understanding of the IEEE 1588v2 PTP.

## PTP Clocks

PTP employs a hierarchy of clock types to ensure that precise timing and synchronization is maintained between the source and the numerous PTP clients that are distributed throughout the network. A logical grouping of PTP clocks that synchronize with each other using the PTP protocol, but are not necessarily synchronized to the PTP clocks in another domain, is called a PTP domain.

The three PTP clock types are Ordinary clock, Boundary clock, and Transparent clock.

- **Ordinary clock**—This clock type has a single PTP port in a domain, and maintains the timescale used in the domain. It may serve as a source of time, that is, be a primary, or may synchronize to another clock by being a subordinate. It provides time to an application or to an end device.
- **Boundary clock**—This clock type has multiple PTP ports in a domain, and maintains the timescale used in the domain. It may serve as a source of time, that is, be a primary, or may synchronize to another clock by being a subordinate. A boundary clock, that is secondary, has a single slave port, and transfers timing from that port to the primary ports.
- **Transparent clock**—This clock type is a device that measures the time taken for a PTP event message to pass through the device, and provides this information to the clocks receiving this PTP event message.

{start cross reference} Table 13-1 {end cross reference} shows the 1588v2 PTP support matrix on a Cisco ASR1000 platform.

**Table 38: 1588v2 PTP Support Matrix on a Cisco ASR1000 platform**

| Platform/PTP Clock mode | Ordinary Clock | Boundary Clock | Transparent Clock | Hybrid Clock |
|-------------------------|----------------|----------------|-------------------|--------------|
| ASR1002X                | Yes            | Yes            | No                | No           |

## Components of a PTP-enabled Network

The three key components of a PTP-enabled data network are primary reference, PTP client, and PTP-enabled router acting as a Boundary clock.

- **Primary Reference**—An IEEE1588v2 PTP network needs a primary reference to provide a precise time source. The most economical way of obtaining the precise time source for the primary reference is through a Global Positioning System (GPS) because it provides +/- 100 nanosecond (ns) accuracy. First, the PTP primary reference's built-in GPS receiver converts the GPS timing information to PTP time information, which is typically Coordinated Universal Time (UTC), and then delivers the UTC time to all the PTP clients.
- **PTP client**—A PTP client has to be installed on servers, network-monitoring and performance-analysis devices, or other devices that want to use the precise timing information provided by PTP, and it's mostly an ordinary clock. The two kinds of PTP clients are pure software PTP clients and hardware-assistant PTP clients.
- **PTP boundary clock**—Any router that is between a PTP primary and PTP secondary can act as a PTP boundary clock router. It has two interfaces, one facing the PTP primary and another facing the PTP secondary. The boundary clock router acts as a *secondary* on the interface facing the *PTP primary router*, and acts as a *primary* on the interface facing the *PTP secondary router*. The PTP boundary clock router is deployed to minimize timing delay in cases where the distance between PTP primary router and the PTP secondary router is more.



**Note** Intermediary nodes between PTP primary and secondary should be a PTP-enabled or transparent clock node.

The following figure shows the functions of a PTP Enabled device.

**Figure 2: 372860.eps Functions of a PTP-Enabled Device**

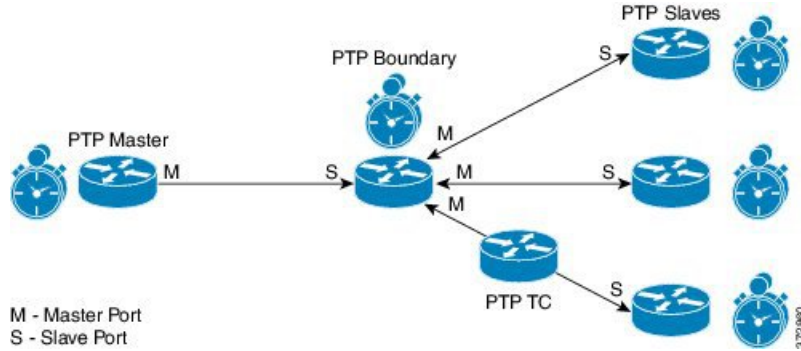

## Clock-Synchronization Process

Clock synchronization is achieved through a series of messages exchanged between the primary clock and the secondary clock as shown in the figure.

**Figure 3: Clock-Synchronization Process**

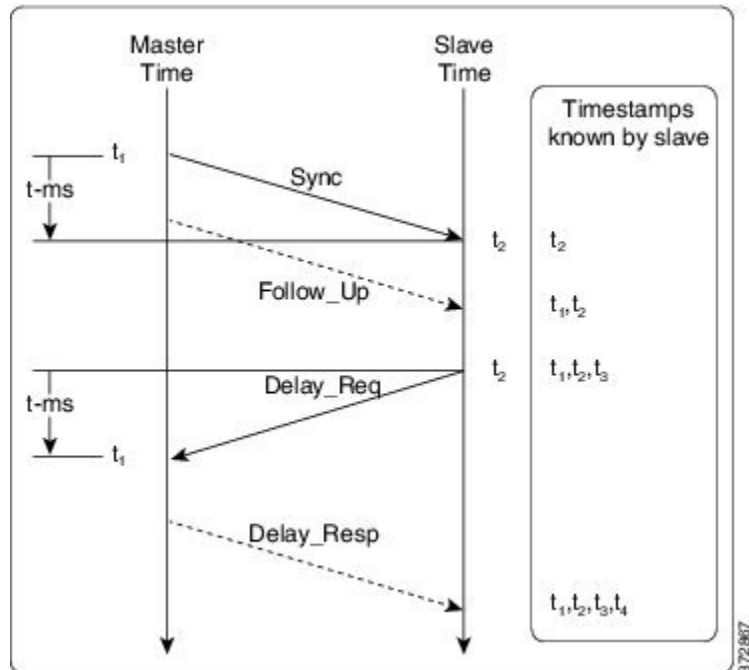

After the primary-secondary clock hierarchy is established, the clock synchronization process starts. The message exchange occurs in this sequence:

1. The primary clock sends a Sync message. The time at which the Sync message leaves the primary is time-stamped as  $t_{\text{start subscript}1 \text{end subscript}}$ .
2. The secondary clock receives the Sync message and is time-stamped as  $t_{\text{start subscript}2 \text{end subscript}}$ .
3. The secondary sends the Delay\_Req message, which is time-stamped as  $t_{\text{start subscript}3 \text{end subscript}}$  when it leaves the secondary, and as  $t_{\text{start subscript}4 \text{end subscript}}$  when the primary receives it.
4. The primary responds with a Delay\_Resp message that contains the time stamp  $t_{\text{start subscript}4 \text{end subscript}}$ .

The clock offset is the difference between the primary clock and the secondary clock, and is calculated as follows:

$$\text{Offset} = t_{\text{start subscript}2 \text{end subscript}} - t_{\text{start subscript}1 \text{end subscript}} - \text{meanPathDelay}$$

IEEE1588 assumes that the path delay between the primary clock and the secondary clock is symmetrical, and hence, the mean path delay is calculated as follows:

$$\text{meanPathDelay} = ((t_{\text{start subscript}2 \text{end subscript}} - t_{\text{start subscript}1 \text{end subscript}}) + (t_{\text{start subscript}4 \text{end subscript}} - t_{\text{start subscript}3 \text{end subscript}}))/2$$

## PTP Messages

All PTP communication is performed through message exchange. The two sets of messages defined by IEEE1588v2 are General messages and Event messages.

- **General messages**—These messages do not require accurate time stamps, and are classified as Announce, Follow\_Up, Delay\_Resp, Pdelay\_Resp\_Follow\_Up, Management, and Signaling.
- **Event messages**—These messages require accurate time stamping, and are classified as Sync, Delay\_Req, Pdelay\_Req, and Pdelay\_Resp.

## PTP Clocking Modes

The following are the PTP clocking modes supported on a Cisco ASR 1002-X Router:

- **Unicast Mode**—In unicast mode, the primary sends the Sync or Delay\_Resp messages to the secondary on the unicast IP address of the secondary, and the secondary in turn sends the Delay\_Req message to the primary on the unicast IP address of the primary.
- **Unicast Negotiation Mode**—In unicast negotiation mode, the primary does not know of any secondary until the secondary sends a negotiation message to the primary. The unicast negotiation mode is good for scalability purpose because one primary can have multiple secondary.

## PTP Accuracy

Accuracy is an important aspect of PTP implementation on an Ethernet port. For a packet network, Packet Delay Variation (PDV) is one of the key factors that impacts the accuracy of a PTP clock. The Cisco ASR 1002-X Router can handle the PDV of the network with its advanced hardware and software capabilities, such as hardware stamping and special high-priority queue for PTP packets. It can provide around 300 ns accuracy in a scalable deployment scenario.

The two methods used on the same topology to cross-check and verify the results are:

- One-pulse-per-second (1PPS) to verify the secondary PTP.
- Maximum Time Interval Error (MTIE) and Time Deviation (TDEV) to verify the PDV.

The verification topology includes a primary reference with a GPS receiver, a Cisco ASR 1002-X Router, PTP hardware secondary reference clocks with 1PPS output, and a test equipment for the measurement.

**Figure 4: 1PPS Accuracy Measurement**

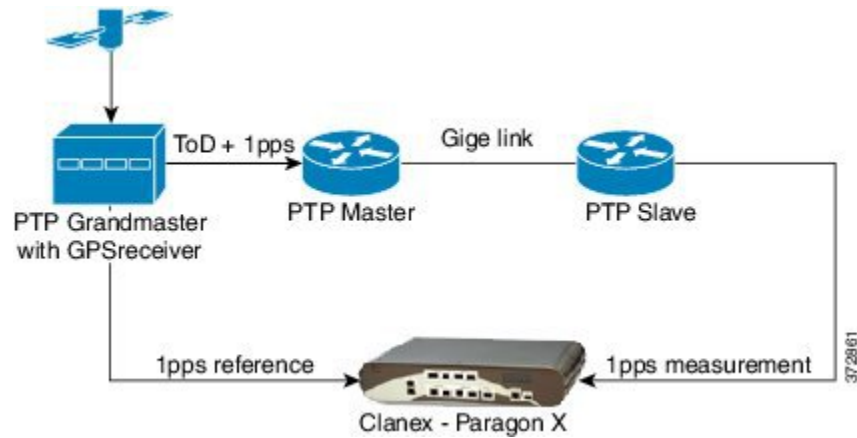

The following figure shows the PPS accuracy, with time of day measured using the test equipment as per the topology shown in the following figure. The average PPS accuracy value found is 250 ns.

Figure 5: Graph Showing PPS Accuracy

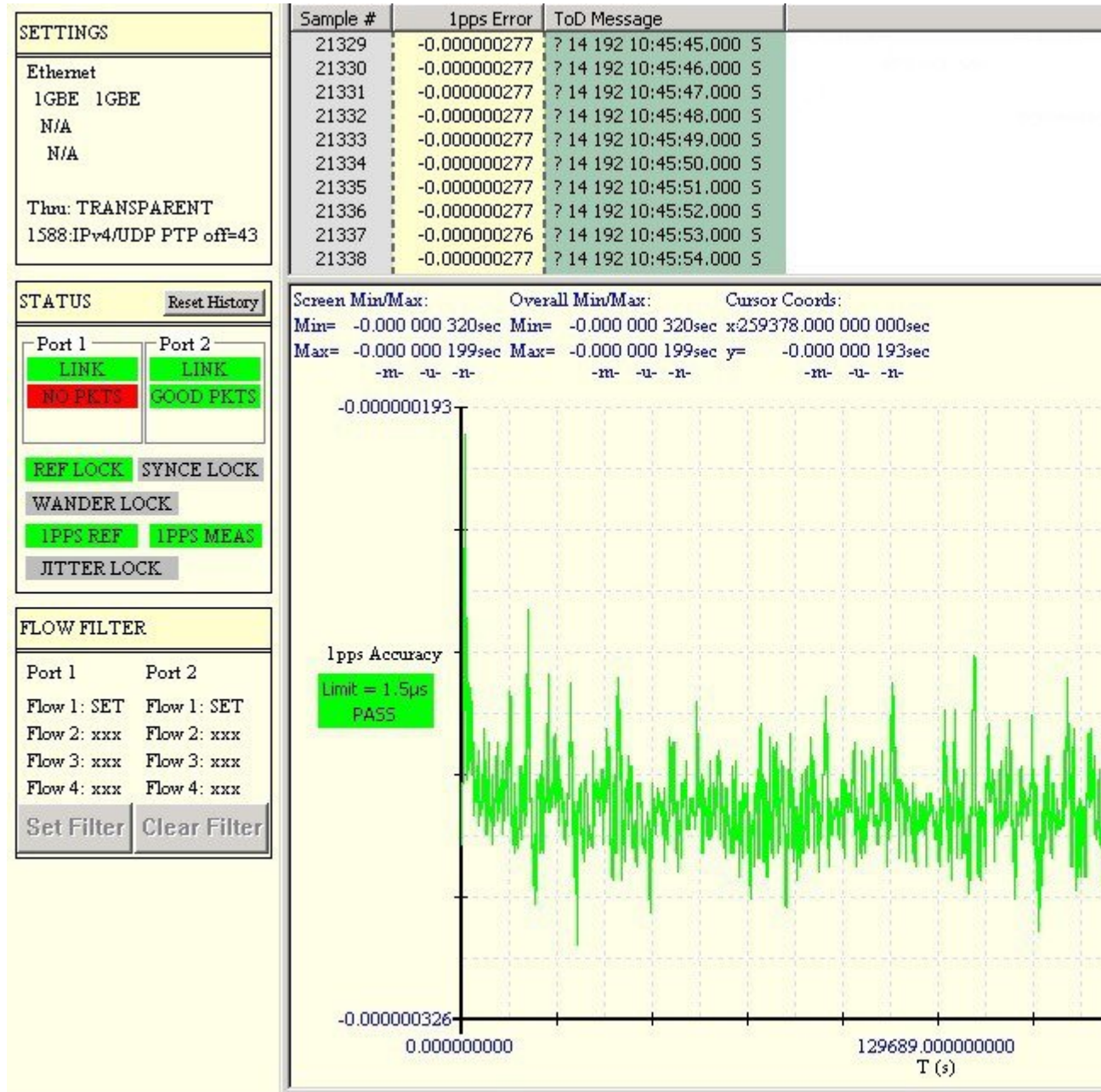

{start cross reference}Figure 13-5{end cross reference} shows a topology that includes a primary reference with a GPS receiver, a Cisco ASR 1002-X Router, PTP hardware secondary reference clocks, and a test equipment for the MTIE and TDEV measurement.

Figure 6: MTIE and TDEV measurement

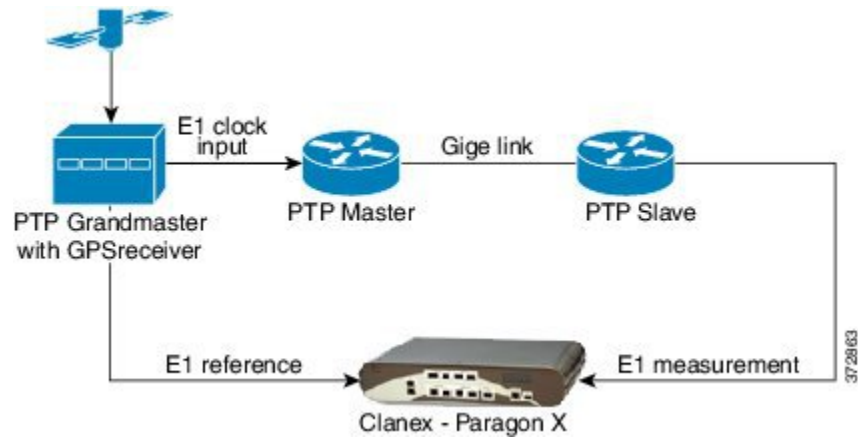

{start cross reference}Figure 13-6{end cross reference} shows a graph with the MTIE and TDEV measurements to verify the PDV.

Figure 7: Graph to show MTIE and TDEV Measurement

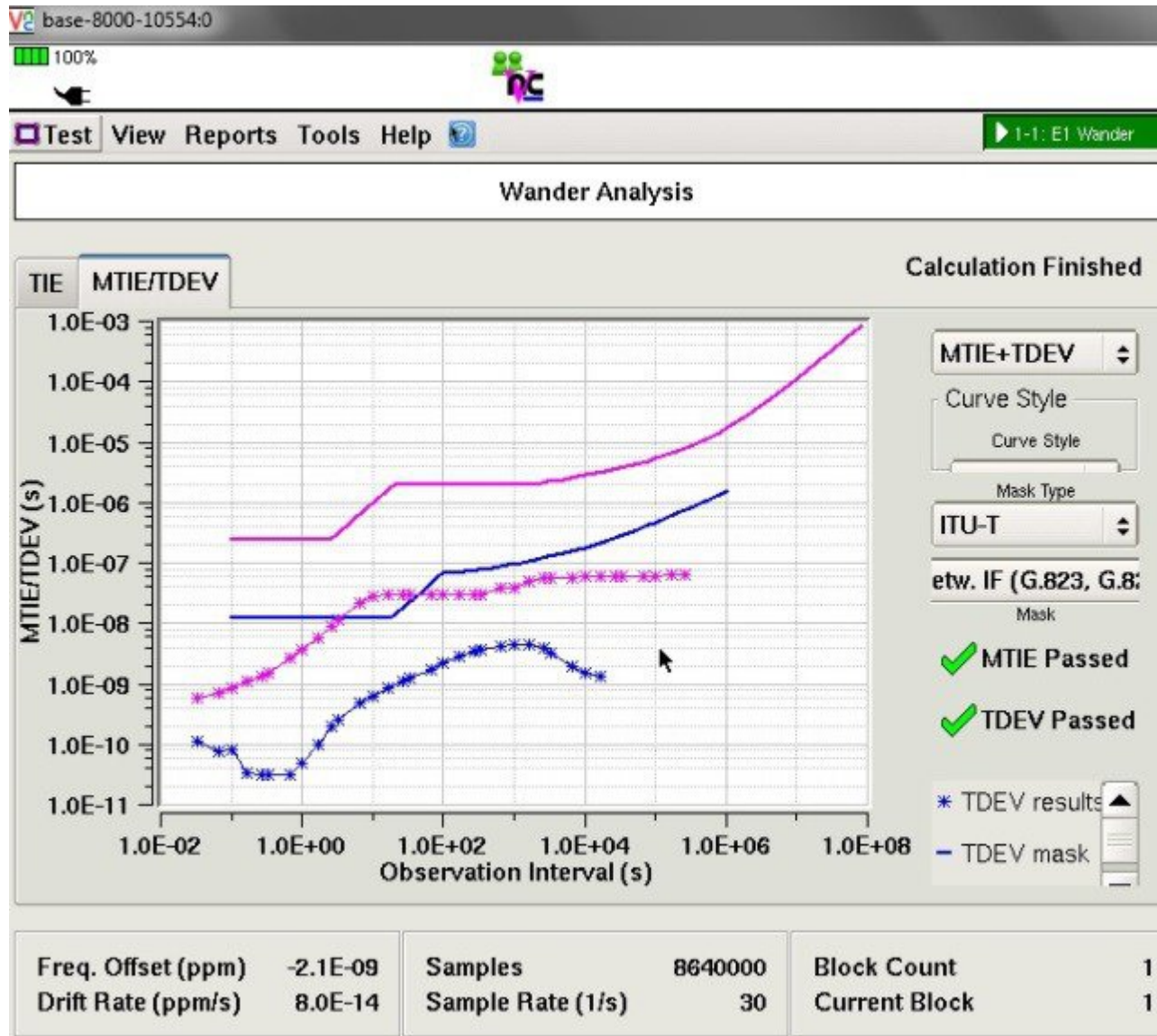

## IEEE 1588v2 PTP Support

IEEE 1588v2 PTP supports these features on a Cisco ASR1002-X Router:

- Two-step Ordinary clock and Boundary clock.
- Hardware-assistant PTP implementation to provide sub-300 ns accuracy.
- PTP operation on all physical onboard Gigabit Ethernet interfaces.
- Supports built-in Gigabit Ethernet links in two-step clock mode.



# Configuring IEEE 1588v2 PTP

You can configure IEEE 1588v2 PTP features on the Cisco ASR 1002-X Router by performing the following procedures:

## Configuring Input or Output Network Clocking

We recommend that you configure a stable input clock source from a GPS device before configuring primary PTP. The GPS device acts as a PTP primary reference, and the BITS or 10-MHz port of a Cisco ASR 1002-X Router can be used to input or output the network clock. Perform these tasks to configure network clocking on a Cisco ASR 1002-X Router:

## Configuring an Ordinary Clock

You can configure a Cisco ASR 1002-X Router in Ordinary clock mode as either primary or secondary.

*Figure 8: Ordinary Clock Scenario with a GPS Device as Primary Reference*



Perform these tasks to configure an ordinary clock as either primary or secondary:

## Configuring an Ordinary Clock as Primary PTP

This section describes how to configure an ordinary clock as primary PTP.

### SUMMARY STEPS

1. **configure terminal**
2. **ptp clock ordinary domain** *domain\_number*
3. **clock-port** *name* **master**
4. **transport ipv4 unicast interface** {GigabitEthernet | Loopback} *interface-number* [**negotiation**]
5. **clock destination** *ip-address*
6. **sync interval** *interval*
7. **end**

### DETAILED STEPS

|        | Command or Action                                                                 | Purpose                           |
|--------|-----------------------------------------------------------------------------------|-----------------------------------|
| Step 1 | <b>configure terminal</b><br><b>Example:</b><br>Router# <b>configure terminal</b> | Enters global configuration mode. |

|               | Command or Action                                                                                                                                                                                                                            | Purpose                                                                                                                                                                                                                                                                                                                                                          |
|---------------|----------------------------------------------------------------------------------------------------------------------------------------------------------------------------------------------------------------------------------------------|------------------------------------------------------------------------------------------------------------------------------------------------------------------------------------------------------------------------------------------------------------------------------------------------------------------------------------------------------------------|
| <b>Step 2</b> | <b>ptp clock ordinary domain</b> <i>domain_number</i><br><b>Example:</b><br><br>Router(config)# <b>ptp clock ordinary domain</b> 0                                                                                                           | Creates a PTP clock and specifies the clock mode.                                                                                                                                                                                                                                                                                                                |
| <b>Step 3</b> | <b>clock-port</b> <i>name</i> <b>master</b><br><b>Example:</b><br><br>Router(config-ptp-clk)# <b>clock-port MASTER</b> master                                                                                                                | Specifies the clocking mode of a PTP port and enters the clock port configuration mode.                                                                                                                                                                                                                                                                          |
| <b>Step 4</b> | <b>transport ipv4 unicast interface</b> {GigabitEthernet   Loopback} <i>interface-number</i> [ <b>negotiation</b> ]<br><b>Example:</b><br><br>Router(config-ptp-port)# <b>transport ipv4 unicast interface</b> Loopback11 <b>negotiation</b> | Specifies the IP version, transmission mode, and interface that a PTP clock port uses to exchange timing packets.<br><br>The <b>negotiation</b> keyword specifies the unicast negotiation mode where the secondary and primary clock exchange negotiation messages before establishing a relationship.<br><b>Note</b> Only Loopback interface type is supported. |
| <b>Step 5</b> | <b>clock destination</b> <i>ip-address</i><br><b>Example:</b><br><br>Router(config-ptp-port)# <b>clock destination</b> 20.20.20.20                                                                                                           | Specifies the IP address of a PTP clock destination.<br><br>If the clock port is set to primary mode with unicast negotiation, you need not use this command because the device uses negotiation to determine the IP address of PTP slave devices.                                                                                                               |
| <b>Step 6</b> | <b>sync interval</b> <i>interval</i><br><b>Example:</b><br><br>Router(config-ptp-port)# <b>sync interval</b> -4                                                                                                                              | (Optional) Specifies the interval used to send PTP synchronization messages.<br><br>The default value is -5.                                                                                                                                                                                                                                                     |
| <b>Step 7</b> | <b>end</b><br><b>Example:</b><br><br><b>Example:</b><br><br>Router(config-ptp-port)# <b>end</b>                                                                                                                                              | Exits global configuration mode.                                                                                                                                                                                                                                                                                                                                 |

## Examples

The following example shows how to configure an ordinary clock as primary PTP:

```
Router# configure terminal
Router(config)# ptp clock ordinary domain 0
Router(config-ptp-clk)# clock-port MASTER master
Router(config-ptp-port)# transport ipv4 unicast interface
Loopback11
negotiation
Router(config-ptp-port)# clock destination
20.20.20.20
```

```
Router(config-ptp-port)# Sync interval
-4
Router(config-ptp-port)# end
```

## Configuring an Ordinary Clock as Secondary PTP

This section describes how to configure Ordinary Clock as secondary PTP.

### SUMMARY STEPS

1. **configure terminal**
2. **ptp clock ordinary domain domain\_number**
3. **clock-port name slave**
4. **transport ipv4 unicast interface {GigabitEthernet | Loopback} interface-number [negotiation]**
5. **clock source ip-address**
6. **end**

### DETAILED STEPS

|               | Command or Action                                                                                                                                                                                                 | Purpose                                                                                                                                                                                                                                                                                                                                                           |
|---------------|-------------------------------------------------------------------------------------------------------------------------------------------------------------------------------------------------------------------|-------------------------------------------------------------------------------------------------------------------------------------------------------------------------------------------------------------------------------------------------------------------------------------------------------------------------------------------------------------------|
| <b>Step 1</b> | <b>configure terminal</b><br><b>Example:</b><br>Router# <b>configure terminal</b>                                                                                                                                 | Enters global configuration mode.                                                                                                                                                                                                                                                                                                                                 |
| <b>Step 2</b> | <b>ptp clock ordinary domain domain_number</b><br><b>Example:</b><br>Router(config)# <b>ptp clock ordinary domain 0</b>                                                                                           | Creates a PTP clock and specifies the clock mode.                                                                                                                                                                                                                                                                                                                 |
| <b>Step 3</b> | <b>clock-port name slave</b><br><b>Example:</b><br>Router(config-ptp-clk)# <b>clock-port SLAVE slave</b>                                                                                                          | Specifies the clocking mode of a PTP port and enters the clock port configuration mode.                                                                                                                                                                                                                                                                           |
| <b>Step 4</b> | <b>transport ipv4 unicast interface {GigabitEthernet   Loopback} interface-number [negotiation]</b><br><b>Example:</b><br>Router(config-ptp-port)# <b>transport ipv4 unicast interface Loopback22 negotiation</b> | Specifies the IP version, transmission mode, and interface that a PTP clock port uses to exchange timing packets.<br><br>The <b>negotiation</b> keyword specifies the unicast negotiation mode where the secondary and primary clock exchanges negotiation messages before establishing a relationship.<br><b>Note</b> Only Loopback interface type is supported. |
| <b>Step 5</b> | <b>clock source ip-address</b><br><b>Example:</b><br>Router(config-ptp-port)# <b>clock source 10.10.10.10</b>                                                                                                     | Specifies the source IP address of a primary PTP clock.<br><b>Note</b> You can specify only 1 primary clock IP address. Priority-based clock source selection is not supported.                                                                                                                                                                                   |

|        | Command or Action                                                     | Purpose                          |
|--------|-----------------------------------------------------------------------|----------------------------------|
| Step 6 | <b>end</b><br><b>Example:</b><br>Router(config-ptp-port) # <b>end</b> | Exits global configuration mode. |

## Examples

The following example shows how to configure an ordinary clock as secondary PTP:

```
Router# configure terminal
Router(config)# ptp clock ordinary domain 0
Router(config-ptp-clk)# clock-port SLAVE master
Router(config-ptp-port)# transport ipv4 unicast interface
Loopback22
negotiation
Router(config-ptp-port)# clock source
10.10.10.10
Router(config-ptp-port)# end
```

## Configuring a Boundary Clock

You can configure the primary PTP and secondary PTP in a boundary clock topology as shown in the figure in the same way that you configure a primary and secondary in ordinary clock mode. This section describes how to configure a Cisco ASR 1002-X Router in boundary clock mode.



**Note** Currently, boundary clock supports only unicast negotiation mode.

Figure 9: PTP Boundary Clock Scenario

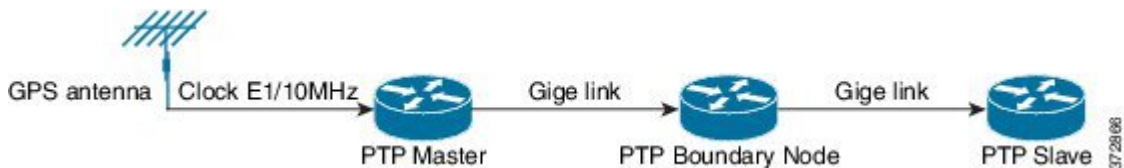

## SUMMARY STEPS

1. **configure terminal**
2. **ptp clock boundary domain** domain\_number
3. **clock-port** name slave
4. **transport ipv4 unicast interface** {GigabitEthernet | Loopback} interface-number [negotiation]
5. **clock source** ip-address
6. **exit**
7. **clock-port** name master
8. **transport ipv4 unicast interface** {GigabitEthernet | Loopback} interface-number [negotiation]
9. **end**

## DETAILED STEPS

|               | Command or Action                                                                                                                                                                                                 | Purpose                                                                                                                                                                                                                                                                                                                                                          |
|---------------|-------------------------------------------------------------------------------------------------------------------------------------------------------------------------------------------------------------------|------------------------------------------------------------------------------------------------------------------------------------------------------------------------------------------------------------------------------------------------------------------------------------------------------------------------------------------------------------------|
| <b>Step 1</b> | <b>configure terminal</b><br><b>Example:</b><br>Router# <b>configure terminal</b>                                                                                                                                 | Enters the global configuration mode.                                                                                                                                                                                                                                                                                                                            |
| <b>Step 2</b> | ptp clock boundary domain domain_number<br><b>Example:</b><br>Router(config)# ptp clock boundary domain 0                                                                                                         | Creates a PTP clock and specifies the clock mode.                                                                                                                                                                                                                                                                                                                |
| <b>Step 3</b> | clock-port name slave<br><b>Example:</b><br>Router(config-ptp-clk)# clock-port SLAVE slave                                                                                                                        | Specifies the clocking mode of a PTP port and enters the clock port configuration mode.                                                                                                                                                                                                                                                                          |
| <b>Step 4</b> | <b>transport ipv4 unicast interface {GigabitEthernet   Loopback} interface-number [negotiation]</b><br><b>Example:</b><br>Router(config-ptp-port)# <b>transport ipv4 unicast interface Loopback11 negotiation</b> | Specifies the IP version, transmission mode, and interface that a PTP clock port uses to exchange timing packets.<br><br>The <b>negotiation</b> keyword specifies the unicast negotiation mode where the secondary and primary clock exchange negotiation messages before establishing a relationship.<br><b>Note</b> Only Loopback interface type is supported. |
| <b>Step 5</b> | <b>clock source ip-address</b><br><b>Example:</b><br>Router(config-ptp-port)# <b>clock source 10.10.10.10</b>                                                                                                     | Specifies the source IP address of a PTP master clock.<br><b>Note</b> You can specify only one primary clock IP address. Priority-based clock source selection is not supported.                                                                                                                                                                                 |
| <b>Step 6</b> | <b>exit</b><br><b>Example:</b><br>Router(config-ptp-port)# <b>exit</b>                                                                                                                                            | Exits clock port configuration mode.                                                                                                                                                                                                                                                                                                                             |
| <b>Step 7</b> | clock-port name master<br><b>Example:</b><br>Router(config-ptp-clk)# clock-port MASTER master                                                                                                                     | Specifies the clocking mode of a PTP port and enters clock port configuration mode.                                                                                                                                                                                                                                                                              |
| <b>Step 8</b> | <b>transport ipv4 unicast interface {GigabitEthernet   Loopback} interface-number [negotiation]</b><br><b>Example:</b><br>Router(config-ptp-port)# <b>transport ipv4 unicast interface Loopback10 negotiation</b> | Specifies the IP version, transmission mode, and interface that a PTP clock port uses to exchange timing packets.<br><br>The <b>negotiation</b> keyword specifies the unicast negotiation mode where the secondary and primary clock exchange negotiation messages before establishing a relationship.<br><b>Note</b> Only Loopback interface type is supported. |

|        | Command or Action                                                                               | Purpose                          |
|--------|-------------------------------------------------------------------------------------------------|----------------------------------|
| Step 9 | <b>end</b><br><b>Example:</b><br><br><b>Example:</b><br><br>Router(config-ptp-port)# <b>end</b> | Exits global configuration mode. |

## Examples

The following example shows how to configure a boundary clock:

```
Router# configure terminal
Router(config)# ptp clock ordinary domain 0
Router(config-ptp-clk)# clock-port SLAVE slave
Router(config-ptp-port)# transport ipv4 unicast interface
Loopback11
negotiation
Router(config-ptp-port)# clock source
10.10.10.10
Router(config-ptp-port)# exit
Router(config-ptp-clk)# clock-port MASTER master
Router(config-ptp-port)# transport ipv4 unicast interface
Loopback10
negotiation
Router(config-ptp-port)# end
```

## Configuring Time of Day

A Cisco ASR 1002-X Router can exchange time of day and 1PPS input with an external device, such as a GPS receiver, using the time of day and 1PPS input and output interfaces on the router.

Perform these tasks to configure Time of Day (ToD) messages on the Cisco ASR 1002-X Router:

### Configuring Input Time-of-Day Messages

This section describes how to configure input time-of-day messages.



---

**Note** You can configure time-of-day input only in a primary PTP clock port.

---

#### SUMMARY STEPS

1. **configure terminal**
2. **ptp clock ordinary domain domain\_number**
3. **tod {R0 | R1} {cisco | ntp}**
4. **input [1pps] { R0 | R1 }**
5. **clock-port name master**
6. **transport ipv4 unicast interface {GigabitEthernet | Loopback} interface-number [negotiation]**

7. `clock destination ip-address`
8. `end`

## DETAILED STEPS

|        | Command or Action                                                                                                                                                                                                       | Purpose                                                                                                                                                                                                                                                                                                                                                      |
|--------|-------------------------------------------------------------------------------------------------------------------------------------------------------------------------------------------------------------------------|--------------------------------------------------------------------------------------------------------------------------------------------------------------------------------------------------------------------------------------------------------------------------------------------------------------------------------------------------------------|
| Step 1 | <b>configure terminal</b><br><b>Example:</b><br>Router# <b>configure terminal</b>                                                                                                                                       | Enters global configuration mode.                                                                                                                                                                                                                                                                                                                            |
| Step 2 | <code>ptp clock ordinary domain domain_number</code><br><b>Example:</b><br>Router(config)# <code>ptp clock ordinary domain 0</code>                                                                                     | Creates a PTP clock and specifies the clock mode.                                                                                                                                                                                                                                                                                                            |
| Step 3 | <code>tod {R0   R1} {cisco   ntp}</code><br><b>Example:</b><br><b>Example:</b><br>Router(config-ptp-clk)# <b>tod R0 ntp</b>                                                                                             | Configures the time-of-day message format used by the 1PPS or BITS interface.<br><b>Note</b> Currently, only R0 1PPS port is supported; R1 is not valid. Also, only ntp mode is supported, not cisco mode.                                                                                                                                                   |
| Step 4 | <code>input [1pps] { R0   R1 }</code><br><b>Example:</b><br>Router(config-ptp-clk)# <b>input 1pps R0</b>                                                                                                                | Enables PTP input clocking using a 1.544-Mhz, 2.048-Mhz, or 10-Mhz timing interface, or phase using the 1PPS or RS-422 interface.<br><b>Note</b> Currently, only R0 1PPS port is supported; R1 is not valid.                                                                                                                                                 |
| Step 5 | <code>clock-port name master</code><br><b>Example:</b><br>Router(config-ptp-clk)# <code>clock-port MASTER master</code>                                                                                                 | Specifies the clocking mode of a PTP port and enters the clock port configuration mode.                                                                                                                                                                                                                                                                      |
| Step 6 | <code>transport ipv4 unicast interface {GigabitEthernet   Loopback} interface-number [negotiation]</code><br><b>Example:</b><br>Router(config-ptp-port)# <b>transport ipv4 unicast interface Loopback11 negotiation</b> | Specifies the IP version, transmission mode, and interface that a PTP clock port uses to exchange timing packets.<br>The <b>negotiation</b> keyword specifies the unicast negotiation mode where the secondary and primary clock exchange negotiation messages before establishing a relationship.<br><b>Note</b> Only Loopback interface type is supported. |
| Step 7 | <code>clock destination ip-address</code><br><b>Example:</b><br>Router(config-ptp-port)# <b>clock destination 20.20.20.20</b>                                                                                           | Specifies the IP address of a PTP clock destination.<br>If the clock port is set to primary mode with unicast negotiation, you need not use this command because the device uses negotiation to determine the IP address of secondary PTP devices.                                                                                                           |

|               | Command or Action                                                     | Purpose                          |
|---------------|-----------------------------------------------------------------------|----------------------------------|
| <b>Step 8</b> | <b>end</b><br><b>Example:</b><br>Router(config-ptp-port) # <b>end</b> | Exits global configuration mode. |

### What to do next

#### Examples

The following example shows how to configure input time-of-day messages:

```

Router# configure terminal
Router(config)# ptp clock ordinary domain 0
Router(config-ptp-clk)# tod R0 ntp
Router(config-ptp-clk)# input
lpps R0
Router(config-ptp-clk)# clock-port MASTER master
Router(config-ptp-port)# transport ipv4 unicast interface
Loopback11
negotiation
Router(config-ptp-port)# clock destination
20.20.20.20

Router(config-ptp-port)# end

```

## Configuring Output Time-of-Day Messages

This section describes how to configure output time-of-day messages.



**Note** You can configure ToD output only on secondary PTP clock ports.

### SUMMARY STEPS

1. **configure terminal**
2. **ptp clock ordinary domain domain\_number**
3. **tod {R0 | R1} {cisco | ntp}**
4. **output [lpps] { R0 | R1 }**
5. **clock-port name slave**
6. **transport ipv4 unicast interface {GigabitEthernet | Loopback} interface-number [negotiation]**
7. **clock source ip-address**
8. **end**

### DETAILED STEPS

|               | Command or Action                            | Purpose                           |
|---------------|----------------------------------------------|-----------------------------------|
| <b>Step 1</b> | <b>configure terminal</b><br><b>Example:</b> | Enters global configuration mode. |



|               | Command or Action                                                                                                                                                                                          | Purpose                                                                                                                                                                                                                                                                                                                                                      |
|---------------|------------------------------------------------------------------------------------------------------------------------------------------------------------------------------------------------------------|--------------------------------------------------------------------------------------------------------------------------------------------------------------------------------------------------------------------------------------------------------------------------------------------------------------------------------------------------------------|
|               | Router# <b>configure terminal</b>                                                                                                                                                                          |                                                                                                                                                                                                                                                                                                                                                              |
| <b>Step 2</b> | ptp clock ordinary domain domain_number<br><b>Example:</b><br>Router(config)# ptp clock ordinary domain 0                                                                                                  | Creates a PTP clock and specifies the clock mode.                                                                                                                                                                                                                                                                                                            |
| <b>Step 3</b> | tod {R0   R1} {cisco   ntp}<br><b>Example:</b><br><b>Example:</b><br>Router(config-ptp-clk)# <b>tod R0 ntp</b>                                                                                             | Configures the time-of-day message format used by the 1PPS or BITS interface.<br><b>Note</b> Currently, only R0 1PPS port is supported; R1 is not valid. Also, only ntp mode is supported, not cisco mode.                                                                                                                                                   |
| <b>Step 4</b> | output [1pps] { R0   R1 }<br><b>Example:</b><br>Router(config-ptp-clk)# <b>output R0 ntp</b>                                                                                                               | Enables output of time-of-day messages using a 1PPS interface.<br><b>Note</b> Currently, only R0 1PPS port is supported; R1 is not valid.                                                                                                                                                                                                                    |
| <b>Step 5</b> | clock-port name slave<br><b>Example:</b><br>Router(config-ptp-clk)# clock-port SLAVE slave                                                                                                                 | Specifies the clocking mode of a PTP port and enters the clock port configuration mode.                                                                                                                                                                                                                                                                      |
| <b>Step 6</b> | transport ipv4 unicast interface {GigabitEthernet   Loopback} interface-number [negotiation]<br><b>Example:</b><br>Router(config-ptp-port)# <b>transport ipv4 unicast interface Loopback11 negotiation</b> | Specifies the IP version, transmission mode, and interface that a PTP clock port uses to exchange timing packets.<br>The <b>negotiation</b> keyword specifies the unicast negotiation mode where the secondary and primary clock exchange negotiation messages before establishing a relationship.<br><b>Note</b> Only Loopback interface type is supported. |
| <b>Step 7</b> | clock source ip-address<br><b>Example:</b><br>Router(config-ptp-port)# <b>clock source 10.10.10.10</b>                                                                                                     | Specifies the source IP address of a PTP master clock.<br><b>Note</b> You can specify only 1 primary clock IP address. Priority-based clock source selection is not supported.                                                                                                                                                                               |
| <b>Step 8</b> | end<br><b>Example:</b><br><b>Example:</b><br>Router(config-ptp-port)# <b>end</b>                                                                                                                           | Exits global configuration mode.                                                                                                                                                                                                                                                                                                                             |

## What to do next

### Examples

The following example shows how to configure output time-of-day messages:

```

Router# configure terminal
Router(config)# ptp clock ordinary domain 0
Router(config-ptp-clk)# tod R0 ntp
Router(config-ptp-clk)# output
lpps R0
Router(config-ptp-clk)# clock-port MASTER master
Router(config-ptp-port)# transport ipv4 unicast interface
Loopback11
negotiation
Router(config-ptp-port)# clock source
10.10.10.10
Router(config-ptp-port)# end

```

## Configuration Examples for IEEE 1588v2 PTP on a Cisco ASR1002-X Router

This example shows how to configure IEEE 1588v2 PTP on a Cisco ASR1002-X Router:

### Unicast Negotiation Mode

#### Master Clock

```

ptp clock ordinary domain 1
tod R0 ntp
input lpps R0
clock-port MASTER master
transport ipv4 unicast interface loopback 0 negotiation

```

#### Slave clock

```

ptp clock ordinary domain 1
tod R0 ntp
output lpps R0
clock-port SLAVE slave
transport ipv4 unicast interface loopback 0 negotiation
clock source 10.1.1.1

```

#### Boundary clock

```

ptp clock boundary domain 1
clock-port SLAVE slave
transport ipv4 unicast interface loopback 0 negotiation
clock source 10.1.1.1
clock-port MASTER master
transport ipv4 unicast interface loopback 1 negotiation

```

### Unicast Mode

#### Master Clock

```

ptp clock ordinary domain 1
tod R0 ntp
input lpps R0
clock-port MASTER master
transport ipv4 unicast interface loopback 0
clock destination 20.1.1.1

```

#### Slave clock

```

ptp clock ordinary domain 1
tod R0 ntp

```

```

output lpps R0
clock-port SLAVE slave
transport ipv4 unicast interface loopback 0
clock source 10.1.1.1

```

## Verifying the IEEE 1588v2 PTP Configuration

Use the following commands to verify the IEEE 1588v2 PTP configuration:

- Use the **show ptp clock running domain 0** command to display the output:

```
Router# show ptp clock running domain 0
```

On the **MASTER**:

```

 PTP Ordinary Clock [Domain 0]
 State Ports Pkts sent Pkts rcvd Redundancy Mode
 FREQ_LOCKED 1 31522149 10401171 Hot standby

```

PORT SUMMARY

| Name   | Tx Mode | Role   | Transport | State  | Sessions | PTP Master Port Addr |
|--------|---------|--------|-----------|--------|----------|----------------------|
| MASTER | unicast | master | Lo1       | Master | 1        | -                    |

SESSION INFORMATION

```

MASTER [Lo1] [Sessions 1]
Peer addr Pkts in Pkts out In Errs Out Errs
11.11.11.11 10401171 31522149 0 0

```

On the **SLAVE**:

```

 PTP Ordinary Clock [Domain 0]
 State Ports Pkts sent Pkts rcvd Redundancy Mode
 PHASE_ALIGNED 1 4532802 13357682 Track one

```

PORT SUMMARY

| Name  | Tx Mode | Role  | Transport | State | Sessions | PTP Master Port Addr |
|-------|---------|-------|-----------|-------|----------|----------------------|
| SLAVE | unicast | slave | Lo20      | Slave | 1        | 10.10.10.10          |

SESSION INFORMATION

```

SLAVE [Lo20] [Sessions 1]
Peer addr Pkts in Pkts out In Errs Out Errs
10.10.10.10 13357682 4532802 0 0

```

- Use the **show platform software ptp tod** command to check the time-of-day information:

```

PTPd ToD information:
Time: 06/24/14 02:06:29

```

- Use the **show platform ptp tod all** command to check the time-of-day state:

```
Router# show platform ptp tod all
```

On the **MASTER**

```

ToD/1PPS Info for : R0

```

```

RJ45 JACK TYPE : RS422
ToD CONFIGURED : YES
ToD FORMAT : NTPv4
ToD DELAY : 0
1PPS MODE : INPUT
1PPS STATE : UP
ToD STATE : UP

```

On the **SLAVE**:

```

ToD/1PPS Info for : R0

```

```

RJ45 JACK TYPE : RS422
ToD CONFIGURED : YES
ToD FORMAT : NTPv4
ToD DELAY : 0
1PPS MODE : OUTPUT
OFFSET : 0
PULSE WIDTH : 0

```

## Additional References

### MIBs

| MIB  | MIBs Link                                                                                                                                                                                              |
|------|--------------------------------------------------------------------------------------------------------------------------------------------------------------------------------------------------------|
| None | To locate and download MIBs for selected platforms, Cisco IOS releases, and feature sets, use Cisco MIB Locator found at this URL:<br><br>{start hypertext}http://www.cisco.com/go/mibs{end hypertext} |

### Technical Assistance

| Description                                                                                                                                                                                                                                                                                                                                                                           | Link                                                                              |
|---------------------------------------------------------------------------------------------------------------------------------------------------------------------------------------------------------------------------------------------------------------------------------------------------------------------------------------------------------------------------------------|-----------------------------------------------------------------------------------|
| The Cisco Support and Documentation website provides online resources to download documentation, software, and tools. Use these resources to install and configure the software and to troubleshoot and resolve technical issues with Cisco products and technologies. Access to most tools on the Cisco Support and Documentation website requires a Cisco.com user ID and password. | {start hypertext}http://www.cisco.com/cisco/web/support/index.html{end hypertext} |

## Feature Information for IEEE 1588v2 PTP Support

{start cross reference} Table 13-2 {end cross reference} lists the features in this module and provides links to specific configuration information.

Use Cisco Feature Navigator to find information about platform support and software image support. Cisco Feature Navigator enables you to determine which software images support a specific software release, feature set, or platform. To access Cisco Feature Navigator, go to {start hypertext}http://www.cisco.com/go/cfn{end hypertext}. An account on Cisco.com is not required.



---

**Note** {start cross reference}Table 13-2{end cross reference} lists only the software release that introduced support for a given feature in a given software release train. Unless noted otherwise, subsequent releases of that software release train also support that feature.

---

**Table 39: Feature Information for Network Synchronization Support**

| Feature Name            | Releases           | Feature Information                                                                         |
|-------------------------|--------------------|---------------------------------------------------------------------------------------------|
| IEEE 1588v2 PTP Support | Cisco IOS XE 3.13S | In Cisco IOS XE Release 3.13S, this feature was introduced on the Cisco ASR 1002-X Routers. |





## CHAPTER 18

# Configuring Bridge Domain Interfaces

The Cisco ASR 1000 Series Aggregation Services Routers support the bridge domain interface (BDI) feature for packaging Layer 2 Ethernet segments into Layer 3 IP address.

- [Restrictions for Bridge Domain Interfaces, on page 441](#)
- [Information About Bridge Domain Interface, on page 442](#)
- [Configuring Bridge-Domain Virtual IP Interface, on page 451](#)
- [Additional References, on page 457](#)
- [Feature Information for Configuring Bridge Domain Interfaces, on page 457](#)

## Restrictions for Bridge Domain Interfaces

The following are the restrictions pertaining to bridge domain interfaces:

- Only 4096 bridge domain interfaces are supported per system.
- For a bridge domain interface, the maximum transmission unit (MTU) size can be configured between 1500 and 9216 bytes.
- Bridge domain interfaces support only the following features:
  - IPv4 Multicast
  - QoS marking and policing. Shaping and queuing are not supported
  - IPv4 and IPv6 VRF
  - IPv4 and IPv6 unicast forwarding
  - Dynamic routing such as BGP, OSPF, EIGRP, RIP, IS-IS, and STATIC
  - Hot Standby Router Protocol (HSRP) from IOS XE 3.8.0 onwards.
  - Virtual Router Redundancy Protocol (VRRP) from IOS XE 3.8.0 onwards.
  - Flexible NetFlow



---

**Note** Flexible NetFlow is supported from Cisco IOS XE 17.7.1a and later releases.

---

- Bridge domain interfaces do not support the following features:
  - PPP over Ethernet (PPPoE)
  - Bidirectional Forwarding Detection (BFD) protocol
  - QoS
  - Network-Based Application Recognition (NBAR) or Advanced Video Coding (AVC)



---

**Note** NAT is supported from XE16.2.1 and later releases.

---

## Information About Bridge Domain Interface

Bridge domain interface is a logical interface that allows bidirectional flow of traffic between a Layer 2 bridged network and a Layer 3 routed network traffic. Bridge domain interfaces are identified by the same index as the bridge domain. Each bridge domain represents a Layer 2 broadcast domain. Only one bridge domain interface can be associated with a bridge domain.

Bridge domain interface supports the following features:

- IP termination
- Layer 3 VPN termination
- Address Resolution Protocol (ARP), G-ARP, and P-ARP handling
- MAC address assignment

Prior to configuring a bridge domain interface, you must understand the following concepts:

- Ethernet Virtual Circuit Overview
- Bridge Domain Interface Encapsulation
- Assigning a MAC Address
- Support for IP Protocols
- Support for IP Forwarding
- Packet Forwarding
- Bridge Domain Interface Statistics

## Ethernet Virtual Circuit Overview

An Ethernet Virtual Circuit (EVC) is an end-to-end representation of a single instance of a Layer 2 service that is offered by a provider. It embodies the different parameters on which the service is being offered. In the Cisco EVC Framework, the bridge domains are made up of one or more Layer 2 interfaces known as service instances. A service instance is the instantiation of an EVC on a given port on a given router. Service instance is associated with a bridge domain based on the configuration.



An incoming frame can be classified as service instance based on the following criteria:

- Single 802.1Q VLAN tag, priority-tagged, or 802.1ad VLAN tag
- Both QinQ (inner and outer) VLAN tags, or both 802.1ad S-VLAN and C-VLAN tags
- Outer 802.1p CoS bits, inner 802.1p CoS bits, or both
- Payload Ethernet type (five choices are supported: IPv4, IPv6, PPPoE-all, PPOE-discovery, and PPPoE-session)

Service instance also supports alternative mapping criteria:

- Untagged—Mapping to all the frames lacking a 802.1Q or 802.1ad header
- Default—Mapping to all the frames

For more information on the EVC architecture, see the section *Configuring Ethernet Virtual Connections on the Cisco ASR 1000 Router* in the [Carrier Ethernet Configuration Guide](#).

## Bridge Domain Interface Encapsulation

Security Group classification includes both Source and Destination Group, which is specified by source SGT and DGT. SGT Based PBR feature provides the PBR route-map match clause for SGT/DGT based packet classification. SGT Based PBR feature supports configuration of unlimited number of tags, but it is recommended to configure the tags based on memory available in the platform.

An EVC provides the ability to employ different encapsulations on each Ethernet flow point (EFP) present in a bridge domain. A BDI egress point may not be aware of the encapsulation of an egress packet because the packet may have egressed from one or more EFPs with different encapsulations.

In a bridge domain, if all the EFPs have different encapsulations, the BDI must be untagged (using the no 802.1Q tag). Encapsulate all the traffic in the bridge domain (popped or pushed) at the EFPs. Configure rewrite at each EFP to enable encapsulation of the traffic on the bridge domain.

In a bridge domain, if all the EFPs have the same encapsulation, configure the encapsulations on the BDI using the encapsulation command. Enabling encapsulation at the BDI ensures effective pushing or popping of tags, thereby eliminating the need for configuring the rewrite command at the EFPs. For more information on configuring the encapsulations on the BDI, see the [How to Configure a Bridge Domain Interface](#).

## Assigning a MAC Address

All the bridge domain interfaces on the Cisco ASR 1000 chassis share a common MAC address. The first bridge domain interface on a bridge domain is allocated a MAC address. Thereafter, the same MAC address is assigned to all the bridge domain interfaces that are created in that bridge domain.



---

**Note** You can configure a static MAC address on a bridge domain interface using the **mac-address** command.

---

## Support for IP Protocols

Bridge domain interfaces enable the Cisco ASR 1000 Series Aggregation Services Routers to act as a Layer 3 endpoint on the Layer 2 bridge domain for the following IP-related protocols:

- ARP
- DHCP
- HTTP
- ICMP
- NTP
- RARP
- SNMP
- TCP
- Telnet
- TFTP
- UDP

## Support for IP Forwarding

Bridge domain interface supports the following IP forwarding features:

- IPv4 input and output access control lists (ACL)
- IPv4 input and output QoS policies. The operations supported for the input and output service policies on a bridge domain interface are:
  - Classification
  - Marking
  - Policing
- IPv4 L3 VRFs

## Packet Forwarding

A bridge domain interface provides bridging and forwarding services between the Layer 2 and Layer 3 network infrastructure.

### Layer 2 to Layer 3

During a packet flow from a Layer 2 network to a Layer 3 network, if the destination MAC address of the incoming packet matches the bridge domain interface MAC address, or if the destination MAC address is a multicast address, the packet or a copy of the packet is forwarded to the bridge domain interface.



---

**Note** MAC address learning cannot not be performed on the bridge domain interface.

---

## Layer 3 to Layer 2

When a packet arrives at a Layer 3 physical interface of a router, a route lookup action is performed. If route lookup points to a bridge domain interface, then the bridge domain interface adds the layer 2 encapsulation and forwards the frame to the corresponding bridge domain. The byte counters are updated.

During a Layer 2 lookup on a bridge domain to which the bridge domain interface belongs, the bridge domain forwards the packets to the correct service instance based on the destination MAC address.

## Link States of a Bridge Domain and a Bridge Domain Interface

Bridge domain interface acts as a routable IOS interface on Layer 3 and as a port on a bridge domain. Both bridge domain interfaces and bridge domains operate with individual administrative states.

Shutting down a bridge domain interface stops the Layer 3 data service, but does not override or impact the state of the associated bridge domain.

Shutting down a bridge domain stops Layer 2 forwarding across all the associated members including service instances and bridge domain interfaces. The associated service instances influence the operational state of a bridge domain. Bridge domain interface cannot be operational unless one of the associated service instances is up.



---

**Note** Because a bridge domain interface is an internal interface, the operational state of bridge domain interface does not affect the bridge domain operational state.

---

## BDI Initial State

The initial administrative state of a BDI depends on how the BDI is created. When you create a BDI at boot time in the startup configuration, the default administrative state for the BDI is up. It will remain in this state unless the startup configuration includes the shutdown command. This behavior is consistent with all the other interfaces. When you create a BDI dynamically at command prompt, the default administrative state is down.

## BDI Link State

A BDI maintains a link state that comprises of three states: administratively down, operationally down, and up. The link state of a BDI is derived from two independent inputs: the BDI administrative state set by the corresponding users and the fault indication state from the lower levels of the interface states. It defines a BDI link state based on the state of the two inputs.

| Fault Indication State             | BDI Admin       |                    |
|------------------------------------|-----------------|--------------------|
| {start emdash} {end emdash}        | <b>Shutdown</b> | <b>No Shutdown</b> |
| <b>No faults asserted</b>          | Admin-down      | Up                 |
| <b>At least one fault asserted</b> | Admin-down      | Operationally-Down |

## Bridge Domain Interface Statistics

For virtual interfaces, such as the bridge domain interface, protocol counters are periodically queried from the QFP.

When packets flow from a Layer 2 bridge domain network to a Layer 3 routing network through the bridge domain interface, the packets are treated as bridge domain interface input packets and bytes. When packets arrive at a Layer 3 interface and are forwarded through the bridge domain interface to a Layer 2 bridge domain, the packets are treated as output packets and bytes, and the counters are updated accordingly.

A BDI maintains a standard set of Layer 3 packet counters as the case with all Cisco IOS interfaces. Use the `show interface` command to view the Layer 3 packet counters.

The convention of the counters is relative to the Layer 3 cloud. For example, input refers to the traffic entry to the Layer 3 cloud from the Layer 2 BD, while output refers to the traffic exit from the Layer 3 cloud to the Layer 2 BD.

Use the `show interfaces accounting` command to display the statistics for the BDI status. Use the `show interface <if-name>` command to display the overall count of the packets and bytes that are transmitted and received.

## Creating or Deleting a Bridge Domain Interface

When you define an interface or subinterface for a Cisco IOS router, you name it and specify how it is assigned an IP address. You can create a bridge domain interface before adding a bridge domain to the system. This new bridge domain interface will be activated after the associated bridge domain is configured.



---

**Note** When a bridge domain interface is created, a bridge domain is automatically created.

---

When you create the bridge domain interface and the bridge domain, the system maintains the required associations for mapping the bridge domain-bridge domain interface pair.

The mapping of bridge domain and bridge domain interface is maintained in the system. The bridge domain interface uses the index of the associated bridge domain to show the association.

## Bridge Domain Interface Scalability

The following table lists the bridge domain interface scalability numbers, based on the type of Cisco ASR 1000 Series Aggregation Services Router's Forwarding Processors.

*Table 40: Bridge Domain Interface Scalability Numbers Based on the Type of Cisco ASR 1000 Series Aggregation Services Router's Forwarding Processor*

| Description                                 | ASR1000-ESP5,ASR 1001,ASR 1002-F (ESP2.5) | ASR1000-ESP10,ASR1000-ESP10-N,ASR1000-ESP20 | ASR1000-ESP40 |
|---------------------------------------------|-------------------------------------------|---------------------------------------------|---------------|
| Maximum bridge domain interfaces per router | 4096                                      | 4096                                        | 4096          |

## Bridge-Domain Virtual IP Interface

The Virtual IP Interface (VIF) feature helps to associate multiple BDI interfaces with a BD instance. The BD-VIF interface inherits all the existing L3 features of IOS logical IP interface.



---

**Note** You must configure every BD-VIF interface with a unique MAC address and it should belong to a different VRF.

---

The Virtual IP Interface (VIF) feature has the following limitations:

- BD-VIF interface does not support IP multicast.
- Number of BD-VIF interfaces with automatically generated MAC address varies on the basis of platforms.
- BD-VIF Interface does not support MPLS.
- The maximum number of BD-VIF interfaces per bridge-domain and the total number of BD-VIF interface for per system vary based on the type of platforms.

The maximum number of BD-VIF supported on different platforms varies:

- ASR 1000 supports maximum 100 BD-VIF for a Bridge Domain
- CSR 1000v supports maximum 16 BD-VIF for a Bridge Domain
- ISR 4000 support maximum 16 BD-VIF for a Bridge Domain

From Cisco IOS XE 17.7.1a release, BD-VIF supports [Flexible Netflow \(FNF\)](#).

## How to Configure a Bridge Domain Interface

To configure a bridge domain interface, perform the following steps:

### SUMMARY STEPS

1. **enable**
2. **configure terminal**
3. **interface BDI** *{interface number}*
4. **encapsulation** *encapsulation dot1q <first-tag> [second-dot1q <second-tag>]*
5. Do one of the following:
6. **match security-group destination tag** *sgt-number*
7. **mac address** *{mac-address}*
8. **no shut**
9. **shut**

## DETAILED STEPS

|               | Command or Action                                                                                                                                                                                                                                                                                                                                                                                                                       | Purpose                                                                                             |
|---------------|-----------------------------------------------------------------------------------------------------------------------------------------------------------------------------------------------------------------------------------------------------------------------------------------------------------------------------------------------------------------------------------------------------------------------------------------|-----------------------------------------------------------------------------------------------------|
| <b>Step 1</b> | <b>enable</b><br><b>Example:</b><br><pre>Router&gt; enable</pre>                                                                                                                                                                                                                                                                                                                                                                        | Enables privileged EXEC mode. Enter your password, if prompted.                                     |
| <b>Step 2</b> | <b>configure terminal</b><br><b>Example:</b><br><pre>Router# configure terminal</pre>                                                                                                                                                                                                                                                                                                                                                   | Enters global configuration mode.                                                                   |
| <b>Step 3</b> | <b>interface BDI</b> <i>{interface number}</i><br><b>Example:</b><br><pre>Router(config-if)# interface BDI3</pre>                                                                                                                                                                                                                                                                                                                       | Specifies a bridge domain interface.                                                                |
| <b>Step 4</b> | <b>encapsulation</b> <i>encapsulation dot1q &lt;first-tag&gt; [second-dot1q &lt;second-tag&gt;]</i><br><b>Example:</b><br><pre>Router(config-if)# encapsulation dot1Q 1 second-dot1q 2</pre>                                                                                                                                                                                                                                            | Defines the encapsulation type.<br>The example shows how to define dot1q as the encapsulation type. |
| <b>Step 5</b> | Do one of the following:<br><b>Example:</b><br><pre>ip address ip-address mask</pre> <b>Example:</b><br><b>Example:</b><br><pre>ipv6 address {X:X:X:X::X link-local   X:X:X:X::X/prefix [anycast   eui-64]   autoconfig [default]}</pre> <b>Example:</b><br><pre>Router(config-if)# ip address 10.2.2.1 255.255.255.0</pre> <b>Example:</b><br><b>Example:</b><br><pre>Router(config-if)# ipv6 address AB01:CD1:123:C::/64 eui-64</pre> | Specifies either the IPv4 or IPv6 address for the bridge domain interface.                          |
| <b>Step 6</b> | <b>match security-group destination tag</b> <i>sgt-number</i><br><b>Example:</b>                                                                                                                                                                                                                                                                                                                                                        | Configures the value for security-group destination security tag.                                   |

|               | Command or Action                                                                           | Purpose                                                    |
|---------------|---------------------------------------------------------------------------------------------|------------------------------------------------------------|
|               | Router(config-route-map)# match security-group destination tag 150                          |                                                            |
| <b>Step 7</b> | <b>mac address {mac-address}</b><br><b>Example:</b><br>Router(config-if)# mac-address 1.1.3 | Specifies the MAC address for the bridge domain interface. |
| <b>Step 8</b> | <b>no shut</b><br><b>Example:</b><br>Router(config-if)# no shut                             | Enables the bridge domain interface.                       |
| <b>Step 9</b> | <b>shut</b><br><b>Example:</b><br>Router(config-if)# shut                                   | Disables the bridge domain interface.                      |

## Example

The following example shows the configuration of a bridge domain interface at IP address 10.2.2.1 255.255.255.0:

```
Router# configure terminal
Router(config)# interface BDI3
Router(config-if)# encapsulation dot1q 1 second-dot1q 2
Router(config-if)# ip address 10.2.2.1 255.255.255.0
Router(config-if)# mac-address 1.1.3
Router(config-if)# no shut
Router(config-if)# exit
```

## Displaying and Verifying Bridge Domain Interface Configuration

### SUMMARY STEPS

1. enable
2. show interfaces bdi
3. show platform software interface fp active name
4. show platform hardware qfp active interface if-name
5. debug platform hardware qfp feature
6. platform trace runtime process forwarding-manager module
7. platform trace boottime process forwarding-manager module interfaces

## DETAILED STEPS

|               | Command or Action                                                                                                                                                                                                      | Purpose                                                                                                                                                        |
|---------------|------------------------------------------------------------------------------------------------------------------------------------------------------------------------------------------------------------------------|----------------------------------------------------------------------------------------------------------------------------------------------------------------|
| <b>Step 1</b> | <b>enable</b><br><b>Example:</b><br>Router> <b>enable</b>                                                                                                                                                              | Enables privileged EXEC mode. Enter your password, if prompted.                                                                                                |
| <b>Step 2</b> | <b>show interfaces bdi</b><br><b>Example:</b><br>Router# <b>show interfaces BDI3</b>                                                                                                                                   | Displays the configuration summary of the corresponding BDI.                                                                                                   |
| <b>Step 3</b> | <b>show platform software interface fp active name</b><br><b>Example:</b><br>Router# <b>show platform software interface fp active name BDI4</b>                                                                       | Displays the bridge domain interface configuration in a Forwarding Processor.                                                                                  |
| <b>Step 4</b> | <b>show platform hardware qfp active interface if-name</b><br><b>Example:</b><br>Router# <b>show platform hardware qfp active interface if-name BDI4</b>                                                               | Displays the bridge domain interface configuration in a data path.                                                                                             |
| <b>Step 5</b> | <b>debug platform hardware qfp feature</b><br><b>Example:</b><br>Router# <b>debug platform hardware qfp active feature l2bd client all</b>                                                                             | The selected CPP L2BD Client debugging is on.                                                                                                                  |
| <b>Step 6</b> | <b>platform trace runtime process forwarding-manager module</b><br><b>Example:</b><br>Router(config)# <b>platform trace runtime slot F0 bay 0 process forwarding-manager module interfaces level info</b>              | Enables the Forwarding Manager Route Processor and Embedded Service Processor trace messages for the Forwarding Manager process.                               |
| <b>Step 7</b> | <b>platform trace boottime process forwarding-manager module interfaces</b><br><b>Example:</b><br>Router(config)# <b>platform trace boottime slot R0 bay 1 process forwarding-manager forwarding-manager level max</b> | Enables the Forwarding Manager Route Processor and Embedded Service Processor trace messages for the Route Processor Forwarding Manager process during bootup. |



**What to do next**

For additional information on the commands and the options available with each command, see the [Cisco IOS Configuration Fundamentals Command Reference Guide](#).

## Configuring Bridge-Domain Virtual IP Interface

```
enable
configure terminal
[no] interface BD-VIF interface-number
 [[no] vrf forwarding vrf-name]
 [[no] mac address mac-address]
 [[no] ip address ip-address mask]
 [[no] ipv6 address {X:X:X:X::X link-local| X:X:X:X::X/prefix [anycast | eui-64] |
 autoconfig [default]}]
exit
```

To delete BD-VIF interface, use the 'no' form of the command.

## Associating VIF Interface with a Bridge Domain

```
enable
configure terminal
bridge-domain bridge-domain number
[no] member BD-VIF interface-number
exit
```

To dissociate the VIF interface, use the 'no' form of the command.

## Verifying Bridge-Domain Virtual IP Interface

All existing show commands for interface and IP interface can be used for the BD-VIF interface.

```
show interface bd-vif bd-vif-id
show ip interface bd-vif bd-vif-id
show bd-vif interfaces in fman-fp
show pla sof inter fp ac brief | i BD_VIF
```

## Example Configuration Bridge-Domain Virtual IP Interface

Detail sample:

```
interface Port-channell
mtu 9000
no ip address
!Ethernet service endpoint one per neutron network
service instance 1756 ethernet
 description 4e8e5957-649f-477b-9e5b-f1f75b21c03c
 encapsulation dot1q 1756
 rewrite ingress tag pop 1 symmetric
 bridge-domain 1756
!
```

```

interface BD-VIF5001
no shutdown
vrf forwarding vrf5001
ip address 10.0.0.1 255.255.255.0
interface BD-VIF5002
no shutdown
vrf forwarding vrf5002
ip address 10.0.0.2 255.255.255.0

bridge-domain 1756
member Port-channell service-instance 1756
member bd-vif5001
member bd-vif5002

```

## Configuring Flexible NetFlow over a Bridge Domain Virtual IP Interface

### SUMMARY STEPS

1. **enable**
2. **configure terminal**
3. **interface** *type number*
4. **{ip | ipv6} flow monitor** *monitor-name* [**sampler** *sampler-name*] **{input | output}**
5. **exit**

### DETAILED STEPS

|               | Command or Action                                                                                                                                                                                           | Purpose                                                                                                               |
|---------------|-------------------------------------------------------------------------------------------------------------------------------------------------------------------------------------------------------------|-----------------------------------------------------------------------------------------------------------------------|
| <b>Step 1</b> | <b>enable</b><br><br><b>Example:</b><br><br>Device> enable                                                                                                                                                  | Enables privileged EXEC mode. Enter your password, if prompted.                                                       |
| <b>Step 2</b> | <b>configure terminal</b><br><br><b>Example:</b><br><br>Device# configure terminal                                                                                                                          | Enters global configuration mode.                                                                                     |
| <b>Step 3</b> | <b>interface</b> <i>type number</i><br><br><b>Example:</b><br><br>Device (config)# interface BD-VIF 100                                                                                                     | Specifies an interface and enters interface configuration mode. Enter the BD-VIF number.                              |
| <b>Step 4</b> | <b>{ip   ipv6} flow monitor</b> <i>monitor-name</i> [ <b>sampler</b> <i>sampler-name</i> ] <b>{input   output}</b><br><br><b>Example:</b><br><br>Device(config-if)# ip flow monitor FLOW-MONITOR-1<br>input | Enables a Flexible NetFlow flow monitor for IP traffic that the router is receiving or transmitting on the interface. |
| <b>Step 5</b> | <b>exit</b><br><br><b>Example:</b><br><br>Device(config-if)# exit                                                                                                                                           | Exits interface configuration mode and returns to privileged EXEC mode.                                               |

## Examples: Flexible NetFlow over a Bridge Domain Virtual IP Interface

The following is a sample output for the **show platform hardware qfp active interface if-name** command showing the QFP information and flow direction for flow monitors. The table below provides the key to the CLI output.

| Configuration                           | Output                                       |
|-----------------------------------------|----------------------------------------------|
| ip flow monitor <monitor-name> input    | IPV4_INPUT_FNF_FIRST<br>IPV4_INPUT_FNF_FINAL |
| ip flow monitor <monitor-name> output   | IPV4_BDI_OUTPUT_FNF_FINAL                    |
| ipv6 flow monitor <monitor-name> input  | IPV6_INPUT_FNF_FIRST<br>IPV6_INPUT_FNF_FINAL |
| ipv6 flow monitor <monitor-name> output | IPV6_BDI_OUTPUT_FNF_FINAL                    |

```
Device# show run interface bd-vif2
Building configuration...
```

```
Current configuration: 227 bytes
!
interface BD-VIF2
vrf forwarding vrf1
ip flow monitor test1 input
ip flow monitor test1 output
ip address 10.11.11.11 255.255.255.0
ipv6 flow monitor test2 input
ipv6 flow monitor test2 output
ipv6 address 2001:DB8::1/32
end
```

```
Device# show platform hardware qfp active interface if-name BD-VIF 2
```

```
General interface information
Interface Name: BD-VIF2
Interface state: VALID
Platform interface handle: 20
QFP interface handle: 17
Rx uidb: 262138
Tx uidb: 262127
Channel: 0
Interface Relationships

BGPPA/QPPB interface configuration information
Ingress: BGPPA/QPPB not configured. flags: 0000
Egress: BGPPA not configured. flags: 0000
```

```
ipv4_input enabled.
ipv4_output enabled.
ipv6_input enabled.
ipv6_output enabled.
layer2_input enabled.
layer2_output enabled.
ess_ac_input enabled.
```

```
Features Bound to Interface:
2 GIC FIA state
66 PUNT INJECT DB
70 cpp_l2bd_svr
```

```

43 icmp_svr
45 ipfrag_svr
46 ipreass_svr
47 ipv6reass_svr
44 icmp6_svr
58 stile
Protocol 0 - ipv4_input
FIA handle - CP:0x55a7f59df038 DP:0x3fff1000
 IPV4_INPUT_DST_LOOKUP_ISSUE (M)
 IPV4_INPUT_ARL_SANITY (M)
 IPV4_INPUT_SRC_LOOKUP_ISSUE
 IPV4_INPUT_DST_LOOKUP_CONSUME (M)
 IPV4_INPUT_SRC_LOOKUP_CONSUME
 IPV4_INPUT_FOR_US_MARTIAN (M)
 IPV4_INPUT_STILE_LEGACY
 IPV4_INPUT_FNF_FIRST
 IPV4_INPUT_LOOKUP_PROCESS (M)
 IPV4_INPUT_FNF_FINAL
 IPV4_INPUT_IPOPTIONS_PROCESS (M)
 IPV4_INPUT_GOTO_OUTPUT_FEATURE (M)
Protocol 1 - ipv4_output
FIA handle - CP:0x55a7f59df0d8 DP:0x3ffeff00
 IPV4_VFR_REFRAG (M)
 IPV4_OUTPUT_SRC_LOOKUP_ISSUE
 IPV4_OUTPUT_L2_REWRITE (M)
 IPV4_OUTPUT_SRC_LOOKUP_CONSUME
 IPV4_OUTPUT_STILE_LEGACY
 IPV4_OUTPUT_FRAG (M)
 IPV4_BDI_OUTPUT_FNF_FINAL
 BDI_VLAN_TAG_ATTACH_AND_LAYER2_LOOKUP_GOTO
 LAYER2_BRIDGE
 BDI_OUTPUT_GOTO_OUTPUT_FEATURE
 IPV4_OUTPUT_DROP_POLICY (M)
 DEF_IF_DROP_FIA (M)
Protocol 6 - ipv6_input
FIA handle - CP:0x55a7f59dee58 DP:0x3fff4300
 IPV6_INPUT_SANITY_CHECK (M)
 IPV6_INPUT_DST_LOOKUP_ISSUE (M)
 IPV6_INPUT_SRC_LOOKUP_ISSUE
 IPV6_INPUT_ARL (M)
 IPV6_INPUT_DST_LOOKUP_CONT (M)
 IPV6_INPUT_SRC_LOOKUP_CONT
 IPV6_INPUT_DST_LOOKUP_CONSUME (M)
 IPV6_INPUT_SRC_LOOKUP_CONSUME
 IPV6_INPUT_STILE_LEGACY
 IPV6_INPUT_FNF_FIRST
 IPV6_INPUT_FOR_US (M)
 IPV6_INPUT_LOOKUP_PROCESS (M)
 IPV6_INPUT_FNF_FINAL
 IPV6_INPUT_LINK_LOCAL_CHECK (M)
 IPV6_INPUT_GOTO_OUTPUT_FEATURE (M)
Protocol 7 - ipv6_output
FIA handle - CP:0x55a7f59dee08 DP:0x3fff4b80
 IPV6_VFR_REFRAG (M)
 IPV6_OUTPUT_SRC_LOOKUP_ISSUE
 IPV6_OUTPUT_SRC_LOOKUP_CONT
 IPV6_OUTPUT_SRC_LOOKUP_CONSUME
 IPV6_OUTPUT_L2_REWRITE (M)
 IPV6_OUTPUT_STILE_LEGACY
 IPV6_OUTPUT_FRAG (M)
 IPV6_BDI_OUTPUT_FNF_FINAL
 BDI_VLAN_TAG_ATTACH_AND_LAYER2_LOOKUP_GOTO
 LAYER2_BRIDGE
 BDI_OUTPUT_GOTO_OUTPUT_FEATURE

```

```
IPV6_OUTPUT_DROP_POLICY (M)
DEF_IF_DROP_FIA (M)
```

□

The following is a sample out of the **show flow monitor** `[[name] [cache [format {csv | record | table}]] [statistics]]` command showing the cache output in record format.

```
Device# show flow monitor name FLOW-MONITOR-1 cache format record
```

```
Cache type: Normal
Cache size: 1000
Current entries: 4
High Watermark: 4
Flows added: 101
Flows aged: 97
- Active timeout (1800 secs) 3
- Inactive timeout (15 secs) 94
- Event aged 0
- Watermark aged 0
- Emergency aged
IPV4 DESTINATION ADDRESS:
198.51.100.1 0
ipv4 source address: 10.10.11.1
trns source port: 25
trns destination port: 25
counter bytes: 72840
counter packets: 1821
IPV4 DESTINATION ADDRESS: 198.51.100.2
ipv4 source address: 10.10.10.2
trns source port: 20
trns destination port: 20
counter bytes: 3913860
counter packets: 7326
IPV4 DESTINATION ADDRESS: 198.51.100.200
ipv4 source address: 192.168.67.6
trns source port: 0
trns destination port: 3073
counter bytes: 51072
counter packets: 1824
```

```
Device# show flow monitor name FLOW-MONITOR-2 cache format record
```

```
Cache type: Normal
Cache size: 1000
Current entries: 2
High Watermark: 3
Flows added: 95
Flows aged: 93
- Active timeout (1800 secs) 0
- Inactive timeout (15 secs) 93
- Event aged 0
- Watermark aged 0
- Emergency aged 0
IPV6 DESTINATION ADDRESS: 2001:DB8:0:ABCD::1
ipv6 source address: 2001:DB8:0:ABCD::2
trns source port: 33572
trns destination port: 23
counter bytes: 19140
counter packets: 349
IPV6 DESTINATION ADDRESS: FF02::9
ipv6 source address: 2001:DB8::A8AA:BBFF:FE8B

trns source port: 521
trns destination port: 521
```

```
counter bytes: 92
counter packets: 1
```

The following is a sample out of the **show flow interface** command showing the flow status for an interface.

```
Device# show flow interface BD-VIF2001
```

```
Interface GigabitEthernet0/0/0
FNF: monitor: FLOW-MONITOR-1
direction: Input
traffic(ip): on
FNF: monitor: FLOW-MONITOR-2
direction: Input traffic(ipv6): on
```

```
Device# show flow interface BD-VIF2002
```

```
Interface GigabitEthernet1/0/0
FNF: monitor: FLOW-MONITOR-1
direction: Output
traffic(ip): on
FNF: monitor: FLOW-MONITOR-2
direction: Input traffic(ipv6): on
```

The following is a sample output of the **show platform hardware qfp active interface if-name | in FNF** command showing the QFP information and flow direction for flow monitors in Flexible NetFlow configuration. The table below provides the key to the CLI output.

| Configuration                           | Output                                       |
|-----------------------------------------|----------------------------------------------|
| ip flow monitor <monitor-name> input    | IPV4_INPUT_FNF_FIRST<br>IPV4_INPUT_FNF_FINAL |
| ip flow monitor <monitor-name> output   | IPV4_BDI_OUTPUT_FNF_FINAL                    |
| ipv6 flow monitor <monitor-name> input  | IPV6_INPUT_FNF_FIRST<br>IPV6_INPUT_FNF_FINAL |
| ipv6 flow monitor <monitor-name> output | IPV6_BDI_OUTPUT_FNF_FINAL                    |

```
Device# show run interface bd-vif2
Building configuration...
```

```
Current configuration : 227 bytes
!
interface BD-VIF2
vrf forwarding vrf1
ip flow monitor test1 input
ip flow monitor test1 output
ip address 10.11.11.11 255.255.255.0
ipv6 flow monitor test2 input
ipv6 flow monitor test2 output
ipv6 address 2001::8/64
end
```

```
Device# show platform hardware qfp active interface if-name BD-VIF 2 | in FNF
IPV4_INPUT_FNF_FIRST
IPV4_INPUT_FNF_FINAL
IPV4_BDI_OUTPUT_FNF_FINAL.
IPV6_INPUT_FNF_FIRST
IPV6_INPUT_FNF_FINAL
IPV6_BDI_OUTPUT_FNF_FINAL
```

The **clear flow monitor name** *monitor-name* [**cache** [**force-export**] | **force-export** | **statistics**] command clears a Flexible NetFlow flow monitor, flow monitor cache, or flow monitor statistics, and can be used to force the export of the data in the flow monitor cache.

For more details on configuring Flexible NetFlow, see the [Flexible NetFlow Configuration Guide, Cisco IOS XE 17](#).

## Additional References

### Related Documents

| Related Topic                                                                                      | Document Title                                                                                                                                                                      |
|----------------------------------------------------------------------------------------------------|-------------------------------------------------------------------------------------------------------------------------------------------------------------------------------------|
| Configuring Ethernet Virtual Connections on the Cisco ASR 1000 Series Aggregation Services Routers | <a href="#">Carrier Ethernet Configuration Guide</a>                                                                                                                                |
| EVC Quality of Service                                                                             | <a href="http://www.cisco.com/en/US/docs/ios/ios_xe/qos/configuration/guide/qos_evc_xe.html">http://www.cisco.com/en/US/docs/ios/ios_xe/qos/configuration/guide/qos_evc_xe.html</a> |

### MIBs

| MIB  | MIBs Link                                                                                                                                                                                                                   |
|------|-----------------------------------------------------------------------------------------------------------------------------------------------------------------------------------------------------------------------------|
| None | To locate and download MIBs for selected platforms, Cisco software releases, and feature sets, use Cisco MIB Locator found at the following URL:<br><a href="http://www.cisco.com/go/mibs">http://www.cisco.com/go/mibs</a> |

### Technical Assistance

| Description                                                                                                                                                                                                                                                                                                                                                                           | Link                                                                                                            |
|---------------------------------------------------------------------------------------------------------------------------------------------------------------------------------------------------------------------------------------------------------------------------------------------------------------------------------------------------------------------------------------|-----------------------------------------------------------------------------------------------------------------|
| The Cisco Support and Documentation website provides online resources to download documentation, software, and tools. Use these resources to install and configure the software and to troubleshoot and resolve technical issues with Cisco products and technologies. Access to most tools on the Cisco Support and Documentation website requires a Cisco.com user ID and password. | <a href="https://www.cisco.com/c/en_in/support/index.html">https://www.cisco.com/c/en_in/support/index.html</a> |

## Feature Information for Configuring Bridge Domain Interfaces

The following table lists the features in this module and provides links to specific configuration information.

Use Cisco Feature Navigator to find information about platform support and software image support. Cisco Feature Navigator enables you to determine which software images support a specific software release, feature set, or platform. To access Cisco Feature Navigator, go to <http://www.cisco.com/go/cfn>. An account on Cisco.com is not required.



**Note** The table below lists only the software release that introduced support for a given feature in a given software release train. Unless noted otherwise, subsequent releases of that software release train also support that feature.

**Table 41: Feature Information for Configuring Bridge Domain Interfaces**

| Feature Name                                                          | Releases                       | Feature Information                                                                                                                                                                                                                |
|-----------------------------------------------------------------------|--------------------------------|------------------------------------------------------------------------------------------------------------------------------------------------------------------------------------------------------------------------------------|
| Configuring Bridge Domain Interface                                   | Cisco IOS XE 3.2.0S            | This feature was introduced on the Cisco ASR 1000 Series Aggregation Services Routers.                                                                                                                                             |
| Configuring Bridge Domain Interface                                   | Cisco IOS XE 3.7.0S            | This feature was updated on the Cisco ASR 1000 Series Aggregation Services Routers. The following section was updated for this feature:<br><a href="#">Information About Bridge Domain Interface, on page 442</a>                  |
| Bridge-Domain Virtual IP Interface                                    | Cisco IOS XE Gibraltar 16.12   | The Bridge-Domain Virtual IP Interface (VIF) now connects multiple Bridge Domain Interfaces (BDI) with a single BD instance so that each IP subnet within an L2 network can be associated with a single VRF.                       |
| Flexible NetFlow (FNF) on Bridge-Domain Virtual IP Interface (BD-VIF) | Cisco IOS XE Cupertino 17.7.1a | This feature was introduced on the Cisco ASR 1000 Series Aggregation Services Routers. The following command was introduced:<br><b>{ip   ipv6} flow monitor <i>monitor-name</i> [sampler <i>sampler-name</i>] {input   output}</b> |





## CHAPTER 19

# Enabling Support for Tunable DWDM-XFP-C

First Published: July 2013

The dense wavelength-division multiplexing (DWDM) wavelengths of the DWDM-XFP-C module on the Cisco ASR 1000 Series Aggregation Services Routers is tunable. You can configure the DWDM ITU wavelengths using the **itu channel** command in the interface configuration mode. The **itu channel** command ensures that the traffic continues to flow.

The following table contains the wavelength mapping information for the DWDM-XFP-C. module

**Table 42: DWDM-XFP-C Wavelength Mapping**

| Channel | Frequency (THz) | Wavelength (nm) |
|---------|-----------------|-----------------|
| 1       | 191.95          | 1561.83         |
| 2       | 192.00          | 1561.42         |
| 3       | 192.05          | 1561.01         |
| 4       | 192.10          | 1560.61         |
| 5       | 192.15          | 1560.20         |
| 6       | 192.20          | 1559.79         |
| 7       | 192.25          | 1559.39         |
| 8       | 192.30          | 1558.98         |
| 9       | 192.35          | 1558.58         |
| 10      | 192.40          | 1558.17         |
| 11      | 192.45          | 1557.77         |
| 12      | 192.50          | 1557.36         |
| 13      | 192.55          | 1556.96         |
| 14      | 192.60          | 1556.55         |
| 15      | 192.65          | 1556.15         |

| Channel | Frequency (THz) | Wavelength (nm) |
|---------|-----------------|-----------------|
| 16      | 192.70          | 1555.75         |
| 17      | 192.75          | 1555.34         |
| 18      | 192.80          | 1554.94         |
| 19      | 192.85          | 1554.54         |
| 20      | 192.90          | 1554.13         |
| 21      | 192.95          | 1553.73         |
| 22      | 193.00          | 1553.33         |
| 23      | 193.05          | 1552.93         |
| 24      | 193.10          | 1552.52         |
| 25      | 193.15          | 1552.12         |
| 26      | 193.20          | 1551.72         |
| 27      | 193.25          | 1551.32         |
| 28      | 193.30          | 1550.92         |
| 29      | 193.35          | 1550.52         |
| 30      | 193.40          | 1550.12         |
| 31      | 193.45          | 1549.72         |
| 32      | 193.50          | 1549.32         |
| 33      | 193.55          | 1548.91         |
| 34      | 193.60          | 1548.51         |
| 35      | 193.65          | 1548.11         |
| 36      | 193.70          | 1547.72         |
| 37      | 193.75          | 1547.32         |
| 38      | 193.80          | 1546.92         |
| 39      | 193.85          | 1546.52         |
| 40      | 193.90          | 1546.12         |
| 41      | 193.95          | 1545.72         |
| 42      | 194.00          | 1545.32         |
| 43      | 194.05          | 1544.92         |

| Channel | Frequency (THz) | Wavelength (nm) |
|---------|-----------------|-----------------|
| 44      | 194.10          | 1544.53         |
| 45      | 194.15          | 1544.13         |
| 46      | 194.20          | 1543.73         |
| 47      | 194.25          | 1543.33         |
| 48      | 194.30          | 1542.94         |
| 49      | 194.35          | 1542.54         |
| 50      | 194.40          | 1542.14         |
| 51      | 194.45          | 1541.75         |
| 52      | 194.50          | 1541.35         |
| 53      | 194.55          | 1540.95         |
| 54      | 194.60          | 1540.56         |
| 55      | 194.65          | 1540.16         |
| 56      | 194.70          | 1539.77         |
| 57      | 194.75          | 1539.37         |
| 58      | 194.80          | 1538.98         |
| 59      | 194.85          | 1538.58         |
| 60      | 194.90          | 1538.19         |
| 61      | 194.95          | 1537.79         |
| 62      | 195.00          | 1537.40         |
| 63      | 195.05          | 1537.00         |
| 64      | 195.10          | 1536.61         |
| 65      | 195.15          | 1536.22         |
| 66      | 195.20          | 1535.82         |
| 67      | 195.25          | 1535.43         |
| 68      | 195.30          | 1535.04         |
| 69      | 195.35          | 1534.64         |
| 70      | 195.40          | 1534.25         |
| 71      | 195.45          | 1533.86         |

| Channel | Frequency (THz) | Wavelength (nm) |
|---------|-----------------|-----------------|
| 72      | 195.50          | 1533.47         |
| 73      | 195.55          | 1533.07         |
| 74      | 195.60          | 1532.68         |
| 75      | 195.65          | 1532.29         |
| 76      | 195.70          | 1531.90         |
| 77      | 195.75          | 1531.51         |
| 78      | 195.80          | 1531.12         |
| 79      | 195.85          | 1530.72         |
| 80      | 195.90          | 1530.33         |
| 81      | 195.95          | 1529.94         |
| 82      | 196.00          | 1529.55         |

- [Configuring the DWDM-XFP-C Module, on page 462](#)

## Configuring the DWDM-XFP-C Module

Perform the following procedure to configure the DWDM-XFP-C module.

### SUMMARY STEPS

1. **enable** *source-interface gigabitethernet slot/port*
2. **configure terminal**
3. **interface** *tengigabitethernet slot/port*
4. **itu channel number**

### DETAILED STEPS

|               | Command or Action                                                                                        | Purpose                                                             |
|---------------|----------------------------------------------------------------------------------------------------------|---------------------------------------------------------------------|
| <b>Step 1</b> | <b>enable</b> <i>source-interface gigabitethernet slot/port</i><br><b>Example:</b><br><br>Router# enable | Enables the privileged EXEC mode. If prompted, enter your password. |
| <b>Step 2</b> | <b>configure terminal</b><br><b>Example:</b><br><br>Router# configure terminal                           | Enters the global configuration mode.                               |
| <b>Step 3</b> | <b>interface</b> <i>tengigabitethernet slot/port</i>                                                     | Specifies the 10-Gigabit Ethernet interface to be configured.       |

|               | Command or Action                                                                                         | Purpose                                                                                                            |
|---------------|-----------------------------------------------------------------------------------------------------------|--------------------------------------------------------------------------------------------------------------------|
|               | <b>Example:</b><br><code>Router(config)# interface tengigabitethernet 4/11</code>                         | Here:<br>slot/port—Specifies the location of the interface.                                                        |
| <b>Step 4</b> | <b>itu channel</b> <i>number</i><br><br><b>Example:</b><br><code>Router(config-if)# itu channel 28</code> | Sets the ITU channel.<br><br><i>number</i> —Specifies the ITU channel number. The acceptable values are from 1–82. |

## Verifying the ITU Configuration

The following example shows how to use the **show hw-module subslot** command to check an ITU configuration:

```

Router# enable
Router# conf t
Enter configuration commands, one per line. End with CNTL/Z.
Router(config)#int tenGigabitEthernet 1/2/0
Router(config-if)#itu channel 20
Router(config-if)#
Router#
Router# show hw-module subslot 1/2 transceiver 0 idpr dump
Description = XFP optics (type 6)
Transceiver Type: = TUNABLE DWDM XFP (194)
Product Identifier (PID) = DWDM-XFP-C
Frequency Set for Tunable DWDM = 195.5 THz
Vendor Revision = 00
Serial Number (SN) = JFX1617800W
Vendor Name = CISCO-JDSU
Vendor OUI (IEEE company ID) = 00.01.9C (412)
CLEI code = IP9IAGGCAB
Cisco part number = 10-2544-02
Device State = Disabled.
XFP IDPROM Page 0x0:
000: 0C 00 49 00 F8 00 46 00 FB 00
010: 00 00 00 00 00 00 00 00 A6 04
020: 09 C4 8C A0 13 88 9B 83 13 93
030: 62 1F 1F 07 0F 8D 00 0A 09 CF
040: 00 10 00 18 FF E8 00 0C FF F4
050: 00 00 00 00 00 00 00 00 00 00
060: 00 BF 25 1C 00 C4 00 00 01 F4
070: 00 00 00 00 00 00 00 00 00 00
080: 00 00 00 00 9E 20 00 00 00 00
090: 00 00 00 00 00 00 1E 7C 00 00
100: 00 00 00 01 00 00 00 00 00 00
110: E2 98 00 14 00 00 00 00 00 00 <<See byte 113, the hexa decimal
equivalent for ITU channel 20>>
120: 00 00 00 00 00 00 00 00 01
XFP IDPROM Page 0x1:
128: 0C 98 07 00 00 00 00 00 00 00
138: 08 B4 63 71 50 00 00 00 00 9F
148: 43 49 53 43 4F 2D 4A 44 53

```





## CHAPTER 20

# Monitoring and Maintaining Multilink Frame Relay

---

The Cisco Frame Relay implementation currently supports routing on IP, DECnet, AppleTalk, XNS, Novell IPX, CLNS, Banyan VINES, and transparent bridging. This guide describes how to monitor and maintain the Multilink Frame Relay feature for the Cisco ASR 1000 Series Routers.

- [Feature Overview](#) , on page 465
- [Configuring Multilink Frame Relay](#), on page 465
- [Monitoring and Maintaining Frame Relay and Multilink Frame Relay](#), on page 465
- [Additional References](#), on page 466
- [Feature Information for Monitoring and Maintaining Multilink Frame Relay](#), on page 467

## Feature Overview

The Multilink Frame Relay feature is based on the Frame Relay Forum's Multilink Frame Relay UNI Implementation Agreement (FRF.16). This feature provides a cost-effective way to increase bandwidth for certain applications by enabling multiple serial links to be aggregated into a single bundle of bandwidth. Multilink Frame Relay is supported on User-to-Network Interface (UNI) networks.

## Configuring Multilink Frame Relay

The multilink frame relay configuration processes are described in the Frame Relay - Multilink (MLFR-FRF.16) feature guide. For more information, see the Frame Relay - Multilink (MLFR-FRF.16) feature guide at: [http://www.cisco.com/en/US/docs/ios/ios\\_xe/wan/configuration/guide/wan\\_ml\\_fr\\_fr161\\_xe.html](http://www.cisco.com/en/US/docs/ios/ios_xe/wan/configuration/guide/wan_ml_fr_fr161_xe.html)

## Monitoring and Maintaining Frame Relay and Multilink Frame Relay

You can use different **show** and **debug** commands to monitor and maintain frame relay and multilink frame relay configurations.

You can use the following **show** commands to display the multilink frame relay configurations:

- **show platform software frame-relay**—Displays the statistics about frame relay permanent virtual circuits (PVCs).
- **show platform software mfr**—Displays statistics about multilink frame relay information.

You can use the following **debug** commands to debug the multilink frame relay configurations:

- **debug platform hardware qfp active interface frame-relay multilink**—Debugs the multilink frame relay interfaces in the Cisco QuantumFlow Processor (QFP).
- **platform trace runtime process forwarding-manager module**—Enables Forwarding Manager Route Processor and Embedded Service Processor trace messages for the forwarding manager process.

For additional information on the commands and the options available for each command, see the Cisco IOS Configuration Fundamentals Command Reference document, located at: [http://www.cisco.com/en/US/docs/ios/fundamentals/command/reference/cf\\_book.html](http://www.cisco.com/en/US/docs/ios/fundamentals/command/reference/cf_book.html)

## Additional References

### Related Documents

| Related Topic                         | Document Title                                                                                                                                                                                        |
|---------------------------------------|-------------------------------------------------------------------------------------------------------------------------------------------------------------------------------------------------------|
| Multilink - Frame Relay (MLFR-FRF.16) | <a href="http://www.cisco.com/en/US/docs/ios/ios_xe/wan/configuration/guide/wan_ml_fr_frf161_xe.html">http://www.cisco.com/en/US/docs/ios/ios_xe/wan/configuration/guide/wan_ml_fr_frf161_xe.html</a> |
| Frame Relay                           | <i>Wide-Area Networking Configuration Guide: Frame Relay, Cisco IOS XE Release 3S</i>                                                                                                                 |

### Standards

| Standard | Title |
|----------|-------|
| None     | —     |

### MIBs

| MIB  | MIBs Link                                                                                                                                                                                                         |
|------|-------------------------------------------------------------------------------------------------------------------------------------------------------------------------------------------------------------------|
| None | To locate and download MIBs for selected platforms, Cisco IOS releases, and feature sets, use Cisco MIB Locator found at this URL:<br><br><a href="http://www.cisco.com/go/mibs">http://www.cisco.com/go/mibs</a> |

### RFCs

| RFC  | Title |
|------|-------|
| None | —     |



**Technical Assistance**

| Description                                                                                                                                                                                                                                                                                                                                                                           | Link                                                                                    |
|---------------------------------------------------------------------------------------------------------------------------------------------------------------------------------------------------------------------------------------------------------------------------------------------------------------------------------------------------------------------------------------|-----------------------------------------------------------------------------------------|
| The Cisco Support and Documentation website provides online resources to download documentation, software, and tools. Use these resources to install and configure the software and to troubleshoot and resolve technical issues with Cisco products and technologies. Access to most tools on the Cisco Support and Documentation website requires a Cisco.com user ID and password. | {start<br>hypertext}http://www.cisco.com/cisco/web/support/index.html{end<br>hypertext} |

## Feature Information for Monitoring and Maintaining Multilink Frame Relay

{start cross reference} Table 16-1 {end cross reference} lists the features in this module and provides links to specific configuration information.

Use Cisco Feature Navigator to find information about platform support and software image support. Cisco Feature Navigator enables you to determine which software images support a specific software release, feature set, or platform. To access Cisco Feature Navigator, go to {start hypertext} <http://www.cisco.com/go/cfn> {end hypertext}. An account on Cisco.com is not required.



**Note** {start cross reference} Table 16-1 {end cross reference} lists only the software release that introduced support for a given feature in a given software release train. Unless noted otherwise, subsequent releases of that software release train also support that feature.

**Table 43: Feature Information for Monitoring and Maintaining Multilink Frame Relay**

| Feature Name                           | Releases            | Feature Information                                                                            |
|----------------------------------------|---------------------|------------------------------------------------------------------------------------------------|
| Monitoring and Maintaining Frame Relay | Cisco IOS XE 3.4.0S | In Cisco IOS XE Release 3.4S, this feature was introduced on the Cisco ASR 1000 Series Router. |





## CHAPTER 21

# Configuring MPLS Layer 2 VPNs

First Published: March 29, 2012

Last Revised:

The Frame Relay to ATM Bridged Interworking feature provides interoperability between the Frame Relay attachment virtual circuit (VC) and the ATM attachment VC that are connected to different provider edge (PE) routers. The bridged encapsulation corresponding to the bridged (Ethernet) interworking mechanism is used to enable this interoperability. The Ethernet frames are carried through the MPLS network using Ethernet over MPLS (EoMPLS). The interworking function is performed in the PE routers connected to the Frame Relay attachment VC and the ATM attachment VC based on RFC 2684 and RFC 2427.

The xconnect support on Gigabit EtherChannel (GEC) Virtual Private Wire Service (VPWS) on ASR 1000 feature enables service providers to supply connectivity between customer sites with existing data link layer (Layer 2) networks by using a single, integrated, packet-based network infrastructure—a Cisco MPLS network. Instead of separate networks with separate network management environments, service providers can deliver Layer 2 connections over an MPLS backbone.

Layer 2 Gateway Protocol (L2GP) is a recommended IEEE standard (802.1ah) to address the issues that arise when two independent, bridged domains are connected redundantly through an arbitrary number of links. L2GP defines how the forwarding gateways are selected, so that only redundant ports are blocked and there are no temporary loops. The transition should be at least at the same speed in which Spanning Tree Protocol (STP) L2GP resolves the transient loop problem during reconvergence because it does not require cooperation from the outside domain.

Reverse Layer 2 Gateway Protocol (R-L2GP) is a variation of an L2GP. In case of an R-L2GP, the pseudo information of the R-L2GP is transmitted by network provider edges (nPEs) instead of user provider edges (uPEs). R-L2GP provides a mechanism to send out static preconfigured bridge protocol data units (BPDUs) on each ring access port of the nPEs to stimulate a per-access ring instantiation of the protocol. R-L2GP enables the PEs to avoid the burden of running Multiple Instances Spanning Tree Protocol (MISTP) when multiple independent access networks that run MISTP connect to a pair of redundant PEs.

High-Level Data Link Control (HDLC) Ethernet over MPLS is part of the Any Transport over MPLS (AToM) solution. HDLC and Ethernet are two link-layer transports that utilize the AToM architecture.

- [Overview of L2VPN Interworking, on page 470](#)
- [Virtual Private LAN Services, on page 472](#)
- [Prerequisites for Frame Relay DLCI-to-ATM AAL5SNAP Bridged Interworking, on page 479](#)
- [Frame Relay DLCI-to-ATM AAL5SNAP Bridged Interworking, on page 479](#)
- [Configuring Frame Relay DLCI-to-ATM AAL5SNAP Bridged Interworking, on page 481](#)
- [Gigabit EtherChannel for Virtual Private Wire Service, on page 487](#)

- [Configuring Gigabit EtherChannel for Virtual Private Wire Service, on page 488](#)
- [High-Level Data Link Control-Ethernet Interworking, on page 499](#)
- [Configuring HDLC-Ethernet Interworking, on page 500](#)
- [Additional References, on page 526](#)
- [Technical Assistance, on page 528](#)
- [Feature Information for Configuring MPLS Layer 2 VPNs, on page 528](#)
- [Glossary, on page 530](#)

## Overview of L2VPN Interworking

Interworking is a transforming function that interconnects two heterogeneous attachment circuits (ACs). Several types of interworking functions exist. The function that is used depends on the AC type used, the type of data carried, and the level of functionality required. The two main Layer 2 Virtual Private Network (L2VPN) interworking functions supported in Cisco IOS XE software are bridged interworking and routed interworking.

Layer 2 (L2) transport over multiprotocol label switching (MPLS) and IP exists for ACs, such as Ethernet-to-Ethernet or Point-to-Point Protocol (PPP), Ethernet to VLAN, and Ethernet to Frame Relay. An interworking function facilitates translation between different L2 encapsulations.

## L2VPN Interworking Modes

L2VPN interworking works in either Ethernet (bridged) mode or IP (routed) mode. You can specify the mode by issuing the **interworking {ethernet | ip}** command in pseudowire-class configuration mode and in L2VPN xconnect configuration mode for protocol-based CLI.

The **interworking** command causes the ACs to be terminated locally. The two keywords perform the following functions:

- The **ethernet** keyword causes Ethernet frames to be extracted from an AC and sent over the pseudowire. Ethernet end-to-end transmission is resumed. The AC frames that are not Ethernet are dropped. In the case of VLAN, the VLAN tag is removed, leaving an untagged Ethernet frame.
- The **ip** keyword causes IP packets to be extracted from an AC and sent over the pseudowire. The AC frames that do not contain IPv4 packets are dropped.

The following sections explain the Ethernet and IP interworking modes in detail.

## Ethernet or Bridged Interworking

Ethernet interworking is also called bridged interworking. Ethernet frames are bridged across the pseudowire. The CE routers can natively bridge Ethernet traffic or can route traffic using a bridged encapsulation model, such as Bridge-group Virtual Interface (BVI) or Routed Bridge Encapsulation (RBE). The PE routers operate in the Ethernet like-to-like mode.

The Ethernet interworking mode offers the following services:

- LAN services—An example of this is an enterprise that has several sites, with some sites having Ethernet connectivity to the service provider (SP) network and others having Asynchronous Transfer Mode (ATM) connectivity. If the enterprise requires LAN connectivity to all its sites, traffic from the Ethernet or VLAN of one site can be sent through the IP/MPLS network and encapsulated as bridged traffic over an ATM VC of another site.
- Connectivity services—An example of this is an enterprise that has different sites running an Internal Gateway Protocol (IGP) that has incompatible procedures on broadcast and non broadcast links. This

enterprise has several sites that run an IGP, such as Open Shortest Path First (OSPF) or Intermediate System-to-Intermediate System (IS-IS), between the sites. In this scenario, some of the procedures (such as route advertisement or designated router election) depend on the underlying L2 protocol and are different for a point-to-point ATM connection versus a broadcast Ethernet connection. Therefore, the bridged encapsulation over ATM can be used to achieve homogenous Ethernet connectivity between the CE routers running an IGP.

## IP or Routed Interworking

IP interworking is also called routed interworking. The CE routers encapsulate the IP on the link between the CE router and the PE router. A new VC type is used to signal the IP pseudowire in MPLS. Translation between the L2 and IP encapsulations across the pseudowire is required. Special consideration needs to be given to the address resolution protocol operation and routing protocol operation, because these are handled differently on different L2 encapsulations.

The IP interworking mode is used to provide IP connectivity between sites, regardless of the L2 connectivity to these sites. It is different from a Layer 3 VPN because it is point-to-point in nature and the service provider does not maintain any routing information pertaining to customers.

Address resolution is encapsulation dependent as specified here:

- Ethernet uses Address Resolution Protocol (ARP)
- ATM uses inverse ARP
- PPP uses IP Control Protocol (IPCP)
- HDLC uses Serial Line ARP (SLARP)

Therefore, address resolution must be terminated on the PE router. Also, the end-to-end address resolution is not supported. Routing protocols operate differently over broadcast and point-to-point media. For Ethernet, the CE routers must either use static routing or configure the routing protocols to treat the Ethernet side as a point-to-point network.

In routed interworking, the IP packets that are extracted from the ACs are sent over the pseudowire. The pseudowire works in the IP Layer 2 transport (VC type 0x000B) like-to-like mode. The interworking function at the network service provider's (NSP) end completes the required adaptation based on the AC technology. The non-IPv4 packets are dropped.

In routed interworking, the following considerations must be kept in mind:

- ARP, inverse ARP, and IPCP are punted to the routing protocol.

Therefore, the PE router at the NSP end must provide the following address-resolution functionalities for the Ethernet and ATM and Frame Relay point-to-point subinterface attachment circuits:

- Ethernet—The PE device acts as a Proxy ARP server to all the ARP requests from the CE router. The PE router responds with the MAC address of its local interface.
- ATM and Frame Relay point-to-point subinterface—By default, inverse ARP does not run in the point-to-point Frame Relay or ATM subinterfaces. The IP address and subnet mask define the connected prefix; therefore, configuration is not required in the CE devices.
- Interworking requires that the MTUs in both the ACs must match for the pseudowire that is to come up. The default MTU in one AC must match the MTU of other AC.

The following table lists the range of MTUs that can be configured for different ACs.

Table 44: Range of MTUs for Different ACs

| AC Type          | Range of MTUs Supported |
|------------------|-------------------------|
| ATM              | 64 to 9216              |
| Gigabit Ethernet | 1500 to 9216            |
| POS              | 64 to 9216              |
| Fast Ethernet    | 1500 to 9216            |

The MTU configured on an AC must not exceed the MTU in the core network. This ensures that the traffic is not fragmented.

- The CE routers with Ethernet attachment VCs running OSPF must be configured with the `ospfIfType` option so that the OSPF protocol treats the underlying physical broadcast link as a P2P link.

## Virtual Private LAN Services

Virtual Private LAN Service (VPLS) enables enterprises to link together their Ethernet-based LANs from multiple sites via the infrastructure provided by their service provider. From the enterprise perspective, the service provider's public network looks like one giant Ethernet LAN. For the service provider, VPLS provides an opportunity to deploy another revenue-generating service on top of their existing network without major capital expenditures. Operators can extend the operational life of equipment in their network.

Virtual Private LAN Services (VPLS) uses the provider core to join multiple attachment circuits together to simulate a virtual bridge that connects the multiple attachment circuits together. From a customer point of view, there is no topology for VPLS. All of the CE devices appear to connect to a logical bridge emulated by the provider core.

## Reverse Layer 2 Gateway Protocol

Layer 2 Gateway Protocol (L2GP) is a recommended IEEE standard (802.1ah) to address the issues that arise when two independent, bridged domains are connected redundantly through an arbitrary number of links. L2GP defines how the forwarding gateways are selected, so that only redundant ports are blocked and there are no temporary loops. The transition should be at least the same speed in which STP L2GP resolves the transient loop problem during the reconvergence because it does not require cooperation from the outside domain.

Reverse Layer 2 Gateway Protocol (R-L2GP) is a variation of an L2GP. In case of an R-L2GP, the pseudo information of the R-L2GP is transmitted by Network-facing Provider Edges (nPEs) instead of User Provider-Edges (uPEs). R-L2GP provides a mechanism to send out static preconfigured Bridge Protocol Data Units (BPDUs) on each ring access port of nPEs to stimulate a per-access ring instantiation of the protocol. R-L2GP enables the Provider Edges (PEs) to avoid the burden of running Multiple Instance Spanning Tree Protocol (MST) when multiple independent access networks that run MST connect to a pair of redundant PEs.

In order for this to work, the pair of nPEs are programmed to send out BPDUs on the access ring ports in such a way that they appear to be either:

- The root bridge itself (the bridge with the lowest bridge ID or priority).
- The bridge with the second lowest bridge ID or priority, and with a 0 cost path to the root.

Using R-L2GP, you can statically configure the BPDUs instead of the STP generate the BPDUs dynamically. The following figure shows the topology of multiple-access networks connected to redundant nPEs.

Figure 10: Multiple-Access Networks Connected to Redundant nPEs

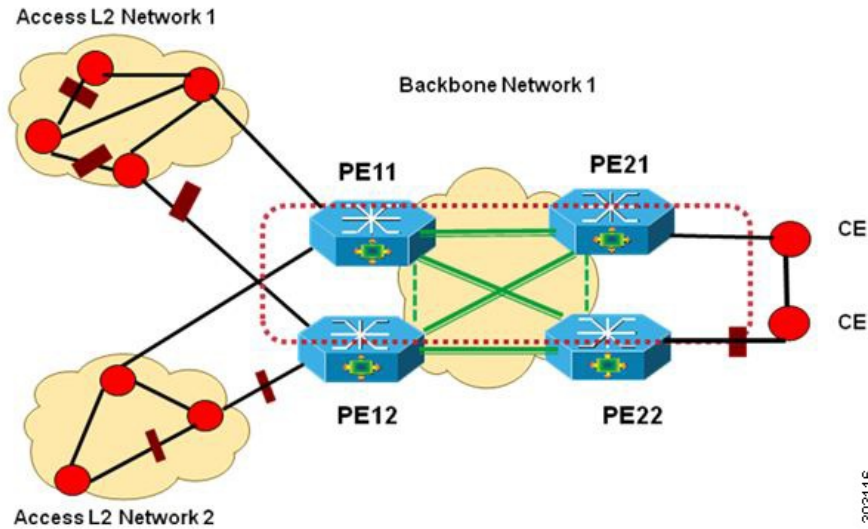

303116

### BPDUs Sent Out of R-L2GP Ports

An R-L2GP module in a route processor (RP) generates static preconfigured BPDUs, and sends them to uPEs via access ports, with the R-L2GP enabled.



**Note** Only locally generated static BPDUs can be sent out to RL2GP ports.

The following figure shows how a BPDU is forwarded to an R-L2GP port.

Figure 11: BPDU on an R-L2GP Port

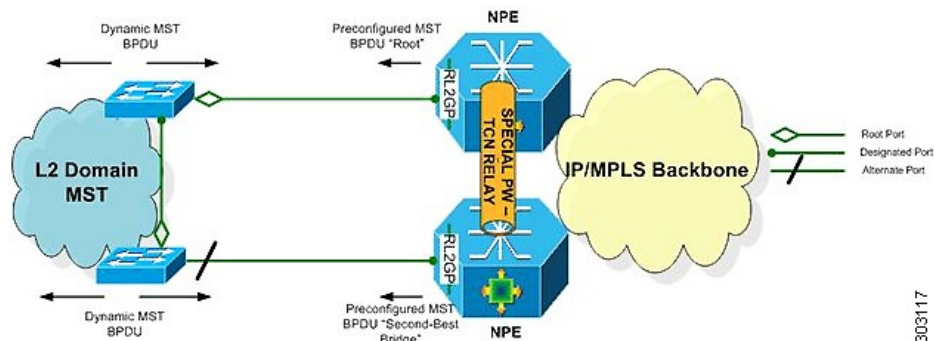

303117

## BPDUs Received on R-L2GP Ports

On PE, only BPDUs with Topology Change Notification (TCN) bits on are punted to the R-L2GP and the STP module. If the PE is in a redundant setting, the corresponding BPDUs are propagated to peer-redundant PE via the L2 protocol forwarding pseudowire (PW).

## BPDUs Received on L2 Protocol Forwarding PW

The TCN BPDUs received from L2 protocol forwarding PW are punted to RP, and STP/R-L2GP process it and generate MAC flush.

## Restrictions for R-L2GP

The restrictions for the R-L2GP feature are:

- R-L2GP is supported only on L2 bridge ports, and is not compatible with prestandard MST.
- All the access-side shall have the same MST instance, the same name and the same revision number configuration as nPEs.
- There is no configure error detection and recover mechanism for R-L2GP. Users are expected to configure R-L2GP and MSTP instance on CEs and nPEs correctly.

## Configuring the R-L2GP

Since the R-L2GP configuration is bundled with the MST configuration, the above parameters can be recycled from the MSTI and MST region (currently only one MST region is supported on IOS) configurations. This section describes how to configure Reverse L2GP. It consists of the following sections:

## Configuring the MST

Configuration of the MST must be done before configuring the R-L2GP and attaching the R-L2GP to a port.

### SUMMARY STEPS

1. **enable**
2. **configure terminal**
3. **spanning-tree mode mst**
4. **spanning-tree mst configuration**
5. **name name**
6. **revision version**
7. **instance instance-id {vlans vlan-range}**

### DETAILED STEPS

|        | Command or Action                                          | Purpose                                                               |
|--------|------------------------------------------------------------|-----------------------------------------------------------------------|
| Step 1 | <b>enable</b><br><br><b>Example:</b><br><br>Router# enable | Enables privileged EXEC mode.<br><br>Enter your password if prompted. |



|               | Command or Action                                                                                                          | Purpose                                                                                                                                                                        |
|---------------|----------------------------------------------------------------------------------------------------------------------------|--------------------------------------------------------------------------------------------------------------------------------------------------------------------------------|
| <b>Step 2</b> | <b>configure terminal</b><br><b>Example:</b><br><pre>Router# configure terminal</pre>                                      | Enters global configuration mode.                                                                                                                                              |
| <b>Step 3</b> | <b>spanning-tree mode mst</b><br><b>Example:</b><br><pre>Router(config)# spanning-tree mode mst.</pre>                     | Enables MST mode.                                                                                                                                                              |
| <b>Step 4</b> | <b>spanning-tree mst configuration</b><br><b>Example:</b><br><pre>Router(config)# spanning-tree mst configuration</pre>    | Enters MST configuration submode.                                                                                                                                              |
| <b>Step 5</b> | <b>name name</b><br><b>Example:</b><br><pre>Router(config-mst)# name Cisco</pre>                                           | Sets the name of the MST region.<br><b>Note</b> All the nodes in the same region should be configured with the same MST name.                                                  |
| <b>Step 6</b> | <b>revision version</b><br><b>Example:</b><br><pre>Router(config-mst)# revision 5</pre>                                    | Sets the revision number for the MST (802.1s) configuration.<br><b>Note</b> All the nodes in the same region should be configured with the same MST configure revision number. |
| <b>Step 7</b> | <b>instance instance-id {vlans vlan-range}</b><br><b>Example:</b><br><pre>Router(config-mst)# instance 2 vlans 1-100</pre> | Maps a VLAN or a group of VLANs to an MST instance.                                                                                                                            |

## Configuring an R-L2GP Instance

Perform the following steps to configure R-L2GP instance.

### SUMMARY STEPS

1. **enable**
2. **configure terminal**
3. **spanning-tree pseudo-information transmit identifier**
4. **remote-id id**
5. **mst region-id root mac-address**
6. **mst region-id cost**

## DETAILED STEPS

|               | Command or Action                                                                                                                                     | Purpose                                                                                                                                                                                                                                                             |
|---------------|-------------------------------------------------------------------------------------------------------------------------------------------------------|---------------------------------------------------------------------------------------------------------------------------------------------------------------------------------------------------------------------------------------------------------------------|
| <b>Step 1</b> | <b>enable</b><br><b>Example:</b><br>Router> <b>enable</b>                                                                                             | <b>Enables privileged EXEC mode.</b><br><b>Enter your password, if prompted.</b>                                                                                                                                                                                    |
| <b>Step 2</b> | configure terminal<br><b>Example:</b><br>Router# <b>configure terminal</b>                                                                            | Enters global configuration mode.                                                                                                                                                                                                                                   |
| <b>Step 3</b> | <b>spanning-tree pseudo-information transmit identifier</b><br><b>Example:</b><br>Router(config)# <i>spanning-tree pseudo-information transmit 46</i> | Configures the Reverse-L2GP configuration on the interface or the untagged Ethernet Flow Point (EFP) port.                                                                                                                                                          |
| <b>Step 4</b> | <b>remote-id id</b><br><b>Example:</b><br>Router(config-pseudo)# <i>remote-id 53</i>                                                                  | Configures the remote R-L2GP instance ID that pairs with the specified R-L2GP instance ID.                                                                                                                                                                          |
| <b>Step 5</b> | <b>mst region-id root mac-address</b><br><b>Example:</b><br>Router(config-pseudo)#<br>mst 0 root 32768 0000.0000.0001                                 | Adds MST instances to R-L2GP instances and configures the MAC address and priority for MST instances.<br><br><b>Note</b> MST 0 has all the VLANs that have not been explicitly specified in other MST instances. MST 0 must be configured for each R-L2GP instance. |
| <b>Step 6</b> | <b>mst region-id cost</b><br><b>Example:</b><br>Router(config-pseudo)# <i>mst 1 cost 1</i>                                                            | Adds the corresponding MST instance list to the R-L2GP instance and configures the R-L2GP path cost for the MST instance or multiple MST instances.                                                                                                                 |

## What to do next



**Note** To configure an R-L2GP on the Cisco ASR 1000 Series Aggregation Services Router, the remote-id configured on nPE1 must be the transmit identifier configured on nPE2, and vice versa.

## Attaching an R-L2GP Instance to a Port

## SUMMARY STEPS

1. **enable**
2. **configure terminal**

3. interface gigabitethernet slot/port
4. spanning-tree pseudo-information transmit identifier

**DETAILED STEPS**

|        | Command or Action                                                                                                                                                                                                                    | Purpose                                                                                                                                                                                                                                |
|--------|--------------------------------------------------------------------------------------------------------------------------------------------------------------------------------------------------------------------------------------|----------------------------------------------------------------------------------------------------------------------------------------------------------------------------------------------------------------------------------------|
| Step 1 | <p>enable</p> <p><b>Example:</b></p> <pre>Router&gt; enable</pre>                                                                                                                                                                    | <p>Enables privileged EXEC mode.</p> <p>Enter your password, if prompted.</p>                                                                                                                                                          |
| Step 2 | <p>configure terminal</p> <p><b>Example:</b></p> <pre>Router# configure terminal</pre>                                                                                                                                               | <p>Enters global configuration mode.</p>                                                                                                                                                                                               |
| Step 3 | <p>interface gigabitethernet slot/port</p> <p><b>Example:</b></p> <p>or</p> <p><b>Example:</b></p> <pre>interface tengigabitethernet slot/port</pre> <p><b>Example:</b></p> <pre>Router(config)# interface gigabitethernet 4/1</pre> | <p>Specifies Gigabit Ethernet or the 10 Gigabit Ethernet interface on the access side of the nPE to configure.</p> <p>Here:</p> <ul style="list-style-type: none"> <li>• slot/port—Specifies the location of the interface.</li> </ul> |
| Step 4 | <p><b>spanning-tree pseudo-information transmit identifier</b></p> <p><b>Example:</b></p> <pre>Router(config-if)# spanning-tree pseudo-information transmit 46</pre>                                                                 | <p>Configures the Reverse-L2GP configuration on the interface.</p> <p><b>Note</b> The identifier should be the same as the one configured on the nPE.</p>                                                                              |

**Example: Configuring an R-L2GP**

The following example shows how to configure an R-L2GP in a network comprising two nPEs.

Configuration example on nPE1:

```
enable
configure terminal
spanning-tree pseudo-information transmit 46
 remote-id 53
 mst 0 root 32768 0000.0000.0001
 mst 1 root 32768 0000.0000.0002
 mst 1 cost 1
 mst 2 root 32768 0000.0000.0003
exit
interface gigabitEthernet 2/1/0
 spanning-tree pseudo-information transmit 46
```

Configuration example on nPE2:

```

spanning-tree pseudo-information transmit 53
 remote-id 46
 mst 0 root 32768 0000.0000.0001
 mst 1 root 32768 0000.0000.0002
 mst 1 cost 1
 mst 2 root 32768 0000.0000.0003
interface gigabitEthernet 0/0/1
 spanning-tree pseudo-information transmit 53

```

## Configuring the Layer 2 Protocol Forwarding Virtual Private LAN Services Pseudowire Between Two Redundant NPES

### SUMMARY STEPS

1. **enable**
2. **configure terminal**
3. **l2 vfi vfi-name manual**
4. **vpn id vpn\_id**
5. **bridge-domain bridge\_id**
6. **forward permit l2protocol all**
7. **neighbor ip-address vc-id {encapsulation mpls |pw-class pw-class-name}**

### DETAILED STEPS

|        | Command or Action                                                                                 | Purpose                                                                                                      |
|--------|---------------------------------------------------------------------------------------------------|--------------------------------------------------------------------------------------------------------------|
| Step 1 | <b>enable</b><br><b>Example:</b><br>Router> <b>enable</b>                                         | <b>Enables privileged EXEC mode.</b><br><br><b>Enter your password, if prompted.</b>                         |
| Step 2 | <b>configure terminal</b><br><b>Example:</b><br>Router# <b>configure terminal</b>                 | Enters global configuration mode.                                                                            |
| Step 3 | <b>l2 vfi vfi-name manual</b><br><b>Example:</b><br>Router(config)# <b>l2 vfi vfitest1 manual</b> | Creates a Layer 2 Virtual Forwarding Instance (VFI) and enters the Layer 2 VFI manual configuration submode. |
| Step 4 | <b>vpn id vpn_id</b><br><b>Example:</b><br>Router(config-vfi)# <b>vpn id 303</b>                  | Sets or updates a VPN ID on a VPN routing and forwarding (VRF) instance.                                     |
| Step 5 | <b>bridge-domain bridge_id</b><br><b>Example:</b><br>Router(config-vfi)# <b>bridge-domain 100</b> | Binds a service instance to a bridge domain instance.                                                        |

|        | Command or Action                                                                                                                                                            | Purpose                                                                                                                                              |
|--------|------------------------------------------------------------------------------------------------------------------------------------------------------------------------------|------------------------------------------------------------------------------------------------------------------------------------------------------|
| Step 6 | <b>forward permit l2protocol all</b><br><b>Example:</b><br><pre>Router(config-vfi)# forward permit l2protocol all</pre>                                                      | Defines the VPLS pseudowire that is used to transport bridge protocol data unit (BPDU) information between two network provider edge (N-PE) routers. |
| Step 7 | <b>neighbor ip-address vc-id {encapsulation mpls  pw-class pw-class-name}</b><br><b>Example:</b><br><pre>Router(config-vfi)# neighbor 10.10.10.10 1 encapsulation mpls</pre> | Specifies the routers that should form a point-to-point Layer 2 virtual forwarding interface (VFI) connection.                                       |

## Verifying an R-L2GP Configuration

The following examples show how to use the show commands to verify an R-L2GP configuration:

```
Router# show spanning-tree pseudo-information 46 configuration

remote_id 53
mst_region_id 0, port_count 2, update_flag 0x0
mrecord 0x3AF841EC, mrec_count 3:
 msti 0: root_id 32768.0000.0000.0001, root_cost 0, update_flag 0x0
 msti 1: root_id 32769.0000.0000.0002, root_cost 1, update_flag 0x0
 msti 2: root_id 32770.0000.0000.0003, root_cost 0, update_flag 0x0
Router# show spanning-tree pseudo-information 1 interface GigabitEthernet3/0/3
Pseudo id 1:
 GigabitEthernet 2/1/0
 GigabitEthernet 0/0/1
```

## Prerequisites for Frame Relay DLCI-to-ATM AAL5SNAP Bridged Interworking

Before you configure the Frame Relay Data Link Connection Identifier (DLCI)-to-ATM AAL5SNAP Bridged Interworking feature on a router, ensure that the following prerequisites are met:

- Enable frame-relay switching on the Frame Relay provider edge (PE) router.
- Customer edge (CE) routers must support Bridge-group Virtual Interface or Routed Bridge Encapsulation.

## Frame Relay DLCI-to-ATM AAL5SNAP Bridged Interworking

This feature provides interoperability between the ATM attachment VC and Frame Relay attachment VC connected to different PE routers. This interworking uses the bridged encapsulation corresponding to the bridged (Ethernet) interworking mechanism. The Ethernet frames are carried through the MPLS network using Ethernet over MPLS (EoMPLS). This feature is configured only in the bridged mode and not in the routed mode.

The following figure shows the interworking function performed in the PE routers that are connected to the ATM attachment VC and the Frame Relay attachment VC.

Figure 12: Network Topology for Frame Relay DLCI-to-ATM AAL5SNAP Bridged Interworking

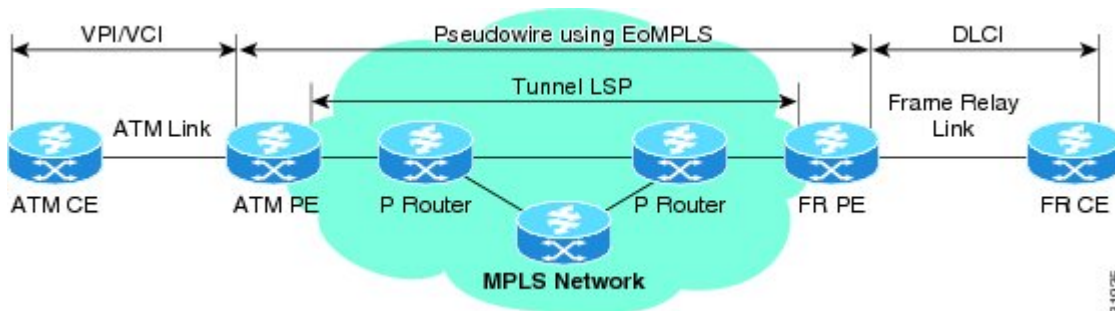

On the ATM PE router with interworking function, when traffic flows from the ATM segment to MPLS cloud, the bridged encapsulation (ATM and SNAP header) is discarded and the Ethernet frame is encapsulated with the labels required to go through the pseudowire using the VC type 5 (Ethernet). In the opposite direction, after the label disposition from the MPLS cloud, the Ethernet frames are encapsulated over AAL5SNAP using bridged encapsulation.

On the FR PE router with interworking function, when traffic flows from the FR segment to the MPLS cloud, the bridged encapsulation (Frame Relay and SNAP header) is discarded and the Ethernet frame is encapsulated with the labels required to go through the pseudowire, using the VC type 5 (Ethernet). In the opposite direction, after the label disposition from the MPLS cloud, the Ethernet frames are encapsulated over FR using bridged encapsulation.

The PE router automatically supports translation of both Cisco and IETF Frame Relay encapsulation types coming from the Customer edge (CE) router, but translates only to IETF when sending to the CE router. The Cisco CE router can handle the IETF encapsulation on receipt, even if it is configured to send Cisco encapsulation.

The following modes are supported:

- The ATM permanent virtual circuit (PVC) mode with the AAL5SNAP encapsulation type, and the existing Quality of Service (QoS) functionality for ATM PVCs.
- The Frame Relay DLCI mode, and the existing QoS functionality for Frame Relay.

PVC status signaling works the same way it does in the like-to-like case. The PE router reports the PVC status to the CE router, based on the availability of the pseudowire.

The attachment circuit maximum transmission unit (MTU) on both sides of the pseudowire must match when connected over MPLS. The non-AAL5 traffic (such as OAM cells) is punted to be processed at the RP level. A VC that is configured with OAM cell emulation on the ATM PE router (using the **oam-ac emulation-enable** command) can send end-to-end F5 loopback cells at configured intervals toward the CE router. When the pseudowire is down, an end-to-end F5 segment alarm indication signal (AIS) and remote defect indication (RDI) is sent from the PE router to the CE router.

The following figure shows the protocol stack for the Frame Relay DLCI-to-ATM AAL5SNAP Bridged Interworking feature.

Figure 13: Protocol Stack for Frame Relay DLCI-to-ATM AAL5SNAP Bridged Interworking

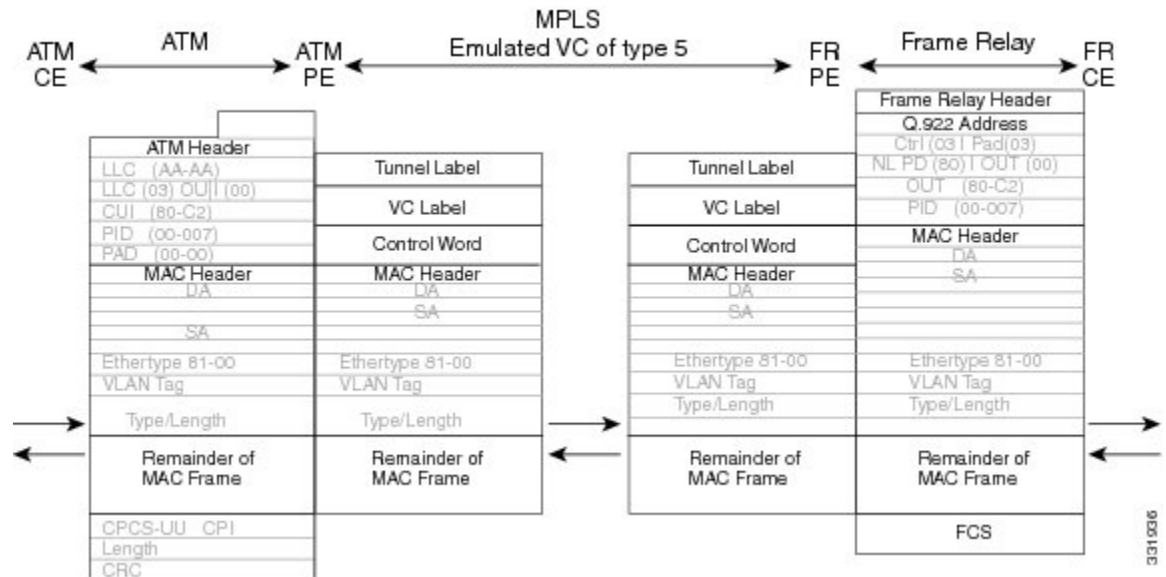

## Configuring Frame Relay DLCI-to-ATM AAL5SNAP Bridged Interworking

To configure the Frame Relay DLCI-to-ATM AAL5SNAP Bridged Interworking feature on an ATM-PE router, perform the following steps:

### SUMMARY STEPS

1. **enable**
2. **configure terminal**
3. **Router(config)# no ip domain lookup**
4. **mpls label range** minimum-value maximum-value [static minimum-static-value maximum-static-value]
5. **mpls label protocol ldp**
6. **mpls ip default-route**
7. **mpls ldp graceful-restart**
8. **xconnect logging pseudowire status**
9. **pseudowire-class** [pw-class-name]
10. **encapsulation mpls**
11. **interworking ethernet**
12. **exit**
13. **interface loopback** loopback-interface-number
14. **ip address** ip-address mask
15. **exit**
16. **interface GigabitEthernet** slot/subslot/port
17. **ip address** ip-address mask

18. **negotiation auto**
19. **mpls ip**
20. **exit**
21. **interface atm** *slot/subslot/port*
22. **no ip address**
23. **atm clock internal**
24. **no atm enable-ilmi-trap**
25. **exit**
26. **interface atm** *slot/subslot/port* [*.subinterface-number* {**point-to-point**}]
27. **mtu** *bytes*
28. **no atm enable-ilmi-trap**
29. **pvc** [*name*] *vpi/vci* **l2transport**
30. **encapsulation** *encapsulation-type*
31. **xconnect** *peer-ip-address* *vc-id* **encapsulation mpls pw-class** *pw-class-name*
32. **exit**

## DETAILED STEPS

|        | Command or Action                                                                                                                                                                                               | Purpose                                                                                                                             |
|--------|-----------------------------------------------------------------------------------------------------------------------------------------------------------------------------------------------------------------|-------------------------------------------------------------------------------------------------------------------------------------|
| Step 1 | <b>enable</b><br><b>Example:</b><br>Router> <b>enable</b>                                                                                                                                                       | <b>Enables the privileged EXEC mode.</b><br><b>Enter your password, if prompted.</b>                                                |
| Step 2 | <b>configure terminal</b><br><b>Example:</b><br>Router# <b>configure terminal</b>                                                                                                                               | Enters the global configuration mode.                                                                                               |
| Step 3 | <b>Router(config)# no ip domain lookup</b>                                                                                                                                                                      | Disables the IP domain naming system (DNS).                                                                                         |
| Step 4 | <b>mpls label range</b> <i>minimum-value maximum-value</i> [ <i>static minimum-static-value maximum-static-value</i> ]<br><b>Example:</b><br>Router (config)# <b>mpls label range 101 4000 static 4001 5001</b> | Configures the range of local labels available for use with Multiprotocol Label Switching (MPLS) applications on packet interfaces. |
| Step 5 | <b>mpls label protocol ldp</b><br><b>Example:</b><br>Router (config)# <b>mpls label protocol ldp</b>                                                                                                            | Specifies label distribution protocol (LDP) for the ATM-PE router.                                                                  |
| Step 6 | <b>mpls ip default-route</b><br><b>Example:</b>                                                                                                                                                                 | Enables the distribution of labels associated with the IP default route.                                                            |



|                | Command or Action                                                                                                               | Purpose                                                                                                          |
|----------------|---------------------------------------------------------------------------------------------------------------------------------|------------------------------------------------------------------------------------------------------------------|
|                | <code>Router(config)# mpls ip default-route</code>                                                                              |                                                                                                                  |
| <b>Step 7</b>  | <b>mpls ldp graceful-restart</b><br><b>Example:</b><br><code>Router(config)# mpls ldp graceful-restart</code>                   | Enables MPLS LDP graceful restart.                                                                               |
| <b>Step 8</b>  | <b>xconnect logging pseudowire status</b><br><b>Example:</b><br><code>Router(config)# xconnect logging pseudowire status</code> | Enables system logging (syslog) reporting of pseudowire status events.                                           |
| <b>Step 9</b>  | <b>pseudowire-class [pw-class-name]</b><br><b>Example:</b><br><code>Router(config)# pseudowire-class atm-fr-bridged</code>      | Establishes a pseudowire class with a name that you specify, and enters the pseudowire class configuration mode. |
| <b>Step 10</b> | <b>encapsulation mpls</b><br><b>Example:</b><br><code>Router(config-pw-class)# encapsulation mpls</code>                        | Enables MPLS encapsulation on the interface.                                                                     |
| <b>Step 11</b> | <b>interworking ethernet</b><br><b>Example:</b><br><code>Router(config-pw-class)# interworking ethernet</code>                  | Enables the L2VPN Ethernet interworking feature.                                                                 |
| <b>Step 12</b> | <b>exit</b>                                                                                                                     | Exits pseudowire class configuration mode.                                                                       |
| <b>Step 13</b> | <b>interface loopback loopback-interface-number</b><br><b>Example:</b><br><code>Router(config)# interface loopback 0</code>     | Specifies the loopback logical interface.                                                                        |
| <b>Step 14</b> | <b>ip address ip-address mask</b><br><b>Example:</b><br><code>Router(config-if)# ip address 44.1.1.2 255.255.255.255</code>     | Specifies the IP address for the Loopback interface.                                                             |
| <b>Step 15</b> | <b>exit</b>                                                                                                                     | Exits interface configuration mode.                                                                              |

|                | Command or Action                                                                                                                         | Purpose                                                                                                                             |
|----------------|-------------------------------------------------------------------------------------------------------------------------------------------|-------------------------------------------------------------------------------------------------------------------------------------|
| <b>Step 16</b> | <b>interface GigabitEthernet</b> <i>slot/subslot/port</i><br><b>Example:</b><br>Router(config)# <b>interface GigabitEthernet</b><br>0/0/1 | Specifies the Gigabit Ethernet interface for the connection of the PE routers.                                                      |
| <b>Step 17</b> | <b>ip address</b> <i>ip-address mask</i><br><b>Example:</b><br>Router(config-if)# <b>ip address</b> 10.10.1.2<br>255.255.255.0            | Specifies the IP address for the Gigabit Ethernet interface.                                                                        |
| <b>Step 18</b> | <b>negotiation auto</b><br><b>Example:</b><br>Router(config-if)# <b>negotiation auto</b>                                                  | Enables the auto negotiation protocol to configure the speed, duplex, and automatic flow control of the Gigabit Ethernet interface. |
| <b>Step 19</b> | <b>mpls ip</b><br><b>Example:</b><br>Router(config-if)# <b>mpls ip</b>                                                                    | Enables MPLS forwarding of the IPv4 packets towards the MPLS core.                                                                  |
| <b>Step 20</b> | <b>exit</b>                                                                                                                               | Exits interface configuration mode.                                                                                                 |
| <b>Step 21</b> | <b>interface atm</b> <i>slot/subslot/port</i><br><b>Example:</b><br>Router(config)# <b>interface atm</b> 0/1/2                            | Configures an ATM interface and enters interface configuration mode.                                                                |
| <b>Step 22</b> | <b>no ip address</b><br><b>Example:</b><br>Router(config-if)# <b>no ip address</b>                                                        | Removes the previously configured IP address.                                                                                       |
| <b>Step 23</b> | <b>atm clock internal</b><br><b>Example:</b><br>Router(config-if)# <b>atm clock internal</b>                                              | Enables the ATM interface to generate the transmit clock internally.                                                                |
| <b>Step 24</b> | <b>no atm enable-ilmi-trap</b><br><b>Example:</b><br>Router(config-if)# <b>no atm enable-ilmi-trap</b>                                    | Disables the Integrated Local Management Interface (ILMI) ATM traps.                                                                |
| <b>Step 25</b> | <b>exit</b>                                                                                                                               | Exits interface configuration mode.                                                                                                 |

|         | Command or Action                                                                                                                                                                                                     | Purpose                                                                                                                                           |
|---------|-----------------------------------------------------------------------------------------------------------------------------------------------------------------------------------------------------------------------|---------------------------------------------------------------------------------------------------------------------------------------------------|
| Step 26 | <b>interface atm slot/subslot/port [.subinterface-number {point-to-point}]</b><br><b>Example:</b><br><pre>Router(config)# interface atm 0/1/2.1 point-to-point</pre>                                                  | Configures an ATM interface and enters interface configuration mode.                                                                              |
| Step 27 | <b>mtu bytes</b><br><b>Example:</b><br><pre>Router(config-subif)# mtu 1500</pre>                                                                                                                                      | Adjusts the maximum packet size or maximum transmission unit (MTU) size.<br><b>Note</b> The MTU sizes of both the attachment circuits must match. |
| Step 28 | <b>no atm enable-ilmi-trap</b><br><b>Example:</b><br><pre>Router(config-subif)# no atm enable-ilmi-trap</pre>                                                                                                         | Disables the ILMI ATM traps.                                                                                                                      |
| Step 29 | <b>pvc [name ] vpi/vci l2transport</b><br><b>Example:</b><br><pre>Router(config-subif)# pvc cisco 10/100 l2transport</pre>                                                                                            | Assigns a name to an ATM PVC, specifies the encapsulation type on an ATM PVC, and enters ATM virtual circuit configuration mode.                  |
| Step 30 | <b>encapsulation encapsulation-type</b><br><b>Example:</b><br><pre>Router(config-if-atm-l2trans-pvc)# encapsulation aal5snap</pre>                                                                                    | Sets the AAL5SNAP encapsulation (Any-to-Any) for the ATM point-to-point interface.                                                                |
| Step 31 | <b>xconnect peer-ip-address vc-id encapsulation mpls pw-class pw-class-name</b><br><b>Example:</b><br><pre>Router(config-if-atm-l2trans-pvc)# xconnect 190.1.1.1 100 encapsulation mpls pw-class atm-fr-bridged</pre> | Binds an attachment circuit to a pseudowire and configures an Any Transport over MPLS (AToM) static pseudowire.                                   |
| Step 32 | <b>exit</b>                                                                                                                                                                                                           | Exits global configuration mode.                                                                                                                  |

## Example: Frame Relay-to-ATM Bridged Interworking on an ATM-PE Router

The following example shows the configuration of the Frame Relay-to-ATM Bridged Interworking feature on an ATM-PE router:

```
no ip domain lookup
mpls label range 101 4000 static 4001 5001
```

```

mpls label protocol ldp
mpls ip default-route
mpls ldp graceful-restart
xconnect logging pseudowire status
!
pseudowire-class atm-fr-bridged
encapsulation mpls
interworking ethernet
!
interface Loopback0
ip address 44.1.1.2 255.255.255.255
!
interface GigabitEthernet0/0/1
ip address 10.10.1.2 255.255.255.0
negotiation auto
mpls ip
!
interface ATM0/1/2
no ip address
atm clock INTERNAL
no atm enable-ilmi-trap
!
interface ATM0/1/2.1 point-to-point
mtu 1500
no atm enable-ilmi-trap
pvc 10/100 12transport
encapsulation aal5snap
xconnect 190.1.1.1 100 pw-class atm-fr-bridged
!
!

```

## Example: Frame Relay-to-ATM Bridged Interworking on a Frame Relay-PE Router

The following example shows the configuration of the Frame Relay-to-ATM Bridged Interworking feature on a Frame Relay-PE router:

```

ipv6 unicast-routing
mpls label protocol ldp
mpls ip default-route
mpls ldp graceful-restart
frame-relay switching
xconnect logging pseudowire status
!
controller T1 0/3/0
framing esf
clock source internal
linecode b8zs
cablelength long 0db
channel-group 0 timeslots 1-24
!
pseudowire-class atm-fr-bridged
encapsulation mpls
interworking ethernet
!
interface Loopback0
ip address 190.1.1.1 255.255.255.255
!
interface Serial0/3/0:0
no ip address
encapsulation frame-relay

```

```

frame-relay intf-type dce
frame-relay interface-dlci 101 switched
!
interface GigabitEthernet1/3/1
ip address 10.10.1.1 255.255.255.0
negotiation auto
mpls ip
!
connect fr-atm-2 Serial0/3/0:0 101 l2transport
xconnect 44.1.1.2 100 pw-class atm-fr-bridged
!

```

## Gigabit EtherChannel for Virtual Private Wire Service

GEC for AToM is a solution for a VPWS transporting Layer 2 packets over an MPLS backbone with GEC.

This feature enables service providers to supply connectivity between customer sites having data link layer (Layer 2) networks, by using a single, integrated, packet-based network infrastructure—a Cisco MPLS network. Instead of separate networks with separate network management environments, service providers can deliver Layer 2 connections over an MPLS backbone.

### Supported Modes

The following modes are supported in the GEC for VPWS feature:

#### GEC Like-to-Like Mode

The GEC Like-to-Like mode allows switching of data between two physical interfaces in which the two segments (CE1-PE1 and CE2-PE2, as shown in the following figure are both of GEC type.

The GEC Like-to-Like mode has the following features:

**Figure 14: Topology of the GEC Like-to-Like Mode for the GEC for VPWS Feature**

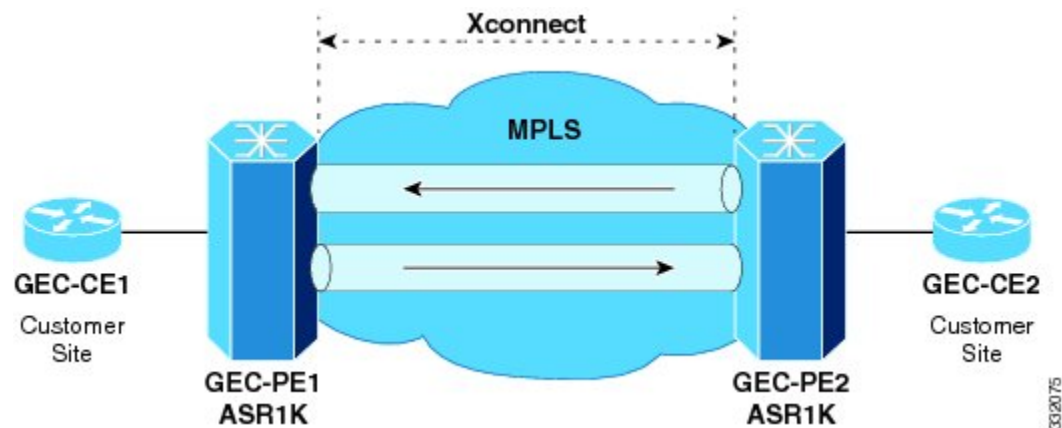

#### Any-to-GEC Mode

The Any-to-GEC mode allows switching of data between two physical interfaces in which the two segments, CE1-PE1 and CE2-PE2, are both of different types, while one is GEC, the other can be PPP, Ethernet, Frame Relay, or ATM, as shown in the following figure.

The Any-to-GEC mode has the following features:

*Figure 15: Topology of the Any-to-GEC Mode for the GEC for VPWS Feature*

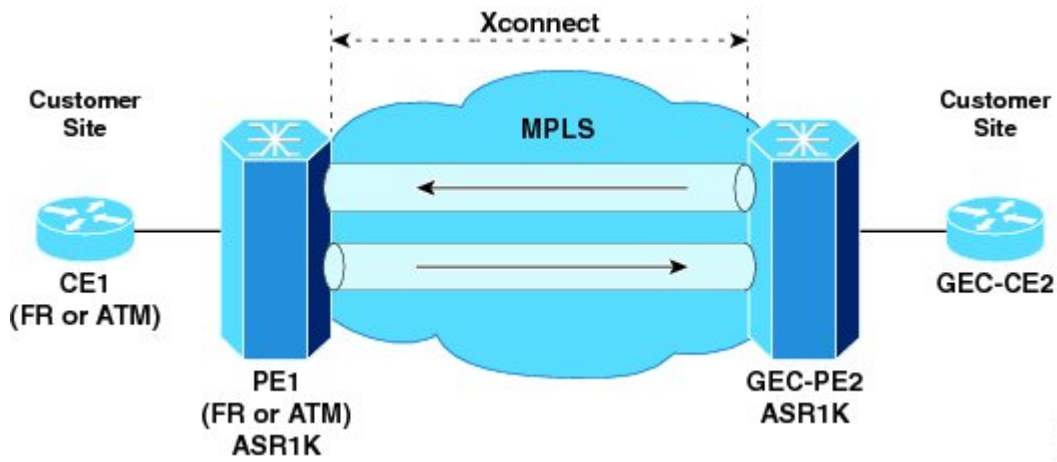

**Note** Bridged interworking is used when Layer 2 (L2) packets are considered without regard for Layer 3 contents. In bridged interworking, Ethernet frames that are extracted from the attachment circuit are sent over the MPLS pseudowire.



**Note** Routed interworking is used to carry Layer 3 packets. In routed interworking, IP packets that are extracted from the attachment circuits are sent over the MPLS pseudowire.

## Restrictions for Gigabit EtherChannel for Virtual Private Wire Service

The following are the restrictions for Gigabit EtherChannel for VPWS are the followings:

- GEC for VPWS does not support Q-in-Q encapsulation and remote port shutdown.
- A maximum four member links are supported under the port channel and a maximum of 64 port channel bundles are supported per router.

## Configuring Gigabit EtherChannel for Virtual Private Wire Service

The GEC VPWS support feature is supported by AToM on the EtherChannel Interface, and includes the following features:

### EtherChannel-to-EtherChannel over MPLS (Bridged) Interworking

Configure L2VPN interworking on the upstream interfaces of the PE routers.

After configuring MPLS Forwarding, perform the following steps on the downstream interfaces of the PE routers:

## SUMMARY STEPS

1. enable
2. **configure terminal**
3. mpls label protocol ldp
4. interface loopback loopback-interface-number
5. ip address ip-address mask
6. exit
7. pseudowire-class pw-class-name
8. encapsulation mpls
9. interworking ethernet
10. exit
11. interface port-channel number
12. xconnect peer-ip-address vc-id encapsulation mpls pseudowire-class pw-class-name
13. interface GigabitEthernet slot | subslot | port
14. channel-group port-channel number

## DETAILED STEPS

|               | Command or Action                                                                                       | Purpose                                                                    |
|---------------|---------------------------------------------------------------------------------------------------------|----------------------------------------------------------------------------|
| <b>Step 1</b> | enable                                                                                                  | Changes the privilege level for the corresponding CLI session.             |
| <b>Step 2</b> | <b>configure terminal</b><br><br><b>Example:</b><br><br>Router# configure terminal                      | Enters global configuration mode.                                          |
| <b>Step 3</b> | mpls label protocol ldp<br><br><b>Example:</b><br><br>Router# mpls label protocol ldp                   | Specifies that LDP is the default label distribution protocol.             |
| <b>Step 4</b> | interface loopback loopback-interface-number<br><br><b>Example:</b><br><br>Router# interface loopback 1 | Specifies the loopback interface, and enters interface configuration mode. |
| <b>Step 5</b> | ip address ip-address mask<br><br><b>Example:</b><br><br>Router# ip address 10.10.2.1 255.255.255.0     | Sets the IP address and mask for the loopback interface.                   |
| <b>Step 6</b> | exit                                                                                                    | Exits interface configuration mode.                                        |

|                | Command or Action                                                                                                                                                                                   | Purpose                                                                                                                                                                                                                                                                                                                                                |
|----------------|-----------------------------------------------------------------------------------------------------------------------------------------------------------------------------------------------------|--------------------------------------------------------------------------------------------------------------------------------------------------------------------------------------------------------------------------------------------------------------------------------------------------------------------------------------------------------|
| <b>Step 7</b>  | pseudowire-class pw-class-name<br><b>Example:</b><br><br>Router(config)# pseudowire-class gec-bridged                                                                                               | Specifies the name of a Layer 2 pseudowire class and enters the pseudowire class configuration mode.                                                                                                                                                                                                                                                   |
| <b>Step 8</b>  | encapsulation mpls<br><b>Example:</b><br><br>Router(config-pw)# encapsulation mpls                                                                                                                  | Uses MPLS as the tunneling method to encapsulate data in the pseudowire.                                                                                                                                                                                                                                                                               |
| <b>Step 9</b>  | interworking ethernet<br><b>Example:</b><br><br>Router(config-pw)# interworking ethernet                                                                                                            | Enables the L2VPN Interworking feature, and causes Ethernet frames to be extracted from the attachment circuit and sent over the pseudowire. Ethernet end-to-end transmission is assumed. Attachment circuit frames that do not contain Ethernet frames are dropped. In the case of VLAN, the VLAN tag is removed, which leaves a pure Ethernet frame. |
| <b>Step 10</b> | exit                                                                                                                                                                                                | Exits xconnect configuration mode.                                                                                                                                                                                                                                                                                                                     |
| <b>Step 11</b> | interface port-channel number<br><b>Example:</b><br><br>Router(config)# interface port-channel 1                                                                                                    | Creates an EtherChannel interface on the Cisco Cable Modem Termination System (CMTS).                                                                                                                                                                                                                                                                  |
| <b>Step 12</b> | xconnect peer-ip-address vc-id encapsulation mpls pseudowire-class pw-class-name<br><b>Example:</b><br><br>Router(config-if)# xconnect 10.0.0.1 707 encapsulation mpls pseudowire-class gec-bridged | Binds an attachment circuit to a pseudowire to configure an AToM static pseudowire, specifies MPLS as the tunneling method, and enters the xconnect configuration mode.                                                                                                                                                                                |
| <b>Step 13</b> | interface GigabitEthernet slot   subslot   port<br><b>Example:</b><br><br>Router(config)# interface GigabitEthernet 0/0/1                                                                           | Specifies the Gigabit Ethernet interface, and enters interface configuration mode.                                                                                                                                                                                                                                                                     |
| <b>Step 14</b> | channel-group port-channel number<br><b>Example:</b><br><br>Router(config-if) channel-group 1                                                                                                       | Configures an EtherChannel interface to an EtherChannel group.                                                                                                                                                                                                                                                                                         |

### What to do next



**Note** The EtherChannel-to-EtherChannel over MPLS (Bridged) Interworking mode is also supported under VLAN.



## EtherChannel-to-EtherChannel over MPLS (Routed) Interworking

Configure L2VPN interworking on the upstream interfaces of the PE routers.

After configuring MPLS Forwarding, perform the following steps on the downstream interfaces of the PE routers:

### SUMMARY STEPS

1. enable
2. **configure terminal**
3. mpls label protocol ldp
4. interface loopback loopback-interface-number
5. ip address ip-address mask
6. exit
7. pseudowire-class pw-class-name
8. encapsulation mpls
9. interworking ip
10. exit
11. interface port-channel number
12. xconnect peer-ip-address vc-id encapsulation mpls pseudowire-class pw-class-name
13. interface GigabitEthernet slot | subslot | port
14. channel-group port-channel number

### DETAILED STEPS

|               | Command or Action                                                                                       | Purpose                                                                    |
|---------------|---------------------------------------------------------------------------------------------------------|----------------------------------------------------------------------------|
| <b>Step 1</b> | enable                                                                                                  | Changes the privilege level for the corresponding CLI session.             |
| <b>Step 2</b> | <b>configure terminal</b><br><br><b>Example:</b><br><br>Router# configure terminal                      | Enters global configuration mode.                                          |
| <b>Step 3</b> | mpls label protocol ldp<br><br><b>Example:</b><br><br>Router# mpls label protocol ldp                   | Specifies that LDP is the default label distribution protocol.             |
| <b>Step 4</b> | interface loopback loopback-interface-number<br><br><b>Example:</b><br><br>Router# interface loopback 1 | Specifies the loopback interface, and enters interface configuration mode. |
| <b>Step 5</b> | ip address ip-address mask<br><br><b>Example:</b>                                                       | Sets the IP address and mask for the loopback interface.                   |

|                | Command or Action                                                                                                                                                                              | Purpose                                                                                                                                                                                                         |
|----------------|------------------------------------------------------------------------------------------------------------------------------------------------------------------------------------------------|-----------------------------------------------------------------------------------------------------------------------------------------------------------------------------------------------------------------|
|                | Router# ip address 10.10.2.1 255.255.255.0                                                                                                                                                     |                                                                                                                                                                                                                 |
| <b>Step 6</b>  | exit                                                                                                                                                                                           | Exits interface configuration mode.                                                                                                                                                                             |
| <b>Step 7</b>  | pseudowire-class pw-class-name<br><b>Example:</b><br>Router(config)# pseudowire-class gec-bridged                                                                                              | Specifies the name of a Layer 2 pseudowire class and enters pseudowire class configuration mode.                                                                                                                |
| <b>Step 8</b>  | encapsulation mpls<br><b>Example:</b><br>Router(config-pw)# encapsulation mpls                                                                                                                 | Uses MPLS as the tunneling method to encapsulate data in the pseudowire.                                                                                                                                        |
| <b>Step 9</b>  | interworking ip<br><b>Example:</b><br>Router(config-pw)# interworking ip                                                                                                                       | Enables the L2VPN Interworking feature, and causes IP packets to be extracted from the attachment circuit and sent over the pseudowire. Attachment circuit frames that do not contain IPv4 packets are dropped. |
| <b>Step 10</b> | exit                                                                                                                                                                                           | Exits xconnect configuration mode.                                                                                                                                                                              |
| <b>Step 11</b> | interface port-channel number<br><b>Example:</b><br>Router(config)# interface port-channel 1                                                                                                   | Creates an EtherChannel interface on the Cisco Cable Modem Termination System (CMTS).                                                                                                                           |
| <b>Step 12</b> | xconnect peer-ip-address vc-id encapsulation mpls pseudowire-class pw-class-name<br><b>Example:</b><br>Router(config-if)# xconnect 10.0.0.1 707 encapsulation mpls pseudowire-class gec-routed | Binds an attachment circuit to a pseudowire to configure an AToM static pseudowire, specifies MPLS as the tunneling method, and enters xconnect configuration mode.                                             |
| <b>Step 13</b> | interface GigabitEthernet slot   subslot   port<br><b>Example:</b><br>Router(config)# interface GigabitEthernet 0/0/1                                                                          | Specifies the Gigabit Ethernet interface, and enters interface configuration mode.                                                                                                                              |
| <b>Step 14</b> | channel-group port-channel number<br><b>Example:</b><br>Router(config-if) channel-group 1                                                                                                      | Configures EtherChannel interfaces to an EtherChannel group.                                                                                                                                                    |

**What to do next**

**Note** The EtherChannel-to-EtherChannel over MPLS (Routed) Interworking mode is also supported under VLAN.

## Example: GEC Like-to-Like (Routed) Interworking

The following example shows the configuration of the GEC Like-to-Like (Routed) Interworking feature:

```
no ip domain lookup
mpls label range 101 4000 static 4001 5001
mpls label protocol ldp
mpls ip default-route
mpls ldp graceful-restart
xconnect logging pseudowire status
!
pseudowire-class gec-bridged
encapsulation mpls
interworking ethernet!
pseudowire-class gec-routed
encapsulation mpls
interworking ip
!
interface Loopback0
ip address 44.1.1.2 255.255.255.255
!
interface GigabitEthernet0/0/1
ip address 10.10.1.2 255.255.255.0
negotiation auto
mpls ip
!
interface port-channel 1
xconnect 190.1.1.1 100 encapsulation mpls pw-class gec-bridged
!
interface GigabitEthernet0/0/3
channel-group 1
!
interface GigabitEthernet0/0/2
channel-group 1
!
router ospf 10
log-adjacency-changes
network 44.1.1.2 0.0.0.0 area 0
network 10.10.1.2 0.0.0.255 area 0
```

## Any-to-EtherChannel over MPLS (Bridged) Interworking

You can configure Any-to-EtherChannel over MPLS (Bridged) interworking on the Cisco ASR 1000 Series Routers.

Any-to-EtherChannel over MPLS (Bridged) interworking supports the following modes:

- Frame Relay-to-EtherChannel
- ATM-to-EtherChannel
- Ethernet-to-EtherChannel

Irrespective of the mode used, in Any-to-EtherChannel over MPLS (Bridged) interworking, configure L2VPN interworking on the upstream interfaces of PE routers.

Perform the following steps on the downstream interfaces of the PE routers:

## SUMMARY STEPS

1. enable
2. **configure terminal**
3. mpls label protocol ldp
4. interface loopback loopback-interface-number
5. ip address ip-address mask
6. exit
7. pseudowire-class pw-class-name
8. encapsulation mpls
9. interworking ethernet
10. interface GigabitEthernet slot | subslot | port
11. xconnect peer-ip-address vc-id encapsulation mpls pseudowire-class pw-class-name

## DETAILED STEPS

|               | Command or Action                                                                                   | Purpose                                                                                              |
|---------------|-----------------------------------------------------------------------------------------------------|------------------------------------------------------------------------------------------------------|
| <b>Step 1</b> | enable                                                                                              | Changes the privilege level for the corresponding CLI session.                                       |
| <b>Step 2</b> | <b>configure terminal</b><br><b>Example:</b><br><br>Router# configure terminal                      | Enters global configuration mode.                                                                    |
| <b>Step 3</b> | mpls label protocol ldp<br><b>Example:</b><br><br>Router# mpls label protocol ldp                   | Specifies that LDP is the default label distribution protocol.                                       |
| <b>Step 4</b> | interface loopback loopback-interface-number<br><b>Example:</b><br><br>Router# interface loopback 1 | Specifies the loopback interface, and enters the interface configuration mode.                       |
| <b>Step 5</b> | ip address ip-address mask<br><b>Example:</b><br><br>Router# ip address 10.10.2.1 255.255.255.0     | Sets the IP address and mask for the loopback interface.                                             |
| <b>Step 6</b> | exit                                                                                                | Exits interface configuration mode.                                                                  |
| <b>Step 7</b> | pseudowire-class pw-class-name<br><b>Example:</b>                                                   | Specifies the name of a Layer 2 pseudowire class and enters the pseudowire class configuration mode. |

|                | Command or Action                                                                                                                                                                                                  | Purpose                                                                                                                                                                                                                                                                                                                                                |
|----------------|--------------------------------------------------------------------------------------------------------------------------------------------------------------------------------------------------------------------|--------------------------------------------------------------------------------------------------------------------------------------------------------------------------------------------------------------------------------------------------------------------------------------------------------------------------------------------------------|
|                | <code>Router(config)# pseudowire-class gec-bridged</code>                                                                                                                                                          |                                                                                                                                                                                                                                                                                                                                                        |
| <b>Step 8</b>  | <p>encapsulation mpls</p> <p><b>Example:</b></p> <pre>Router(config-pw)# encapsulation mpls</pre>                                                                                                                  | Uses MPLS as the tunneling method to encapsulate data in the pseudowire.                                                                                                                                                                                                                                                                               |
| <b>Step 9</b>  | <p>interworking ethernet</p> <p><b>Example:</b></p> <pre>Router(config-pw)# interworking ethernet</pre>                                                                                                            | Enables the L2VPN Interworking feature, and causes Ethernet frames to be extracted from the attachment circuit and sent over the pseudowire. Ethernet end-to-end transmission is assumed. Attachment circuit frames that do not contain Ethernet frames are dropped. In the case of VLAN, the VLAN tag is removed, which leaves a pure Ethernet frame. |
| <b>Step 10</b> | <p>interface GigabitEthernet slot   subslot   port</p> <p><b>Example:</b></p> <pre>Router(config)# interface GigabitEthernet 0/0/1</pre>                                                                           | Specifies the Gigabit Ethernet interface, and enters interface configuration mode.                                                                                                                                                                                                                                                                     |
| <b>Step 11</b> | <p>xconnect peer-ip-address vc-id encapsulation mpls pseudowire-class pw-class-name</p> <p><b>Example:</b></p> <pre>Router(config-if)# xconnect 10.0.0.1 707 encapsulation mpls pseudowire-class gec-bridged</pre> | Binds an attachment circuit to a pseudowire to configure an AToM static pseudowire, specifies MPLS as the tunneling method, and enters the xconnect configuration mode.                                                                                                                                                                                |

### What to do next



**Note** Ethernet-to-EtherChannel over MPLS (Bridge) Interworking mode is also supported under VLAN.

## Any-to-EtherChannel over MPLS (Routed) Interworking

You can configure Any-to-EtherChannel over MPLS (Routed) interworking on the Cisco ASR 1000 Series Routers.

Any-to-EtherChannel over MPLS (Routed) interworking supports the following modes:

- ATM-to-EtherChannel
- Ethernet-to-EtherChannel
- PPP-to-EtherChannel

Configure L2VPN interworking on the upstream interfaces of PE routers.

Perform the following steps on the downstream interfaces of the PE routers:

## SUMMARY STEPS

1. **enable**
2. configure terminal
3. ipv6 unicast-routing
4. **mpls ip default-route**
5. **mpls ldp graceful-restart**
6. **xconnect logging pseudowire status**
7. controller t1 slot/subslot/port
8. clock source internal
9. linecode b8zs
10. cablelength long db-loss-value
11. channel-group *channel-group-number* timeslots *range*
12. exit
13. pseudowire-class [*pw-class-name*]
14. encapsulation mpls
15. interworking ethernet
16. exit
17. *interface loopback loopback-interface-number*
18. **ip address ip-address mask**
19. **exit**
20. **interface serial** slot/subslot/port:timeslot
21. no ip address
22. **encapsulation ppp**
23. clock source internal
24. xconnect peer-loopback vc-id pw-class pe-class-name

## DETAILED STEPS

|        | Command or Action                                                          | Purpose                                                                          |
|--------|----------------------------------------------------------------------------|----------------------------------------------------------------------------------|
| Step 1 | <b>enable</b><br><b>Example:</b><br>Router> <b>enable</b>                  | <b>Enables privileged EXEC mode.</b><br><b>Enter your password, if prompted.</b> |
| Step 2 | configure terminal<br><b>Example:</b><br>Router# <b>configure terminal</b> | Enters global configuration mode.                                                |
| Step 3 | ipv6 unicast-routing<br><b>Example:</b><br>Router# ipv6 unicast-routing    | (Optional) Enables the task of forwarding the IPv6 unicast datagrams.            |
| Step 4 | <b>mpls ip default-route</b><br><b>Example:</b>                            | Enables the distribution of labels associated with the IP default route.         |

|                | Command or Action                                                                                                                                                          | Purpose                                                                                                         |
|----------------|----------------------------------------------------------------------------------------------------------------------------------------------------------------------------|-----------------------------------------------------------------------------------------------------------------|
|                | <code>Router(config)# mpls ip default-route</code>                                                                                                                         |                                                                                                                 |
| <b>Step 5</b>  | <b>mpls ldp graceful-restart</b><br><b>Example:</b><br><code>Router(config)# mpls ldp graceful-restart</code>                                                              | Enables MPLS LDP graceful restart.                                                                              |
| <b>Step 6</b>  | <b>xconnect logging pseudowire status</b><br><b>Example:</b><br><code>Router(config)# xconnect logging pseudowire status</code>                                            | Enables system logging (syslog) reporting of pseudowire status events.                                          |
| <b>Step 7</b>  | <code>controller t1 slot/subslot/port</code><br><b>Example:</b><br><code>Router(config)# controller T1 0/3/0</code>                                                        | Configures a T1 controller and enters controller configuration mode.                                            |
| <b>Step 8</b>  | <code>clock source internal</code><br><b>Example:</b><br><code>Router(config-controller)# clock source internal</code>                                                     | Configures the clock source of a DS1 link and uses the internal clock from the interface.                       |
| <b>Step 9</b>  | <code>linecode b8zs</code><br><b>Example:</b><br><code>Router(config-controller)# linecode b8zs</code>                                                                     | Specifies Binary 8-Zero Substitution (B8ZS) as the line code type for the T1 controller.                        |
| <b>Step 10</b> | <code>cablelength long db-loss-value</code><br><b>Example:</b><br><code>Router(config-controller)# cablelength long 0db</code>                                             | Decreases the transmit signal by 0 dB. This is the default value.                                               |
| <b>Step 11</b> | <code>channel-group <i>channel-group-number</i> timeslots <i>range</i></code><br><b>Example:</b><br><code>Router(config-controller)# channel-group 0 timeslots 1-24</code> | Configures serial WAN on a T1 or E1 interface.                                                                  |
| <b>Step 12</b> | <code>exit</code>                                                                                                                                                          | Exits pseudowire class configuration mode.                                                                      |
| <b>Step 13</b> | <code>pseudowire-class [<i>pw-class-name</i>]</code><br><b>Example:</b><br><code>Router(config)# pseudowire-class atm-fr-bridged</code>                                    | Establishes a pseudowire class with a name that you specify and enters the pseudowire class configuration mode. |

|                | Command or Action                                                                                                           | Purpose                                                                                                                                                             |
|----------------|-----------------------------------------------------------------------------------------------------------------------------|---------------------------------------------------------------------------------------------------------------------------------------------------------------------|
| <b>Step 14</b> | encapsulation mpls<br><b>Example:</b><br><br>Router(config-pw-class)# <b>encapsulation mpls</b>                             | Enables MPLS encapsulation on the interface.                                                                                                                        |
| <b>Step 15</b> | interworking ethernet<br><b>Example:</b><br><br>Router(config-pw-class)# <b>interworking ethernet</b>                       | Enables the L2VPN Ethernet interworking feature.                                                                                                                    |
| <b>Step 16</b> | exit                                                                                                                        | Exits pseudowire class configuration mode.                                                                                                                          |
| <b>Step 17</b> | <i>interface loopback loopback-interface-number</i><br><b>Example:</b><br><br>Router(config)# <b>interface loopback 0</b>   | Specifies the Loopback logical interface.                                                                                                                           |
| <b>Step 18</b> | <b>ip address ip-address mask</b><br><b>Example:</b><br><br>Router(config-if)# <b>ip address 44.1.1.2 255.255.255.255</b>   | Specifies the IP address for the Loopback interface.                                                                                                                |
| <b>Step 19</b> | exit                                                                                                                        | Exits the interface configuration mode.                                                                                                                             |
| <b>Step 20</b> | <b>interface serial slot/subslot/port:timeslot</b><br><b>Example:</b><br><br>Router(config)# <b>interface Serial0/3/0:0</b> | Specifies a serial interface created on a channelized T1 controller.                                                                                                |
| <b>Step 21</b> | no ip address<br><b>Example:</b><br><br>Router(config-if)# <b>no ip address</b>                                             | Removes the previously configured IP address.                                                                                                                       |
| <b>Step 22</b> | <b>encapsulation ppp</b><br><b>Example:</b><br><br>Router(config-if)# <b>encapsulation frame-relay</b>                      | Configures the PPP (for serial interface) encapsulation on serial interface.                                                                                        |
| <b>Step 23</b> | clock source internal                                                                                                       | Specifies that the T1/E1 link uses the internal clock from the interface.                                                                                           |
| <b>Step 24</b> | xconnect peer-loopback vc-id pw-class pe-class-name                                                                         | Binds an attachment circuit to a pseudowire to configure an AToM static pseudowire, specifies MPLS as the tunneling method, and enters xconnect configuration mode. |



**What to do next**

**Note** Ethernet-to-EtherChannel over MPLS (Bridge) Interworking mode is also supported under VLAN.

## High-Level Data Link Control-Ethernet Interworking

HDLC-Ethernet over MPLS is part of Any Transport over MPLS (AToM) solution. High-Level Link Control (HDLC) and Ethernet are two link-layer transports that utilize the AToM architecture. This section describes how these two transport types can communicate with each other using the AToM framework.

The following figure shows the topology of the HDLC-Ethernet Interworking feature.

*Figure 16: Topology of the HDLC-Ethernet Interworking Feature*

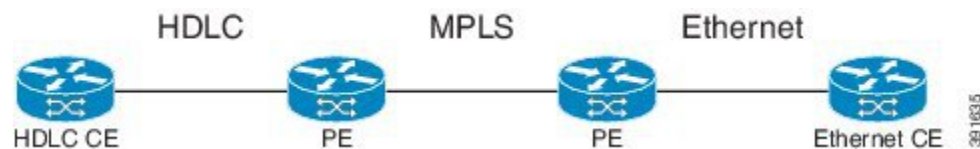

The following features are supported from Cisco IOS XE Release 3.13.0S on the Cisco ASR 1000 Series Aggregation Services Routers:

- HDLC-Ethernet Bridged-Mode Interworking
- HDLC-Ethernet Routed-Mode Interworking
- HDLC Encapsulation: CISCO
- Ethernet Encapsulation: Dot1Q, QinQ, Port Interface

## Prerequisites for HDLC-Ethernet Interworking

Perform the following tasks to enable HDLC-Ethernet interworking:

- Configure a controller slot on Ethernet CE:

```
controller E1 2/0
channel-group 0 timeslots 1
no shutdown
interface Serial12/0:0
no shutdown
```

- Configure an Ethernet CE interface for Ethernet interworking:

```
bridge irb
bridge 1 protocol ieee
bridge 1 route ip
interface Serial12/0:0
no bridge-group 1
no ip address
!
int BV11
no ip address
ip address 192.168.1.1 255.255.255.0
no shut
```

```

!
interface Serial2/0:0
description Connect to PE1
no ip address
encapsulation hdlc
bridge-group 1
no shut

```

- Configure an Ethernet CE interface for IP interworking:

```

interface Serial2/0:0
description Connect to PE1
ip address 192.168.1.1 255.255.255.0
encapsulation hdlc
no shut

```

## Restrictions for HDLC-Ethernet Interworking

The following features are not supported:

- HDLC encapsulation: none CISCO
- IPv6 is not supported in routed mode

## Configuring HDLC-Ethernet Interworking

HDLC-Ethernet Interworking can be configured in the following two modes:

### Bridge Mode

Perform the following steps to configure the HDLC-Ethernet Interworking in the bridge mode via interface-based configuration:

### On the HDLC-PE

#### SUMMARY STEPS

1. enable
2. **configure terminal**
3. pseudowire-class pw-class-name
4. encapsulation mpls
5. interworking ethernet
6. interface serial slot | subslot | port
7. **no ip address**
8. xconnect peer-ip-address vc-id pseudowire-class pw-class-name

#### DETAILED STEPS

|        | Command or Action | Purpose                                                        |
|--------|-------------------|----------------------------------------------------------------|
| Step 1 | enable            | Changes the privilege level for the corresponding CLI session. |

|               | Command or Action                                                                                                                                        | Purpose                                                                                                                                                                                                                                                                                                                                                |
|---------------|----------------------------------------------------------------------------------------------------------------------------------------------------------|--------------------------------------------------------------------------------------------------------------------------------------------------------------------------------------------------------------------------------------------------------------------------------------------------------------------------------------------------------|
| <b>Step 2</b> | <b>configure terminal</b><br><b>Example:</b><br><br>Router# configure terminal                                                                           | Enters global configuration mode.                                                                                                                                                                                                                                                                                                                      |
| <b>Step 3</b> | pseudowire-class pw-class-name<br><b>Example:</b><br><br>Router(config)# pseudowire-class pw-iw-ether                                                    | Specifies the name of a Layer 2 pseudowire class and enters pseudowire class configuration mode.                                                                                                                                                                                                                                                       |
| <b>Step 4</b> | encapsulation mpls<br><b>Example:</b><br><br>Router(config-pw)# encapsulation mpls                                                                       | Uses MPLS as the tunneling method to encapsulate data in the pseudowire.                                                                                                                                                                                                                                                                               |
| <b>Step 5</b> | interworking ethernet<br><b>Example:</b><br><br>Router(config-pw)# interworking ethernet                                                                 | Enables the L2VPN Interworking feature, and causes Ethernet frames to be extracted from the attachment circuit and sent over the pseudowire. Ethernet end-to-end transmission is assumed. Attachment circuit frames that do not contain Ethernet frames are dropped. In the case of VLAN, the VLAN tag is removed, which leaves a pure Ethernet frame. |
| <b>Step 6</b> | interface serial slot   subslot   port<br><b>Example:</b><br><br>Router(config)# <b>interface Serial0/1/0:0</b>                                          | Specifies the serial interface, and enters interface configuration mode.                                                                                                                                                                                                                                                                               |
| <b>Step 7</b> | <b>no ip address</b><br><b>Example:</b><br><br>Router(config-if)# <b>no ip address</b>                                                                   | Removes all the IP addresses of the interface.                                                                                                                                                                                                                                                                                                         |
| <b>Step 8</b> | xconnect peer-ip-address vc-id pseudowire-class pw-class-name<br><b>Example:</b><br><br>Router(config-if)# xconnect 17.17.17.17 100 pw-class pw-iw-ether | Binds an attachment circuit to a pseudowire to configure an AToM static pseudowire, specifies MPLS as the tunneling method, and enters xconnect configuration mode.                                                                                                                                                                                    |

## On the Ethernet PE

### SUMMARY STEPS

1. enable
2. **configure terminal**
3. pseudowire-class pw-class-name

4. `encapsulation mpls`
5. `interworking ethernet`
6. `interface GigabitEthernet slot | subslot | port`
7. `encapsulation dot1Q vlan-id`
8. `xconnect peer-ip-address vc-id pseudowire-class pw-class-name`

## DETAILED STEPS

|               | Command or Action                                                                                                                                  | Purpose                                                                                                                                                                                                                                                                                                                                                |
|---------------|----------------------------------------------------------------------------------------------------------------------------------------------------|--------------------------------------------------------------------------------------------------------------------------------------------------------------------------------------------------------------------------------------------------------------------------------------------------------------------------------------------------------|
| <b>Step 1</b> | <code>enable</code>                                                                                                                                | Changes the privilege level for the corresponding CLI session.                                                                                                                                                                                                                                                                                         |
| <b>Step 2</b> | <b>configure terminal</b><br><b>Example:</b><br><pre>Router# configure terminal</pre>                                                              | Enters global configuration mode.                                                                                                                                                                                                                                                                                                                      |
| <b>Step 3</b> | <p><code>pseudowire-class pw-class-name</code></p> <b>Example:</b><br><pre>Router(config)# pseudowire-class pw-1w-ether</pre>                      | Specifies the name of a Layer 2 pseudowire class and enters pseudowire class configuration mode.                                                                                                                                                                                                                                                       |
| <b>Step 4</b> | <p><code>encapsulation mpls</code></p> <b>Example:</b><br><pre>Router(config-pw)# encapsulation mpls</pre>                                         | Uses MPLS as the tunneling method to encapsulate data in the pseudowire.                                                                                                                                                                                                                                                                               |
| <b>Step 5</b> | <p><code>interworking ethernet</code></p> <b>Example:</b><br><pre>Router(config-pw)# interworking ethernet</pre>                                   | Enables the L2VPN Interworking feature, and causes Ethernet frames to be extracted from the attachment circuit and sent over the pseudowire. Ethernet end-to-end transmission is assumed. Attachment circuit frames that do not contain Ethernet frames are dropped. In the case of VLAN, the VLAN tag is removed, which leaves a pure Ethernet frame. |
| <b>Step 6</b> | <p><code>interface GigabitEthernet slot   subslot   port</code></p> <b>Example:</b><br><pre>Router(config)# interface GigabitEthernet0/0/0.3</pre> | Specifies the Gigabit Ethernet interface, and enters interface configuration mode.                                                                                                                                                                                                                                                                     |
| <b>Step 7</b> | <p><code>encapsulation dot1Q vlan-id</code></p> <b>Example:</b><br><pre>Router(config-if)# encapsulation dot1Q 3</pre>                             | Removes all the IP addresses of the interface.                                                                                                                                                                                                                                                                                                         |

|               | Command or Action                                                                                                                                                                  | Purpose                                                                                                                                                             |
|---------------|------------------------------------------------------------------------------------------------------------------------------------------------------------------------------------|---------------------------------------------------------------------------------------------------------------------------------------------------------------------|
| <b>Step 8</b> | xconnect peer-ip-address vc-id pseudowire-class<br>pw-class-name<br><br><b>Example:</b><br><br><pre>Router(config-if)# xconnect 16.16.16.16 100 pseudowire-class pw-iw-ether</pre> | Binds an attachment circuit to a pseudowire to configure an AToM static pseudowire, specifies MPLS as the tunneling method, and enters xconnect configuration mode. |

### What to do next

Perform the following steps to configure the HDLC-Ethernet Interworking in the bridge mode via protocol-based configuration:

## On the HDLC-PE

### SUMMARY STEPS

1. enable
2. **configure terminal**
3. **l2vpn xconnect context** xc-name
4. **interworking ethernet**
5. **member** interface-id
6. **member** ip-address vc-id **encapsulation mpls**

### DETAILED STEPS

|               | Command or Action                                                                                                          | Purpose                                                                                                                                                                                                                                                                                                                                                |
|---------------|----------------------------------------------------------------------------------------------------------------------------|--------------------------------------------------------------------------------------------------------------------------------------------------------------------------------------------------------------------------------------------------------------------------------------------------------------------------------------------------------|
| <b>Step 1</b> | enable                                                                                                                     | Changes the privilege level for the corresponding CLI session.                                                                                                                                                                                                                                                                                         |
| <b>Step 2</b> | <b>configure terminal</b><br><br><b>Example:</b><br><br><pre>Router# configure terminal</pre>                              | Enters global configuration mode.                                                                                                                                                                                                                                                                                                                      |
| <b>Step 3</b> | <b>l2vpn xconnect context</b> xc-name<br><br><b>Example:</b><br><br><pre>Router(config)# l2vpn xconnect context HDLC</pre> | Creates an empty cross-connect, and enters xconnect submode.                                                                                                                                                                                                                                                                                           |
| <b>Step 4</b> | <b>interworking ethernet</b><br><br><b>Example:</b><br><br><pre>Router(config)# interworking ethernet</pre>                | Enables the L2VPN Interworking feature, and causes Ethernet frames to be extracted from the attachment circuit and sent over the pseudowire. Ethernet end-to-end transmission is assumed. Attachment circuit frames that do not contain Ethernet frames are dropped. In the case of VLAN, the VLAN tag is removed, which leaves a pure Ethernet frame. |

|               | Command or Action                                                                                                                            | Purpose                                         |
|---------------|----------------------------------------------------------------------------------------------------------------------------------------------|-------------------------------------------------|
| <b>Step 5</b> | <b>member interface-id</b><br><b>Example:</b><br><pre>Router(config)# member serial0/1/0:0</pre>                                             | Adds an interface as an AC segment of xconnect. |
| <b>Step 6</b> | <b>member ip-address vc-id encapsulation mpls</b><br><b>Example:</b><br><pre>Router(config)# member 17.17.17.17 100 encapsulation mpls</pre> | Adds a pseudowire member to xconnect.           |

## On the Ethernet PE

### SUMMARY STEPS

1. enable
2. **configure terminal**
3. **l2vpn xconnect context foo**
4. **interworking ethernet**
5. **member interface-id**
6. **member ip-address vc-id encapsulation mpls**

### DETAILED STEPS

|               | Command or Action                                                                                             | Purpose                                                                                                                                                                                                                                                                                                                                                |
|---------------|---------------------------------------------------------------------------------------------------------------|--------------------------------------------------------------------------------------------------------------------------------------------------------------------------------------------------------------------------------------------------------------------------------------------------------------------------------------------------------|
| <b>Step 1</b> | enable                                                                                                        | Changes the privilege level for the corresponding CLI session.                                                                                                                                                                                                                                                                                         |
| <b>Step 2</b> | <b>configure terminal</b><br><b>Example:</b><br><pre>Router# configure terminal</pre>                         | Enters global configuration mode.                                                                                                                                                                                                                                                                                                                      |
| <b>Step 3</b> | <b>l2vpn xconnect context foo</b><br><b>Example:</b><br><pre>Router(config)# l2vpn xconnect context foo</pre> | Creates an empty cross-connect, and enters xconnect submode.                                                                                                                                                                                                                                                                                           |
| <b>Step 4</b> | <b>interworking ethernet</b><br><b>Example:</b><br><pre>Router(config)# interworking ethernet</pre>           | Enables the L2VPN Interworking feature, and causes Ethernet frames to be extracted from the attachment circuit and sent over the pseudowire. Ethernet end-to-end transmission is assumed. Attachment circuit frames that do not contain Ethernet frames are dropped. In the case of VLAN, the VLAN tag is removed, which leaves a pure Ethernet frame. |

|               | Command or Action                                                                                                                                   | Purpose                                         |
|---------------|-----------------------------------------------------------------------------------------------------------------------------------------------------|-------------------------------------------------|
| <b>Step 5</b> | <b>member</b> interface-id<br><b>Example:</b><br><pre>Router(config)# member GigabitEthernet0/0/0.3</pre>                                           | Adds an interface as an AC segment of xconnect. |
| <b>Step 6</b> | <b>member</b> ip-address vc-id <b>encapsulation mpls</b><br><b>Example:</b><br><pre>Router(config)# member 16.16.16.16 100 encapsulation mpls</pre> | Adds a pseudowire member to xconnect.           |

## Routed Mode

Perform the following steps to configure the HDLC-Ethernet Interworking in the routed mode via interface-based configuration:

### On HDLC-PE

#### SUMMARY STEPS

1. enable
2. **configure terminal**
3. pseudowire-class pw-class-name
4. encapsulation mpls
5. interworking ip
6. interface serial slot | subslot | port
7. **no ip address**
8. xconnect peer-ip-address vc-id pseudowire-class pw-class-name

#### DETAILED STEPS

|               | Command or Action                                                                                            | Purpose                                                                                          |
|---------------|--------------------------------------------------------------------------------------------------------------|--------------------------------------------------------------------------------------------------|
| <b>Step 1</b> | enable                                                                                                       | Changes the privilege level for the corresponding CLI session.                                   |
| <b>Step 2</b> | <b>configure terminal</b><br><b>Example:</b><br><pre>Router# configure terminal</pre>                        | Enters global configuration mode.                                                                |
| <b>Step 3</b> | pseudowire-class pw-class-name<br><b>Example:</b><br><pre>Router(config)# pseudowire-class pw-ip-ether</pre> | Specifies the name of a Layer 2 pseudowire class and enters pseudowire class configuration mode. |

|               | Command or Action                                                                                                                                        | Purpose                                                                                                                                                                                                         |
|---------------|----------------------------------------------------------------------------------------------------------------------------------------------------------|-----------------------------------------------------------------------------------------------------------------------------------------------------------------------------------------------------------------|
| <b>Step 4</b> | encapsulation mpls<br><b>Example:</b><br><br>Router(config-pw)# encapsulation mpls                                                                       | Uses MPLS as the tunneling method to encapsulate data in the pseudowire.                                                                                                                                        |
| <b>Step 5</b> | interworking ip<br><b>Example:</b><br><br>Router(config-pw)# interworking ip                                                                             | Enables the L2VPN Interworking feature, and causes IP packets to be extracted from the attachment circuit and sent over the pseudowire. Attachment circuit frames that do not contain IPv4 packets are dropped. |
| <b>Step 6</b> | interface serial slot   subslot   port<br><b>Example:</b><br><br>Router(config)# <b>interface Serial0/1/0:0</b>                                          | Specifies the serial interface, and enters interface configuration mode.                                                                                                                                        |
| <b>Step 7</b> | no ip address<br><b>Example:</b><br><br>Router(config-if)# <b>no ip address</b>                                                                          | Removes all the IP addresses of the interface.                                                                                                                                                                  |
| <b>Step 8</b> | xconnect peer-ip-address vc-id pseudowire-class pw-class-name<br><b>Example:</b><br><br>Router(config-if)# xconnect 17.17.17.17 100 pw-class pw-ip-ether | Binds an attachment circuit to a pseudowire to configure an AToM static pseudowire, specifies MPLS as the tunneling method, and enters xconnect configuration mode.                                             |

## On Ethernet PE

### SUMMARY STEPS

1. enable
2. **configure terminal**
3. pseudowire-class pw-class-name
4. encapsulation mpls
5. interworking ip
6. interface GigabitEthernet slot | subslot | port
7. **encapsulation dot1Q** vlan-id
8. xconnect peer-ip-address vc-id pseudowire-class pw-class-name

### DETAILED STEPS

|               | Command or Action | Purpose                                                        |
|---------------|-------------------|----------------------------------------------------------------|
| <b>Step 1</b> | enable            | Changes the privilege level for the corresponding CLI session. |



|               | Command or Action                                                                                                                                                      | Purpose                                                                                                                                                                                                         |
|---------------|------------------------------------------------------------------------------------------------------------------------------------------------------------------------|-----------------------------------------------------------------------------------------------------------------------------------------------------------------------------------------------------------------|
| <b>Step 2</b> | <b>configure terminal</b><br><b>Example:</b><br><br>Router# configure terminal                                                                                         | Enters global configuration mode.                                                                                                                                                                               |
| <b>Step 3</b> | pseudowire-class pw-class-name<br><b>Example:</b><br><br>Router(config)# pseudowire-class pw-ip-ether                                                                  | Specifies the name of a Layer 2 pseudowire class and enters pseudowire class configuration mode.                                                                                                                |
| <b>Step 4</b> | encapsulation mpls<br><b>Example:</b><br><br>Router(config-pw)# encapsulation mpls                                                                                     | Uses MPLS as the tunneling method to encapsulate data in the pseudowire.                                                                                                                                        |
| <b>Step 5</b> | interworking ip<br><b>Example:</b><br><br>Router(config-pw)# interworking ip                                                                                           | Enables the L2VPN Interworking feature, and causes IP packets to be extracted from the attachment circuit and sent over the pseudowire. Attachment circuit frames that do not contain IPv4 packets are dropped. |
| <b>Step 6</b> | interface GigabitEthernet slot   subslot   port<br><b>Example:</b><br><br>Router(config)# <b>interface</b><br><b>GigabitEthernet0/0/0.3</b>                            | Specifies the Gigabit Ethernet interface, and enters interface configuration mode.                                                                                                                              |
| <b>Step 7</b> | encapsulation dot1Q vlan-id<br><b>Example:</b><br><br>Router(config-if)# <b>encapsulation dot1Q 3</b>                                                                  | Enables IEEE 802.1Q encapsulation of traffic on a specified subinterface in a VLAN.                                                                                                                             |
| <b>Step 8</b> | xconnect peer-ip-address vc-id pseudowire-class<br>pw-class-name<br><b>Example:</b><br><br>Router(config-if)# xconnect 16.16.16.16 100<br>pseudowire-class pw-ip-ether | Binds an attachment circuit to a pseudowire to configure an AToM static pseudowire, specifies MPLS as the tunneling method, and enters xconnect configuration mode.                                             |

### What to do next

Perform the following steps to configure the HDLC-Ethernet Interworking in the routed mode via protocol-based configuration:

## On HDLC-PE

### SUMMARY STEPS

1. enable
2. **configure terminal**
3. **l2vpn xconnect context foo**
4. **interworking ip**
5. **member interface-id**
6. **member ip-address encapsulation mpls**

### DETAILED STEPS

|               | Command or Action                                                                                                                  | Purpose                                                                                                                                                                                                         |
|---------------|------------------------------------------------------------------------------------------------------------------------------------|-----------------------------------------------------------------------------------------------------------------------------------------------------------------------------------------------------------------|
| <b>Step 1</b> | enable                                                                                                                             | Changes the privilege level for the corresponding CLI session.                                                                                                                                                  |
| <b>Step 2</b> | <b>configure terminal</b><br><b>Example:</b><br><br>Router# configure terminal                                                     | Enters global configuration mode.                                                                                                                                                                               |
| <b>Step 3</b> | <b>l2vpn xconnect context foo</b><br><b>Example:</b><br><br>Router(config)# l2vpn xconnect context foo                             | Creates an empty cross-connect, and enters xconnect submode.                                                                                                                                                    |
| <b>Step 4</b> | <b>interworking ip</b><br><b>Example:</b><br><br>Router(config)# interworking ip                                                   | Enables the L2VPN Interworking feature, and causes IP packets to be extracted from the attachment circuit and sent over the pseudowire. Attachment circuit frames that do not contain IPv4 packets are dropped. |
| <b>Step 5</b> | <b>member interface-id</b><br><b>Example:</b><br><br>Router(config)# member serial10/1/0:0                                         | Adds an interface as an AC segment of xconnect.                                                                                                                                                                 |
| <b>Step 6</b> | <b>member ip-address encapsulation mpls</b><br><b>Example:</b><br><br>Router(config)# member 17.17.17.17 100<br>encapsulation mpls | Adds a pseudowire member to xconnect.                                                                                                                                                                           |

## On Ethernet PE

### SUMMARY STEPS

1. enable

2. **configure terminal**
3. **l2vpn xconnect context foo**
4. **interworking ip**
5. **member interface-id**
6. **member ip-address vcid encapsulation mpls**

## DETAILED STEPS

|               | Command or Action                                                                                                                       | Purpose                                                                                                                                                                                                         |
|---------------|-----------------------------------------------------------------------------------------------------------------------------------------|-----------------------------------------------------------------------------------------------------------------------------------------------------------------------------------------------------------------|
| <b>Step 1</b> | enable                                                                                                                                  | Changes the privilege level for the corresponding CLI session.                                                                                                                                                  |
| <b>Step 2</b> | <b>configure terminal</b><br><b>Example:</b><br><br>Router# configure terminal                                                          | Enters global configuration mode.                                                                                                                                                                               |
| <b>Step 3</b> | <b>l2vpn xconnect context foo</b><br><b>Example:</b><br><br>Router(config)# l2vpn xconnect context foo                                  | Creates an empty cross-connect, and enters xconnect submode.                                                                                                                                                    |
| <b>Step 4</b> | <b>interworking ip</b><br><b>Example:</b><br><br>Router(config)# interworking ip                                                        | Enables the L2VPN Interworking feature, and causes IP packets to be extracted from the attachment circuit and sent over the pseudowire. Attachment circuit frames that do not contain IPv4 packets are dropped. |
| <b>Step 5</b> | <b>member interface-id</b><br><b>Example:</b><br><br>Router(config)# member GigabitEthernet0/0/0.3                                      | Adds an interface as an AC segment of xconnect.                                                                                                                                                                 |
| <b>Step 6</b> | <b>member ip-address vcid encapsulation mpls</b><br><b>Example:</b><br><br>Router(config)# member 16.16.16.16 100<br>encapsulation mpls | Adds a pseudowire member to xconnect.                                                                                                                                                                           |

## Example: HDLC-Ethernet Interworking Configuration

The following examples show how to configure the HDLC-Ethernet Interworking feature, and verify the configuration using **show** commands for legacy and new protocol-based outputs on the Cisco ASR 1000 Series Aggregation Services Routers:

### Example: Different Forms of Protocol-Based CLI Configuration

The following example shows how to configure the HDLC-Ethernet interworking on the Controller slot on Ethernet CE:

```

controller E1 2/0
channel-group 0 timeslots 1
no shutdown
interface Serial2/0:0
no shutdown

```

The following example shows how to configure the HDLC-Ethernet interworking on the Controller slot on Ethernet PE:

```

controller E1 0/1/0
channel-group 0 timeslots 1
no shutdown
interface Serial0/1/0:0
no shutdown

```

The following example shows how to configure the HDLC-Ethernet interworking using legacy CLI.

The following example shows how to configure on HDLC-CE and HDLC-PE in Bridged (Ethernet) mode using legacy CLI:

On HDLC-CE

```

configure terminal
bridge irb
bridge 1 protocol ieee
bridge 1 route ip
!
int BVI1
ip address 192.168.1.1 255.255.255.0
no shut
!
interface Serial2/0:0
description Connect to PE1
encapsulation hdlc
bridge-group 1
no shut
end

```

HDLC-PE:

```

configure terminal
pseudowire-class pw-iv-eth
 encapsulation mpls
 interworking Ethernet
!
interface Serial0/1/0:0
 description Connect to CE1
 encapsulation hdlc
 no ip address
 xconnect 192.0.2.3 100 pw-class pw-iv-eth
 no shut
end

```

The following example shows how to configure Ethernet on Ethernet-CE and Ethernet-PE in Bridged (Ethernet) mode using legacy CLI:

On Ethernet-CE

```

configure terminal
interface GigabitEthernet0/1
description Connect to PE2

```

```

ip address 192.168.1.2 255.255.255.0
ip irdp
ip irdp maxadvertinterval 4
no shut
end

```

#### On Ethernet-PE

```

configure terminal
pseudowire-class pw-iw-eth
 encapsulation mpls
 interworking Ethernet
!
interface GigabitEthernet1/0/0
 description Connect to CE2
 no ip address
xconnect 192.0.2.1 100 pw-class pw-iw-eth
 no shut
end

```

The following example shows how to configure VLAN at Ethernet-CE and Ethernet-PE in Bridged (Ethernet) mode using legacy CLI:

#### On Ethernet-CE:

```

configure terminal
interface GigabitEthernet0/1
no ip address
no shut
!
interface GigabitEthernet0/1.10
description Connect to PE2
encapsulation dot1q 10
ip address 192.168.1.2 255.255.255.0
ip irdp
ip irdp maxadvertinterval 4
no shut
end

```

#### On Ethernet-PE:

```

configure terminal
pseudowire-class pw-iw-eth
 encapsulation mpls
 interworking Ethernet
!
interface GigabitEthernet1/0/0
no ip address
no shut
!
interface GigabitEthernet1/0/0.10
 description Connect to CE2
 encapsulation dot1Q 10
 no ip address
xconnect 192.0.2.1 100 pw-class pw-iw-eth
 no shut
end

```

The following example shows how to configure QinQ at Ethernet-CE and Ethernet-PE in Bridged (Ethernet) mode using legacy CLI:

#### On Ethernet-CE:

**Example: Different Forms of Protocol-Based CLI Configuration**

```

configure terminal
interface GigabitEthernet0/1
no ip address
no shut
!
interface GigabitEthernet0/1.10
description Connect to PE2
encapsulation dot1q 10 second-dot1q 20
ip address 192.168.1.2 255.255.255.0
ip irdp
ip irdp maxadvertinterval 4
no shut
end

```

**On Ethernet-PE:**

```

configure terminal
pseudowire-class pw-iw-eth
encapsulation mpls
interworking Ethernet
!
interface GigabitEthernet1/0/0
no ip address
no shut
!
interface GigabitEthernet1/0/0.10
description Connect to CE2
encapsulation dot1Q 10 second-dot1q 20
no ip address
xconnect 192.0.2.1 100 pw-class pw-iw-eth
no shut
end

```

The following example shows how to configure HDLC-Ethernet interworking using Protocol-Based CLI:

The following example shows how to configure HDLC on HDLC-CE and HDLC-PE in Bridged (Ethernet) mode using protocol-based CLI:

**On HDLC-CE:**

```

configure terminal
bridge irb
bridge 1 protocol ieee
bridge 1 route ip
!
int BVI1
ip address 192.168.1.1 255.255.255.0
no shut
!
interface Serial2/0:0
description Connect to PE1
encapsulation hdlc
bridge-group 1
no shut
end

```

**On HDLC-PE:**

```

configure terminal
interface Serial0/1/0:0
description Connect to CE1
encapsulation hdlc

```

```

no ip address
no shut
!
Interface pseudowire101
encapsulation mpls
neighbor 192.0.2.3 100
signaling protocol ldp
no shut
l2vpn xconnect context foohdlc
interworking ethernet
member Serial0/1/0:0
member pseudowire101
no shut
end

```

The following example shows how to configure Ethernet on Ethernet-CE and Ethernet-PE - Bridged (Ethernet) mode using protocol-based CLI:

On Ethernet-CE:

```

configure terminal
interface GigabitEthernet0/1
description Connect to PE2
ip address 192.168.1.2 255.255.255.0
ip irdp
ip irdp maxadvertinterval 4
no shut
end

```

On Ethernet-PE:

```

configure terminal
interface GigabitEthernet1/0/0
description Connect to CE2
no ip address
no shut
!
Interface pseudowire101
encapsulation mpls
neighbor 192.0.2.1 100
signaling protocol ldp
no shut
!
l2vpn xconnect context fooeth
interworking ethernet
member GigabitEthernet1/0/0
member pseudowire101
no shut
end

```

The following example shows how to configure VLAN on Ether-CE and Ethernet-PE in Bridged (Ethernet) mode using protocol-based CLI:

On Ethernet-CE:

```

configure terminal
!
interface GigabitEthernet0/1
no ip address
no shut
!
interface GigabitEthernet0/1.10
encapsulation dot1q 10

```

```

description Connect to PE2
ip address 192.168.1.2 255.255.255.0
ip irdp
ip irdp maxadvertinterval 4
no shut
end

```

#### On Ethernet-PE:

```

configure terminal
!
interface GigabitEthernet1/0/0
no ip address
no shut
!
interface GigabitEthernet1/0/0.10
description Connect to CE2
encapsulation dot1q 10
no ip address
no shut
!
Interface pseudowire101
encapsulation mpls
neighbor 192.0.2.1 100
signaling protocol ldp
no shut
!
l2vpn xconnect context foovlan
interworking ethernet
member GigabitEthernet1/0/0.10
member pseudowire101
no shut
end

```

The following example shows how to configure QinQ on Ethernet-CE and Ethernet-PE in Bridged (Ethernet) mode using protocol-based CLI:

#### Ethernet-CE:

```

configure terminal
!
interface GigabitEthernet0/1
no ip address
no shut
!
interface GigabitEthernet0/1.10
description Connect to PE2
encapsulation dot1q 10 second-dot1q 20
ip address 192.168.1.2 255.255.255.0
ip irdp
ip irdp maxadvertinterval 4
no shut
end

```

#### Ethernet-PE:

```

configure terminal
!
interface GigabitEthernet1/0/0
no ip address
no shut
!
interface GigabitEthernet1/0/0.10

```



```

description Connect to CE2
encapsulation dot1q 10 second-dot1q 20
no ip address
no shut
!
Interface pseudowire101
encapsulation mpls
neighbor 192.0.2.1 100
signaling protocol ldp
no shut
!
l2vpn xconnect context fooqing
interworking ethernet
member GigabitEthernet1/0/0.10
member pseudowire101
no shut
end

```

## Example: Verifying the Configuration for HDLC-Ethernet Interworking

Use the following **show** commands to verify the configuration for HDLC-Ethernet interworking:

Port mode

The following example shows how to verify the HDLC configuration on PE:

```

Router# show mpls l2transport vc

Local intf Local circuit Dest address VC ID Status

Se0/1/0:0 HDLC 104.0.0.1 101 UP

```

```

Router# show mpls l2transport vc detail
Local interface: Se0/1/0:0 up, line protocol up, HDLC up
 Interworking type is Ethernet
 Destination address: 104.0.0.1, VC ID: 101, VC status: up
 Output interface: Fa0/0/1, imposed label stack {20 22}
 Preferred path: not configured
 Default path: active
 Next hop: 10.1.1.2
 Create time: 00:00:19, last status change time: 00:00:15
 Last label FSM state change time: 00:00:15
 Signaling protocol: LDP, peer 104.0.0.1:0 up
 Targeted Hello: 102.0.0.1(LDP Id) -> 104.0.0.1, LDP is UP
 Graceful restart: configured and enabled
 Non stop routing: not configured and not enabled
 Status TLV support (local/remote) : enabled/supported
 LDP route watch : enabled
 Label/status state machine : established, LruRru
 Last local dataplane status rcvd: No fault
 Last BFD dataplane status rcvd: Not sent
 Last BFD peer monitor status rcvd: No fault
 Last local AC circuit status rcvd: No fault
 Last local AC circuit status sent: No fault
 Last local PW i/f circ status rcvd: No fault
 Last local LDP TLV status sent: No fault
 Last remote LDP TLV status rcvd: No fault
 Last remote LDP ADJ status rcvd: No fault
 MPLS VC labels: local 33, remote 22
 Group ID: local 0, remote 0
 MTU: local 1500, remote 1500
 Remote interface description: Connect to CE2
 Sequencing: receive disabled, send disabled
 Control Word: On
 SSO Descriptor: 104.0.0.1/101, local label: 33

```

## Example: Verifying the Configuration for HDLC-Ethernet Interworking

```

Dataplane:
 SSM segment/switch IDs: 4274/4273 (used), PWID: 26
VC statistics:
 transit packet totals: receive 3, send 6
 transit byte totals: receive 162, send 366
 transit packet drops: receive 0, seq error 0, send 0
Router# show l2vpn atom vc

```

| Interface | Peer ID   | VC ID | Service |        | Status |
|-----------|-----------|-------|---------|--------|--------|
|           |           |       | Type    | Name   |        |
| pw101     | 104.0.0.1 | 101   | p2p     | foo101 | UP     |

```

Router# show l2vpn atom vc detail
pseudowire101 is up, VC status is up PW type: Ethernet
 Create time: 00:00:18, last status change time: 00:00:14
 Last label FSM state change time: 00:00:14
 Destination address: 104.0.0.1 VC ID: 101
 Output interface: Fa0/0/1, imposed label stack {16 17}
 Preferred path: not configured
 Default path: active
 Next hop: 10.1.1.2
Member of xconnect service foo101
 Associated member Se0/1/0:0 is up, status is up
 Interworking type is Ethernet
 Service id: 0xde000002
Signaling protocol: LDP, peer 104.0.0.1:0 up
 Targeted Hello: 102.0.0.1(LDP Id) -> 104.0.0.1, LDP is UP
 Graceful restart: configured and enabled
 Non stop routing: not configured and not enabled
 PWid FEC (128), VC ID: 101
 Status TLV support (local/remote) : enabled/supported
 LDP route watch : enabled
 Label/status state machine : established, LruRru
 Local dataplane status received : No fault
 BFD dataplane status received : Not sent
 BFD peer monitor status received : No fault
 Status received from access circuit : No fault
 Status sent to access circuit : No fault
 Status received from pseudowire i/f : No fault
 Status sent to network peer : No fault
 Status received from network peer : No fault
 Adjacency status of remote peer : No fault
Sequencing: receive disabled, send disabled
Bindings
 Parameter Local Remote

 Label 18 17
 Group ID 0 0
 Interface Connect to CE1 Connect to CE2
 MTU 1500 1500
 Control word on (configured: autosense) on
 PW type Ethernet Ethernet
 VCCV CV type 0x02 0x02
 LSPV [2] LSPV [2]
 VCCV CC type 0x07 0x07
 CW [1], RA [2], TTL [3] CW [1], RA [2], TTL [3]
 Status TLV enabled supported
SSO Descriptor: 104.0.0.1/101, local label: 18
Dataplane:
 SSM segment/switch IDs: 4106/4105 (used), PWID: 2
Rx Counters
 3 input transit packets, 162 bytes
 0 drops, 0 seq err
Tx Counters

```

5 output transit packets, 305 bytes  
0 drops

The following example shows how to verify the Ethernet configuration on PE:

```
Router# show mpls l2transport vc
Local intf Local circuit Dest address VC ID Status

Gi1/0/0 Ethernet 102.0.0.1 101 UP
```

```
Router# show mpls l2transport vc detail
Local interface: Gi1/0/0 up, line protocol up, Ethernet up
Destination address: 102.0.0.1, VC ID: 101, VC status: up
Output interface: Fa0/0/1, imposed label stack {19 33}
Preferred path: not configured
Default path: active
Next hop: 11.1.1.1
Create time: 00:00:22, last status change time: 00:00:19
Last label FSM state change time: 00:00:19
Signaling protocol: LDP, peer 102.0.0.1:0 up
Targeted Hello: 104.0.0.1(LDP Id) -> 102.0.0.1, LDP is UP
Graceful restart: configured and enabled
Non stop routing: not configured and not enabled
Status TLV support (local/remote) : enabled/supported
LDP route watch : enabled
Label/status state machine : established, LruRru
Last local dataplane status rcvd: No fault
Last BFD dataplane status rcvd: Not sent
Last BFD peer monitor status rcvd: No fault
Last local AC circuit status rcvd: No fault
Last local AC circuit status sent: No fault
Last local PW i/f circ status rcvd: No fault
Last local LDP TLV status sent: No fault
Last remote LDP TLV status rcvd: No fault
Last remote LDP ADJ status rcvd: No fault
MPLS VC labels: local 22, remote 33
Group ID: local 0, remote 0
MTU: local 1500, remote 1500
Remote interface description: Connect to CE1
Sequencing: receive disabled, send disabled
Control Word: On
SSO Descriptor: 102.0.0.1/101, local label: 22
Dataplane:
SSM segment/switch IDs: 4574/4573 (used), PWID: 80
VC statistics:
transit packet totals: receive 9, send 5
transit byte totals: receive 315, send 380
transit packet drops: receive 0, seq error 0, send 0
```

```
Router# show l2vpn atom vc
Interface Peer ID VC ID Service Type Name Status

pw101 102.0.0.1 101 p2p foo101 UP
```

```
Router# show l2vpn atom vc detail
pseudowire101 is up, VC status is up PW type: Ethernet
Create time: 00:00:23, last status change time: 00:00:20
Last label FSM state change time: 00:00:20
Destination address: 102.0.0.1 VC ID: 101
Output interface: Fa0/0/1, imposed label stack {18 18}
Preferred path: not configured
Default path: active
Next hop: 11.1.1.1
Member of xconnect service foo101
Associated member Gi1/0/0 is up, status is up
Interworking type is Like2Like
```

## Example: Verifying the Configuration for HDLC-Ethernet Interworking

```

Service id: 0xb5000004
Signaling protocol: LDP, peer 102.0.0.1:0 up
Targeted Hello: 104.0.0.1(LDP Id) -> 102.0.0.1, LDP is UP
Graceful restart: configured and enabled
Non stop routing: not configured and not enabled
Pwid FEC (128), VC ID: 101
Status TLV support (local/remote) : enabled/supported
 LDP route watch : enabled
 Label/status state machine : established, LruRru
 Local dataplane status received : No fault
 BFD dataplane status received : Not sent
 BFD peer monitor status received : No fault
 Status received from access circuit : No fault
 Status sent to access circuit : No fault
 Status received from pseudowire i/f : No fault
 Status sent to network peer : No fault
 Status received from network peer : No fault
 Adjacency status of remote peer : No fault
Sequencing: receive disabled, send disabled
Bindings
 Parameter Local Remote

Label 17 18
Group ID 0 0
Interface Connect to CE2 Connect to CE1
MTU 1500 1500
Control word on (configured: autosense) on
PW type Ethernet Ethernet
VCCV CV type 0x02
 LSPV [2] LSPV [2]
VCCV CC type 0x07
 CW [1], RA [2], TTL [3] CW [1], RA [2], TTL [3]
Status TLV enabled supported
SSO Descriptor: 102.0.0.1/101, local label: 17
Dataplane:
 SSM segment/switch IDs: 4126/4125 (used), PWID: 4
Rx Counters
 5 input transit packets, 175 bytes
 0 drops, 0 seq err
Tx Counters
 3 output transit packets, 228 bytes
 0 drops

```

## VLAN (dot1q) mode

The following example shows how to verify the HDLC configuration on PE:

```

Router# show mpls l2transport vc
Local intf Local circuit Dest address VC ID Status

Se0/1/0:0 HDLC 104.0.0.1 138 UP
Router# show mpls l2transport vc detail
Local interface: Se0/1/0:0 up, line protocol up, HDLC up
Interworking type is Ethernet
Destination address: 104.0.0.1, VC ID: 138, VC status: up
Output interface: Fa0/0/1, imposed label stack {20 53}
Preferred path: not configured
Default path: active
Next hop: 10.1.1.2
Create time: 00:00:19, last status change time: 00:00:15
Last label FSM state change time: 00:00:15
Signaling protocol: LDP, peer 104.0.0.1:0 up
Targeted Hello: 102.0.0.1(LDP Id) -> 104.0.0.1, LDP is UP
Graceful restart: configured and enabled

```

```

Non stop routing: not configured and not enabled
Status TLV support (local/remote) : enabled/supported
 LDP route watch : enabled
 Label/status state machine : established, LruRru
 Last local dataplane status rcvd: No fault
 Last BFD dataplane status rcvd: Not sent
 Last BFD peer monitor status rcvd: No fault
 Last local AC circuit status rcvd: No fault
 Last local AC circuit status sent: No fault
 Last local PW i/f circ status rcvd: No fault
 Last local LDP TLV status sent: No fault
 Last remote LDP TLV status rcvd: No fault
 Last remote LDP ADJ status rcvd: No fault
MPLS VC labels: local 35, remote 53
Group ID: local 0, remote 0
MTU: local 1500, remote 1500
Remote interface description: Connect to CE2
Sequencing: receive disabled, send disabled
Control Word: On
SSO Descriptor: 104.0.0.1/138, local label: 35
Dataplane:
 SSM segment/switch IDs: 4486/4485 (used), PWID: 65
VC statistics:
 transit packet totals: receive 4, send 3
 transit byte totals: receive 1036, send 183
 transit packet drops: receive 0, seq error 0, send 0

```

Router# **show l2vpn atom vc**

| Interface | Peer ID   | VC ID | Service |        | Status |
|-----------|-----------|-------|---------|--------|--------|
|           |           |       | Type    | Name   |        |
| pwl38     | 104.0.0.1 | 138   | p2p     | fool38 | UP     |

Router# **show l2vpn atom vc detail**

```

pseudowire138 is up, VC status is up PW type: Ethernet
Create time: 00:00:18, last status change time: 00:00:14
Last label FSM state change time: 00:00:14
Destination address: 104.0.0.1 VC ID: 138
Output interface: Fa0/0/1, imposed label stack {16 30}
Preferred path: not configured
Default path: active
Next hop: 10.1.1.2
Member of xconnect service fool38
Associated member Se0/1/0:0 is up, status is up
Interworking type is Ethernet
Service id: 0x4000027
Signaling protocol: LDP, peer 104.0.0.1:0 up
Targeted Hello: 102.0.0.1(LDP Id) -> 104.0.0.1, LDP is UP
Graceful restart: configured and enabled
Non stop routing: not configured and not enabled
PWid FEC (128), VC ID: 138
Status TLV support (local/remote) : enabled/supported
 LDP route watch : enabled
 Label/status state machine : established, LruRru
 Local dataplane status received : No fault
 BFD dataplane status received : Not sent
 BFD peer monitor status received : No fault
 Status received from access circuit : No fault
 Status sent to access circuit : No fault
 Status received from pseudowire i/f : No fault
 Status sent to network peer : No fault
 Status received from network peer : No fault
 Adjacency status of remote peer : No fault
Sequencing: receive disabled, send disabled
Bindings
 Parameter Local Remote

```

## Example: Verifying the Configuration for HDLC-Ethernet Interworking

```

Label 20 30
Group ID 0 0
Interface Connect to CE1 Connect to CE2
MTU 1500 1500
Control word on (configured: autosense) on
PW type Ethernet Ethernet
VCCV CV type 0x02 0x02
 LSPV [2] LSPV [2]
VCCV CC type 0x07 0x07
 CW [1], RA [2], TTL [3] CW [1], RA [2], TTL [3]
Status TLV enabled supported
SSO Descriptor: 104.0.0.1/138, local label: 20
Dataplane:
 SSM segment/switch IDs: 4313/4312 (used), PWID: 41
Rx Counters
 2 input transit packets, 108 bytes
 0 drops, 0 seq err
Tx Counters
 3 output transit packets, 183 bytes
 0 drops

```

The following example shows how to verify the VLAN configuration on PE:

```

Router# show mpls l2transport vc

Local intf Local circuit Dest address VC ID Status

Gi1/0/0.10 Eth VLAN 10 102.0.0.1 138 UP
Router# show mpls l2transport vc detail
Local interface: Gi1/0/0.10 up, line protocol up, Eth VLAN 10 up
Interworking type is Ethernet
Destination address: 102.0.0.1, VC ID: 138, VC status: up
Output interface: Fa0/0/1, imposed label stack {19 35}
Preferred path: not configured
Default path: active
Next hop: 11.1.1.1
Create time: 00:00:22, last status change time: 00:00:20
Last label FSM state change time: 00:00:20
Signaling protocol: LDP, peer 102.0.0.1:0 up
Targeted Hello: 104.0.0.1(LDP Id) -> 102.0.0.1, LDP is UP
Graceful restart: configured and enabled
Non stop routing: not configured and not enabled
Status TLV support (local/remote) : enabled/supported
LDP route watch : enabled
Label/status state machine : established, LruRru
Last local dataplane status rcvd: No fault
Last BFD dataplane status rcvd: Not sent
Last BFD peer monitor status rcvd: No fault
Last local AC circuit status rcvd: No fault
Last local AC circuit status sent: No fault
Last local PW i/f circ status rcvd: No fault
Last local LDP TLV status sent: No fault
Last remote LDP TLV status rcvd: No fault
Last remote LDP ADJ status rcvd: No fault
MPLS VC labels: local 53, remote 35
Group ID: local 0, remote 0
MTU: local 1500, remote 1500
Remote interface description: Connect to CE1
Sequencing: receive disabled, send disabled
Control Word: On
SSO Descriptor: 102.0.0.1/138, local label: 53
Dataplane:
 SSM segment/switch IDs: 4784/4783 (used), PWID: 117
VC statistics:

```

```

transit packet totals: receive 6, send 6
transit byte totals: receive 234, send 1276
transit packet drops: receive 0, seq error 0, send 0
Router# show l2vpn atom vc

```

| Interface | Peer ID   | VC ID | Service Type | Service Name | Status |
|-----------|-----------|-------|--------------|--------------|--------|
| pwl38     | 102.0.0.1 | 138   | p2p          | fool38       | UP     |

```

Router# show l2vpn atom vc detail
pseudowire138 is up, VC status is up PW type: Ethernet
 Create time: 00:00:23, last status change time: 00:00:20
 Last label FSM state change time: 00:00:20
 Destination address: 102.0.0.1 VC ID: 138
 Output interface: Fa0/0/1, imposed label stack {18 20}
 Preferred path: not configured
 Default path: active
 Next hop: 11.1.1.1
Member of xconnect service fool38
 Associated member Gil/0/0.10 is up, status is up
 Interworking type is Ethernet
 Service id: 0x7b000029
Signaling protocol: LDP, peer 102.0.0.1:0 up
 Targeted Hello: 104.0.0.1(LDP Id) -> 102.0.0.1, LDP is UP
 Graceful restart: configured and enabled
 Non stop routing: not configured and not enabled
 PWid FEC (128), VC ID: 138
 Status TLV support (local/remote) : enabled/supported
 LDP route watch : enabled
 Label/status state machine : established, LruRru
 Local dataplane status received : No fault
 BFD dataplane status received : Not sent
 BFD peer monitor status received : No fault
 Status received from access circuit : No fault
 Status sent to access circuit : No fault
 Status received from pseudowire i/f : No fault
 Status sent to network peer : No fault
 Status received from network peer : No fault
 Adjacency status of remote peer : No fault
Sequencing: receive disabled, send disabled
Bindings
 Parameter Local Remote

 Label 30 20
 Group ID 0 0
 Interface Connect to CE2 Connect to CE1
 MTU 1500 1500
 Control word on (configured: autosense) on
 PW type Ethernet Ethernet
 VCCV CV type 0x02 0x02
 LSPV [2] LSPV [2]
 VCCV CC type 0x07 0x07
 CW [1], RA [2], TTL [3] CW [1], RA [2], TTL [3]
 Status TLV enabled supported
SSO Descriptor: 102.0.0.1/138, local label: 30
Dataplane:
 SSM segment/switch IDs: 4333/4332 (used), PWID: 41
Rx Counters
 8 input transit packets, 312 bytes
 0 drops, 0 seq err
Tx Counters
 5 output transit packets, 380 bytes
 0 drops

```

QinQ mode

The following example shows how to verify HDLC configuration on PE:

```

Router# show mpls l2transport vc

Local intf Local circuit Dest address VC ID Status

Se0/1/0:0 HDLC 104.0.0.1 145 UP
Router# show mpls l2transport vc detail
Local interface: Se0/1/0:0 up, line protocol up, HDLC up
 Interworking type is Ethernet
 Destination address: 104.0.0.1, VC ID: 145, VC status: up
 Output interface: Fa0/0/1, imposed label stack {20 25}
 Preferred path: not configured
 Default path: active
 Next hop: 10.1.1.2
Create time: 00:00:20, last status change time: 00:00:15
 Last label FSM state change time: 00:00:15
Signaling protocol: LDP, peer 104.0.0.1:0 up
 Targeted Hello: 102.0.0.1(LDP Id) -> 104.0.0.1, LDP is UP
 Graceful restart: configured and enabled
 Non stop routing: not configured and not enabled
 Status TLV support (local/remote) : enabled/supported
 LDP route watch : enabled
 Label/status state machine : established, LruRru
 Last local dataplane status rcvd: No fault
 Last BFD dataplane status rcvd: Not sent
 Last BFD peer monitor status rcvd: No fault
 Last local AC circuit status rcvd: No fault
 Last local AC circuit status sent: No fault
 Last local PW i/f circ status rcvd: No fault
 Last local LDP TLV status sent: No fault
 Last remote LDP TLV status rcvd: No fault
 Last remote LDP ADJ status rcvd: No fault
MPLS VC labels: local 27, remote 25
Group ID: local 0, remote 0
MTU: local 1500, remote 1500
Remote interface description: Connect to CE2
Sequencing: receive disabled, send disabled
Control Word: On
SSO Descriptor: 104.0.0.1/145, local label: 27
Dataplane:
 SSM segment/switch IDs: 4521/4520 (used), PWID: 72
VC statistics:
 transit packet totals: receive 4, send 7
 transit byte totals: receive 216, send 427
 transit packet drops: receive 0, seq error 0, send 0
Router# show mpls l2vpn atom vc

Interface Peer ID VC ID Service Status

pw145 104.0.0.1 145 p2p foo145 UP
Router# show mpls l2vpn atom vc detail
pseudowire145 is up, VC status is up PW type: Ethernet
 Create time: 00:00:18, last status change time: 00:00:13
 Last label FSM state change time: 00:00:13
 Destination address: 104.0.0.1 VC ID: 145
 Output interface: Fa0/0/1, imposed label stack {16 33}
 Preferred path: not configured
 Default path: active
 Next hop: 10.1.1.2
Member of xconnect service foo145
 Associated member Se0/1/0:0 is up, status is up
 Interworking type is Ethernet

```



```

Service id: 0x2e
Signaling protocol: LDP, peer 104.0.0.1:0 up
Targeted Hello: 102.0.0.1(LDP Id) -> 104.0.0.1, LDP is UP
Graceful restart: configured and enabled
Non stop routing: not configured and not enabled
PWid FEC (128), VC ID: 145
Status TLV support (local/remote) : enabled/supported
 LDP route watch : enabled
 Label/status state machine : established, LruRru
 Local dataplane status received : No fault
 BFD dataplane status received : Not sent
 BFD peer monitor status received : No fault
 Status received from access circuit : No fault
 Status sent to access circuit : No fault
 Status received from pseudowire i/f : No fault
 Status sent to network peer : No fault
 Status received from network peer : No fault
 Adjacency status of remote peer : No fault
Sequencing: receive disabled, send disabled
Bindings
Parameter Local Remote

Label 33 33
Group ID 0 0
Interface Connect to CE1 Connect to CE2
MTU 1500 1500
Control word on (configured: autosense) on
PW type Ethernet Ethernet
VCCV CV type 0x02 0x02
 LSPV [2] LSPV [2]
VCCV CC type 0x07 0x07
 CW [1], RA [2], TTL [3] CW [1], RA [2], TTL [3]
Status TLV enabled supported
SSO Descriptor: 104.0.0.1/145, local label: 33
Dataplane:
 SSM segment/switch IDs: 4345/4344 (used), PWID: 48
Rx Counters
 2 input transit packets, 108 bytes
 0 drops, 0 seq err
Tx Counters
 3 output transit packets, 183 bytes
 0 drops

```

The following example shows how to verify the Qinq configuration on PE:

```

Router# show mpls l2transport vc
Local intf Local circuit Dest address VC ID Status

Gi1/0/0.10 Eth VLAN 10/20 102.0.0.1 145 UP
Router# show mpls l2transport vc detail
Local interface: Gi1/0/0.10 up, line protocol up, Eth VLAN 10/20 up
Interworking type is Ethernet
Destination address: 102.0.0.1, VC ID: 145, VC status: up
Output interface: Fa0/0/1, imposed label stack {19 27}
Preferred path: not configured
Default path: active
Next hop: 11.1.1.1
Create time: 00:00:23, last status change time: 00:00:21
Last label FSM state change time: 00:00:21
Signaling protocol: LDP, peer 102.0.0.1:0 up
Targeted Hello: 104.0.0.1(LDP Id) -> 102.0.0.1, LDP is UP
Graceful restart: configured and enabled
Non stop routing: not configured and not enabled
Status TLV support (local/remote) : enabled/supported

```

## Example: Verifying the Configuration for HDLC-Ethernet Interworking

```

LDP route watch : enabled
Label/status state machine : established, LruRru
Last local dataplane status rcvd: No fault
Last BFD dataplane status rcvd: Not sent
Last BFD peer monitor status rcvd: No fault
Last local AC circuit status rcvd: No fault
Last local AC circuit status sent: No fault
Last local PW i/f circ status rcvd: No fault
Last local LDP TLV status sent: No fault
Last remote LDP TLV status rcvd: No fault
Last remote LDP ADJ status rcvd: No fault
MPLS VC labels: local 25, remote 27
Group ID: local 0, remote 0
MTU: local 1500, remote 1500
Remote interface description: Connect to CE1
Sequencing: receive disabled, send disabled
Control Word: On
SSO Descriptor: 102.0.0.1/145, local label: 25
Dataplane:
 SSM segment/switch IDs: 4815/4814 (used), PWID: 124
VC statistics:
 transit packet totals: receive 10, send 6
 transit byte totals: receive 430, send 456
 transit packet drops: receive 0, seq error 0, send 0
Router# show l2vpn atom vc

```

| Interface | Peer ID   | VC ID | Service Type | Service Name | Status |
|-----------|-----------|-------|--------------|--------------|--------|
| pw145     | 102.0.0.1 | 145   | p2p          | fool45       | UP     |

```

Router# show l2vpn atom vc detail
pseudowire145 is up, VC status is up PW type: Ethernet
Create time: 00:00:23, last status change time: 00:00:19
Last label FSM state change time: 00:00:19
Destination address: 102.0.0.1 VC ID: 145
Output interface: Fa0/0/1, imposed label stack {18 33}
Preferred path: not configured
Default path: active
Next hop: 11.1.1.1
Member of xconnect service fool45
Associated member Gil/0/0.10 is up, status is up
Interworking type is Ethernet
Service id: 0xed000030
Signaling protocol: LDP, peer 102.0.0.1:0 up
Targeted Hello: 104.0.0.1(LDP Id) -> 102.0.0.1, LDP is UP
Graceful restart: configured and enabled
Non stop routing: not configured and not enabled
PWid FEC (128), VC ID: 145
Status TLV support (local/remote) : enabled/supported
LDP route watch : enabled
Label/status state machine : established, LruRru
Local dataplane status received : No fault
BFD dataplane status received : Not sent
BFD peer monitor status received : No fault
Status received from access circuit : No fault
Status sent to access circuit : No fault
Status received from pseudowire i/f : No fault
Status sent to network peer : No fault
Status received from network peer : No fault
Adjacency status of remote peer : No fault
Sequencing: receive disabled, send disabled
Bindings
Parameter Local Remote

Label 33 33

```

```

Group ID 0 0
Interface Connect to CE2 Connect to CE1
MTU 1500 1500
Control word on (configured: autosense) on
PW type Ethernet Ethernet
VCCV CV type 0x02 0x02
 LSPV [2] LSPV [2]
VCCV CC type 0x07 0x07
 CW [1], RA [2], TTL [3] CW [1], RA [2], TTL [3]
Status TLV enabled supported
SSO Descriptor: 102.0.0.1/145, local label: 33
Dataplane:
 SSM segment/switch IDs: 4361/4360 (used), PWID: 48
Rx Counters
 8 input transit packets, 344 bytes
 0 drops, 0 seq err
Tx Counters
 5 output transit packets, 380 bytes
 0 drops

```

## Example: HDLC-Dot1Q Interworking

The following example shows how to configure HDLC-dot1q interworking:

Short form

On HDLC-PE:

```

configure terminal
template type pseudowire hdlc-vlan1-tmp
encapsulation mpls
signaling protocol ldp

l2vpn xconnect context hdlc-vlan1
interworking ethernet
member Serial0/2/0:3
member pseudowire101 192.0.2.3 107 template hdlc-vlan1-tmp
no shutdown
end

```

On Ethernet-PE:

```

configure terminal
interface FastEthernet0/0/0.16
description Connect to CE2
encapsulation dot1q 16
no ip address
no shut
!
template type pseudowire hdlc-vlan1-tmp
encapsulation mpls
signaling protocol ldp

l2vpn xconnect context hdlc-vlan1
interworking ethernet
member FastEthernet0/0/0.16
member pseudowire101 192.0.2.1 107 template hdlc-vlan1-tmp
no shutdown
end

```

Long form

On HDLC-PE:

```

configure terminal
template type pseudowire hdlc-vlan1
 encapsulation mpls
!
interface pseudowire107
 source template type pseudowire hdlc-vlan1
 encapsulation mpls
 neighbor 192.0.2.3 107
 signaling protocol ldp
 no shut
!
l2vpn xconnect context hdlc-vlan1-con
 interworking ethernet
 member Serial0/2/0:3
 member pseudowire107
 no shutdown
end

```

#### On Ethernet-PE:

```

configure terminal
interface FastEthernet0/0/0.16
 description Connect to CE2
 encapsulation dot1q 16
 no ip address
 no shut
!
template type pseudowire hdlc-vlan1
 encapsulation mpls
!
interface pseudowire107
 source template type pseudowire hdlc-vlan1
 encapsulation mpls
 neighbor 192.0.2.1 107
 signaling protocol ldp
 no shut
!
l2vpn xconnect context hdlc-vlan1-con
 interworking ethernet
 member FastEthernet0/0/0.16
 member pseudowire107
 no shutdown
end

```

## Additional References

The following sections provide references related to the Frame Relay-to-ATM Bridged Interworking and xconnect support on GEC (VPWS) features.

#### Related Documents

| Related Topic  | Document Title                                                                                             |
|----------------|------------------------------------------------------------------------------------------------------------|
| Basics of MPLS | {start cross reference}MPLS: Basic MPLS Configuration Guide, Cisco IOS XE Release 3S {end cross reference} |

| Related Topic                        | Document Title                                                                                             |
|--------------------------------------|------------------------------------------------------------------------------------------------------------|
| MPLS Layer 2 VPNs                    | {start cross reference}MPLS Layer 2 VPNs Configuration Guide, Cisco IOS XE Release 3S{end cross reference} |
| Cisco IOS Configuration Fundamentals | {start cross reference}Cisco IOS Configuration Fundamentals Command Reference{end cross reference}         |

### Standards

| Standard                                                    | Title |
|-------------------------------------------------------------|-------|
| No new or modified standards are supported by this feature. | —     |

### MIBs

| MIB                                                                                                     | MIBs Link                                                                                                                                                                                                           |
|---------------------------------------------------------------------------------------------------------|---------------------------------------------------------------------------------------------------------------------------------------------------------------------------------------------------------------------|
| <ul style="list-style-type: none"> <li>• CISCO-IETF-PW-MIB</li> <li>• CISCO-IETF-PW-MPLS-MIB</li> </ul> | To locate and download MIBs for selected platforms, Cisco IOS releases, and feature sets, use the Cisco MIB Locator found at the following URL:<br><br>{start hypertext}http://www.cisco.com/go/mibs{end hypertext} |

### RFCs

| RFC <sup>1</sup> | Title                                                   |
|------------------|---------------------------------------------------------|
| RFC 2684         | Multiprotocol Encapsulation over ATM Adaptation Layer 5 |
| RFC 2427         | Multiprotocol Interconnect over Frame Relay             |

{start footnote}Not all the supported RFCs are listed.{end footnote}

## Technical Assistance

| Description                                                                                                                                                                                                                                                                                                                                                                                                                                                                                                                                                             | Link                                                                                              |
|-------------------------------------------------------------------------------------------------------------------------------------------------------------------------------------------------------------------------------------------------------------------------------------------------------------------------------------------------------------------------------------------------------------------------------------------------------------------------------------------------------------------------------------------------------------------------|---------------------------------------------------------------------------------------------------|
| <p>The Cisco Support website provides extensive online resources, including documentation and tools for troubleshooting and resolving technical issues with Cisco products and technologies.</p> <p>To receive security and technical information about your products, you can subscribe to various services, such as the Product Alert Tool (accessed from Field Notices), the Cisco Technical Services Newsletter, and Really Simple Syndication (RSS) Feeds.</p> <p>Access to most tools on the Cisco Support website requires a Cisco.com user ID and password.</p> | <p>{start<br/>hypertext}http://www.cisco.com/cisco/web/support/index.html {end<br/>hypertext}</p> |

## Feature Information for Configuring MPLS Layer 2 VPNs

{start cross reference} Table 17-2 {end cross reference} lists the features in this module and provides links to specific configuration information. Only features that were introduced or modified in Cisco IOS Release 3.6.0S or a later release appear in the table.

Not all commands may be available in your Cisco IOS software release. For release information about a specific command, see the corresponding command reference documentation.

Use the Cisco Feature Navigator to find information about platform support and software image support. The Cisco Feature Navigator enables you to determine which Cisco IOS and Cisco Catalyst operating system software images support a specific software release, feature set, or platform. To access the Cisco Feature Navigator, go to {start hypertext}http://www.cisco.com/go/cfn {end hypertext}. An account on Cisco.com is not required.

Table 45: Feature Information for Configuring MPLS Layer 2 VPNs

| Feature Name                              | Releases | Feature Information                                                                                                                                                                                                                                                                                                                                                                                                                                                                                                                                                                                                                                                                                                                                                                                                                                                                                                                                                                                                                                                                                                                                                                      |
|-------------------------------------------|----------|------------------------------------------------------------------------------------------------------------------------------------------------------------------------------------------------------------------------------------------------------------------------------------------------------------------------------------------------------------------------------------------------------------------------------------------------------------------------------------------------------------------------------------------------------------------------------------------------------------------------------------------------------------------------------------------------------------------------------------------------------------------------------------------------------------------------------------------------------------------------------------------------------------------------------------------------------------------------------------------------------------------------------------------------------------------------------------------------------------------------------------------------------------------------------------------|
| Frame Relay to ATM Bridged Interworking   | 3.6.0S   | <p>The Frame Relay to ATM Bridged Interworking feature provides interoperability between the Frame Relay attachment VC and the ATM attachment VC connected to different PE routers. The bridged encapsulation corresponding to the bridged (Ethernet) interworking mechanism is used. The Ethernet frames are carried through the MPLS network using Ethernet over MPLS (EoMPLS).</p> <p>In Cisco IOS XE Release 3.6.0S, this feature was implemented on the Cisco ASR 1000 Series Aggregation Services Routers.</p> <p>The following sections provide information about this feature:</p> <ul style="list-style-type: none"> <li>{start cross reference}Frame Relay DLCI-to-ATM AAL5SNAP Bridged Interworking{end cross reference}</li> <li>{start cross reference}Configuring Frame Relay DLCI-to-ATM AAL5SNAP Bridged Interworking{end cross reference}</li> </ul>                                                                                                                                                                                                                                                                                                                    |
| xconnect support on GEC (VPWS) on ASR1000 | 3.6.0S   | <p>The Xconnect Support on GEC (VPWS) on ASR1000 feature enables the service providers to supply connectivity between customer sites with existing data link layer (Layer 2) networks by using a single, integrated, packet-based network infrastructure—a Cisco MPLS network. Instead of separate networks with network management environments, service providers can deliver Layer 2 connections over an MPLS backbone.</p> <p>In Cisco IOS XE Release 3.6.0S, this feature was implemented on the ASR 1000 Series Aggregation Services Routers.</p> <p>The following sections provide information about this feature:</p> <ul style="list-style-type: none"> <li>{start cross reference}Gigabit EtherChannel for Virtual Private Wire Service{end cross reference}</li> <li>{start cross reference}Configuring Gigabit EtherChannel for Virtual Private Wire Service{end cross reference}</li> </ul>                                                                                                                                                                                                                                                                                 |
| Reverse Layer 2 Gateway Protocol          | 3.8.0S   | <p>Reverse L2GP (R-L2GP) is a variation of L2GP. In case of R-L2GP, the pseudo information of the R-L2GP is transmitted by nPEs, instead of uPEs. R-L2GP provides a mechanism to send out static preconfigured BPDUs on each ring access port of nPEs to stimulate a per-access ring instantiation of the protocol. R-L2GP enables the PEs to avoid the burden of running Multiple-instance Spanning Tree Protocol (MST) when multiple independent access networks that run MST connect to a pair of redundant PEs. In order for this to work, the pair of nPEs are programmed to send out BPDUs on the access ring ports in such a way that they appear to be either:</p> <ul style="list-style-type: none"> <li>The root bridge itself (the bridge with the lowest bridge id/priority).</li> <li>The bridge with the second lowest bridge ID/priority, and with a 0 cost path to the root.</li> </ul> <p>The following sections provide information about this feature:</p> <ul style="list-style-type: none"> <li>{start cross reference}Reverse Layer 2 Gateway Protocol{end cross reference}</li> <li>{start cross reference}Configuring the R-L2GP{end cross reference}</li> </ul> |

| Feature Name               | Releases | Feature Information                                                                                                                                                                                                                                                                                                                                                                                                                                                                                                                                                                                                                            |
|----------------------------|----------|------------------------------------------------------------------------------------------------------------------------------------------------------------------------------------------------------------------------------------------------------------------------------------------------------------------------------------------------------------------------------------------------------------------------------------------------------------------------------------------------------------------------------------------------------------------------------------------------------------------------------------------------|
| HDLC-Ethernet Interworking | 3.13.0S  | <p>High-Level Data Link Control (HDLC)-Ethernet over MPLS is part of Any Transport over MPLS (AToM) solution. HDLC and Ethernet are two link-layer transport systems that utilize the AToM architecture. The feature describes how these two transport system can communicate with each other using the AToM framework.</p> <p>The following sections provide information about this feature:</p> <ul style="list-style-type: none"> <li>{start cross reference}High-Level Data Link Control-Ethernet Interworking{end cross reference}</li> <li>{start cross reference}Configuring HDLC-Ethernet Interworking{end cross reference}</li> </ul> |

## Glossary

**ATM**—Asynchronous Transfer Mode. A method of data transportation, whereby fixed-length packets are sent over a switched network. The method's ability to ensure reliable delivery of packets at a high rate makes it suitable for carrying voice, video, and data.

**AToM**—Any Transport over MPLS. AToM is a solution for transporting Layer 2 packets over an MPLS backbone. AToM enables service providers to supply connectivity between customer sites with existing data link layer (Layer 2) networks by using a single, integrated, packet-based network infrastructure—a Cisco MPLS network. Instead of separate networks with separate network management environments, service providers can deliver Layer 2 connections over an MPLS backbone.

**Dot1q**—IEEE 802.1Q is the networking standard that supports virtual LANs (VLANs) on an Ethernet network. The standard defines a system of VLAN tagging for Ethernet frames and the accompanying procedures to be used by bridges and switches in handling such frames.

**EoMPLS**—Ethernet over MPLS. This technology leverages an existing MPLS backbone network to deliver Transparent LAN Services based on Ethernet connectivity to the customer site.

**GEC**—Gigabit EtherChannel. A high-performance Ethernet technology that provides gigabit per second transmission rates. It provides a flexible and scalable bandwidth with resiliency and load sharing across links for switches, router interfaces, and servers. Supports up to eight links per channel.

**HDLC**—High-Level Data Link Control (HDLC) is a bit-oriented code-transparent synchronous data link-layer protocol developed by the International Organization for Standardization (ISO).

**MPLS**—Multiprotocol Label Switching. A mechanism in high-performance telecommunications networks that directs and carries data from one network node to the next. MPLS makes it easy to create virtual links between distant nodes. It can encapsulate packets of various network protocols.

**QinQ**—IEEE 802.1ad is an Ethernet networking standard informally known as IEEE 802.1QinQ, and is an amendment to the IEEE standard 802.1Q-1998. The technique is also known as provider bridging, Stacked VLANs, or simply QinQ or Q-in-Q.

**VPLS**—Virtual Private LAN Service. A method to provide Ethernet-based multipoint-to-multipoint communication over IP and MPLS networks.





## CHAPTER 22

# EVPN VPWS over SR-TE Preferred Path

The Ethernet VPN Virtual Private Wire Service (EVPN VPWS) functionality implements the signaling and encapsulation techniques for establishing an EVPN instance between a pair of PEs. This enhancement extends EVPN VPWS to support the specification of an SR-TE policy using the **preferred path** feature.

- [Feature Information for EVPN VPWS over SR-TE Preferred Path, on page 531](#)
- [Restrictions for EVPN VPWS over SR-TE Preferred Path, on page 531](#)
- [Information About EVPN VPWS over SR-TE Preferred Path, on page 532](#)
- [How to Configure EVPN VPWS over SR-TE Preferred Path, on page 532](#)
- [Verifying EVPN VPWS over SR-TE Preferred Path, on page 533](#)

## Feature Information for EVPN VPWS over SR-TE Preferred Path

The following table provides release information about the feature or features described in this module. This table lists only the software release that introduced support for a given feature in a given software release train. Unless noted otherwise, subsequent releases of that software release train also support that feature.

Use the Cisco Feature Navigator to find information about platform support and Cisco software image support. To access the Cisco Feature Navigator, go to [www.cisco.com/go/cfn](http://www.cisco.com/go/cfn). An account on Cisco.com is not required.

**Table 46: Feature Information for EVPN VPWS over SR-TE Preferred Path**

| Feature Name                        | Releases                       | Feature Information          |
|-------------------------------------|--------------------------------|------------------------------|
| EVPN VPWS over SR-TE Preferred Path | Cisco IOS XE Cupertino 17.7.1a | This feature was introduced. |

## Restrictions for EVPN VPWS over SR-TE Preferred Path

- SR On-Demand Next Hop (ODN) policy is not supported; only SR static policy is supported.
- SR Per-Flow Policy (PFP) is not supported; only SR Per-Destination Policy (PDP) is supported.
- Interior Gateway Protocol (IGP) is Intermediate System-to-Intermediate system (IS-IS).

## Information About EVPN VPWS over SR-TE Preferred Path

The EVPN VPWS functionality implements the signaling and encapsulation techniques for establishing an EVPN instance between a pair of PEs. This enhancement enables EVPN VPWS to support the specification of an SR-TE policy using the **preferred path** feature. This feature includes the **fallback disable** option, which disables the default behavior of falling back on an alternate path if the preferred path is down.

The following figure illustrates the architecture:

**Figure 17: EVPN VPWS over SR-TE Architecture**

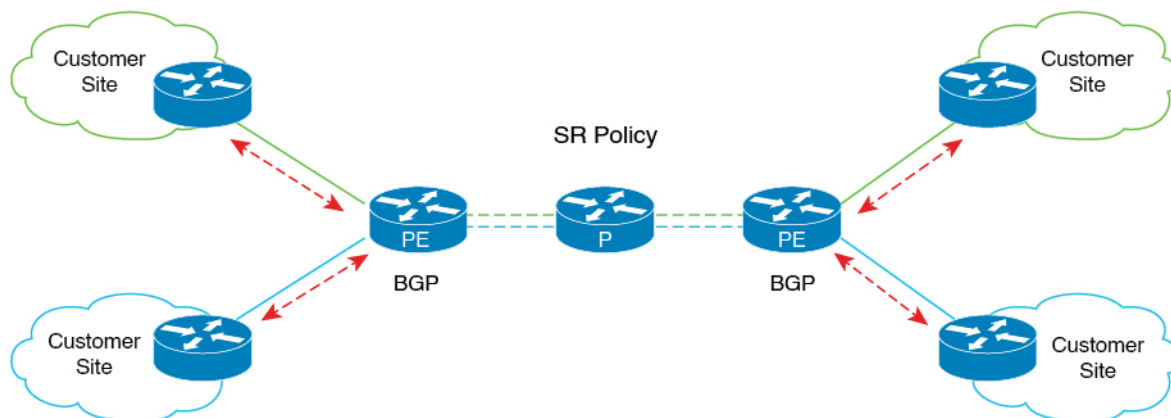

357825

## How to Configure EVPN VPWS over SR-TE Preferred Path

The following sections provide information about the tasks involved in configuring EVPN VPWS over the SR-TE preferred path.

### Configuring EVPN VPWS over SR-TE Preferred Path

The following example shows how to enable EVPN VPWS over the configured SR-TE preferred path:

```
l2vpn evpn instance 100 point-to-point
rd 100:100
route-target export 100:100
route-target import 100:100
!
vpls context vc100
 preferred-path segment-routing traffic-eng policy p-100
 service target 100 source 100
interface GigabitEthernet0/0/3
service instance 100 ethernet
encapsulation dot1q 100
```

## Configuring EVPN VPWS over SR-TE Preferred Path with Fallback Disable

The **fallback disable** command prevents a device from using the default path if the preferred path SR policy goes down.

```
l2vpn evpn instance 100 point-to-point
rd 100:100
route-target export 100:100
route-target import 100:100
vpws context vc100
service target 100 source 100
member GigabitEthernet0/0/3 service-instance 100
preferred-path segment-routing traffic-eng policy p-100 disable-fallback
```

## Removing Fallback Disable from EVPN VPWS over SR-TE Preferred Path

The following example shows how to remove the fallback disable option in EVPN VPWS over SR-TE preferred path:

```
l2vpn evpn instance 100 point-to-point
vpws context vc100
preferred-path segment-routing traffic-eng policy p-100
```

## Disabling EVPN VPWS over SR-TE Preferred Path Configuration

The following example shows how to disable the EVPN VPWS over SR-TE preferred path configuration:

```
l2vpn evpn instance 100 point-to-point
vpws context vc100
no preferred-path segment-routing traffic-eng policy p-100 disable-fallback
```

## Verifying EVPN VPWS over SR-TE Preferred Path

The following sample outputs show how to verify the EVPN VPWS over SR-TE preferred path and fallback disable configurations.

- The following is a sample output showing the EVPN VPWS configuration over an SR-TE preferred path:

```
device# show l2vpn evpn vpws VC ID 100 detail
EVPN name: vc100, state: up, type: point-to-point
EVPN ID: 100
VPWS Service Instance ID: Source 1, Target 2
Labels: Local 17, Remote 17
Next Hop Address: 6.6.6.6
Associated member interface Gi0/0/3 up, Gi0/0/3:3000 status is up
Output interface: Tu65536, imposed label stack {16016 17}
Preferred path: active
Default path: ready
```

```
device# show l2vpn evpn vpws vc preferred-path
Tunnel EVPN ID Source Target Name Status

Tunnel65536 100 1 2 vc100 up
```

- The following is a sample output showing the EVPN VPWS configuration over an SR-TE preferred path, with fallback disabled:

```
device# show l2vpn evpn vpws VC ID 100 detail
EVPN name: vc100, state: up, type: point-to-point
 EVPN ID: 100
 VPWS Service Instance ID: Source 1, Target 2
 Labels: Local 17, Remote 17
 Next Hop Address: 6.6.6.6
 Associated member interface Gi0/0/3 up, Gi0/0/3:3000 status is up
 Output interface: Tu65536, imposed label stack {16016 17}
 Preferred path: active
 Default path: disabled
Dataplane:
SSM segment/switch IDs: 25037/12290 (used), PWID: 1
Rx Counters
1241 input transit packets, 463266 bytes
0 drops
Tx Counters
828 output transit packets, 402840 bytes
0 drops
24 VC FSM state transitions, Last 10 shown
DpUp: Act -> Est, Mon Sep 06 23:32:43.809 (2w2d ago)
RemDn: Est -> RemWait, Mon Sep 06 23:32:43.809 (2w2d ago)
RemUp: RemWait -> Act, Mon Sep 06 23:32:43.816 (2w2d ago)
DpUp: Act -> Est, Mon Sep 06 23:32:43.816 (2w2d ago)
DpDn: Est -> Act, Mon Sep 06 23:35:57.944 (2w2d ago)
DpUp: Act -> Est, Mon Sep 06 23:43:50.071 (2w2d ago)
DpDn: Est -> Act, Mon Sep 06 23:46:15.361 (2w2d ago)
DpUp: Act -> Est, Mon Sep 06 23:54:11.508 (2w2d ago)
DpDn: Est -> Act, Tue Sep 07 00:00:11.248 (2w2d ago)
DpUp: Act -> Est, Tue Sep 07 00:06:27.355 (2w2d ago)
```

- The following is a sample output showing the EVPN VPWS configuration over an SR-TE preferred path, with fallback disable option removed:

```
device# show l2vpn evpn vpws VC ID 100 detail
EVPN name: vc100, state: up, type: point-to-point
 EVPN ID: 100
 VPWS Service Instance ID: Source 1, Target 2
 Labels: Local 17, Remote 17
 Next Hop Address: 6.6.6.6
 Associated member interface Gi0/0/3 up, Gi0/0/3:3000 status is up
 Output interface: Tu65536, imposed label stack {16016 17}
 Preferred path: active
 Default path: ready
```

- The following is a sample output showing the EVPN VPWS configuration over an SR-TE preferred path disabled:

```
device# show l2vpn evpn vpws VC ID 100 detail
EVPN name: vc100, state: up, type: point-to-point
 EVPN ID: 100
 VPWS Service Instance ID: Source 1, Target 2
 Labels: Local 17, Remote 17
 Next Hop Address: 6.6.6.6
 Associated member interface Gi0/0/3 up, Gi0/0/3:3000 status is up
 Output interface: Gi0/0/0, imposed label stack {16 16}
 Preferred path: not configured
 Default path: active
```



## CHAPTER 23

# Enabling Management by REST API

- [Introduction, on page 535](#)
- [Overview of Installation, on page 535](#)
- [Enabling REST API Support Using the Cisco IOS XE CLI, on page 536](#)

## Introduction

You can use the Cisco IOS XE REST API to manage the Cisco ASR 1001-X and ASR 1002-X as an alternative to configuring and managing selected features on the router using the Cisco IOS XE CLI. This chapter describes how to configure these Cisco ASR routers to enable management using the REST API. For detailed information about using the REST API, see the [Cisco IOS XE REST API Management Reference Guide](#).

## Overview of Installation

Installing the Cisco IOS XE REST API involves the following general steps:

1. Download the OVA package from Cisco.com.
  - a. From the Cisco Routers product page, navigate to the Cisco CSR 1000V Cloud Services Router product page. <http://www.cisco.com/c/en/us/products/routers/cloud-services-router-1000v-series/index.html>
  - b. Click the “Download Software” link.
  - c. Select the Cisco IOS XE release package and follow the instructions for downloading the software.
2. Install the REST API OVA on the ASR platform.
3. Enable the REST API on the ASR platform.

# Enabling REST API Support Using the Cisco IOS XE CLI

## Configuring the Data Plane Dual Management Interface to Support the REST API

Beginning with Cisco IOS XE 3.16, it is possible to associate management container IP addresses with either:

- Data plane interface (see procedure below)

or

- Management plane interface (see [Configuring the Management Plane Dual Management Interface to Support the REST API](#))

### Configuration Notes

`{start blocklabel}Management Container IP Addresses in Subnet of Router Management Interface{end blocklabel}`

To allocate the management container IP addresses to be associated with the router's management interface, ensure that the IP addresses configured for the management container are within the same subnet as the router's management interface. For example:

Management container IP address: 192.168.5.225

Router management interface: 192.168.5.224

`{start blocklabel}Order of Configuring Gateway Port, Management Interface, and IP Addresses{end blocklabel}`

Configuring the management container details in the following order:

1. vNIC gateway port (`vnic gateway virtualportgroup0`)
2. Guest IP addresses

The vNIC management interface (`vnic management GigabitEthernet0`) can be configured after the guest IP addresses.

### SUMMARY STEPS

1. **enable**
2. **configure terminal**
3. **interface GigabitEthernetx**
4. **ip address *ipv4-addr subnet-mask***
5. **no shutdown**
6. **exit**
7. **interface virtualportgroup *virtualportgroup-number***
8. **configure terminal**
9. **interface virtualportgroup 0**
10. **ip unnumbered GigabitEthernet0/0/0**
11. **exit**

12. **ip route** *ipv4-address ipv4-subnet-mask VirtualPortGroup0*
13. **exit**
14. **ip unnumbered** *GigabitEthernetx*
15. **no shutdown**
16. **exit**
17. **virtual-service** *csr\_mgmt*
18. **vnic gateway** *virtualportgroup virtualportgroup\_number*
19. **guest ip address** *remote-mgmt-ipv4-addr*
20. **exit**
21. **vnic management** *GigabitEthernet0*
22. **exit**
23. **activate**
24. **end**
25. **ip route** *ipaddress subnetmask virtualportgroup virtualportgroupnumber*

## DETAILED STEPS

|        | Command or Action                                                                                                                            | Purpose                                                                                                                                           |
|--------|----------------------------------------------------------------------------------------------------------------------------------------------|---------------------------------------------------------------------------------------------------------------------------------------------------|
| Step 1 | <b>enable</b><br><b>Example:</b><br><pre>Router&gt; enable</pre>                                                                             | Enables privileged EXEC mode. <ul style="list-style-type: none"> <li>• Enter your password if prompted.</li> </ul>                                |
| Step 2 | <b>configure terminal</b><br><b>Example:</b><br><pre>Router# configure terminal</pre>                                                        | Enters global configuration mode.                                                                                                                 |
| Step 3 | <b>interface</b> <i>GigabitEthernetx</i><br><b>Example:</b><br><pre>Router(config)# interface gigabitethernet1</pre>                         | Enters interface configuration mode for the interface designated by <i>x</i> .<br><br>The range of GigabitEthernet ports depends on the platform. |
| Step 4 | <b>ip address</b> <i>ipv4-addr subnet-mask</i><br><b>Example:</b><br><pre>Router(config-if)# ip address 198.51.100.235 255.255.255.128</pre> | Configures the IP address for the management interface.                                                                                           |
| Step 5 | <b>no shutdown</b><br><b>Example:</b><br><pre>Router(config-if)# no shutdown</pre>                                                           | Enables the management interface.                                                                                                                 |
| Step 6 | <b>exit</b><br><b>Example:</b>                                                                                                               | Exits interface configuration mode.                                                                                                               |

|                | Command or Action                                                                                                                                                                                | Purpose                                                                                                                                  |
|----------------|--------------------------------------------------------------------------------------------------------------------------------------------------------------------------------------------------|------------------------------------------------------------------------------------------------------------------------------------------|
|                | <code>Router(config-if)# exit</code>                                                                                                                                                             |                                                                                                                                          |
| <b>Step 7</b>  | <b>interface virtualportgroup</b> <i>virtualportgroup-number</i><br><b>Example:</b><br><code>Router(config)# interface virtualportgroup 0</code>                                                 | Creates a virtual port group and enters virtual port group interface configuration mode.                                                 |
| <b>Step 8</b>  | <b>configure terminal</b><br><b>Example:</b><br><code>Router(config)# configure terminal</code>                                                                                                  | Enter interface configuration mode.                                                                                                      |
| <b>Step 9</b>  | <b>interface virtualportgroup 0</b><br><b>Example:</b><br><code>Router(config)# interface virtualportgroup 0</code>                                                                              | Creates a virtual port group and enters virtual port group interface configuration mode.                                                 |
| <b>Step 10</b> | <b>ip unnumbered GigabitEthernet0/0/0</b><br><b>Example:</b><br><code>Router(config)# ip unnumbered GigabitEthernet0/0/0</code>                                                                  | Enables IP processing on an interface without assigning it an explicit IP address.                                                       |
| <b>Step 11</b> | <b>exit</b><br><b>Example:</b><br><code>Router(config)# exit</code>                                                                                                                              | Exit interface configuration mode.                                                                                                       |
| <b>Step 12</b> | <b>ip route</b> <i>ipv4-address</i> <i>ipv4-subnet-mask</i><br><b>VirtualPortGroup0</b><br><b>Example:</b><br><code>Router# ip route 198.51.100.108 255.255.255.255<br/>VirtualPortGroup0</code> | Creates an IP route that maps to the virtual port group. Use the same IP address that was configured using the guest ip address command. |
| <b>Step 13</b> | <b>exit</b><br><b>Example:</b><br><code>Router# exit</code>                                                                                                                                      | Exit configuration mode.                                                                                                                 |
| <b>Step 14</b> | <b>ip unnumbered GigabitEthernetx</b><br><b>Example:</b><br><code>router(config-if)# ip unnumbered gigabitethernet1</code>                                                                       | Enables IP processing on an interface without assigning it an explicit IP address.                                                       |
| <b>Step 15</b> | <b>no shutdown</b><br><b>Example:</b>                                                                                                                                                            | Enables the virtual port group interface.                                                                                                |



|                | Command or Action                                                                                                                                                      | Purpose                                                                                                                                                                                                                            |
|----------------|------------------------------------------------------------------------------------------------------------------------------------------------------------------------|------------------------------------------------------------------------------------------------------------------------------------------------------------------------------------------------------------------------------------|
|                | <pre>router(config-if)# no shutdown</pre>                                                                                                                              |                                                                                                                                                                                                                                    |
| <b>Step 16</b> | <p><b>exit</b></p> <p><b>Example:</b></p> <pre>router(config-if)# exit</pre>                                                                                           | Exits virtual port group interface mode.                                                                                                                                                                                           |
| <b>Step 17</b> | <p><b>virtual-service csr_mgmt</b></p> <p><b>Example:</b></p> <pre>router(config)# virtual-service csr_mgmt</pre>                                                      | Configures the virtual services container and enters virtual services configuration mode.                                                                                                                                          |
| <b>Step 18</b> | <p><b>vnic gateway virtualportgroup <i>virtualportgroup_number</i></b></p> <p><b>Example:</b></p> <pre>router(config-virt-serv)# vnic gateway virtualportgroup 0</pre> | Creates a vNIC gateway interface for the virtual services container and maps it to the virtual port group.                                                                                                                         |
| <b>Step 19</b> | <p><b>guest ip address <i>remote-mgmt-ipv4-addr</i></b></p> <p><b>Example:</b></p> <pre>router(config-virt-serv-intf)# guest ip address 198.51.100.236</pre>           | Configures the remote-management IP address for the vNIC gateway interface for the virtual services container.                                                                                                                     |
| <b>Step 20</b> | <p><b>exit</b></p> <p><b>Example:</b></p> <pre>router(config-virt-serv-intf)# exit</pre>                                                                               | Exits virtual services interface configuration mode and enters virtual services configuration mode.                                                                                                                                |
| <b>Step 21</b> | <p><b>vnic management GigabitEthernet0</b></p> <p><b>Example:</b></p> <pre>router(config-virt-serv)# vnic management GigabitEthernet0</pre>                            | <p>(Cisco IOS XE 3.16S and later only)</p> <p>Beginning with Cisco IOS XE 3.16S, it is necessary to configure two vnic interfaces:</p> <ul style="list-style-type: none"> <li>• vnic gateway</li> <li>• vnic management</li> </ul> |
| <b>Step 22</b> | <p><b>exit</b></p> <p><b>Example:</b></p> <pre>router(config-virt-serv-vnic)# exit</pre>                                                                               | Exits vNIC management mode.                                                                                                                                                                                                        |
| <b>Step 23</b> | <p><b>activate</b></p> <p><b>Example:</b></p> <pre>router(config-virt-serv-vnic)# activate</pre>                                                                       | Activates the <b>csr_mgmt</b> virtual services container.                                                                                                                                                                          |

|                | Command or Action                                                                                                                                                                                            | Purpose                                                                                                                                         |
|----------------|--------------------------------------------------------------------------------------------------------------------------------------------------------------------------------------------------------------|-------------------------------------------------------------------------------------------------------------------------------------------------|
| <b>Step 24</b> | <b>end</b><br><b>Example:</b><br><pre>router(config-virt-serv)# end</pre>                                                                                                                                    | Exits virtual services configuration mode and enters global configuration mode.                                                                 |
| <b>Step 25</b> | <b>ip route <i>ipaddress subnetmask</i> <i>virtualportgroup</i> <i>virtualportgroupnumber</i></b><br><b>Example:</b><br><pre>router(config)# ip route 198.51.100.236 255.255.255.255 VirtualPortGroup0</pre> | Creates an IP route that maps to the virtual port group. Use the same IP address that was configured using the <b>guest ip address</b> command. |

## Configuring the Management Plane Dual Management Interface to Support the REST API

Beginning with Cisco IOS XE 3.16, it is possible to associate management container IP addresses with either:

- Management plane interface (see procedure below)

or

- Data plane interface (see {start cross reference} Configuring the Data Plane Dual Management Interface to Support the REST API){end cross reference}

### Configuration Notes

{start blocklabel} Management Container IP Addresses in Subnet of Router Management Interface {end blocklabel}

To allocate the management container IP addresses to be associated with the router's management interface, ensure that the IP addresses configured for the management container are within the same subnet as the router's management interface. For example:

Management container IP address: 192.168.5.225

Router management interface: 192.168.5.224

{start blocklabel} Order of Configuring Gateway Port, Management Interface, and IP Addresses {end blocklabel}

Configuring the management container details in the following order:

1. vNIC gateway port (vnic gateway virtualportgroup0)
2. vNIC management interface (vnic management GigabitEthernet0)
3. Guest IP addresses

In contrast to the related procedure that uses the data plane interface, in this case, the vNIC management interface must be configured before configuring guest IP addresses.

## SUMMARY STEPS

1. **enable**
2. **configure terminal**
3. **interface GigabitEthernetx**
4. **ip address *ipv4-addr subnet-mask***
5. **no shutdown**
6. **exit**
7. **interface virtualportgroup *virtualportgroup-number***
8. **configure terminal**
9. **interface virtualportgroup 0**
10. **ip unnumbered GigabitEthernet0/0/0**
11. **exit**
12. **ip unnumbered GigabitEthernetx**
13. **no shutdown**
14. **exit**
15. **virtual-service csr\_mgmt**
16. **vnic gateway virtualportgroup *virtualportgroup\_number***
17. **exit**
18. **vnic management GigabitEthernet0**
19. **guest ip address *guest-mgmt-ipv4-address***
20. **exit**
21. **activate**
22. **end**
23. **ip route *ipaddress subnetmask virtualportgroup virtualportgroupnumber***

## DETAILED STEPS

|        | Command or Action                                                                                             | Purpose                                                                                                                                           |
|--------|---------------------------------------------------------------------------------------------------------------|---------------------------------------------------------------------------------------------------------------------------------------------------|
| Step 1 | <b>enable</b><br><b>Example:</b><br><pre>Router&gt; enable</pre>                                              | Enables privileged EXEC mode. <ul style="list-style-type: none"> <li>• Enter your password if prompted.</li> </ul>                                |
| Step 2 | <b>configure terminal</b><br><b>Example:</b><br><pre>Router# configure terminal</pre>                         | Enters global configuration mode.                                                                                                                 |
| Step 3 | <b>interface GigabitEthernetx</b><br><b>Example:</b><br><pre>Router(config)# interface gigabitethernet1</pre> | Enters interface configuration mode for the interface designated by <i>x</i> .<br><br>The range of GigabitEthernet ports depends on the platform. |
| Step 4 | <b>ip address <i>ipv4-addr subnet-mask</i></b><br><b>Example:</b>                                             | Configures the IP address for the management interface.                                                                                           |

|                | Command or Action                                                                                                                   | Purpose                                                                                  |
|----------------|-------------------------------------------------------------------------------------------------------------------------------------|------------------------------------------------------------------------------------------|
|                | Router(config-if)# ip address 198.51.100.235<br>255.255.255.128                                                                     |                                                                                          |
| <b>Step 5</b>  | <b>no shutdown</b><br><b>Example:</b><br>Router(config-if)# no shutdown                                                             | Enables the management interface.                                                        |
| <b>Step 6</b>  | <b>exit</b><br><b>Example:</b><br>Router(config-if)# exit                                                                           | Exits interface configuration mode.                                                      |
| <b>Step 7</b>  | <b>interface virtualportgroup <i>virtualportgroup-number</i></b><br><b>Example:</b><br>Router(config)# interface virtualportgroup 0 | Creates a virtual port group and enters virtual port group interface configuration mode. |
| <b>Step 8</b>  | <b>configure terminal</b><br><b>Example:</b><br>Router(config)# configure terminal                                                  | Enter interface configuration mode.                                                      |
| <b>Step 9</b>  | <b>interface virtualportgroup 0</b><br><b>Example:</b><br>Router(config)# interface virtualportgroup 0                              | Creates a virtual port group and enters virtual port group interface configuration mode. |
| <b>Step 10</b> | <b>ip unnumbered GigabitEthernet0/0/0</b><br><b>Example:</b><br>Router(config)# ip unnumbered GigabitEthernet0/0/0                  | Enables IP processing on an interface without assigning it an explicit IP address.       |
| <b>Step 11</b> | <b>exit</b><br><b>Example:</b><br>Router(config)# exit                                                                              | Exit interface configuration mode.                                                       |
| <b>Step 12</b> | <b>ip unnumbered GigabitEthernetx</b><br><b>Example:</b><br>router(config-if)# ip unnumbered gigabitethernet1                       | Enables IP processing on an interface without assigning it an explicit IP address.       |
| <b>Step 13</b> | <b>no shutdown</b><br><b>Example:</b><br>router(config-if)# no shutdown                                                             | Enables the virtual port group interface.                                                |

|         | Command or Action                                                                                                                                       | Purpose                                                                                                                                                                                                                 |
|---------|---------------------------------------------------------------------------------------------------------------------------------------------------------|-------------------------------------------------------------------------------------------------------------------------------------------------------------------------------------------------------------------------|
| Step 14 | <b>exit</b><br><b>Example:</b><br><pre>router(config-if)# exit</pre>                                                                                    | Exits virtual port group interface mode.                                                                                                                                                                                |
| Step 15 | <b>virtual-service csr_mgmt</b><br><b>Example:</b><br><pre>router(config)# virtual-service csr_mgmt</pre>                                               | Configures the virtual services container and enters virtual services configuration mode.                                                                                                                               |
| Step 16 | <b>vnic gateway virtualportgroup virtualportgroup_number</b><br><b>Example:</b><br><pre>router(config-virt-serv)# vnic gateway virtualportgroup 0</pre> | Creates a vNIC gateway interface for the virtual services container and maps it to the virtual port group.                                                                                                              |
| Step 17 | <b>exit</b><br><b>Example:</b><br><pre>router(config-virt-serv-intf)# exit</pre>                                                                        | Exits virtual services interface configuration mode and enters virtual services configuration mode.                                                                                                                     |
| Step 18 | <b>vnic management GigabitEthernet0</b><br><b>Example:</b><br><pre>router(config-virt-serv)# vnic management GigabitEthernet0</pre>                     | (Cisco IOS XE 3.16S and later only)<br>Beginning with Cisco IOS XE 3.16S, it is necessary to configure two vnic interfaces: <ul style="list-style-type: none"> <li>• vnic gateway</li> <li>• vnic management</li> </ul> |
| Step 19 | <b>guest ip address guest-mgmt-ipv4-address</b><br><b>Example:</b><br><pre>guest ip address 198.51.100.225</pre>                                        | Configures the remote-management IP address for the vNIC gateway interface for the virtual services container.                                                                                                          |
| Step 20 | <b>exit</b><br><b>Example:</b><br><pre>router(config-virt-serv-vnic)# exit</pre>                                                                        | Exits vNIC management mode.                                                                                                                                                                                             |
| Step 21 | <b>activate</b><br><b>Example:</b><br><pre>router(config-virt-serv)# activate</pre>                                                                     | Activates the <b>csr_mgmt</b> virtual services container.                                                                                                                                                               |
| Step 22 | <b>end</b><br><b>Example:</b><br><pre>router(config-virt-serv)# end</pre>                                                                               | Exits virtual services configuration mode and enters global configuration mode.                                                                                                                                         |

|                | Command or Action                                                                                                                                                                                      | Purpose                                                                                                                                         |
|----------------|--------------------------------------------------------------------------------------------------------------------------------------------------------------------------------------------------------|-------------------------------------------------------------------------------------------------------------------------------------------------|
| <b>Step 23</b> | <p><b>ip route</b> <i>ipaddress subnetmask virtualportgroup virtualportgroupnumber</i></p> <p><b>Example:</b></p> <pre>router(config)# ip route 198.51.100.236 255.255.255.255 VirtualPortGroup0</pre> | Creates an IP route that maps to the virtual port group. Use the same IP address that was configured using the <b>guest ip address</b> command. |

## Configuring the REST API Local Port and AutoSave Options

Beginning with Cisco IOS XE Release 3.13S, you can configure the REST API local port and autosave options.

### SUMMARY STEPS

1. `remote-management`
2. `restful-api local-port local-port-number`
3. `restful-api autosave interval`

### DETAILED STEPS

|               | Command or Action                                                                                                                                     | Purpose                                                                                                                                                                                                                                                                                                                                                                                                                                                                                                       |
|---------------|-------------------------------------------------------------------------------------------------------------------------------------------------------|---------------------------------------------------------------------------------------------------------------------------------------------------------------------------------------------------------------------------------------------------------------------------------------------------------------------------------------------------------------------------------------------------------------------------------------------------------------------------------------------------------------|
| <b>Step 1</b> | <p><code>remote-management</code></p> <p><b>Example:</b></p> <pre>router(config)# remote-management</pre>                                             | Enters remote-management configuration mode.                                                                                                                                                                                                                                                                                                                                                                                                                                                                  |
| <b>Step 2</b> | <p><b>restful-api local-port</b> <i>local-port-number</i></p> <p><b>Example:</b></p> <pre>router(cfg-remote-mgmt)# restful-api local-port 55443</pre> | <p>Configures the REST API local port number. The valid range depends on whether the REST API virtual services container uses the same IP address as the management interface, or if it uses a different IP address:</p> <ul style="list-style-type: none"> <li>• Valid range if the dual management interface is configured is from 1 to 61000.</li> <li>• Valid range if the shared management interface is configured is from 55001 to 61000.</li> </ul> <p>In both cases, the default value is 55443.</p> |
| <b>Step 3</b> | <p><b>restful-api autosave</b> <i>interval</i></p> <p><b>Example:</b></p> <pre>Router(cfg-remote-mgmt)# restful-api autosave 60</pre>                 | Configures the REST API autosave interval. The range is from 30-300 seconds, and the default is 30.                                                                                                                                                                                                                                                                                                                                                                                                           |

## Configuring onep

The Open Network Environment Programming Interface (onep) is used to define the service set for Cisco IOS and the REST API. Configure onep as follows.

**SUMMARY STEPS**

1. `conf t`
2. `onep`
3. `service set vty`
4. `end`

**DETAILED STEPS**

|               | <b>Command or Action</b>                                                                                                                               | <b>Purpose</b>              |
|---------------|--------------------------------------------------------------------------------------------------------------------------------------------------------|-----------------------------|
| <b>Step 1</b> | <code>conf t</code><br><b>Example:</b><br><code>asr1k#conf t</code><br><b>Example:</b><br>Enter configuration commands, one per line. End with CNTL/Z. | Enters configuration mode.  |
| <b>Step 2</b> | <code>onep</code><br><b>Example:</b><br><code>asr1k(config)#onep</code>                                                                                | Enters onep mode.           |
| <b>Step 3</b> | <code>service set vty</code><br><b>Example:</b><br><code>asr1k(config-onep)#service set vty</code>                                                     | Select the vty service set. |
| <b>Step 4</b> | <code>end</code><br><b>Example:</b><br><code>asr1k(config-onep)#end</code><br><b>Example:</b><br><code>asr1k#</code>                                   | Exit onep mode.             |

**Disabling REST API Support**

Support for the REST API is enabled by default. The following procedure disables the REST API.

**SUMMARY STEPS**

1. `enable`
2. `configure terminal`
3. `remote-management`
4. `no restful-api`

## 5. end

## DETAILED STEPS

|               | Command or Action                                                                              | Purpose                                                                                                               |
|---------------|------------------------------------------------------------------------------------------------|-----------------------------------------------------------------------------------------------------------------------|
| <b>Step 1</b> | <b>enable</b><br><b>Example:</b><br><pre>router&gt; enable</pre>                               | Enables privileged EXEC mode.<br><ul style="list-style-type: none"> <li>• Enter your password if prompted.</li> </ul> |
| <b>Step 2</b> | <b>configure terminal</b><br><b>Example:</b><br><pre>router# configure terminal</pre>          | Enters global configuration mode.                                                                                     |
| <b>Step 3</b> | <b>remote-management</b><br><b>Example:</b><br><pre>router(config)# remote-management</pre>    | Enters remote-management configuration mode.                                                                          |
| <b>Step 4</b> | <b>no restful-api</b><br><b>Example:</b><br><pre>router(cfg-remote-mgmt)# no restful-api</pre> | Disables support for the REST API.                                                                                    |
| <b>Step 5</b> | <b>end</b><br><b>Example:</b><br><pre>router(cfg-remote-mgmt)# end</pre>                       | Exits remote-management configuration mode and enters configuration mode.                                             |

## What to do next



**Note** When REST API support is disabled using the **no restful-api** command, the REST API PUT, POST and DELETE operations are disabled. However, the GET operation is still available.

## Viewing the REST API Container Status

Use the **show virtual-service detail** command to view the REST API container status.





## CHAPTER 24

# LSM-MLDP-based MVPN Support

First Published: November 28, 2012

The Label Switched Multicast (LSM) feature supports IPv4 and IPv6 multicast traffic over a Multi-Protocol Label Switching (MPLS) network. This feature is based on the basic MPLS infrastructure and supports IP multicast traffic through the MPLS clouds. The LSM feature enables service providers to extend the existing MPLS backbone network for multicast services. By default, MPLS creates an out-label for an in-label for each packet. This feature extends this functionality to create multiple out-labels for a single in-label.

The LSM service includes point-to-multipoint (P2MP) and multipoint-to-multipoint (MP2MP) packet transport. The P2MP packet transport can be implemented using either Resource reSerVation Protocol (RSVP) P2MP - Traffic Engineering (P2MP-TE), or Multicast Label Distribution Protocol (MLDP) based Multicast VPN (MVPN). The MP2MP packet transport can be implemented only through MLDP based MVPN.

The packets are transported over three types of routers:

- Head-end router: Encapsulates the IP packet with one or more labels.
- Midpoint router: Replaces the in-label with an out-label.
- Tail-end router: Removes the label from the packet.
- [Restrictions and Usage Guidelines, on page 547](#)
- [Configuring LSM-MLDP-based MVPN Support , on page 548](#)
- [Sample Configuration for MLDP MVPN, on page 576](#)
- [Troubleshooting LSM MLDP based MVPN Support , on page 607](#)
- [MVPN MLDP over GRE , on page 608](#)

## Restrictions and Usage Guidelines

Follow these restrictions and usage guidelines while configuring LSM-MLDP-based MVPN support:

- A head-end router does not support multiple sub Label Switched Paths (subLSPs) belonging to different tunnels, over the same physical interface.
- RSVP-TE-based LSM is not supported; only MLDP-based LSM is supported.
- Process-level software forwarding is not supported.
- Rosen Model MLDP is not supported in the global configuration mode. However, MLDP inband signaling is supported in the global configuration mode.
- These are the scale considerations for MLDP-based MVPN:

- Maximum number of Multicast Virtual Route Forwardings (MVRFs) supported on each PE is 600.
  - Maximum number of m-route supported on each PE is 200,000.
  - Maximum number of OIF supported is 1000.
  - Maximum number of MLDP ingress labels (local labels) supported on each PE is 100,000.
  - Maximum number of MLDP egress labels (remote labels) supported on each PE is 100,000.
  - Max of 32 PE or P neighbors in a PE router per MDT, and max of 33 PE or P neighbors in a P router per MDT.
- Supported content group modes are Protocol Independent Multicast (PIM) sparse mode (PIM-SM) and Source Specific Multicast (SSM) traffic.
  - Unsupported content group modes are PIM dense mode (PIM-DM) and bidirectional PIM (bidir-PIM) traffic.
  - The PIM-sparse content group mode is supported if the RP is configured behind the PE router (on CE). The RP and the source router have to be in the same VRF and PE site with the same RPF interface.
  - For RPF lookup in the context of the extranet, only the ip multicast rpf select command is supported for the configuration.
  - The MLDP provides only link protection with the FRR TE. Only single hop is supported with MLDP TE. However, the backup path can have multiple hops.
  - If you use MLDP to configure RSVP-TE with Fast Reroute, ensure that unidirectional tunnels are set up in each direction for incoming and outgoing traffic.

## Configuring LSM-MLDP-based MVPN Support

Deployment of an LSM-MLDP-based MVPN involves configuring a default Multicast Distribution Trees (MDT) and one or more data MDTs.

A static default MDT is established for each multicast domain. The default MDT defines the path used by PE routers to send multicast data and control messages to other PE routers in the multicast domain. A default MDT is created in the core network using a single MP2MP LSP.

An MLDP-based MVPN also supports dynamic creation of data MDTs for high-bandwidth transmissions. For high-rate data sources, a data MDT is created using the P2MP LSPs to offload the traffic from the default MDT to avoid unnecessary wastage of bandwidth to PEs that are not a part of the stream. You can configure MLDP MVPN for both the intranet and the extranet.



---

**Note** Before configuring MLDP-based MVPN, ensure that the MPLS is enabled on the core facing interface. For information on MPLS configuration, see the [Cisco IOS Multiprotocol Label Switching Configuration Guide](#). Also, ensure that the BGP and any interior gateway protocol (OSPF or ISIS) is enabled on the core router.

---

## Configuring MLDP MVPN Intranet Services

Complete these steps to configure MLDP MVPN for intranet:

- Enabling MPLS MLDP
- Configuring MVPN Routing and Forwarding instance
- Configuring a VRF entry
- Configuring the route distinguisher
- Configuring VPN Id
- Configuring the Route-Target extended community
- Configuring the default MDT
- Configuring Data MDTs (optional)
- Configuring BGP MDT address family
- Configuring BGP vpv4 address family
- Configuring BGP VRF address family
- Configuring PIM SM/SSM mode for the VRFs



---

**Note** See [Configuring the MDT Address Family in BGP for Multicast VPN](#) for information on configuring an MDT and vpv4 address family session on the PE routers to establish MDT peering sessions for MVPN.

---

### SUMMARY STEPS

1. **enable**
2. **configure terminal**
3. **mpls MLDP**
4. vrf definition vrf-name
5. rd route-distinguisher
6. vpn id vpn-id
7. route-target import route-target-ext-community
8. **route-target export** *route-target-ext-community*
9. **mdt default mpls MLDP** *root-node*
10. mdt data mpls MLDP numberofdataMDTs
11. mdt data threshold bandwidth
12. exit
13. ip multicast-routing vrf vrf-name distributed
14. end

## DETAILED STEPS

|               | Command or Action                                                                                                                   | Purpose                                                                                                                                                                                                                                                                                                                                                                                                                              |
|---------------|-------------------------------------------------------------------------------------------------------------------------------------|--------------------------------------------------------------------------------------------------------------------------------------------------------------------------------------------------------------------------------------------------------------------------------------------------------------------------------------------------------------------------------------------------------------------------------------|
| <b>Step 1</b> | <b>enable</b><br><b>Example:</b><br><pre>Router&gt; enable</pre>                                                                    | Enables privileged EXEC mode. <ul style="list-style-type: none"> <li>• Enter your password when prompted.</li> </ul>                                                                                                                                                                                                                                                                                                                 |
| <b>Step 2</b> | <b>configure terminal</b><br><b>Example:</b><br><pre>Router# configure terminal</pre>                                               | Enters global configuration mode.                                                                                                                                                                                                                                                                                                                                                                                                    |
| <b>Step 3</b> | <b>mpls MLDP</b><br><b>Example:</b><br><pre>Router(config)# mpls MLDP</pre>                                                         | Enables MPLS MLDP support.<br><b>Note</b> The mpls MLDP command is configured by default. To disable MPLS MLDP, use the no mpls MLDP command.                                                                                                                                                                                                                                                                                        |
| <b>Step 4</b> | <b>vrf definition vrf-name</b><br><b>Example:</b><br><pre>Router(config)# ip vrf blue</pre>                                         | Defines the VPN routing instance by assigning a VRF name, and enters the VRF configuration mode.<br>The vrf-name argument is the name assigned to a VRF.                                                                                                                                                                                                                                                                             |
| <b>Step 5</b> | <b>rd route-distinguisher</b><br><b>Example:</b><br><pre>Router(config-vrf)# rd 10:3</pre>                                          | Creates routing and forwarding tables. Specify the <i>route-distinguisher</i> argument to add an 8-byte value to create a VPN prefix.<br>You can enter an <i>route-distinguisher</i> value in either of these formats: <ul style="list-style-type: none"> <li>• 16-bit autonomous system number: Your 16-bit number. For example, 101:3.</li> <li>• 32-bit IP address: Your 32-bit number. For example, 192.168.122.15:1.</li> </ul> |
| <b>Step 6</b> | <b>vpn id vpn-id</b><br><b>Example:</b><br><pre>Router(config-vrf)# vpn id 10:3</pre>                                               | Sets or updates a VPN identifier on a VRF.                                                                                                                                                                                                                                                                                                                                                                                           |
| <b>Step 7</b> | <b>route-target import route-target-ext-community</b><br><b>Example:</b><br><pre>Router(config-vrf)# route-target import 10:3</pre> | Creates a route-target extended community for a VRF. <ul style="list-style-type: none"> <li>• The import keyword imports the routing information from the target VPN extended community.</li> <li>• The route-target-ext-community argument adds the route-target extended community attributes to the VRF list of import, export, or both (import and export) route-target extended communities.</li> </ul>                         |

|                | Command or Action                                                                                                                               | Purpose                                                                                                                                                                                                                                                                                                                                                                                                                                                                                                                                                                                                                                                                              |
|----------------|-------------------------------------------------------------------------------------------------------------------------------------------------|--------------------------------------------------------------------------------------------------------------------------------------------------------------------------------------------------------------------------------------------------------------------------------------------------------------------------------------------------------------------------------------------------------------------------------------------------------------------------------------------------------------------------------------------------------------------------------------------------------------------------------------------------------------------------------------|
| <b>Step 8</b>  | <b>route-target export</b> <i>route-target-ext-community</i><br><b>Example:</b><br><pre>Router(config-vrf)# route-target export 10:3</pre>      | Creates a route-target extended community for a VRF. <ul style="list-style-type: none"> <li>• The export keyword exports the routing information from the target VPN extended community.</li> <li>• The route-target-ext-community argument adds the route-target extended community attributes to the VRF list of import, export, or both (import and export) route-target extended communities.</li> </ul>                                                                                                                                                                                                                                                                         |
| <b>Step 9</b>  | <b>mdt default mpls MLDP</b> <i>root-node</i><br><b>Example:</b><br><pre>Router(config-vrf)# mdt default mpls MLDP 192.0.2.2</pre>              | Configures MLDP MDT for a VRF. The root node can be IP address of a loopback or physical interface on any router (source PE, receiver PE or core router) in the provider network. The root node address should be reachable by all the routers in the network. The router from where the signalling occurs functions as the root node.<br><br>The default MDT must be configured on each PE router to enable the PE routers to receive multicast traffic for this particular MVRF.<br><br><b>Note</b> By default MPLS MLDP is enabled. To disable, use the no mpls MLDP command.<br><br><b>Note</b> LSPVIF tunnel is created as a result of mdt default mpls MLDP root-node command. |
| <b>Step 10</b> | <b>mdt data mpls MLDP numberofdataMDTs</b><br><b>Example:</b><br><pre>Router(config-vrf)# mdt data mpls MLDP 100</pre>                          | Configures the MLDP data MDP.                                                                                                                                                                                                                                                                                                                                                                                                                                                                                                                                                                                                                                                        |
| <b>Step 11</b> | <b>mdt data threshold bandwidth</b><br><b>Example:</b><br><pre>Router(config-vrf)# mdt data threshold 20</pre>                                  | Configures the threshold value for data MDT.<br><br><b>Note</b> Bandwidth is traffic rate in Kb/s.                                                                                                                                                                                                                                                                                                                                                                                                                                                                                                                                                                                   |
| <b>Step 12</b> | <b>exit</b><br><b>Example:</b><br><pre>Router(config-vrf)# exit</pre>                                                                           | Exits the configuration session.                                                                                                                                                                                                                                                                                                                                                                                                                                                                                                                                                                                                                                                     |
| <b>Step 13</b> | <b>ip multicast-routing vrf vrf-name distributed</b><br><b>Example:</b><br><pre>Router(config)# ip multicast-routing vrf blue distributed</pre> | Enables multicast routing for the specified VRF.                                                                                                                                                                                                                                                                                                                                                                                                                                                                                                                                                                                                                                     |
| <b>Step 14</b> | <b>end</b><br><b>Example:</b>                                                                                                                   | Closes the configuration session.                                                                                                                                                                                                                                                                                                                                                                                                                                                                                                                                                                                                                                                    |

## Example

| Command or Action   | Purpose |
|---------------------|---------|
| Router(config)# end |         |

## What to do next



**Note** See [Configuring the MDT Address Family in BGP for Multicast VPN](#) for information on configuring an MDT address family session on the PE routers to establish MDT peering sessions for MVPN.

## Example

This example describes how to configure MLDP MVPN on an intranet:

```
Router> enable
Router# configure terminal
Router(config)# mpls MLDP
Router(config)# ip vrf blue
Router(config-vrf)# rd 10:3
Router(config-vrf)# vpn id 10:3
Router(config-vrf)# route-target import 10:3
Router(config-vrf)# route-target export 10:3
Router(config-vrf)# mdt default mpls MLDP 192.0.2.2
Router(config-vrf)# mdt data mpls MLDP 100
Router(config-vrf)# mdt data threshold 20
Router(config-vrf)# exit
Router(config)# ip multicast-routing vrf blue distributed
Router(config)# end
```

## Verification

Use these commands to verify the LSM-MLDP-based MVPN support intranet configuration.

- To check the MLDP neighbors, use the show mpls MLDP neighbors command:

```
Router# show mpls MLDP neighbors
MLDP peer ID : 192.0.2.3:0, uptime 00:41:41 Up,
 Target Adj : Yes
 Session hndl : 2
 Upstream count : 2
 Branch count : 0
 Path count : 1
 Path(s) : 192.0.2.3 No LDP Tunnel120
 Nhop count : 1
 Nhop list : 192.0.2.3
MLDP peer ID : 192.0.2.2:0, uptime 00:17:42 Up,
 Target Adj : No
 Session hndl : 4
 Upstream count : 0
 Branch count : 0
 Path count : 1
 Path(s) : 192.0.2.3 No LDP Tunnel120
 Nhop count : 0
```

- To check the PIM neighbors, use the `show ip pim vrf vrf-name neighbor` command:

```
Router# show ip pim vrf blue neighbor
PIM Neighbor Table
Mode: B - Bidir Capable, DR - Designated Router, N - Default DR Priority,
 P - Proxy Capable, S - State Refresh Capable, G - GenID Capable
Neighbor Interface Uptime/Expires Ver DR
Address
192.0.2.3 Lspvif1 00:06:21/00:01:17 v2 1 / DR S P G
```

- To check the multicast routes for a given VRF, use `show ip mroute vrf vrf_name verbose` command:

```
Router# show ip mroute vrf blue verbose
IP Multicast Routing Table
Flags: D - Dense, S - Sparse, B - Bidir Group, s - SSM Group, C - Connected,
 L - Local, P - Pruned, R - RP-bit set, F - Register flag,
 T - SPT-bit set, J - Join SPT, M - MSDP created entry, E - Extranet,
 X - Proxy Join Timer Running, A - Candidate for MSDP Advertisement,
 U - URD, I - Received Source Specific Host Report,
 Z - Multicast Tunnel, z - MDT-data group sender,
 Y - Joined MDT-data group, y - Sending to MDT-data group,
 V - RD & Vector, v - Vector
Outgoing interface flags: H - Hardware switched, A - Assert winner
Timers: Uptime/Expires
Interface state: Interface, Next-Hop or VCD, State/Mode
(40.0.0.2, 232.0.1.4), 00:00:16/00:03:13, flags: sT
 Incoming interface: GigabitEthernet3/2/1, RPF nbr 0.0.0.0
 Outgoing interface list:
 Lspvif1, LSM MDT: B0000004 (default), Forward/Sparse, 00:00:16/00:03:13
(*, 224.0.1.40), 00:47:09/00:02:56, RP 0.0.0.0, flags: DPL
 Incoming interface: Null, RPF nbr 0.0.0.0
 Outgoing interface list: Null
```

- To check the packet counters, use `show ip mroute vrf vrf_name count` command:

```
Router# show ip mroute vrf blue count
IP Multicast Statistics
2 routes using 1208 bytes of memory
2 groups, 0.50 average sources per group
Forwarding Counts: Pkt Count/Pkts per second/Avg Pkt Size/Kilobits per second
Other counts: Total/RPF failed/Other drops(OIF-null, rate-limit etc)
Group: 232.0.1.4, Source count: 1, Packets forwarded: 1333, Packets received: 1334
 Source: 40.0.0.2/32, Forwarding: 1333/20/46/7, Other: 1334/0/1
Group: 224.0.1.40, Source count: 0, Packets forwarded: 0, Packets received: 0
```

- To check the MPLS forwarding, use `show mpls forwarding-table` command:

```
Router# show mpls forwarding-table
Local Outgoing Prefix Bytes Label Outgoing Next Hop
Label Label or Tunnel Id Switched interface
16 Pop Label IPv4 VRF[V] 0 aggregate/blue
17 Pop Label IPv4 VRF[V] 0 aggregate/red
18 [T] Pop Label 192.0.2.3/32 0 Tu20 point2point
19 [T] 25 192.0.2.2/32 0 Tu20 point2point
20 [T] Pop Label 19.0.0.0/24 0 Tu20 point2point
22 [T] No Label [mdt 55:1111 0][V] \9422 aggregate/red
23 [T] No Label [mdt 55:2222 0][V] \9708 aggregate/blue
[T] Forwarding through a LSP tunnel.
View additional labelling info with the 'detail' option
```

## Configuring MLDP MVPN for Extranet Services

You can configure MLDP MVPN for extranet services using these methods:

- Source-Side Chaining (SSC): Configure the phantom receiver MVRF on the source-side router. Multicast routes with VRF Reverse Path Forwarding (RPF) loopup should be configured on the source PE.
- Receiver-Side Chaining (RSC): Configure the phantom source MVRF on the receiver-side router. Multicast routes with VRF RPF loopup should be configured on the receiver VRF.

### Configuring MLDP MVPN for Extranet using SSC

Complete these steps to configure the MLDP MVPN extranet support using SSC:

- Configuring receiver MVRF on the source PE.
- Configuring a loopback address in the receiver VRF on the source PE.
- Configuring fallback multicast route for source address on source PE.
- Configuring fallback multicast route for RP address on the source PE in case of SM mode.
- Configuring static multicast route on receiver PE for loopback IP in the receiver VRF configured on the source PE.



**Note** This configuration is based on the following figure. Configure multicast routes on the PE1 router.

Figure 18: MLDP Based MVPN Network

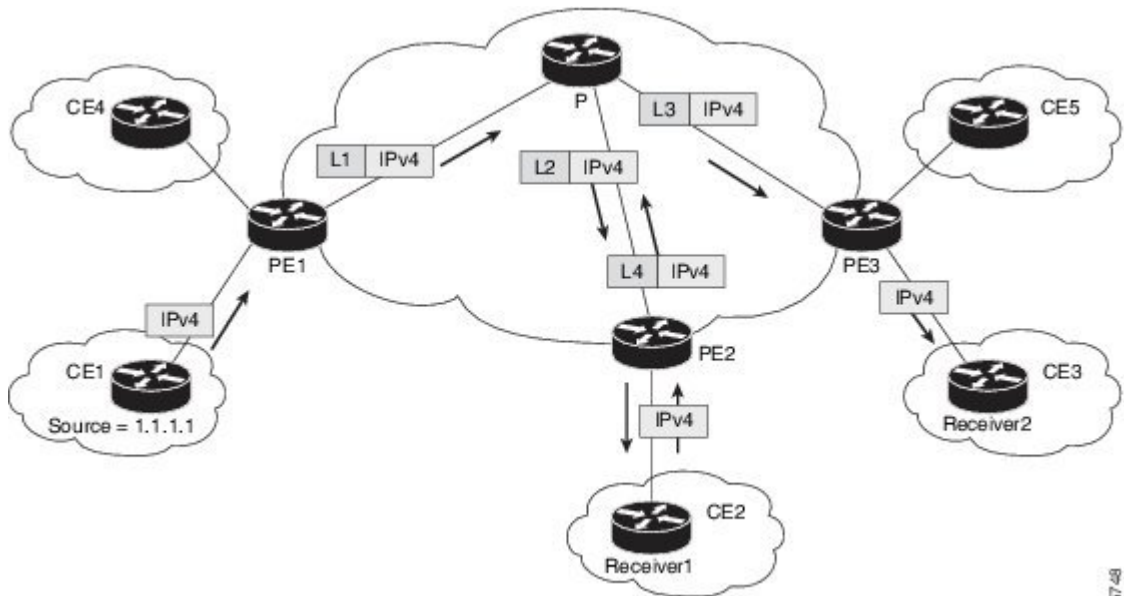

The followings are the detailed steps to configure MLDP MVPN for Extranet using SSC.

{start blocklabel}Configuration on the Source PE: {end blocklabel}



## SUMMARY STEPS

1. **enable**
2. **configure terminal**
3. vrf definition vrf-name
4. rd route-distinguisher
5. vpn id vpn-id
6. route-target import route-target-ext-community
7. route-target export route-target-ext-community
8. mdt default mpls MLDP root-node
9. end
10. interface type instance
11. ip vrf forwarding vrf-name
12. ip address ip-address subnet-mask
13. exit
14. ip multicast [vrf receiver-vrf-name] rpf select {global | vrf source-vrf-name} group-list access-list
15. end

## DETAILED STEPS

|               | Command or Action                                                                 | Purpose                                                                                                                                                                                                                                                                                                                                                                                                                                  |
|---------------|-----------------------------------------------------------------------------------|------------------------------------------------------------------------------------------------------------------------------------------------------------------------------------------------------------------------------------------------------------------------------------------------------------------------------------------------------------------------------------------------------------------------------------------|
| <b>Step 1</b> | <b>enable</b><br><b>Example:</b><br>Router> enable                                | Enables privileged EXEC mode. <ul style="list-style-type: none"> <li>• Enter your password when prompted.</li> </ul>                                                                                                                                                                                                                                                                                                                     |
| <b>Step 2</b> | <b>configure terminal</b><br><b>Example:</b><br>Router# configure terminal        | Enters global configuration mode.                                                                                                                                                                                                                                                                                                                                                                                                        |
| <b>Step 3</b> | vrf definition vrf-name<br><b>Example:</b><br>Router(config)# vrf definition blue | Defines the VPN routing instance by assigning a VRF name argument, and enters the VRF configuration mode. The vrf-name argument is the name assigned to a VRF.                                                                                                                                                                                                                                                                           |
| <b>Step 4</b> | rd route-distinguisher<br><b>Example:</b><br>Router(config-if)# rd 10:4           | Creates routing and forwarding tables. Specify the <i>route-distinguisher</i> argument to add an 8-byte value to create a VPN prefix. <p>You can enter an <i>route-distinguisher</i> value in either of these formats:</p> <ul style="list-style-type: none"> <li>• 16-bit autonomous system number: Your 16-bit number. For example, 101:3.</li> <li>• 32-bit IP address: Your 32-bit number. For example, 192.168.122.15:1.</li> </ul> |

|                | Command or Action                                                                                                            | Purpose                                                                                                                                                                                                                                                                                                                                                                                                      |
|----------------|------------------------------------------------------------------------------------------------------------------------------|--------------------------------------------------------------------------------------------------------------------------------------------------------------------------------------------------------------------------------------------------------------------------------------------------------------------------------------------------------------------------------------------------------------|
| <b>Step 5</b>  | vpn id vpn-id<br><b>Example:</b><br><pre>Router(config-if)# vpn id 10:4</pre>                                                | Sets or updates a VPN identifier on a VRF.                                                                                                                                                                                                                                                                                                                                                                   |
| <b>Step 6</b>  | route-target import route-target-ext-community<br><b>Example:</b><br><pre>Router(config-vrf)# route-target import 10:4</pre> | Creates a route-target extended community for a VRF. <ul style="list-style-type: none"> <li>• The import keyword imports the routing information from the target VPN extended community.</li> <li>• The route-target-ext-community argument adds the route-target extended community attributes to the VRF list of import, export, or both (import and export) route-target extended communities.</li> </ul> |
| <b>Step 7</b>  | route-target export route-target-ext-community<br><b>Example:</b><br><pre>Router(config-vrf)# route-target export 10:4</pre> | Creates a route-target extended community for a VRF. <ul style="list-style-type: none"> <li>• The export keyword export the routing information to the target VPN extended community.</li> <li>• The route-target-ext-community argument adds the route-target extended community attributes to the VRF list of import, export, or both (import and export) route-target extended communities.</li> </ul>    |
| <b>Step 8</b>  | mdt default mpls MLDP root-node<br><b>Example:</b><br><pre>Router(config-vrf)# mdt default mpls MLDP 192.0.2.2</pre>         | Configures MLDP multicast distribution tree (MDT) for a VRF.<br><b>Note</b> LSPVIF tunnel is created as a result of this command.                                                                                                                                                                                                                                                                            |
| <b>Step 9</b>  | end<br><b>Example:</b><br><pre>Router(config-vrf)# end</pre>                                                                 | Closes the configuration session.                                                                                                                                                                                                                                                                                                                                                                            |
| <b>Step 10</b> | interface type instance<br><b>Example:</b><br><pre>Router(config)# interface loopback 3</pre>                                | Enters interface configuration mode and names the new loopback interface.                                                                                                                                                                                                                                                                                                                                    |
| <b>Step 11</b> | ip vrf forwarding vrf-name<br><b>Example:</b><br><pre>Router(config-if)# ip vrf forwarding red</pre>                         | Associates a VRF instance with an interface or subinterface. <ul style="list-style-type: none"> <li>• vrf-name is the name assigned to a VRF.</li> </ul>                                                                                                                                                                                                                                                     |
| <b>Step 12</b> | ip address ip-address subnet-mask<br><b>Example:</b>                                                                         | Specifies the interface IP address and subnet mask. <ul style="list-style-type: none"> <li>• ip-address specifies the IP address of the interface.</li> </ul>                                                                                                                                                                                                                                                |

|                | Command or Action                                                                                                                                                                                  | Purpose                                                                                                                                                                                                                                                                                                                                                                                                                                                                                                                                                                                                                                                                         |
|----------------|----------------------------------------------------------------------------------------------------------------------------------------------------------------------------------------------------|---------------------------------------------------------------------------------------------------------------------------------------------------------------------------------------------------------------------------------------------------------------------------------------------------------------------------------------------------------------------------------------------------------------------------------------------------------------------------------------------------------------------------------------------------------------------------------------------------------------------------------------------------------------------------------|
|                | Router(config-if)# ip address 192.0.2.1<br>255.255.255.255                                                                                                                                         | <ul style="list-style-type: none"> <li>subnet-mask specifies the subnet mask of the interface.</li> </ul>                                                                                                                                                                                                                                                                                                                                                                                                                                                                                                                                                                       |
| <b>Step 13</b> | exit                                                                                                                                                                                               | Exits the interface configuration mode.                                                                                                                                                                                                                                                                                                                                                                                                                                                                                                                                                                                                                                         |
| <b>Step 14</b> | ip multicast [vrf receiver-vrf-name] rpf select {global   vrf<br>source-vrf-name} group-list access-list<br><br><b>Example:</b><br><br>Router(config)# ip multicast vrf red rpf select<br>vrf blue | Configures Reverse Path Forwarding (RPF) lookups originating in a receiver Multicast VPN (MVPN) routing and forwarding (MVRF) instance, in the global routing table to be performed in a source MVRF instance, or in the global routing table based on group address.<br><br>The optional vrf keyword and <i>receiver-vrf-name</i> argument are used to apply a group-based VRF selection policy to RPF lookups originating in the VRF specified for the <i>receiver-vrf-name</i> argument. If the optional vrf keyword and <i>receiver-vrf-name</i> argument are not specified, the group-based VRF selection policy applies to RPF lookups originating from the global table. |
| <b>Step 15</b> | end<br><br><b>Example:</b><br><br>Router(config-vrf)# end                                                                                                                                          | Closes the configuration session.                                                                                                                                                                                                                                                                                                                                                                                                                                                                                                                                                                                                                                               |

## Configuring MLDP MVPN for Extranet using SSC

{start blocklabel} Configuration on Receiver PE: {end blocklabel}

### SUMMARY STEPS

1. **enable**
2. **configure terminal**
3. vrf definition vrf-name
4. rd route-distinguisher
5. vpn id vpn-id
6. route-target import route-target-ext-community
7. route-target export route-target-ext-community
8. mdt default mpls MLDP root-node
9. end
10. interface type instance
11. ip vrf forwarding vrf-name
12. ip address ip-address subnet-mask
13. exit
14. ip mroute vrf receiver\_vrf source\_address subnet\_mask loopback\_ip
15. end

## DETAILED STEPS

|               | Command or Action                                                                                                                   | Purpose                                                                                                                                                                                                                                                                                                                                                                                                       |
|---------------|-------------------------------------------------------------------------------------------------------------------------------------|---------------------------------------------------------------------------------------------------------------------------------------------------------------------------------------------------------------------------------------------------------------------------------------------------------------------------------------------------------------------------------------------------------------|
| <b>Step 1</b> | <b>enable</b><br><b>Example:</b><br><pre>Router&gt; enable</pre>                                                                    | Enables privileged EXEC mode. <ul style="list-style-type: none"> <li>• Enter your password when prompted.</li> </ul>                                                                                                                                                                                                                                                                                          |
| <b>Step 2</b> | <b>configure terminal</b><br><b>Example:</b><br><pre>Router# configure terminal</pre>                                               | Enters global configuration mode.                                                                                                                                                                                                                                                                                                                                                                             |
| <b>Step 3</b> | vrf definition vrf-name<br><b>Example:</b><br><pre>Router(config)# vrf definition blue</pre>                                        | Defines the VPN routing instance by assigning a VRF name, and enters the VRF configuration mode.<br><br>The vrf-name argument is the name assigned to a VRF.                                                                                                                                                                                                                                                  |
| <b>Step 4</b> | <b>rd route-distinguisher</b><br><b>Example:</b><br><pre>Router(config-if)# rd 10:4</pre>                                           | Creates routing and forwarding tables. Specify the <i>route-distinguisher</i> argument to add an 8-byte value to create a VPN prefix. You can enter an RD value in either of these formats: <ul style="list-style-type: none"> <li>• 16-bit autonomous system number: Your 16-bit number. For example, 101:3.</li> <li>• 32-bit IP address: Your 32-bit IP address. For example, 192.168.122.15:1.</li> </ul> |
| <b>Step 5</b> | <b>vpn id vpn-id</b><br><b>Example:</b><br><pre>Router(config-if)# vpn id 10:4</pre>                                                | Sets or updates a VPN identifier on a VRF.                                                                                                                                                                                                                                                                                                                                                                    |
| <b>Step 6</b> | <b>route-target import route-target-ext-community</b><br><b>Example:</b><br><pre>Router(config-vrf)# route-target import 10:4</pre> | Creates a route-target extended community for a VRF. <ul style="list-style-type: none"> <li>• The import keyword imports the routing information from the target VPN extended community.</li> <li>• The route-target-ext-community argument adds the route-target extended community attributes to the VRF list of import, export, or both (import and export) route-target extended communities.</li> </ul>  |
| <b>Step 7</b> | <b>route-target export route-target-ext-community</b><br><b>Example:</b><br><pre>Router(config-vrf)# route-target export 10:4</pre> | Creates a route-target extended community for a VRF. <ul style="list-style-type: none"> <li>• The export keyword exports the routing information to the target VPN extended community.</li> <li>• The route-target-ext-community argument adds the route-target extended community attributes to the</li> </ul>                                                                                               |

|                | Command or Action                                                                                                                                                        | Purpose                                                                                                                                                                                                                      |
|----------------|--------------------------------------------------------------------------------------------------------------------------------------------------------------------------|------------------------------------------------------------------------------------------------------------------------------------------------------------------------------------------------------------------------------|
|                |                                                                                                                                                                          | VRF list of import, export, or both (import and export) route-target extended communities.                                                                                                                                   |
| <b>Step 8</b>  | mdt default mpls MLDP root-node<br><b>Example:</b><br><pre>Router(config-vrf)# mdt default mpls MLDP 192.0.2.2</pre>                                                     | Configures MLDP multicast distribution tree (MDT) for a VRF.<br><b>Note</b> LSPVIF tunnel is created as a result of this command.                                                                                            |
| <b>Step 9</b>  | end<br><b>Example:</b><br><pre>Router(config-vrf)# end</pre>                                                                                                             | Closes the configuration session.                                                                                                                                                                                            |
| <b>Step 10</b> | interface type instance<br><b>Example:</b><br><pre>Router(config)# interface loopback 3</pre>                                                                            | Enters interface configuration mode and names the new loopback interface.                                                                                                                                                    |
| <b>Step 11</b> | ip vrf forwarding vrf-name<br><b>Example:</b><br><pre>Router(config-if)# ip vrf forwarding blue</pre>                                                                    | Associates a VRF instance with an interface or subinterface. <ul style="list-style-type: none"> <li>vrf-name is the name assigned to a VRF.</li> </ul>                                                                       |
| <b>Step 12</b> | ip address ip-address subnet-mask<br><b>Example:</b><br><pre>Router(config-if)# ip address 192.0.2.3 255.255.255.255</pre>                                               | Specifies the interface IP address and subnet mask. <ul style="list-style-type: none"> <li>ip-address specifies the IP address of the interface.</li> <li>subnet-mask specifies the subnet mask of the interface.</li> </ul> |
| <b>Step 13</b> | exit                                                                                                                                                                     | Exits the interface configuration mode.                                                                                                                                                                                      |
| <b>Step 14</b> | ip mroute vrf receiver_vrf source_address subnet_mask loopback_ip<br><b>Example:</b><br><pre>Router(config-if)# ip mroute vrf red 40.0.0.0 255.255.255.0 192.0.2.1</pre> | Configures the static multicast routes for source addresses in the receiver VRF, where:<br>loopback ip is ip address of the loopback configured in the receiver VRF in the source PE.                                        |
| <b>Step 15</b> | end<br><b>Example:</b><br><pre>Router(config-vrf)# end</pre>                                                                                                             | Closes the configuration session.                                                                                                                                                                                            |

## Example

This is sample example for configuring MLDP MVPN for configuring extranet using SSC:

{start blocklabel} Configuration on the Source PE (Configure These Steps for Both Red and Blue VRFs) {end blocklabel}

```
Router> enable
Router# configure terminal
Router(config)# ip vrf blue
Router(config-if)# rd 10:4
Router(config-if)# vpn id 10:4
Router(config-vrf)# route-target import 10:4
Router(config-vrf)# route-target export 10:4
Router(config-vrf)# mdt default mpls MLDP 192.0.2.2
Router(config-vrf)# end
Router(config)# interface loopback 3
Router(config-if)# ip vrf forwarding red
Router(config-if)# ip address 192.0.2.1 255.255.255.255
Router(config)# ip mroute vrf red 40.0.0.0 255.255.255.0 fallback-lookup vrf blue
Router(config)# ip mroute vrf red 44.44.44.44 255.255.255.0 fallback-lookup vrf blue
Router(config-vrf)# end
```

{start blocklabel} Configuration on the Receiver PE {end blocklabel}

```
Router> enable
Router# configure terminal
Router(config)# ip vrf blue
Router(config-if)# rd 10:4
Router(config-if)# vpn id 10:4
Router(config-vrf)# route-target import 10:4
Router(config-vrf)# route-target export 10:4
Router(config-vrf)# mdt default mpls MLDP 192.0.2.2
Router(config-vrf)# end
Router(config)# interface loopback 3
Router(config-if)# ip vrf forwarding blue
Router(config-if)# ip address 192.0.2.3 255.255.255.255 Remove
Router(config-if)# ip mroute vrf red 40.0.0.0 255.255.255.0 192.0.2.1
Router(config-vrf)# end
```

## Configuring MLDP MVPN for Extranet Services using RSC

Complete these steps to configuring MLDP MVPN for extranet services using RSC:

- Configuring the source mVRF on the receiver PE router.
- Configuring RPF for MLDP based MVPN extranet support using static multicast routes on the receiver PE.



---

**Note** Configure multicast routes on PE2 and PE3 routers.

---

{start blocklabel} Configuration on Source PE {end blocklabel}

### SUMMARY STEPS

1. **enable**
2. **configure terminal**
3. vrf definition vrf-name
4. rd route-distinguisher

5. `vpn id vpn-id`
6. `route-target import route-target-ext-community`
7. `route-target export route-target-ext-community`
8. `mdt default mpls MLDP root-node`
9. `end`

## DETAILED STEPS

|               | Command or Action                                                                                                                           | Purpose                                                                                                                                                                                                                                                                                                                                                                                                          |
|---------------|---------------------------------------------------------------------------------------------------------------------------------------------|------------------------------------------------------------------------------------------------------------------------------------------------------------------------------------------------------------------------------------------------------------------------------------------------------------------------------------------------------------------------------------------------------------------|
| <b>Step 1</b> | <p><b>enable</b></p> <p><b>Example:</b></p> <pre>Router&gt; enable</pre>                                                                    | <p>Enables privileged EXEC mode.</p> <ul style="list-style-type: none"> <li>• Enter your password when prompted.</li> </ul>                                                                                                                                                                                                                                                                                      |
| <b>Step 2</b> | <p><b>configure terminal</b></p> <p><b>Example:</b></p> <pre>Router# configure terminal</pre>                                               | <p>Enters global configuration mode.</p>                                                                                                                                                                                                                                                                                                                                                                         |
| <b>Step 3</b> | <p><b>vrf definition vrf-name</b></p> <p><b>Example:</b></p> <pre>Router(config)# ip vrf blue</pre>                                         | <p>Defines the VPN routing instance by assigning a VRF name, and enters the VRF configuration mode.</p> <p>The <i>vrf-name</i> argument is the name assigned to a VRF.</p>                                                                                                                                                                                                                                       |
| <b>Step 4</b> | <p><b>rd route-distinguisher</b></p> <p><b>Example:</b></p> <pre>Router(config-if)# rd 10:3</pre>                                           | <p>Creates routing and forwarding tables. Specify the <i>route-distinguisher</i> argument to add an 8-byte value to create a VPN prefix. You can enter an RD value in either of these formats:</p> <ul style="list-style-type: none"> <li>• 16-bit autonomous system number: Your 16-bit number. For example, 101:3.</li> <li>• 32-bit IP address: Your 32-bit number. For example, 192.168.122.15:1.</li> </ul> |
| <b>Step 5</b> | <p><b>vpn id vpn-id</b></p> <p><b>Example:</b></p> <pre>Router(config-if)# vpn id 10:3</pre>                                                | <p>Sets or updates a VPN identifier on a VRF.</p>                                                                                                                                                                                                                                                                                                                                                                |
| <b>Step 6</b> | <p><b>route-target import route-target-ext-community</b></p> <p><b>Example:</b></p> <pre>Router(config-vrf)# route-target import 10:3</pre> | <p>Creates a route-target extended community for a VRF.</p> <ul style="list-style-type: none"> <li>• The import keyword imports routing information from the target VPN extended community.</li> <li>• The route-target-ext-community argument adds the route-target extended community attributes to the VRF list of import, export, or both (import and export) route-target extended communities.</li> </ul>  |

|               | Command or Action                                                                                                            | Purpose                                                                                                                                                                                                                                                                                                                                                                                                    |
|---------------|------------------------------------------------------------------------------------------------------------------------------|------------------------------------------------------------------------------------------------------------------------------------------------------------------------------------------------------------------------------------------------------------------------------------------------------------------------------------------------------------------------------------------------------------|
| <b>Step 7</b> | route-target export route-target-ext-community<br><b>Example:</b><br><pre>Router(config-vrf)# route-target export 10:3</pre> | Creates a route-target extended community for a VRF. <ul style="list-style-type: none"> <li>• The export keyword exports the routing information to the target VPN extended community.</li> <li>• The route-target-ext-community argument adds the route-target extended community attributes to the VRF list of import, export, or both (import and export) route-target extended communities.</li> </ul> |
| <b>Step 8</b> | mdt default mpls MLDP root-node<br><b>Example:</b><br><pre>Router(config-vrf)# mdt default mpls MLDP 192.0.2.2</pre>         | Configures MLDP multicast distribution tree (MDT) for a VRF.<br><b>Note</b> LSPVIF tunnel is created as a result of this command.                                                                                                                                                                                                                                                                          |
| <b>Step 9</b> | end<br><b>Example:</b><br><pre>Router(config-vrf)# end</pre>                                                                 | Closes the configuration session.                                                                                                                                                                                                                                                                                                                                                                          |

## Configuring MLDP MVPN for Extranet Services using RSC

{start blocklabel} Configuration on Receiver PE {end blocklabel}

### SUMMARY STEPS

1. enable
2. configure terminal
3. vrf definition vrf-name
4. rd route-distinguisher
5. vpn id vpn-id
6. route-target import route-target-ext-community
7. route-target export route-target-ext-community
8. mdt default mpls MLDP root-node
9. ip mroute [vrf receiver-vrf-name] source-address mask {fallback-lookup vrf source-vrf-name} [distance]
10. end

### DETAILED STEPS

|               | Command or Action                                         | Purpose                                                                                                              |
|---------------|-----------------------------------------------------------|----------------------------------------------------------------------------------------------------------------------|
| <b>Step 1</b> | enable<br><b>Example:</b><br><pre>Router&gt; enable</pre> | Enables privileged EXEC mode. <ul style="list-style-type: none"> <li>• Enter your password when prompted.</li> </ul> |
| <b>Step 2</b> | configure terminal<br><b>Example:</b>                     | Enters global configuration mode.                                                                                    |



|               | Command or Action                                                                                                 | Purpose                                                                                                                                                                                                                                                                                                                                                                                                    |
|---------------|-------------------------------------------------------------------------------------------------------------------|------------------------------------------------------------------------------------------------------------------------------------------------------------------------------------------------------------------------------------------------------------------------------------------------------------------------------------------------------------------------------------------------------------|
|               | Router# configure terminal                                                                                        |                                                                                                                                                                                                                                                                                                                                                                                                            |
| <b>Step 3</b> | vrf definition vrf-name<br><b>Example:</b><br>Router(config)# ip vrf blue                                         | Defines the VPN routing instance by assigning a VRF name, and enters the VRF configuration mode.<br><br>The <i>vrf-name</i> argument is the name assigned to a VRF.                                                                                                                                                                                                                                        |
| <b>Step 4</b> | rd route-distinguisher<br><b>Example:</b><br>Router(config-if)# rd 10:3                                           | Creates routing and forwarding tables. Specify the <i>route-distinguisher</i> argument to add an 8-byte value to create a VPN prefix. You can enter an RD value in either of these formats: <ul style="list-style-type: none"> <li>• 16-bit autonomous system number: Your 16-bit number. For example, 101:3.</li> <li>• 32-bit IP address: Your 32-bit number. For example, 192.168.122.15:1.</li> </ul>  |
| <b>Step 5</b> | vpn id vpn-id<br><b>Example:</b><br>Router(config-if)# vpn id 10:3                                                | Sets or updates a VPN identifier on a VRF.                                                                                                                                                                                                                                                                                                                                                                 |
| <b>Step 6</b> | route-target import route-target-ext-community<br><b>Example:</b><br>Router(config-vrf)# route-target import 10:3 | Creates a route-target extended community for a VRF. <ul style="list-style-type: none"> <li>• The import keyword imports routing information from the target VPN extended community.</li> <li>• The route-target-ext-community argument adds the route-target extended community attributes to the VRF list of import, export, or both (import and export) route-target extended communities.</li> </ul>   |
| <b>Step 7</b> | route-target export route-target-ext-community<br><b>Example:</b><br>Router(config-vrf)# route-target export 10:3 | Creates a route-target extended community for a VRF. <ul style="list-style-type: none"> <li>• The export keyword exports the routing information to the target VPN extended community.</li> <li>• The route-target-ext-community argument adds the route-target extended community attributes to the VRF list of import, export, or both (import and export) route-target extended communities.</li> </ul> |
| <b>Step 8</b> | mdt default mpls MLDP root-node<br><b>Example:</b><br>Router(config-vrf)# mdt default mpls MLDP 192.0.2.2         | Configures MLDP multicast distribution tree (MDT) for a VRF.<br><br><b>Note</b> LSPVIF tunnel is created as a result of this command.                                                                                                                                                                                                                                                                      |
| <b>Step 9</b> | ip mroute [vrf receiver-vrf-name] source-address mask {fallback-lookup vrf source-vrf-name} [distance]            | Configures RPF lookups originating in a receiver MVRF or in the global routing table to be resolved in a source                                                                                                                                                                                                                                                                                            |

## Example

|                | Command or Action                                                                                                   | Purpose                                                                                                                                                                                                                                                                                                                                                                                                                                                                                                                               |
|----------------|---------------------------------------------------------------------------------------------------------------------|---------------------------------------------------------------------------------------------------------------------------------------------------------------------------------------------------------------------------------------------------------------------------------------------------------------------------------------------------------------------------------------------------------------------------------------------------------------------------------------------------------------------------------------|
|                | <p><b>Example:</b></p> <pre>Router(config)# ip mroute vrf red 40.0.0.0 255.255.255.0 fallback-lookup vrf blue</pre> | <p>MVRF or in the global routing table based on group address. Use this command on the receiver PE.</p> <ul style="list-style-type: none"> <li>The optional vrf keyword and receiver-vrf-name argument are used to apply a group-based VRF selection policy to RPF lookups originating in the VRF specified for the receiver-vrf-name argument. If the optional vrf keyword and receiver-vrf-name argument are not specified, the group-based VRF selection policy applies to RPF lookups originating in the global table.</li> </ul> |
| <b>Step 10</b> | <pre>end</pre> <p><b>Example:</b></p> <pre>Router(config-vrf)# end</pre>                                            | Closes the configuration session.                                                                                                                                                                                                                                                                                                                                                                                                                                                                                                     |

## Example

This is sample example for configuring MLDP MVPN for configuring extranet using RSC:

{start blocklabel} Configuration on Source PE: {end blocklabel}

```
Router# enable
Router# conf t
Enter configuration commands, one per line. End with CNTL/Z.
Router(config)# ip vrf blue1
Router(config-if)# rd 10:3
Router(config-if)# vpn id 10:3
Router(config-vrf)# route-target import 10:3
Router(config-vrf)# route-target export 10:3
Router(config-vrf)# mdt default mpls MLDP 192.0.2.2
mdt default mpls MLDP root-node
Router(config-if)# end
Router(config)# ip mroute vrf red 40.0.0.0 255.255.255.0 fallback-lookup vrf blue
Router(config-if)# end
```

{start blocklabel} Configuration on Receiver PE: {end blocklabel}

```
Router# enable
Router# conf t
Enter configuration commands, one per line. End with CNTL/Z.
Router(config)# ip vrf blue1
Router(config-if)# rd 10:3
Router(config-if)# vpn id 10:3
Router(config-vrf)# route-target import 10:3
Router(config-vrf)# route-target export 10:3
Router(config-vrf)# mdt default mpls MLDP 192.0.2.2
Router(config)# ip mroute vrf red 40.0.0.0 255.255.255.0 fallback-lookup vrf blue
Router(config-if)# end
```

## Configuring MLDP TE-FRR Support

TE-FRR provides link protection, however TE-FRR on MLDP provides link protection only for the single hop primary path. Node protection is not supported. These are the highlights:

- Backup tunnel support
- Backup bandwidth protection

### SUMMARY STEPS

1. **enable**
2. **configure terminal**
3. **ip multicast mpls traffic-eng** [range {access-list-number | access-list-name}]
4. **mpls MLDP path traffic-eng**
5. **end**

### DETAILED STEPS

|        | Command or Action                                                                                                                                        | Purpose                                                                                                              |
|--------|----------------------------------------------------------------------------------------------------------------------------------------------------------|----------------------------------------------------------------------------------------------------------------------|
| Step 1 | <b>enable</b><br><b>Example:</b><br>Router> enable                                                                                                       | Enables privileged EXEC mode. <ul style="list-style-type: none"> <li>• Enter your password when prompted.</li> </ul> |
| Step 2 | <b>configure terminal</b><br><b>Example:</b><br>Router# configure terminal                                                                               | Enters global configuration mode.                                                                                    |
| Step 3 | <b>ip multicast mpls traffic-eng</b> [range {access-list-number   access-list-name}]<br><b>Example:</b><br>Router(config)# ip multicast mpls traffic-eng | Enables IP multicast traffic on a tail end router enabled with MPLS TE P2MP functionality.                           |
| Step 4 | <b>mpls MLDP path traffic-eng</b><br><b>Example:</b><br>Router(config)# mpls MLDP path traffic-en                                                        | Configures MLDP to use traffic-eng tunnels.                                                                          |
| Step 5 | <b>end</b><br><b>Example:</b><br>Router(config)# end                                                                                                     | Closes the configuration session.                                                                                    |

## Configuring MLDP with PIM-based MVPN

MLDP with PIM-based MVPN supports MLDP coexistence with a PIM-based MVPN deployment. Using this feature, you can gradually introduce MLDP in an existing PIM-based MVPN environment, facilitating phased migration towards a complete LSM-based MVPN network infrastructure. If both the MLDP-based MVPN and GRE-based MVPN are configured, MDT selects PIM based MVPN by default. Configure the precedence for MLDP MVPN and PIM based MVPN using the **mdt preference option1 option2** command. This example sets MLDP MVPN precedence over PIM based MVPN:

```
Router(config-vrf)# mdt preference MLDP pim
```

## MLDP Support with Load Balancing

MLDP supports load balancing of multicast traffic with Equal Cost Multipath (ECMP) links. For Load balancing to work with MLDP, use the **disable mpls MLDP forwarding recursive** command, which is enabled by default. Also, ensure that the **mpls MLDP path multipath** command is enabled for load balancing to function as expected.

## Root Node Redundancy

Configure multiple root nodes in the network using the **mdt default mpls MLDP ip\_address** command. The control plane builds a corresponding tree with root at the configured node to enable efficient forwarding. A node in the network selects the nearest root for optimal bandwidth usage. Also, in case a root node is unreachable (due to link failure, or router crash), the node switches to the next available root.

This example describes the root node redundancy configuration:

```
Router(config)# ip vrf blue1
Router(config-if)# rd 10:3
Router(config-if)# vpn id 10:3
Router(config-vrf)# route-target import 10:3
Router(config-vrf)# route-target export 10:3
Router(config-vrf)# mdt default mpls MLDP 192.0.2.2
Router(config-vrf)# mdt default mpls MLDP 5.5.5.5
```

## Verification

Use these commands to verify the LSM-MLDP-based MVPN support configuration.

- To check the MLDP neighbors, use the **show mpls MLDP neighbors** command:

```
Router# show mpls MLDP neighbors
MLDP peer ID : 192.0.2.3:0, uptime 00:41:41 Up,
 Target Adj : Yes
 Session hndl : 2
 Upstream count : 2
 Branch count : 0
 Path count : 1
 Path(s) : 192.0.2.3 No LDP Tunnel20
 Nhop count : 1
 Nhop list : 192.0.2.3
MLDP peer ID : 192.0.2.2:0, uptime 00:17:42 Up,
 Target Adj : No
```

```

Session hndl : 4
Upstream count : 0
Branch count : 0
Path count : 1
Path(s) : 192.0.2.3 No LDP Tunnel20
Nhop count : 0

```

- To check the PIM neighbors, use the `show ip pim vrf vrf_name neighbor` command:

```

Router# show ip pim vrf blue neighbor
PIM Neighbor Table
Mode: B - Bidir Capable, DR - Designated Router, N - Default DR Priority,
 P - Proxy Capable, S - State Refresh Capable, G - GenID Capable
Neighbor Interface Uptime/Expires Ver DR
Address Prio/Mode
192.0.2.3 Lspvif1 00:06:21/00:01:17 v2 1 / DR S P G

```

- To check the multicast routes for a given VRF, use `show ip mroute vrf vrf_name verbose` command:

```

Router# show ip mroute vrf blue verbose
IP Multicast Routing Table
Flags: D - Dense, S - Sparse, B - Bidir Group, s - SSM Group, C - Connected,
 L - Local, P - Pruned, R - RP-bit set, F - Register flag,
 T - SPT-bit set, J - Join SPT, M - MSDP created entry, E - Extranet,
 X - Proxy Join Timer Running, A - Candidate for MSDP Advertisement,
 U - URD, I - Received Source Specific Host Report,
 Z - Multicast Tunnel, z - MDT-data group sender,
 Y - Joined MDT-data group, y - Sending to MDT-data group,
 V - RD & Vector, v - Vector
Outgoing interface flags: H - Hardware switched, A - Assert winner
Timers: Uptime/Expires
Interface state: Interface, Next-Hop or VCD, State/Mode
(40.0.0.2, 232.0.1.4), 00:00:16/00:03:13, flags: sT
 Incoming interface: GigabitEthernet3/2/1, RPF nbr 0.0.0.0
 Outgoing interface list:
 Lspvif1, LSM MDT: B0000004 (default), Forward/Sparse, 00:00:16/00:03:13
 (*, 224.0.1.40), 00:47:09/00:02:56, RP 0.0.0.0, flags: DPL
 Incoming interface: Null, RPF nbr 0.0.0.0
 Outgoing interface list: Null

```

- To check the packet counters, use `show ip mroute vrf vrf_name count` command:

```

Router# show ip mroute vrf blue count
IP Multicast Statistics
2 routes using 1208 bytes of memory
2 groups, 0.50 average sources per group
Forwarding Counts: Pkt Count/Pkts per second/Avg Pkt Size/Kilobits per second
Other counts: Total/RPF failed/Other drops(OIF-null, rate-limit etc)
Group: 232.0.1.4, Source count: 1, Packets forwarded: 1333, Packets received: 1334
 Source: 40.0.0.2/32, Forwarding: 1333/20/46/7, Other: 1334/0/1
Group: 224.0.1.40, Source count: 0, Packets forwarded: 0, Packets received: 0

```

- To check the MFIB output and whether hardware switching or software switching is enabled, use `show ip mfib vrf vrf_name group_address verbose` command:

```

Router# show ip mfib vrf blue 232.0.1.4 verbose
Entry Flags: C - Directly Connected, S - Signal, IA - Inherit A flag,
 ET - Data Rate Exceeds Threshold, K - Keepalive
 DDE - Data Driven Event, HW - Hardware Installed
I/O Item Flags: IC - Internal Copy, NP - Not platform switched,

```

```

NS - Negate Signalling, SP - Signal Present,
A - Accept, F - Forward, RA - MRIB Accept, RF - MRIB Forward,
MA - MFIB Accept
Platform per slot HW-Forwarding Counts: Pkt Count/Byte Count
Platform Entry flags: HF - Hardware Forwarding, NP - Not platform switched,
PF - Partial Hardware Forwarding
Platform Interface flags: HW - Hardware Switched, NP - Not platform switched
Forwarding Counts: Pkt Count/Pkts per second/Avg Pkt Size/Kbits per second
Other counts: Total/RPF failed/Other drops
I/O Item Counts: FS Pkt Count/PS Pkt Count
VRF blue
(40.0.0.2,232.0.1.4) Flags: K HW
Platform Flags: HW
Slot 6: HW Forwarding: 912/41952, Platform Flags: HF
SW Forwarding: 0/0/0/0, Other: 1/0/1
HW Forwarding: 912/20/46/7, Other: 0/0/0
GigabitEthernet3/2/1 Flags: RA A MA
Platform Flags:
Lspvif1, LSM/B0000004 Flags: RF F NS
Platform Flags: HW
CEF: Mid chain adjacency
Pkts: 0/0

```

- To check the labels, use show mpls forwarding-table command:

```

Router# show mpls forwarding-table
Local Outgoing Prefix Bytes Label Outgoing Next Hop
Label Label or Tunnel Id Switched interface
16 Pop Label IPv4 VRF[V] 0 aggregate/blue
17 Pop Label IPv4 VRF[V] 0 aggregate/red
18 [T] Pop Label 192.0.2.3/32 0 Tu20 point2point
19 [T] 25 192.0.2.2/32 0 Tu20 point2point
20 [T] Pop Label 19.0.0.0/24 0 Tu20 point2point
22 [T] No Label [mdt 55:1111 0][V] \9422 aggregate/red
23 [T] No Label [mdt 55:2222 0][V] \9708 aggregate/blue
[T] Forwarding through a LSP tunnel.
View additional labelling info with the 'detail' option

```

- To display all the Replicate Output Chain Element (Replicate OCE) on the Forwarding Manager (FMAN) RP, use show platform software mpls rp act-status replicate command.

```

Router#show platform software mpls rp active replicate
Replicate-oce-list: 0x400000d2 (1 OCEs)
OM: 0x42269b64
Replicate-oce-list: 0x400000d3 (1 OCEs)
OM: 0x43ba2aec
Replicate-oce-list: 0x400000d4 (0 OCEs)
OM: 0x422659bc
Replicate-oce-list: 0x400000d5 (0 OCEs)
OM: 0x422658ac

```

- To display the Replicate OCE with the specified index value on FMAN RP, use show platform software mpls rp act-status replicate index index-value command.



**Note** You should run “show platform software mpls rp active replicate” first to see the all the replicated OCE on the FMAN RP.

```
Router#show platform software mpls fp active replicate
Replicate-oce-list: 0x84 (1 OCEs)
 AOM obj: 478, HW list: 0x11b19610 (created)
Router#show platform software mpls rp active replicate index 0x84 Replicate-oce-list entries
```

| OCE               | Type      | Misc Info                        |
|-------------------|-----------|----------------------------------|
| 0xa3<br>(created) | OBJ_LABEL | aom id: 494, HW info: 0x11b19e40 |

- To display all the replicated OCE on the FMAN FP, use `show platform software mpls fp act-status replicate` command.

```
Router#show platform software mpls fp active replicate
Replicate-oce-list: 0x400000d2 (1 OCEs)
 AOM obj: 352887, HW list: 0x11a65628 (created)
Replicate-oce-list: 0x400000d3 (1 OCEs)
 AOM obj: 352889, HW list: 0x10d4a518 (created)
Replicate-oce-list: 0x400000d4 (0 OCEs)
 AOM obj: 352891, HW list: 0x139e3d90 (created)
Replicate-oce-list: 0x400000d5 (0 OCEs)
 AOM obj: 352894, HW list: 0x139e7cb8 (created)
```

- To display the complete OCE chain used for forwarding traffic to a particular IPv4 multicast address, use `show platform hardware qfp active feature multicast v4mcast ip-address-mgroup ip-address-source vrf vrf-id extension` command.

```
Router#show platform hardware qfp active feature multicast v4mcast 239.1.1.1/32 vrf 2
extension
Root: 0x1187fc58
Flags: 0x000002
First leaf: 0x11887fa8
Number of nodes: 1
Number of leaves: 3
RPF i/f: 0x01fff7
Punt limit counter: 200
NS DCS Punt limit: 0x000001
RPF Fast Convergence Flags: 00000000
Secondary RPF interface: 00000000
RPF Fast Convergence Timer: 0
Extended leaf address: 0x89f80060
Node: 0x1187fc58
Cumulative Free Space: : 4
Cumulative Weight: : 3
Number of Children: : 3
Hw Addr: : 0x8b969440
Node Flags: : 0x000004
Software Child Ptr: : 0x1187fce0, 0x1187fd60, 0x11887fa8, 00000000
00000000, 00000000, 00000000
Hardware Child Ptr: : 0x89f8e440, 0x89f8e450, 0x89f8e460, 00000000
00000000, 00000000, 00000000
OCE Flags: : 0x000009
SW OCE chain ptr: 0x11884b48
HW OCE chain ptr: 0x895d59a0
OCE Type: Adjacency, Number of children: 1
Adj Type: : IPV4 Adjacency
Encap Len: : 0
L3 MTU: : 9216
Adj Flags: : 64
Fixup Flags: : 0
```

```

Interface Name: Lspvif0
Next Hop Address: : 00000000 00000000 00000000 00000000
Lisp locator status: : 00000000
Next HW OCE Ptr: : 0x895d5940
OCE Type: REPLICATE OCE, Number of children: 1
Replica_node: : 0x89fab440
Next HW OCE Ptr: : 0x895d5ab0
OCE Type: Label OCE, Number of children: 1
Label flags: : 0
Num Labels: : 1
Num Bk Labels: : 1
Out Labels: : 17
Out Backup Labels: : 0
Next HW OCE Ptr: : 0x895d5a70
OCE Type: Label OCE, Number of children: 1
Label flags: : 65
Num Labels: : 1
Num Bk Labels: : 0
Out Labels: : 3
Next HW OCE Ptr: : 0x895d59f0
OCE Type: Adjacency, Number of children: 0
Adj Type: : MPLS Adjacency
Encap Len: : 14
L3 MTU: : 1500
Adj Flags: : 0
Fixup Flags: : 0
Interface Name: GigabitEthernet0/1/0
Encap: : 00 24 14 f4 9d 00 00 21 d8 d4 a5 10 88 47
Next Hop Address: : 0b000002 00000000 00000000 00000000
Next HW OCE Ptr: : 00000000
OCE Flags: : 0x000002
SW OCE chain ptr: 0x118830d0
HW OCE chain ptr: 0x895d58f0
OCE Type: Adjacency, Number of children: 0
Adj Type: : IPV4 Adjacency
Encap Len: : 20
L3 MTU: : 1480
Adj Flags: : 0
Fixup Flags: : 2
Interface Name: Tunnell
Encap: : 45 00 00 00 00 00 00 00 ff 67 39 94 c0 00 01 01
c0 00 01 01
Next Hop Address: : 00000000 00000000 00000000 00000000
Lisp locator status: : 00000000
Next HW OCE Ptr: : 00000000
OCE Flags: : 0x000009
SW OCE chain ptr: 0x1186c250
HW OCE chain ptr: 0x895d5650
OCE Type: Adjacency, Number of children: 0
Adj Type: : IPV4 Adjacency
Encap Len: : 14
L3 MTU: : 1500
Adj Flags: : 0
Fixup Flags: : 64
Interface Name: GigabitEthernet0/1/2
Encap: : 01 00 5e 00 00 00 00 21 d8 d4 a5 12 08 00
Next Hop Address: : e1000000 00000000 00000000 00000000
Lisp locator status: : 00000000
Next HW OCE Ptr: : 00000000
OCE Flags: : 0x000009
SW OCE chain ptr: 0x1186d478
HW OCE chain ptr: 0x895d5660
OCE Type: Adjacency, Number of children: 0
Adj Type: : IPV4 Adjacency

```



```

Encap Len: : 14
L3 MTU: : 1500
Adj Flags: : 0
Fixup Flags: : 64
Interface Name: GigabitEthernet0/1/4
Encap: : 01 00 5e 00 00 00 00 21 d8 d4 a5 14 08 00
Next Hop Address: : e1000000 00000000 00000000 00000000
Lisp locator status: : 00000000
Next HW OCE Ptr: : 00000000

```

- To display the complete OCE chain used for forwarding traffic to a particular IPv6 multicast address, use `show platform hardware qfp active feature multicast v6mcast ip-address-mgroup ip-address-source vrf vrf-id extension` command.

```

Router#show platform hardware qfp active feature multicast v6mcast FF04::10/128 vrf 503316482
extension
Root: 0x11b6c700
Flags: 0x000002
First leaf: 0x11e55bc8
Number of nodes: 1
Number of leaves: 3
RPF i/f: 0x01fff3
Punt limit counter: 200
NS DCS Punt limit: 0x000001
RPF Fast Convergence Flags: 00000000
Secondary RPF interface: 00000000
RPF Fast Convergence Timer: 0
Extended leaf address: 0x8ba18c90
Node: 0x11b6c700
Cumulative Free Space: : 4
Cumulative Weight: : 3
Number of Children: : 3
Hw Addr: : 0x8ba06c60
Node Flags: : 0x000004
Software Child Ptr: : 0x11b6dcb0, 0x11b6e0b0, 0x11e55bc8, 00000000
00000000, 00000000, 00000000
Hardware Child Ptr: : 0x8ba24060, 0x8ba24070, 0x8ba245f0, 00000000
00000000, 00000000, 00000000
OCE Flags: : 0x000009
SW OCE chain ptr: 0x11b71af0
HW OCE chain ptr: 0x895ffa40
OCE Type: Adjacency, Number of children: 1
Adj Type: : IPV6 Adjacency
Encap Len: : 0
L3 MTU: : 9216
Adj Flags: : 64
Fixup Flags: : 0
Interface Name: Lspvif0
Next Hop Address: : 00000000 00000000 00000000 00000000
Lisp locator status: : 00000000
Next HW OCE Ptr: : 0x895ffa20
OCE Type: Label OCE, Number of children: 1
Label flags: : 0
Num Labels: : 1
Num Bk Labels: : 1
Out Labels: : 2
Out Backup Labels: : 2
Next HW OCE Ptr: : 0x895ff9f0
OCE Type: Adjacency, Number of children: 1
Adj Type: : MPLS Adjacency
Encap Len: : 0
L3 MTU: : 9216
Adj Flags: : 64

```

```

Fixup Flags: : 0
Interface Name: Lspvif0
Next Hop Address: : 00000000 00000000 00000000 00000000
Next HW OCE Ptr: : 0x895ff980
OCE Type: REPLICATE OCE, Number of children: 1
Replica_node: : 0x8ba51060
Next HW OCE Ptr: : 0x895ffa60
OCE Type: Label OCE, Number of children: 1
Label flags: : 0
Num Labels: : 1
Num Bk Labels: : 1
Out Labels: : 17
Out Backup Labels: : 0
Next HW OCE Ptr: : 0x895ff7b0
OCE Type: Adjacency, Number of children: 0
Adj Type: : MPLS Adjacency
Encap Len: : 14
L3 MTU: : 1500
Adj Flags: : 0
Fixup Flags: : 0
Interface Name: GigabitEthernet0/1/0
Encap: : 00 24 14 f4 9d 00 00 21 d8 d4 a5 10 88 47
Next Hop Address: : 0b000002 00000000 00000000 00000000
Next HW OCE Ptr: : 00000000
OCE Flags: : 0x000009
SW OCE chain ptr: 0x11b6b800
HW OCE chain ptr: 0x895ff6a0
OCE Type: Adjacency, Number of children: 0
Adj Type: : IPV6 Adjacency
Encap Len: : 14
L3 MTU: : 1500
Adj Flags: : 0
Fixup Flags: : 64
Interface Name: GigabitEthernet0/1/2
Encap: : 33 33 00 00 00 00 00 21 d8 d4 a5 12 86 dd
Next Hop Address: : ff0e0000 00000000 00000000 00000000
Lisp locator status: : 00000000
Next HW OCE Ptr: : 00000000
OCE Flags: : 0x000009
SW OCE chain ptr: 0x11b6ba08
HW OCE chain ptr: 0x895ff6e0
OCE Type: Adjacency, Number of children: 0
Adj Type: : IPV6 Adjacency
Encap Len: : 14
L3 MTU: : 1500
Adj Flags: : 0
Fixup Flags: : 64
Interface Name: GigabitEthernet0/1/4
Encap: : 33 33 00 00 00 00 00 21 d8 d4 a5 14 86 dd
Next Hop Address: : ff0e0000 00000000 00000000 00000000
Lisp locator status: : 00000000
Next HW OCE Ptr: : 00000000
OCE Flags: : 0x00000a
SW OCE chain ptr: 0x11b6de20
HW OCE chain ptr: 0x895ff770
OCE Type: Adjacency, Number of children: 0
Adj Type: : IPV6 Adjacency
Encap Len: : 4
L3 MTU: : 1460
Adj Flags: : 2
Fixup Flags: : 2
Interface Name: Tunnel15
Encap: : f8 00 01 47
Next Hop Address: : 00000000 00000000 00000000 00000000

```

```

Lisp locator status: : 00000000
Next HW OCE Ptr: : 00000000
Root: 0x11e4f428
Flags: 00000000
First leaf: 0x11e51b90
Number of nodes: 1
Number of leaves: 3
RPF i/f: 0x0003fd
Punt limit counter: 200
NS DCS Punt limit: 0x000001
RPF Fast Convergence Flags: 00000000
Secondary RPF interface: 00000000
RPF Fast Convergence Timer: 0
Extended leaf address: 0x8ba21210
Node: 0x11e4f428
Cumulative Free Space: : 4
Cumulative Weight: : 3
Number of Children: : 3
Hw Addr: : 0x8ba0c560
Node Flags: : 0x000004
Software Child Ptr: : 0x11e424b8, 0x11e332b8, 0x11e51b90, 00000000
Root: 0x11e50f20
Flags: 00000000
First leaf: 0x11e51b90
Number of nodes: 1
Number of leaves: 3
RPF i/f: 0x0003fd
Punt limit counter: 200
NS DCS Punt limit: 0x000001
RPF Fast Convergence Flags: 00000000
Secondary RPF interface: 00000000
RPF Fast Convergence Timer: 0
Extended leaf address: 0x8ba212a0
Node: 0x11e50f20
Cumulative Free Space: : 4
Cumulative Weight: : 3
Number of Children: : 3
Hw Addr: : 0x8ba0c560
Node Flags: : 0x000004
Software Child Ptr: : 0x11e424b8, 0x11e56f98, 0x11e51b90, 00000000
00000000, 00000000, 00000000
Hardware Child Ptr: : 0x8ba247a0, 0x8ba24750, 0x8ba24740, 00000000
00000000, 00000000, 00000000
OCE Flags: : 0x000009
SW OCE chain ptr: 0x11b6ba08
HW OCE chain ptr: 0x895ff6e0
OCE Type: Adjacency, Number of children: 0
Adj Type: : IPV6 Adjacency
Encap Len: : 14
L3 MTU: : 1500
Adj Flags: : 0
Fixup Flags: : 64
Interface Name: GigabitEthernet0/1/4
Encap: : 33 33 00 00 00 00 00 21 d8 d4 a5 14 86 dd
Next Hop Address: : ff0e0000 00000000 00000000 00000000
Lisp locator status: : 00000000
Next HW OCE Ptr: : 00000000
OCE Flags: : 0x000009
SW OCE chain ptr: 0x11b71af0
HW OCE chain ptr: 0x895ffa40
OCE Type: Adjacency, Number of children: 1
Adj Type: : IPV6 Adjacency
Encap Len: : 0
L3 MTU: : 9216

```

```

Adj Flags: : 64
Fixup Flags: : 0
Interface Name: Lspvif0
Next Hop Address: : 00000000 00000000 00000000 00000000
Lisp locator status: : 00000000
Next HW OCE Ptr: : 0x895ffa20
OCE Type: Label OCE, Number of children: 1
Label flags: : 0
Num Labels: : 1
Num Bk Labels: : 1
Out Labels: : 2
Out Backup Labels: : 2
Next HW OCE Ptr: : 0x895ff9f0
OCE Type: Adjacency, Number of children: 1
Adj Type: : MPLS Adjacency
Encap Len: : 0
L3 MTU: : 9216
Adj Flags: : 64
Fixup Flags: : 0
Interface Name: Lspvif0
Next Hop Address: : 00000000 00000000 00000000 00000000
Next HW OCE Ptr: : 0x895ff980
OCE Type: REPLICATE OCE, Number of children: 1
Replica_node: : 0x8ba51060
Next HW OCE Ptr: : 0x895ffa60
OCE Type: Label OCE, Number of children: 1
Label flags: : 0
Num Labels: : 1
Num Bk Labels: : 1
Out Labels: : 17
Out Backup Labels: : 0
Next HW OCE Ptr: : 0x895ff7b0
OCE Type: Adjacency, Number of children: 0
Adj Type: : MPLS Adjacency
Encap Len: : 14
L3 MTU: : 1500
Adj Flags: : 0
Fixup Flags: : 0
Interface Name: GigabitEthernet0/1/0
Encap: : 00 24 14 f4 9d 00 00 21 d8 d4 a5 10 88 47
Next Hop Address: : 0b000002 00000000 00000000 00000000
Next HW OCE Ptr: : 00000000
OCE Flags: : 0x000003
SW OCE chain ptr: 0x11b6b800
HW OCE chain ptr: 0x895ff6a0
OCE Type: Adjacency, Number of children: 0
Adj Type: : IPV6 Adjacency
Encap Len: : 14
L3 MTU: : 1500
Adj Flags: : 0
Fixup Flags: : 64
Interface Name: GigabitEthernet0/1/2
Encap: : 33 33 00 00 00 00 00 21 d8 d4 a5 12 86 dd
Next Hop Address: : ff0e0000 00000000 00000000 00000000
Lisp locator status: : 00000000
Next HW OCE Ptr: : 00000000

```

- To display the complete OCE chain used for handling incoming MPLS packets with the particular label, use `show platform hardware qfp active feature cef-mpls prefix mpls mpls-lable exact` command.

```

Router# show platform hardware qfp active feature cef-mpls prefix mpls 17 exact
Gtrie Node Type: Leaf Node
HW Content: : 0a000000 00000f00 00000000 8bb08a30

```

```

QPPB QoS Precedence valid: 0
QoS Precedence: 0
QPPB QoS Group valid: 0
QoS Group: 0
BGPPA Traffic Index valid: 0
BGPPA Traffic Index: 0
TBLF refcount: 2
TBLF application lf handle: 0
CTS src_sgt: 0
CTS dst_sgt: 0
Prefix Length: 20
Prefix: 00 0d 00
Lisp local eid: 0
Lisp remote eid: 0
Lisp locator status bits: 0
Lisp dynamic configured eid: 0
Lisp dynamic discovered eid: 0
OCE Type: EOS OCE, Number of children: 2
Next HW OCE Ptr: : 0x8bb07e10, 0x8bb07e00
OCE Type: REPLICATE OCE, Number of children: 2
Replica_node: : 0x8ca90a20
Next HW OCE Ptr: : 0x8bb07eb0, 0x8bb08840
OCE Type: Label OCE, Number of children: 1
Label flags: : 64
Num Labels: : 1
Num Bk Labels: : 0
Out Labels: : 1048577
Next HW OCE Ptr: : 0x8bb07e60
OCE Type: Interface OCE, Number of children: 1
Next HW OCE Ptr: : 0x8bb07e40
Interface Name: Lspvif20
OCE Type: Lookup OCE, Number of children: 0
Lookup flags: : 1
Table Type: : 0
Lookup table ID: : 0
OCE Type: Label OCE, Number of children: 1
Label flags: : 0
Num Labels: : 1
Num Bk Labels: : 1
Out Labels: : 88
Out Backup Labels: : 0
Next HW OCE Ptr: : 0x8bb06ca0
OCE Type: Adjacency, Number of children: 0
Adj Type: : MPLS Adjacency
Encap Len: : 14
L3 MTU: : 1500
Adj Flags: : 0
Fixup Flags: : 0
Interface Name: GigabitEthernet0/1/0
Encap: : 00 0e 39 88 70 19 00 21 d8 60 c0 10 88 47
Next Hop Address: : 0f000001 00000000 00000000 00000000
Next HW OCE Ptr: : 00000000
OCE Type: REPLICATE OCE, Number of children: 2
Replica_node: : 0x8ca90a00
Next HW OCE Ptr: : 0x8bb07e70, 0x8bb08840
OCE Type: Label OCE, Number of children: 1
Label flags: : 64
Num Labels: : 1
Num Bk Labels: : 0
Out Labels: : 1048577
Next HW OCE Ptr: : 0x8bb07e50
OCE Type: Interface OCE, Number of children: 1
Next HW OCE Ptr: : 0x8bb001f0
Interface Name: Lspvif20

```

```

OCE Type: Lookup OCE, Number of children: 0
Lookup flags: : 0
Table Type: : 1
Lookup table ID: : 2
OCE Type: Label OCE, Number of children: 1
Label flags: : 0
Num Labels: : 1
Num Bk Labels: : 1
Out Labels: : 88
Out Backup Labels: : 0
Next HW OCE Ptr: : 0x8bb06ca0
OCE Type: Adjacency, Number of children: 0
Adj Type: : MPLS Adjacency
Encap Len: : 14
L3 MTU: : 1500
Adj Flags: : 0
Fixup Flags: : 0
Interface Name: GigabitEthernet0/1/0
Encap: : 00 0e 39 88 70 19 00 21 d8 60 c0 10 88 47
Next Hop Address: : 0f000001 00000000 00000000 00000000
Next HW OCE Ptr: : 00000000

```

## Sample Configuration for MLDP MVPN

You can configure MLDP MVPN in these two modes:

- Source Specific Mode (SSM)
- Sparse Mode (SM)

## Configuration Example Using SSM Mode

Consider these scenarios while configuring MLDP MVPN using SSM mode:

- MLDP MVPN Extranet SSC
- MLDP MVPN Extranet RSC
- MLDP MVPN Intranet

### MLDP MVPN Extranet SSC

{start blocklabel} Configuration on PE1 Router (Source PE): {end blocklabel}

```

ip vrf red2
 rd 10:2
 vpn id 10:2
 mdt default mpls MLDP 4.4.4.4
 mdt data mpls MLDP 100
 mdt data threshold 20
 route-target export 10:2
 route-target import 10:2
!
ip vrf red3
 rd 10:3
 vpn id 10:3
 mdt default mpls MLDP 4.4.4.4
 mdt data mpls MLDP 100
 mdt data threshold 20
 route-target export 10:3

```

```
route-target import 10:3
!
ip multicast-routing
ip multicast-routing vrf red2
ip multicast-routing vrf red3
interface Loopback1
 ip address 192.0.2.1 255.255.255.255
 ip pim sparse-mode
!
interface Loopback102
 ip vrf forwarding red2
 ip address 101.2.0.2 255.255.255.255
 ip pim sparse-mode
!
interface Loopback103
 ip vrf forwarding red3
 ip address 101.3.0.2 255.255.255.255
 ip pim sparse-mode
interface GigabitEthernet1/22.2
 encapsulation dot1Q 2
 ip vrf forwarding red2
 ip address 12.2.0.1 255.255.0.0
 ip pim sparse-mode
!
interface TenGigabitEthernet8/1
 ip address 10.1.1.1 255.255.255.0
 ip ospf 1 area 0
 load-interval 30
 mpls ip
 mpls label protocol ldp
router ospf 1
 router-id 192.0.2.1
 network 192.0.2.1 0.0.0.0 area 0
!
router bgp 100
 bgp log-neighbor-changes
 neighbor 192.0.2.2 remote-as 100
 neighbor 192.0.2.2 update-source Loopback1
 neighbor 192.0.2.3 remote-as 100
 neighbor 192.0.2.3 update-source Loopback1
 neighbor 4.4.4.4 remote-as 100
 neighbor 4.4.4.4 update-source Loopback1
!
 address-family ipv4
 neighbor 192.0.2.2 activate
 neighbor 192.0.2.3 activate
 neighbor 4.4.4.4 activate
 no auto-summary
 exit-address-family
!
 address-family vpnv4
 neighbor 192.0.2.2 activate
 neighbor 192.0.2.2 send-community both
 neighbor 192.0.2.3 activate
 neighbor 192.0.2.3 send-community both
 exit-address-family
!
 address-family ipv4 mdt
 neighbor 192.0.2.2 activate
 neighbor 192.0.2.2 send-community both
 neighbor 192.0.2.3 activate
 neighbor 192.0.2.3 send-community both
 exit-address-family
!
```

```

address-family ipv4 vrf red2
 redistribute static
 redistribute connected
 neighbor 192.0.2.2 remote-as 100
 neighbor 192.0.2.2 activate
 neighbor 192.0.2.2 send-community both
 neighbor 192.0.2.3 remote-as 100
 neighbor 192.0.2.3 activate
 neighbor 192.0.2.3 send-community both
exit-address-family
!
address-family ipv4 vrf red3
 redistribute static
 redistribute connected
 neighbor 192.0.2.2 remote-as 100
 neighbor 192.0.2.2 activate
 neighbor 192.0.2.2 send-community both
 neighbor 192.0.2.3 remote-as 100
 neighbor 192.0.2.3 activate
 neighbor 192.0.2.3 send-community both
exit-address-family
ip pim vrf red2 ssm default
ip pim vrf red3 ssm default
ip mroute vrf red3 12.2.0.0 255.255.0.0 fallback-lookup vrf red2

```

{start blocklabel} Configuration on PE Router: {end blocklabel}

```

interface Loopback1
 ip address 4.4.4.4 255.255.255.255
interface GigabitEthernet2/10
 ip address 20.1.1.2 255.255.255.0
 ip ospf 1 area 0
 load-interval 30
 mpls ip
 mpls label protocol ldp
interface GigabitEthernet2/20
 ip address 30.1.1.2 255.255.255.0
 ip ospf 1 area 0
 mpls ip
 mpls label protocol ldp
interface TenGigabitEthernet4/0/0
 ip address 10.1.1.2 255.255.255.0
 ip ospf 1 area 0
 load-interval 30
 mpls ip
 mpls label protocol ldp
router ospf 1
 router-id 4.4.4.4
 network 4.4.4.4 0.0.0.0 area 0
!
router bgp 100
 bgp log-neighbor-changes
 neighbor 192.0.2.1 remote-as 100
 neighbor 192.0.2.2 remote-as 100
 neighbor 192.0.2.3 remote-as 100
!
address-family ipv4
 neighbor 192.0.2.1 activate
 neighbor 192.0.2.2 activate
 neighbor 192.0.2.3 activate
 no auto-summary
exit-address-family

```

{start blocklabel} Configuration on PE2 Router (Receiver PE): {end blocklabel}



```

ip vrf red3
 rd 10:3
 vpn id 10:3
 mdt default mpls MLDP 4.4.4.4
 mdt data mpls MLDP 100
 mdt data threshold 20
 route-target export 10:3
 route-target import 10:3
!
ip multicast-routing
ip multicast-routing vrf red3
interface Loopback1
 ip address 192.0.2.2 255.255.255.255
 ip pim sparse-mode
!
interface Loopback103
 ip vrf forwarding red3
 ip address 102.3.0.2 255.255.255.255
 ip pim sparse-mode
!
interface GigabitEthernet4/0/0
 ip address 20.1.1.1 255.255.255.0
 ip ospf 1 area 0
 load-interval 30
 negotiation auto
 mpls ip
 mpls label protocol ldp
!
interface GigabitEthernet4/0/1.3
 encapsulation dot1Q 3
 ip vrf forwarding red3
 ip address 22.2.0.1 255.255.0.0
 ip pim sparse-mode
!
router ospf 1
 router-id 192.0.2.2
 network 192.0.2.2 0.0.0.0 area 0
!
router bgp 100
 bgp log-neighbor-changes
 neighbor 192.0.2.1 remote-as 100
 neighbor 192.0.2.1 update-source Loopback1
 neighbor 192.0.2.3 remote-as 100
 neighbor 192.0.2.3 update-source Loopback1
 neighbor 4.4.4.4 remote-as 100
 neighbor 4.4.4.4 update-source Loopback1
!
 address-family ipv4
 neighbor 192.0.2.1 activate
 neighbor 192.0.2.3 activate
 neighbor 4.4.4.4 activate
 no auto-summary
 exit-address-family
!
 address-family vpnv4
 neighbor 192.0.2.1 activate
 neighbor 192.0.2.1 send-community both
 neighbor 192.0.2.3 activate
 neighbor 192.0.2.3 send-community both
 exit-address-family
!
 address-family ipv4 mdt
 neighbor 192.0.2.1 activate

```

```

neighbor 192.0.2.1 send-community both
neighbor 192.0.2.3 activate
neighbor 192.0.2.3 send-community both
exit-address-family
!
address-family ipv4 vrf red3
 redistribute static
 redistribute connected
 neighbor 192.0.2.1 remote-as 100
 neighbor 192.0.2.1 activate
 neighbor 192.0.2.1 send-community both
 neighbor 192.0.2.3 remote-as 100
 neighbor 192.0.2.3 activate
 neighbor 192.0.2.3 send-community both
exit-address-family
!
ip pim vrf red3 ssm default
ip mroute vrf red3 12.2.0.0 255.255.0.0 101.3.0.2

```

{start blocklabel} Configuration on PE3 Router (Receiver PE){end blocklabel}

```

ip vrf red3
 rd 10:3
 vpn id 10:3
 mdt default mpls MLDP 4.4.4.4
 mdt data mpls MLDP 100
 mdt data threshold 20
 route-target export 10:3
 route-target import 10:3
!
ip multicast-routing
ip multicast-routing vrf red3
!
interface Loopback1
 ip address 192.0.2.3 255.255.255.255
 ip pim sparse-mode
!
interface Loopback103
 ip vrf forwarding red3
 ip address 103.3.0.2 255.255.255.255
 ip pim sparse-mode
!
interface GigabitEthernet3/2/0.3
 encapsulation dot1Q 3
 ip vrf forwarding red3
 ip address 32.2.0.1 255.255.0.0
 ip pim sparse-mode
 ip igmp version 3
!
interface GigabitEthernet3/2/1
 ip address 30.1.1.1 255.255.255.0
 ip ospf 1 area 0
 load-interval 30
 negotiation auto
 mpls ip
 mpls label protocol ldp
!
router ospf 1
 router-id 192.0.2.3
 network 192.0.2.3 0.0.0.0 area 0
!
router bgp 100
 bgp log-neighbor-changes
 neighbor 192.0.2.1 remote-as 100

```

```

neighbor 192.0.2.1 update-source Loopback1
neighbor 192.0.2.2 remote-as 100
neighbor 192.0.2.2 update-source Loopback1
neighbor 4.4.4.4 remote-as 100
neighbor 4.4.4.4 update-source Loopback1
!
address-family ipv4
 neighbor 192.0.2.1 activate
 neighbor 192.0.2.2 activate
 neighbor 4.4.4.4 activate
 no auto-summary
exit-address-family
!
address-family vpnv4
 neighbor 192.0.2.1 activate
 neighbor 192.0.2.1 send-community both
 neighbor 192.0.2.2 activate
 neighbor 192.0.2.2 send-community both
exit-address-family
!
address-family ipv4 mdt
 neighbor 192.0.2.1 activate
 neighbor 192.0.2.1 send-community both
 neighbor 192.0.2.2 activate
 neighbor 192.0.2.2 send-community both
exit-address-family
!
address-family ipv4 vrf red3
 redistribute static
 redistribute connected
 neighbor 192.0.2.1 remote-as 100
 neighbor 192.0.2.1 activate
 neighbor 192.0.2.1 send-community both
 neighbor 192.0.2.2 remote-as 100
 neighbor 192.0.2.2 activate
 neighbor 192.0.2.2 send-community both
exit-address-family
!
ip pim vrf red3 ssm default
ip mroute vrf red3 12.2.0.0 255.255.0.0 101.3.0.2

```

## MLDP MVPN Extranet RSC

{start blocklabel}Configuration on PE1 Router (Source PE){end blocklabel}

```

ip vrf red2
 rd 10:2
 vpn id 10:2
 mdt default mpls MLDP 4.4.4.4
 mdt data mpls MLDP 100
 mdt data threshold 20
 route-target export 10:2
 route-target import 10:2
!
ip multicast-routing
ip multicast-routing vrf red2
!
interface Loopback1
 ip address 192.0.2.1 255.255.255.255
 ip pim sparse-mode
!
interface Loopback102
 ip vrf forwarding red2

```

```

ip address 101.2.0.2 255.255.255.255
ip pim sparse-mode
!
interface GigabitEthernet1/22.2
encapsulation dot1Q 2
ip vrf forwarding red2
ip address 12.2.0.1 255.255.0.0
ip pim sparse-mode
!
interface TenGigabitEthernet8/1
ip address 10.1.1.1 255.255.255.0
ip ospf 1 area 0
load-interval 30
mpls ip
mpls label protocol ldp
!
router ospf 1
router-id 192.0.2.1
network 192.0.2.1 0.0.0.0 area 0
!
router bgp 100
bgp log-neighbor-changes
neighbor 192.0.2.2 remote-as 100
neighbor 192.0.2.2 update-source Loopback1
neighbor 192.0.2.3 remote-as 100
neighbor 192.0.2.3 update-source Loopback1
neighbor 4.4.4.4 remote-as 100
neighbor 4.4.4.4 update-source Loopback1
!
address-family ipv4
neighbor 192.0.2.2 activate
neighbor 192.0.2.3 activate
neighbor 4.4.4.4 activate
no auto-summary
exit-address-family
!
address-family vpnv4
neighbor 192.0.2.2 activate
neighbor 192.0.2.2 send-community both
neighbor 192.0.2.3 activate
neighbor 192.0.2.3 send-community both
exit-address-family
!
address-family ipv4 mdt
neighbor 192.0.2.2 activate
neighbor 192.0.2.2 send-community both
neighbor 192.0.2.3 activate
neighbor 192.0.2.3 send-community both
exit-address-family
!
address-family ipv4 vrf red2
redistribute static
redistribute connected
neighbor 192.0.2.2 remote-as 100
neighbor 192.0.2.2 activate
neighbor 192.0.2.2 send-community both
neighbor 192.0.2.3 remote-as 100
neighbor 192.0.2.3 activate
neighbor 192.0.2.3 send-community both
exit-address-family
!
ip pim vrf red2 ssm default

{end blocklabel} Configuration on P Router (Core Router) {end blocklabel}

```

```

interface Loopback1
 ip address 4.4.4.4 255.255.255.255
 !
interface GigabitEthernet2/10
 ip address 20.1.1.2 255.255.255.0
 ip ospf 1 area 0
 load-interval 30
 mpls ip
 mpls label protocol ldp
 !
interface GigabitEthernet2/20
 ip address 30.1.1.2 255.255.255.0
 ip ospf 1 area 0
 mpls ip
 mpls label protocol ldp
 !
interface TenGigabitEthernet4/0/0
 ip address 10.1.1.2 255.255.255.0
 ip ospf 1 area 0
 load-interval 30
 mpls ip
 mpls label protocol ldp
 mls qos trust dscp
 !
router ospf 1
 router-id 4.4.4.4
 network 4.4.4.4 0.0.0.0 area 0
 !
router bgp 100
 bgp log-neighbor-changes
 neighbor 192.0.2.1 remote-as 100
 neighbor 192.0.2.2 remote-as 100
 neighbor 192.0.2.3 remote-as 100
 !
 address-family ipv4
 neighbor 192.0.2.1 activate
 neighbor 192.0.2.2 activate
 neighbor 192.0.2.3 activate
 no auto-summary
 exit-address-family
 !

```

{start blocklabel} Configuration ond PE2 Router (Receiver PE){end blocklabel}

```

ip vrf red2
 rd 10:2
 vpn id 10:2
 mdt default mpls MLDP 4.4.4.4
 mdt data mpls MLDP 100
 mdt data threshold 20
 route-target export 10:2
 route-target import 10:2
 !
ip vrf red3
 rd 10:3
 vpn id 10:3
 mdt default mpls MLDP 4.4.4.4
 mdt data mpls MLDP 100
 mdt data threshold 20
 route-target export 10:3
 route-target import 10:3
 !
ip multicast-routing

```

```

ip multicast-routing vrf red3
ip multicast-routing vrf red2
!
interface Loopback1
 ip address 192.0.2.2 255.255.255.255
 ip pim sparse-mode
!
interface Loopback102
 ip vrf forwarding red2
 ip address 102.2.0.2 255.255.255.255
 ip pim sparse-mode
!
interface Loopback103
 ip vrf forwarding red3
 ip address 102.3.0.2 255.255.255.255
 ip pim sparse-mode
!
interface GigabitEthernet4/0/0
 ip address 20.1.1.1 255.255.255.0
 ip ospf 1 area 0
 load-interval 30
 negotiation auto
 mpls ip
 mpls label protocol ldp
!
interface GigabitEthernet4/0/1.3
 encapsulation dot1Q 3
 ip vrf forwarding red3
 ip address 22.2.0.1 255.255.0.0
 ip pim sparse-mode
!
router ospf 1
 router-id 192.0.2.2
 network 192.0.2.2 0.0.0.0 area 0
!
router bgp 100
 bgp log-neighbor-changes
 neighbor 192.0.2.1 remote-as 100
 neighbor 192.0.2.1 update-source Loopback1
 neighbor 192.0.2.3 remote-as 100
 neighbor 192.0.2.3 update-source Loopback1
 neighbor 4.4.4.4 remote-as 100
 neighbor 4.4.4.4 update-source Loopback1
!
 address-family ipv4
 neighbor 192.0.2.1 activate
 neighbor 192.0.2.3 activate
 neighbor 4.4.4.4 activate
 no auto-summary
 exit-address-family
!
 address-family vpnv4
 neighbor 192.0.2.1 activate
 neighbor 192.0.2.1 send-community both
 neighbor 192.0.2.3 activate
 neighbor 192.0.2.3 send-community both
 exit-address-family
!
 address-family ipv4 mdt
 neighbor 192.0.2.1 activate
 neighbor 192.0.2.1 send-community both
 neighbor 192.0.2.3 activate
 neighbor 192.0.2.3 send-community both
 exit-address-family

```

```

!
address-family ipv4 vrf red2
 redistribute static
 redistribute connected
 neighbor 192.0.2.1 remote-as 100
 neighbor 192.0.2.1 activate
 neighbor 192.0.2.1 send-community both
 neighbor 192.0.2.3 remote-as 100
 neighbor 192.0.2.3 activate
 neighbor 192.0.2.3 send-community both
exit-address-family
!
address-family ipv4 vrf red3
 redistribute static
 redistribute connected
 neighbor 192.0.2.1 remote-as 100
 neighbor 192.0.2.1 activate
 neighbor 192.0.2.1 send-community both
 neighbor 192.0.2.3 remote-as 100
 neighbor 192.0.2.3 activate
 neighbor 192.0.2.3 send-community both
exit-address-family
!
ip pim vrf red3 ssm default
ip pim vrf red2 ssm default
ip mroute vrf red3 12.2.0.0 255.255.0.0 fallback-lookup vrf red2

```

{start blocklabel}Configuration on PE3 Router (Receiver PE){end blocklabel}

```

ip vrf red2
 rd 10:2
 vpn id 10:2
 mdt default mpls MLDP 4.4.4.4
 mdt data mpls MLDP 100
 mdt data threshold 20
 route-target export 10:2
 route-target import 10:2
!
ip vrf red3
 rd 10:3
 vpn id 10:3
 mdt default mpls MLDP 4.4.4.4
 mdt data mpls MLDP 100
 mdt data threshold 20
 route-target export 10:3
 route-target import 10:3
!
ip multicast-routing
ip multicast-routing vrf red3
ip multicast-routing vrf red2
!
interface Loopback1
 ip address 192.0.2.3 255.255.255.255
 ip pim sparse-mode
!
interface Loopback102
 ip vrf forwarding red2
 ip address 103.2.0.2 255.255.255.255
 ip pim sparse-mode
!
interface Loopback103
 ip vrf forwarding red3
 ip address 103.3.0.2 255.255.255.255
 ip pim sparse-mode

```

```

!
interface GigabitEthernet3/2/0.3
 encapsulation dot1Q 3
 ip vrf forwarding red3
 ip address 32.2.0.1 255.255.0.0
 ip pim sparse-mode
 ip igmp version 3
!
interface GigabitEthernet3/2/1
 ip address 30.1.1.1 255.255.255.0
 ip ospf 1 area 0
 load-interval 30
 negotiation auto
 mpls ip
 mpls label protocol ldp
!
router ospf 1
 router-id 192.0.2.3
 network 192.0.2.3 0.0.0.0 area 0
!
router bgp 100
 bgp log-neighbor-changes
 neighbor 192.0.2.1 remote-as 100
 neighbor 192.0.2.1 update-source Loopback1
 neighbor 192.0.2.2 remote-as 100
 neighbor 192.0.2.2 update-source Loopback1
 neighbor 4.4.4.4 remote-as 100
 neighbor 4.4.4.4 update-source Loopback1
!
 address-family ipv4
 neighbor 192.0.2.1 activate
 neighbor 192.0.2.2 activate
 neighbor 4.4.4.4 activate
 no auto-summary
 exit-address-family
!
 address-family vpnv4
 neighbor 192.0.2.1 activate
 neighbor 192.0.2.1 send-community both
 neighbor 192.0.2.2 activate
 neighbor 192.0.2.2 send-community both
 exit-address-family
!
 address-family ipv4 mdt
 neighbor 192.0.2.1 activate
 neighbor 192.0.2.1 send-community both
 neighbor 192.0.2.2 activate
 neighbor 192.0.2.2 send-community both
 exit-address-family
!
 address-family ipv4 vrf red2
 redistribute static
 redistribute connected
 neighbor 192.0.2.1 remote-as 100
 neighbor 192.0.2.1 activate
 neighbor 192.0.2.1 send-community both
 neighbor 192.0.2.2 remote-as 100
 neighbor 192.0.2.2 activate
 neighbor 192.0.2.2 send-community both
 exit-address-family
!
 address-family ipv4 vrf red3
 redistribute static
 redistribute connected

```



```

neighbor 192.0.2.1 remote-as 100
neighbor 192.0.2.1 activate
neighbor 192.0.2.1 send-community both
neighbor 192.0.2.2 remote-as 100
neighbor 192.0.2.2 activate
neighbor 192.0.2.2 send-community both
exit-address-family
!
ip pim vrf red3 ssm default
ip pim vrf red2 ssm default
ip mroute vrf red3 12.2.0.0 255.255.0.0 fallback-lookup vrf red2

```

## MLDP MVPN Intranet

{start blocklabel} Configuration on PE1 Router (Source PE){end blocklabel}

```

ip vrf red2
rd 10:2
vpn id 10:2
mdt default mpls MLDP 4.4.4.4
mdt data mpls MLDP 100
mdt data threshold 20
route-target export 10:2
route-target import 10:2
!
ip multicast-routing
ip multicast-routing vrf red2
!
interface Loopback1
ip address 192.0.2.1 255.255.255.255
ip pim sparse-mode
!
interface Loopback102
ip vrf forwarding red2
ip address 101.2.0.2 255.255.255.255
ip pim sparse-mode
!
interface GigabitEthernet1/22.2
encapsulation dot1Q 2
ip vrf forwarding red2
ip address 12.2.0.1 255.255.0.0
ip pim sparse-mode
!
interface TenGigabitEthernet8/1
ip address 10.1.1.1 255.255.255.0
ip ospf 1 area 0
load-interval 30
mpls ip
mpls label protocol ldp
!
router ospf 1
router-id 192.0.2.1
network 192.0.2.1 0.0.0.0 area 0
!
router bgp 100
bgp log-neighbor-changes
neighbor 192.0.2.2 remote-as 100
neighbor 192.0.2.2 update-source Loopback1
neighbor 192.0.2.3 remote-as 100
neighbor 192.0.2.3 update-source Loopback1
neighbor 4.4.4.4 remote-as 100
neighbor 4.4.4.4 update-source Loopback1
!

```

```

address-family ipv4
 neighbor 192.0.2.2 activate
 neighbor 192.0.2.3 activate
 neighbor 4.4.4.4 activate
 no auto-summary
exit-address-family
!
address-family vpv4
 neighbor 192.0.2.2 activate
 neighbor 192.0.2.2 send-community both
 neighbor 192.0.2.3 activate
 neighbor 192.0.2.3 send-community both
exit-address-family
!
address-family ipv4 mdt
 neighbor 192.0.2.2 activate
 neighbor 192.0.2.2 send-community both
 neighbor 192.0.2.3 activate
 neighbor 192.0.2.3 send-community both
exit-address-family
!
address-family ipv4 vrf red2
 redistribute static
 redistribute connected
 neighbor 192.0.2.2 remote-as 100
 neighbor 192.0.2.2 activate
 neighbor 192.0.2.2 send-community both
 neighbor 192.0.2.3 remote-as 100
 neighbor 192.0.2.3 activate
 neighbor 192.0.2.3 send-community both
exit-address-family
!
ip pim vrf red2 ssm default

```

{srtat blocklabel} Configuration on P Router (Core Router){end blocklabel}

```

interface Loopback1
 ip address 4.4.4.4 255.255.255.255
!
interface GigabitEthernet2/10
 ip address 20.1.1.2 255.255.255.0
 ip ospf 1 area 0
 load-interval 30
 mpls ip
 mpls label protocol ldp
!
interface GigabitEthernet2/20
 ip address 30.1.1.2 255.255.255.0
 ip ospf 1 area 0
 mpls ip
 mpls label protocol ldp
!
interface TenGigabitEthernet4/0/0
 ip address 10.1.1.2 255.255.255.0
 ip ospf 1 area 0
 load-interval 30
 mpls ip
 mpls label protocol ldp
 mls qos trust dscp
!
router ospf 1
 router-id 4.4.4.4
 network 4.4.4.4 0.0.0.0 area 0
!

```

```

router bgp 100
 bgp log-neighbor-changes
 neighbor 192.0.2.1 remote-as 100
 neighbor 192.0.2.2 remote-as 100
 neighbor 192.0.2.3 remote-as 100
 !
 address-family ipv4
 neighbor 192.0.2.1 activate
 neighbor 192.0.2.2 activate
 neighbor 192.0.2.3 activate
 no auto-summary
 exit-address-family
 !

```

{start blocklabel} Configuration on PE2 Router (Receiver PE){end blocklabel}

```

ip vrf red2
 rd 10:2
 vpn id 10:2
 mdt default mpls MLDP 4.4.4.4
 mdt data mpls MLDP 100
 mdt data threshold 20
 route-target export 10:2
 route-target import 10:2
 !
ip multicast-routing
ip multicast-routing vrf red2
 !
interface Loopback1
 ip address 192.0.2.2 255.255.255.255
 ip pim sparse-mode
 !
interface Loopback102
 ip vrf forwarding red2
 ip address 102.2.0.2 255.255.255.255
 ip pim sparse-mode
 !
interface GigabitEthernet4/0/0
 ip address 20.1.1.1 255.255.255.0
 ip ospf 1 area 0
 load-interval 30
 negotiation auto
 mpls ip
 mpls label protocol ldp
 !
interface GigabitEthernet4/0/1.2
 encapsulation dot1Q 2
 ip vrf forwarding red2
 ip address 22.2.0.1 255.255.0.0
 ip pim sparse-mode
 ip igmp version 3
 !
router ospf 1
 router-id 192.0.2.2
 network 192.0.2.2 0.0.0.0 area 0
 !
router bgp 100
 bgp log-neighbor-changes
 neighbor 192.0.2.1 remote-as 100
 neighbor 192.0.2.1 update-source Loopback1
 neighbor 192.0.2.3 remote-as 100
 neighbor 192.0.2.3 update-source Loopback1
 neighbor 4.4.4.4 remote-as 100
 neighbor 4.4.4.4 update-source Loopback1

```

```

!
address-family ipv4
 neighbor 192.0.2.1 activate
 neighbor 192.0.2.3 activate
 neighbor 4.4.4.4 activate
 no auto-summary
exit-address-family
!
address-family vpv4
 neighbor 192.0.2.1 activate
 neighbor 192.0.2.1 send-community both
 neighbor 192.0.2.3 activate
 neighbor 192.0.2.3 send-community both
exit-address-family
!
address-family ipv4 mdt
 neighbor 192.0.2.1 activate
 neighbor 192.0.2.1 send-community both
 neighbor 192.0.2.3 activate
 neighbor 192.0.2.3 send-community both
exit-address-family
!
address-family ipv4 vrf red2
 redistribute static
 redistribute connected
 neighbor 192.0.2.1 remote-as 100
 neighbor 192.0.2.1 activate
 neighbor 192.0.2.1 send-community both
 neighbor 192.0.2.3 remote-as 100
 neighbor 192.0.2.3 activate
 neighbor 192.0.2.3 send-community both
exit-address-family
!
ip pim vrf red2 ssm default
!

```

{start blocklabel}Configuration on PE3 Router (Receiver PE){end blocklabel}

```

ip vrf red2
 rd 10:2
 vpn id 10:2
 mdt default mpls MLDP 4.4.4.4
 mdt data mpls MLDP 100
 mdt data threshold 20
 route-target export 10:2
 route-target import 10:2
!
ip multicast-routing
ip multicast-routing vrf red2
!
interface Loopback1
 ip address 192.0.2.3 255.255.255.255
 ip pim sparse-mode
!
interface Loopback102
 ip vrf forwarding red2
 ip address 103.2.0.2 255.255.255.255
 ip pim sparse-mode
!
interface GigabitEthernet3/2/0.2
 encapsulation dot1Q 2
 ip vrf forwarding red2
 ip address 32.2.0.1 255.255.0.0
 ip pim sparse-mode

```

```

ip igmp version 3
!
interface GigabitEthernet3/2/1
ip address 30.1.1.1 255.255.255.0
ip ospf 1 area 0
load-interval 30
negotiation auto
mpls ip
mpls label protocol ldp
!
router ospf 1
router-id 192.0.2.3
network 192.0.2.3 0.0.0.0 area 0
!
router bgp 100
bgp log-neighbor-changes
neighbor 192.0.2.1 remote-as 100
neighbor 192.0.2.1 update-source Loopback1
neighbor 192.0.2.2 remote-as 100
neighbor 192.0.2.2 update-source Loopback1
neighbor 4.4.4.4 remote-as 100
neighbor 4.4.4.4 update-source Loopback1
!
address-family ipv4
neighbor 192.0.2.1 activate
neighbor 192.0.2.2 activate
neighbor 4.4.4.4 activate
no auto-summary
exit-address-family
!
address-family vpv4
neighbor 192.0.2.1 activate
neighbor 192.0.2.1 send-community both
neighbor 192.0.2.2 activate
neighbor 192.0.2.2 send-community both
exit-address-family
!
address-family ipv4 mdt
neighbor 192.0.2.1 activate
neighbor 192.0.2.1 send-community both
neighbor 192.0.2.2 activate
neighbor 192.0.2.2 send-community both
exit-address-family
!
address-family ipv4 vrf red2
redistribute static
redistribute connected
neighbor 192.0.2.1 remote-as 100
neighbor 192.0.2.1 activate
neighbor 192.0.2.1 send-community both
neighbor 192.0.2.2 remote-as 100
neighbor 192.0.2.2 activate
neighbor 192.0.2.2 send-community both
exit-address-family
!
ip pim vrf red2 ssm default
!

```

## Configuration Example Using SM Mode

Consider these scenarios while configuring MLDP MVPN using SSM mode:

- MLDP MVPN Extranet SSC

- MLDP MVPN Extranet RSC
- MLDP MVPN Intranet

## MLDP MVPN Extranet SSC

{start blocklabel} Configuration on PE1 Router (Source PE) {end blocklabel}

```

ip vrf red2
 rd 10:2
 vpn id 10:2
 mdt default mpls MLDP 4.4.4.4
 mdt data mpls MLDP 100
 mdt data threshold 20
 route-target export 10:2
 route-target import 10:2
!
ip vrf red3
 rd 10:3
 vpn id 10:3
 mdt default mpls MLDP 4.4.4.4
 mdt data mpls MLDP 100
 mdt data threshold 20
 route-target export 10:3
 route-target import 10:3
!
ip multicast-routing
ip multicast-routing vrf red2
ip multicast-routing vrf red3
interface Loopback1
 ip address 192.0.2.1 255.255.255.255
 ip pim sparse-mode
!
interface Loopback102
 ip vrf forwarding red2
 ip address 101.2.0.2 255.255.255.255
 ip pim sparse-mode
!
interface Loopback103
 ip vrf forwarding red3
 ip address 101.3.0.2 255.255.255.255
 ip pim sparse-mode
interface GigabitEthernet1/22.2
 encapsulation dot1Q 2
 ip vrf forwarding red2
 ip address 12.2.0.1 255.255.0.0
 ip pim sparse-mode
!
interface TenGigabitEthernet8/1
 ip address 10.1.1.1 255.255.255.0
 ip ospf 1 area 0
 load-interval 30
 mpls ip
 mpls label protocol ldp
router ospf 1
 router-id 192.0.2.1
 network 192.0.2.1 0.0.0.0 area 0
!
router bgp 100
 bgp log-neighbor-changes
 neighbor 192.0.2.2 remote-as 100
 neighbor 192.0.2.2 update-source Loopback1
 neighbor 192.0.2.3 remote-as 100

```

```

neighbor 192.0.2.3 update-source Loopback1
neighbor 4.4.4.4 remote-as 100
neighbor 4.4.4.4 update-source Loopback1
!
address-family ipv4
 neighbor 192.0.2.2 activate
 neighbor 192.0.2.3 activate
 neighbor 4.4.4.4 activate
 no auto-summary
exit-address-family
!
address-family vpnv4
 neighbor 192.0.2.2 activate
 neighbor 192.0.2.2 send-community both
 neighbor 192.0.2.3 activate
 neighbor 192.0.2.3 send-community both
exit-address-family
!
address-family ipv4 mdt
 neighbor 192.0.2.2 activate
 neighbor 192.0.2.2 send-community both
 neighbor 192.0.2.3 activate
 neighbor 192.0.2.3 send-community both
exit-address-family
!
address-family ipv4 vrf red2
 redistribute static
 redistribute connected
 neighbor 192.0.2.2 remote-as 100
 neighbor 192.0.2.2 activate
 neighbor 192.0.2.2 send-community both
 neighbor 192.0.2.3 remote-as 100
 neighbor 192.0.2.3 activate
 neighbor 192.0.2.3 send-community both
exit-address-family
!
address-family ipv4 vrf red3
 redistribute static
 redistribute connected
 neighbor 192.0.2.2 remote-as 100
 neighbor 192.0.2.2 activate
 neighbor 192.0.2.2 send-community both
 neighbor 192.0.2.3 remote-as 100
 neighbor 192.0.2.3 activate
 neighbor 192.0.2.3 send-community both
exit-address-family
ip pim vrf red2 rp-address 11.11.11.11
ip pim vrf red3 rp-address 11.11.11.11
ip mroute vrf red3 12.2.0.0 255.255.0.0 fallback-lookup vrf red2
ip mroute vrf red3 11.11.11.11 255.255.0.0 fallback-lookup vrf red2

```

{start blocklabel} Configuration on P Router {end blocklabel}

```

interface Loopback1
 ip address 4.4.4.4 255.255.255.255
interface GigabitEthernet2/10
 ip address 20.1.1.2 255.255.255.0
 ip ospf 1 area 0
 load-interval 30
mpls ip
mpls label protocol ldp
interface GigabitEthernet2/20
 ip address 30.1.1.2 255.255.255.0
 ip ospf 1 area 0

```

```

mpls ip
mpls label protocol ldp
interface TenGigabitEthernet4/0/0
ip address 10.1.1.2 255.255.255.0
ip ospf 1 area 0
load-interval 30
mpls ip
mpls label protocol ldp
router ospf 1
router-id 4.4.4.4
network 4.4.4.4 0.0.0.0 area 0
!
router bgp 100
bgp log-neighbor-changes
neighbor 192.0.2.1 remote-as 100
neighbor 192.0.2.2 remote-as 100
neighbor 192.0.2.3 remote-as 100
!
address-family ipv4
neighbor 192.0.2.1 activate
neighbor 192.0.2.2 activate
neighbor 192.0.2.3 activate
no auto-summary
exit-address-family

```

{start blocklabel} Configuration on PE2 Router (Receiver PE){end blocklabel}

```

ip vrf red3
rd 10:3
vpn id 10:3
mdt default mpls MLDP 4.4.4.4
mdt data mpls MLDP 100
mdt data threshold 20
route-target export 10:3
route-target import 10:3
!
ip multicast-routing
ip multicast-routing vrf red3
interface Loopback1
ip address 192.0.2.2 255.255.255.255
ip pim sparse-mode
!
interface Loopback103
ip vrf forwarding red3
ip address 102.3.0.2 255.255.255.255
ip pim sparse-mode
!
interface GigabitEthernet4/0/0
ip address 20.1.1.1 255.255.255.0
ip ospf 1 area 0
load-interval 30
negotiation auto
mpls ip
mpls label protocol ldp
!
interface GigabitEthernet4/0/1.3
encapsulation dot1Q 3
ip vrf forwarding red3
ip address 22.2.0.1 255.255.0.0
ip pim sparse-mode
!
router ospf 1
router-id 192.0.2.2
network 192.0.2.2 0.0.0.0 area 0

```



```

!
router bgp 100
 bgp log-neighbor-changes
 neighbor 192.0.2.1 remote-as 100
 neighbor 192.0.2.1 update-source Loopback1
 neighbor 192.0.2.3 remote-as 100
 neighbor 192.0.2.3 update-source Loopback1
 neighbor 4.4.4.4 remote-as 100
 neighbor 4.4.4.4 update-source Loopback1
!
address-family ipv4
 neighbor 192.0.2.1 activate
 neighbor 192.0.2.3 activate
 neighbor 4.4.4.4 activate
 no auto-summary
exit-address-family
!
address-family vpnv4
 neighbor 192.0.2.1 activate
 neighbor 192.0.2.1 send-community both
 neighbor 192.0.2.3 activate
 neighbor 192.0.2.3 send-community both
exit-address-family
!
address-family ipv4 mdt
 neighbor 192.0.2.1 activate
 neighbor 192.0.2.1 send-community both
 neighbor 192.0.2.3 activate
 neighbor 192.0.2.3 send-community both
exit-address-family
!
address-family ipv4 vrf red3
 redistribute static
 redistribute connected
 neighbor 192.0.2.1 remote-as 100
 neighbor 192.0.2.1 activate
 neighbor 192.0.2.1 send-community both
 neighbor 192.0.2.3 remote-as 100
 neighbor 192.0.2.3 activate
 neighbor 192.0.2.3 send-community both
exit-address-family
!
ip pim vrf red3 rp-address 11.11.11.11
ip mroute vrf red3 12.2.0.0 255.255.0.0 101.3.0.2

{start blocklabel}Configuraton on PE3 Router (Receiver PE){end blocklabel}

```

```

ip vrf red3
 rd 10:3
 vpn id 10:3
 mdt default mpls MLDP 4.4.4.4
 mdt data mpls MLDP 100
 mdt data threshold 20
 route-target export 10:3
 route-target import 10:3
!
ip multicast-routing
ip multicast-routing vrf red3
!
interface Loopback1
 ip address 192.0.2.3 255.255.255.255
 ip pim sparse-mode
!
interface Loopback103

```

```

ip vrf forwarding red3
ip address 103.3.0.2 255.255.255.255
ip pim sparse-mode
!
interface GigabitEthernet3/2/0.3
encapsulation dot1Q 3
ip vrf forwarding red3
ip address 32.2.0.1 255.255.0.0
ip pim sparse-mode
ip igmp version 3
!
interface GigabitEthernet3/2/1
ip address 30.1.1.1 255.255.255.0
ip ospf 1 area 0
load-interval 30
negotiation auto
mpls ip
mpls label protocol ldp
!
router ospf 1
router-id 192.0.2.3
network 192.0.2.3 0.0.0.0 area 0
!
router bgp 100
bgp log-neighbor-changes
neighbor 192.0.2.1 remote-as 100
neighbor 192.0.2.1 update-source Loopback1
neighbor 192.0.2.2 remote-as 100
neighbor 192.0.2.2 update-source Loopback1
neighbor 4.4.4.4 remote-as 100
neighbor 4.4.4.4 update-source Loopback1
!
address-family ipv4
neighbor 192.0.2.1 activate
neighbor 192.0.2.2 activate
neighbor 4.4.4.4 activate
no auto-summary
exit-address-family
!
address-family vpnv4
neighbor 192.0.2.1 activate
neighbor 192.0.2.1 send-community both
neighbor 192.0.2.2 activate
neighbor 192.0.2.2 send-community both
exit-address-family
!
address-family ipv4 mdt
neighbor 192.0.2.1 activate
neighbor 192.0.2.1 send-community both
neighbor 192.0.2.2 activate
neighbor 192.0.2.2 send-community both
exit-address-family
!
address-family ipv4 vrf red3
redistribute static
redistribute connected
neighbor 192.0.2.1 remote-as 100
neighbor 192.0.2.1 activate
neighbor 192.0.2.1 send-community both
neighbor 192.0.2.2 remote-as 100
neighbor 192.0.2.2 activate
neighbor 192.0.2.2 send-community both
exit-address-family
!

```

```
ip pim vrf red3 rp-address 11.11.11.11
ip mroute vrf red3 12.2.0.0 255.255.0.0 101.3.0.2
```

## MLDP MVPN Extranet RSC

{start blocklabel} Configuration on PE1 Router (Source PE){end blocklabel}

```
ip vrf red2
rd 10:2
vpn id 10:2
mdt default mpls MLDP 4.4.4.4
mdt data mpls MLDP 100
mdt data threshold 20
route-target export 10:2
route-target import 10:2
!
ip multicast-routing
ip multicast-routing vrf red2
!
interface Loopback1
ip address 192.0.2.1 255.255.255.255
ip pim sparse-mode
!
interface Loopback102
ip vrf forwarding red2
ip address 101.2.0.2 255.255.255.255
ip pim sparse-mode
!
interface GigabitEthernet1/22.2
encapsulation dot1Q 2
ip vrf forwarding red2
ip address 12.2.0.1 255.255.0.0
ip pim sparse-mode
!
interface TenGigabitEthernet8/1
ip address 10.1.1.1 255.255.255.0
ip ospf 1 area 0
load-interval 30
mpls ip
mpls label protocol ldp
!
router ospf 1
router-id 192.0.2.1
network 192.0.2.1 0.0.0.0 area 0
!
router bgp 100
bgp log-neighbor-changes
neighbor 192.0.2.2 remote-as 100
neighbor 192.0.2.2 update-source Loopback1
neighbor 192.0.2.3 remote-as 100
neighbor 192.0.2.3 update-source Loopback1
neighbor 4.4.4.4 remote-as 100
neighbor 4.4.4.4 update-source Loopback1
!
address-family ipv4
neighbor 192.0.2.2 activate
neighbor 192.0.2.3 activate
neighbor 4.4.4.4 activate
no auto-summary
exit-address-family
!
address-family vpnv4
neighbor 192.0.2.2 activate
```

```

neighbor 192.0.2.2 send-community both
neighbor 192.0.2.3 activate
neighbor 192.0.2.3 send-community both
exit-address-family
!
address-family ipv4 mdt
neighbor 192.0.2.2 activate
neighbor 192.0.2.2 send-community both
neighbor 192.0.2.3 activate
neighbor 192.0.2.3 send-community both
exit-address-family
!
address-family ipv4 vrf red2
redistribute static
redistribute connected
neighbor 192.0.2.2 remote-as 100
neighbor 192.0.2.2 activate
neighbor 192.0.2.2 send-community both
neighbor 192.0.2.3 remote-as 100
neighbor 192.0.2.3 activate
neighbor 192.0.2.3 send-community both
exit-address-family
!
ip pim vrf red2 rp-address 11.11.11.11
{start blocklabel} Configuration on P Router (Core Router){end blocklabel}

```

```

interface Loopback1
ip address 4.4.4.4 255.255.255.255
!
interface GigabitEthernet2/10
ip address 20.1.1.2 255.255.255.0
ip ospf 1 area 0
load-interval 30
mpls ip
mpls label protocol ldp
!
interface GigabitEthernet2/20
ip address 30.1.1.2 255.255.255.0
ip ospf 1 area 0
mpls ip
mpls label protocol ldp
!
interface TenGigabitEthernet4/0/0
ip address 10.1.1.2 255.255.255.0
ip ospf 1 area 0
load-interval 30
mpls ip
mpls label protocol ldp
mls qos trust dscp
!
router ospf 1
router-id 4.4.4.4
network 4.4.4.4 0.0.0.0 area 0
!
router bgp 100
bgp log-neighbor-changes
neighbor 192.0.2.1 remote-as 100
neighbor 192.0.2.2 remote-as 100
neighbor 192.0.2.3 remote-as 100
!
address-family ipv4
neighbor 192.0.2.1 activate
neighbor 192.0.2.2 activate

```

```

 neighbor 192.0.2.3 activate
 no auto-summary
 exit-address-family
 !
} {start blocklabel} Configuration on PE2 Router (Receiver PE) {end blocklabel}

ip vrf red2
 rd 10:2
 vpn id 10:2
 mdt default mpls MLDP 4.4.4.4
 mdt data mpls MLDP 100
 mdt data threshold 20
 route-target export 10:2
 route-target import 10:2
 !
ip vrf red3
 rd 10:3
 vpn id 10:3
 mdt default mpls MLDP 4.4.4.4
 mdt data mpls MLDP 100
 mdt data threshold 20
 route-target export 10:3
 route-target import 10:3
 !
ip multicast-routing
ip multicast-routing vrf red3
ip multicast-routing vrf red2
 !
interface Loopback1
 ip address 192.0.2.2 255.255.255.255
 ip pim sparse-mode
 !
interface Loopback102
 ip vrf forwarding red2
 ip address 102.2.0.2 255.255.255.255
 ip pim sparse-mode
 !
interface Loopback103
 ip vrf forwarding red3
 ip address 102.3.0.2 255.255.255.255
 ip pim sparse-mode
 !
interface GigabitEthernet4/0/0
 ip address 20.1.1.1 255.255.255.0
 ip ospf 1 area 0
 load-interval 30
 negotiation auto
 mpls ip
 mpls label protocol ldp
 !
interface GigabitEthernet4/0/1.3
 encapsulation dot1Q 3
 ip vrf forwarding red3
 ip address 22.2.0.1 255.255.0.0
 ip pim sparse-mode
 !
router ospf 1
 router-id 192.0.2.2
 network 192.0.2.2 0.0.0.0 area 0
 !
router bgp 100
 bgp log-neighbor-changes
 neighbor 192.0.2.1 remote-as 100

```

```

neighbor 192.0.2.1 update-source Loopback1
neighbor 192.0.2.3 remote-as 100
neighbor 192.0.2.3 update-source Loopback1
neighbor 4.4.4.4 remote-as 100
neighbor 4.4.4.4 update-source Loopback1
!
address-family ipv4
neighbor 192.0.2.1 activate
neighbor 192.0.2.3 activate
neighbor 4.4.4.4 activate
no auto-summary
exit-address-family
!
address-family vpnv4
neighbor 192.0.2.1 activate
neighbor 192.0.2.1 send-community both
neighbor 192.0.2.3 activate
neighbor 192.0.2.3 send-community both
exit-address-family
!
address-family ipv4 mdt
neighbor 192.0.2.1 activate
neighbor 192.0.2.1 send-community both
neighbor 192.0.2.3 activate
neighbor 192.0.2.3 send-community both
exit-address-family
!
address-family ipv4 vrf red2
redistribute static
redistribute connected
neighbor 192.0.2.1 remote-as 100
neighbor 192.0.2.1 activate
neighbor 192.0.2.1 send-community both
neighbor 192.0.2.3 remote-as 100
neighbor 192.0.2.3 activate
neighbor 192.0.2.3 send-community both
exit-address-family
!
address-family ipv4 vrf red3
redistribute static
redistribute connected
neighbor 192.0.2.1 remote-as 100
neighbor 192.0.2.1 activate
neighbor 192.0.2.1 send-community both
neighbor 192.0.2.3 remote-as 100
neighbor 192.0.2.3 activate
neighbor 192.0.2.3 send-community both
exit-address-family
!
ip pim vrf red2 rp-address 11.11.11.11
ip pim vrf red3 rp-address 11.11.11.11
ip mroute vrf red3 12.2.0.0 255.255.0.0 fallback-lookup vrf red2
ip mroute vrf red3 11.11.11.11 255.255.255.255 fallback-lookup vrf red2

```

{start blocklabel} Configuration on PE3 Router (Receiver PE){end blocklabel}

```

ip vrf red2
rd 10:2
vpn id 10:2
mdt default mpls MLDP 4.4.4.4
mdt data mpls MLDP 100
mdt data threshold 20
route-target export 10:2
route-target import 10:2

```

```
!
ip vrf red3
 rd 10:3
 vpn id 10:3
 mdt default mpls MLDP 4.4.4.4
 mdt data mpls MLDP 100
 mdt data threshold 20
 route-target export 10:3
 route-target import 10:3
!
ip multicast-routing
ip multicast-routing vrf red3
ip multicast-routing vrf red2
!
interface Loopback1
 ip address 192.0.2.3 255.255.255.255
 ip pim sparse-mode
!
interface Loopback102
 ip vrf forwarding red2
 ip address 103.2.0.2 255.255.255.255
 ip pim sparse-mode
!
interface Loopback103
 ip vrf forwarding red3
 ip address 103.3.0.2 255.255.255.255
 ip pim sparse-mode
!
interface GigabitEthernet3/2/0.3
 encapsulation dot1Q 3
 ip vrf forwarding red3
 ip address 32.2.0.1 255.255.0.0
 ip pim sparse-mode
 ip igmp version 3
!
interface GigabitEthernet3/2/1
 ip address 30.1.1.1 255.255.255.0
 ip ospf 1 area 0
 load-interval 30
 negotiation auto
 mpls ip
 mpls label protocol ldp
!
router ospf 1
 router-id 192.0.2.3
 network 192.0.2.3 0.0.0.0 area 0
!
router bgp 100
 bgp log-neighbor-changes
 neighbor 192.0.2.1 remote-as 100
 neighbor 192.0.2.1 update-source Loopback1
 neighbor 192.0.2.2 remote-as 100
 neighbor 192.0.2.2 update-source Loopback1
 neighbor 4.4.4.4 remote-as 100
 neighbor 4.4.4.4 update-source Loopback1
!
 address-family ipv4
 neighbor 192.0.2.1 activate
 neighbor 192.0.2.2 activate
 neighbor 4.4.4.4 activate
 no auto-summary
 exit-address-family
!
 address-family vpnv4
```

```

neighbor 192.0.2.1 activate
neighbor 192.0.2.1 send-community both
neighbor 192.0.2.2 activate
neighbor 192.0.2.2 send-community both
exit-address-family
!
address-family ipv4 mdt
neighbor 192.0.2.1 activate
neighbor 192.0.2.1 send-community both
neighbor 192.0.2.2 activate
neighbor 192.0.2.2 send-community both
exit-address-family
!
address-family ipv4 vrf red2
redistribute static
redistribute connected
neighbor 192.0.2.1 remote-as 100
neighbor 192.0.2.1 activate
neighbor 192.0.2.1 send-community both
neighbor 192.0.2.2 remote-as 100
neighbor 192.0.2.2 activate
neighbor 192.0.2.2 send-community both
exit-address-family
!
address-family ipv4 vrf red3
redistribute static
redistribute connected
neighbor 192.0.2.1 remote-as 100
neighbor 192.0.2.1 activate
neighbor 192.0.2.1 send-community both
neighbor 192.0.2.2 remote-as 100
neighbor 192.0.2.2 activate
neighbor 192.0.2.2 send-community both
exit-address-family
!
ip pim vrf red2 rp-address 11.11.11.11
ip pim vrf red3 rp-address 11.11.11.11
ip mroute vrf red3 12.2.0.0 255.255.0.0 fallback-lookup vrf red2
ip mroute vrf red3 11.11.11.11 255.255.255.255 fallback-lookup vrf red2

```

## MLDP MVPN Intranet

{start blocklabel} Configuration on PE1 Router (Source PE) {end blocklabel}

```

ip vrf red2
rd 10:2
vpn id 10:2
mdt default mpls MLDP 4.4.4.4
mdt data mpls MLDP 100
mdt data threshold 20
route-target export 10:2
route-target import 10:2
!
ip multicast-routing
ip multicast-routing vrf red2
!
interface Loopback1
ip address 192.0.2.1 255.255.255.255
ip pim sparse-mode
!
interface Loopback102
ip vrf forwarding red2
ip address 101.2.0.2 255.255.255.255

```



```

ip pim sparse-mode
!
interface GigabitEthernet1/22.2
 encapsulation dot1Q 2
 ip vrf forwarding red2
 ip address 12.2.0.1 255.255.0.0
 ip pim sparse-mode
!
interface TenGigabitEthernet8/1
 ip address 10.1.1.1 255.255.255.0
 ip ospf 1 area 0
 load-interval 30
 mpls ip
 mpls label protocol ldp
!
router ospf 1
 router-id 192.0.2.1
 network 192.0.2.1 0.0.0.0 area 0
!
router bgp 100
 bgp log-neighbor-changes
 neighbor 192.0.2.2 remote-as 100
 neighbor 192.0.2.2 update-source Loopback1
 neighbor 192.0.2.3 remote-as 100
 neighbor 192.0.2.3 update-source Loopback1
 neighbor 4.4.4.4 remote-as 100
 neighbor 4.4.4.4 update-source Loopback1
!
 address-family ipv4
 neighbor 192.0.2.2 activate
 neighbor 192.0.2.3 activate
 neighbor 4.4.4.4 activate
 no auto-summary
 exit-address-family
!
 address-family vpnv4
 neighbor 192.0.2.2 activate
 neighbor 192.0.2.2 send-community both
 neighbor 192.0.2.3 activate
 neighbor 192.0.2.3 send-community both
 exit-address-family
!
 address-family ipv4 mdt
 neighbor 192.0.2.2 activate
 neighbor 192.0.2.2 send-community both
 neighbor 192.0.2.3 activate
 neighbor 192.0.2.3 send-community both
 exit-address-family
!
 address-family ipv4 vrf red2
 redistribute static
 redistribute connected
 neighbor 192.0.2.2 remote-as 100
 neighbor 192.0.2.2 activate
 neighbor 192.0.2.2 send-community both
 neighbor 192.0.2.3 remote-as 100
 neighbor 192.0.2.3 activate
 neighbor 192.0.2.3 send-community both
 exit-address-family
!
ip pim vrf red2 rp-address 11.11.11.11

```

{start blocklabel} Configuration on P Router (Core Router) {end blocklabel}

```

interface Loopback1
 ip address 4.4.4.4 255.255.255.255
!
interface GigabitEthernet2/10
 ip address 20.1.1.2 255.255.255.0
 ip ospf 1 area 0
 load-interval 30
 mpls ip
 mpls label protocol ldp
!
interface GigabitEthernet2/20
 ip address 30.1.1.2 255.255.255.0
 ip ospf 1 area 0
 mpls ip
 mpls label protocol ldp
!
interface TenGigabitEthernet4/0/0
 ip address 10.1.1.2 255.255.255.0
 ip ospf 1 area 0
 load-interval 30
 mpls ip
 mpls label protocol ldp
 mls qos trust dscp
!
router ospf 1
 router-id 4.4.4.4
 network 4.4.4.4 0.0.0.0 area 0
!
router bgp 100
 bgp log-neighbor-changes
 neighbor 192.0.2.1 remote-as 100
 neighbor 192.0.2.2 remote-as 100
 neighbor 192.0.2.3 remote-as 100
!
 address-family ipv4
 neighbor 192.0.2.1 activate
 neighbor 192.0.2.2 activate
 neighbor 192.0.2.3 activate
 no auto-summary
 exit-address-family
!

```

{start blocklabel} Configuration on PE2 Router (Receiver PE) {end blocklabel}

```

ip vrf red2
 rd 10:2
 vpn id 10:2
 mdt default mpls MLDP 4.4.4.4
 mdt data mpls MLDP 100
 mdt data threshold 20
 route-target export 10:2
 route-target import 10:2
!
ip multicast-routing
ip multicast-routing vrf red2
!
interface Loopback1
 ip address 192.0.2.2 255.255.255.255
 ip pim sparse-mode
!
interface Loopback102
 ip vrf forwarding red2
 ip address 102.2.0.2 255.255.255.255

```

```
 ip pim sparse-mode
!
interface GigabitEthernet4/0/0
 ip address 20.1.1.1 255.255.255.0
 ip ospf 1 area 0
 load-interval 30
 negotiation auto
 mpls ip
 mpls label protocol ldp
!
interface GigabitEthernet4/0/1.2
 encapsulation dot1Q 2
 ip vrf forwarding red2
 ip address 22.2.0.1 255.255.0.0
 ip pim sparse-mode
 ip igmp version 3
!
router ospf 1
 router-id 192.0.2.2
 network 192.0.2.2 0.0.0.0 area 0
!
router bgp 100
 bgp log-neighbor-changes
 neighbor 192.0.2.1 remote-as 100
 neighbor 192.0.2.1 update-source Loopback1
 neighbor 192.0.2.3 remote-as 100
 neighbor 192.0.2.3 update-source Loopback1
 neighbor 4.4.4.4 remote-as 100
 neighbor 4.4.4.4 update-source Loopback1
!
 address-family ipv4
 neighbor 192.0.2.1 activate
 neighbor 192.0.2.3 activate
 neighbor 4.4.4.4 activate
 no auto-summary
 exit-address-family
!
 address-family vpnv4
 neighbor 192.0.2.1 activate
 neighbor 192.0.2.1 send-community both
 neighbor 192.0.2.3 activate
 neighbor 192.0.2.3 send-community both
 exit-address-family
!
 address-family ipv4 mdt
 neighbor 192.0.2.1 activate
 neighbor 192.0.2.1 send-community both
 neighbor 192.0.2.3 activate
 neighbor 192.0.2.3 send-community both
 exit-address-family
!
 address-family ipv4 vrf red2
 redistribute static
 redistribute connected
 neighbor 192.0.2.1 remote-as 100
 neighbor 192.0.2.1 activate
 neighbor 192.0.2.1 send-community both
 neighbor 192.0.2.3 remote-as 100
 neighbor 192.0.2.3 activate
 neighbor 192.0.2.3 send-community both
 exit-address-family
!
 ip pim vrf red2 rp-address 11.11.11.11
!
```

{start blocklabel}Configuration on PE3 Router (Receiver PE){end blocklabel}

```

ip vrf red2
 rd 10:2
 vpn id 10:2
 mdt default mpls MLDP 4.4.4.4
 mdt data mpls MLDP 100
 mdt data threshold 20
 route-target export 10:2
 route-target import 10:2
!
ip multicast-routing
ip multicast-routing vrf red2
!
interface Loopback1
 ip address 192.0.2.3 255.255.255.255
 ip pim sparse-mode
!
interface Loopback102
 ip vrf forwarding red2
 ip address 103.2.0.2 255.255.255.255
 ip pim sparse-mode
!
interface GigabitEthernet3/2/0.2
 encapsulation dot1Q 2
 ip vrf forwarding red2
 ip address 32.2.0.1 255.255.0.0
 ip pim sparse-mode
 ip igmp version 3
!
interface GigabitEthernet3/2/1
 ip address 30.1.1.1 255.255.255.0
 ip ospf 1 area 0
 load-interval 30
 negotiation auto
 mpls ip
 mpls label protocol ldp
!
router ospf 1
 router-id 192.0.2.3
 network 192.0.2.3 0.0.0.0 area 0
!
router bgp 100
 bgp log-neighbor-changes
 neighbor 192.0.2.1 remote-as 100
 neighbor 192.0.2.1 update-source Loopback1
 neighbor 192.0.2.2 remote-as 100
 neighbor 192.0.2.2 update-source Loopback1
 neighbor 4.4.4.4 remote-as 100
 neighbor 4.4.4.4 update-source Loopback1
!
 address-family ipv4
 neighbor 192.0.2.1 activate
 neighbor 192.0.2.2 activate
 neighbor 4.4.4.4 activate
 no auto-summary
 exit-address-family
!
 address-family vpnv4
 neighbor 192.0.2.1 activate
 neighbor 192.0.2.2 send-community both
 neighbor 192.0.2.2 activate
 neighbor 192.0.2.2 send-community both

```

```

exit-address-family
!
address-family ipv4 mdt
 neighbor 192.0.2.1 activate
 neighbor 192.0.2.1 send-community both
 neighbor 192.0.2.2 activate
 neighbor 192.0.2.2 send-community both
exit-address-family
!
address-family ipv4 vrf red2
 redistribute static
 redistribute connected
 neighbor 192.0.2.1 remote-as 100
 neighbor 192.0.2.1 activate
 neighbor 192.0.2.1 send-community both
 neighbor 192.0.2.2 remote-as 100
 neighbor 192.0.2.2 activate
 neighbor 192.0.2.2 send-community both
exit-address-family
!
ip pim vrf red2 rp-address 11.11.11.11
!

```

## Troubleshooting LSM MLDP based MVPN Support

Use these debug commands to troubleshoot the LSM MLDP based MVPN support on the Cisco ASR 1000 Series Aggregation Services Routers.

| Command                                                                                                                       | Purpose                          |
|-------------------------------------------------------------------------------------------------------------------------------|----------------------------------|
| debug mpls MLDP packet<br>debug mpls MLDP neighbor<br>debug mpls MLDP all                                                     | Used for MLDP debugging [RP].    |
| debug ip igmp vrf blue                                                                                                        | Used for IGMP debugs.            |
| debug ip pim vrf blue hello<br>debug ip pim vrf blue timer<br>debug ip pim vrf blue bsr<br>debug ip pim vrf blue auto-rp      | Used for PIM debugs [RP].        |
| debug mpls infra lfd mfi                                                                                                      | Used for IOS layer debugs.       |
| deb pl so mpls                                                                                                                | Used for IOSD shim layer debugs. |
| configure terminal<br>platform trace [run boot] slot [f0 f1 r0 r1] bay 0 process for mod cef level<br>[debug verbose ]<br>end | Used for FMAN-RP/FMAN-FP.        |
| debug platform hardware qfp active feature cef-mpls client mpls all                                                           | Used for QFP client.             |
| debug platform hardware qfp active feature cef-mpls datapath mpls all                                                         | Used for QFP server.             |

## MVPN MLDP over GRE

The Multicast Label Distribution Protocol- based Multicast VPN (MVPN) feature supports IPv4 and IPv6 multicast traffic over a Multi-Protocol Label Switching (MPLS) network. But a large part of the network infrastructure is still IP network, and the legacy IP network does not support MPLS. The existing MPLS over Generic Routing Encapsulation (GRE) feature provides a mechanism for tunneling MPLS packets over a non-MPLS network by creating a GRE tunnel across the IP network and bridging the separated MPLS networks. However, the existing MPLS over GRE feature does not support MPLS multicast traffic. The MVPN MLDP over GRE feature provides a solution by supporting encapsulating MPLS multicast traffic in the GRE tunnel.

The following figure shows a sample configuration for MVPN Multicast Label Distribution Protocol over GRE using the PE-PE network topology.

**Figure 19: MVPN MLDP over GRE with PE-PE Network Topology**

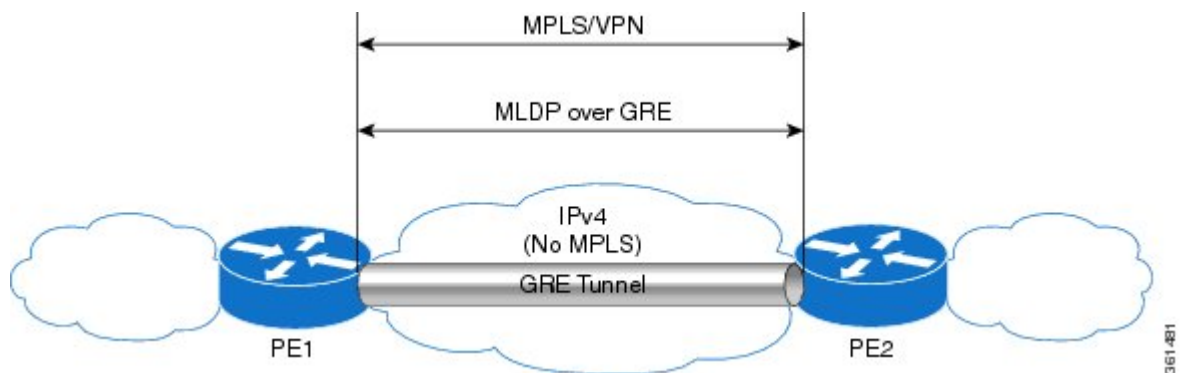

## Prerequisites for MVPN MLDP over GRE

- Ensure that MPLS Virtual Private Network (MVPN) is configured and working properly. For information about setting up MPLS VPNs, see:

```
{start
hypertext}http://www.cisco.com/en/US/docs/ios-xml/ios/mp_l3_vpns/configuration/xs-3s/asr1000/mp-cfg-layer3-vpn.html{end
hypertext}
```

- Ensure that Multiprotocol Border Gateway Protocol (MP-BGP) is configured and working properly. For more information about configuring (MP-BGP), see:

```
{start
hypertext}http://www.cisco.com/en/US/docs/ios-xml/ios/mp_l3_vpns/configuration/xs-3s/asr1000/mp-bgp-mpls-vpn.html{end
hypertext}
```

## Restrictions for MVPN MLDP over GRE

The following are the restrictions that you will encounter while configuring the MVPN MLDP over GRE feature:

- MVPN MLDP over GRE supports only IPv4 GRE.
- MVPN MLDP over GRE supports IPv4 and IPv6 multicast traffic.

## Configuring MVPN MLDP over GRE

Complete these steps to configure MVPN MLDP over GRE with PE-to-PE topology. You should perform these steps on both the PE routers.

### SUMMARY STEPS

1. **enable**
2. **configure terminal**
3. **mpls MLDP**
4. vrf definition vrf-name
5. rd route-distinguisher
6. vpn id vpn-id
7. address-family ipv4
8. mdt default mpls MLDP root-node
9. mdt default mpls MLDP root-node
10. mdt data mpls MLDP number\_of\_data\_MDTs
11. mdt data threshold bandwidth
12. route-target export route-target-ext-community
13. route-target import route-target-ext-community
14. exit
15. address-family ipv6
16. mdt default mpls MLDP root-node
17. mdt default mpls MLDP root-node
18. mdt data mpls MLDP number\_of\_data\_MDTs
19. mdt data threshold bandwidth
20. route-target export route-target-ext-community
21. route-target import route-target-ext-community
22. exit
23. exit
24. **interface** name
25. **vrf forwarding** vrf-name
26. **ip address** ip-address subnet-mask
27. ip pim sparse-mode
28. **ipv6 address** ipv6-address
29. **ospfv3100 ipv6 area** 0
30. end
31. ip multicast-routing vrf vrf-name **distributed**
32. ipv6 multicast-routing vrf vrf-name
33. exit
34. end

## DETAILED STEPS

|               | Command or Action                                                                                   | Purpose                                                                                                                                                                                                                                                                                                                                                                                                              |
|---------------|-----------------------------------------------------------------------------------------------------|----------------------------------------------------------------------------------------------------------------------------------------------------------------------------------------------------------------------------------------------------------------------------------------------------------------------------------------------------------------------------------------------------------------------|
| <b>Step 1</b> | <b>enable</b><br><b>Example:</b><br><pre>Router&gt; enable</pre>                                    | Enables the privileged EXEC mode. Enter your password when prompted.                                                                                                                                                                                                                                                                                                                                                 |
| <b>Step 2</b> | <b>configure terminal</b><br><b>Example:</b><br><pre>Router# configure terminal</pre>               | Enters the global configuration mode.                                                                                                                                                                                                                                                                                                                                                                                |
| <b>Step 3</b> | <b>mpls MLDP</b><br><b>Example:</b><br><pre>Router(config)# mpls MLDP</pre>                         | Enables MPLS MLDP support.<br><br><b>Note</b> The mpls MLDP command is configured by default. To disable MPLS MLDP, use the no mpls MLDP command.                                                                                                                                                                                                                                                                    |
| <b>Step 4</b> | <b>vrf definition vrf-name</b><br><b>Example:</b><br><pre>Router(config)# vrf definition blue</pre> | Defines the VPN routing instance by assigning a VRF name, and enters the VRF configuration mode.<br><br><i>vrf-name</i> —Name assigned to a VRF.                                                                                                                                                                                                                                                                     |
| <b>Step 5</b> | <b>rd route-distinguisher</b><br><b>Example:</b><br><pre>Router(config-vrf)# rd 200:2</pre>         | Creates routing and forwarding tables.<br><br>route-distinguisher— Specifies the 8-byte value to create a VPN prefix.<br><br>You can enter a route-distinguisher value in either of these formats: <ul style="list-style-type: none"> <li>• <i>16-bit autonomous system number</i>: Your 16-bit number Example, 200:2.</li> <li>• <i>32-bit IP address</i>: Your 32-bit number Example, 192.168.122.15:1.</li> </ul> |
| <b>Step 6</b> | <b>vpn id vpn-id</b><br><b>Example:</b><br><pre>Router(config-vrf)# vpn id 200:2</pre>              | Sets or updates a VPN identifier on a VRF.                                                                                                                                                                                                                                                                                                                                                                           |
| <b>Step 7</b> | <b>address-family ipv4</b><br><b>Example:</b><br><pre>Router(config-vrf)# address-family ipv4</pre> | Enters the address family configuration mode using standard IP Version 4 (IPv4) address prefixes.                                                                                                                                                                                                                                                                                                                    |
| <b>Step 8</b> | <b>mdt default mpls MLDP root-node</b><br><b>Example:</b>                                           | Configures MLDP MDT for a VRF.<br><br>root-node—The root node can be IP address of a loopback or physical interface on any router (source PE, receiver                                                                                                                                                                                                                                                               |



|                | Command or Action                                                                                                                        | Purpose                                                                                                                                                                                                                                                                                                                                                                                                                                                                                                   |
|----------------|------------------------------------------------------------------------------------------------------------------------------------------|-----------------------------------------------------------------------------------------------------------------------------------------------------------------------------------------------------------------------------------------------------------------------------------------------------------------------------------------------------------------------------------------------------------------------------------------------------------------------------------------------------------|
|                | <pre>Router(config-vrf-af)# mdt default mpls MLDP 192.0.2.1</pre>                                                                        | <p>PE, or core router) in the provider network. The root node address should be accessible to all the routers in the network. The router from where signalling occurs functions as the root node.</p> <p>The default MDT must be configured on each PE router to enable the PE routers to receive multicast traffic for this particular MVRF.</p> <p><b>Note</b> Creates the LSPVIF tunnel with the mdt default mpls MLDP root-node command.</p>                                                          |
| <b>Step 9</b>  | <p>mdt default mpls MLDP root-node</p> <p><b>Example:</b></p> <pre>Router(config-vrf-af)# mdt default mpls MLDP 192.0.2.2</pre>          | <p>Configures Root Node Redundancy.</p> <p>root-node—The root node can be IP address of a loopback or physical interface on any router (source PE, receiver PE, or core router) in the provider network. The root node address should be accessible to all the routers in the network. The router from where signaling occurs functions as the root node.</p> <p>The default MDT must be configured on each PE router to enable the PE routers to receive multicast traffic for this particular MVRF.</p> |
| <b>Step 10</b> | <p>mdt data mpls MLDP number_of_data_MDTs</p> <p><b>Example:</b></p> <pre>Router(config-vrf-af)# mdt data mpls MLDP 20</pre>             | <p>Configures the MLDP data MDP.</p>                                                                                                                                                                                                                                                                                                                                                                                                                                                                      |
| <b>Step 11</b> | <p>mdt data threshold bandwidth</p> <p><b>Example:</b></p> <pre>Router(config-vrf-af)# mdt data threshold 1</pre>                        | <p>Configures the threshold value for data MDT.</p> <p><b>Note</b> Bandwidth is traffic rate, in Kbps.</p>                                                                                                                                                                                                                                                                                                                                                                                                |
| <b>Step 12</b> | <p>route-target export route-target-ext-community</p> <p><b>Example:</b></p> <pre>Router(config-vrf-af)# route-target export 200:2</pre> | <p>Creates a route target extended community for a VRF.</p> <ul style="list-style-type: none"> <li>• <b>export</b>—Exports the routing information from the target VPN extended community.</li> <li>• <i>route-target-ext-community</i>—Adds the route target extended community attributes to the VRF list of import, export, or both (import and export) route target extended communities.</li> </ul>                                                                                                  |
| <b>Step 13</b> | <p>route-target import route-target-ext-community</p> <p><b>Example:</b></p> <pre>Router(config-vrf-af)# route-target import 200:2</pre> | <p>Creates a route-target extended community for a VRF.</p> <ul style="list-style-type: none"> <li>• <b>import</b>—Imports the routing information from the target VPN extended community.</li> <li>• <i>route-target-ext-community</i>—Adds the route target extended community attributes to the VRF list of</li> </ul>                                                                                                                                                                                 |

|                | Command or Action                                                                                                    | Purpose                                                                                                                                                                                                                                                                                                                                                                                                                                                                                                                                                                                          |
|----------------|----------------------------------------------------------------------------------------------------------------------|--------------------------------------------------------------------------------------------------------------------------------------------------------------------------------------------------------------------------------------------------------------------------------------------------------------------------------------------------------------------------------------------------------------------------------------------------------------------------------------------------------------------------------------------------------------------------------------------------|
|                |                                                                                                                      | import, export, or both (import and export)<br>route-target extended communities.                                                                                                                                                                                                                                                                                                                                                                                                                                                                                                                |
| <b>Step 14</b> | exit<br><br><b>Example:</b><br><br>Router(config-vrf-af)# exit                                                       | Exits the address family configuration mode.                                                                                                                                                                                                                                                                                                                                                                                                                                                                                                                                                     |
| <b>Step 15</b> | address-family ipv6<br><br><b>Example:</b><br><br>Router(config-vrf)# address-family ipv6                            | Enters the address family configuration mode using standard IP Version 6 (IPv6) address prefixes.                                                                                                                                                                                                                                                                                                                                                                                                                                                                                                |
| <b>Step 16</b> | mdt default mpls MLDP root-node<br><br><b>Example:</b><br><br>Router(config-vrf-af)# mdt default mpls MLDP 192.0.2.1 | Configures MLDP MDT for a VRF.<br><br>root-node—The root node can be IP address of a loopback or physical interface on any router (source PE, receiver PE, or core router) in the provider network. The root node address should be accessible to all the routers in the network. The router from where signalling occurs functions as the root node.<br><br>The default MDT must be configured on each PE router to enable the PE routers to receive multicast traffic for this particular MVRF.<br><br><b>Note</b> Creates the LSPVIF tunnel with the mdt default mpls MLDP root-node command. |
| <b>Step 17</b> | mdt default mpls MLDP root-node<br><br><b>Example:</b><br><br>Router(config-vrf-af)# mdt default mpls MLDP 1.1.1.2   | Configures Root Node Redundancy.<br><br>root-node—The root node can be IP address of a loopback or physical interface on any router (source PE, receiver PE, or core router) in the provider network. The root node address should be accessible to all the routers in the network. The router from where signalling occurs functions as the root node.<br><br>The default MDT must be configured on each PE router to enable the PE routers to receive multicast traffic for this particular MVRF.                                                                                              |
| <b>Step 18</b> | mdt data mpls MLDP number_of_data_MDTs<br><br><b>Example:</b><br><br>Router(config-vrf-af)# mdt data mpls MLDP 20    | Configures the MLDP data MDP.                                                                                                                                                                                                                                                                                                                                                                                                                                                                                                                                                                    |
| <b>Step 19</b> | mdt data threshold bandwidth<br><br><b>Example:</b><br><br>Router(config-vrf-af)# mdt data threshold 1               | Configures the threshold value for data MDT.<br><br><b>Note</b> Bandwidth is traffic rate, in Kbps.                                                                                                                                                                                                                                                                                                                                                                                                                                                                                              |

|                | Command or Action                                                                                                                        | Purpose                                                                                                                                                                                                                                                                                                                                                                                                  |
|----------------|------------------------------------------------------------------------------------------------------------------------------------------|----------------------------------------------------------------------------------------------------------------------------------------------------------------------------------------------------------------------------------------------------------------------------------------------------------------------------------------------------------------------------------------------------------|
| <b>Step 20</b> | <p>route-target export route-target-ext-community</p> <p><b>Example:</b></p> <pre>Router(config-vrf-af)# route-target export 200:2</pre> | <p>Creates a route target extended community for a VRF.</p> <ul style="list-style-type: none"> <li>• <b>export</b>—Exports the routing information from the target VPN extended community.</li> <li>• <i>route-target-ext-community</i>—Adds the route target extended community attributes to the VRF list of import, export, or both (import and export) route target extended communities.</li> </ul> |
| <b>Step 21</b> | <p>route-target import route-target-ext-community</p> <p><b>Example:</b></p> <pre>Router(config-vrf-af)# route-target import 200:2</pre> | <p>Creates a route-target extended community for a VRF.</p> <ul style="list-style-type: none"> <li>• <b>import</b>—Imports the routing information from the target VPN extended community.</li> <li>• <i>route-target-ext-community</i>—Adds the route target extended community attributes to the VRF list of import, export, or both (import and export) route-target extended communities.</li> </ul> |
| <b>Step 22</b> | <p>exit</p> <p><b>Example:</b></p> <pre>Router(config-vrf-af)# exit</pre>                                                                | Exits the address family configuration mode.                                                                                                                                                                                                                                                                                                                                                             |
| <b>Step 23</b> | <p>exit</p> <p><b>Example:</b></p> <pre>Router(config-if)# exit</pre>                                                                    | Exits the interface configuration mode.                                                                                                                                                                                                                                                                                                                                                                  |
| <b>Step 24</b> | <p>interface name</p> <p><b>Example:</b></p> <pre>Router(config)# interface gi0/0/0</pre>                                                | Specifies the interface name and enters the interface configuration mode.                                                                                                                                                                                                                                                                                                                                |
| <b>Step 25</b> | <p>vrf forwarding <i>vrf-name</i></p> <p><b>Example:</b></p> <pre>Router(config-if)# vrf forwarding blue</pre>                           | <p>Associates a VRF instance with an interface or subinterface.</p> <ul style="list-style-type: none"> <li>• <i>vrf-name</i>—Name assigned to a VRF.</li> </ul>                                                                                                                                                                                                                                          |
| <b>Step 26</b> | <p>ip address ip-address subnet-mask</p> <p><b>Example:</b></p> <pre>Router(config-if)# ip address 30.2.0.1 255.255.255.0</pre>          | Specifies the interface IPv4 address and subnet-mask.                                                                                                                                                                                                                                                                                                                                                    |
| <b>Step 27</b> | <p>ip pim sparse-mode</p> <p><b>Example:</b></p>                                                                                         | Enables sparse mode.                                                                                                                                                                                                                                                                                                                                                                                     |

## Example: Configuring MVPN MLDP over GRE

|                | Command or Action                                                                                                                    | Purpose                                                               |
|----------------|--------------------------------------------------------------------------------------------------------------------------------------|-----------------------------------------------------------------------|
|                | Router(config-if)# ip pim sparse-mode                                                                                                |                                                                       |
| <b>Step 28</b> | <b>ipv6 address</b> ipv6-address<br><b>Example:</b><br>Router(config-if)# ipv6 address 32002:30:2::1/64                              | Specifies the interface IPv6 address.                                 |
| <b>Step 29</b> | <b>ospfv3100 ipv6 area 0</b>                                                                                                         | Enables OSPFv3 router configuration mode for the IPv6 address family. |
| <b>Step 30</b> | end<br><b>Example:</b><br>Router(config)# end                                                                                        | Ends the configuration session.                                       |
| <b>Step 31</b> | <b>ip multicast-routing vrf vrf-name distributed</b><br><b>Example:</b><br>Router(config)# ip multicast-routing vrf blue distributed | Enables multicast routing for the specified VRF.                      |
| <b>Step 32</b> | <b>ipv6 multicast-routing vrf vrf-name</b><br><b>Example:</b><br>Router(config)# ipv6 multicast-routing vrf blue                     | Enables IPv6 multicast routing for the specified VRF.                 |
| <b>Step 33</b> | exit<br><b>Example:</b><br>Router(config-if)# exit                                                                                   | Exits the interface configuration mode.                               |
| <b>Step 34</b> | end<br><b>Example:</b><br>Router(config)# end                                                                                        | Ends the configuration session.                                       |

## Example: Configuring MVPN MLDP over GRE

The following example shows how to configure MVPN MLDP over GRE:

```
Router> enable
Router# configure terminal
Router(config)# mpls MLDP
Router(config)# vrf definition blue
Router(config-vrf)# rd 200:2
Router(config-vrf)# vpn id 200:2
Router(config-vrf)# address-family ipv4
Router(config-vrf-af)# mdt default mpls MLDP 192.0.2.1
Router(config-vrf-af)# mdt default mpls MLDP 192.0.2.2
Router(config-vrf-af)# mdt data mpls MLDP 20
```

```

Router(config-vrf-af)# mdt data threshold 1
Router(config-vrf-af)# route-target export 200:2
Router(config-vrf-af)# route-target import 200:2
Router(config-vrf-af)# exit
Router(config-vrf)# address-family ipv6
Router(config-vrf-af)# mdt default mpls MLDP 192.0.2.1
Router(config-vrf-af)# mdt default mpls MLDP 192.0.2.2
Router(config-vrf-af)# mdt data mpls MLDP 20
Router(config-vrf-af)# mdt data threshold 1
Router(config-vrf-af)# route-target export 200:2
Router(config-vrf-af)# route-target import 200:2
Router(config-vrf-af)# exit
Router(config-if)# exit
Router(config)# interface gi0/0/0
Router(config-if)# vrf forwarding blue
Router(config-if)# ip address 30.2.0.1 255.255.255.0
Router(config-if)# ip pim sparse-mode
Router(config-if)# ipv6 address 32002:30:2::1/64
Router(config-if)# ospfv3 100 ipv6 area 0
Router(config)# end
Router(config)# ip multicast-routing vrf blue distributed
Router(config)# ipv6 multicast-routing vrf blue
Router(config-if)# exit
Router(config)# end

```

The following example shows how to configure MVPNv4 MLDP over GRE on router PE1:

```

Router# enable
Router# configure terminal
Router(config)# vrf definition VRF_blue
Router(config-vrf)# rd 1:1
Router(config-vrf)# vpn id 1:1
Router(config-vrf)# address-family ipv4
Router(config-vrf-af)# mdt default mpls mldp 192.0.2.1
Router(config-vrf-af)# mdt data mpls mldp 100
Router(config-vrf-af)# mdt data threshold 4000000
Router(config-vrf-af)# route-target export 1:1
Router(config-vrf-af)# route-target import 1:1
Router(config-vrf-af)# exit
Router(config-vrf)# exit
Router(config)# ip multicast-routing vrf blue distributed
Router(config)# interface Loopback 0
Router(config-if)# ip address 192.0.2.1 255.255.255.0
Router(config-if)# exit
Router(config)# interface Loopback 1
Router(config-if)# vrf forwarding blue
Router(config-if)# ip address 192.0.100.1 255.255.255.0
Router(config-if)# ip pim sparse-mode
Router(config-if)# exit
Router(config)# interface GigabitEthernet 0/0/0
Router(config-if)# ip address 10.0.0.21 255.255.255.0
Router(config-if)# exit
Router(config)# interface Tunnel 100
Router(config-if)# ip address 10.0.0.1 255.255.255.0
Router(config-if)# mpls ip
Router(config-if)# tunnel source 10.0.0.21
Router(config-if)# tunnel destination 10.0.0.22
Router(config-if)# exit
Router(config-if)# end

```

The following example shows how to configure MVPNv4 MLDP over GRE on router PE2:

```

Router# enable

```

## Example: Configuring MVPN MLDP over GRE

```

Router# configure terminal
Router(config)# vrf definition VRF_blue
Router(config-vrf)# rd 1:1
Router(config-vrf)# vpn id 1:1
Router(config-vrf)# address-family ipv4
Router(config-vrf-af)# mdt default mpls mldp 192.0.2.1
Router(config-vrf-af)# mdt data mpls mldp 100
Router(config-vrf-af)# mdt data threshold 1000
Router(config-vrf-af)# route-target export 1:1
Router(config-vrf-af)# route-target import 1:1
Router(config-vrf-af)# exit
Router(config-vrf)# exit
Router(config)# ip multicast-routing vrf blue distributed
Router(config)# interface Loopback 0
Router(config-if)# ip address 192.0.2.2 255.255.255.0
Router(config-if)# exit
Router(config)# interface Loopback 1
Router(config-if)# vrf forwarding blue
Router(config-if)# ip address 192.0.100.20 255.255.255.0
Router(config-if)# ip pim sparse-mode
Router(config-if)# exit
Router(config)# interface GigabitEthernet 0/0/0
Router(config-if)# ip address 10.0.0.22 255.255.255.0
Router(config-if)# exit
Router(config)# interface Tunnel 100
Router(config-if)# ip address 10.0.0.5 255.255.255.0
Router(config-if)# mpls ip
Router(config-if)# tunnel source 10.0.0.22
Router(config-if)# tunnel destination 10.0.0.21
Router(config-if)# exit
Router(config-if)# end

```

- To display the IPv6 neighbor information, use the **show ipv6 pim vrf vrf-name neighbor** command:

```

Router# show ipv6 pim vrf vrf blue neighbor
PIM Neighbor Table
Mode: B - Bidir Capable, G - GenID Capable
Neighbor Address Interface Uptime Expires Mode DR pri
::FFFF:192.0.2.1 Lspvif 3w0d 00:01:17 B G 1

```

Here, 192.0.2.1 is the loopback IP address of another PE on the other end of GRE tunnel, and ::FFFF:x.x.x.x is IPv4-mapped IPv6 IP address.

- To display the IPv4 neighbor information, use the **show ip pim vrf vrf-name neighbor** command:

```

Router# show ip pim vrf blue neighbor
PIM Neighbor Table
Mode: B - Bidir Capable, DR - Designated Router, N - Default DR Priority,
 P - Proxy Capable, S - State Refresh Capable, G - GenID Capable
Neighbor Interface Uptime/Expires Ver DR
Address
30.2.0.3 Gi0/0/1.3900 2w0d/00:01:37 v2 0 / G
192.0.2.1 Lspvif 7w0d/00:01:18 v2 1 / B S P G

```

- To display the IPv6 multicast routing table, use the **show ipv mroute vrf vrf-name** command:

```

Router# show ipv mroute vrf vrf blue
Multicast Routing Table
Flags: D - Dense, S - Sparse, B - Bidir Group, s - SSM Group,
 C - Connected, L - Local, I - Received Source Specific Host Report,
 P - Pruned, R - RP-bit set, F - Register flag, T - SPT-bit set,

```

```

 J - Join SPT, Y - Joined MDT-data group,
 y - Sending to MDT-data group
 g - BGP signal originated, G - BGP Signal received,
 n - BGP Shared-Tree Prune received, n - BGP C-Mroute suppressed,
 q - BGP Src-Active originated, Q - BGP Src-Active received
 E - Extranet
Timers: Uptime/Expires
Interface state: Interface, State
(2002:30::100, FF33:0:3::4000:1), 00:01:06/00:02:53, flags: sT
 Incoming interface: Lspvif1
 RPF nbr: ::FFFF:192.0.2.2
 Immediate Outgoing interface list:
 GigabitEthernet0/0/1.3900, Forward, 00:01:06/00:02:53

```

- To display the IPv4 multicast routing table, use the **show ip mroute vrf-name** command:

```

Router# show ip mroute vrf blue
IP Multicast Routing Table
Flags: D - Dense, S - Sparse, B - Bidir Group, s - SSM Group, C - Connected,
 L - Local, P - Pruned, R - RP-bit set, F - Register flag,
 T - SPT-bit set, J - Join SPT, M - MSDP created entry, E - Extranet,
 X - Proxy Join Timer Running, A - Candidate for MSDP Advertisement,
 U - URD, I - Received Source Specific Host Report,
 Z - Multicast Tunnel, z - MDT-data group sender,
 Y - Joined MDT-data group, y - Sending to MDT-data group,
 G - Received BGP C-Mroute, g - Sent BGP C-Mroute,
 N - Received BGP Shared-Tree Prune, n - BGP C-Mroute suppressed,
 Q - Received BGP S-A Route, q - Sent BGP S-A Route,
 V - RD & Vector, v - Vector, p - PIM Joins on route,
 x - VxLAN group
Outgoing interface flags: H - Hardware switched, A - Assert winner, p - PIM Join
Timers: Uptime/Expires
Interface state: Interface, Next-Hop or VCD, State/Mode
(30.0.0.100, 232.0.0.1), 1w0d/00:01:47, flags: sT
 Incoming interface: Null, RPF nbr 192.0.2.1
 Outgoing interface list:
 Gi0/0/1.3900, Forward/Sparse, 1w0d/00:01:47

```

- To display the multicast routing counter for IPv6, use the **show ipv6 mroute vrf vrf-name counter** command:

```

Router# show ipv6 mroute vrf vrf blue counter
Forwarding Counts: Pkt Count/Pkts per second/Avg Pkt Size/Kilobits per second
Other counts: Total/RPF failed/Other drops(OIF-null, rate-limit etc)
VRF vrf blue
 5057 routes, 11 (*,G)s, 46 (*,G/m)s
Group: FF00::/8
 RP-tree,
 SW Forwarding: 0/0/0/0, Other: 0/0/0
 HW Forwarding: NA/NA/NA/NA, Other: NA/NA/NA
Group: FF00::/15
 RP-tree,
 SW Forwarding: 0/0/0/0, Other: 0/0/0
 HW Forwarding: NA/NA/NA/NA, Other: NA/NA/NA
Group: FF02::/16
 RP-tree,
 SW Forwarding: 0/0/0/0, Other: 3/3/0
Group: FF10::/15
 RP-tree,
 SW Forwarding: 0/0/0/0, Other: 0/0/0
 HW Forwarding: NA/NA/NA/NA, Other: NA/NA/NA
Group: FF12::/16

```

```

RP-tree,
 SW Forwarding: 0/0/0/0, Other: 0/0/0
Group: FF20::/15
RP-tree,
 SW Forwarding: 0/0/0/0, Other: 0/0/0
 HW Forwarding: NA/NA/NA/NA, Other: NA/NA/NA
Group: FF22::/16
RP-tree,
 SW Forwarding: 0/0/0/0, Other: 0/0/0
Group: FF30::/15
RP-tree,
 SW Forwarding: 0/0/0/0, Other: 0/0/0
 HW Forwarding: NA/NA/NA/NA, Other: NA/NA/NA
Group: FF32::/16
RP-tree,
 SW Forwarding: 0/0/0/0, Other: 0/0/0
Group: FF33::/32
RP-tree,
 SW Forwarding: 0/0/0/0, Other: 0/0/0
 HW Forwarding: NA/NA/NA/NA, Other: NA/NA/NA
to this, all of these are default entries in IPv6 Mroute table
Group: FF33:0:3::4000:1
----- from this entry, all entries below are user entries learnt via PIM6 or MLD protocol

Source: 2002:30::100,
 SW Forwarding: 0/0/0/0, Other: 0/0/0
 HW Forwarding: NA/NA/NA/NA, Other: NA/NA/NA
----- from the first entry

```

- To display the multicast routing counter for IPv4, use the **show ip mroute vrf vrf-name counter** command:

```

Router# show ip mroute vrf blue counter
Use "show ip mfib count" to get better response time for a large number of mroutes.
IP Multicast Statistics
5001 routes using 3706920 bytes of memory
101 groups, 49.50 average sources per group
Forwarding Counts: Pkt Count/Pkts per second/Avg Pkt Size/Kilobits per second
Other counts: Total/RPF failed/Other drops(OIF-null, rate-limit etc)
Group: 232.0.0.1, Source count: 50, Packets forwarded: 0, Packets received: 0
Source: 30.0.0.149/32, Forwarding: 0/0/0/0, Other: 0/0/0

```

- To display the MPLS information, use the **show mpls forwarding-table labels <local label> detail** command:

```

Router# show mpls forwarding-table labels 10333 detail
Local Outgoing Prefix Bytes Label Outgoing Next Hop
Label Label or Tunnel Id Switched interface
10333 No Label [mdt 200:1 0][V] 0 aggregate/vrf-name
 MAC/Encaps=0/0, MRU=0, Label Stack{}, via Ls1
 VPN route: vrf blue
 No output feature configured
 Broadcast
Router# show mpls forwarding-table labels
1715
detail
Local Outgoing Prefix Bytes Label Outgoing Next Hop
Label Label or Tunnel Id Switched interface
1715 No Label [mdt 200:1 0][V] 0 aggregate/vpn200
 MAC/Encaps=0/0, MRU=0, Label Stack{}, via Ls1
 VPN route: vpn200
 No output feature configured
 Broadcast

```



- To display the MFIB table, use the **show mfib <vrf\_name> verbose** command:

```

Router# show ip mfib vrf blue verbose
Entry Flags: C - Directly Connected, S - Signal, IA - Inherit A flag,
 ET - Data Rate Exceeds Threshold, K - Keepalive
 DDE - Data Driven Event, HW - Hardware Installed
 ME - MoFRR ECMP entry, MNE - MoFRR Non-ECMP entry, MP - MFIB
 MoFRR Primary, RP - MRIB MoFRR Primary, P - MoFRR Primary
 MS - MoFRR Entry in Sync, MC - MoFRR entry in MoFRR Client.
I/O Item Flags: IC - Internal Copy, NP - Not platform switched,
 NS - Negate Signalling, SP - Signal Present,
 A - Accept, F - Forward, RA - MRIB Accept, RF - MRIB Forward,
 MA - MFIB Accept, A2 - Accept backup,
 RA2 - MRIB Accept backup, MA2 - MFIB Accept backup
Forwarding Counts: Pkt Count/Pkts per second/Avg Pkt Size/Kbits per second
Other counts: Total/RPF failed/Other drops
I/O Item Counts: FS Pkt Count/PS Pkt Count
VRF vpn200
(*,224.0.0.0/4) Flags: K HW
 0x9A2 OIF-IC count: 0, OIF-A count: 0
 SW Forwarding: 0/0/0/0, Other: 0/0/0
 HW Forwarding: NA/NA/NA/NA, Other: NA/NA/NA
(*,224.0.1.40) Flags: C K HW
 0x9A4 OIF-IC count: 1, OIF-A count: 0
 SW Forwarding: 0/0/0/0, Other: 0/0/0
 HW Forwarding: NA/NA/NA/NA, Other: NA/NA/NA
Loopback200 Flags: RF F IC NS
 CEF: Special OCE (discard)
 Pkts: 0/0
(*,232.0.0.0/8) Flags: K HW
 0x9A3 OIF-IC count: 0, OIF-A count: 0
 SW Forwarding: 0/0/0/0, Other: 0/0/0
 HW Forwarding: NA/NA/NA/NA, Other: NA/NA/NA
(30.0.0.100,232.0.0.1) Flags: K HW
 0x5C98 OIF-IC count: 0, OIF-A count: 0
 SW Forwarding: 0/0/0/0, Other: 0/0/0
 HW Forwarding: NA/NA/NA/NA, Other: NA/NA/NA
GigabitEthernet0/0/1.3900 Flags: RF F NS
 CEF: Adjacency with MAC: 01005E000001503DE5974F0181000F3C0800
 Pkts: 0/0

```





## CHAPTER 25

# Tracing and Trace Management

---

This chapter contains the following sections:

- [Tracing Overview, on page 621](#)
- [How Tracing Works, on page 621](#)
- [Tracing Levels, on page 622](#)
- [Viewing a Tracing Level, on page 623](#)
- [Setting a Tracing Level, on page 624](#)
- [Viewing the Content of the Trace Buffer, on page 625](#)

## Tracing Overview

Tracing is a function that logs internal events. Trace files are automatically created and saved to the tracelogs directory on the harddisk: file system on all Cisco ASR 1000 Series Routers except the Cisco ASR 1002 Router, which stores tracing files in bootflash:. Trace files are used to store tracing data.

The contents of trace files are useful for the following purposes:

- **Troubleshooting**—If a Cisco ASR 1000 Series Router is having an issue, the trace file output may provide information that is useful for locating and solving the problem.
- **Debugging**—The trace file outputs can help users get a more detailed view of system actions and operations.

## How Tracing Works

The tracing function logs the contents of internal events on the Cisco ASR 1000 Series Routers. Trace files with all trace output for a module are periodically created and updated and are stored in the tracelog directory. Trace files can be erased from this directory to recover space on the file system without impacting system performance.

The most recent trace information for a specific module can be viewed using the **show platform software trace message** command in privileged EXEC mode.

Trace files can be copied to other destinations using most file transfer functions (such as FTP, TFTP, and so on) and opened using a plaintext editor.

Tracing cannot be disabled on the Cisco ASR 1000 Series Router. Trace levels, however, which set the message types that generate trace output, are user-configurable and can be set using the **platform trace** commands. If

a user wants to modify the trace level to increase or decrease the amount of trace message output, the user should set a new tracing level using the **platform trace** commands. Trace levels can be set by process using the **all-modules** keyword within the **platform trace** commands, or by module within a process. See the **platform trace** command reference for more information on this command.

## Tracing Levels

Tracing levels determine how much information about a module should be stored in the trace buffer or file. shows all of the trace levels that are available and provides descriptions of what types of messages are displayed with each tracing level.

**Table 47: Tracing Levels and Descriptions**

| Trace Level   | Level Number | Description                                                                                                                                                                                                                                                                             |
|---------------|--------------|-----------------------------------------------------------------------------------------------------------------------------------------------------------------------------------------------------------------------------------------------------------------------------------------|
| Emergency     | 0            | The message is regarding an issue that makes the system unusable.                                                                                                                                                                                                                       |
| Alert         | 1            | The message is regarding an action that must be taken immediately.                                                                                                                                                                                                                      |
| Critical      | 2            | The message is regarding a critical condition. This is the default setting for every module on the Cisco ASR 1000 Series Routers.                                                                                                                                                       |
| Error         | 3            | The message is regarding a system error.                                                                                                                                                                                                                                                |
| Warning       | 4            | The message is regarding a system warning                                                                                                                                                                                                                                               |
| Notice        | 5            | The message is regarding a significant issue, but the router is still working normally.                                                                                                                                                                                                 |
| Informational | 6            | The message is useful for informational purposes only.                                                                                                                                                                                                                                  |
| Debug         | 7            | The message provides debug-level output.                                                                                                                                                                                                                                                |
| Verbose       | 8            | All possible tracing messages are sent.                                                                                                                                                                                                                                                 |
| Noise         | -            | All possible trace messages for the module are logged.<br><br>The noise level is always equal to the highest possible tracing level. Even if a future enhancement to tracing introduces a higher tracing level, the noise level will become equal to the level of that new enhancement. |

Trace level settings are leveled, meaning that every setting will contain all messages from the lower setting plus the messages from its own setting. For instance, setting the trace level to 3(error) ensures that the trace file will contain all output for the 0 (emergencies), 1 (alerts), 2 (critical), and 3 (error) settings. Setting the trace level to 4 (warning) will ensure that all trace output for the specific module will be included in that trace file.

The default tracing level for every module on the Cisco ASR 1000 Series Router is notice.

All trace levels are not user-configurable. Specifically, the alert, critical, and notice tracing levels cannot be set by users. If you wish to trace these messages, set the trace level to a higher level that will collect these messages.

When setting trace levels, it is also important to remember that the setting is not done in a configuration mode, so trace level settings are returned to their defaults after every router reload.



**Caution** Setting tracing of a module to the debug level or higher can have a negative performance impact. Setting tracing to this level or higher should be done with discretion.



**Caution** Setting a large number of modules to high tracing levels can severely degrade performance. If a high level of tracing is needed in a specific context, it is almost always preferable to set a single module on a higher tracing level rather than setting multiple modules to high tracing levels.

## Viewing a Tracing Level

By default, all modules on the Cisco ASR 1000 Series Routers are set to notice. This setting will be maintained unless changed by a user.

To see the tracing level for any module on the Cisco ASR 1000 Series Routers, enter the **show platform software trace level** command in privileged EXEC mode.

In the following example, the **show platform software trace level** command is used to view the tracing levels of the Forwarding Manager processes on the active RP:

```
Router# show platform software trace level forwarding-manager rp active
Module Name Trace Level

acl Notice
binos Notice
binos/brand Notice
bipc Notice
bsignal Notice
btrace Notice
cce Notice
cdllib Notice
cef Notice
chasfs Notice
chasutil Notice
erspan Notice
ess Notice
ether-channel Notice
evlib Notice
evutil Notice
file_alloc Notice
fman_rp Notice
fpm Notice
fw Notice
icmp Notice
interfaces Notice
iosd Notice
ipc Notice
ipclog Notice
iphc Notice
ipsec Notice
mgmte-acl Notice
mlp Notice
```

|                            |        |
|----------------------------|--------|
| mqipc                      | Notice |
| nat                        | Notice |
| nbar                       | Notice |
| netflow                    | Notice |
| om                         | Notice |
| peer                       | Notice |
| qos                        | Notice |
| route-map                  | Notice |
| sbc                        | Notice |
| services                   | Notice |
| sw_wdog                    | Notice |
| tcl_acl_config_type        | Notice |
| tcl_acl_db_type            | Notice |
| tcl_cdlcore_message        | Notice |
| tcl_cef_config_common_type | Notice |
| tcl_cef_config_type        | Notice |
| tcl_dpibd_config_type      | Notice |
| tcl_fman_rp_comm_type      | Notice |
| tcl_fman_rp_message        | Notice |
| tcl_fw_config_type         | Notice |
| tcl_hapi_tcl_type          | Notice |
| tcl_icmp_type              | Notice |
| tcl_ip_options_type        | Notice |
| tcl_ipc_ack_type           | Notice |
| tcl_ipsec_db_type          | Notice |
| tcl_mcp_comm_type          | Notice |
| tcl_mlp_config_type        | Notice |
| tcl_mlp_db_type            | Notice |
| tcl_om_type                | Notice |
| tcl_ui_message             | Notice |
| tcl_ui_type                | Notice |
| tcl_urpf_config_type       | Notice |
| tdllib                     | Notice |
| trans_avl                  | Notice |
| uihandler                  | Notice |
| uipeer                     | Notice |
| uistatus                   | Notice |
| urpf                       | Notice |
| vista                      | Notice |
| wccp                       | Notice |

## Setting a Tracing Level

To set a tracing level for any module on the Cisco ASR 1000 Series Routers, or for all modules within a process on the Cisco ASR 1000 Series Router, enter the **platform software trace** command in privileged EXEC mode.

In the following example, the trace level for the forwarding processor module in the Forwarding Manager of the ESP processor in slot 0 is set to the informational tracing level (info):

```
Router(config)# platform trace runtime slot F0 bay 0 process forwarding-manager module
interfaces level info
```

In the following example, the trace level for the forwarding processor module in the Forwarding Manager of the ESP processor in slot R0 is set to the informational tracing level (max):

```
Router(config)# platform trace boottime slot R0 bay 1 process forwarding-manager
forwarding-manager level max
```

See the **platform trace boottime process forwarding-manager moduleinterfaces** and **platform trace runtime process forwarding-manager moduleinterfaces** command reference for additional information about the options for this command.

## Viewing the Content of the Trace Buffer

To view the trace messages in the trace buffer or file, enter the **show platform software trace message** command in privileged EXEC mode.

In the following example, the trace messages for the Host Manager process in Route Processor slot 0 are viewed using the **show platform software trace message** command:

```
Router# show platform software trace message host-manager R0
08/23 12:09:14.408 [uipeer]: (info): Looking for a ui_req msg
08/23 12:09:14.408 [uipeer]: (info): Start of request handling for con 0x100a61c8
08/23 12:09:14.399 [uipeer]: (info): Accepted connection for 14 as 0x100a61c8
08/23 12:09:14.399 [uipeer]: (info): Received new connection 0x100a61c8 on descriptor 14
08/23 12:09:14.398 [uipeer]: (info): Accepting command connection on listen fd 7
08/23 11:53:57.440 [uipeer]: (info): Going to send a status update to the shell manager in
slot 0
08/23 11:53:47.417 [uipeer]: (info): Going to send a status update to the shell manager in
slot 0
```







# CHAPTER 26

## Packet Trace

First Published: August 03, 2016

The Packet-Trace feature provides a detailed understanding of how data packets are processed by the Cisco IOS XE platform, and thus helps customers to diagnose issues and troubleshoot them more efficiently. This module provides information about how to use the Packet-Trace feature.

- [Information About Packet Trace, on page 627](#)
- [Usage Guidelines for Configuring Packet Trace, on page 628](#)
- [Configuring Packet Trace, on page 628](#)
- [Configuring Packet Tracer with UDF Offset , on page 630](#)
- [Displaying Packet-Trace Information, on page 633](#)
- [Removing Packet-Trace Data, on page 634](#)
- [Configuration Examples for Packet Trace , on page 634](#)
- [Additional References, on page 641](#)
- [Feature Information for Packet Trace, on page 642](#)

## Information About Packet Trace

The Packet-Trace feature provides three levels of inspection for packets: accounting, summary, and path data. Each level provides a detailed view of packet processing at the cost of some packet processing capability. However, Packet Trace limits inspection to packets that match the debug platform condition statements, and is a viable option even under heavy-traffic situations in customer environments.

The following table explains the three levels of inspection provided by packet trace.

**Table 48: Packet-Trace Level**

| <b>Packet-Trace Level</b> | <b>Description</b>                                                                                                                                                                                         |
|---------------------------|------------------------------------------------------------------------------------------------------------------------------------------------------------------------------------------------------------|
| Accounting                | Packet-Trace accounting provides a count of packets that enter and leave the network processor. Packet-Trace accounting is a lightweight performance activity, and runs continuously until it is disabled. |

| Packet-Trace Level | Description                                                                                                                                                                                                                                                                                                                                                                                                                                                                                                                                                                                                                                                                                                                                                                                                                                                                                                                                                                                                                    |
|--------------------|--------------------------------------------------------------------------------------------------------------------------------------------------------------------------------------------------------------------------------------------------------------------------------------------------------------------------------------------------------------------------------------------------------------------------------------------------------------------------------------------------------------------------------------------------------------------------------------------------------------------------------------------------------------------------------------------------------------------------------------------------------------------------------------------------------------------------------------------------------------------------------------------------------------------------------------------------------------------------------------------------------------------------------|
| Summary            | At the summary level of packet trace, data is collected for a finite number of packets. Packet-Trace summary tracks the input and output interfaces, the final packet state, and punt, drop, or inject packets, if any. Collecting summary data adds to additional performance compared to normal packet processing, and can help to isolate a troublesome interface.                                                                                                                                                                                                                                                                                                                                                                                                                                                                                                                                                                                                                                                          |
| Path data          | <p>The packet-trace path data level provides the greatest level of detail in packet trace. Data is collected for a finite number of packets. Packet-Trace path data captures data, including a conditional debugging ID that is useful to correlate with feature debugs, a timestamp, and also feature-specific path-trace data.</p> <p>Path data also has two optional capabilities: packet copy and Feature Invocation Array (FIA) trace. The packet-copy option enables you to copy input and output packets at various layers of the packet (layer 2, layer 3 or layer 4). The FIA- trace option tracks every feature entry invoked during packet processing and helps you to know what is happening during packet processing.</p> <p><b>Note</b> Collecting path data consumes more packet-processing resources, and the optional capabilities incrementally affect packet performance. Therefore, path-data level should be used in limited capacity or in situations where packet performance change is acceptable.</p> |

## Usage Guidelines for Configuring Packet Trace

Consider the following best practices while configuring the Packet-Trace feature:

- Use of ingress conditions when using the Packet-Trace feature is recommended for a more comprehensive view of packets.
- Packet-trace configuration requires data-plane memory. On systems where data-plane memory is constrained, carefully consider how you will select the packet-trace values. A close approximation of the amount of memory consumed by packet trace is provided by the following equation:

memory required = (statistics overhead) + number of packets \* (summary size + data size + packet copy size).

When the Packet-Trace feature is enabled, a small, fixed amount of memory is allocated for statistics. Similarly, when per-packet data is captured, a small, fixed amount of memory is required for each packet for summary data. However, as shown by the equation, you can significantly influence the amount of memory consumed by the number of packets you select to trace, and whether you collect path data and copies of packets.

## Configuring Packet Trace

Perform the following steps to configure the Packet-Trace feature.



**Note** The amount of memory consumed by the Packet-Trace feature is affected by the packet-trace configuration. You should carefully select the size of per-packet path data and copy buffers and the number of packets to be traced in order to avoid interrupting normal services. You can check the current data-plane DRAM memory consumption by using the **show platform hardware qfp active infrastructure exmem statistics** command.

## SUMMARY STEPS

1. **enable**
2. **debug platform packet-trace packet** *pkt-num* [**fia-trace** | **summary-only**] [**circular**] [**data-size** *data-size*]
3. **debug platform packet-trace** {**punt** | **inject**|**copy**|**drop**|**packet**|**statistics**}
4. **debug platform condition** [**ipv4** | **ipv6**] [**interface** *interface*][**access-list** *access-list-name* | *ipv4-address / subnet-mask* | *ipv6-address / subnet-mask*] [**ingress** | **egress** |**both**]
5. **debug platform condition start**
6. **debug platform condition stop**
7. **show platform packet-trace** {**configuration** | **statistics** | **summary** | **packet** {**all** | *pkt-num*}}
8. **clear platform condition all**
9. **exit**

## DETAILED STEPS

|        | Command or Action                                                                                                                                                                                                                                            | Purpose                                                                                                                                                                                                                                                                                                                                                                                                                                                                                                                                                                                                                                                                                                                                                                                                                                          |
|--------|--------------------------------------------------------------------------------------------------------------------------------------------------------------------------------------------------------------------------------------------------------------|--------------------------------------------------------------------------------------------------------------------------------------------------------------------------------------------------------------------------------------------------------------------------------------------------------------------------------------------------------------------------------------------------------------------------------------------------------------------------------------------------------------------------------------------------------------------------------------------------------------------------------------------------------------------------------------------------------------------------------------------------------------------------------------------------------------------------------------------------|
| Step 1 | <b>enable</b><br><b>Example:</b><br><pre>Router&gt; enable</pre>                                                                                                                                                                                             | Enables the privileged EXEC mode. Enter your password if prompted.                                                                                                                                                                                                                                                                                                                                                                                                                                                                                                                                                                                                                                                                                                                                                                               |
| Step 2 | <b>debug platform packet-trace packet</b> <i>pkt-num</i> [ <b>fia-trace</b>   <b>summary-only</b> ] [ <b>circular</b> ] [ <b>data-size</b> <i>data-size</i> ]<br><b>Example:</b><br><pre>Router# debug platform packet-trace packets 2048 summary-only</pre> | Collects summary data for a specified number of packets. Captures feature path data by default, and optionally performs FIA trace.<br><i>pkt-num</i> —Specifies the maximum number of packets maintained at a given time.<br><b>fia-trace</b> —Provides detailed level of data capture, including summary data, feature-specific data. Also displays each feature entry visited during packet processing.<br><b>summary-only</b> —Enables the capture of summary data with minimal details.<br><b>circular</b> —Saves the data of the most recently traced packets.<br><i>data-size</i> —Specifies the size of data buffers for storing feature and FIA trace data for each packet in bytes. When very heavy packet processing is performed on packets, users can increase the size of the data buffers if necessary. The default value is 2048. |

|               | Command or Action                                                                                                                                                                                                                                                                | Purpose                                                                                                                                                                                    |
|---------------|----------------------------------------------------------------------------------------------------------------------------------------------------------------------------------------------------------------------------------------------------------------------------------|--------------------------------------------------------------------------------------------------------------------------------------------------------------------------------------------|
| <b>Step 3</b> | <b>debug platform packet-trace {punt  inject copy drop packet statistics}</b><br><b>Example:</b><br><pre>Router# debug platform packet-trace punt</pre>                                                                                                                          | Enables tracing of punted packets from data to control plane.                                                                                                                              |
| <b>Step 4</b> | <b>debug platform condition [ipv4   ipv6] [interface interface][access-list access-list -name   ipv4-address / subnet-mask   ipv6-address / subnet-mask] [ingress   egress  both]</b><br><b>Example:</b><br><pre>Router# debug platform condition interface g0/0/0 ingress</pre> | Specifies the matching criteria for tracing packets. Provides the ability to filter by protocol, IP address and subnet mask, access control list (ACL), interface, and direction.          |
| <b>Step 5</b> | <b>debug platform condition start</b><br><b>Example:</b><br><pre>Router# debug platform condition start</pre>                                                                                                                                                                    | Enables the specified matching criteria and starts packet tracing.                                                                                                                         |
| <b>Step 6</b> | <b>debug platform condition stop</b><br><b>Example:</b><br><pre>Router# debug platform condition start</pre>                                                                                                                                                                     | Deactivates the condition and stops packet tracing.                                                                                                                                        |
| <b>Step 7</b> | <b>show platform packet-trace {configuration   statistics   summary   packet {all   pkt-num}}</b><br><b>Example:</b><br><pre>Router# show platform packet-trace 14</pre>                                                                                                         | Displays packet-trace data according to the specified option. See {start cross reference} Table 21-1 {end cross reference} for detailed information about the <b>show</b> command options. |
| <b>Step 8</b> | <b>clear platform condition all</b><br><b>Example:</b><br><pre>Router(config)# clear platform condition all</pre>                                                                                                                                                                | Removes the configurations provided by the <b>debug platform condition</b> and <b>debug platform packet-trace</b> commands.                                                                |
| <b>Step 9</b> | <b>exit</b><br><b>Example:</b><br><pre>Router# exit</pre>                                                                                                                                                                                                                        | Exits the privileged EXEC mode.                                                                                                                                                            |

## Configuring Packet Tracer with UDF Offset

Perform the following steps to configure the Packet-Trace UDF with offset:

## SUMMARY STEPS

1. **enable**
2. **configure terminal**
3. **udf udf name header {inner | outer} {13|14} offset offset-in-bytes length length-in-bytes**
4. **udf udf name {header | packet-start} offset-base offset length**
5. **ip access-list extended {acl-name acl-num}**
6. **ip access-list extended { deny | permit } udf udf-name value mask**
7. **debug platform condition [ipv4 | ipv6] [ interface interface] [access-list access-list -name | ipv4-address / subnet-mask | ipv6-address / subnet-mask] [ ingress | egress |both ]**
8. **debug platform condition start**
9. **debug platform packet-trace packet pkt-num [ fia-trace | summary-only] [ circular ] [ data-size data-size]**
10. **debug platform packet-trace {punt | inject|copy | drop |packet | statistics}**
11. **debug platform condition stop**
12. **exit**

## DETAILED STEPS

|               | Command or Action                                                                                                                                                                                                                                                                                                                                                                       | Purpose                                                                                                                                                                                                                                                                                                                                                                                                                                                                                                       |
|---------------|-----------------------------------------------------------------------------------------------------------------------------------------------------------------------------------------------------------------------------------------------------------------------------------------------------------------------------------------------------------------------------------------|---------------------------------------------------------------------------------------------------------------------------------------------------------------------------------------------------------------------------------------------------------------------------------------------------------------------------------------------------------------------------------------------------------------------------------------------------------------------------------------------------------------|
| <b>Step 1</b> | <b>enable</b><br><br><b>Example:</b><br><br>Device> enable                                                                                                                                                                                                                                                                                                                              | Enables privileged EXEC mode.<br><br>• Enter your password if prompted.                                                                                                                                                                                                                                                                                                                                                                                                                                       |
| <b>Step 2</b> | <b>configure terminal</b><br><br><b>Example:</b><br><br>Device# configure terminal                                                                                                                                                                                                                                                                                                      | Enters global configuration mode.                                                                                                                                                                                                                                                                                                                                                                                                                                                                             |
| <b>Step 3</b> | <b>udf udf name header {inner   outer} {13 14} offset offset-in-bytes length length-in-bytes</b><br><br><b>Example:</b><br><br>Router(config)# udf TEST_UDF_NAME_1 header inner 13 64 1<br><br>Router(config)# udf TEST_UDF_NAME_2 header inner 14 77 2<br><br>Router(config)# udf TEST_UDF_NAME_3 header outer 13 65 1<br><br>Router(config)# udf TEST_UDF_NAME_4 header outer 14 67 1 | Configures individual UDF definitions. You can specify the name of the UDF, the networking header from which offset, and the length of data to be extracted.<br><br>The <b>inner</b> or <b>outer</b> keywords indicate the start of the offset from the unencapsulated Layer 3 or Layer 4 headers, or if there is an encapsulated packet, they indicate the start of offset from the inner L3/L4.<br><br>The <b>length</b> keyword specifies, in bytes, the length from the offset. The range is from 1 to 2. |
| <b>Step 4</b> | <b>udf udf name {header   packet-start} offset-base offset length</b><br><br><b>Example:</b>                                                                                                                                                                                                                                                                                            | • header—Specifies the offset base configuration.<br><br>• packet-start—Specifies the offset base from packet-start. packet-start” can vary depending on if                                                                                                                                                                                                                                                                                                                                                   |

|               | Command or Action                                                                                                                                                                                                                                                                                                                                                                            | Purpose                                                                                                                                                                                                                                                                                                                                                                                                                                                                                                                                                                                              |
|---------------|----------------------------------------------------------------------------------------------------------------------------------------------------------------------------------------------------------------------------------------------------------------------------------------------------------------------------------------------------------------------------------------------|------------------------------------------------------------------------------------------------------------------------------------------------------------------------------------------------------------------------------------------------------------------------------------------------------------------------------------------------------------------------------------------------------------------------------------------------------------------------------------------------------------------------------------------------------------------------------------------------------|
|               | <pre>Router(config)# udf TEST_UDF_NAME_5 packet-start 120 1</pre>                                                                                                                                                                                                                                                                                                                            | <p>packet-trace is for an inbound packet or outbound packet. If the packet-trace is for an inbound packet then the packet-start will be layer2. For outbound, the packet-start will be layer3.</p> <ul style="list-style-type: none"> <li>• <b>offset</b>—Specifies the number of bytes offset from the offset base. To match the first byte from the offset base (Layer 3/Layer 4 header), configure the offset as 0.</li> <li>• <b>length</b>—Specifies the number of bytes from the offset. Only 1 or 2 bytes are supported. To match additional bytes, you must define multiple UDFs.</li> </ul> |
| <b>Step 5</b> | <p><b>ip access-list extended</b> {<i>acl-name</i> [<i>acl-num</i>]}</p> <p><b>Example:</b></p> <pre>Router(config)# ip access-list extended acl2</pre>                                                                                                                                                                                                                                      | Enables extended ACL configuration mode. The CLI enters the extended ACL configuration mode in which all subsequent commands apply to the current extended access list. Extended ACLs control traffic by the comparison of the source and destination addresses of the IP packets to the addresses configured in the ACL.                                                                                                                                                                                                                                                                            |
| <b>Step 6</b> | <p><b>ip access-list extended</b> { <b>deny</b>   <b>permit</b> } <b>udf</b> <i>udf-name</i> <b>value</b> <b>mask</b></p> <p><b>Example:</b></p> <pre>Router(config-acl)# permit ip any any udf TEST_UDF_NAME_5 0xD3 0xFF</pre>                                                                                                                                                              | Configures the ACL to match on UDFs along with the current access control entries (ACEs). The bytes defined in ACL is 0xD3. Masks are used with IP addresses in IP ACLs to specify what should be permitted and denied.                                                                                                                                                                                                                                                                                                                                                                              |
| <b>Step 7</b> | <p><b>debug platform condition</b> [<b>ipv4</b>   <b>ipv6</b>] [<b>interface</b> <i>interface</i>] [<b>access-list</b> <i>access-list -name</i>   <i>ipv4-address / subnet-mask</i>   <i>ipv6-address / subnet-mask</i>] [<b>ingress</b>   <b>egress</b>   <b>both</b> ]</p> <p><b>Example:</b></p> <pre>Router# debug platform condition interface gi0/0/0 ipv4 access-list acl2 both</pre> | Specifies the matching criteria for tracing packets. Provides the ability to filter by protocol, IP address and subnet mask, access control list (ACL), interface, and direction.                                                                                                                                                                                                                                                                                                                                                                                                                    |
| <b>Step 8</b> | <p><b>debug platform condition start</b></p> <p><b>Example:</b></p> <pre>Router# debug platform condition start</pre>                                                                                                                                                                                                                                                                        | Enables the specified matching criteria and starts packet tracing.                                                                                                                                                                                                                                                                                                                                                                                                                                                                                                                                   |
| <b>Step 9</b> | <p><b>debug platform packet-trace packet</b> <i>pkt-num</i> [<b>fia-trace</b>   <b>summary-only</b>] [<b>circular</b> ] [<b>data-size</b> <i>data-size</i>]</p> <p><b>Example:</b></p> <pre>Router# debug platform packet-trace packet 1024 fia-trace data-size 2048</pre>                                                                                                                   | <p>Collects summary data for a specified number of packets. Captures feature path data by default, and optionally performs FIA trace.</p> <p><i>pkt-num</i>—Specifies the maximum number of packets maintained at a given time.</p> <p><b>fia-trace</b>—Provides detailed level of data capture, including summary data, feature-specific data. Also</p>                                                                                                                                                                                                                                             |

|         | Command or Action                                                                                                                                                     | Purpose                                                                                                                                                                                                                                                                                                                                                                                                                                                                                                              |
|---------|-----------------------------------------------------------------------------------------------------------------------------------------------------------------------|----------------------------------------------------------------------------------------------------------------------------------------------------------------------------------------------------------------------------------------------------------------------------------------------------------------------------------------------------------------------------------------------------------------------------------------------------------------------------------------------------------------------|
|         |                                                                                                                                                                       | <p>displays each feature entry visited during packet processing.</p> <p><b>summary-only</b>—Enables the capture of summary data with minimal details.</p> <p><b>circular</b>—Saves the data of the most recently traced packets.</p> <p><i>data-size</i>—Specifies the size of data buffers for storing feature and FIA trace data for each packet in bytes. When very heavy packet processing is performed on packets, users can increase the size of the data buffers if necessary. The default value is 2048.</p> |
| Step 10 | <p><b>debug platform packet-trace {punt   inject copy   drop  packet   statistics}</b></p> <p><b>Example:</b></p> <pre>Router# debug platform packet-trace punt</pre> | Enables tracing of punted packets from data to control plane.                                                                                                                                                                                                                                                                                                                                                                                                                                                        |
| Step 11 | <p><b>debug platform condition stop</b></p> <p><b>Example:</b></p> <pre>Router# debug platform condition start</pre>                                                  | Deactivates the condition and stops packet tracing.                                                                                                                                                                                                                                                                                                                                                                                                                                                                  |
| Step 12 | <p><b>exit</b></p> <p><b>Example:</b></p> <pre>Router# exit</pre>                                                                                                     | Exits the privileged EXEC mode.                                                                                                                                                                                                                                                                                                                                                                                                                                                                                      |

## Displaying Packet-Trace Information

Use these **show** commands to display packet-trace information.

*Table 49: show Commands*

| Command                                                    | Description                                                                                                                                                         |
|------------------------------------------------------------|---------------------------------------------------------------------------------------------------------------------------------------------------------------------|
| <b>show platform packet-trace configuration</b>            | Displays packet trace configuration, including any defaults.                                                                                                        |
| <b>show platform packet-trace statistics</b>               | Displays accounting data for all the traced packets.                                                                                                                |
| <b>show platform packet-trace summary</b>                  | Displays summary data for the number of packets specified.                                                                                                          |
| <b>show platform packet-trace {all   pkt-num} [decode]</b> | Displays the path data for all the packets or the packet specified. The <b>decode</b> option attempts to decode the binary packet into a more human- readable form. |

## Removing Packet-Trace Data

Use these commands to clear packet-trace data.

*Table 50: clear Commands*

| Command                                          | Description                                               |
|--------------------------------------------------|-----------------------------------------------------------|
| <b>clear platform packet-trace statistics</b>    | Clears the collected packet-trace data and statistics.    |
| <b>clear platform packet-trace configuration</b> | Clears the packet-trace configuration and the statistics. |

## Configuration Examples for Packet Trace

This section provides the following configuration examples:

### Example: Configuring Packet Trace

This example describes how to configure packet trace and display the results. In this example, incoming packets to Gigabit Ethernet interface 0/0/1 are traced, and FIA-trace data is captured for the first 128 packets. Also, the input packets are copied. The **show platform packet-trace packet 0** command displays the summary data and each feature entry visited during packet processing for packet 0.

```

Router>
enable
Router# debug platform packet-trace packet 128 fia-trace
Router# debug platform packet-trace punt
Router# debug platform condition interface g0/0/1 ingress
Router# debug platform condition start
Router#! ping to UUT
Router# debug platform condition stop
Router# show platform packet-trace packet 0
Packet: 0 CBUG ID: 9
Summary
 Input : GigabitEthernet0/0/1
 Output : GigabitEthernet0/0/0
 State : FWD
 Timestamp
 Start : 1819281992118 ns (05/17/2014 06:42:01.207240 UTC)
 Stop : 1819282095121 ns (05/17/2014 06:42:01.207343 UTC)
Path Trace
Feature: IPV4
 Source : 198.51.100.2
 Destination : 198.51.100.2
 Protocol : 1 (ICMP)
Feature: FIA_TRACE
 Entry : 0x8059dbe8 - DEBUG_COND_INPUT_PKT
 Timestamp : 3685243309297
Feature: FIA_TRACE
 Entry : 0x82011a00 - IPV4_INPUT_DST_LOOKUP_CONSUME
 Timestamp : 3685243311450
Feature: FIA_TRACE
 Entry : 0x82000170 - IPV4_INPUT_FOR_US_MARTIAN

```



```

Timestamp : 3685243312427
Feature: FIA_TRACE
Entry : 0x82004b68 - IPV4_OUTPUT_LOOKUP_PROCESS
Timestamp : 3685243313230
Feature: FIA_TRACE
Entry : 0x8034f210 - IPV4_INPUT_IPOPTIONS_PROCESS
Timestamp : 3685243315033
Feature: FIA_TRACE
Entry : 0x82013200 - IPV4_OUTPUT_GOTO_OUTPUT_FEATURE
Timestamp : 3685243315787
Feature: FIA_TRACE
Entry : 0x80321450 - IPV4_VFR_REFRAG
Timestamp : 3685243316980
Feature: FIA_TRACE
Entry : 0x82014700 - IPV6_INPUT_L2_REWRITE
Timestamp : 3685243317713
Feature: FIA_TRACE
Entry : 0x82000080 - IPV4_OUTPUT_FRAG
Timestamp : 3685243319223
Feature: FIA_TRACE
Entry : 0x8200e500 - IPV4_OUTPUT_DROP_POLICY
Timestamp : 3685243319950
Feature: FIA_TRACE
Entry : 0x8059aff4 - PACTRAC_OUTPUT_STATS
Timestamp : 3685243323603
Feature: FIA_TRACE
Entry : 0x82016100 - MARMOT_SPA_D_TRANSMIT_PKT
Timestamp : 3685243326183

```

```

Router# clear platform condition all
Router# exit

```

Linux Forwarding Transport Service (LFTS) is a transport mechanism to forward packets punted from the CPP into applications other than IOSd. This example displays the LFTS-based intercepted packet destined for binos application.

```

Router# show platform packet-trace packet 10
Packet: 10 CBUG ID: 52
Summary
Input : GigabitEthernet0/0/0
Output : internal0/0/rp:1
State : PUNT 55 (For-us control)
Timestamp
Start : 597718358383 ns (06/06/2016 09:00:13.643341 UTC)
Stop : 597718409650 ns (06/06/2016 09:00:13.643392 UTC)
Path Trace
Feature: IPV4
Input : GigabitEthernet0/0/0
Output : <unknown>
Source : 10.64.68.2
Destination : 224.0.0.102
Protocol : 17 (UDP)
SrcPort : 1985
DstPort : 1985
Feature: FIA_TRACE
Input : GigabitEthernet0/0/0
Output : <unknown>
Entry : 0x8a0177bc - DEBUG_COND_INPUT_PKT
Lapsed time : 426 ns
Feature: FIA_TRACE
Input : GigabitEthernet0/0/0
Output : <unknown>
Entry : 0x8a017788 - IPV4_INPUT_DST_LOOKUP_CONSUME
Lapsed time : 386 ns

```

```

Feature: FIA_TRACE
 Input : GigabitEthernet0/0/0
 Output : <unknown>
 Entry : 0x8a01778c - IPV4_INPUT_FOR_US_MARTIAN
 Lapsed time : 13653 ns
Feature: FIA_TRACE
 Input : GigabitEthernet0/0/0
 Output : internal0/0/rp:1
 Entry : 0x8a017730 - IPV4_INPUT_LOOKUP_PROCESS_EXT
 Lapsed time : 2360 ns
Feature: FIA_TRACE
 Input : GigabitEthernet0/0/0
 Output : internal0/0/rp:1
 Entry : 0x8a017be0 - IPV4_INPUT_IPOPTIONS_PROCESS_EXT
 Lapsed time : 66 ns
Feature: FIA_TRACE
 Input : GigabitEthernet0/0/0
 Output : internal0/0/rp:1
 Entry : 0x8a017bfc - IPV4_INPUT_GOTO_OUTPUT_FEATURE_EXT
 Lapsed time : 680 ns
Feature: FIA_TRACE
 Input : GigabitEthernet0/0/0
 Output : internal0/0/rp:1
 Entry : 0x8a017d60 - IPV4_INTERNAL_ARL_SANITY_EXT
 Lapsed time : 320 ns
Feature: FIA_TRACE
 Input : GigabitEthernet0/0/0
 Output : internal0/0/rp:1
 Entry : 0x8a017a40 - IPV4_VFR_REFRAG_EXT
 Lapsed time : 106 ns
Feature: FIA_TRACE
 Input : GigabitEthernet0/0/0
 Output : internal0/0/rp:1
 Entry : 0x8a017d2c - IPV4_OUTPUT_DROP_POLICY_EXT
 Lapsed time : 1173 ns
Feature: FIA_TRACE
 Input : GigabitEthernet0/0/0
 Output : internal0/0/rp:1
 Entry : 0x8a017940 - INTERNAL_TRANSMIT_PKT_EXT
 Lapsed time : 20173 ns
LFTS Path Flow: Packet: 10 CBUG ID: 52
Feature: LFTS
Pkt Direction: IN
Punt Cause : 55
 subCause : 0

```

## Example: Using Packet Trace

This example provides a scenario in which packet trace is used to troubleshoot packet drops for a NAT configuration on a Cisco ASR 1006 Router. This example shows how you can effectively utilize the level of detail provided by the Packet-Trace feature to gather information about an issue, isolate the issue, and then find a solution.

In this scenario, you can detect that there are issues, but are not sure where to start troubleshooting. You should, therefore, consider accessing the Packet-Trace summary for a number of incoming packets.

```

Router# debug platform condition ingress
Router# debug platform packet-trace packet 2048 summary-only
Router# debug platform condition start
Router# debug platform condition stop
Router# show platform packet-trace summary

```

| Pkt | Input                 | Output           | State | Reason                  |
|-----|-----------------------|------------------|-------|-------------------------|
| 0   | Gi0/0/0               | Gi0/0/0          | DROP  | 402 (NoStatsUpdate)     |
| 1   | internal0/0/rp:0      | internal0/0/rp:0 | PUNT  | 21 (RP<->QFP keepalive) |
| 2   | internal0/0/recycle:0 | Gi0/0/0          | FWD   |                         |

The output shows that packets are dropped due to NAT configuration on Gigabit Ethernet interface 0/0/0, which enables you to understand that an issue is occurring on a specific interface. Using this information, you can limit which packets to trace, reduce the number of packets for data capture, and increase the level of inspection.

```

Router# debug platform packet-trace packet 256
Router# debug platform packet-trace punt
Router# debug platform condition interface Gi0/0/0
Router# debug platform condition start
Router# debug platform condition stop
Router# show platform packet-trace summary
Router# show platform packet-trace 15
Packet: 15 CBUG ID: 238
Summary
 Input : GigabitEthernet0/0/0
 Output : internal0/0/rp:1
 State : PUNT 55 (For-us control)
 Timestamp
 Start : 1166288346725 ns (06/06/2016 09:09:42.202734 UTC)
 Stop : 1166288383210 ns (06/06/2016 09:09:42.202770 UTC)
Path Trace
 Feature: IPV4
 Input : GigabitEthernet0/0/0
 Output : <unknown>
 Source : 10.64.68.3
 Destination : 224.0.0.102
 Protocol : 17 (UDP)
 SrcPort : 1985
 DstPort : 1985
IOSd Path Flow: Packet: 15 CBUG ID: 238
 Feature: INFRA
 Pkt Direction: IN
 Packet Rcvd From CPP
 Feature: IP
 Pkt Direction: IN
 Source : 10.64.68.122
 Destination : 10.64.68.255
 Feature: IP
 Pkt Direction: IN
 Packet Enqueued in IP layer
 Source : 10.64.68.122
 Destination : 10.64.68.255
 Interface : GigabitEthernet0/0/0
 Feature: UDP
 Pkt Direction: IN
 src : 10.64.68.122(1053)
 dst : 10.64.68.255(1947)
 length : 48

Router#show platform packet-trace packet 10
Packet: 10 CBUG ID: 10
Summary
 Input : GigabitEthernet0/0/0
 Output : internal0/0/rp:0
 State : PUNT 55 (For-us control)
 Timestamp
 Start : 274777907351 ns (01/10/2020 10:56:47.918494 UTC)
 Stop : 274777922664 ns (01/10/2020 10:56:47.918509 UTC)

```

```

Path Trace
Feature: IPV4 (Input)
 Input : GigabitEthernet0/0/0
 Output : <unknown>
 Source : 10.78.106.2
 Destination : 224.0.0.102
 Protocol : 17 (UDP)
 SrcPort : 1985
 DstPort : 1985

IOSd Path Flow: Packet: 10 CBUG ID: 10
Feature: INFRA
 Pkt Direction: IN
Packet Rcvd From DATAPLANE
Feature: IP
 Pkt Direction: IN
 Packet Enqueued in IP layer
 Source : 10.78.106.2
 Destination : 224.0.0.102
 Interface : GigabitEthernet0/0/0

Feature: UDP
 Pkt Direction: IN DROP
 Pkt : DROPPED
 UDP: Discarding silently
 src : 881 10.78.106.2(1985)
 dst : 224.0.0.102(1985)
 length : 60

Router#show platform packet-trace packet 12
Packet: 12 CBUG ID: 767
Summary
 Input : GigabitEthernet3
 Output : internal0/0/rp:0
 State : PUNT 11 (For-us data)
Timestamp
 Start : 16120990774814 ns (01/20/2020 12:38:02.816435 UTC)
 Stop : 16120990801840 ns (01/20/2020 12:38:02.816462 UTC)
Path Trace
Feature: IPV4 (Input)
 Input : GigabitEthernet3
 Output : <unknown>
 Source : 12.1.1.1
 Destination : 12.1.1.2
 Protocol : 6 (TCP)
 SrcPort : 46593
 DstPort : 23

IOSd Path Flow: Packet: 12 CBUG ID: 767
Feature: INFRA
 Pkt Direction: IN
Packet Rcvd From DATAPLANE

Feature: IP
 Pkt Direction: IN
 Packet Enqueued in IP layer
 Source : 12.1.1.1
 Destination : 12.1.1.2
 Interface : GigabitEthernet3

Feature: IP
 Pkt Direction: IN
 FORWARDEDTo transport layer
 Source : 12.1.1.1
 Destination : 12.1.1.2

```

```
Interface : GigabitEthernet3
```

```
Feature: TCP
```

```
Pkt Direction: IN
```

```
tcp0: I NoTCB 12.1.1.1:46593 12.1.1.2:23 seq 1925377975 OPTS 4 SYN WIN 4128
```

```
Router# show platform packet-trace summary
```

| Pkt | Input | Output           | State | Reason           |
|-----|-------|------------------|-------|------------------|
| 0   | INJ.2 | Gi1              | FWD   |                  |
| 1   | Gi1   | internal0/0/rp:0 | PUNT  | 11 (For-us data) |
| 2   | INJ.2 | Gi1              | FWD   |                  |
| 3   | Gi1   | internal0/0/rp:0 | PUNT  | 11 (For-us data) |
| 4   | INJ.2 | Gi1              | FWD   |                  |
| 5   | INJ.2 | Gi1              | FWD   |                  |
| 6   | Gi1   | internal0/0/rp:0 | PUNT  | 11 (For-us data) |
| 7   | Gi1   | internal0/0/rp:0 | PUNT  | 11 (For-us data) |
| 8   | Gi1   | internal0/0/rp:0 | PUNT  | 11 (For-us data) |
| 9   | Gi1   | internal0/0/rp:0 | PUNT  | 11 (For-us data) |
| 10  | INJ.2 | Gi1              | FWD   |                  |
| 11  | INJ.2 | Gi1              | FWD   |                  |
| 12  | INJ.2 | Gi1              | FWD   |                  |
| 13  | Gi1   | internal0/0/rp:0 | PUNT  | 11 (For-us data) |
| 14  | Gi1   | internal0/0/rp:0 | PUNT  | 11 (For-us data) |
| 15  | Gi1   | internal0/0/rp:0 | PUNT  | 11 (For-us data) |
| 16  | INJ.2 | Gi1              | FWD   |                  |

The following example displays the packet trace data statistics.

```
Router#show platform packet-trace statistics
```

```
Packets Summary
```

```
 Matched 3
```

```
 Traced 3
```

```
Packets Received
```

```
 Ingress 0
```

```
 Inject 0
```

```
Packets Processed
```

```
 Forward 0
```

```
 Punt 3
```

| Count | Code | Cause                      |
|-------|------|----------------------------|
| 3     | 56   | RP injected for-us control |

```
 Drop 0
```

```
 Consume 0
```

|       | PKT_DIR_IN |          |           |
|-------|------------|----------|-----------|
|       | Dropped    | Consumed | Forwarded |
| INFRA | 0          | 0        | 0         |
| TCP   | 0          | 0        | 0         |
| UDP   | 0          | 0        | 0         |
| IP    | 0          | 0        | 0         |
| IPV6  | 0          | 0        | 0         |
| ARP   | 0          | 0        | 0         |

|       | PKT_DIR_OUT |          |           |
|-------|-------------|----------|-----------|
|       | Dropped     | Consumed | Forwarded |
| INFRA | 0           | 0        | 0         |
| TCP   | 0           | 0        | 0         |
| UDP   | 0           | 0        | 0         |
| IP    | 0           | 0        | 0         |
| IPV6  | 0           | 0        | 0         |
| ARP   | 0           | 0        | 0         |

The following example displays packets that are injected and punted to the forwarding processor from the control plane.

## Example: Using Packet Trace

```
Router#debug platform condition ipv4 10.118.74.53/32 both
Router#Router#debug platform condition start
Router#debug platform packet-trace packet 200
Packet count rounded up from 200 to 256
```

```
Router#show platform packet-tracer packet 0
show plat pack pa 0
Packet: 0 CBUG ID: 674
Summary
 Input : GigabitEthernet1
 Output : internal0/0/rp:0
 State : PUNT 11 (For-us data)
 Timestamp
 Start : 17756544435656 ns (06/29/2020 18:19:17.326313 UTC)
 Stop : 17756544469451 ns (06/29/2020 18:19:17.326346 UTC)
```

```
Path Trace
Feature: IPV4(Input)
 Input : GigabitEthernet1
 Output : <unknown>
 Source : 10.118.74.53
 Destination : 198.51.100.38
 Protocol : 17 (UDP)
 SrcPort : 2640
 DstPort : 500
```

```
IOSd Path Flow: Packet: 0 CBUG ID: 674
Feature: INFRA
Pkt Direction: IN
 Packet Rcvd From DATAPLANE
```

```
Feature: IP
Pkt Direction: IN
 Packet Enqueued in IP layer
 Source : 10.118.74.53
 Destination : 198.51.100.38
 Interface : GigabitEthernet1
```

```
Feature: IP
Pkt Direction: IN
FORWARDED To transport layer
 Source : 10.118.74.53
 Destination : 198.51.100.38
 Interface : GigabitEthernet1
```

```
Feature: UDP
Pkt Direction: IN
DROPPED
UDP: Checksum error: dropping
Source : 10.118.74.53(2640)
Destination : 198.51.100.38(500)
```

```
Router#show platform packet-tracer packet 2
Packet: 2 CBUG ID: 2
```

```
IOSd Path Flow:
 Feature: TCP
 Pkt Direction: OUTtcp0: O SYNRCVD 198.51.100.38:22 198.51.100.55:52774 seq 3052140910
OPTS 4 ACK 2346709419 SYN WIN 4128
```

```
Feature: TCP
Pkt Direction: OUT
FORWARDED
TCP: Connection is in SYNRCVD state
ACK : 2346709419
```

```

SEQ : 3052140910
Source : 198.51.100.38(22)
Destination : 198.51.100.55(52774)

```

```

Feature: IP
Pkt Direction: OUTRoute out the generated packet.srcaddr: 198.51.100.38, dstaddr:
198.51.100.55

```

```

Feature: IP
Pkt Direction: OUTInject and forward successful srcaddr: 198.51.100.38, dstaddr:
198.51.100.55

```

```

Feature: TCP
Pkt Direction: OUTtcp0: O SYNRCVD 198.51.100.38:22 198.51.100.55:52774 seq 3052140910
OPTS 4 ACK 2346709419 SYN WIN 4128

```

#### Summary

```

Input : INJ.2
Output : GigabitEthernet1
State : FWD

```

#### Timestamp

```

Start : 490928006866 ns (06/29/2020 13:31:30.807879 UTC)
Stop : 490928038567 ns (06/29/2020 13:31:30.807911 UTC)

```

#### Path Trace

##### Feature: IPV4(Input)

```

Input : internal0/0/rp:0
Output : <unknown>
Source : 172.18.124.38
Destination : 172.18.124.55
Protocol : 6 (TCP)
SrcPort : 22
DstPort : 52774

```

##### Feature: IPSec

```

Result : IPSEC_RESULT_DENY
Action : SEND_CLEAR
SA Handle : 0
Peer Addr : 55.124.18.172
Local Addr : 38.124.18.172

```

Router#

## Additional References

### Standards

| Standard | Title |
|----------|-------|
| None     | —     |

### MIBs

| MIB  | MIBs Link                                                                                                                                                                                              |
|------|--------------------------------------------------------------------------------------------------------------------------------------------------------------------------------------------------------|
| None | To locate and download MIBs for selected platforms, Cisco IOS releases, and feature sets, use Cisco MIB Locator found at this URL:<br><br>{start hypertext}http://www.cisco.com/go/mibs{end hypertext} |

**RFCs**

| RFC  | Title |
|------|-------|
| None | —     |

**Technical Assistance**

| Description                                                                                                                                                                                                                                                                                                                                                                           | Link                                                                                    |
|---------------------------------------------------------------------------------------------------------------------------------------------------------------------------------------------------------------------------------------------------------------------------------------------------------------------------------------------------------------------------------------|-----------------------------------------------------------------------------------------|
| The Cisco Support and Documentation website provides online resources to download documentation, software, and tools. Use these resources to install and configure the software and to troubleshoot and resolve technical issues with Cisco products and technologies. Access to most tools on the Cisco Support and Documentation website requires a Cisco.com user ID and password. | {start<br>hypertext}http://www.cisco.com/cisco/web/support/index.html{end<br>hypertext} |

## Feature Information for Packet Trace

{start cross reference} Table 21-4 {end cross reference} lists the features in this module and provides links to specific configuration information.

Use Cisco Feature Navigator to find information about platform support and software image support. Cisco Feature Navigator enables you to determine which software images support a specific software release, feature set, or platform. To access Cisco Feature Navigator, go to {start hypertext} <http://www.cisco.com/go/cfn> {end hypertext}. An account on Cisco.com is not required.



---

**Note** {start cross reference} Table 21-4 {end cross reference} lists only the software releases that support a given feature in a given software release train. Unless noted otherwise, subsequent releases of that software release train also support that feature.

---



Table 51: Feature Information for Packet Trace

| Feature Name | Releases                      | Feature Information                                                                                                                                                                                                                                                                                                                                                                                                                                                                                                                                                                                                                                                                                                                                                                                                                            |
|--------------|-------------------------------|------------------------------------------------------------------------------------------------------------------------------------------------------------------------------------------------------------------------------------------------------------------------------------------------------------------------------------------------------------------------------------------------------------------------------------------------------------------------------------------------------------------------------------------------------------------------------------------------------------------------------------------------------------------------------------------------------------------------------------------------------------------------------------------------------------------------------------------------|
| Packet Trace | Cisco IOS XE 3.10S            | <p>The Packet Trace feature provides information about how data packets are processed by the Cisco IOS XE software.</p> <p>In Cisco IOS XE Release 3.10S, this feature was introduced on the Cisco ASR 1000 Series Aggregation Services Routers.</p> <p>The following commands were introduced or modified:</p> <ul style="list-style-type: none"> <li>• <b>debug platform packet-trace packet</b> <i>pkt-num</i> [<i>fia-trace</i>   <i>summary-only</i>] [<i>data-size data-size</i>] [<i>circular</i>]</li> <li>• <b>debug platform packet-trace copy packet</b> {<i>input</i>   <i>output</i>   <i>both</i>} [<i>size num-bytes</i>] [<i>L2</i>   <i>L3</i>   <i>L4</i>]</li> <li>• <b>show platform packet-trace</b> {<i>configuration</i>   <i>statistics</i>   <i>summary</i>   <i>packet</i> {<i>all</i>   <i>pkt-num</i>}}</li> </ul> |
|              | Cisco IOS XE 3.11S            | <p>In Cisco IOS XE Release 3.11S, this feature was enhanced to include the following features:</p> <ul style="list-style-type: none"> <li>• Matched versus traced statistics.</li> <li>• Trace stop timestamp in addition to trace start timestamp.</li> </ul> <p>The following commands were introduced or modified:</p> <ul style="list-style-type: none"> <li>• <b>debug platform packet-trace drop</b> [<i>code drop-num</i>]</li> <li>• <b>show platform packet-trace packet</b> {<i>all</i>   <i>pkt-num</i>} [<i>decode</i>]</li> </ul>                                                                                                                                                                                                                                                                                                 |
|              | Cisco IOS XE Denali 16.3.1    | <p>In Cisco IOS XE Denali 16.3.1, this feature was enhanced to include Layer3 packet tracing along with IOSd.</p> <p>The following commands were introduced or modified: <b>debug platform packet-trace punt</b>.</p>                                                                                                                                                                                                                                                                                                                                                                                                                                                                                                                                                                                                                          |
|              | Cisco IOS XE Amsterdam 17.3.1 | <p>The output of the <b>show platform packet-trace</b> command now includes additional trace information for packets either originated from IOSd or destined to IOSd or other BinOS processes.</p>                                                                                                                                                                                                                                                                                                                                                                                                                                                                                                                                                                                                                                             |





## CHAPTER 27

# Packet Drops

This document provides information about Packet Drops on the Cisco ASR 1000 Series Aggregation Services Routers.

- [Information About Packet Drops, on page 645](#)
- [Viewing Packet Drop Information, on page 646](#)
- [Verifying Packet Information, on page 647](#)
- [Packet Drops Warnings, on page 648](#)
- [Configuring Packet Drops Warning Thresholds, on page 649](#)
- [Viewing Packet Drops Warning Thresholds, on page 650](#)
- [Feature Information for Packet Drops, on page 651](#)

## Information About Packet Drops

### What are Packet Drops

A packet drop occurs when a router or a network device fails to transmit packets, instead of forwarding them to their intended destination.

### Functional Elements in Cisco ASR 1000 Series Routers

The Cisco ASR 1000 Series Router consists of the following key components within the system:

- Cisco ASR 1000 Series Route Processor (RP).
- Cisco ASR 1000 Series Embedded Services Processor (ESP).
- Cisco ASR 1000 Series SPA Interface Processor (SIP) or Modular Interface Processor.

### Cisco Quantum Flow Processor Based Hardware Architecture

The Cisco ASR 1000 Series Routers feature the Cisco Quantum Flow Processor (QFP) as the core of their hardware design. Within this design framework, every packet is processed and routed via the Embedded Services Processor (ESP). If an issue arises within the ESP, packet routing and forwarding are halted.

# Viewing Packet Drop Information

Perform the following steps to view the history of the QFP Drops. You can filter the packet drop information for your instance based on the interface, protocol, or feature:

## SUMMARY STEPS

1. **enable**
2. **show drops**
3. **show drops { bqs | crypto | firewall | interface | ip-all | nat | punt | qfp | qos | history }**

## DETAILED STEPS

### Step 1 **enable**

#### Example:

```
Router> enable
```

Enables the privileged EXEC mode. Enter your password, if prompted.

### Step 2 **show drops**

#### Example:

```
Router# show drops
```

Displays the drop statistics.

### Step 3 **show drops { bqs | crypto | firewall | interface | ip-all | nat | punt | qfp | qos | history }**

#### Example:

```
Router# show drops qfp
```

Displays the drop statistics and the summary for the interface or the protocol that you choose.

**Note** From Cisco IOS XE 17.13.1a, a new keyword option history is added to the **show drops** command. The **show drops history qfp** command will allow the user to view the history of the QFP drops.

## Example

### Example for Viewing Packet Drop Information: Sample Output

The following is a sample output of the show drops command. This sample output displays the **packet drops** information related to the Quantum Flow Processor (QFP).

```
Router#show drops
bqs BQS related drops
crypto IPSEC related drops
firewall Firewall related drops
history History of drops
interface Interface drop statistics
ip-all IP related drops
nat NAT related drops
```

```

punt Punt path related drops
qfp QFP drop statistics
qos QoS related drops
| Output modifiers
<cr> <cr>

Router# show drops qfp
----- show platform hardware qfp active statistics drop detail
Last clearing of QFP drops statistics : Fri Feb 18 08:02:37 2022
(6d 23h 54m 29s ago)

ID Global Drop Stats Packets
Octets

319 BFDoffload 9
1350
61 Icmp 84
3780
53 IpFragErr 32136
48718168
244 IpLispHashLkupFailed 3
213
56 IpsecInput 18
4654
23 TailDrop 26713208
10952799454
216 UnconfiguredIpv6Fia 241788
26596680
----- show platform hardware qfp active interface all
statistics drop_summary

Drop Stats Summary:
note: 1) these drop stats are only updated when PAL
reads the interface stats.
2) the interface stats include the subinterface
Interface Rx Pkts Tx Pkts

GigabitEthernet1 60547 0
GigabitEthernet2 60782 27769658
GigabitEthernet3 60581 0
GigabitEthernet4 60502 1323990
Tunnel14095001 0 1990214
Tunnel14095002 0 3883238
Tunnel14095003 0 3879243
Tunnel14095004 0 2018866
Tunnel14095005 0 3875972
Tunnel14095006 0 3991497
Tunnel14095007 0 4107743
Tunnel14095008 0 3990601

```

## Verifying Packet Information

This section shows examples of command output to verify packet information.

In order to display statistics of drops for all interfaces in Packet Processor Engine (PPE), use the command **show drops qfp**.



**Note** The wrapper command **show drops qfp** is the shorthand notation for the original **show platform hardware qfp active statistics drop** command.

```
Router#show drops qfp
```

```

Global Drop Stats Octets
Packets

```

```
AttnInvalidSpid 0 0
BadDistFifo 0 0
BadIpChecksum 0 0
```

In order to display the history of QFP drops for all interfaces in Packet Processor Engine (PPE), use the command **show drops history qfp**. This command can also track the number of packet drops in the last 1-min, 5-min and 30-min time period.



**Note** The wrapper command **show drops history qfp** is the shorthand notation for the original **show platform hardware qfp active statistics drop history** command.

```
Router# show drops history qfp
```

```
Last clearing of QFP drops statistics : Mon Jun 26 07:29:14
2023
(21s ago)
```

```

Global Drop Stats 1-Min
5-Min 30-Min All

```

```
Ipv4NoAdj 0
0 0 99818
Ipv4NoRoute 0
0 0 99853
```

## Packet Drops Warnings

From Cisco IOS XE 17.14, you can configure the warning thresholds for per drop cause and/or total QFP drop in packets per second. If the configured thresholds are exceeded, then a rate-limited syslog warning is generated. One warning is generated for total threshold exceeded and one warning per drop cause will be generated.

The warning is generated a maximum of once per minute for each drop cause. The drops over the previous minute are checked against the threshold (packets per second) x 60, and if the drops exceed this value, a warning is generated.

The following are the sample warnings for total and per drop cause respectively.

```
%QFP-5-DROP_OVERALL_RATE: Exceeded the overall drop threshold 10000 pps during the last
60-second measurement period, packets dropped in last 1 minute: 641220, last 5 minutes:
1243420, last 30 minutes: 124342200
```

```
%QFP-5-DROP_CAUSE_RATE: Exceeded the drop threshold 1000 pps for QosPolicing (drop code:
20) during the last 60-second measurement period, packets dropped due to QosPolicing in
last 1 minute: 61220, last 5 minutes: 43420, last 30 minutes: 4611200
```

# Configuring Packet Drops Warning Thresholds

Perform the following steps to configure the warning thresholds for per drop cause and/or total QFP drop in packets per second.

## SUMMARY STEPS

1. **enable**
2. **configure terminal**
3. **platform qfp drops threshold {per-cause *drop\_id threshold* | total *threshold*}**

## DETAILED STEPS

|               | Command or Action                                                                                                                                                             | Purpose                                                                                                                                                                                           |
|---------------|-------------------------------------------------------------------------------------------------------------------------------------------------------------------------------|---------------------------------------------------------------------------------------------------------------------------------------------------------------------------------------------------|
| <b>Step 1</b> | <b>enable</b><br><b>Example:</b><br>Router> enable                                                                                                                            | Enables the privileged EXEC mode. Enter your password, if prompted.                                                                                                                               |
| <b>Step 2</b> | <b>configure terminal</b><br><b>Example:</b><br>Router# configure terminal                                                                                                    | Enters global configuration mode.                                                                                                                                                                 |
| <b>Step 3</b> | <b>platform qfp drops threshold {per-cause <i>drop_id threshold</i>   total <i>threshold</i>}</b><br><b>Example:</b><br>Router# platform qfp drops threshold per-cause 206 10 | Specifies the per drop cause or total threshold value for the drop.<br><br><b>Note</b> Use the <b>show platform hardware qfp active statistics drop detail</b> command to view the drop cause ID. |

### Example

The following examples show how to configure the warning thresholds for per drop cause and total QFP drops.

#### Example for configuring warning threshold for per drop cause QFP drops

The following example shows how to configure the warning threshold of 15 pps for drop cause ID 24.

```
Router> enable
Router# configure terminal
Router(config)#platform qfp drops threshold ?
per-cause Set warning threshold for per cause QFP drops
total Set warning threshold for total QFP drops
Router(config)#platform qfp drops threshold per-cause ?
<0-1024> QFP drop cause ID
Router(config)#platform qfp drops threshold per-cause 24 ?
<0-2147483647> Drop threshold in packets per second (pps)
Router(config)#platform qfp drops threshold per-cause 24 15
```

#### Example for configuring warning threshold for total QFP drops

The following example shows how to configure the warning threshold of 100 pps for total QFP drops.

```
Router> enable
Router# configure terminal
Router(config)#platform qfp drops threshold ?
per-cause Set warning threshold for per cause QFP drops
total Set warning threshold for total QFP drops
Router(config)#platform qfp drops threshold total ?
<0-2147483647> Drop threshold in packets per second (pps)
Router(config)#platform qfp drops threshold total 100
```

## Viewing Packet Drops Warning Thresholds

Perform the following steps to view the configured warning thresholds for per drop cause and total QFP drops.

### SUMMARY STEPS

1. **enable**
2. **show platform hardware qfp active statistics drop threshold**

### DETAILED STEPS

|               | Command or Action                                                                                                                                                 | Purpose                                                                                                                                                                                                                                                                                                                 |
|---------------|-------------------------------------------------------------------------------------------------------------------------------------------------------------------|-------------------------------------------------------------------------------------------------------------------------------------------------------------------------------------------------------------------------------------------------------------------------------------------------------------------------|
| <b>Step 1</b> | <b>enable</b><br><br><b>Example:</b><br>Router> enable                                                                                                            | Enables the privileged EXEC mode. Enter your password, if prompted.                                                                                                                                                                                                                                                     |
| <b>Step 2</b> | <b>show platform hardware qfp active statistics drop threshold</b><br><br><b>Example:</b><br>Router# show platform hardware qfp active statistics drop thresholds | Displays the configured warning thresholds for per drop cause and total QFP drops.<br><br><b>Note</b> <ul style="list-style-type: none"> <li>• The wrapper command <b>show drops thresholds</b> is the shorthand notation of the <b>show platform hardware qfp active statistics drop threshold</b> command.</li> </ul> |

### Example

#### Example for Viewing Packet Drop Warning Thresholds

The following is a sample output of the **show platform hardware qfp active statistics drop threshold** command.

```
Router#show platform hardware qfp active statistics drop thresholds

Drop ID Drop Cause Name Threshold

10 BadIpChecksum 100
206 PuntPerCausePolicerDrops 10
20 QosPolicing 200
 Total 30
```

The following is a sample output of the **show drops thresholds** wrapper command.



```
Router#show platform hardware qfp active statistics drop thresholds

Drop ID Drop Cause Name Threshold

10 BadIpChecksum 100
206 PuntPerCausePolicerDrops 10
20 QosPolicing 200
 Total 30
```

## Feature Information for Packet Drops

The following table provides release information about the feature or features described in this module. This table lists only the software release that introduced support for a given feature in a given software release train. Unless noted otherwise, subsequent releases of that software release train also support that feature.

Use Cisco Feature Navigator to find information about platform support and Cisco software image support. To access Cisco Feature Navigator, go to [www.cisco.com/go/cfn](http://www.cisco.com/go/cfn). An account on Cisco.com is not required.

**Table 52: Feature Information for Packet Drops**

| Feature Name                    | Releases              | Feature Information                                                                                                                                                                                                                                                                                                                                                                                                 |
|---------------------------------|-----------------------|---------------------------------------------------------------------------------------------------------------------------------------------------------------------------------------------------------------------------------------------------------------------------------------------------------------------------------------------------------------------------------------------------------------------|
| Viewing Packet Drop Information | Cisco IOS XE 17.13.1a | A new keyword option history is added to the <b>show drops</b> command. The <b>show drops history qfp</b> command will allow the user to view the history of the QFP drops.                                                                                                                                                                                                                                         |
| QFP Drops Threshold and Warning | IOS XE 17.14.1a       | From Cisco IOS XE 17.14.1a, this feature enables you to configure the warning threshold for each drop cause, and the total QFP drop in packets per second. If the configured threshold exceeds, then a rate-limited syslog warning is generated.<br><br>You can configure the threshold using the <b>platform qfp drops threshold</b> command on the Cisco ASR 1000 Series and Catalyst 8500 Series Edge Platforms. |
| Packet Drops History            | IOS XE 17.13.1a       | From Cisco IOS XE 17.13.1a, you can use the <b>show drops history qfp</b> command to view the history of the QFP drops on the Cisco ASR 1000 Series and Catalyst 8500 Series Edge Platforms.                                                                                                                                                                                                                        |





## CHAPTER 28

# Configuring and Accessing the Web User Interface

---

The Cisco ASR 1000 Series Routers introduce a web user interface that expands on the functionality of web user interfaces available in other Cisco routers.

This chapter is about this web user interface and covers the following topics:

- [Web User Interface Overview, on page 653](#)
- [Configuring the Router for Web User Interface Access, on page 657](#)
- [Authentication and the Web User Interface, on page 659](#)
- [Domain Name System and the Web User Interface, on page 659](#)
- [Clocks and the Web User Interface, on page 660](#)
- [Accessing the Web User Interface, on page 660](#)
- [Using Auto Refresh, on page 661](#)
- [Web User Interface Tips and Tricks, on page 662](#)
- [Configuring Web User Interface in Cisco IOS XE 16 Releases, on page 663](#)

## Web User Interface Overview

This section covers the following topics:

### Web User Interface General Overview

The web user interface is available on Cisco ASR 1000 Series Routers starting in Cisco IOS XE Release 2.1.1. The web user interface is not available in Cisco IOS XE Release 2.1.0.

The Cisco ASR 1000 Series Routers can be accessed using a web user interface. This web user interface allows users to monitor router performance using an easy-to-read graphical interface. Most aspects of a Cisco ASR 1000 Series Router can be monitored using the web user interface.

The web user interface has the following features:

- An interface that presents information in an easy-to-read graphical format.
- An interface that allows users to monitor most software processes, including processes related to the IOS and nonIOS subpackages within the Cisco IOS XE consolidated package.
- An interface that allows users to monitor most hardware components, including all RPs, ESPs, SIPs, and SPAs installed in the router.

- Access to the legacy web user interface in addition to the enhanced web user interface.
- The ability to gather the output of **show** commands from the web user interface.

## Legacy Web User Interface Overview

Previous Cisco routers have a legacy web user interface that can be used to monitor the router. This legacy web user interface presents information in a straightforward manner without using any graphics. On the Cisco ASR 1000 Series Routers, this interface is part of the larger web user interface and can be accessed by clicking the “IOS Web UI” option in the left-hand menu.

On the Cisco ASR 1000 Series Routers, the legacy web user interface can only be used to configure and monitor the IOS subpackage. In some scenarios, most notably when an **ip http** command has been successfully entered to enable the HTTP or HTTPS server while a properly configured web user interface transport map has not yet been applied on the Cisco ASR 1000 Series Router, the legacy web user interface will be accessible while the graphics-based web user interface will be inaccessible.

See the following figure for an example of the legacy web user interface home page.

Figure 20: Legacy Web User Interface Home Page

The screenshot shows the legacy web user interface for a Cisco Router. The page is titled "Router" and includes a navigation menu on the left with categories such as System, Chassis, Memory, Process Resource, Alarms, CEF, Diagnostics, Interfaces, Modules, Peers, and WebCLI. The main content area displays "IOS WebUI" with a refresh timer set to 15 seconds. Below this, the "Cisco Systems" logo is followed by the title "Accessing Cisco ASR1006 'Router'" and a list of diagnostic actions: "Show diagnostic log - display the diagnostic log.", "Monitor the router - HTML access to the command line interface at level 0,1,2,3,4,5,6,7,8,9,10,11,12,13,14,15", "Show tech-support - display information commonly needed by tech support.", and "Extended Ping - Send extended ping commands.". A "Help resources" section provides contact information for Cisco Connection Online (CCO), TAC, and HTML interface development. The footer includes copyright information for 2004-2007 Cisco Systems, Inc. and the date/time: 10:52:00 AM Thu Apr 03 2008 GMT.

271 029

## Graphics-Based Web User Interface Overview

The web user interface on the Cisco ASR 1000 Series Routers expands the legacy web user interface available on other platforms by presenting information in easy-to-read graphics-based tables, graphs, or charts, depending on the information presented. The web user interface on the Cisco ASR 1000 Series Routers is also able to present monitoring information stored in both the IOS and nonIOS subpackages, allowing for a complete view of the router using the web user interface.

See the following figure for an example of the graphics-based web user interface home page.

Figure 21: Graphics-Based Web User Interface Home Page

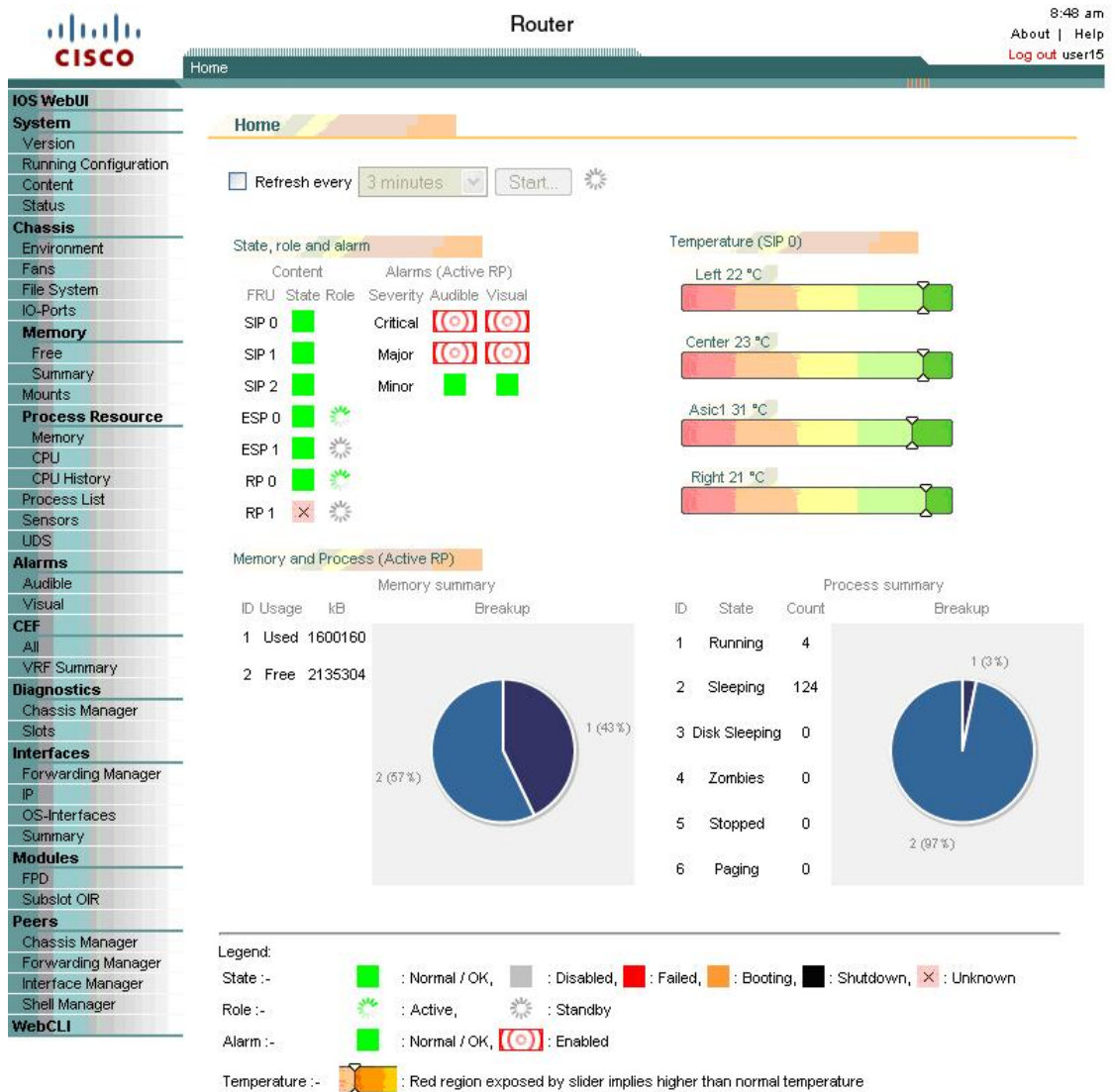

© 2004-2008 Cisco Systems, Inc. All rights reserved.

07:50:13 AM Tue Apr 22 2008 GMT

271030

## Persistent Web User Interface Transport Maps Overview

To enable the graphics-based web user interface, a persistent web user interface transport map must be configured. The persistent web user interface transport map, when successfully configured and applied to the router, defines how the router handles incoming web user interface requests. In the persistent web user interface transport map, users define whether the graphics-based web user interface can be accessed through HTTP, HTTPS, or both protocols. Only one persistent web user interface transport map can be applied to a Cisco ASR 1000 Series Router at a time.

The persistent web user interface transport map configuration must be performed in addition to the legacy web user interface configuration, which is configured using the **ip http** command set. The **ip http** command settings define which ports are used by HTTP or HTTPS for both the legacy and graphics-based web user interface.

## Configuring the Router for Web User Interface Access

The ability to access either web user interface on the Cisco ASR 1000 Series Routers is disabled by default.

The legacy web user interface must be configured before the graphics-based web user interface can be enabled.



**Note** The web user interface will not work if the Management Ethernet interface has not been configured or is not working; specifically, the default route must be specified in the Management Ethernet VRF before the web user interface can be configured.

To enable the entire web user interface, perform the following tasks:

### SUMMARY STEPS

1. (Optional) Ensure the clock setting on your router is accurate by entering the **show clock** command.
2. Connect to your router and enter the **configure terminal** command to enter global configuration mode.
3. Set the HTTP server authentication method to local by entering the **ip http authentication local** command.
4. Enable the legacy web user interface by entering one of the following global configuration commands:
5. Create and name a persistent web user interface transport map by entering the **transport-map type persistent webui transport-map-name** command.
6. Enable HTTP, HTTPS, or both by entering the following commands in transport map configuration mode:
7. (Optional) Enter the **show transport-map name transport-map-name** privileged EXEC command to verify that your transport map is properly configured.
8. Enable the transport map by entering the **transport type persistent webui input transport-map-name** global configuration command.

### DETAILED STEPS

**Step 1** (Optional) Ensure the clock setting on your router is accurate by entering the **show clock** command.

**Example:**

```
Router# show clock
*13:56:59.257 DST Mon May 5 2008
```

If the router time is not properly set, use the **clock set** and **clock timezone** commands for setting the router clock.

**Step 2** Connect to your router and enter the **configure terminal** command to enter global configuration mode.

**Step 3** Set the HTTP server authentication method to local by entering the **ip http authentication local** command.

**Step 4** Enable the legacy web user interface by entering one of the following global configuration commands:

- **ip http server**—Enables HTTP on port 80, which is the default HTTP port.
- **ip http port port-number**—Enables HTTP on the nondefault user-specified port.

- **ip http secure-server**—Enables HTTPS on port 443, the default HTTPS port.
- **ip http secure-port *port-number***—Enables HTTPS on the nondefault user-specified port.

The legacy web user interface becomes available at this point of the procedure. Users attempting to access the web user interface after this step is completed will see the legacy web user interface only.

To enable the graphics-based web user interface, proceed to Step 5 and complete the remaining steps in this procedure.

- Step 5** Create and name a persistent web user interface transport map by entering the **transport-map type persistent webui *transport-map-name*** command.
- Step 6** Enable HTTP, HTTPS, or both by entering the following commands in transport map configuration mode:
- **server**—Enables HTTP.
  - **secure-server**—Enables HTTPS.
- Port numbers cannot be set within the transport map. The port numbers defined in Step 4 are also used with these settings in the persistent web user interface transport map.
- Step 7** (Optional) Enter the **show transport-map name *transport-map-name*** privileged EXEC command to verify that your transport map is properly configured.
- Step 8** Enable the transport map by entering the **transport type persistent webui input *transport-map-name*** global configuration command.

## What to do next

### Examples

In the following example, the HTTP server authentication method is set to local:

```
Router# configure terminal
Enter configuration commands, one per line. End with CNTL/Z.
Router(config)# ip http authentication local
```

```
Router(config)# exit
```

In the following example, the web user interface using the default HTTP port is enabled:

```
Router# configure terminal
Enter configuration commands, one per line. End with CNTL/Z.
Router(config)# ip http server
Router(config)# transport-map type persistent webui http-webui
Router(config-tmap)# server
Router(config-tmap)# exit
Router(config)# exit
Router# show transport-map name http-webui
Transport Map:
 Name: http-webui
 Type: Persistent Webui Transport
Webui:
 Server: enabled
 Secure Server: disabled
Router# configure terminal
Router(config)# transport type persistent webui input http-webui
*Apr 22 02:43:55.798: %UICFGEXP-6-SERVER_NOTIFIED_START: R0/0: psd: Server wui has been notified to start
```

In the following example, the web user interface using the default HTTPs port is enabled:



```

Router# configure terminal
Enter configuration commands, one per line. End with CNTL/Z.
Router(config)# ip http secure-server
Router(config)# transport-map type persistent webui https-webui

Router(config-tmap)# secure-server
Router(config-tmap)# exit
Router(config)# transport type persistent webui input https-webui
*Apr 22 02:38:43.597: %UICFGEXP-6-SERVER_NOTIFIED_START: R0/0: psd: Server wui has been notified to start

```

In the following example, the web user interface using the default HTTP and HTTPS ports is enabled:

```

Router# configure terminal
Enter configuration commands, one per line. End with CNTL/Z.
Router(config)# ip http server
Router(config)# ip http secure-server
Router(config)# transport-map type persistent webui http-https-webui
Router(config-tmap)# server
Router(config-tmap)# secure-server
Router(config-tmap)# exit
Router(config)# transport type persistent webui input http-https-webui
*Apr 22 02:47:22.981: %UICFGEXP-6-SERVER_NOTIFIED_START: R0/0: psd: Server wui has been notified to start

```

## Authentication and the Web User Interface

Users attempting to access the web user interface for a router are subject to the same authentication requirements configured for that router. The web browser prompts all users for a name and password combination, and the web browser then looks to the router configuration to see if a user should or should not be granted access to the web user interface.

Only users with a privilege level of 15 can access the web user interface. Otherwise, authentication of web user interface traffic is governed by the authentication configuration for all other traffic.

To configure authentication on your router, see {start cross reference} Configuring Authentication {end cross reference}. {start hypertext}

[http://www.cisco.com/en/US/docs/ios/12\\_2/security/configuration/guide/scfathen.html](http://www.cisco.com/en/US/docs/ios/12_2/security/configuration/guide/scfathen.html) {end hypertext}

## Domain Name System and the Web User Interface

The Domain Name System (DNS) is a distributed database in which you can map hostnames to IP addresses through the DNS protocol from a DNS server.

If the router is configured to participate in the Domain Name System, users can access the web user interface by entering **http://<dns-hostname>** as the web browser address.

For information on configuring DNS, see {start cross reference} Configuring DNS {end cross reference}. {start hypertext}[http://www.cisco.com/en/US/docs/ios/ipaddr/configuration/guide/ip\\_addr\\_config\\_dns\\_ps6922\\_TSD\\_Products\\_Configuration\\_Guide\\_Chapter.html](http://www.cisco.com/en/US/docs/ios/ipaddr/configuration/guide/ip_addr_config_dns_ps6922_TSD_Products_Configuration_Guide_Chapter.html) {end hypertext}

# Clocks and the Web User Interface

Requests to view the web user interface can be rejected by certain web browsers if the time as seen by the web browser differs from the time as seen by the router by an hour or more.

For this reason, we recommend checking the router time using the **show clock** command before configuring the router and, if the router time is not properly set, use the **clock set** and **clock timezone** commands for setting the router clock.

Similarly, the web browser's clock source, which is usually the personal computer, must also have an accurate time to properly access the web user interface.

The following message appears when the web browser and the router clocks are more than an hour apart:

```
Your access is being denied for one of the following reasons:. Your previous session has
timed-out, or. You have been logged out from elsewhere, or. You have not yet logged in, or.
The resource requires a higher privilege level login.
```

If you see this message and fixing the other possible causes of the issue still does not make the web user interface accessible, check both the router clock and the PC clock to ensure both clocks reflect the accurate day and time and then retry your connection to the web user interface.

Also note that if one clock changes at daylight savings time while another clock does not, clock-related issues can occur.

## Accessing the Web User Interface

To access the web user interface, perform the following tasks:

### SUMMARY STEPS

1. Open your web browser. The web user interface supports the following web browsers:
2. Enter the address of the router in the address field of the web browser. The format for the address of the router in the address field is **http://<routername or management-ethernet-ip-address>:http-port]** or **https://<routername or management-ethernet-ip-address>:https-port]**, and the addresses that are acceptable depend upon your web browser user interface configurations and whether your router is participating in DNS. Following are some examples of acceptable address field web browser entries:
3. If prompted, enter your username and password. The username and password combination required to enter the web user interface is the same combination required to access the router.
4. The graphics-based web user interface similar to should appear in your web browser.

### DETAILED STEPS

- 
- Step 1** Open your web browser. The web user interface supports the following web browsers:
- Microsoft Internet Explorer 6 or later
  - Mozilla Firefox 2.0 or later

**Step 2** Enter the address of the router in the address field of the web browser. The format for the address of the router in the address field is **http://<routername or management-ethernet-ip-address>:http-port** or **https://<routername or management-ethernet-ip-address>:https-port** , and the addresses that are acceptable depend upon your web browser user interface configurations and whether your router is participating in DNS. Following are some examples of acceptable address field web browser entries:

**Example:**

```
HTTP Using Default Port Example
http://198.51.100.1
HTTPS Using Default Port Example
https://198.51.100.1
HTTP Using NonDefault Port Example
http://198.51.100.1:94
HTTPS Using NonDefault Port Example
https://198.51.100.1:530/
HTTP Using Default Port Participating in DNS Example
http://router1
HTTPS Using Default Port Participating in DNS Example
https://router1
HTTP Using NonDefault Port Participating in DNS Example
http://router1:94
HTTPS Using NonDefault Port Participating in DNS Example
https://router1:530/
```

**Step 3** If prompted, enter your username and password. The username and password combination required to enter the web user interface is the same combination required to access the router.

**Step 4** The graphics-based web user interface similar to should appear in your web browser.

---

## Using Auto Refresh

The web user interface does not refresh content automatically by default.

To set an auto-refresh interval, follow these steps:

### SUMMARY STEPS

1. Check the **Refresh every** check box on the graphical web user interface home page. A check mark appears in the check box.
2. Set the frequency of the auto-refresh interval using the drop-down menu.
3. Click the **Start** button to the right of the drop-down menu. After hitting this button, the **Start** button becomes the **Stop** button and a countdown timer placed to the right of the **Stop** button begins to increment.

### DETAILED STEPS

---

**Step 1** Check the **Refresh every** check box on the graphical web user interface home page. A check mark appears in the check box.

Figure 22: Checking Auto Refresh Check Box

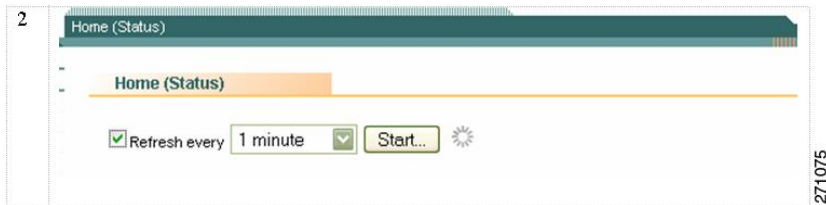

**Step 2** Set the frequency of the auto-refresh interval using the drop-down menu.

**Step 3** Click the **Start** button to the right of the drop-down menu. After hitting this button, the **Start** button becomes the **Stop** button and a countdown timer placed to the right of the **Stop** button begins to increment.

Figure 23: Auto Refresh Counter Example



The web user interface screen refreshes every time this counter reaches 0 seconds.

If you would like to stop the auto-refresh update, click the **Stop** button to return to the default setting of no auto-refresh update.

## Web User Interface Tips and Tricks

This section provides some useful information about using the web user interface once the interface has been accessed:

- If you know a Cisco IOS command-line interface command to gather information that you are unable to gather using the web user interface, you can click **IOS Web UI** followed by **Monitor the Router** to enter commands.
- If you know a diagnostic mode command to gather information that you are unable to gather using the web user interface, you can click **WebCLI** to enter **show** commands.
- The WebCLI command line has a context-sensitive help feature that shows the options available in a certain keyword sequence using a drop-down menu. The following figure shows an example of this drop-down menu context-sensitive help feature.

Figure 24: Web CLI Drop-Down Menu

The screenshot shows the Cisco IOS XE WebUI interface. The top header includes the Cisco logo, the word "Router", and the time "10:44 am" along with "About | Help" and "Log out user15". The navigation sidebar on the left lists various system components like "IOS WebUI", "System", "Chassis", "Memory", "Process Resource", "Alarms", "CEP", "Diagnostics", "Interfaces", "Modules", and "Peers". The "WebCLI" section is highlighted in the sidebar and the main content area. It contains the following text:

To conserve resources, the webCLI requires the following steps:

- . In the *command* field, start entering "show" to see all start-phrases for supported **show** commands
- . After entering the entire start-phrase or selecting one, enter a <space> to see all possible matching commands
- . Enter the remainder of the command or select one. Hit <enter> to execute the command

The "Command" field contains the text "show platform software process list". A dropdown menu is open, showing a list of commands:

- show platform software process list 0
- show platform software process list 0 summary
- show platform software process list 1
- show platform software process list 1 summary
- show platform software process list 2
- show platform software process list 2 summary
- show platform software process list F0
- show platform software process list F0 summary
- show platform software process list F1
- show platform software process list F1 summary
- show platform software process list FP active
- show platform software process list FP active summary
- show platform software process list FP standby
- show platform software process list FP standby summary
- show platform software process list R0
- show platform software process list R0 summary
- show platform software process list R1
- show platform software process list R1 summary
- show platform software process list RP active
- show platform software process list RP active summary
- show platform software process list RP standby
- show platform software process list RP standby summary

On the right side of the dropdown menu, there is a small icon of a gear and the text "rights reserved. GMT".

271031

# Configuring Web User Interface in Cisco IOS XE 16 Releases

## Web User Interface

The Web User Interface (WebUI) is a graphical user interface that allows you to provision, monitor, and optimize your device. These sections explain how to access the web user interface and bring up the device:

### Setting Up Factory Default Device Using WebUI

Quick Setup Wizard allows you to perform the basic router configuration. To configure the router:

**Before you begin**

- Before you access the WebUI, you need to have the basic configuration on the device.

- 
- Step 1** Connect the RJ-45 end of a serial cable to the RJ-45 console port on the router.
- Step 2** After the device initial configuration wizard appears, enter **No** to get into the device prompt when the following system message appears on the router.
- Would you like to enter the initial configuration dialog? [yes/no]: no
- Step 3** From the configuration mode, enter the following configuration parameters.
- ```
!
ip dhcp pool WEBUIPool
network 192.168.1.0 255.255.255.0
default-router 192.168.1.1
username webui privilege 15 password cisco
!
interface gig 0/0/1
ip address 192.168.1.1 255.255.255.0
!
```
- Step 4** Connect your device to the router using an Ethernet cable to the gig 0/0/1 interface.
- Step 5** Set up your system as a DHCP client to obtain the IP address of the router automatically.
- Step 6** Launch the browser and enter the device IP address in your browser's address line. For a secure connection, type <https://192.168.1.1/#/dayZeroRouting>. For a less secure connection, enter <http://192.168.1.1/#/dayZeroRouting>.
- Step 7** Enter the default username (webui) and default password (cisco).
-

Using Basic or Advanced Mode Setup Wizard

To configure the router using the basic or advanced mode setup:

- Step 1** Choose the **Basic Mode** or **Advanced Mode** and click **Go To Account Creation Page**.
- Step 2** Enter the username and password. Reenter the password to confirm.
- Step 3** Click **Create and Launch Wizard**.
- Step 4** Enter the device name and domain name.
- Step 5** Select the appropriate time zone from the **Time Zone** drop-down list.
- Step 6** Select the appropriate date and time mode from the **Date and Time** drop-down list.
- Step 7** Click **LAN Settings**.

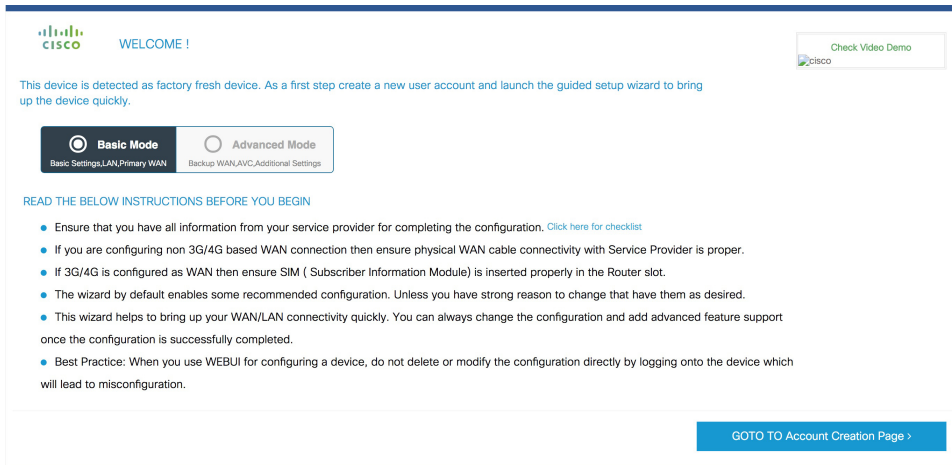

Configure LAN Settings

Step 1

Choose the **Web DHCP Pool/DHCP Pool** name or the **Create and Associate Access VLAN** option.

a) If you choose the Web DHCP Pool, specify the following:

Pool Name—Enter the DHCP Pool Name.

Network—Enter network address and the subnet mask.

b) If you choose the Create and Associate Access VLAN option, specify the following:

Access VLAN—Enter the Access VLAN identification number. The range is from 1 to 4094.

Network—Enter the IP address of the VLAN.

Management Interfaces—Select the interface and move to the selected list box using the right and left arrows. You can also double click or drag and drop to move the interface to the selected list box.

Step 2

Click **Primary WAN Settings**.

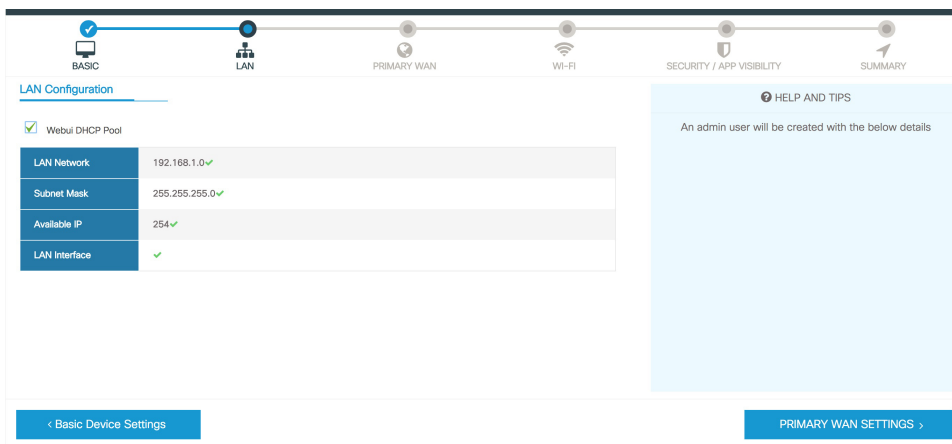

Configure Primary WAN Settings

- Step 1** Select the primary WAN type. You can configure Serial, 3G/4G, Ethernet, or Broadband (xDSL) as primary WAN depending on the WAN types supported by the router.
- Step 2** Select the interface from the drop-down list.
- Step 3** Check the **Get DNS Server info directly from ISP** check box to get the DNS server information directly from the service provider. You can also manually enter the Primary DNS and Secondary DNS.
- Step 4** Check the **Get IP automatically from ISP** check box to get the IP address information directly from the service provider. You can also manually enter the IP address and subnet mask.
- Step 5** Check the **Enable NAT** check box to enable NAT. It is recommended to enable NAT.
- Step 6** Check the **Enable PPPOE** check box to enable PPPoE. If you have enabled PPPoE, select the required authentication mode. The options are: **PAP** and **CHAP**.
- Step 7** Enter the username and password provided by the service provider.
- Step 8** Click **Security / APP Visibility WAN Settings**.

The screenshot displays the 'PRIMARY WAN' configuration page. At the top, a progress bar shows 'BASIC' and 'LAN' as completed steps, and 'PRIMARY WAN' as the current step. The page is divided into several sections:

- WAN Configuration:** Includes dropdown menus for 'WAN Type *' and 'Interface *'.
- DNS / IP Address:** Contains three checked checkboxes: 'Get DNS Server info directly from ISP', 'Get IP automatically from ISP', and 'Enable NAT'.
- Profile:** Features an 'Access Point Name (APN) *' text input field and an unchecked checkbox for 'Configure username and password if provided by service'.

At the bottom, there are navigation buttons: '< LAN SETTINGS' on the left and 'Wi-Fi >' on the right. A 'HELP AND TIPS' panel on the right side contains the text: 'An admin user will be created with the below details'.

Configure Secondary WAN Settings

For advanced configuration, you should configure the secondary WAN connection.

- Step 1** Select the secondary WAN type. You can configure Serial, 3G/4G, Ethernet, or Broadband (xDSL) as a secondary WAN depending on the WAN types supported by the router.
- Step 2** Select the interface from the drop-down list.
- Step 3** Check the **Get DNS Server info directly from ISP** check box to get the DNS server information directly from the service provider. You can also manually enter the Primary DNS and Secondary DNS.
- Step 4** Check the **Get IP automatically from ISP** check box to get the IP address information directly from the service provider. You can also manually enter the IP address and subnet mask.
- Step 5** Check the **Enable NAT** check box to enable NAT. It is recommended to enable NAT.
- Step 6** Check the **Enable PPPOE** check box to enable PPPoE. If you have enabled PPPoE, select the required authentication mode. The options are: **PAP** and **CHAP**.
- Step 7** Enter the username and password provided by the service provider.

Step 8 Click **Security / APP Visibility WAN Settings**.

Configure Security Settings

Step 1 Check the **Enable Cisco Recommended Security Settings** check box to ensure that all passwords are not shown in plain text. The passwords are encrypted.

Step 2 Click **Day 0 Config Summary**.

Step 3 To preview the configuration, click **CLI Preview** to preview the configuration.

Step 4 Click **Finish** to complete the Day Zero setup.

The screenshot displays the 'SUMMARY' page of the Day 0 configuration wizard. At the top, a progress bar indicates the completion status of six steps: BASIC, LAN, PRIMARY WAN, WI-FI, SECURITY / APP VISIBILITY, and SUMMARY. The 'SUMMARY' step is currently selected. Below the progress bar, a table provides a detailed overview of the configurations for each step:

Step	Configuration Details
Basic	Router Name: geo, Domain Name: mydomain.com, Time Zone: 5:30, Date & Time Mode: Automatic
LAN	LAN Interface: , IP Address: , Subnet Mask: , Use as DHCP Server: Yes, Pool Name: , Network: (), Management Interface Configured: No
Primary WAN	WAN Interface: , IP Address: Automatic, DNS: Automatic, NAT: Enabled
Wi-Fi	Wi-Fi Configuration:
Security / App Visibility	Cisco recommended security settings: Enabled, Application Visibility: Disabled

At the bottom of the page, there are navigation buttons: '< SECURITY / APP VISIBILITY' on the left and 'Finish >' on the right. A 'CLI Preview' button is also present in the top right corner of the summary area.



CHAPTER 29

PPP Half-Bridge on the Cisco ASR 1000 Series Routers

First Published: December 12, 2014

For situations in which routed network needs connectivity to a remote bridged Ethernet network, a serial or ISDN interface can be configured to function as a PPP half-bridge. The line to the remote bridge functions as a virtual Ethernet interface, and the router's serial or ISDN interface functions as a node on the same Ethernet subnetwork as the remote network.

The PPP full-bridge sends PPP packets to the PPP half-bridge, which converts them to routed packets and forwards them to other router processes. Likewise, the PPP half-bridge converts routed packets to Ethernet bridge packets and sends them to the PPP full-bridge on the same Ethernet subnetwork.



Note An interface cannot function as both a half-bridge and a full-bridge.

- [Prerequisites for PPP Half-Bridge on the Cisco ASR 1000 Series Routers, on page 669](#)
- [Information About PPP Half-Bridge on the Cisco ASR 1000 Series Routers, on page 670](#)
- [Configuration Examples for PPP Half-Bridge, on page 671](#)
- [Verifying PPP Half-Bridge, on page 671](#)
- [Additional References, on page 673](#)
- [Feature Information for PPP Half-Bridge on the Cisco ASR 1000 Series Routers, on page 674](#)

Prerequisites for PPP Half-Bridge on the Cisco ASR 1000 Series Routers

PPP encapsulation must be enabled under the interface to use PPP half-bridge on ASR 1000 Series Routers.

Information About PPP Half-Bridge on the Cisco ASR 1000 Series Routers

The following figure shows a half-bridge configuration. The router port connecting to the bridge is configured as a serial interface to the PPP half-bridge. The interface functions as a virtual node on the Ethernet subnetwork on the bridge. The serial interface has an IP address associated with the Ethernet subnetwork.

Figure 25: PPP Half-Bridge Configuration

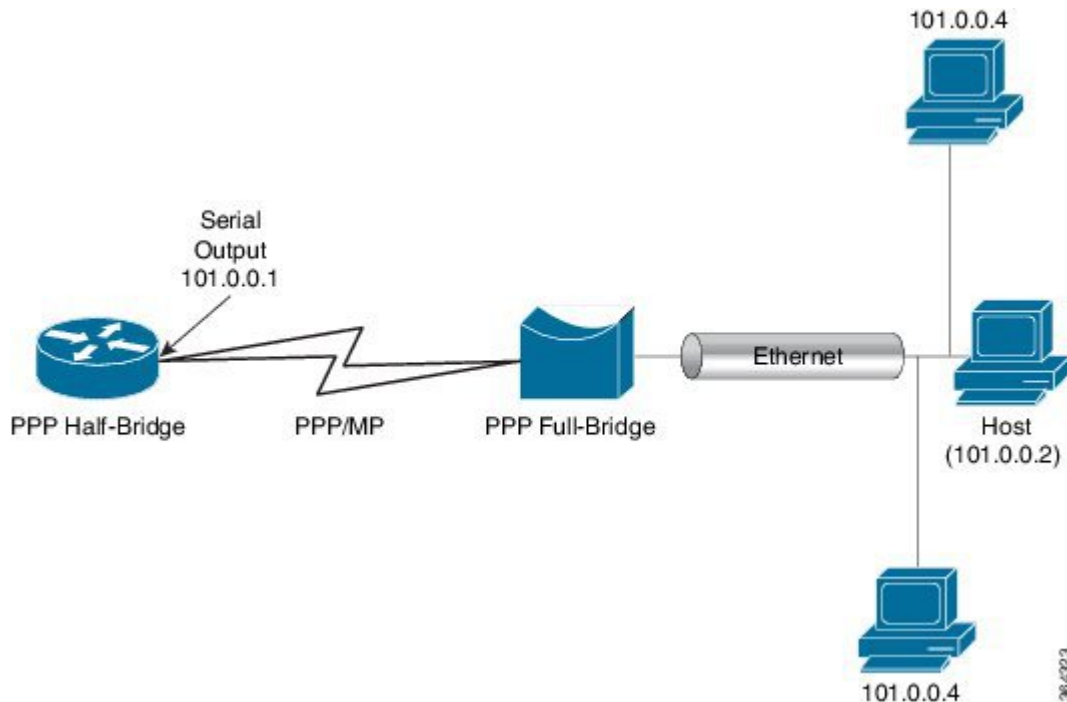

When a packet destined to the Ethernet arrives at the PPP half-bridge, it is converted to Ethernet packets, encapsulated in PPP frames, and sent on the Ethernet bridge link. The PPP full-bridge decapsulates PPP header, and forwards the Ethernet packet with bridge functionality.

In the reverse direction, PPP half-bridge extracts the Ethernet packets encapsulated in PPP frames that are received from PPP full-bridge device. The PPP half-bridge converts them to IP packets, and routes them on the Internet.

PPP Half-Bridge Supported Features

PPP half-bridge supports the following interworking features:

- VRF aware PPP half bridge interface
- Multicast and VPN Multicast (IGMP V2 and V3) on the PPP half bridge interface
- Routing protocol on the PPP half bridge interface
- IPv4 on the PPP half bridge interface
- ACL on the PPP half bridge interface

- QOS on the PPP half bridge interface
- PPP authentication on the half bridge interface

Configuration Examples for PPP Half-Bridge

Example: Configuring PPP Half-Bridge on the Cisco ASR 1000 Series Routers

The following example shows how to configure PPP Half-Bridge on ASR 1000 Series Routers:

```
interface Serial0/1/1:0
 ip address 101.0.0.1 255.255.255.0
 encapsulation ppp
 ppp bridge ip
```

Example: Configuring PPP Full-Bridge on the Cisco 7206 Routers

The following example shows how to emulate the bridge device.

```
no ip routing
interface Serial5/1:0
 no ip address
 encapsulation ppp
 bridge-group 1
interface GigabitEthernet0/2
 bridge-group 1
```

Verifying PPP Half-Bridge

The commands outlined in this section can be used to verify the PPP half-bridge.

Command	Purpose
show ppp interfaces	Displays PPP state information for an interface.
show adjacency	Displays information about the Cisco Express Forwarding adjacency table or the hardware Layer 3-switching adjacency table.
show interfaces serial slot/port	Displays information about a serial interface.

The following example displays PPP state information for an interface.

```
Router# show ppp all
Interface/ID OPEN+ Nego* Fail- Stage Peer Address Peer Name
-----
Se0/1/1:0 LCP+ BCP+ LocalT 0.0.0.0
```

The following example shows the sample output for **show adjacency** command.

```
Router# show adjacency serial 0/1/1:0 detail
Protocol Interface Address
```

```

IP          Serial0/1/1:0          101.0.0.2(11)
                                0 packets, 0 bytes
                                epoch 0
                                sourced in sev-epoch 439
                                Encap length 20
                                FF0300310001503DE53411110022BDD5
                                E8000800
                                ARP

```

The following example displays information about a serial interface.

```

Router# show interfaces serial 0/1/1:0
Serial0/1/1:0 is up, line protocol is up
  Hardware is SPA-8XCHT1/E1
  Internet address is 101.0.0.1/24
  MTU 1500 bytes, BW 1984 Kbit/sec, DLY 20000 usec,
    reliability 255/255, txload 1/255, rxload 1/255
  Encapsulation PPP, LCP Open
  Open: BCP, crc 16, loopback not set
  Keepalive set (10 sec)
  ARP type: ARPA, ARP Timeout 04:00:00

```

Debugging PPP Half-Bridge

The following commands are used to debug PPP half-bridge.

Command	Purpose
debug ppp negotiation	Enables debugging of LCP and Network Control Protocol (NCP) session negotiations.
debug ppp error	Displays local errors.
debug ppp events	Displays information about protocol actions and transitions between action states (pending, waiting, idle) on the link.
debug arp	Displays information on Address Resolution Protocol (ARP) transactions.

Sample output for debug ppp command

```

Router# debug ppp
Aug 6 14:36:00.021 CST: ppp827 PPP: Phase is ESTABLISHING
*Aug 6 14:36:00.021 CST: Se0/3/0:0 PPP: Using default call direction
*Aug 6 14:36:00.021 CST: Se0/3/0:0 PPP: Treating connection as a dedicated line*Aug 6
14:36:00.021 CST: Se0/3/0:0 PPP: Session handle[1900033B] Session id[827]
*Aug 6 14:36:00.021 CST: Se0/3/0:0 LCP: Event[OPEN] State[Initial to Starting]
*Aug 6 14:36:00.021 CST: Se0/3/0:0 LCP: O CONFREQ [Starting] id 1 len 10
*Aug 6 14:36:00.021 CST: Se0/3/0:0 LCP: MagicNumber 0x6B5AC045 (0x05066B5AC045)*Aug 6
14:36:00.021 CST: Se0/3/0:0 LCP: Event[UP] State[Starting to REQsent]*

```

Sample output for debug arp command

```

Router# debug arp
Aug 6 15:43:22.915 CST: IP ARP: rcvd req src 101.0.0.2 503d.e534.1111, dst 101.0.0.1
Serial0/1/1:0
Aug 6 15:43:22.917 CST: IP ARP: creating entry for IP address: 101.0.0.2, hw: 503d.e534.1111

```

```
Aug 6 15:43:22.917 CST: IP ARP: sent rep src 101.0.0.1 0022.bdd5.e800, dst 101.0.0.2
503d.e534.1111 Serial0/1/1:2
```

Additional References

Standards

Standard	Title
None	—

MIBs

MIB	MIBs Link
None	To locate and download MIBs for selected platforms, Cisco IOS releases, and feature sets, use Cisco MIB Locator found at this URL: {start hypertext}http://www.cisco.com/go/mibs{end hypertext}

RFCs

RFC	Title
None	—

Technical Assistance

Description	Link
The Cisco Support and Documentation website provides online resources to download documentation, software, and tools. Use these resources to install and configure the software and to troubleshoot and resolve technical issues with Cisco products and technologies. Access to most tools on the Cisco Support and Documentation website requires a Cisco.com user ID and password.	{start hypertext}http://www.cisco.com/cisco/web/support/index.html{end hypertext}

Feature Information for PPP Half-Bridge on the Cisco ASR 1000 Series Routers

{start cross reference} Table 23-1 {end cross reference} lists the features in this module and provides links to specific configuration information.

Use Cisco Feature Navigator to find information about platform support and software image support. Cisco Feature Navigator enables you to determine which software images support a specific software release, feature set, or platform. To access Cisco Feature Navigator, go to {start hypertext} <http://www.cisco.com/go/cfn> {start hypertext}. An account on Cisco.com is not required.



Note {start cross reference} Table 23-1 {end cross reference} lists only the software releases that support a given feature in a given software release train. Unless noted otherwise, subsequent releases of that software release train also support that feature.

Table 53: Feature Information for PPP Half-Bridge on the Cisco ASR 1000 Series Routers

Feature Name	Releases	Feature Information
PPP Half-Bridge on the Cisco ASR 1000 Series Routers	Cisco IOS XE 3.13.1	In Cisco IOS XE Release 3.13.1, the PPP Half-Bridge feature was introduced on the Cisco ASR 1000 Series Router.



CHAPTER 30

Cisco ASR 1000 Embedded Services Processor 10G Non Crypto Capable New Feature

First Published: September 26, 2008

Last Updated: September 26, 2008

The Cisco ASR 1000 Embedded Services Processor 10G Non Crypto Capable new feature includes:

- Embedded Services Processor (ESP) in which all encryption chips have been removed
- Encryption software is removed from the Cisco IOS XE Route Processor software subpackage.

Finding Support Information for Platforms and Cisco IOS and Catalyst OS Software Images

Use Cisco Feature Navigator to find information about platform support and Cisco IOS and Catalyst OS software image support. To access Cisco Feature Navigator, go to <http://www.cisco.com/go/cfn>. An account on Cisco.com is not required.

- [Information About Cisco ASR 1000 ESP 10G Non Crypto Capable New Feature, on page 675](#)
- [Checking the ESP Board, on page 676](#)
- [Additional References, on page 676](#)

Information About Cisco ASR 1000 ESP 10G Non Crypto Capable New Feature

For those users who are under export or import restrictions for strong encryption services products, the Cisco ASR 1000 ESP board (ASR1000-ESP10-N) without encryption is provided. This unrestricted product format, in which all encryption chips have been removed, can be provided in the Cisco ASR 1002, 1004, and 1006 Series Routers. Additionally, a Cisco IOS XE 2.2 image for this ESP is available that does not contain encryption software. Therefore, any Cisco ASR 1000 Series Router which contains the ASR1000-ESP10-N ESP board does not provide Secure Shell (SSH), Transport Layer Security (TLS), Secure Socket Layer (SSL), or IP Security (IPSec) encryption processes. All other functionality found in the Cisco ASR 1000 Series Routers remains the same.

The benefits of Cisco ASR 1000 ESP 10G Non Crypto Capable new feature are:

- Fully unrestricted network product that meets US export restrictions and any foreign security import restrictions.
- Users can obtain encryption processes of their own choosing.

Checking the ESP Board

You can verify the part number of your ASR 1000 Series Router ESP board in two ways:

- Look for the ASR1000-ESP10-N part number on the board itself, or
- Enter the **show platform** command as shown below:

```
Router# show platform
Chassis type: ASR1006
Slot      Type                State                Insert time (ago)
-----
0          ASR1000-SIP10         ok                   00:03:06
0/0        SPA-5X1GE-V2          ok                   00:01:35
0/1        SPA-8X1FE-TX-V2       ok                   00:01:35
0/2        SPA-2XCT3/DS0         ok                   00:01:35
1          ASR1000-SIP10         ok                   00:03:06
1/0        SPA-2XOC3-POS         ok                   00:01:35
1/1        SPA-8XCHT1/E1         ok                   00:01:35
1/2        SPA-2XT3/E3           ok                   00:01:35
R0         ASR1000-RP1           ok, active          00:03:06
F0         ASR1000-ESP10-N
          ok, active           00:03:06
P0         ASR1006-PWR-AC        ok                   00:02:06
P1         ASR1006-FAN           ok                   00:02:06
Slot      CPLD Version          Firmware Version
-----
0          06120701              12.2(33r)XNB
1          06120701              12.2(33r)XNB
R0         07082312              12.2(33r)XNB
F0         07051680              12.2(33r)XNB
```

Additional References

The following sections provide references related to the Cisco ASR 1000 ESP 10G Non Crypto Capable New Feature.

Related Documents

Related Topic	Document Title
Cisco ASR 1000 Series Routers software configuration information.	<i>Cisco ASR 1000 Series Aggregation Services Routers Software Configuration Guide</i> at http://www.cisco.com/en/US/docs/routers/asr1000/configuration/guide/chassis/asrswcfg.html

Related Topic	Document Title
Cisco ASR 1000 Series Routers hardware installation information.	<i>Cisco ASR 1000 Series Aggregation Services Routers Hardware Installation and Initial Configuration Guide</i> at http://www.cisco.com/en/US/docs/routers/asr1000/install/guide/chassis/asr1000hig.html
System message information for Cisco IOS XE software.	<i>System Messages for Cisco IOS XE</i> at http://www.cisco.com/en/US/products/ps9343/products_system_message_guides_list.html
Cisco IOS XE software configuration information.	<i>Cisco IOS XE Configuration Guides</i> at http://www.cisco.com/en/US/products/ps9587/products_installation_and_configuration_guides_list.html

Standards

Standard	Title
No new or modified standards are supported by this feature, and support for existing standards has not been modified by this feature.	—

MIBs

MIB	MIBs Link
No new or modified MIBs are supported by this feature, and support for existing MIBs has not been modified by this feature.	To locate and download MIBs for selected platforms, Cisco IOS releases, and feature sets, use Cisco MIB Locator found at the following URL: http://www.cisco.com/go/mibs

RFCs

RFC	Title
No new or modified RFCs are supported by this feature, and support for existing RFCs has not been modified by this feature	—

Technical Assistance

Description	Link
<p>The Cisco Support website provides extensive online resources, including documentation and tools for troubleshooting and resolving technical issues with Cisco products and technologies.</p> <p>To receive security and technical information about your products, you can subscribe to various services, such as the Product Alert Tool (accessed from Field Notices), the Cisco Technical Services Newsletter, and Really Simple Syndication (RSS) Feeds.</p> <p>Access to most tools on the Cisco Support website requires a Cisco.com user ID and password.</p>	http://www.cisco.com/techsupport



CHAPTER 31

Ethernet Virtual Connections on Port Channels

A port channel bundles individual Ethernet links into a single logical link that provides an aggregated bandwidth of up to four physical links. The Ethernet Virtual Connection (EVC) Port Channel feature provides support for the Ethernet service instances on a port channel.

- [Information About Ethernet Virtual Connections on Port Channels, on page 679](#)
- [Configuring a Basic EVC Port Channel, on page 680](#)
- [Load Balancing the EVCs on Port Channels, on page 683](#)
- [Enabling Flow Based Load Balancing on a Port Channel, on page 684](#)
- [Configuring Flow Based Load Balancing, on page 685](#)
- [VLAN-Based Manual Load Balancing, on page 686](#)
- [Configuring LACP, on page 691](#)
- [VLAN Manual Load Balancing on Q-in-Q Interfaces, on page 692](#)

Information About Ethernet Virtual Connections on Port Channels

Usage Guidelines for Configuring an EVC on a Port Channel

Prior to configuring an EVC on a port channel, consider these usage guidelines:

- All the member links of the port channel are on the Cisco ASR 1000 Fixed Ethernet Line card or on the shared port adapters (SPAs).
- All the member links of the port channel must be configured such that they are of the same speed, and are in the same duplex mode.
- EVC connect and IP subinterfaces are allowed to co-exist over the port-channel interface.
- If you configure a physical port as part of a channel group, you cannot configure EVCs under that physical port.
- You cannot use the bandwidth percent or police percent commands on EVC port channels in flat policy maps or in the parent of the Hierarchical quality of service (HQoS) policy maps.

Quality of Service Support

The following Quality of Service (QoS) policy settings are supported for egress traffic on the Cisco ASR 1000 Layer 3 port-channel interface:

- The QoS on the subinterface of a port channel with a specific encapsulation, such as, VLAN.
- The QoS on a member link.
- Modular QoS CLI (MQC) policy aggregation is supported with VLAN-based load balancing on subinterfaces and member-link ports.

The following section describes the QoS support for the following interfaces:

Port-Channel Interface

- Does not support any QoS policies on the port-channel interface.

Member-Link Interface

- Supports egress queuing, policing, and marking for flow-based load balancing.
- Supports egress queuing, policing, and marking for VLAN-based manual load balancing.
- Supports egress queuing, policing, marking, and the configuration of similar policies on two links for LACP 1:1.

EVC on Port-Channel Interface

- Does not support flow-based load balancing.
- Supports ingress and egress policing and marking for VLAN-based manual load balancing.
- Supports ingress and egress policing and marking for LACP 1:1.



Note Ensure that you configure the QoS policies for the EVCs on a port channel and a member link separately.



Note Service policies for ingress traffic are supported on EVC only.

Configuring a Basic EVC Port Channel

Configuring a Port Channel Interface with ethernet Service Instances

To configure a port-channel interface with Ethernet service instances, perform the following steps.

SUMMARY STEPS

1. enable

2. **configure terminal**
3. **interface port-channel** *number*
4. **[no] ip address**
5. **no negotiation auto**
6. **[no] service instance** *id* **Ethernet** [*service-name*]
7. **encapsulation** { **default** | **untagged** | **dot1q** *vlan-id* [**second-dot1q** *vlan-id*] }
8. **[no] service instance** *id* **ethernet** [*service-name*]
9. **encapsulation** { **default** | **untagged** | **dot1q** *vlan-id* [**second-dot1q** *vlan-id*] }

DETAILED STEPS

	Command or Action	Purpose
Step 1	enable Example: Router# enable	Enables the privileged EXEC mode. Enter your password if prompted.
Step 2	configure terminal Example: Router# configure terminal	Enters the global configuration mode.
Step 3	interface port-channel <i>number</i> Example: Router(config)# interface port-channel 11	Creates the port-channel interface.
Step 4	[no] ip address Example: Router(config-if)# no ip address	Removes an IP address or disables IP processing.
Step 5	no negotiation auto Example: Router(config-if)# no negotiation auto	Disables the advertisement of speed, duplex mode, and flow control on a Gigabit Ethernet interface.
Step 6	[no] service instance <i>id</i> Ethernet [<i>service-name</i>] Example: Router(config-if)# service instance 1 ethernet	Creates a service instance (an instantiation of an EVC) on an interface and sets the device to the config-if-srv submode.
Step 7	encapsulation { default untagged dot1q <i>vlan-id</i> [second-dot1q <i>vlan-id</i>] } Example: Router(config-if-srv)# encapsulation dot1q 101	Defines the matching criteria to be used in order to map ingress dot1q frames on an interface to the appropriate service instance.
Step 8	[no] service instance <i>id</i> ethernet [<i>service-name</i>] Example: Router(config-if)# service instance 2 ethernet	Creates a second service instance on the interface.

	Command or Action	Purpose
Step 9	encapsulation { default untagged dot1q <i>vlan-id</i> [second-dot1q <i>vlan-id</i>] } Example: Router(config-if-srv)# encapsulation dot1q 201	Defines the matching criteria to be used in order to map ingress dot1q frames on an interface to the appropriate service instance.

Adding a Port Channel Ethernet Flow Point to a Bridge Domain

To add a port channel Ethernet Flow Point (EFP) to a bridge domain, perform the following steps.

SUMMARY STEPS

1. [no] **bridge-domain** *bridge-id*
2. **member port-channel interface** *id* **service-instance** *id*
3. [no] **bridge-domain** *bridge-id* | **xconnect vfi** *vfi name*
4. **member port-channel interface** *id* **service-instance** *id*

DETAILED STEPS

	Command or Action	Purpose
Step 1	[no] bridge-domain <i>bridge-id</i> Example: Router(config-if-srv)# bridge-domain 100	The bridge-domain command binds the service instance to a bridge domain instance, where <i>bridge-id</i> is the identifier of the bridge-domain instance. To disable bridging, use the no form of this command.
Step 2	member port-channel interface <i>id</i> service-instance <i>id</i> Example: Router(config-if-srv)# member Port-channel1 service-instance 1	Creates a service instance on the interface.
Step 3	[no] bridge-domain <i>bridge-id</i> xconnect vfi <i>vfi name</i> Example: Router(config-if-srv)# bridge-domain 200	The bridge-domain command binds the service instance to a bridge-domain instance, where <i>bridge-id</i> is the identifier of the bridge-domain instance. The xconnect vfi command specifies the Layer 2 virtual forwarding interface (VFI) that you are binding to the interface, where <i>vfi name</i> is the name of the VFI.
Step 4	member port-channel interface <i>id</i> service-instance <i>id</i> Example: Router(config-if-srv)# member Port-channel1 service-instance 2	Creates a service instance on the interface.

Adding an Ethernet Port to the Port Channel Interface

To configure the channel group number on the Ethernet port and to add an Ethernet port to the port-channel interface, perform the following steps.

SUMMARY STEPS

1. **interface** GigabitEthernet *slot/port/sub-port*
2. **no ip address**
3. **no negotiation auto**
4. **channel-group** *channel-group-number*
5. **end**

DETAILED STEPS

	Command or Action	Purpose
Step 1	interface GigabitEthernet <i>slot/port/sub-port</i> Example: Router(config-if-srv)# interface GigabitEthernet0/2/0	Specifies the Gigabit Ethernet port that is to be configured. This is the port in which the slot, port, or subport specifies the location of the Gigabit Ethernet port.
Step 2	no ip address Example: Router(config-if-srv)# no ip address	Removes an IP address or disables IP processing.
Step 3	no negotiation auto Example: Router(config-if-srv)# no negotiation auto	Disables the advertisement of speed, duplex mode, and flow control on a Gigabit Ethernet interface.
Step 4	channel-group <i>channel-group-number</i> Example: Router(config-if-srv)# channel-group 1	Assigns a port-channel interface to a port-channel group.
Step 5	end Example: Router(config-if-srv)# end	Exits the command-line interface and enters the privileged EXEC mode.

Load Balancing the EVCs on Port Channels

The load balancing of the EVCs in a port channel aims to load balance traffic across the member links of that port channel when the EVCs are configured. In the VLAN-based load-balancing method, if you do not assign EVCs to a member link, they will be statically mapped to one of the active port-channel member links, which will result in the outgoing traffic being limited to the bandwidth of the member link. In the flow-based load-balancing method, the traffic is distributed across all member links.

EFPs are configured under a port channel. The traffic, which is carried by the EFPs, is load balanced across member links. Ingress traffic for a single EVC can arrive on any member of the bundle. All the egress traffic pertaining to an EFP uses only one of the member links. Load balancing is achieved by grouping EFPs and assigning them to a member link. The Cisco ASR 1000 Layer 2 port-channel interface supports flow-based load balancing by default. In default load balancing, you have no control over how the EFPs are grouped together, and sometimes, the EFP grouping may not be ideal. To avoid this, use VLAN-based manual load balancing to control the EFP grouping.

Flow-Based Load Balancing

Flow-based load balancing is the default load-balancing method that is applied on a specific system level or a specific port channel level. However, EVC port channel also supports the VLAN-based load-balancing method. You can configure either of the load balancing methods globally for all the port channels or directly on specific port channels.

Load-Balancing Algorithm

When you select flow-based load balancing, a global flow-based load-balancing algorithm is applied to the port channel by default. Using the packet header information, the corresponding port channel balances the traffic across all the member links. You can configure the device to use one of the following methods to load balance across the port channels:

- Destination IP Address
- Destination MAC Address
- Source exclusive OR (XOR) Destination IP Address
- Source XOR Destination MAC Address
- Source IP Address
- Source MAC Address

The provision that you configure will be applied to all the egress traffic streams on all the port-channel interfaces that have flow-based load balancing.

The following is a sample configuration of the flow-based load-balancing algorithm:

```
Router(config)# port-channel load-balance-hash-algo ?
dst-ip Destination IP
dst-mac Destination MAC
src-dst-ip Source XOR Destination IP Addr
src-dst-mac Source XOR Destination MAC
src-ip Source IP
src-mac Source MAC
```

Enabling Flow Based Load Balancing on a Port Channel



Note Flow-based load balancing is enabled by default at the global level. You must explicitly configure VLAN-based load balancing; otherwise, the default load-balancing method is flow-based.

To enable flow-based load balancing on a port channel, perform the following steps:

SUMMARY STEPS

1. **enable**
2. **configure terminal**
3. **interface port-channel** *port-channel number*

4. **load-balancing {flow | vlan}**
5. **end**

DETAILED STEPS

	Command or Action	Purpose
Step 1	enable Example: Router# enable	Enables the privileged EXEC mode.
Step 2	configure terminal Example: Router# configure terminal	Enters the global configuration mode.
Step 3	interface port-channel <i>port-channel number</i> Example: Router(config)# interface port-channel 1	Specifies the port channel to configure, and enters the configuration mode.
Step 4	load-balancing {flow vlan} Example: Router(config-if)# load-balancing flow	Applies the load-balancing method to the specific port channel.
Step 5	end Example: Router(config-if)# end	Exits the configuration mode.

Configuring Flow Based Load Balancing

To configure flow-based load balancing on an EVC port channel, perform the following steps.

SUMMARY STEPS

1. **enable**
2. **configure terminal**
3. **interface port-channel *channel-number***
4. **port-channel load-balance flow-based**
5. **end**

DETAILED STEPS

	Command or Action	Purpose
Step 1	enable Example: Router# enable	Enables the privileged EXEC mode. Enter your password if prompted.

	Command or Action	Purpose
Step 2	configure terminal Example: Router# <code>configure terminal</code>	Enters the global configuration mode.
Step 3	interface port-channel <i>channel-number</i> Example: Router(config)# <code>interface port-channel 1</code>	Creates the port-channel interface.
Step 4	port-channel load-balance flow-based Example: Router(config-if)# <code>port-channel load-balance flow-based</code>	Configures the specified port-channel interface in the flow-based load-balancing mode.
Step 5	end	Exits the configuration mode.

VLAN-Based Manual Load Balancing

Configuring VLAN Based Manual Load Balancing

Perform this task to link a VLAN port channel, and to enable VLAN load balancing on port channels:

SUMMARY STEPS

1. **enable**
2. **configure terminal**
3. **interface port-channel *channel-number***
4. **no ip address**
5. **no negotiation auto**
6. **port-channel load-balancing link 1**
7. **backup link 2**
8. **service-instance 100,300**
9. **port-channel load-balancing link 2**
10. **backup link 1**
11. **service-instance 200,400**
12. **load-balancing vlan**
13. **service instance *id* ethernet**
14. **encapsulation { default | untagged | dot1q *vlan-id* [second-dot1q *vlan-id*] }**
15. **service instance *id* ethernet**
16. **encapsulation { default | untagged | dot1q *vlan-id* [second-dot1q *vlan-id*] }**
17. **service instance *id* ethernet**
18. **encapsulation { default | untagged | dot1q *vlan-id* [second-dot1q *vlan-id*] }**
19. **service instance *id* ethernet**
20. **encapsulation { default | untagged | dot1q *vlan-id* [second-dot1q *vlan-id*] }**

21. **interface** *type number*
22. **no ip address**
23. **no negotiation auto**
24. **channel-group** *channel-number link link-number*
25. **interface** *type number*
26. **no ip address**
27. **no negotiation auto**
28. **channel-group** *channel-number link link-number*
29. **end**

DETAILED STEPS

	Command or Action	Purpose
Step 1	enable Example: Router> enable	Enables the privileged EXEC mode. Enter your password if prompted.
Step 2	configure terminal Example: Router# configure terminal	Enters the global configuration mode.
Step 3	interface port-channel <i>channel-number</i> Example: Router(config)# interface port-channel 1	Enters the interface configuration mode and defines the interface as a port channel.
Step 4	no ip address Example: Router(config-if)# no ip address	Removes an IP address or disables IP processing.
Step 5	no negotiation auto Example: Router(config-if)# no negotiation auto	Disables the advertisement of speed, duplex mode, and flow control on a port-channel interface.
Step 6	port-channel load-balancing link 1 Example: Router(config-if)# port-channel load-balancing link 1	Enables port-channel load balancing on link 1.
Step 7	backup link 2 Example: Router(config-if)# backup link 2	Assigns a backup link 2.
Step 8	service-instance 100,300 Example: Router(config-if)# service-instance 100,300	Creates a service instance on the interface.

	Command or Action	Purpose
Step 9	port-channel load-balancing link 2 Example: Router(config-if)# port-channel load-balancing link 2	Enables port-channel load balancing on link 2.
Step 10	backup link 1 Example: Router(config-if)# backup link 1	Assigns a backup link 1.
Step 11	service-instance 200,400 Example: Router(config-if)# service-instance 200,400	Creates a service instance on the interface.
Step 12	load-balancing vlan Example: Router(config-if)# load-balancing vlan	Enables port-channel load balancing on the router.
Step 13	service instance <i>id</i> ethernet Example: Router(config-if)# service instance 100 ethernet	Creates a service instance on the interface.
Step 14	encapsulation { default untagged dot1q <i>vlan-id</i> [second-dot1q <i>vlan-id</i>] } Example: Router(config-if-srv)# encapsulation dot1q 100	Defines the matching criteria to be used in order to map the ingress dot1q frames on an interface to the appropriate service instance.
Step 15	service instance <i>id</i> ethernet Example: Router(config-if)# service instance 200 ethernet	Creates a service instance on the interface.
Step 16	encapsulation { default untagged dot1q <i>vlan-id</i> [second-dot1q <i>vlan-id</i>] } Example: Router(config-if-srv)# encapsulation dot1q 200	Defines the matching criteria to be used in order to map the ingress dot1q frames on an interface to the appropriate service instance.
Step 17	service instance <i>id</i> ethernet Example: Router(config-if)# service instance 300 ethernet	Creates a service instance on the interface.
Step 18	encapsulation { default untagged dot1q <i>vlan-id</i> [second-dot1q <i>vlan-id</i>] } Example: Router(config-if-srv)# encapsulation dot1q 300	Defines the matching criteria to be used in order to map the ingress dot1q frames on an interface to the appropriate service instance.

	Command or Action	Purpose
Step 19	service instance <i>id</i> ethernet Example: Router(config-if)# service instance 400 ethernet	Creates a service instance on the interface.
Step 20	encapsulation { default untagged dot1q <i>vlan-id</i> [second-dot1q <i>vlan-id</i>] } Example: Router(config-if-srv)# encapsulation dot1q 400	Defines the matching criteria to be used in order to map the ingress dot1q frames on an interface to the appropriate service instance.
Step 21	interface <i>type number</i> Example: Router(config)# interface gigabitethernet0/2/6	Specifies the interface type and number.
Step 22	no ip address Example: Router(config-if)# no ip address	Removes an IP address or disables IP processing.
Step 23	no negotiation auto Example: Router(config-if)# no negotiation auto	Disables the advertisement of speed, duplex mode, and flow control on a port-channel interface.
Step 24	channel-group <i>channel-number</i> link <i>link-number</i> Example: Router(config-if)# channel-group 1 link 1	Assigns a Gigabit Ethernet interface to the specified channel group and link.
Step 25	interface <i>type number</i> Example: Router(config)# interface gigabitethernet0/2/7	Specifies the interface type and number.
Step 26	no ip address Example: Router(config-if)# no ip address	Removes an IP address or disables IP processing.
Step 27	no negotiation auto Example: Router(config-if)# no negotiation auto	Disables the advertisement of speed, duplex mode, and flow control on a port-channel interface.
Step 28	channel-group <i>channel-number</i> link <i>link-number</i> Example: Router(config-if)# channel-group 1 link 1	Assigns a Gigabit Ethernet interface to the specified channel group and link.
Step 29	end Example: Router(config-if)# end	Exits the interface configuration mode, and returns to the privileged EXEC mode.

Example: Ethernet Virtual Connections on Port Channels

Example: Ethernet Virtual Connections on Port Channels

The following example shows how to configure flow-based load balancing on a port-channel interface:

```
Router# enable
Router# configure terminal
Router(config)# interface Port-channel 1
Router(config-if)# port-channel load-balance flow-based
Router(config-if)# end
```

The following example shows how to configure QoS on an EVC port channel:

```
Router> enable
Router# configure terminal
Router(config)# class-map c1-cos2-cos4
match cos 2 match vlan 1
Router(config)# policy-map p1-ingress
Router(config-pmap)# class c1-cos2-cos4
Router(config-pmap-c)# police cir 100000 conform-action set-cos-transmit 4
Router(config)# interface Port-channel1
Router(config-if)# no ip address
Router(config-if)# no negotiation auto
Router(config-if)# load-balancing vlan
Router(config-if)# service instance 1 ethernet
Router(config-if-srv)# encapsulation dot1q 1
Router(config-if-srv)# service-policy input p1-ingress
Router(config-if)# port-channel load-balance link 1
Router(config-if)# backup link 2
Router(config-if)# service-instance 1
Router(config-if)# interface GigabitEthernet3/0/3
Router(config-if)# no ip address
Router(config-if)# no shutdown
Router(config-if)# negotiation auto
Router(config-if)# channel-group 1 link 1
Router(config-if)# interface GigabitEthernet5/0/0
Router(config-if)# no ip address
Router(config-if)# no shutdown
Router(config-if)# negotiation auto
Router(config-if)# channel-group 1 link 2
Router(config-if)# bridge-domain 1
Router(config-if)# member Port-channel1 service-instance 1
```

The following example shows how to use the **show running-config interface port-channel channel-number** command to verify an EVC port channel's per-flow load-balancing configuration:

```
Router# enable
Router# configure terminal
Router(config)# interface Port-channel 2
Router(config-if)# port-channel load-balance flow-based
Router(config-if)# end
Router# show running-config interface Port-channel 2
```

```
Building configuration...
```



```

Current configuration : 113 bytes
!
interface Port-channel2
band width 1000000
no ip address
port-channel load-balance flow-based
end

```

Configuring LACP

To configure the channel mode for each individual link in the LACP port channel, perform the following steps.

SUMMARY STEPS

1. **config t**
2. **interface** *type slot/port*
3. **channel-group number mode** {active | on | passive}
4. **lacp** {port-priority | rate}

DETAILED STEPS

	Command or Action	Purpose
Step 1	config t Example: Router# config t Router(config)#	Enters the configuration mode.
Step 2	interface <i>type slot/port</i> Example: Router(config)# interface GigabitEthernet0/2/0	Specifies the interface to configure, and enters the interface configuration mode.
Step 3	channel-group number mode {active on passive} Example: Router(config-if)# channel-group 1 mode active	Specifies the port mode for the link in a port channel. After the LACP is enabled, configure each link or the entire channel as active or passive. When you run port channels with no associated aggregation protocol, the port channel mode is always on.
Step 4	lacp {port-priority rate} Example: Router(config-if)# lacp port-priority 4000	Configures the port priority for use with the LACP.

Configuring the LACP Mode per Port Channel Interface

To configure the LACP mode on an individual port-channel interface, perform the following steps.

SUMMARY STEPS

1. **interface port-channel** *port-channel number*
2. **lacp** {**fast switch-over** | **max-bundle** | **min-bundle**}

DETAILED STEPS

	Command or Action	Purpose
Step 1	interface port-channel <i>port-channel number</i> Example: Router(config)# interface port-channel 1	Specifies the port channel to configure, and enters the configuration mode.
Step 2	lacp { fast switch-over max-bundle min-bundle } Example: Router (config-int)# lacp max-bundle 4	max-bundle -Specifies the maximum number of ports to bundle in this port channel. fast switch-over -Enables fast switchover on this port channel. min-bundle -Specifies the minimum number of ports to bundle in this port channel. Configures four active links on the port channel. The remaining links are in standby mode. Traffic is load-balanced among the active links.

VLAN Manual Load Balancing on Q-in-Q Interfaces

This section describes VLAN-based manual load balancing for port channel Q-in-Q subinterfaces.

Prerequisites for VLAN Manual Load Balancing on Q-in-Q Interfaces

- The port-channel load-balancing method must be configured as VLAN manual, using the command: **port-channel load-balancing vlan-manual**
- The primary and secondary interfaces must be associated to the same port channel for load balancing to take place.

Restrictions for VLAN Manual Load Balancing on Q-in-Q Interfaces

- All the physical ports that form the member links of a port channel must have the same bandwidth capacity.
- The same primary and secondary VLAN IDs must be configured on both the devices.

Information About VLAN Manual Load Balancing on Q-in-Q Interfaces

Cisco ASR 1000 devices support VLAN-based manual load balancing on single VLAN interfaces. User can manually assign VLAN subinterfaces to primary and secondary GEC (Gigabit Ethernet Channel) member links. However, this feature is not supported on port channel Q-in-Q subinterfaces.

The following CLI enhancement is introduced to enable VLAN-based manual load balancing on port channel Q-in-Q subinterfaces:

```
Router(config)# int Port-channel x.y
Router(config-subif)# encapsulation dot1q <outer vlan> second-dot1q <inner-vlan> primary
<primary interface> secondary <secondary interface>
```

With this enhancement, users can direct traffic flows to a particular subinterface bucket with the load-balancing algorithm.

Configure VLAN Manual Load Balancing on Q-in-Q Interfaces

To configure VLAN Manual Load Balancing on Q-in-Q Interfaces, perform the following steps.

SUMMARY STEPS

1. **enable**
2. **configure terminal**
3. **port-channel load-balancing***vlan-manual*
4. **interface port-channel** *channel-number.subinterface-number*
5. **encapsulation dot1q***<outer vlan>***second-dot1q***<inner vlan>***primary***<primary interface>***secondary***<secondary interface>*
6. **ip address** *ip-address mask*
7. **exit**

DETAILED STEPS

	Command or Action	Purpose
Step 1	enable Example: Device> enable	Enables privileged EXEC mode. Enter your password, if prompted.
Step 2	configure terminal Example: Device# configure terminal	Enters global configuration mode.
Step 3	port-channel load-balancing <i>vlan-manual</i> Example: Device(config)# port-channel load-balancing vlan-manual	Configures port channel load balancing method as VLAN manual.
Step 4	interface port-channel <i>channel-number.subinterface-number</i> Example:	Configures a port channel interface and enters interface configuration mode.

	Command or Action	Purpose
	Device(config)# interface port-channel 10.100	
Step 5	<p>encapsulation dot1q<outer vlan>second-dot1q<inner vlan>primary<primary interface>secondary<secondary interface></p> <p>Example:</p> <pre>Device(config-subif)# encapsulation dot1Q 100 second-dot1q 200 primary TenGigabitEthernet0/0/2 secondary TenGigabitEthernet0/0/0</pre>	<p>Enables the 802.1Q encapsulation of traffic on a specified subinterface in a VLAN.</p> <ul style="list-style-type: none"> • Use the second-dot1q keyword to specify the VLAN tags to be terminated in the subinterface. • Use the primary and secondary keywords to specify the primary and secondary subinterfaces.
Step 6	<p>ip address ip-address mask</p> <p>Example:</p> <pre>Device(config-subif)# ip address 192.168.12.2 255.255.255.0</pre>	Sets the IP address and subnet mask for the specified GE interface.
Step 7	<p>exit</p> <p>Example:</p> <pre>Device(config-subif)# exit</pre>	Exits interface configuration mode and returns to global configuration mode.

Verify VLAN Manual Load Balancing on Q-in-Q Interfaces

The following is a sample output for VLAN manual load balancing in Q-in-Q port channel subinterface with primary and secondary interfaces:

```
Router# show run interface port-channel 20.100
interface Port-channel20.100
 encapsulation dot1Q 100 second-dot1q 200 primary TenGigabitEthernet0/0/2 secondary
TenGigabitEthernet0/0/0
 ip address 192.168.12.1 255.255.255.0
end
```

```
Router# show interface port-channel 20 etherchannel
All IDBs List contains 2 configured interfaces
Port: TenGigabitEthernet0/0/2 (index: 0)
Port: TenGigabitEthernet0/0/0 (index: 1)
```

```
Active Member List contains 2 interfaces
Port: TenGigabitEthernet0/0/2
LACP Mode: Active
VLAN 100 (Pri, Ac, C, P)
Port: TenGigabitEthernet0/0/0
LACP Mode: Active
VLAN 100 (Sec, St, C, P)
Passive Member List contains 0 interfaces
Load-Balancing method applied: vlan-manual
```

```
Bucket Information for VLAN Manual LB:
Bucket 0 (p=TenGigabitEthernet0/0/0, s=TenGigabitEthernet0/0/0) active
TenGigabitEthernet0/0/0
Bucket 1 (p=TenGigabitEthernet0/0/0, s=TenGigabitEthernet0/0/2) active
TenGigabitEthernet0/0/0
Bucket 16 (p=TenGigabitEthernet0/0/2, s=TenGigabitEthernet0/0/0) active
TenGigabitEthernet0/0/2
```

```

    Bucket 17 (p=TenGigabitEthernet0/0/2, s=TenGigabitEthernet0/0/2) active
TenGigabitEthernet0/0/2

```

The following is a sample output for two subinterfaces on the same port channel, with the same combination of primary and secondary interfaces:

```

Router# show run interface port-channel 20.100
interface Port-channel20.100
  encapsulation dot1q 100 second-dot1q 200 primary TenGigabitEthernet0/0/0 secondary
TenGigabitEthernet0/0/2
  ip address 192.168.12.1 255.255.255.0
end

```

```

Router# show run interface port-channel 20.600
interface Port-channel20.600
  encapsulation dot1q 600 second-dot1q 800 primary TenGigabitEthernet0/0/0 secondary
TenGigabitEthernet0/0/2
  ip address 192.168.20.1 255.255.255.0
end

```

```

Router# show interface port-channel 20 etherchannel
All IDBs List contains 2 configured interfaces
  Port: TenGigabitEthernet0/0/2 (index: 0)
  Port: TenGigabitEthernet0/0/0 (index: 1)

Active Member List contains 2 interfaces
  Port: TenGigabitEthernet0/0/2
    LACP Mode: Active
    VLAN 100 (Pri, Ac, C, P)   VLAN 600 (Sec, St, C, P)
  Port: TenGigabitEthernet0/0/0
    LACP Mode: Active
    VLAN 100 (Sec, St, C, P)   VLAN 600 (Pri, Ac, C, P)
Passive Member List contains 0 interfaces
Load-Balancing method applied: vlan-manual

```

```

Bucket Information for VLAN Manual LB:
  Bucket 0 (p=TenGigabitEthernet0/0/0, s=TenGigabitEthernet0/0/0) active
TenGigabitEthernet0/0/0
  Bucket 1 (p=TenGigabitEthernet0/0/0, s=TenGigabitEthernet0/0/2) active
TenGigabitEthernet0/0/0
  Bucket 16 (p=TenGigabitEthernet0/0/2, s=TenGigabitEthernet0/0/0) active
TenGigabitEthernet0/0/2
  Bucket 17 (p=TenGigabitEthernet0/0/2, s=TenGigabitEthernet0/0/2) active
TenGigabitEthernet0/0/2

```

The following is a sample output for VLAN manual load balancing on Q-in-Q 802.1ad port channel subinterface with primary and secondary interfaces:

```

Router# show interface port-channel 20 etherchannel
All IDBs List contains 2 configured interfaces
  Port: TenGigabitEthernet0/0/3 (index: 0)
  Port: TenGigabitEthernet0/0/1 (index: 1)

Active Member List contains 2 interfaces
  Port: TenGigabitEthernet0/0/1
    VLAN 1 (Sec, St, D, P)   VLAN 900 (Sec, St, D, P)
  Port: TenGigabitEthernet0/0/3
    VLAN 1 (Pri, Ac, D, P)   VLAN 900 (Pri, Ac, D, P)
Passive Member List contains 0 interfaces
Load-Balancing method applied: vlan-manual

Bucket Information for VLAN Manual LB:
  Bucket 0 (p=TenGigabitEthernet0/0/3, s=TenGigabitEthernet0/0/3) active
TenGigabitEthernet0/0/3
  Bucket 1 (p=TenGigabitEthernet0/0/3, s=TenGigabitEthernet0/0/1) active

```

```
TenGigabitEthernet0/0/3
  Bucket 16 (p=TenGigabitEthernet0/0/1, s=TenGigabitEthernet0/0/3) active
TenGigabitEthernet0/0/1
  Bucket 17 (p=TenGigabitEthernet0/0/1, s=TenGigabitEthernet0/0/1) active
TenGigabitEthernet0/0/1
Router#
```



CHAPTER 32

Configuring Traffic Storm Control

This topic describes how to configure the Traffic Storm Control feature on a Cisco ASR 1000 Series Aggregated Services Router.

- [Understanding Traffic Storm Control, on page 697](#)
- [Prerequisites for Configuring Traffic Storm Control, on page 697](#)
- [Configuring Traffic Storm Control, on page 697](#)
- [Examples, on page 699](#)
- [Example: Configuring a Traffic Storm Control CIR, on page 700](#)

Understanding Traffic Storm Control

A traffic storm occurs when packets flood the LAN, creating excessive traffic and degrading network performance. The Traffic Storm Control feature prevents LAN ports from being disrupted by a broadcast, multicast, or unicast traffic storm on physical interfaces.

On a Cisco ASR 1000 Series Aggregated Services Router, you can configure a bits per second policer committed information rate (CIR) on a service instance for broadcast, multicast, or unknown unicast traffic. The Hardware Assistant Policer Engine ensures that the rate does not exceed the configured policer rate. When the traffic exceeds the configured rate, packets are dropped to control the traffic.



Note Traffic storm control is disabled by default.

Prerequisites for Configuring Traffic Storm Control

Ensure that you configure separate storm control policers for each of the broadcast, multicast, and unknown unicast traffic types. Traffic types that do not have a configured policer will not be traffic controlled. For example, multicast traffic will not be traffic controlled if you do not configure a storm control policer for it.

Configuring Traffic Storm Control

Perform the following steps to configure traffic storm control:

SUMMARY STEPS

1. **interface** *{{type slot/port} | {port-channel number}}*
2. **no ip address**
3. **negotiation auto**
4. **service instance** *id ethernet*
5. **encapsulation dot1q** *vlan-id*
6. **storm-control** *{{unicast | broadcast | multicast} cir cir-value}*
7. **bridge-domain** *bridge-id*
8. **end**

DETAILED STEPS

	Command or Action	Purpose
Step 1	interface <i>{{type slot/port} {port-channel number}}</i> Example: Router(config)# interface GigabitEthernet 0/0/0	Selects an interface to configure.
Step 2	no ip address Example: Router(config-if)# no ip address	Disables IP address processing.
Step 3	negotiation auto Example: Router(config-if)# negotiation auto	Enables advertisement of speed, duplex mode, and flow control on a Gigabit Ethernet interface.
Step 4	service instance <i>id ethernet</i> Example: Router(config-if)# service instance 1 ethernet	Configures an Ethernet service instance on an interface and enters the Ethernet service configuration mode.
Step 5	encapsulation dot1q <i>vlan-id</i> Example: Router(config-if-srv)# encapsulation dot1q 1-4094	Defines the matching criteria to be used in order to map ingress dot1q frames on an interface with the appropriate service instance.
Step 6	storm-control <i>{{unicast broadcast multicast} cir cir-value}</i> Example: Router(config-if-srv)# storm-control unicast cir 8000 Router(config-if-srv)# storm-control broadcast cir 1500000 Router(config-if-srv)# storm-control multicast cir 980000000	Sets the storm control rate for unicast, broadcast, or multicast.
Step 7	bridge-domain <i>bridge-id</i> Example: Router(config-if-srv)# bridge-domain 1	Binds the service instance to a bridge domain instance where bridge-id is the identifier.

	Command or Action	Purpose
Step 8	end	Exits the configuration mode.

Examples

Example: Examples

The following example shows how to configure storm control rates for unicast, broadcast, and multicast traffic:

```
Router(config)# interface GigabitEthernet0/0/0
Router(config-if)# no ip address
Router(config-if)# negotiation auto
Router(config-if)# service instance 1 ethernet
Router(config-if-srv)# encapsulation dot1q 1-4094
Router(config-if-srv)# storm-control unicast cir 8000
Router(config-if-srv)# storm-control broadcast cir 1500000
Router(config-if-srv)# storm-control multicast cir 9800000000
Router(config-if-srv)# bridge-domain 1
```

Use the **show ethernet service instance id 1 interface GigabitEthernet 0/0/0 stats** command to view the storm control statistics.

```
Router# show ethernet service instance id 1 interface GigabitEthernet0/0/0 stats

Port maximum number of service instances: 8000
Service Instance 1, Interface GigabitEthernet0/0/0
  Pkts In   Bytes In  Pkts Out  Bytes Out
    0         0         0         0
StormControl Discard Pkts:
  Broadcast  Multicast  Unknown  Unicast
    0         0         0         0
```

Use the **show platform software ethernet fp active efp id 1 interface GigabitEthernet0/0/0** command to view the Ethernet Flow Point (EFP) information in slot 1 of a Cisco ASR 1000 Series Aggregation Services Router.

```
Router# show platform software ethernet fp active efp id 1 interface GigabitEthernet0/0/0

Forwarding Manager Ethernet Flow Points

EFP: ID: 1, DPIDB: 0x1020010, Data Type: static
  Interface: 8 (GigabitEthernet0/0/0)
  QFPIDX: 21
  QFPifname: GigabitEthernet0/0/0.EFP1
  State: AdminDown, Priority: 10
  First tag encap: dot1q, vlan-type: 0x8100
  vlan list: 1-4094
  DOT1AD Port Type: UNI
  Storm ctrl u_cir: 8000, m_cir: 9800000000, b_cir: 1500000
  Bridge-domain: 1, Split-Horizon: None
  MAC-limit: 65536
```

Example: Configuring a Traffic Storm Control CIR

Example: Configuring a Traffic Storm Control CIR

Use the **storm-control {broadcast|unicast|multicast [cos <value>] cir <value>}** command to configure the traffic storm control CIR for a Class of Service (CoS) and an address type. If you do not specify the CoS, but specify a CIR value, the default value for all the CoSs that are not specified will be an aggregate of the specified CIR. For example, in the following configuration, CIR 20000 will be the default CIR value for CoS 0,3,4,5, and 6 for the broadcast MAC address:

```
Router(config)# interface gig 2/0
Router(config)# service instance 100 ethernet
Router(config-if)# storm-control broadcast cir 20000
Router(config-if)# storm-control broadcast cos 1 cir 10000
Router(config-if)# storm-control broadcast cos 2 cir 15000
Router(config-if)# storm-control broadcast cos 7 cir 15000
```



Note Ensure that you configure the default CIR first before configuring the per CoS CIR. If the default CIR is not configured, the **cos** keyword will be disabled from the CLI. Before deleting the default CIR, ensure that you remove all per-CoS CIRs for the same address type.



CHAPTER 33

Cisco ThousandEyes Enterprise Agent Application Hosting

This chapter provides information on Cisco ThousandEyes Enterprise Agent Application Hosting. The following sections are included in this chapter:

- [Cisco ThousandEyes Enterprise Agent Application Hosting, on page 701](#)
- [Supported Platforms and System Requirements, on page 702](#)
- [Workflow to Install and Run the Cisco ThousandEyes Application, on page 703](#)
- [Modifying the Agent Parameters, on page 707](#)
- [Uninstalling the Application, on page 707](#)
- [Troubleshooting the Cisco ThousandEyes Application, on page 707](#)

Cisco ThousandEyes Enterprise Agent Application Hosting

Cisco ThousandEyes is a network intelligence platform that allows you to use its agents to run a variety of tests from its agents to monitor the network and application performance. This application enables you to view end-to-end paths across networks and services that impact your business. Cisco ThousandEyes application actively monitors the network traffic paths across internal, external, and internet networks in real time, and helps to analyse the network performance. Also, Cisco ThousandEyes application provides application availability insights that are enriched with routing and device data for a multidimensional view of digital experience.

From Cisco IOS XE Release 17.8.1, you can use application-hosting capabilities to deploy the Cisco ThousandEyes Enterprise Agent as a container application on Cisco 1000 Series Aggregation Services Routers. This agent application runs as a docker image using Cisco IOx docker-type option. For more information on how to configure Cisco ThousandEyes in controller mode, see [Cisco SD-WAN Systems and Interfaces Configuration Guide](#).

Figure 26: Network View through ThousandEyes Application

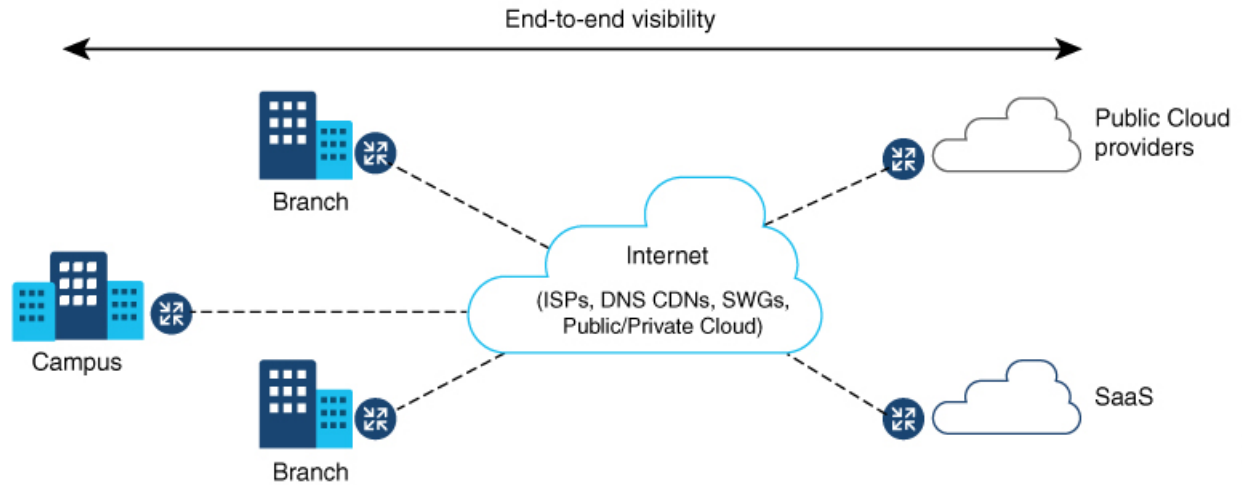

Feature Information for Cisco ThousandEyes Enterprise Agent Application Hosting

The following table provides release information about the feature or features described in this module. This table lists only the software release that introduced support for a given feature in a given software release train. Unless noted otherwise, subsequent releases of that software release train also support that feature.

Use Cisco Feature Navigator to find information about platform support and Cisco software image support. To access Cisco Feature Navigator, go to www.cisco.com/go/cfn. An account on Cisco.com is not required.

Table 54: Feature Information for ThousandEyes Enterprise Agent Application Hosting

Feature Name	Releases	Feature Information
Cisco ThousandEyes Enterprise Agent Application Hosting	Cisco IOS XE 17.8.1	With the integration of ThousandEyes Agent Application running on routing platforms using the App hosting capabilities as container, you can have visibility into application experience with deep insights into the Internet, cloud providers, and enterprise networks.

Supported Platforms and System Requirements

The following table lists the supported platforms and system requirements.

Platforms	Bootflash	FRU Storage	DRAM
Cisco 1000 Series Aggregation Services Routers			
ASR1001-X	8 GB	(Optional) SSD and eUSB	8 GB, 16 GB
ASR1001-HX	32 GB	(Optional) SSD and eUSB	8 GB, 16 GB

Platforms	Bootflash	FRU Storage	DRAM
ASR1002-X	8 GB	(Optional) SSD and eUSB	8 GB
ASR 1002-HX	32 GB	(Optional) SSD and eUSB	16 GB
ASR1006 (RP2)	8 GB	80 GB HDD	8 GB
ASR1006-X/ASR1009-X (RP3)	8 GB	(Default) 100 GB SSD	8 GB



Note The minimum DRAM and bootflash storage requirement for running Cisco ThousandEyes Enterprise Agent is 8 GB. If the device does not have enough memory or storage, we recommend that you upgrade DRAM or add an external storage such as SSD/M.2 USB. When the available resources are not sufficient to run other applications, Cisco IOx generates an error message.

Workflow to Install and Run the Cisco ThousandEyes Application

To install and run the Cisco ThousandEyes image on a device, perform these steps:

- Step 1** Create a new account on the Cisco ThousandEyes portal.
- Step 2** Download the Cisco ThousandEyes application package from the [software downloads](#) page and ensure that you use the agent version 4.2.2.
- Step 3** Copy the image on the device.
- Step 4** Install and launch the image.
- Step 5** Connect the agent to the controller.

Note When you order platforms that support Cisco ThousandEyes application with Cisco IOS XE 17.8.1 software, the Cisco ThousandEyes application package is available in the bootflash of the device.

Workflow to Host the Cisco ThousandEyes Application

To install and launch the application, perform these steps:

Before you begin

Create a new account on the Cisco ThousandEyes portal and generate the token. The Cisco ThousandEyes agent application uses this token to authenticate and check into the correct Cisco ThousandEyes account. you see a message stating that your token is invalid and you want to troubleshoot the issue, see [Troubleshooting the Cisco ThousandEyes Application, on page 707](#).



Note If you configure the correct token and Domain Name Server (DNS) information, the device is discovered automatically.

Step 1 Enable Cisco IOX application environment on the device.

- Use the following commands for non-SD-WAN (autonomous mode) images:

```
config terminal
  iox
end
write
```

- Use the following commands for SD-WAN (controller mode) images:

```
config-transaction
iox
commit
```

Step 2 If the IOx command is accepted, wait for a few seconds and check whether the IOx process is up and running by using the **show iox** command. The output must display that the show IOxman process is running.

```
Device #show iox
```

```
IOx Infrastructure Summary:
-----
IOx service (CAF) 1.11.0.0      : Running
IOx service (HA)                : Not Supported
IOx service (IOxman)            : Running
IOx service (Sec storage)       : Not Supported
Libvirt 1.3.4                   : Running
```

Step 3 Ensure that the ThousandEyes application LXC tarball is available in the device *bootflash*:

Step 4 Create a virtual port group interface to enable the traffic path to the Cisco ThousandEyes application:

```
interface VirtualPortGroup 0
  ip address 192.168.35.1 255.255.255.0
exit
```

Step 5 Configure the app-hosting application with the generated token:

```
app-hosting appid te
  app-vnic gateway1 virtualportgroup 0 guest-interface 0
  guest-ipaddress 192.168.35.2 netmask 255.255.255.0
  app-default-gateway 192.168.35.1 guest-interface 0
  app-resource docker
    prepend-pkg-opts  Required to get the default run-time options from package.yaml

    run-opts 1 "--hostname thousandeyes"
    run-opts 2 "-e TEAGENT_ACCOUNT_TOKEN=<ThousandEyes token>"
  run-opts 3 "-e TEAGENT_PROXY_TYPE=STATIC -e TEAGENT_PROXY_LOCATION=proxy.something.other:80"

  name-server0 75.75.75.75  ISP's DNS server
end

app-hosting appid te
```

```
app-resource docker
prepend-pkg-opts
run-opts 2 "--hostname
```

Note You can use the proxy configuration only if the Cisco ThousandEyes agent does not have an internet access without a proxy. Also, the hostname is optional. If you do not provide the hostname during the installation, the device hostname is used as the Cisco ThousandEyes agent hostname. The device hostname is displayed on the Cisco ThousandEyes portal. The DNS name server information is optional. If the Cisco ThousandEyes agent uses a private IP address, ensure that you establish a connection to the device through NAT.

Step 6 Configure the **start** command to run the application automatically when the application is installed on the device using the **install** command:

```
app-hosting appid te
start
```

Step 7 Install the ThousandEyes application:

```
app-hosting install appid <appid> package [bootflash: | harddisk: | https:]
```

Select a location to install the ThousandEyes application from these options:

```
Device# app-hosting install appid te package ?
bootflash: Package path  ISR4K case if image is locally available in bootflash:
harddisk:   Package path  Cat8K case if image is locally available in M.2 USB
https:     Package path  Download over the internet if image is not locally present in
router. URL to ThousandEyes site hosting agent image to be provided here
```

Step 8 Check if the application is up and running:

```
Device#show app-hosting list
App id                               State
-----
te                                    RUNNING
```

Note If any of these steps fail, use the **show logging** command and check the IOx error message. If the error message is about insufficient disk space, clean the storage media (bootflash or hard disk) to free up the space. Use the **show app-hosting resource** command to check the CPU and disk memory.

Downloading and Copying the Image to the Device

To download and copy the image to bootflash, perform these steps:

Step 1 Check if the Cisco ThousandEyes image is precopied to *bootflash:/<directory name>*.

Step 2 If the image is not available in the device directory, perform these steps:

- a) If the device has a direct access to internet, use the *https:* option in the **application install** command. This option downloads the image from the Cisco ThousandEyes software downloads page into *bootflash:/apps* and installs the application.

```
Device# app-hosting install appid <appid string> package [bootflash: | flash | http | https://
| ftp | ] URL to image location hosted on ThousandEyes portal
```

```

Device# app-hosting install appid tel1000 package
https://downloads.thousandeyes.com/enterprise-agent/thousandeyes-enterprise-agent-4.0.2.cisco.tar

Installing package
'https://downloads.thousandeyes.com/enterprise-agent/thousandeyes-enterprise-agent-4.0.2.cisco.tar'
for 'tel1000'.

Use 'show app-hosting list' for progress.
*Jun 29 23:43:29.244: %IOSXE-6-PLATFORM: R0/0: IOx: App verification successful
*Jun 29 23:45:00.449: %IM-6-INSTALL_MSG: R0/0: ioxman: app-hosting: Install succeeded: tel1000
installed successfully Current state is DEPLOYED
*Jun 29 23:45:01.801: %IOSXE-6-PLATFORM: R0/0: IOx: App verification successful
*Jun 29 23:45:51.054: %IM-6-START_MSG: R0/0: ioxman: app-hosting: Start succeeded: tel1000 started
successfully Current state is RUNNING

Device#show app-hosting detail appid tel1000 (Details of Application)
App id          : tel1000
Owner           : iox
State          : RUNNING
Application
  Type          : docker
  Name          : ThousandEyes Enterprise Agent
  Version       : 4.0
  Author        : ThousandEyes <support@thousandeyes.com>
  Path          : bootflash:thousandeyes-enterprise-agent-4.0-22.cisco.tar
Resource reservation
  Memory        : 500 MB
  Disk          : 1 MB
  CPU           : 1500 units
  CPU-percent   : 70 %

```

- b) If the device has a proxy server, copy the image manually to *bootflash:/apps*.
- c) Download the Cisco ThousandEyes application package from the [software downloads](#) page and ensure that you use the agent version 4.0.2.
- d) Create an application directory in the *bootflash:* to copy the image:

```

Device# mkdir bootflash:apps
Create directory filename [apps]?
Created dir bootflash:/apps

```

- e) Copy the Cisco ThousandEyes image to the *bootflash:apps* directory.
- f) Validate the image using the **verify** command:

```

verify /md5 bootflash:apps/<file name>

```

Connecting the Cisco ThousandEyes Agent with the Controller

Before you begin

Ensure that you have an Internet connection before you connect the agent with the controller.

After the Cisco ThousandEyes application is up and running, the agent (ThousandEyes-agent) process connects to the controller that is running on the cloud environment.

Note If you have issues related to connectivity, the application logs the relevant error messages in the application-specific logs (*/var/logs*).

Modifying the Agent Parameters

To modify the agent parameters, perform these actions:

- Step 1** Stop the application using the **app-hosting stop appid appid** command.
 - Step 2** Deactivate the application using the **app-hosting deactivate appid appid** command.
 - Step 3** Make the required changes to app-hosting configuration.
 - Step 4** Activate the application using the **app-hosting activate appid appid** command.
 - Step 5** Start the application using the **app-hosting start appid appid** command.
-

Uninstalling the Application

To uninstall the application, perform these steps:

- Step 1** Stop the application using the **app-hosting stop appid te** command.
 - Step 2** Check if the application is in active state using the **show app-hosting list** command.
 - Step 3** Deactivate the application using the **app-hosting deactivate appid te** command.
 - Step 4** Ensure that the application is not in active state. Use the **show app-hosting list** command to check status of the application.
 - Step 5** Uninstall the application using the **app-hosting uninstall appid te** command.
 - Step 6** After the uninstallation process is complete, use the **show app-hosting list** command to check if the application is uninstalled successfully.
-

Troubleshooting the Cisco ThousandEyes Application

To troubleshoot the Cisco ThousandEyes application, perform these steps:

1. Connect to Cisco ThousandEyes agent application using the **app-hosting connect appid appid session /bin/bash** command.
2. Verify the configuration applied to the application at the following path */etc/te-agent.cfg*.
3. View the logs at the following path */var/log/agent/te-agent.log*. You can use these logs to troubleshoot the configuration.

Checking the ThousandEyes Application Status

When the Cisco ThousandEyes application is in running state, it is registered on the ThousandEyes portal. If the application does not show up in a few minutes after the agent is in running state, check the following using the **app-hosting connect appid thousandeyes_enterprise_agent session** command:

```
Device#app-hosting connect appid thousandeyes_enterprise_agent session
Device# cat /var/log/agent/te-agent.log
2021-02-04 08:59:29.642 DEBUG [e4736a40] [te.agent.AptPackageInterface] {} Initialized APT
package interface
2021-02-04 08:59:29.642 INFO [e4736a40] [te.agent.main] {} Agent version 1.103.0 starting.
Max core size is 0 and max open files is 1024
2021-02-04 08:59:29.642 DEBUG [e4736a40] [te.agent.db] {} Vacuuming database
2021-02-04 08:59:29.643 INFO [e4736a40] [te.agent.db] {} Found version 0, expected version
50
2021-02-04 08:59:29.672 INFO [e4708700] [te.probe.ServerTaskExecutor] {} ProbeTaskExecutor
started with 2 threads.
2021-02-04 08:59:29.673 INFO [e2f05700] [te.probe.ProbeTaskExecutor.bandwidth] {}
ProbeTaskExecutor started with 1 threads.
2021-02-04 08:59:29.673 INFO [e2704700] [te.probe.ProbeTaskExecutor.realtime] {}
ProbeTaskExecutor started with 1 threads.
2021-02-04 08:59:29.673 INFO [e1f03700] [te.probe.ProbeTaskExecutor.throughput] {}
ProbeTaskExecutor started with 1 threads.
2021-02-04 08:59:29.674 DEBUG [e4736a40] [te.agent.DnssecTaskProceessor] {} Agent is not
running bind
2021-02-04 08:59:29.674 DEBUG [e4736a40] [te.snmp.RequestDispatcher] {} Initialised SNMP++
session
2021-02-04 08:59:29.674 DEBUG [e4736a40] [te.snmp.RequestDispatcher] {} Initialised SNMP++
session
2021-02-04 08:59:29.674 DEBUG [e4736a40] [te.snmp.RequestDispatcher] {} Initialised SNMP++
session
2021-02-04 08:59:29.674 INFO [e4736a40] [te.agent.main] {} Agent starting up
2021-02-04 08:59:29.675 INFO [e4736a40] [te.agent.main] {} No agent id found, attempting
to obtain one
2021-02-04 08:59:29.675 INFO [e4736a40] [te.agent.ClusterMasterAdapter] {} Attempting to
get agent id from scl.thousandeyes.com
2021-02-04 08:59:29.679 ERROR [e4736a40] [te.agent.main] {} Error calling create_agent:
Curl error - Couldn't resolve host name
2021-02-04 08:59:29.680 INFO [e4736a40] [te.agent.main] {} Sleeping for 30 seconds
Note :
```



Note Check the DNS server connection. If the Cisco ThousandEyes agent is assigned to a private IP address, check the NAT configuration.



CHAPTER 34

Online Diagnostics

The online diagnostics contain tests to check different hardware components and verify the status of the software process and interfaces.

- [Scheduling Online Diagnostics, on page 709](#)
- [Configuring Health-Monitoring Diagnostics, on page 709](#)
- [Generic Online Diagnostic Commands, on page 709](#)
- [Generic Online Diagnostic EXEC Commands, on page 710](#)
- [Generic Online Diagnostic Show commands, on page 710](#)
- [Generic Online Diagnostic Example, on page 710](#)
- [Health Monitoring Diagnostics Configuration Example, on page 712](#)
- [Slot and Subslot Level Show Commands Output Example, on page 715](#)

Scheduling Online Diagnostics

You can schedule online diagnostics to run at a designated time of day or on a daily, weekly, or monthly basis for a specific router. Use the **no** form of this command to remove the scheduling.

For information on how to configure, see the configuration example sections.

Configuring Health-Monitoring Diagnostics

You can configure health-monitoring diagnostic testing on a specified router while the router is connected to a live network. You can configure the execution interval for each health-monitoring test, whether or not to generate a system message upon a test failure, or to enable or disable an individual test. Use the **no** form of this command to disable testing.

For information on how to configure Health Monitoring diagnostics, see the *Health-Monitoring Diagnostics Example* section.

Generic Online Diagnostic Commands

```
diagnostic monitor slot slot num test test num
diagnostic monitor syslog
diagnostic monitor threshold slot slot num test test num failure count threshold value
diagnostic schedule slot slot num/all test test num
```

```
diagnostic event-log size size value
diagnostic monitor interval slot slot num test test num interval
```

Generic Online Diagnostic EXEC Commands

```
diagnostic start slot slot num test test num
diagnostic stop slot slot num test test num
clear diagnostic event-log slot slot num/all
test diagnostic simulation [failure | clear] slot slot num test test id
```

EXEC commands to support subslot

```
diagnostic start subslot slot num>/<bay num test test num
diagnostic stop subslot <slot num>/<bay num> test test num
test diagnostic simulation [failure | clear] subslot <slot num>/<bay num> test test id
```

Generic Online Diagnostic Show commands

```
show diagnostic bootup level
show diagnostic slot slot num/all
show diagnostic schedule slot slot num/all
show diagnostic result slot slot num/all
show diagnostic result slot slot num/all detail
show diagnostic events slot slot num/all
show diagnostic content slot slot num/all
show diagnostic description slot slot num/all
show diagnostic status
show diagnostic ondemand test-parameter slot slot num test testid
show diagnostic simulation failure slot slot num
```

show command to support subslot

```
show diagnostic subslot slot num/bay num
show diagnostic schedule subslot slot num/bay num
show diagnostic result subslot slot num/bay num
show diagnostic result subslot slot num/bay num detail
show diagnostic events subslot slot num/bay num
show diagnostic content subslot slot num/bay num
show diagnostic description subslot slot num/bay num
show diagnostic content subslot slot num/bay num
show diagnostic ondemand test-parameter subslot slot num/bay num test testid
show diagnostic simulation failure subslot slot num>/bay num
```

Generic Online Diagnostic Example

```
Router#show diagnostic slot 1

Current bootup diagnostic level: minimal

slot 1: ASR1000-MIP100      SerialNo : JAE210500MM

Overall Diagnostic Result for slot 1 : PASS
Diagnostic level at card bootup: minimal

Test results: (. = Pass, F = Fail, U = Untested)
```

```

1) Np5cHeartbeatTest -----> .
2) AstroIlkTest -----> .
3) LCFpgaScratchTest -----> .
4) CCEOBCLinkStateTest -----> .
    
```

```
slot 1: ASR1000-MIP100          SerialNo : JAE18160AM6
```

```
Overall Diagnostic Result for slot 1 : PASS
Diagnostic level at card bootup: minimal
```

```
Test results: (. = Pass, F = Fail, U = Untested)
```

```

1) EPAPpgaScratchTest -----> .
2) EPAStatusTest -----> .
3) EPAHostPrbsStausTest -----> .
4) EPAXcvrTest:
    
```

```

Port  0  1  2  3  4  5  6  7  8  9
-----
      U  U  U  U  U  U  U  U  U  U
    
```

```
Router#show diagnostic subslot 1/1
```

```
Current bootup diagnostic level: minimal
```

```
subslot 1/1: EPA-10X10GE          SerialNo : JAE18160AM6
```

```
Overall Diagnostic Result for subslot 1/1 : PASS
Diagnostic level at card bootup: minimal
```

```
Test results: (. = Pass, F = Fail, U = Untested)
```

```

1) EPAPpgaScratchTest -----> .
2) EPAStatusTest -----> .
3) EPAHostPrbsStausTest -----> .
4) EPAXcvrTest:
    
```

```

Port  0  1  2  3  4  5  6  7  8  9
-----
      U  U  U  U  U  U  U  U  U  U
    
```

```
Router#show diagnostic subslot 1/1 detail
```

```
Current bootup diagnostic level: minimal
```

```
subslot 1/1: EPA-10X10GE          SerialNo : JAE18160AM6
```

```
Overall Diagnostic Result for subslot 1/1 : PASS
Diagnostic level at card bootup: minimal
```

```
Test results: (. = Pass, F = Fail, U = Untested)
```

```
1) EPAPpgaScratchTest -----> .
```

```

Error code -----> 0 (DIAG_SUCCESS)
Total run count -----> 1
Last test testing type -----> OnDemand
Last test execution time ----> Mar 05 2019 14:17:05
First test failure time -----> n/a
Last test failure time -----> n/a
Last test pass time -----> Mar 05 2019 14:17:05
    
```

```
Total failure count -----> 0
Consecutive failure count ---> 0
```

```
2) EPAStatusTest -----> .
```

```
Error code -----> 0 (DIAG_SUCCESS)
Total run count -----> 1
Last test testing type -----> OnDemand
Last test execution time ----> Mar 05 2019 14:17:05
First test failure time -----> n/a
Last test failure time -----> n/a
Last test pass time -----> Mar 05 2019 14:17:05
Total failure count -----> 0
Consecutive failure count ---> 0
```

```
3) EPAHostPrbsStausTest -----> .
```

```
Error code -----> 0 (DIAG_SUCCESS)
Total run count -----> 1
Last test testing type -----> OnDemand
Last test execution time ----> Mar 05 2019 14:17:05
First test failure time -----> n/a
Last test failure time -----> n/a
Last test pass time -----> Mar 05 2019 14:17:05
Total failure count -----> 0
Consecutive failure count ---> 0
```

```
4) EPAXcvrTest:
```

```
Port 0 1 2 3 4 5 6 7 8 9
-----
      U U U U U U U U U U
```

```
Error code -----> 1 (DIAG_FAILURE)
Total run count -----> 1
Last test testing type -----> OnDemand
Last test execution time ----> Mar 05 2019 14:17:05
First test failure time -----> Mar 05 2019 14:17:05
Last test failure time -----> Mar 05 2019 14:17:05
Last test pass time -----> n/a
Total failure count -----> 1
Consecutive failure count ---> 1
```

Health Monitoring Diagnostics Configuration Example

Slot command example :

```
Router#conf t
Enter configuration commands, one per line. End with CNTL/Z.
Router(config)#
Router(config)#diagnostic monitor slot 2 test ?
```

Diagnostics test suite attributes:

```
M/C/* - Minimal bootup level test / Complete bootup level test / NA
E/* - Basic ondemand test / NA
P/V/* - Per port test / Per device test / NA
D/N/* - Disruptive test / Non-disruptive test / NA
```

S/* - Only applicable to standby unit / NA
 X/* - Not a health monitoring test / NA
 F/* - Fixed monitoring interval test / NA
 E/* - Always enabled monitoring test / NA
 A/I - Monitoring is active / Monitoring is inactive

ID	Test Name	Attributes	Test Interval day hh:mm:ss.ms	Three- day shold
1)	Np5cHeartbeatTest	*B*N***I	000 00:00:05.00	n/a
2)	AstroIlkTest	*B*N***I	000 00:01:00.00	n/a
3)	LCFpgaScratchTest	*B*N***I	000 00:02:00.00	n/a
4)	CCEOBCLinkStateTest	*B*N***I	000 00:01:00.00	n/a

WORD Test ID list (e.g. 1,3-6) or Test Name
 all Select all test ID

```
Router(config)#
Router(config)#diagnostic monitor slot 2 test all
Router(config)#end
Router#show ru
*Aug 2 06:12:19.254: %SYS-5-CONFIG_I: Configured from console by consolen
Router#show run | sec diagnostic monitor
diagnostic monitor slot 2 test Np5cHeartbeatTest cardindex 4
diagnostic monitor slot 2 test AstroIlkTest cardindex 4
diagnostic monitor slot 2 test LCFpgaScratchTest cardindex 4
diagnostic monitor slot 2 test CCEOBCLinkStateTest cardindex 4
Router#
Router#show diagnostic content slot 2
```

slot 2: ASR1000-MIP100

Diagnostics test suite attributes:
 M/C/* - Minimal bootup level test / Complete bootup level test / NA
 B/* - Basic ondemand test / NA
 P/V/* - Per port test / Per device test / NA
 D/N/* - Disruptive test / Non-disruptive test / NA
 S/* - Only applicable to standby unit / NA
 X/* - Not a health monitoring test / NA
 F/* - Fixed monitoring interval test / NA
 E/* - Always enabled monitoring test / NA
 A/I - Monitoring is active / Monitoring is inactive

ID	Test Name	Attributes	Test Interval day hh:mm:ss.ms	Three- day shold
1)	Np5cHeartbeatTest	*B*N***A	000 00:00:05.00	n/a
2)	AstroIlkTest	*B*N***A	000 00:01:00.00	n/a
3)	LCFpgaScratchTest	*B*N***A	000 00:02:00.00	n/a
4)	CCEOBCLinkStateTest	*B*N***A	000 00:01:00.00	n/a

```
Router#show diagnostic result slot 2
```

Current bootup diagnostic level: minimal

slot 2: ASR1000-MIP100 SerialNo : JAE210500MM

Overall Diagnostic Result for slot 2 : PASS
 Diagnostic level at card bootup: minimal

Test results: (. = Pass, F = Fail, U = Untested)

1) Np5cHeartbeatTest -----> .

```

2) AstroIlkTest -----> .
3) LCFpgaScratchTest -----> .
4) CCEOBCLinkStateTest -----> .

```

Router#

Subslot :

Router#show diagnostic content subslot 1/0

subslot 1/0: EPA-2X40GE

Diagnostics test suite attributes:

```

M/C/* - Minimal bootup level test / Complete bootup level test / NA
B/* - Basic ondemand test / NA
P/V/* - Per port test / Per device test / NA
D/N/* - Disruptive test / Non-disruptive test / NA
S/* - Only applicable to standby unit / NA
X/* - Not a health monitoring test / NA
F/* - Fixed monitoring interval test / NA
E/* - Always enabled monitoring test / NA
A/I - Monitoring is active / Monitoring is inactive

```

ID	Test Name	Attributes	Test Interval day hh:mm:ss.ms	Three- day shold
1)	EPAFpgaScratchTest ----->	*B*N***I	000 00:01:00.00	n/a
2)	EPAStatusTest ----->	*B*N***I	000 00:01:00.00	n/a
3)	EPAHostPrbsStausTest ----->	*B*N***I	not configured	n/a
4)	EPAXcvrTest ----->	*BPN*X**I	not configured	n/a

Router#conf t

Enter configuration commands, one per line. End with CNTL/Z.

Router(config)#diagno

Router(config)#diagnostic mon

Router(config)#diagnostic monitor sub

Router(config)#diagnostic monitor subslot 1/0 ?

test Diagnostic test selection

Router(config)#diagnostic monitor subslot 1/0 te

Router(config)#diagnostic monitor subslot 1/0 test ?

Diagnostics test suite attributes:

```

M/C/* - Minimal bootup level test / Complete bootup level test / NA
B/* - Basic ondemand test / NA
P/V/* - Per port test / Per device test / NA
D/N/* - Disruptive test / Non-disruptive test / NA
S/* - Only applicable to standby unit / NA
X/* - Not a health monitoring test / NA
F/* - Fixed monitoring interval test / NA
E/* - Always enabled monitoring test / NA
A/I - Monitoring is active / Monitoring is inactive

```

ID	Test Name	Attributes	Test Interval day hh:mm:ss.ms	Three- day shold
1)	EPAFpgaScratchTest ----->	*B*N***I	000 00:01:00.00	n/a
2)	EPAStatusTest ----->	*B*N***I	000 00:01:00.00	n/a
3)	EPAHostPrbsStausTest ----->	*B*N***I	not configured	n/a
4)	EPAXcvrTest ----->	*BPN*X**I	not configured	n/a

```

WORD    Test ID list (e.g. 1,3-6) or Test Name
all     Select all test ID

Router(config)#diagnostic monitor subslot 1/0 test 1
Router(config)#end
Router#sho
*Aug  2 06:29:41.321: %SYS-5-CONFIG_I: Configured from console by consolew ru
Router#show running-config | sec diagnostic monitor subslot
diagnostic monitor subslot 1/0 test EPAFpgaScratchTest cardindex 5
Router#
Router#
*Aug  2 06:30:07.735: %LINK-3-UPDOWN: Interface FortyGigabitEthernet1/0/1, changed state
to up
*Aug  2 06:30:07.734: %LINK-3-UPDOWN: SIP1/0: Interface FortyGigabitEthernet1/0/1, changed
state to up
*Aug  2 06:30:08.735: %LINEPROTO-5-UPDOWN: Line protocol on Interface
FortyGigabitEthernet1/0/1, changed state to up
Router#
Router#
Router#show diagnostic content subslot 1/0

subslot 1/0: EPA-2X40GE

Diagnostics test suite attributes:
M/C/* - Minimal bootup level test / Complete bootup level test / NA
B/* - Basic ondemand test / NA
P/V/* - Per port test / Per device test / NA
D/N/* - Disruptive test / Non-disruptive test / NA
S/* - Only applicable to standby unit / NA
X/* - Not a health monitoring test / NA
F/* - Fixed monitoring interval test / NA
E/* - Always enabled monitoring test / NA
A/I - Monitoring is active / Monitoring is inactive

ID      Test Name                               Attributes                               Test Interval  Three-
====  =====                               =====                               day hh:mm:ss.ms shold
1) EPAFpgaScratchTest -----> *B*N***A    000 00:01:00.00 n/a
2) EPAStatusTest -----> *B*N***I    000 00:01:00.00 n/a
3) EPAHostPrbsStausTest -----> *B*N***I    not configured n/a
4) EPAXcvrTest -----> *BPN*X**I    not configured n/a

Router#

```

Slot and Subslot Level Show Commands Output Example

```

Slot related show commands:
=====

Router#show diagnostic slot 0

Current bootup diagnostic level: minimal

slot 0: ASR1000-MIP100          SerialNo : JAE20400315

Overall Diagnostic Result for slot 0 : PASS
Diagnostic level at card bootup: minimal

Test results: (. = Pass, F = Fail, U = Untested)

```

```

1) Np5cHeartbeatTest -----> .
2) AstroIlkTest -----> .
3) LCFpgaScratchTest -----> .
4) CCEOBCLinkStateTest -----> .

slot 0: ASR1000-MIP100          SerialNo : JAE214006W6

Overall Diagnostic Result for slot 0 : PASS
Diagnostic level at card bootup: minimal

Test results: (. = Pass, F = Fail, U = Untested)

1) EPAFpgaScratchTest -----> .
2) EPAStatusTest -----> .
3) EPAHostPrbsStausTest -----> .
4) EPAXcvrTest:

Port 0
-----
      U

slot 0: ASR1000-MIP100          SerialNo : JAE214006VX

Overall Diagnostic Result for slot 0 : PASS
Diagnostic level at card bootup: minimal

Test results: (. = Pass, F = Fail, U = Untested)

1) EPAFpgaScratchTest -----> .
2) EPAStatusTest -----> .
3) EPAHostPrbsStausTest -----> .
4) EPAXcvrTest:

Port 0
-----
      .

Router#show diagnostic result slot 0

Current bootup diagnostic level: minimal

slot 0: ASR1000-MIP100          SerialNo : JAE20400315

Overall Diagnostic Result for slot 0 : PASS
Diagnostic level at card bootup: minimal

Test results: (. = Pass, F = Fail, U = Untested)

1) Np5cHeartbeatTest -----> .
2) AstroIlkTest -----> .
3) LCFpgaScratchTest -----> .
4) CCEOBCLinkStateTest -----> .

Router#show diagnostic result slot 0 detail

```

Current bootup diagnostic level: minimal

slot 0: ASR1000-MIP100 SerialNo : JAE20400315

Overall Diagnostic Result for slot 0 : PASS

Diagnostic level at card bootup: minimal

Test results: (. = Pass, F = Fail, U = Untested)

```
1) Np5cHeartbeatTest -----> .

   Error code -----> 0 (DIAG_SUCCESS)
   Total run count -----> 2
   Last test testing type -----> OnDemand
   Last test execution time -----> Jul 22 2019 04:49:25
   First test failure time -----> n/a
   Last test failure time -----> n/a
   Last test pass time -----> Jul 22 2019 04:49:25
   Total failure count -----> 0
   Consecutive failure count ----> 0
```

```
2) AstroIlkTest -----> .

   Error code -----> 0 (DIAG_SUCCESS)
   Total run count -----> 2
   Last test testing type -----> OnDemand
   Last test execution time -----> Jul 22 2019 04:49:25
   First test failure time -----> n/a
   Last test failure time -----> n/a
   Last test pass time -----> Jul 22 2019 04:49:25
   Total failure count -----> 0
   Consecutive failure count ----> 0
```

```
3) LCFpgaScratchTest -----> .

   Error code -----> 0 (DIAG_SUCCESS)
   Total run count -----> 2
   Last test testing type -----> OnDemand
   Last test execution time -----> Jul 22 2019 04:49:25
   First test failure time -----> n/a
   Last test failure time -----> n/a
   Last test pass time -----> Jul 22 2019 04:49:25
   Total failure count -----> 0
   Consecutive failure count ----> 0
```

```
4) CCEOBCLinkStateTest -----> .

   Error code -----> 0 (DIAG_SUCCESS)
   Total run count -----> 2
   Last test testing type -----> OnDemand
   Last test execution time -----> Jul 22 2019 04:49:25
   First test failure time -----> n/a
   Last test failure time -----> n/a
   Last test pass time -----> Jul 22 2019 04:49:25
   Total failure count -----> 0
   Consecutive failure count ----> 0
```

```

Router#
Router#show diagnostic slot 0 detail

Current bootup diagnostic level: minimal

slot 0: ASR1000-MIP100      SerialNo : JAE20400315

Overall Diagnostic Result for slot 0 : PASS
Diagnostic level at card bootup: minimal

Test results: (. = Pass, F = Fail, U = Untested)

```

```

1) Np5cHeartbeatTest -----> .

Error code -----> 0 (DIAG_SUCCESS)
Total run count -----> 2
Last test testing type -----> OnDemand
Last test execution time ----> Jul 22 2019 04:49:25
First test failure time -----> n/a
Last test failure time -----> n/a
Last test pass time -----> Jul 22 2019 04:49:25
Total failure count -----> 0
Consecutive failure count ----> 0

```

```

2) AstroIlkTest -----> .

Error code -----> 0 (DIAG_SUCCESS)
Total run count -----> 2
Last test testing type -----> OnDemand
Last test execution time ----> Jul 22 2019 04:49:25
First test failure time -----> n/a
Last test failure time -----> n/a
Last test pass time -----> Jul 22 2019 04:49:25
Total failure count -----> 0
Consecutive failure count ----> 0

```

```

3) LCFpgaScratchTest -----> .

Error code -----> 0 (DIAG_SUCCESS)
Total run count -----> 2
Last test testing type -----> OnDemand
Last test execution time ----> Jul 22 2019 04:49:25
First test failure time -----> n/a
Last test failure time -----> n/a
Last test pass time -----> Jul 22 2019 04:49:25
Total failure count -----> 0
Consecutive failure count ----> 0

```

```

4) CCEOBCLinkStateTest -----> .

Error code -----> 0 (DIAG_SUCCESS)
Total run count -----> 2
Last test testing type -----> OnDemand
Last test execution time ----> Jul 22 2019 04:49:25
First test failure time -----> n/a
Last test failure time -----> n/a
Last test pass time -----> Jul 22 2019 04:49:25
Total failure count -----> 0
Consecutive failure count ----> 0

```

```
slot 0: ASR1000-MIP100      SerialNo : JAE214006W6
```

```
Overall Diagnostic Result for slot 0 : PASS
Diagnostic level at card bootup: minimal
```

```
Test results: (. = Pass, F = Fail, U = Untested)
```

```
1) EPAPpgaScratchTest -----> .
```

```
    Error code -----> 0 (DIAG_SUCCESS)
    Total run count -----> 1
    Last test testing type -----> OnDemand
    Last test execution time ----> Jul 22 2019 04:49:45
    First test failure time -----> n/a
    Last test failure time -----> n/a
    Last test pass time -----> Jul 22 2019 04:49:45
    Total failure count -----> 0
    Consecutive failure count ---> 0
```

```
2) EPAStatusTest -----> .
```

```
    Error code -----> 0 (DIAG_SUCCESS)
    Total run count -----> 1
    Last test testing type -----> OnDemand
    Last test execution time ----> Jul 22 2019 04:49:45
    First test failure time -----> n/a
    Last test failure time -----> n/a
    Last test pass time -----> Jul 22 2019 04:49:45
    Total failure count -----> 0
    Consecutive failure count ---> 0
```

```
3) EPAHostPrbsStausTest -----> .
```

```
    Error code -----> 0 (DIAG_SUCCESS)
    Total run count -----> 1
    Last test testing type -----> OnDemand
    Last test execution time ----> Jul 22 2019 04:49:45
    First test failure time -----> n/a
    Last test failure time -----> n/a
    Last test pass time -----> Jul 22 2019 04:49:45
    Total failure count -----> 0
    Consecutive failure count ---> 0
```

```
4) EPAXcvrTest:
```

```
Port 0
-----
    U
```

```
    Error code -----> 1 (DIAG_FAILURE)
    Total run count -----> 1
    Last test testing type -----> OnDemand
    Last test execution time ----> Jul 22 2019 04:49:45
    First test failure time -----> Jul 22 2019 04:49:45
    Last test failure time -----> Jul 22 2019 04:49:45
```

```

Last test pass time -----> n/a
Total failure count -----> 1
Consecutive failure count ---> 1

```

```
slot 0: ASR1000-MIP100      SerialNo : JAE214006VX
```

```
Overall Diagnostic Result for slot 0 : PASS
Diagnostic level at card bootup: minimal
```

```
Test results: (. = Pass, F = Fail, U = Untested)
```

```
1) EPAPpgaScratchTest -----> .
```

```

Error code -----> 0 (DIAG_SUCCESS)
Total run count -----> 1
Last test testing type -----> OnDemand
Last test execution time ----> Jul 22 2019 04:50:03
First test failure time ----> n/a
Last test failure time ----> n/a
Last test pass time -----> Jul 22 2019 04:50:03
Total failure count -----> 0
Consecutive failure count ---> 0

```

```
2) EPAStatusTest -----> .
```

```

Error code -----> 0 (DIAG_SUCCESS)
Total run count -----> 1
Last test testing type -----> OnDemand
Last test execution time ----> Jul 22 2019 04:50:03
First test failure time ----> n/a
Last test failure time ----> n/a
Last test pass time -----> Jul 22 2019 04:50:03
Total failure count -----> 0
Consecutive failure count ---> 0

```

```
3) EPAHostPrbsStausTest -----> .
```

```

Error code -----> 0 (DIAG_SUCCESS)
Total run count -----> 1
Last test testing type -----> OnDemand
Last test execution time ----> Jul 22 2019 04:50:03
First test failure time ----> n/a
Last test failure time ----> n/a
Last test pass time -----> Jul 22 2019 04:50:03
Total failure count -----> 0
Consecutive failure count ---> 0

```

```
4) EPAXcvrTest:
```

```

Port 0
-----
.

```

```

Error code -----> 0 (DIAG_SUCCESS)
Total run count -----> 1
Last test testing type -----> OnDemand

```

```

Last test execution time ----> Jul 22 2019 04:50:03
First test failure time -----> n/a
Last test failure time -----> n/a
Last test pass time -----> Jul 22 2019 04:50:03
Total failure count -----> 0
Consecutive failure count ---> 0
    
```

```

Router#
Router#show diagnostic content slot 0
    
```

```
slot 0: ASR1000-MIP100
```

```

Diagnostics test suite attributes:
M/C/* - Minimal bootup level test / Complete bootup level test / NA
B/* - Basic ondemand test / NA
P/V/* - Per port test / Per device test / NA
D/N/* - Disruptive test / Non-disruptive test / NA
S/* - Only applicable to standby unit / NA
X/* - Not a health monitoring test / NA
F/* - Fixed monitoring interval test / NA
E/* - Always enabled monitoring test / NA
A/I - Monitoring is active / Monitoring is inactive
    
```

ID	Test Name	Attributes	Test Interval day hh:mm:ss.ms	Thre- shold
1)	Np5cHeartbeatTest	*B*N***I	000 00:00:05.00	n/a
2)	AstroIlkTest	*B*N***I	000 00:01:00.00	n/a
3)	LCFpgaScratchTest	*B*N***I	000 00:02:00.00	n/a
4)	CCEOBCLinkStateTest	*B*N***I	000 00:01:00.00	n/a

```

Router#
Router#show diagnostic description slot 0 test all
    
```

```

Np5cHeartbeatTest :
  It Checks the ezman process heartbeat miss.
    
```

```

AstroIlkTest :
  It tests astro interlaken status and reports failures if not ok
    
```

```

LCFpgaScratchTest :
  It checks Read and Write operation of ELC's FPGA
    
```

```

CCEOBCLinkStateTest :
  It Checks EOBC link status of LC card.
    
```

```

Router#
Router#show diagnostic events slot 0
Diagnostic events (storage for 500 events, 26 events recorded)
Number of events matching above criteria = 8
Event Type (ET): I - Info, W - Warning, E - Error
    
```

Time Stamp	ET	[Card]	Event Message
07/22 04:48:23.878	I	[0]	Np5cHeartbeatTest Passed
07/22 04:48:23.880	I	[0]	AstroIlkTest Passed
07/22 04:48:23.882	I	[0]	LCFpgaScratchTest Passed
07/22 04:48:23.886	I	[0]	CCEOBCLinkStateTest Passed

```
07/22 04:49:25.297 I [0] Np5cHeartbeatTest Passed
07/22 04:49:25.298 I [0] AstroIlkTest Passed
07/22 04:49:25.300 I [0] LCFpgaScratchTest Passed
07/22 04:49:25.302 I [0] CCEOBCLinkStateTest Passed
```

```
Router#
Router#show diagnostic simulation failure slot 0
slot 0:
    There is no test failure simulation installed.
```

```
Router#conf t
Enter configuration commands, one per line. End with CNTL/Z.
Router(config)#
Router(config)#do show clock
*05:43:47.385 UTC Mon Jul 22 2019
Router(config)#diagnostic schedule slot 0 test all on jul 22 2019 05:45
Router(config)#end
Router#
Router#show run | sec diagnostic
diagnostic schedule slot 0 test all on July 22 2019 5:45 cardindex 4 jobindex 1
diagnostic bootup level minimal
Router#
Router#
Router#show diagnostic schedule slot 0
Current Time = 05:44:35 UTC Mon Jul 22 2019
```

```
Diagnostic for slot 0:
```

```
Schedule #1:
  To be run on July 22 2019 5:45
  Test ID(s) to be executed: all.
```

```
Router#
*Jul 22 05:44:59.720: %DIAG-6-SCHED_RUNNING: slot 0: Performing Scheduled Online Diagnostic...
*Jul 22 05:44:59.720: %DIAG-6-TEST_RUNNING: slot 0: Running Np5cHeartbeatTest{ID=1} ...
*Jul 22 05:44:59.721: %DIAG-6-TEST_OK: slot 0: Np5cHeartbeatTest{ID=1} has completed
successfully
*Jul 22 05:44:59.721: %DIAG-6-TEST_RUNNING: slot 0: Running AstroIlkTest{ID=2} ...
*Jul 22 05:44:59.722: %DIAG-6-TEST_OK: slot 0: AstroIlkTest{ID=2} has completed successfully
*Jul 22 05:44:59.722: %DIAG-6-TEST_RUNNING: slot 0: Running LCFpgaScratchTest{ID=3} ...
*Jul 22 05:44:59.724: %DIAG-6-TEST_OK: slot 0: LCFpgaScratchTest{ID=3} has completed
successfully
*Jul 22 05:44:59.724: %DIAG-6-TEST_RUNNING: slot 0: Running CCEOBCLinkStateTest{ID=4} ...
*Jul 22 05:44:59.726: %DIAG-6-TEST_OK: slot 0: CCEOBCLinkStateTest{ID=4} has completed
successfully
*Jul 22 05:44:59.726: %DIAG-6-SCHED_COMPLETE: slot 0: Scheduled Online Diagnostic is completed
Router#
Router#show diagnostic schedule slot 0
Current Time = 05:45:07 UTC Mon Jul 22 2019
```

```
Diagnostic for slot 0 is not scheduled.
```

```
Router#
```

```
subslot level commands
=====
```

```
Router#show diagnostic result subslot 0/1
```

```
Current bootup diagnostic level: minimal
```

```
subslot 0/1: EPA-QSFP-1X100GE SerialNo : JAE214006VX
```



```
Overall Diagnostic Result for subslot 0/1 : PASS
Diagnostic level at card bootup: minimal
```

```
Test results: (. = Pass, F = Fail, U = Untested)
```

- ```
1) EPAFpgaScratchTest -----> .
2) EPAStatusTest -----> .
3) EPAHostPrbsStausTest -----> .
4) EPAXcvrTest:
```

```
Port 0

.
```

```
Router#show diagnostic result subslot 0/1 detail
```

```
Current bootup diagnostic level: minimal
```

```
subslot 0/1: EPA-QSFP-1X100GE SerialNo : JAE214006VX
```

```
Overall Diagnostic Result for subslot 0/1 : PASS
Diagnostic level at card bootup: minimal
```

```
Test results: (. = Pass, F = Fail, U = Untested)
```

---

```
1) EPAFpgaScratchTest -----> .

Error code -----> 0 (DIAG_SUCCESS)
Total run count -----> 1
Last test testing type -----> OnDemand
Last test execution time ----> Jul 22 2019 04:50:03
First test failure time ----> n/a
Last test failure time ----> n/a
Last test pass time -----> Jul 22 2019 04:50:03
Total failure count -----> 0
Consecutive failure count ---> 0
```

---

```
2) EPAStatusTest -----> .

Error code -----> 0 (DIAG_SUCCESS)
Total run count -----> 1
Last test testing type -----> OnDemand
Last test execution time ----> Jul 22 2019 04:50:03
First test failure time ----> n/a
Last test failure time ----> n/a
Last test pass time -----> Jul 22 2019 04:50:03
Total failure count -----> 0
Consecutive failure count ---> 0
```

---

```
3) EPAHostPrbsStausTest -----> .

Error code -----> 0 (DIAG_SUCCESS)
Total run count -----> 1
Last test testing type -----> OnDemand
Last test execution time ----> Jul 22 2019 04:50:03
First test failure time ----> n/a
```

```

Last test failure time -----> n/a
Last test pass time -----> Jul 22 2019 04:50:03
Total failure count -----> 0
Consecutive failure count ---> 0

```

---

```

4) EPAXcvrTest:

```

```

Port 0

.

```

```

Error code -----> 0 (DIAG_SUCCESS)
Total run count -----> 3
Last test testing type -----> OnDemand
Last test execution time ----> Jul 22 2019 04:57:24
First test failure time -----> n/a
Last test failure time -----> n/a
Last test pass time -----> Jul 22 2019 04:57:24
Total failure count -----> 0
Consecutive failure count ---> 0

```

---

```

Router#

```

```

Router#show diagnostic content subslot 0/1

```

```

subslot 0/1: EPA-QSFP-1X100GE

```

```

Diagnostics test suite attributes:

```

```

M/C/* - Minimal bootup level test / Complete bootup level test / NA
B/* - Basic ondemand test / NA
P/V/* - Per port test / Per device test / NA
D/N/* - Disruptive test / Non-disruptive test / NA
S/* - Only applicable to standby unit / NA
X/* - Not a health monitoring test / NA
F/* - Fixed monitoring interval test / NA
E/* - Always enabled monitoring test / NA
A/I - Monitoring is active / Monitoring is inactive

```

| ID | Test Name            | Attributes | Test Interval   | Three-day hh:mm:ss.ms | Thre-<br>day shold |
|----|----------------------|------------|-----------------|-----------------------|--------------------|
| 1) | EPAFpgaScratchTest   | *B*N***I   | 000 00:01:00.00 |                       | n/a                |
| 2) | EPAStatusTest        | *B*N***I   | 000 00:01:00.00 |                       | n/a                |
| 3) | EPAHostPrbsStausTest | *B*N***I   | not configured  |                       | n/a                |
| 4) | EPAXcvrTest          | *BPN*X**I  | not configured  |                       | n/a                |

```

Router#

```

```

Router#show diagnostic description subslot 0/1 test all

```

```

EPAFpgaScratchTest :
 it tests read and write operation of EPAs FPGA scratpad resigter

```

```

EPAStatusTest :
 It tests EPA boot staus.

```

```

EPAHostPrbsStausTest :
 It tests mac and EPA phy serdes line auto tune status

```

```
EPAXcvrTest :
 It tests EPA xcvr staus
```

```
Router#
```

```
Router#show diagnostic events subslot 0/1 all
Diagnostic events (storage for 500 events, 26 events recorded)
Number of events matching above criteria = 9
Event Type (ET): I - Info, W - Warning, E - Error
```

| Time Stamp         | ET | [Card] | Event Message               |
|--------------------|----|--------|-----------------------------|
| 07/22 04:50:03.787 | I  | [0/1]  | EPAFpgaScratchTest Passed   |
| 07/22 04:50:03.788 | I  | [0/1]  | EPAStatusTest Passed        |
| 07/22 04:50:03.789 | I  | [0/1]  | EPAHostPrbsStausTest Passed |
| 07/22 04:50:03.811 | I  | [0/1]  | EPAXcvrTest Passed          |
| 07/22 04:57:19.719 | I  | [0/1]  | EPAXcvrTest Passed          |
| 07/22 04:57:24.616 | I  | [0/1]  | EPAXcvrTest Passed          |
| 07/22 05:00:01.333 | I  | [0/1]  | EPAXcvrTest Passed          |
| 07/22 05:00:06.980 | I  | [0/1]  | EPAXcvrTest Passed          |
| 07/22 05:00:31.421 | I  | [0/1]  | EPAXcvrTest Passed          |

```
Router#
```

```
Router#show diagnostic simulation failure subslot 0/1
subslot 0/1:
 There is no test failure simulation installed.
```

```
Router#
```

```
Router#show run | sec diagnostic
diagnostic bootup level minimal
Router#conf t
Enter configuration commands, one per line. End with CNTL/Z.
Router(config)#
Router(config)#
Router(config)#do show clock
*05:48:15.905 UTC Mon Jul 22 2019
Router(config)#diagnostic schedule subslot 0/1 test all on jul 22 2019 05:50
Router(config)#end
Router#
*Jul 22 05:48:44.378: %SYS-5-CONFIG_I: Configured from console by consoleconf t
```

```
Router#show run | sec diagnostic
diagnostic schedule subslot 0/1 test all on July 22 2019 5:50 cardindex 5 jobindex 1
diagnostic bootup level minimal
Router#show diagnostic schedule sub
Router#show diagnostic schedule subslot 0/1
Current Time = 05:49:02 UTC Mon Jul 22 2019
```

```
Diagnostic for subslot 0/1:
```

```
Schedule #1:
 To be run on July 22 2019 5:50
 Test ID(s) to be executed: all.
```

```
Router#show diagnostic schedule subslot 0/1
Current Time = 05:49:14 UTC Mon Jul 22 2019
```

```
Diagnostic for subslot 0/1:
```

```
Schedule #1:
 To be run on July 22 2019 5:50
 Test ID(s) to be executed: all.

Router#
*Jul 22 05:49:59.832: %DIAG-6-SCHED_RUNNING: subslot 0/1: Performing Scheduled Online
Diagnostic...
*Jul 22 05:49:59.832: %DIAG-6-TEST_RUNNING: subslot 0/1: Running EPAFpgaScratchTest{ID=1}
...
*Jul 22 05:49:59.833: %DIAG-6-TEST_OK: subslot 0/1: EPAFpgaScratchTest{ID=1} has completed
successfully
*Jul 22 05:49:59.833: %DIAG-6-TEST_RUNNING: subslot 0/1: Running EPAStatusTest{ID=2} ...
*Jul 22 05:49:59.834: %DIAG-6-TEST_OK: subslot 0/1: EPAStatusTest{ID=2} has completed
successfully
*Jul 22 05:49:59.834: %DIAG-6-TEST_RUNNING: subslot 0/1: Running EPAHostPrbsStausTest{ID=3}
...
*Jul 22 05:49:59.835: %DIAG-6-TEST_OK: subslot 0/1: EPAHostPrbsStausTest{ID=3} has completed
successfully
*Jul 22 05:49:59.835: %DIAG-6-TEST_RUNNING: subslot 0/1: Running EPAXcvrTest{ID=4} ...
*Jul 22 05:49:59.857: %DIAG-6-TEST_OK: subslot 0/1: EPAXcvrTest{ID=4} has completed
successfully
*Jul 22 05:49:59.857: %DIAG-6-SCHED_COMPLETE: subslot 0/1: Scheduled Online Diagnostic is
completed
Router#
Router#show diagnostic schedule subslot 0/1
Current Time = 05:50:33 UTC Mon Jul 22 2019

Diagnostic for subslot 0/1 is not scheduled.

Router#
```



## CHAPTER 35

# Unsupported Commands

---

This document lists the unsupported command in Cisco ASR 1000 Series Routers.

- [Unsupported Commands in Cisco ASR 1000 Series Routers, on page 727](#)

## Unsupported Commands in Cisco ASR 1000 Series Routers

The Cisco ASR 1000 Series Routers contain a series of commands with the **platform** keyword that either produce no output or produce output that is not useful for customer purposes. Although some commands with the **platform** keyword produce output that is useful for customer purposes, and are therefore documented in the Cisco IOS XE command references, the vast majority of these commands are not useful for customer purposes and are therefore considered unsupported.

Because these commands are considered unsupported, you will not find any further Cisco documentation for any of these commands.

Following is the list of unsupported commands for the Cisco ASR 1000 Series Routers:

- clear platform hardware cpp
- clear platform software access-list
- clear platform software adjacency
- clear platform software cce
- clear platform software cef
- clear platform software cman
- clear platform software dpidb
- clear platform software ess
- clear platform software icmp
- clear platform software infrastructure
- clear platform software inspect
- clear platform software mlp
- clear platform software mpls
- clear platform software multicast
- clear platform software nat
- clear platform software nbar
- clear platform software netflow
- clear platform software pam
- clear platform software qos

- clear platform software route-map
- clear platform software shell
- clear platform software wccp
- clear platform software zone
- clear platform software zone-pair
- debug platform all
- debug platform hardware cpp
- debug platform software acl
- debug platform software adjacency
- debug platform software cce
- debug platform software cef
- debug platform software cman
- debug platform software configuration
- debug platform software dpidb
- debug platform software entity
- debug platform software ess
- debug platform software FPM
- debug platform software icmp
- debug platform software infrastructure
- debug platform software inspect
- debug platform software iphc
- debug platform software ipsec
- debug platform software issu
- debug platform software kernel
- debug platform software liin
- debug platform software marmot
- debug platform software mlp
- debug platform software mpls
- debug platform software multicast
- debug platform software nat
- debug platform software nbar
- debug platform software netflow
- debug platform software pam
- debug platform software qos
- debug platform software route-map
- debug platform software shell
- debug platform software urpf
- debug platform software vty
- debug platform software wccp
- debug platform software zone
- set platform software trace
- **show crypto engine**
- show platform hardware cpp (all commands)
- show platform software adjacency
- show platform software bound-uds
- show platform software cce statistics

- show platform software cef counters
- show platform software cman statistics
- show platform software common-classification
- show platform software debug
- show platform software diagnostic
- show platform software dpidb
- show platform software erspan
- show platform software ess
- show platform software firewall
- show platform software flow-control identifier
- show platform software fpm
- show platform software icmp
- show platform software icmp6
- show platform software infrastructure
- show platform software inspect statistics
- show platform software interface
- show platform software ip
- show platform software ipc
- show platform software iphc
- show platform software ipsec
- show platform software ipv6
- show platform software loadinfo
- show platform software mlist
- show platform software mlp
- show platform software mlppp
- show platform software module
- show platform software mpls
- show platform software multicast
- show platform software nat
- show platform software nbar
- show platform software netflow
- show platform software object-manager
- show platform software os-interface
- show platform software pam
- show platform software peer
- show platform software punt
- show platform software push-counter
- show platform software qos
- show platform software sbc tables
- show platform software shell
- show platform software slot
- show platform software spi4
- show platform software urpf
- show platform software vlans
- show platform software vty
- show platform software wccp

- show platform software zone statistics
- test platform hardware eobc
- test platform hardware port
- test platform hardware slot
- test platform hardware subslot
- test platform software cef
- test platform software chassis
- test platform software debug
- test platform software forwarding-manager
- test platform software infrastructure
- test platform software inject
- test platform software process
- test platform software shell
- test platform software tdl
- test platform software trace





## CHAPTER 36

# Configuration Examples

This appendix is designed to provide examples of how some common networking tasks can be accomplished on the Cisco ASR 1000 Series Routers. The examples in this appendix are provided for illustrative purposes only; little or no context is given with these examples.

When reading this section, also be aware that networking configurations are complex and can be configured many ways. The examples in this section simply show one method of accomplishing a configuration.

This appendix contains the following examples:

- [Configuring the Router to Boot the Consolidated Package on the TFTP Server](#) , on page 731
- [Copying the Consolidated Package from the TFTP Server to the Router](#) , on page 734
- [Configuring the Router to Boot Using the Consolidated Package Stored on the Router](#), on page 735
- [Extracting the SubPackages from a Consolidated Package into the Same File System](#), on page 736
- [Extracting the SubPackages from a Consolidated Package into a Different File System](#), on page 737
- [Configuring the Router to Boot Using the SubPackages](#), on page 738
- [Backing Up Configuration Files](#), on page 741
- [Enabling a Second IOS Process on a Single RP Using SSO](#) , on page 742
- [ISSU—Consolidated Package Upgrade](#), on page 746

## Configuring the Router to Boot the Consolidated Package on the TFTP Server

The following example shows how to configure the router to boot the consolidated package on the TFTP server:

```
Router(config)# boot system
tftp://198.51.100.81/auto/tftp-users/user/asr1000rp1-adventerprisek9.02.01.00.122-33.XNA.bin

Router(config)#config-reg 0x2102
Router(config)# exit

*May 29 21:51:11.963: %SYS-5-CONFIG_I: Configured from console by user on console
Router# show run | include boot
boot-start-marker
boot system
tftp://198.51.100.81/auto/tftp-users/user/asr1000rp1-adventerprisek9.02.01.00.122-33.XNA.bin
boot-end-marker
```

## Configuring the Router to Boot the Consolidated Package on the TFTP Server

```

Router# copy run start
Destination filename [startup-config]?
Building configuration...
[OK]
Router# reload
Proceed with reload? [confirm]
*May 29 21:52:01.500: %SYS-5-RELOAD: Reload requested by user on console. Reload Reason:
Reload command.
System Bootstrap, Version 12.2(33r)XN2, RELEASE SOFTWARE (fc1)
Technical Support: http://www.cisco.com/techsupport
Copyright (c) 2008 by cisco Systems, Inc.
Current image running: Boot ROM0
Last reset cause: LocalSoft
ASR1000-RP1 platform with 4194303 Kbytes of main memory
 IP_ADDRESS: 198.51.100.155
 IP_SUBNET_MASK: 255.255.255.0
 DEFAULT_GATEWAY: 198.51.100.1
 TFTP_SERVER: 198.51.100.81
 TFTP_FILE: auto/tftp-users/user/asr1000rp1-adventerprisek9.02.01.00.122-33.XNA.bin
Using midplane macaddr
 TFTP_MACADDR: 00:1a:30:46:e3:ff
 TFTP_VERBOSE: Progress
 TFTP_RETRY_COUNT: 18
 TFTP_TIMEOUT: 7200
 TFTP_CHECKSUM: Yes
 ETHER_PORT: 3
 ETHER_SPEED_MODE: Auto Detect
link up 100Mbps/HD
Receiving auto/tftp-users/user/asr1000rp1-adventerprisek9.02.01.00.122-33.XNA.bin from
198.51.100.81

File reception completed.
Boot image size = 208904396 (0xc73a0cc) bytes
Using midplane macaddr
Package header rev 0 structure detected
Calculating SHA-1 hash...done
validate_package: SHA-1 hash:
 calculated fb456e80:4ba2fa07:8556d27c:ea643e4f:512236df
 expected fb456e80:4ba2fa07:8556d27c:ea643e4f:512236df
Image validated
PPC/IOS XE loader version: 0.0.3
loaded at: 00800000 0CF3C004
zimage at: 00807673 009B92D6
initrd at: 009BA000 01041CC9
isord at: 01042000 0CF39800
avail ram: 00400000 00800000
Kernel load:
Uncompressing image... dst: 00000000 lim: 00400000 start: 00807673 size: 001B1C63...done.
Now booting the IOS XE kernel
%IOSXEBOOT-4-BOOT_SRC: (rp/0): Non-HD Boot
%IOSXEBOOT-4-BOOT_PARAMETER: (rp/0): Booting with custom BOOT_PARAM setting
 Restricted Rights Legend
Use, duplication, or disclosure by the Government is
subject to restrictions as set forth in subparagraph
(c) of the Commercial Computer Software - Restricted
Rights clause at FAR sec. 52.227-19 and subparagraph
(c) (1) (ii) of the Rights in Technical Data and Computer
Software clause at DFARS sec. 252.227-7013.
 cisco Systems, Inc.
 170 West Tasman Drive
 San Jose, California 95134-1706
Cisco IOS Software, IOS-XE Software (PPC_LINUX_IOSD-ADVENTERPRISEK9-M), Version 12.2(33)XNA,
RELEASE SOFTWARE (fc1)
Technical Support: http://www.cisco.com/techsupport

```

```

Copyright (c) 1986-2008 by Cisco Systems, Inc.
Compiled Thu 01-May-08 00:29 by mcpre
Image text-base: 0x10064AF0, data-base: 0x137E0958
Cisco IOS-XE software, Copyright (c) 1986-2008 by Cisco Systems, Inc.
All rights reserved. Certain components of Cisco IOS-XE software are
licensed under the GNU General Public License (GPL) Version 2.0. The
software code licensed under GPL Version 2.0 is free software that comes
with ABSOLUTELY NO WARRANTY. You can redistribute and/or modify such
GPL code under the terms of GPL Version 2.0. For more details, see the
documentation or License Notice file accompanying the IOS-XE software,
or the applicable URL provided on the flyer accompanying the IOS-XE
software.
This product contains cryptographic features and is subject to United
States and local country laws governing import, export, transfer and
use. Delivery of Cisco cryptographic products does not imply
third-party authority to import, export, distribute or use encryption.
Importers, exporters, distributors and users are responsible for
compliance with U.S. and local country laws. By using this product you
agree to comply with applicable laws and regulations. If you are unable
to comply with U.S. and local laws, return this product immediately.
A summary of U.S. laws governing Cisco cryptographic products may be found at:
http://www.cisco.com/wwl/export/crypto/tool/stqrg.html
If you require further assistance please contact us by sending email to
export@cisco.com.
cisco ASR1006 (RP1) processor with 1772131K/6147K bytes of memory.
5 Gigabit Ethernet interfaces
2 Packet over SONET interfaces
2 Channelized T3 ports
32768K bytes of non-volatile configuration memory.
4194304K bytes of physical memory.
921599K bytes of eUSB flash at bootflash:.
39004543K bytes of SATA hard disk at harddisk:.
Duplex is configured.Remove duplex configuration before enabling auto-negotiation
<output removed for brevity>
User Access Verification
Username: user
Password:
Router>en
Password:
Router# show version
Cisco IOS Software, IOS-XE Software (PPC_LINUX_IOSD-ADVENTERPRISEK9-M), Version 12.2(33)XNA,
RELEASE SOFTWARE (fcl)
Technical Support: http://www.cisco.com/techsupport
Copyright (c) 1986-2008 by Cisco Systems, Inc.
Compiled Thu 01-May-08 00:29 by mcpre
Cisco IOS-XE software, Copyright (c) 1986-2008 by Cisco Systems, Inc.
All rights reserved. Certain components of Cisco IOS-XE software are
licensed under the GNU General Public License (GPL) Version 2.0. The
software code licensed under GPL Version 2.0 is free software that comes
with ABSOLUTELY NO WARRANTY. You can redistribute and/or modify such
GPL code under the terms of GPL Version 2.0. For more details, see the
documentation or License Notice file accompanying the IOS-XE software,
or the applicable URL provided on the flyer accompanying the IOS-XE
software.
ROM: IOS-XE ROMMON
Router uptime is 2 minutes
Uptime for this control processor is 4 minutes
System returned to ROM by reload at 14:52:01 DST Thu May 29 2008System image file is
"tftp://172.17.16.81/auto/tftp-users/user/asr1000rp1-adve"Last reload reason: Reload command
This product contains cryptographic features and is subject to United
States and local country laws governing import, export, transfer and
use. Delivery of Cisco cryptographic products does not imply
third-party authority to import, export, distribute or use encryption.
Importers, exporters, distributors and users are responsible for

```

compliance with U.S. and local country laws. By using this product you agree to comply with applicable laws and regulations. If you are unable to comply with U.S. and local laws, return this product immediately. A summary of U.S. laws governing Cisco cryptographic products may be found at: <http://www.cisco.com/wvl/export/crypto/tool/stqrg.html>  
 If you require further assistance please contact us by sending email to [export@cisco.com](mailto:export@cisco.com).

cisco ASR1006 (RP1) processor with 1772131K/6147K bytes of memory.  
 5 Gigabit Ethernet interfaces  
 8 Serial interfaces  
 8 Channelized T1 ports  
 2 Packet over SONET interfaces  
 2 Channelized T3 ports  
 32768K bytes of non-volatile configuration memory.  
 4194304K bytes of physical memory.  
 921599K bytes of eUSB flash at bootflash:.  
 39004543K bytes of SATA hard disk at harddisk:.  
 Configuration register is 0x2102

## Copying the Consolidated Package from the TFTP Server to the Router

The following example shows how to copy the consolidated package from the TFTP server to the router:

```
Router# dir bootflash:
Directory of bootflash:/
 11 drwx 16384 Dec 4 2007 04:32:46 -08:00 lost+found
86401 drwx 4096 Dec 4 2007 06:06:24 -08:00 .ssh
14401 drwx 4096 Dec 4 2007 06:06:36 -08:00 .rollback_timer
28801 drwx 4096 Mar 18 2008 17:31:17 -07:00 .prst_sync
43201 drwx 4096 Dec 4 2007 04:34:45 -08:00 .installer
 13 -rw- 45977 Apr 9 2008 16:48:46 -07:00 target_support_output.tgz.tgz
928862208 bytes total (712273920 bytes free)
Router# copy tftp bootflash:
Address or name of remote host []? 198.51.100.81
Source filename []? /auto/tftp-users/user/asr1000rpl-adventerprisek9.02.01.00.122-33.XNA.bin
Destination filename [asr1000rpl-adventerprisek9.02.01.00.122-33.XNA.bin]?
Accessing
tftp://198.51.100.81/auto/tftp-users/user/asr1000rpl-adventerprisek9.02.01.00.122-33.XNA.bin...
Loading /auto/tftp-users/user/asr1000rpl-adventerprisek9.02.01.00.122-33.XNA.bin from
198.51.100.81 (via GigabitEthernet0):

[OK - 208904396 bytes]
208904396 bytes copied in 330.453 secs (632176 bytes/sec)
Router# dir bootflash:
Directory of bootflash:/
 11 drwx 16384 Dec 4 2007 04:32:46 -08:00 lost+found
86401 drwx 4096 Dec 4 2007 06:06:24 -08:00 .ssh
14401 drwx 4096 Dec 4 2007 06:06:36 -08:00 .rollback_timer
28801 drwx 4096 Mar 18 2008 17:31:17 -07:00 .prst_sync
43201 drwx 4096 Dec 4 2007 04:34:45 -08:00 .installer
 12 -rw- 208904396 May 28 2008 16:17:34 -07:00 asr1000rpl-adventerprisek9.02.01.00.122-33.XNA.bin
 13 -rw- 45977 Apr 9 2008 16:48:46 -07:00 target_support_output.tgz.tgz
928862208 bytes total (503156736 bytes free)
```

# Configuring the Router to Boot Using the Consolidated Package Stored on the Router

The following example shows how to configure the router to boot using the consolidated package stored on the router:

```

Router# dir bootflash:
Directory of bootflash:/
 11 drwx 16384 Dec 4 2007 04:32:46 -08:00 lost+found
86401 drwx 4096 Dec 4 2007 06:06:24 -08:00 .ssh
14401 drwx 4096 Dec 4 2007 06:06:36 -08:00 .rollback_timer
28801 drwx 4096 Mar 18 2008 17:31:17 -07:00 .prst_sync
43201 drwx 4096 Dec 4 2007 04:34:45 -08:00 .installer
 12 -rw- 208904396 May 28 2008 16:17:34 -07:00
asr1000rp1-adventerprisek9.02.01.00.122-33.XNA.bin
 13 -rw- 45977 Apr 9 2008 16:48:46 -07:00 target_support_output.tgz.tgz
928862208 bytes total (503156736 bytes free)
Router# config t
Enter configuration commands, one per line. End with CNTL/Z.
Router(config)#boot system bootflash:asr1000rp1-adventerprisek9.02.01.00.122-33.XNA.bin
Router(config)#config-reg 0x2102
Router(config)#exit
Router#show run | include boot
boot-start-marker
boot system bootflash:asr1000rp1-adventerprisek9.02.01.00.122-33.XNA.bin
boot-end-marker
Router# copy run start
Destination filename [startup-config]?
Building configuration...
[OK]
Router# reload
<output removed for brevity>
User Access Verification
Username: user
Password:
Router>en
Password:
Router#show version
Cisco IOS Software, IOS-XE Software (PPC_LINUX_IOSD-ADVENTERPRISEK9-M), Version 12.2(33)XNA,
 RELEASE SOFTWARE (fcl)
Technical Support: http://www.cisco.com/techsupport
Copyright (c) 1986-2008 by Cisco Systems, Inc.
Compiled Thu 01-May-08 00:29 by mcpre
Cisco IOS-XE software, Copyright (c) 1986-2008 by Cisco Systems, Inc.
All rights reserved. Certain components of Cisco IOS-XE software are
licensed under the GNU General Public License (GPL) Version 2.0. The
software code licensed under GPL Version 2.0 is free software that comes
with ABSOLUTELY NO WARRANTY. You can redistribute and/or modify such
GPL code under the terms of GPL Version 2.0. For more details, see the
documentation or License Notice file accompanying the IOS-XE software,
or the applicable URL provided on the flyer accompanying the IOS-XE
software.
ROM: IOS-XE ROMMON
 Router uptime is 3 minutes
Uptime for this control processor is 5 minutes
System returned to ROM by reload at 16:20:55 DST Wed May 28 2008System image file is
bootflash:asr1000rp1-adventerprisek9.02.01.00.122-33.XNA.binLast reload reason: Reload
command
This product contains cryptographic features and is subject to United

```

```

States and local country laws governing import, export, transfer and
use. Delivery of Cisco cryptographic products does not imply
third-party authority to import, export, distribute or use encryption.
Importers, exporters, distributors and users are responsible for
compliance with U.S. and local country laws. By using this product you
agree to comply with applicable laws and regulations. If you are unable
to comply with U.S. and local laws, return this product immediately.
A summary of U.S. laws governing Cisco cryptographic products may be found at:
http://www.cisco.com/wwl/export/crypto/tool/stqrg.html
If you require further assistance please contact us by sending email to
export@cisco.com.
cisco ASR1006 (RP1) processor with 1772131K/6147K bytes of memory.
5 Gigabit Ethernet interfaces
8 Serial interfaces
8 Channelized T1 ports
2 Packet over SONET interfaces
2 Channelized T3 ports
32768K bytes of non-volatile configuration memory.
4194304K bytes of physical memory.
921599K bytes of eUSB flash at bootflash:.
39004543K bytes of SATA hard disk at harddisk:.Configuration register is 0x2102

```

## Extracting the SubPackages from a Consolidated Package into the Same File System

The following example shows how to extract the subpackages from a consolidated package into the same file system:

The `asr1000rp1-adventerprisek9.02.01.00.122-33.XNA.bin` consolidated package file is in bootflash, but no sub-packages are in the directory.

```

Router# dir bootflash:
Directory of bootflash:/
 11 drwx 16384 Dec 4 2007 04:32:46 -08:00 lost+found
86401 drwx 4096 Dec 4 2007 06:06:24 -08:00 .ssh
14401 drwx 4096 Dec 4 2007 06:06:36 -08:00 .rollback_timer
28801 drwx 4096 Mar 18 2008 17:31:17 -07:00 .prst_sync
43201 drwx 4096 Dec 4 2007 04:34:45 -08:00 .installer
 12 -rw- 208904396 May 9 2008 14:36:31 -07:00
asr1000rp1-adventerprisek9.02.01.00.122-33.XNA.bin
 13 -rw- 45977 Apr 9 2008 16:48:46 -07:00 target_support_output.tgz.tgz
928862208 bytes total (503156736 bytes free)
Router# request platform software package expand file
bootflash:asr1000rp1-adventerprisek9.02.01.00.122-33.XNA.bin
Verifying parameters
Validating package type
Copying package files
SUCCESS: Finished expanding all-in-one software package.

```

After entering the `request platform software package expand file bootflash:asr1000rp1-adventerprisek9.02.01.00.122-33.XNA.bin` command, noting that the `to` option is not used, the sub-packages are extracted from the consolidated package into bootflash.:

```

Router# dir bootflash:
Directory of bootflash:/
 11 drwx 16384 Dec 4 2007 04:32:46 -08:00 lost+found
86401 drwx 4096 Dec 4 2007 06:06:24 -08:00 .ssh
14401 drwx 4096 Dec 4 2007 06:06:36 -08:00 .rollback_timer

```

```

28801 drwx 4096 Mar 18 2008 17:31:17 -07:00 .prst_sync
43201 drwx 4096 Dec 4 2007 04:34:45 -08:00 .installer
 12 -rw- 208904396 May 9 2008 14:36:31 -07:00
asr1000rp1-adventerprisek9.02.01.00.122-33.XNA.bin
57611 -rw- 47071436 May 22 2008 11:26:23 -07:00
asr1000rp1-espbase.02.01.00.122-33.XNA.pkg
57602 -rw- 5740 May 22 2008 11:26:22 -07:00
asr1000rp1-packages-adventerprisek9.02.01.00.122-33.XNA.conf
57612 -rw- 20334796 May 22 2008 11:26:24 -07:00
asr1000rp1-rpaccess.02.01.00.122-33.XNA.pkg
57613 -rw- 22294732 May 22 2008 11:26:24 -07:00
asr1000rp1-rpbase.02.01.00.122-33.XNA.pkg
57614 -rw- 21946572 May 22 2008 11:26:25 -07:00
asr1000rp1-rpcontrol.02.01.00.122-33.XNA.pkg
57615 -rw- 48099532 May 22 2008 11:26:26 -07:00
asr1000rp1-rpios-adventerprisek9.02.01.00.122-33.XNA.pkg
57616 -rw- 34324684 May 22 2008 11:26:27 -07:00
asr1000rp1-sipbase.02.01.00.122-33.XNA.pkg
57617 -rw- 22124748 May 22 2008 11:26:28 -07:00
asr1000rp1-sipsa.02.01.00.122-33.XNA.pkg
57603 -rw- 6256 May 22 2008 11:26:28 -07:00 packages.conf
 13 -rw- 45977 Apr 9 2008 16:48:46 -07:00 target_support_output.tgz.tgz
928862208 bytes total (286662656 bytes free)

```

## Extracting the SubPackages from a Consolidated Package into a Different File System

The following example shows how to extract the subpackages from a consolidated package into a different file system:

The asr1000rp1-adventerprisek9.02.01.00.122-33.XNA.bin consolidated package file is in usb0:

```

Router# dir usb0:
Directory of usb0:/
 1240 -rwx 208904396 May 27 2008 14:10:20 -07:00
asr1000rp1-adventerprisek9.02.01.00.122-33.XNA.bin
255497216 bytes total (40190464 bytes free)

```

No sub-packages are in the bootflash: directory.

```

Router# dir bootflash:
Directory of bootflash:/
 11 drwx 16384 Dec 13 2004 03:45:47 -08:00 lost+found
87937 drwx 4096 Dec 13 2004 03:46:45 -08:00 .rollback_timer
14657 drwx 4096 Dec 13 2004 03:47:17 -08:00 .installer
29313 drwx 4096 Dec 13 2004 03:53:00 -08:00 .ssh
 12 -rw- 33554432 Dec 13 2004 03:53:49 -08:00 nvram_00100
58625 drwx 4096 May 7 2008 17:27:51 -07:00 .prst_sync
945377280 bytes total (695246848 bytes free)
Router# request platform software package expand file
usb0:asr1000rp1-adventerprisek9.02.01.00.122-33.XNA.bin to bootflash:
Verifying parameters
Validating package type
Copying package files
SUCCESS: Finished expanding all-in-one software package.

```

After the **request platform software package expand file usb0:asr1000rpl-adventerprisek9.02.01.00.122-33.XNA.bin to bootflash:** command is entered, the sub-packages are now in the bootflash: directory.

```
Router# dir bootflash:
Directory of bootflash:/
 11 drwx 16384 Dec 13 2004 03:45:47 -08:00 lost+found
87937 drwx 4096 Dec 13 2004 03:46:45 -08:00 .rollback_timer
14657 drwx 4096 Dec 13 2004 03:47:17 -08:00 .installer
29313 drwx 4096 Dec 13 2004 03:53:00 -08:00 .ssh
 12 -rw- 33554432 Dec 13 2004 03:53:49 -08:00 nvram_00100
43979 -rw- 47071436 May 27 2008 14:25:01 -07:00
asr1000rpl-espbase.02.01.00.122-33.XNA.pkg
58625 drwx 4096 May 7 2008 17:27:51 -07:00 .prst_sync
43970 -rw- 5740 May 27 2008 14:25:00 -07:00
asr1000rpl-packages-adventerprisek9.02.01.00.122-33.XNA.conf
43980 -rw- 20334796 May 27 2008 14:25:01 -07:00
asr1000rpl-rpaccess.02.01.00.122-33.XNA.pkg
43981 -rw- 22294732 May 27 2008 14:25:02 -07:00
asr1000rpl-rpbase.02.01.00.122-33.XNA.pkg
43982 -rw- 21946572 May 27 2008 14:25:03 -07:00
asr1000rpl-rpcontrol.02.01.00.122-33.XNA.pkg
43983 -rw- 48099532 May 27 2008 14:25:04 -07:00
asr1000rpl-rpios-adventerprisek9.02.01.00.122-33.XNA.pkg
43984 -rw- 34324684 May 27 2008 14:25:05 -07:00
asr1000rpl-sipbase.02.01.00.122-33.XNA.pkg
43985 -rw- 22124748 May 27 2008 14:25:05 -07:00
asr1000rpl-sipspa.02.01.00.122-33.XNA.pkg
43971 -rw- 6256 May 27 2008 14:25:05 -07:00 packages.conf
945377280 bytes total (478752768 bytes free)
```

## Configuring the Router to Boot Using the SubPackages

The following example shows how to configure the router to boot using the subpackages:

Enter the **dir bootflash:** command to confirm all sub-packages and the provisioning file are in the same file system:

```
Router# dir bootflash:
Directory of bootflash:/
 11 drwx 16384 Dec 4 2007 04:32:46 -08:00 lost+found
86401 drwx 4096 Dec 4 2007 06:06:24 -08:00 .ssh
14401 drwx 4096 Dec 4 2007 06:06:36 -08:00 .rollback_timer
28801 drwx 4096 Mar 18 2008 17:31:17 -07:00 .prst_sync
43201 drwx 4096 Dec 4 2007 04:34:45 -08:00 .installer
 12 -rw- 208904396 May 9 2008 14:36:31 -07:00
asr1000rpl-adventerprisek9.02.01.00.122-33.XNA.bin
57611 -rw- 47071436 May 22 2008 11:26:23 -07:00
asr1000rpl-espbase.02.01.00.122-33.XNA.pkg
57602 -rw- 5740 May 22 2008 11:26:22 -07:00
asr1000rpl-packages-adventerprisek9.02.01.00.122-33.XNA.conf
57612 -rw- 20334796 May 22 2008 11:26:24 -07:00
asr1000rpl-rpaccess.02.01.00.122-33.XNA.pkg
57613 -rw- 22294732 May 22 2008 11:26:24 -07:00
asr1000rpl-rpbase.02.01.00.122-33.XNA.pkg
57614 -rw- 21946572 May 22 2008 11:26:25 -07:00
asr1000rpl-rpcontrol.02.01.00.122-33.XNA.pkg
57615 -rw- 48099532 May 22 2008 11:26:26 -07:00
asr1000rpl-rpios-adventerprisek9.02.01.00.122-33.XNA.pkg
```



```

57616 -rw- 34324684 May 22 2008 11:26:27 -07:00
asr1000rp1-sipbase.02.01.00.122-33.XNA.pkg
57617 -rw- 22124748 May 22 2008 11:26:28 -07:00
asr1000rp1-sipspa.02.01.00.122-33.XNA.pkg
57603 -rw- 6256 May 22 2008 11:26:28 -07:00 packages.conf
13 -rw- 45977 Apr 9 2008 16:48:46 -07:00 target_support_output.tgz.tgz
928862208 bytes total (286662656 bytes free)
Router# show running-config | include boot
boot-start-marker
boot-end-marker
Router# configure terminal
Enter configuration commands, one per line. End with CNTL/Z.
Router(config)# boot system bootflash:packages.conf
Router(config)# config-reg 0x2102
Router(config)# exit
Router# config t
*May 29 22:47:57.433: %SYS-5-CONFIG_I: Configured from console by user
Router# show running-config | include boot
boot-start-marker
boot system bootflash:packages.conf
boot-end-marker
Router# copy run start
Destination filename [startup-config]?
Building configuration...
[OK]
Router# reload
Proceed with reload? [confirm]
*May 29 22:51:54.194: %SYS-5-RELOAD: Reload requested by user on console. Reload Reason:
Reload command.
System Bootstrap, Version 12.2(33r)XN2, RELEASE SOFTWARE (fc1)
Technical Support: http://www.cisco.com/techsupport
Copyright (c) 2008 by cisco Systems, Inc.
Current image running: Boot ROM0
Last reset cause: LocalSoft
ASR1000-RP1 platform with 4194303 Kbytes of main memory
Located packages.conf
Image size 6256 inode num 57603, bks cnt 2 blk size 8*512
#
Located asr1000rp1-rpbase.02.01.00.122-33.XNA.pkg
Image size 22294732 inode num 57606, bks cnt 5444 blk size 8*512
=====
Boot image size = 22294732 (0x15430cc) bytes
Using midplane macaddr
Package header rev 0 structure detected
Calculating SHA-1 hash...done
validate_package: SHA-1 hash:
 calculated 4ad33773:e1cb7492:db502416:4ad586f2:7c4d9701
 expected 4ad33773:e1cb7492:db502416:4ad586f2:7c4d9701
Image validated
PPC/IOS XE loader version: 0.0.3
loaded at: 00800000 01D45004
zimage at: 00807673 009B92D6
initrd at: 009BA000 01041CC9
isord at: 01042000 01D42800
avail ram: 00400000 00800000
Kernel load:
Uncompressing image... dst: 00000000 lim: 00400000 start: 00807673 size: 001B1C63...done.
Now booting the IOS XE kernel
%IOSXEBOOT-4-BOOT_SRC: (rp/0): Non-HD Boot
%IOSXEBOOT-4-BOOT_PARAMETER: (rp/0): Booting with custom BOOT_PARAM setting
Restricted Rights Legend
Use, duplication, or disclosure by the Government is
subject to restrictions as set forth in subparagraph
(c) of the Commercial Computer Software - Restricted

```

```

Rights clause at FAR sec. 52.227-19 and subparagraph
(c) (1) (ii) of the Rights in Technical Data and Computer
Software clause at DFARS sec. 252.227-7013.
 cisco Systems, Inc.
 170 West Tasman Drive
 San Jose, California 95134-1706
Cisco IOS Software, IOS-XE Software (PPC_LINUX_IOSD-ADVENTERPRISEK9-M), Version 12.2(33)XNA,
 RELEASE SOFTWARE (fc1)
Technical Support: http://www.cisco.com/techsupport
Copyright (c) 1986-2008 by Cisco Systems, Inc.
Compiled Thu 01-May-08 00:29 by mcpre
Image text-base: 0x10064AF0, data-base: 0x137E0958
Cisco IOS-XE software, Copyright (c) 1986-2008 by Cisco Systems, Inc.
All rights reserved. Certain components of Cisco IOS-XE software are
licensed under the GNU General Public License (GPL) Version 2.0. The
software code licensed under GPL Version 2.0 is free software that comes
with ABSOLUTELY NO WARRANTY. You can redistribute and/or modify such
GPL code under the terms of GPL Version 2.0. For more details, see the
documentation or License Notice file accompanying the IOS-XE software,
or the applicable URL provided on the flyer accompanying the IOS-XE
software.
This product contains cryptographic features and is subject to United
States and local country laws governing import, export, transfer and
use. Delivery of Cisco cryptographic products does not imply
third-party authority to import, export, distribute or use encryption.
Importers, exporters, distributors and users are responsible for
compliance with U.S. and local country laws. By using this product you
agree to comply with applicable laws and regulations. If you are unable
to comply with U.S. and local laws, return this product immediately.
A summary of U.S. laws governing Cisco cryptographic products may be found at:
http://www.cisco.com/wwl/export/crypto/tool/stqrg.html
If you require further assistance please contact us by sending email to
export@cisco.com.
cisco ASR1006 (RP1) processor with 1776227K/6147K bytes of memory.
5 Gigabit Ethernet interfaces
2 Packet over SONET interfaces
2 Channelized T3 ports
32768K bytes of non-volatile configuration memory.
4194304K bytes of physical memory.
921599K bytes of eUSB flash at bootflash:.
39004543K bytes of SATA hard disk at harddisk:.
Duplex is configured.Remove duplex configuration before enabling auto-negotiation
Press RETURN to get started!
<some output removed for brevity?
User Access Verification
Username: user
Password:
Router> enable
Password:
Router# show version
Cisco IOS Software, IOS-XE Software (PPC_LINUX_IOSD-ADVENTERPRISEK9-M), Version 12.2(33)XNA,
 RELEASE SOFTWARE (fc1)
Technical Support: http://www.cisco.com/techsupport
Copyright (c) 1986-2008 by Cisco Systems, Inc.
Compiled Thu 01-May-08 00:29 by mcpre
Cisco IOS-XE software, Copyright (c) 1986-2008 by Cisco Systems, Inc.
All rights reserved. Certain components of Cisco IOS-XE software are
licensed under the GNU General Public License (GPL) Version 2.0. The
software code licensed under GPL Version 2.0 is free software that comes
with ABSOLUTELY NO WARRANTY. You can redistribute and/or modify such
GPL code under the terms of GPL Version 2.0. For more details, see the
documentation or License Notice file accompanying the IOS-XE software,
or the applicable URL provided on the flyer accompanying the IOS-XE
software.

```

```

ROM: IOS-XE ROMMON
 Router uptime is 1 minute
 Uptime for this control processor is 3 minutes
 System returned to ROM by reload at 15:51:54 DST Thu May 29 2008 System image file is
 bootflash:packages.conf Last reload reason: Reload command
 This product contains cryptographic features and is subject to United
 States and local country laws governing import, export, transfer and
 use. Delivery of Cisco cryptographic products does not imply
 third-party authority to import, export, distribute or use encryption.
 Importers, exporters, distributors and users are responsible for
 compliance with U.S. and local country laws. By using this product you
 agree to comply with applicable laws and regulations. If you are unable
 to comply with U.S. and local laws, return this product immediately.
 A summary of U.S. laws governing Cisco cryptographic products may be found at:
 http://www.cisco.com/wwl/export/crypto/tool/stqrg.html
 If you require further assistance please contact us by sending email to
 export@cisco.com.
 cisco ASR1006 (RP1) processor with 1776227K/6147K bytes of memory.
 5 Gigabit Ethernet interfaces
 8 Serial interfaces
 8 Channelized T1 ports
 2 Packet over SONET interfaces
 2 Channelized T3 ports
 32768K bytes of non-volatile configuration memory.
 4194304K bytes of physical memory.
 921599K bytes of eUSB flash at bootflash:.
 39004543K bytes of SATA hard disk at harddisk:.
 Configuration register is 0x2102

```

## Backing Up Configuration Files

This section provides the following examples:

### Copying a Startup Configuration File to Bootflash

```

Router# dir bootflash:
Directory of bootflash:/
 11 drwx 16384 Dec 4 2007 04:32:46 -08:00 lost+found
86401 drwx 4096 Dec 4 2007 06:06:24 -08:00 .ssh
14401 drwx 4096 Dec 4 2007 06:06:36 -08:00 .rollback_timer
28801 drwx 4096 May 29 2008 16:31:41 -07:00 .prst_sync
43201 drwx 4096 Dec 4 2007 04:34:45 -08:00 .installer
 12 -rw- 208904396 May 28 2008 16:17:34 -07:00
asr1000rp1-adventerprisek9.02.01.00.122-33.XNA.bin
Router# copy nvram:startup-config bootflash:
Destination filename [startup-config]?
3517 bytes copied in 0.647 secs (5436 bytes/sec)
Router# dir bootflash:
Directory of bootflash:/
 11 drwx 16384 Dec 4 2007 04:32:46 -08:00 lost+found
86401 drwx 4096 Dec 4 2007 06:06:24 -08:00 .ssh
14401 drwx 4096 Dec 4 2007 06:06:36 -08:00 .rollback_timer
28801 drwx 4096 May 29 2008 16:31:41 -07:00 .prst_sync
43201 drwx 4096 Dec 4 2007 04:34:45 -08:00 .installer
 12 -rw- 208904396 May 28 2008 16:17:34 -07:00
asr1000rp1-adventerprisek9.02.01.00.122-33.XNA.bin
13 -rw- 7516 Jul 2 2008 15:01:39 -07:00 startup-config

```

## Copying a Startup Configuration File to a USB Flash Disk

```

Router# dir usb0:
Directory of usb0:/
43261 -rwx 208904396 May 27 2008 14:10:20 -07:00
asr1000rp1-adventerprisek9.02.01.00.122-33.XNA.bin
255497216 bytes total (40190464 bytes free)
Router# copy nvram:startup-config usb0:
Destination filename [startup-config]?
3172 bytes copied in 0.214 secs (14822 bytes/sec)
Router# dir usb0:
Directory of usb0:/
43261 -rwx 208904396 May 27 2008 14:10:20 -07:00
asr1000rp1-adventerprisek9.02.01.00.122-33.XNA.bin43262 -rwx 3172 Jul 2 2008
15:40:45 -07:00 startup-config255497216 bytes total (40186880 bytes free)

```

## Copying a Startup Configuration File to a TFTP Server

```

Router# copy bootflash:startup-config tftp:
Address or name of remote host []? 198.51.100.81
Destination filename [pe24_asr-1002-config]? /auto/tftp-users/user/startup-config
!!
3517 bytes copied in 0.122 secs (28828 bytes/sec)

```

## Enabling a Second IOS Process on a Single RP Using SSO

The `show platform` command output does not indicate a second IOS process is active:

```

Router# show platform
Chassis type: ASR1004
Slot Type State Insert time (ago)

0 ASR1000-SIP10 ok 00:04:39
0/0 SPA-5X1GE-V2 ok 00:03:23
0/1 SPA-2XT3/E3 ok 00:03:18
R0 ASR1000-RP1 ok, active 00:04:39
F0 ASR1000-ESP10 ok, active 00:04:39
P0 ASR1004-PWR-AC ok 00:03:52
P1 ASR1004-PWR-AC ok 00:03:52
Slot CPLD Version Firmware Version

0 07091401 12.2(33r)XN2
R0 07062111 12.2(33r)XN2
F0 07051680 12.2(33r)XN2

```

The `show redundancy states` command output shows that the redundancy state is nonredundant:

```

Router# show redundancy states
my state = 13 -ACTIVE
peer state = 1 -DISABLED
Mode = Simplex
Unit ID = 48
Redundancy Mode (Operational) = Non-redundant
Redundancy Mode (Configured) = Non-redundant
Redundancy State = Non Redundant
Maintenance Mode = Disabled

```

```

Manual Swact = disabled (system is simplex (no peer unit))
Communications = Down Reason: Simplex mode
client count = 66
client_notification_TMR = 30000 milliseconds
RF debug mask = 0x0

```

SSO is configured:

```

Router# configure terminal
Enter configuration commands, one per line. End with CNTL/Z.
Router(config)# redundancy
Router(config-red)# mode sso
*May 27 19:43:43.539: %CMRP-6-DUAL_IOS_REBOOT_REQUIRED: R0/0: cmand: Configuration must
be saved and the chassis must be rebooted for IOS redundancy changes to take effect
Router(config-red)# exit
Router(config)# exit
Router#show
*May 27 19:44:04.173: %SYS-5-CONFIG_I: Configured from console by user on console

```

The **show redundancy states** command output now indicates that SSO is configured but not operational:

```

Router# show redundancy states
my state = 13 -ACTIVE
peer state = 1 -DISABLED
Mode = Simplex
Unit ID = 48
Redundancy Mode (Operational) = Non-redundant
Redundancy Mode (Configured) = sso
Redundancy State = Non Redundant
Maintenance Mode = Disabled
Manual Swact = disabled (system is simplex (no peer unit))
Communications = Down Reason: Simplex mode
client count = 66
client_notification_TMR = 30000 milliseconds
RF debug mask = 0x0

```

The **show platform** command output continues to show a second IOS process is still not running:

```

Router# show platform
Chassis type: ASR1004
Slot Type State Insert time (ago)

0 ASR1000-SIP10 ok 00:05:53
0/0 SPA-5X1GE-V2 ok 00:04:37
0/1 SPA-2XT3/E3 ok 00:04:32
R0 ASR1000-RP1 ok, active 00:05:53
F0 ASR1000-ESP10 ok, active 00:05:53
P0 ASR1004-PWR-AC ok 00:05:06
P1 ASR1004-PWR-AC ok 00:05:06
Slot CPLD Version Firmware Version

0 07091401 12.2(33r)XN2
R0 07062111 12.2(33r)XN2
F0 07051680 12.2(33r)XN2
Router# copy running-config startup-config
Destination filename [startup-config]?
Building configuration...
[OK]

```

The router needs to be reloaded after saving the running configuration to make SSO the operational redundancy mode:

```

Router# reload
Proceed with reload? [confirm]
*May 27 19:45:16.917: %SYS-5-RELOAD: Reload requested by user on console. Reload Reason:
Reload command.
System Bootstrap, Version 12.2(33r)XN2, RELEASE SOFTWARE (fc1)
Technical Support: http://www.cisco.com/techsupport
Copyright (c) 2008 by cisco Systems, Inc.
Current image running: Boot ROM1
Last reset cause: LocalSoft
ASR1000-RP1 platform with 4194303 Kbytes of main memory
Located packages.conf
Image size 6256 inode num 43971, bks cnt 2 blk size 8*512
#
Located asr1000rp1-rpbase.02.01.00.122-33.XNA.pkg
Image size 22294732 inode num 43974, bks cnt 5444 blk size 8*512
=====
Boot image size = 22294732 (0x15430cc) bytes
Using midplane macaddr
Package header rev 0 structure detected
Calculating SHA-1 hash...done
validate_package: SHA-1 hash:
 calculated 4ad33773:e1cb7492:db502416:4ad586f2:7c4d9701
 expected 4ad33773:e1cb7492:db502416:4ad586f2:7c4d9701
Image validated
PPC/IOS XE loader version: 0.0.3
loaded at: 00800000 01D45004
zimage at: 00807673 009B92D6
initrd at: 009BA000 01041CC9
isord at: 01042000 01D42800
avail ram: 00400000 00800000
Kernel load:
Uncompressing image... dst: 00000000 lim: 00400000 start: 00807673 size: 001B1C63...done.
Now booting the IOS XE kernel
%IOSXEBOOT-4-BOOT_SRC: (rp/0): Non-HD Boot
%IOSXEBOOT-4-BOOT_PARAMETER: (rp/0): Booting with custom BOOT_PARAM setting
 Restricted Rights Legend
Use, duplication, or disclosure by the Government is
subject to restrictions as set forth in subparagraph
(c) of the Commercial Computer Software - Restricted
Rights clause at FAR sec. 52.227-19 and subparagraph
(c) (1) (ii) of the Rights in Technical Data and Computer
Software clause at DFARS sec. 252.227-7013.
 cisco Systems, Inc.
 170 West Tasman Drive
 San Jose, California 95134-1706
Cisco IOS Software, IOS-XE Software (PPC_LINUX_IOSD-ADVENTERPRISEK9-M), Version 12.2(33)XNA,
RELEASE SOFTWARE (fc1)
Technical Support: http://www.cisco.com/techsupport
Copyright (c) 1986-2008 by Cisco Systems, Inc.
Compiled Thu 01-May-08 00:29 by mcpre
Image text-base: 0x10064AF0, data-base: 0x137E0958
Cisco IOS-XE software, Copyright (c) 1986-2008 by Cisco Systems, Inc.
All rights reserved. Certain components of Cisco IOS-XE software are
licensed under the GNU General Public License (GPL) Version 2.0. The
software code licensed under GPL Version 2.0 is free software that comes
with ABSOLUTELY NO WARRANTY. You can redistribute and/or modify such
GPL code under the terms of GPL Version 2.0. For more details, see the
documentation or License Notice file accompanying the IOS-XE software,
or the applicable URL provided on the flyer accompanying the IOS-XE
software.
This product contains cryptographic features and is subject to United
States and local country laws governing import, export, transfer and
use. Delivery of Cisco cryptographic products does not imply

```

```

third-party authority to import, export, distribute or use encryption.
Importers, exporters, distributors and users are responsible for
compliance with U.S. and local country laws. By using this product you
agree to comply with applicable laws and regulations. If you are unable
to comply with U.S. and local laws, return this product immediately.
A summary of U.S. laws governing Cisco cryptographic products may be found at:
http://www.cisco.com/wwl/export/crypto/tool/stqrg.html
If you require further assistance please contact us by sending email to
export@cisco.com.
cisco ASR1004 (RP1) processor with 752227K/6147K bytes of memory.
5 Gigabit Ethernet interfaces
32768K bytes of non-volatile configuration memory.
4194304K bytes of physical memory.
937983K bytes of eUSB flash at bootflash:.
39004543K bytes of SATA hard disk at harddisk:.
253424K bytes of USB flash at usb0:.
Press RETURN to get started!
<some output omitted for brevity>
User Access Verification
Username: user
Password:
Router> enable
Password:

```

The **show platform** command output now indicates a second IOS process is active on RP 0:

```

Router# show platform
Chassis type: ASR1004
Slot Type State Insert time (ago)

0 ASR1000-SIP10 ok 00:29:34
 0/0 SPA-5X1GE-V2 ok 00:28:13
 0/1 SPA-2XT3/E3 ok 00:28:18
R0 ASR1000-RP1 ok 00:29:34 R0/0
 ok, active 00:29:34 R0/1 ok, standby
 00:27:49 F0 ASR1000-ESP10 ok, active 00:29:34
P0 ASR1004-PWR-AC ok 00:28:47
P1 ASR1004-PWR-AC ok 00:28:47
Slot CPLD Version Firmware Version

0 07091401 12.2 (33r)XN2
R0 07062111 12.2 (33r)XN2
F0 07051680 12.2 (33r)XN2

```

The **show redundancy states** command shows SSO as the operational redundancy mode:

```

Router# show redundancy states
 my state = 13 -ACTIVE
 peer state = 8 -STANDBY HOT
 Mode = Duplex
 Unit ID = 48
Redundancy Mode (Operational) = sso
Redundancy Mode (Configured) = sso
Redundancy State = sso
 Maintenance Mode = Disabled
 Manual Swact = enabled
 Communications = Up
 client count = 66
 client_notification_TMR = 30000 milliseconds
 RF debug mask = 0x0

```

# ISSU—Consolidated Package Upgrade

In the following example, ISSU is used to upgrade two RPs in the same Cisco ASR 1000 Series Router to consolidated packages. The RPs are being upgraded from Cisco IOS XE Release 2.1.0, which uses Cisco IOS Release 12.2(33)XNA, to Cisco IOS XE Release 2.1.1, which uses Cisco IOS Release 12.2(33)XNA1.

The example starts with the user logged into RP 0, the active RP.

```
Router# show version
```

```
Cisco IOS Software, IOS-XE Software (PPC_LINUX_IOSD-ADVENTERPRISEK9-M), Version 12.2(33)XNA,
 RELEASE SOFTWARE (fc1)
Technical Support: http://www.cisco.com/techsupport
Copyright (c) 1986-2008 by Cisco Systems, Inc.
Compiled Thu 01-May-08 00:29 by mcpre
Cisco IOS-XE software, Copyright (c) 1986-2008 by Cisco Systems, Inc.
All rights reserved. Certain components of Cisco IOS-XE software are
licensed under the GNU General Public License (GPL) Version 2.0. The
software code licensed under GPL Version 2.0 is free software that comes
with ABSOLUTELY NO WARRANTY. You can redistribute and/or modify such
GPL code under the terms of GPL Version 2.0. For more details, see the
documentation or License Notice file accompanying the IOS-XE software,
or the applicable URL provided on the flyer accompanying the IOS-XE
software.
ROM: IOS-XE ROMMON
 Router uptime is 2 weeks, 2 hours, 54 minutes
Uptime for this control processor is 1 hour, 7 minutes
System returned to ROM by reload at 15:24:15 DST Mon Jul 21 2008
System image file is bootflash:asr1000rpl-adventerprisek9.02.01.00.122-33.XNA.bin
Last reload reason: redundancy force-switchover
This product contains cryptographic features and is subject to United
States and local country laws governing import, export, transfer and
use. Delivery of Cisco cryptographic products does not imply
third-party authority to import, export, distribute or use encryption.
Importers, exporters, distributors and users are responsible for
compliance with U.S. and local country laws. By using this product you
agree to comply with applicable laws and regulations. If you are unable
to comply with U.S. and local laws, return this product immediately.
A summary of U.S. laws governing Cisco cryptographic products may be found at:
http://www.cisco.com/wwl/export/crypto/tool/stqrg.html
If you require further assistance please contact us by sending email to
export@cisco.com.
cisco ASR1006 (RP1) processor with 1772131K/6147K bytes of memory.
 8 FastEthernet interfaces
 5 Gigabit Ethernet interfaces
 8 Serial interfaces
 8 Channelized T1 ports
 2 Packet over SONET interfaces
 2 Channelized T3 ports
32768K bytes of non-volatile configuration memory.
4194304K bytes of physical memory.
921599K bytes of eUSB flash at bootflash:.
39004543K bytes of SATA hard disk at harddisk:.
Configuration register is 0x2102
Router# dir bootflash:
Directory of bootflash:/
 11 drwx 16384 Dec 4 2007 04:32:46 -08:00 lost+found
86401 drwx 4096 Dec 4 2007 06:06:24 -08:00 .ssh
14401 drwx 4096 Dec 4 2007 06:06:36 -08:00 .rollback_timer
```



```

28801 drwx 4096 Jul 21 2008 15:29:25 -07:00 .prst_sync
43201 drwx 4096 Dec 4 2007 04:34:45 -08:00 .installer
 12 -rw- 208904396 May 28 2008 16:17:34 -07:00 asr1000rp1-adventerprisek9.02.01.00.122-33.XNA.bin
13 -rw- 7516 Jul 2 2008 15:01:39 -07:00 startup-config
 14 -rw- 45977 Apr 9 2008 16:48:46 -07:00 target_support_output.tgz.tgz
928862208 bytes total (76644352 bytes free)
Router# dir stby-bootflash:
Directory of stby-bootflash:/
 11 drwx 16384 Dec 13 2004 03:45:47 -08:00 lost+found
87937 drwx 4096 Jul 17 2008 16:43:34 -07:00 .rollback_timer
14657 drwx 4096 Jul 17 2008 16:43:34 -07:00 .installer
29313 drwx 4096 Dec 13 2004 03:53:00 -08:00 .ssh
 12 -rw- 33554432 Dec 13 2004 03:53:49 -08:00 nvram_00100
 13 -rw- 208904396 Jun 5 2008 20:12:53 -07:00
asr1000rp1-adventerprisek9.02.01.00.122-33.XNA.bin
58625 drwx 4096 Jul 21 2008 15:32:59 -07:00 .prst_sync
945377280 bytes total (276652032 bytes free)
Router# copy tftp bootflash:
Address or name of remote host []? 198.51.100.81

Source filename []? /auto/tftp-users/user/asr1000rp1-adventerprisek9.02.01.01.122-33.XNA1.bin

Destination filename [asr1000rp1-adventerprisek9.02.01.01.122-33.XNA1.bin]?
Accessing
tftp://198.51.100.81/auto/tftp-users/user/asr1000rp1-adventerprisek9.02.01.01.122-33.XNA1.bin...
Loading /auto/tftp-users/user/asr1000rp1-adventerprisek9.02.01.01.122-33.XNA1.bin from
198.51.100.81 (via GigabitEthernet0):

#####
[OK - 209227980 bytes]
209227980 bytes copied in 329.215 secs (635536 bytes/sec)
Router# copy bootflash:asr1000rp1-adventerprisek9.02.01.01.122-33.XNA1.bin stby-bootflash:

Destination filename [asr1000rp1-adventerprisek9.02.01.01.122-33.XNA1.bin]?
Copy in progress...CCCCCCCC<output removed for brevity>
209227980 bytes copied in 434.790 secs (481216 bytes/sec)
Router# dir bootflash:
Directory of bootflash:/
 11 drwx 16384 Dec 4 2007 04:32:46 -08:00 lost+found
86401 drwx 4096 Dec 4 2007 06:06:24 -08:00 .ssh
14401 drwx 4096 Dec 4 2007 06:06:36 -08:00 .rollback_timer
28801 drwx 4096 Jul 21 2008 15:29:25 -07:00 .prst_sync
43201 drwx 4096 Dec 4 2007 04:34:45 -08:00 .installer
 12 -rw- 208904396 May 28 2008 16:17:34 -07:00
asr1000rp1-adventerprisek9.02.01.00.122-33.XNA.bin
 15 -rw- 7516 Jul 2 2008 15:01:39 -07:00 startup-config
 13 -rw- 45977 Apr 9 2008 16:48:46 -07:00 target_support_output.tgz.tgz
 16 -rw- 209227980 Jul 17 2008 16:06:58 -07:00
asr1000rp1-adventerprisek9.02.01.01.122-33.XNA1.bin
928862208 bytes total (76644352 bytes free)
Router# dir stby-bootflash:
Directory of stby-bootflash:/
 11 drwx 16384 Dec 13 2004 03:45:47 -08:00 lost+found
87937 drwx 4096 Jul 17 2008 16:43:34 -07:00 .rollback_timer
14657 drwx 4096 Jul 17 2008 16:43:34 -07:00 .installer
29313 drwx 4096 Dec 13 2004 03:53:00 -08:00 .ssh
 12 -rw- 33554432 Dec 13 2004 03:53:49 -08:00 nvram_00100
 13 -rw- 208904396 Jun 5 2008 20:12:53 -07:00
asr1000rp1-adventerprisek9.02.01.00.122-33.XNA.bin
58625 drwx 4096 Jul 21 2008 15:32:59 -07:00 .prst_sync
 14 -rw- 209227980 Jul 17 2008 16:16:07 -07:00
asr1000rp1-adventerprisek9.02.01.01.122-33.XNA1.bin
945377280 bytes total (276652032 bytes free)

```

```

Router# issu loadversion rp 1 file
stby-bootflash:asr1000rpl-adventerprisek9.02.01.01.122-33.XNA1.bin

--- Starting installation state synchronization ---
Finished installation state synchronization
--- Starting file path checking ---
Finished file path checking
--- Starting system installation readiness checking ---
Finished system installation readiness checking
--- Starting installation changes ---
Setting up image to boot on next reset
Starting automatic rollback timer
Finished installation changes
SUCCESS: Software will now load.
Router#
*Jul 21 23:34:27.206: %ASR1000_OIR-6-OFFLINECARD: Card (rp) offline in slot R1
*Jul 21 23:34:27.271: %REDUNDANCY-3-STANDBY_LOST: Standby processor fault (PEER_NOT_PRESENT)
*Jul 21 23:34:27.271: %REDUNDANCY-3-STANDBY_LOST: Standby processor fault (PEER_DOWN)
*Jul 21 23:34:27.271: %REDUNDANCY-3-STANDBY_LOST: Standby processor fault
(PEER_REDUNDANCY_STATE_CHANGE)
*Jul 21 23:37:05.528: %ASR1000_OIR-6-ONLINECARD: Card (rp) online in slot R1
*Jul 21 23:37:25.480: %REDUNDANCY-5-PEER_MONITOR_EVENT: Active detected a standby insertion
(raw-event=PEER_FOUND(4))
*Jul 21 23:37:25.480: %REDUNDANCY-5-PEER_MONITOR_EVENT: Active detected a standby insertion
(raw-event=PEER_REDUNDANCY_STATE_CHANGE(5))
Finished installation state synchronization
*Jul 21 23:37:26.349: %REDUNDANCY-3-IPC: IOS versions do not match.
*Jul 21 23:38:47.172: %HA_CONFIG_SYNC-6-BULK_CFGSYNC_SUCCEEDED: Bulk Sync succeeded
*Jul 21 23:38:47.173: %RF-5-RF_TERMINAL_STATE: Terminal state reached for (SSO)
Router# issu runversion
--- Starting installation state synchronization ---
Finished installation state synchronization
Initiating active RP failover
SUCCESS: Standby RP will now become active
Router#
System Bootstrap, Version 12.2(33r)XN2, RELEASE SOFTWARE (fc1)
Technical Support: http://www.cisco.com/techsupport
Copyright (c) 2008 by Cisco Systems, Inc.
<additional output removed for brevity>
*Jul 21 23:43:31.970: %SYS-5-RESTART: System restarted --
Cisco IOS Software, IOS-XE Software (PPC_LINUX_IOSD-ADVENTERPRISEK9-M), Version 12.2(33)XNA,
RELEASE SOFTWARE (fc1)
Technical Support: http://www.cisco.com/techsupport
Copyright (c) 1986-2008 by Cisco Systems, Inc.
Compiled Thu 01-May-08 00:29 by mcpre
*Jul 21 23:43:31.978: %SSH-5-ENABLED: SSH 1.99 has been enabled
*Jul 21 23:43:35.196: Relay: standby progression done
*Jul 21 23:43:35.197: %PLATFORM-6-RF_PROG_SUCCESS: RF state STANDBY HOT

```

At this point of the process, the user has to log onto RP1, which started the upgrade as the standby RP but is the active RP after the switchover.

The following commands are entered from RP1:

```

Router# issu acceptversion
Cancelling rollback timer
SUCCESS: Rollback timer cancelled
Router# issu commitversion
--- Starting installation changes ---
Cancelling rollback timer
Saving image changes
Finished installation changes
Building configuration...

```

```

[OK]
SUCCESS: version committed: bootflash:asr1000rp1-adventerprisek9.02.01.01.122-33.XNA1.bin
Router# show version
Cisco IOS Software, IOS-XE Software (PPC_LINUX_IOSD-ADVENTERPRISEK9-M), Version 12.2(33)XNA1,
 RELEASE SOFTWARE (fc1)
Technical Support: http://www.cisco.com/techsupport
Copyright (c) 1986-2008 by Cisco Systems, Inc.
Compiled Tue 08-Jul-08 14:40 by mcpre
Cisco IOS-XE software, Copyright (c) 1986-2008 by Cisco Systems, Inc.
All rights reserved. Certain components of Cisco IOS-XE software are
licensed under the GNU General Public License (GPL) Version 2.0. The
software code licensed under GPL Version 2.0 is free software that comes
with ABSOLUTELY NO WARRANTY. You can redistribute and/or modify such
GPL code under the terms of GPL Version 2.0. For more details, see the
documentation or License Notice file accompanying the IOS-XE software,
or the applicable URL provided on the flyer accompanying the IOS-XE
software.
ROM: IOS-XE ROMMON
 Router uptime is 2 weeks, 3 hours, 8 minutes
 Uptime for this control processor is 11 minutes
 System returned to ROM by reload at 15:29:24 DST Mon Jul 21 2008
 System image file is bootflash:asr1000rp1-adventerprisek9.02.01.01.122-33.XNA1.bin
 Last reload reason: EHSa standby down
 This product contains cryptographic features and is subject to United
 States and local country laws governing import, export, transfer and
 use. Delivery of Cisco cryptographic products does not imply
 third-party authority to import, export, distribute or use encryption.
 Importers, exporters, distributors and users are responsible for
 compliance with U.S. and local country laws. By using this product you
 agree to comply with applicable laws and regulations. If you are unable
 to comply with U.S. and local laws, return this product immediately.
 A summary of U.S. laws governing Cisco cryptographic products may be found at:
 http://www.cisco.com/wwl/export/crypto/tool/stqrg.html
 If you require further assistance please contact us by sending email to
 export@cisco.com.
 cisco ASR1006 (RP1) processor with 1772046K/6147K bytes of memory.
 8 FastEthernet interfaces
 5 Gigabit Ethernet interfaces
 8 Serial interfaces
 8 Channelized T1 ports
 2 Packet over SONET interfaces
 2 Channelized T3 ports
 32768K bytes of non-volatile configuration memory.
 4194304K bytes of physical memory.
 937983K bytes of eUSB flash at bootflash:.
 39004543K bytes of SATA hard disk at harddisk:.
 253424K bytes of USB flash at usb0:.
 Configuration register is 0x2102
Router# show running-config | include boot
boot-start-marker
boot system bootflash:asr1000rp1-adventerprisek9.02.01.01.122-33.XNA1.bin
boot system bootflash:asr1000rp1-adventerprisek9.02.01.00.122-33.XNA1.bin
boot-end-marker
Router#

```

At this point of the procedure, the upgrade of RP1 is complete.

The following procedure uses the same steps to upgrade RP0. The user is still on RP1 when this process begins:

```

Router# show platform

Chassis type: ASR1006
Slot Type State Insert time (ago)

```

```

0 ASR1000-SIP10 ok 00:16:10
0/0 SPA-5X1GE-V2 ok 00:10:50
0/1 SPA-8X1FE-TX-V2 ok 00:10:46
0/2 SPA-2XCT3/DS0 ok 00:10:42
1 ASR1000-SIP10 ok 00:16:10
1/0 SPA-2XOC3-POS ok 00:10:49
1/1 SPA-8XCHT1/E1 ok 00:10:45
1/2 SPA-2XT3/E3 ok 00:10:41
R0 ASR1000-RP1 ok, standby 00:16:10
R1 ASR1000-RP1 ok, active 00:16:10
F0 ASR1000-ESP10 ok, standby 00:16:10
F1 ASR1000-ESP10 ok, active 00:16:10
P0 ASR1006-PWR-AC ok 00:15:07
P1 ASR1006-FAN ok 00:15:07
Slot CPLD Version Firmware Version

0 06120701 12.2(33r)XN2
1 06120701 12.2(33r)XN2
R0 07082312 12.2(33r)XN2
R1 07062111 12.2(33r)XN2
F0 07051680 12.2(33r)XN2
F1 07051680 12.2(33r)XN2
Router# issu loadversion rp 0 file
stby-bootflash:asr1000rp1-adventerprisek9.02.01.01.122-33.XNA1.bin
--- Starting installation state synchronization ---
Finished installation state synchronization
--- Starting file path checking ---
Finished file path checking
--- Starting system installation readiness checking ---
Finished system installation readiness checking
--- Starting installation changes ---
Setting up image to boot on next reset
Starting automatic rollback timer
Finished installation changes
SUCCESS: Software will now load.
Router#
*Jul 21 23:53:41.218: %ASR1000_OIR-6-OFFLINECARD: Card (rp) offline in slot R0
*Jul 21 23:53:41.256: %REDUNDANCY-3-STANDBY_LOST: Standby processor fault (PEER_NOT_PRESENT)
*Jul 21 23:53:41.256: %REDUNDANCY-3-STANDBY_LOST: Standby processor fault (PEER_DOWN)
*Jul 21 23:53:41.256: %REDUNDANCY-3-STANDBY_LOST: Standby processor fault
(PEER_REDUNDANCY_STATE_CHANGE)
*Jul 21 23:53:42.423: %IP-4-DUPADDR: Duplicate address 198.51.100.155 on GigabitEthernet0,
sourced by 001a.3046.e3ff
*Jul 21 23:56:19.885: %ASR1000_OIR-6-ONLINECARD: Card (rp) online in slot R0
*Jul 21 23:56:39.324: %REDUNDANCY-5-PEER_MONITOR_EVENT: Active detected a standby insertion
(raw-event=PEER_FOUND(4))
*Jul 21 23:56:39.324: %REDUNDANCY-5-PEER_MONITOR_EVENT: Active detected a standby insertion
(raw-event=PEER_REDUNDANCY_STATE_CHANGE(5))
*Jul 21 23:58:03.660: %HA_CONFIG_SYNC-6-BULK_CFGSYNC_SUCCEEDED: Bulk Sync succeeded
*Jul 21 23:58:03.661: %RF-5-RF_TERMINAL_STATE: Terminal state reached for (SSO)
Router# issu runversion
--- Starting installation state synchronization ---
Finished installation state synchronization
Initiating active RP failover
SUCCESS: Standby RP will now become active
Router#
System Bootstrap, Version 12.2(33r)XN2, RELEASE SOFTWARE (fcl)
Technical Support: http://www.cisco.com/techsupport
Copyright (c) 2008 by cisco Systems, Inc.
<Output removed for brevity>

```

After the switchover, the user must log onto RP0.

The remaining commands are all entered from RP0:

```

Router# issu acceptversion
Cancelling rollback timer
SUCCESS: Rollback timer cancelled
Router# issu commitversion
*Jul 22 00:10:45.488: %HA_CONFIG_SYNC-6-BULK_CFGSYNC_SUCCEED: Bulk Sync succeeded
*Jul 22 00:10:45.489: %RF-5-RF_TERMINAL_STATE: Terminal state reached for (SSO)
--- Starting installation changes ---
Cancelling rollback timer
Saving image changes
Finished installation changes
Building configuration...
[OK]
SUCCESS: version committed: bootflash:asr1000rp1-adventerprisek9.02.01.01.122-33.XNA1.bin
Router# show version
Cisco IOS Software, IOS-XE Software (PPC_LINUX_IOSD-ADVENTERPRISEK9-M), Version 12.2(33)XNA1,
RELEASE SOFTWARE (fcl)
Technical Support: http://www.cisco.com/techsupport
Copyright (c) 1986-2008 by Cisco Systems, Inc.
Compiled Tue 08-Jul-08 14:40 by mcpre
Cisco IOS-XE software, Copyright (c) 1986-2008 by Cisco Systems, Inc.
All rights reserved. Certain components of Cisco IOS-XE software are
licensed under the GNU General Public License (GPL) Version 2.0. The
software code licensed under GPL Version 2.0 is free software that comes
with ABSOLUTELY NO WARRANTY. You can redistribute and/or modify such
GPL code under the terms of GPL Version 2.0. For more details, see the
documentation or License Notice file accompanying the IOS-XE software,
or the applicable URL provided on the flyer accompanying the IOS-XE
software.
ROM: IOS-XE ROMMON
 Router uptime is 2 weeks, 3 hours, 33 minutes
 Uptime for this control processor is 16 minutes
 System returned to ROM by reload at 15:24:15 DST Mon Jul 21 2008
 System image file is bootflash:asr1000rp1-adventerprisek9.02.01.01.122-33.XNA1.bin
 Last reload reason: EHSa standby down
 This product contains cryptographic features and is subject to United
 States and local country laws governing import, export, transfer and
 use. Delivery of Cisco cryptographic products does not imply
 third-party authority to import, export, distribute or use encryption.
 Importers, exporters, distributors and users are responsible for
 compliance with U.S. and local country laws. By using this product you
 agree to comply with applicable laws and regulations. If you are unable
 to comply with U.S. and local laws, return this product immediately.
 A summary of U.S. laws governing Cisco cryptographic products may be found at:
 http://www.cisco.com/wwl/export/crypto/tool/stqrg.html
 If you require further assistance please contact us by sending email to
 export@cisco.com.
 cisco ASR1006 (RP1) processor with 1772046K/6147K bytes of memory.
 8 FastEthernet interfaces
 5 Gigabit Ethernet interfaces
 8 Serial interfaces
 8 Channelized T1 ports
 2 Packet over SONET interfaces
 2 Channelized T3 ports
 32768K bytes of non-volatile configuration memory.
 4194304K bytes of physical memory.
 921599K bytes of eUSB flash at bootflash:.
 39004543K bytes of SATA hard disk at harddisk:.
 Configuration register is 0x2102
Router# show running-config | include boot
boot-start-marker
boot system bootflash:asr1000rp1-adventerprisek9.02.01.01.122-33.XNA1.bin

```

```
boot system bootflash:asr1000rp1-adventerprisek9.02.01.00.122-33.XNA.bin
boot-end-marker
Router#
```