



Cisco ASR 1001 Router Overview and Installation

This chapter describes the Cisco ASR 1001 Router and provides procedures for installing the Cisco ASR 1001 Router on an equipment shelf or tabletop or in an equipment rack.

This chapter contains the following sections:

- [Cisco ASR 1001 Router Description, on page 1](#)
- [Installation Methods, on page 16](#)
- [General Rack Installation Guidelines, on page 17](#)
- [Guidelines for an Equipment Shelf or Tabletop Installation, on page 18](#)
- [Mounting the Cisco ASR 1001 Router on an Equipment Shelf or Tabletop Installation, on page 18](#)
- [Rack-Mounting the Cisco ASR 1001 Router, on page 20](#)
- [Attaching the Chassis Rack-Mount Brackets, on page 21](#)
- [Installing the Cisco ASR 1001 Router in a Rack, on page 23](#)
- [Attaching the Cable-Management Bracket, on page 27](#)
- [Attaching a Chassis Ground Connection, on page 28](#)
- [Connecting the Shared Port Adapter Cables, on page 31](#)
- [Connecting the Console and Auxiliary Port Cables, on page 31](#)
- [Connecting a Terminal to the Cisco ASR1000-RP1 Console Port, on page 33](#)
- [Connecting Cables, on page 34](#)
- [Overview of AC and DC Power Supplies for the Cisco ASR 1001 Router, on page 34](#)
- [Cisco ASR 1001 Router Power Supply Installation, on page 35](#)

Cisco ASR 1001 Router Description

The Cisco ASR 1001 Router is part of the Cisco aggregation services family of routers. The Cisco ASR 1001 Router offers a compact form factor router that satisfies customer demands such as low power consumption and decreased usage of rack space. The Cisco ASR 1001 Router has the route processor, embedded services processor, and SIP integrated within the chassis with one half-height SPA slot.

By default, the Cisco ASR 1001 Router is shipped with 4 GB of DRAM. To implement software redundancy, a minimum of 8 GB memory must be installed on the router.

The Cisco ASR 1001 Router supports:

- ESP bandwidth 2.5 Gbps (default) to 5 Gbps of forwarding performance (optional software option)
- ESP memory: 1-GB DRAM default; 1-GB DRAM maximum

- Route-processor memory comes with 4-GB DRAM (default); 8-GB DRAM maximum
- 4-Gigabit Ethernet small form-factor pluggable (SFP) ports

For information about the SFP transceiver modules that are compatible with Cisco ASR 1002 Built-in Gigabit Ethernet Ports (4x1GE), refer to the “Modular Optics Compatibility” section in [Cisco ASR 1000 Series Aggregation Services Routers SIP and SPA Hardware Installation Guide](#).

- External USB flash memory 1-GB USB flash memory support

Cisco ASR 1001 Router Architecture

The Cisco ASR 1001 Router provides all the Cisco ASR 1000 Series Router features, services, and performance in a small form-factor chassis. The chassis contains a single integrated mainboard that implements all functions of the route processor (RP), a SPA embedded processor (SIP), a forwarding processor (ESP) and a built-in 4x1 GE SPA.

The SPA interface is connected to a built-in 4xGE SPA, a single half-height (HH) SPA bay, and one flexible integrated daughter card (IDC), providing additional SPA interfaces.

Cisco ASR 1001 Router hardware features include:

- Front-to-back air flow, with 7 built-in cooling fans, numbered from left to right, zero (0) to 6.
- Supports 1 + 1 redundant AC or DC power supplies.
- A cover interlock prevents cover removal with power supplies installed.
- Provides one half-height SPA bay (Bay 1 online insertion and removal (OIR) supported) and integrates a passive board, which consists of a standard SPA interface connector and an interface connector, to the mainboard.
- Support for one factory-configurable integrated daughter card in SPA Bay 2. The integrated daughter card, in SPA Bay 2 is part of the base configuration, and is not an option.
- Provides unique front panels for each integrated daughter card configuration.
- 8 GB internal flash
- Console and Auxiliary RJ-45 ports
- 4 GB DRAM (default)
- Forwarding Performance = 2.5G default, 5G with software license

The Cisco ASR 1001 Router can accommodate different integrated daughter cards. The chassis top cover includes the integrated daughter card front panel with a common base chassis. There will be different top covers for each integrated daughter cards and one for orders with no integrated daughter card.

The Cisco ASR 10001 Router can be shipped with different orderable configurations. The following IDC configurations are available:



Note See the *MIBs for the Cisco ASR 1001 Router* appendix for information about the MIBs that can be used to manage these IDCs.

- IDC-HD80G

IDC-HD80G can support a single 2.5-inch SATA HDD/SSD (see the following image).

Figure 1: Cisco ASR 1001 Router with IDC-HD80G

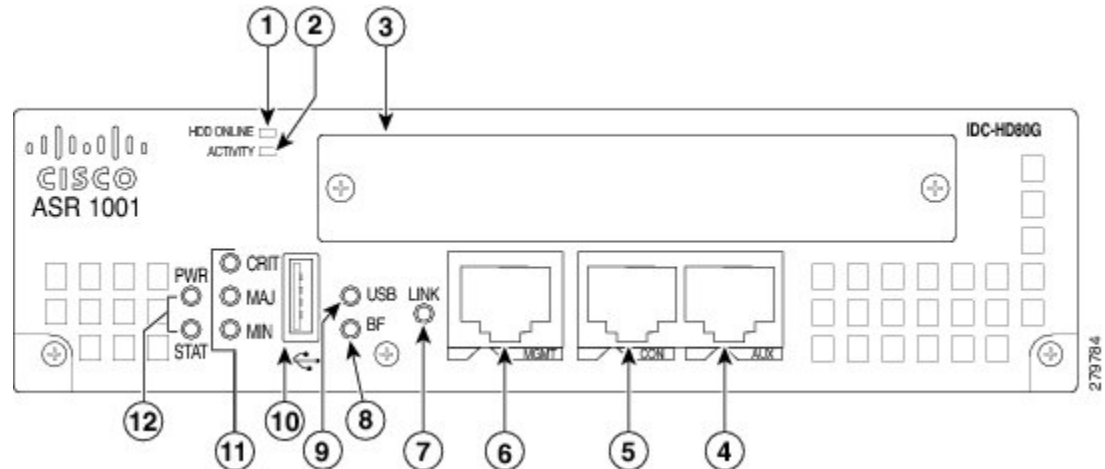

1	HDD Online—LED indicates that the disk is ready and can be accessed	7	LINK LED—Indicates MGMT Ethernet port activity
2	HDD Activity—LED indicates that the disk is currently being accessed	8	BF—Internal bootflash LED that indicates activity of the EUSB device
3	HDD Slot—Slot into which the HDD is inserted (the figure shows an HDD inserted into the slot)	9	USB LED
4	AUX—RS-232 auxiliary port	10	USB port—USB high-speed (480 Mbps) port used for secure key storage, VPN credentials storage, or bulk flash storage of image and configuration backup This USB port is an A port.
5	CON—RS-232 console port	11	STAT—Status LED
6	MGMT—RJ-45 10/100/1000 management Ethernet port	12	PWR—Power LED

- IDC-OC3POS

IDC-OC3POS can support two channels of OC3 (see the following image).

Figure 2: Cisco ASR 1001 Router with IDC-OC3POS

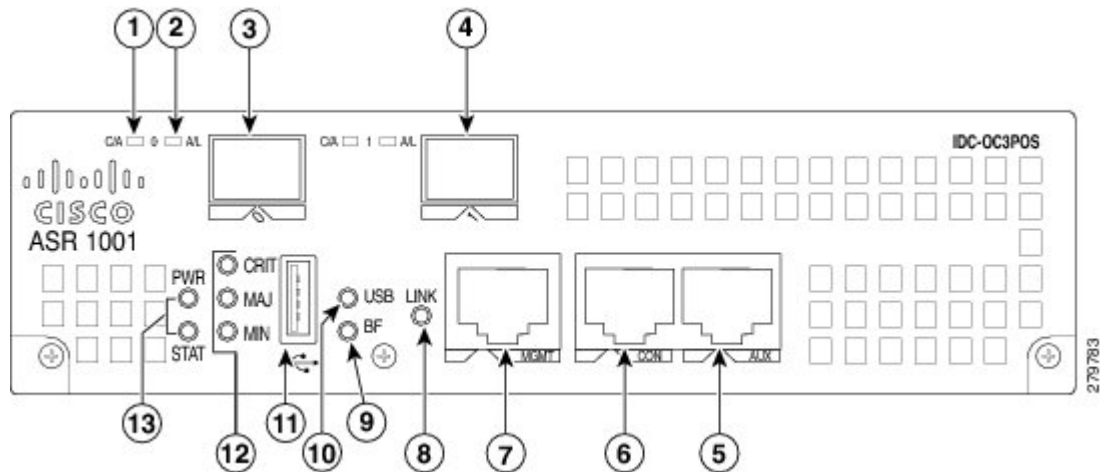

1	C/A—Carrier/Alarm LED	8	LINK LED—Indicates MGMT Ethernet port activity
2	A/L—Active/Loopback LED	9	BF—Internal bootflash LED that indicates activity of the EUSB device
3	POS OC3—Port 0 This POS port is a small form-factor pluggable (SFP) port.	10	USB LED
4	POS OC3—Port 1 This POS port is an SFP port.	11	USB port—USB high-speed (480 Mbps) port used for secure key storage, VPN credentials storage, or bulk flash storage of image and configuration backup This USB port is an A port.
5	AUX—RS-232 auxiliary port	12	STAT—Status LED
6	CON—RS-232 console port	13	PWR—Power LED
7	MGMT—RJ-45 10/100/1000 management Ethernet port		

- IDC-4XGE

IDC-4XGE can support up to four small form-factor pluggable (SFP) transceivers, each of which supports a 1-Gigabit Ethernet connection (see the following image).

Figure 3: Cisco ASR 1001 Router with IDC-4XGE

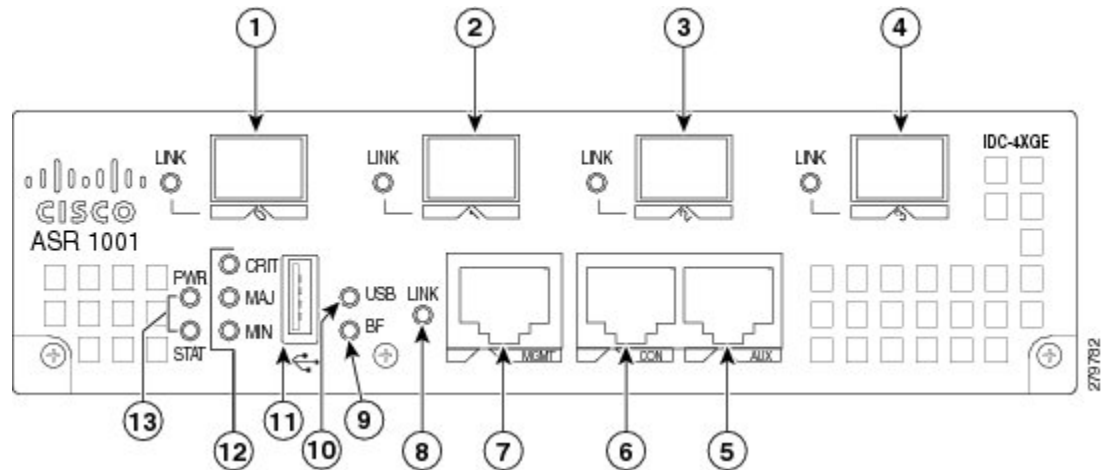

1 GigabitEthernet—Port 0 This POS port is an SFP port.	8 LINK LED—Indicates MGMT Ethernet port activity
2 GigabitEthernet—Port 1 This POS port is an SFP port.	9 BF—Internal bootflash LED that indicates activity of the EUSB device
3 GigabitEthernet—Port 2 This POS port is an SFP port.	10 USB LED
4 GigabitEthernet—Port 3 This POS port is an SFP port.	11 USB port—USB high-speed (480 Mbps) port used for secure key storage, VPN credentials storage, or bulk flash storage of image and configuration backup This USB port is an A port.
5 AUX—RS-232 auxiliary port	12 STAT—Status LED
6 CON—RS-232 console port	13 PWR—Power LED
7 MGMT—RJ-45 10/100/1000 management Ethernet port	—

- IDC-CHT1/E1

IDC-CHT1/E1 can support eight ports of fully channelized T1 or E1 interfaces (see [Figure 4: Cisco ASR 1001 Router with IDC-CHT1/E1, on page 6](#)).

Figure 4: Cisco ASR 1001 Router with IDC-CHT1/E1

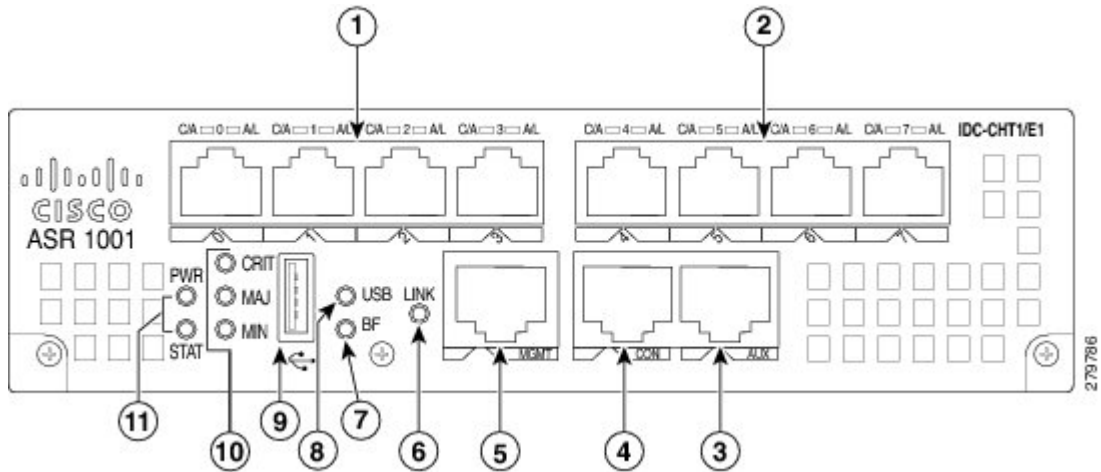

1	T1/E1 Ports—Ports 0 through 3 These T1/E1 ports are RJ-45 ports.	7	BF—Internal bootflash LED that indicates activity of the EUSB device
2	T1/E1 Ports—Ports 4 through 7 These T1/E1 ports are RJ-45 ports.	8	USB LED
3	AUX—RS-232 auxiliary port	9	USB port—USB high-speed (480 Mbps) port used for secure key storage, VPN credentials storage, or bulk flash storage of image and configuration backup This USB port is an A port.
4	CON—RS-232 console port	10	STAT—Status LED
5	MGMT—RJ-45 10/100/1000 management Ethernet port	11	PWR—Power LED
6	LINK LED—Indicates MGMT Ethernet port activity	—	—

- IDC-4XT3

IDC-4XT3 can support up to four unchannelized DS3 (44.736 Mbps) ports (see the following image).

Figure 5: Cisco ASR 1001 Router with IDC-4XT3

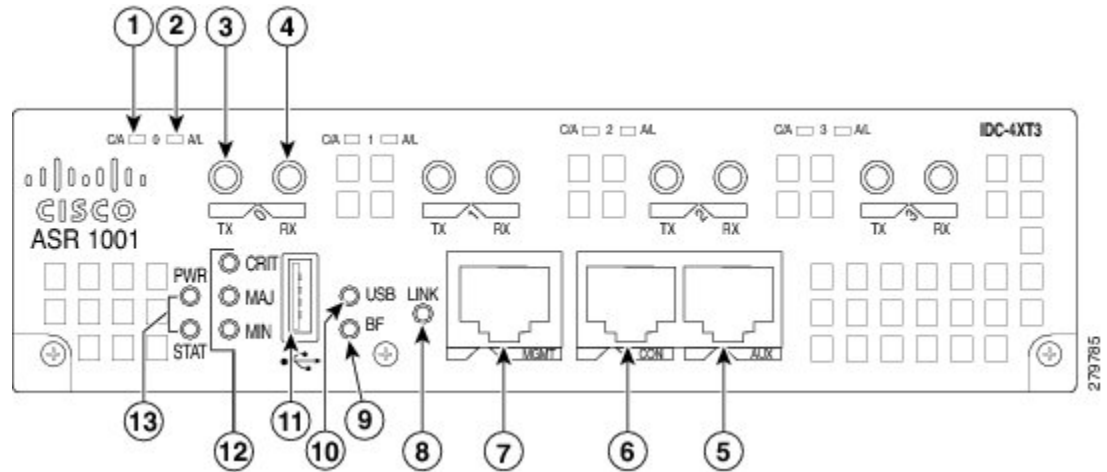

1	C/A—Carrier/Alarm LED	8	LINK LED—Indicates MGMT Ethernet port activity
2	A/L—Active/Loopback LED	9	BF—Internal bootflash LED that indicates activity of the EUSB device
3	T3 TX Port—Transmit port 0 This T3 port uses a 1.0/2.3 RF connector with 75-ohm impedance.	D	USB LED
4	T3 RX Port—Receive port 0 This T3 port uses a 1.0/2.3 RF connector with 75-ohm impedance.	11	USB port—USB high-speed (480 Mbps) port used for secure key storage, VPN credentials storage, or bulk flash storage of image and configuration backup This USB port is an A port.
5	AUX—RS-232 auxiliary port	12	STAT—Status LED
6	CON—RS-232 console port	B	PWR—Power LED
7	MGMT—RJ-45 10/100/1000 management Ethernet port	—	—

The following figures show the front panel of the Cisco ASR 1001 Router with the various IDCs. The following image shows the LEDs that are common to all configurations of the Cisco ASR 1001 Router.

Figure 6: Common LEDs for Cisco ASR 1001 Route Processor

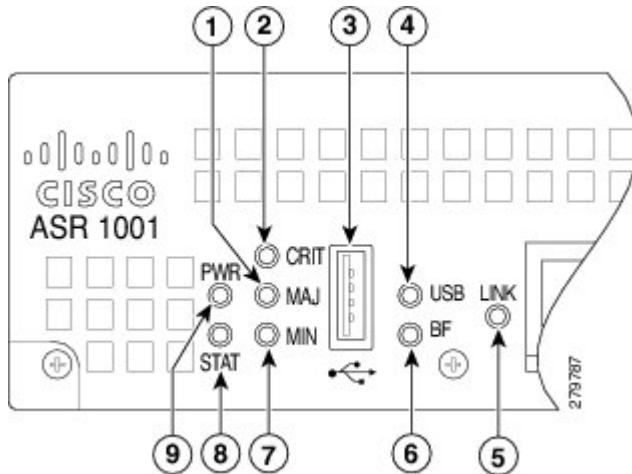

1	MAJ LED—major alarm indicator	6	BF—Internal bootflash LED indicates activity of the EUSB device
2	CRIT LED—critical alarm indicator	7	MIN LED —minor alarm indicator
3	USB port— one USB high-speed (480Mbps) port used for secure key storage, storing of VPN credentials, or bulk flash storage for image and configuration backup	8	STAT—status LED
4	USB LED	9	PWR—Power LED
5	LINK LED indicates MGMT Ethernet port activity	—	—



Note For detailed descriptions of the SPAs on which some of the IDCs are based, go to: http://www.cisco.com/en/US/products/ps6267/products_data_sheets_list.html



Note There are two field-replaceable units in the Cisco ASR 1001 chassis. They are the DIMMs and eUSB. In order to service the components in the chassis, you must remove the power supplies and the chassis cover. For instructions, see the “Removing and Replacing the Cisco ASR 1001 Router DIMM Memory Modules” and the “Remove and Replace the eUSB Device on the Cisco ASR 1001 Router” sections in the *Removing and Replacing FRUs from the Cisco ASR 1000 Series Routers* chapter.

Cisco ASR 1001 Router Faceplate Common Components

The Cisco ASR 1001 Router RP faceplate has common components for each type of ASR 1001 Router configuration. The preceding image and the following image show the Cisco ASR1000-RP faceplate with LEDs and connectors for all configurations of the Cisco ASR 1001 Router.

Figure 7: Common Connectors for Cisco ASR 1001 Route Processor

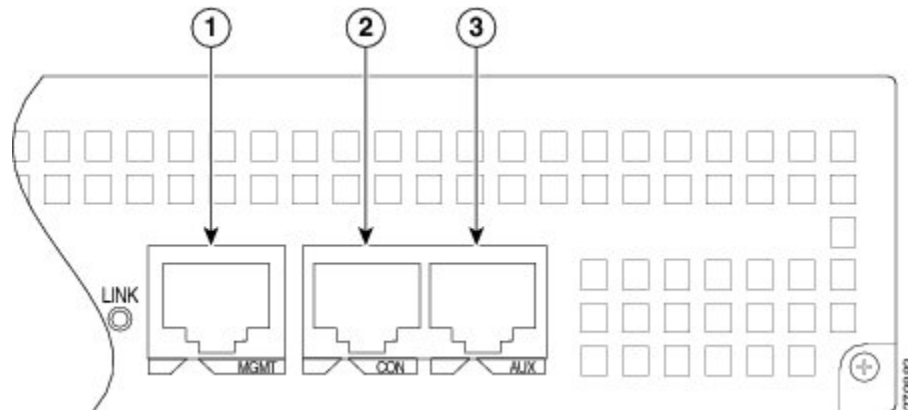

1	MGMT—One RJ-45 10/100/1000 management Ethernet port	3	AUX—One RS-232 auxiliary port
2	CON—One RS-232 console port		

Cisco ASR 1001 Chassis Front View

The following image shows the front of the Cisco ASR 1001 Router.

Figure 8: Cisco ASR 1001 Router Front View

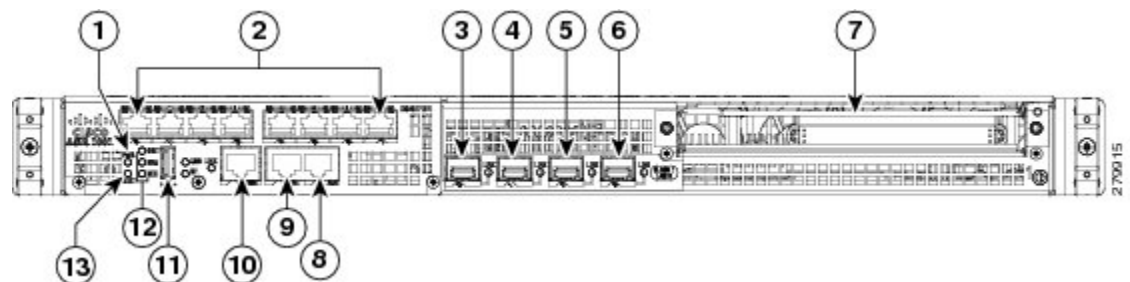

1	PWR—Power LED	8	AUX—one RS-232 auxiliary port
2	Integrated daughter card I/O space	9	CON—one RS-232 console port
3	GE 2/0 and 0/0—The built-in GE ports use industry standard front-panel removable SFP optics and SFP copper interfaces.	10	MGMT —one RJ-45 10/100/1000 management Ethernet port
4	GE 2/1 and 0/1	11	USB port
5	GE 2/2 and 0/2	12	CRIT LED—critical alarm indicator MAJ LED—major alarm indicator MIN LED —minor alarm indicator
6	GE 2/3 and 0/3	13	STAT—status LED

7	One half-height SPA Bay 1	Bottom slot of chassis is Bay 0
---	---------------------------	---------------------------------

Cisco ASR 1001 Chassis Rear View

The following image shows the rear of the Cisco ASR 1001 Router with seven fans and two AC or DC power supplies.

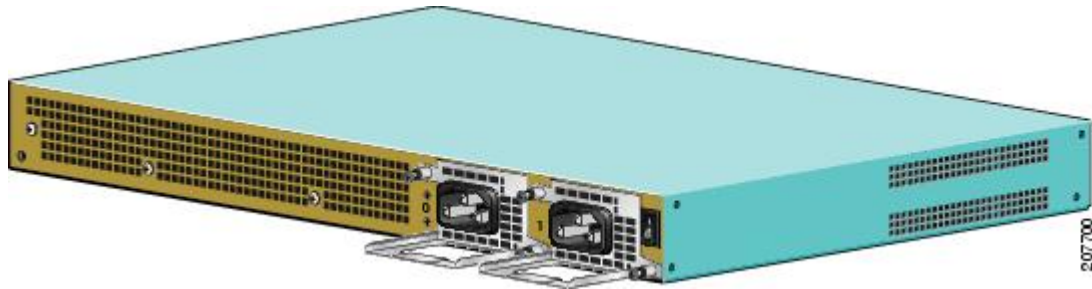

Seven internal fans draw cooling air into the chassis and across internal components to maintain an acceptable operating temperature. The fans are located at the rear of the chassis. A two-hole grounding lug is located on the side of the chassis. Each individual fan also has a fan fail status signal. The fan fail signal is asserted if the fan speed falls below 50% of the rated speed. The fans are numbered from zero (0) to 6, left to right.

Two power supplies, either two AC power supplies or two DC power supplies are accessed from the rear of the router.

Cisco ASR 1001 Router Slot Numbering

The SPA bay numbering scheme for Cisco ASR 1001 Router is different from the Cisco ASR 1000 SIP card. The SPA ordering is: Built-in GE ports (SPA 0), SPA Bay 1 (SPA 1), and I/O Board (SPA 2).

The integrated daughter card is not necessarily a SPA; it could be any I/O, such as a harddrive or USB. When the daughter card is not a SPA, then SPA Bay 2 will be left blank and not present in the system.

The built-in GE ports are logically SPA bay 0 and will be addressed as GE 0/0/x. The half-height SPA slot is logically SPA bay 1 and ports will be addressed as 0/1/x. Ports on the integrated daughter card are logically in SPA bay 2 and will be addressed as 0/2/x.

The following image shows slot numbering for the Cisco ASR 1001 Router.

Figure 9: Cisco ASR 1001 Router Slot Numbering

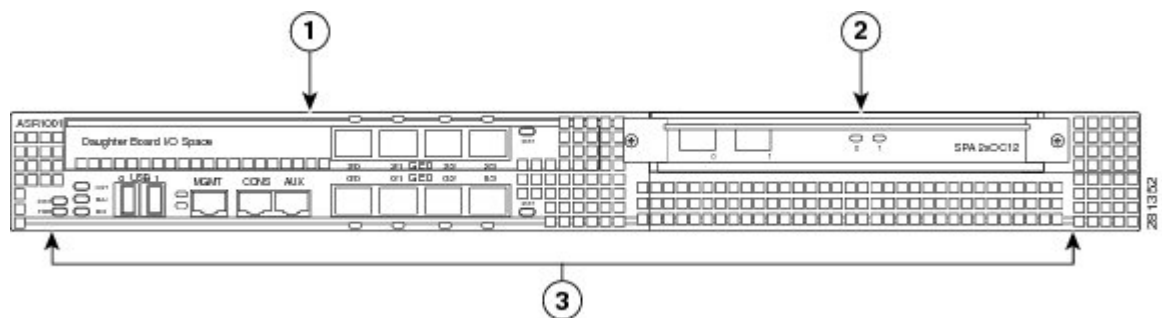

1	Slot 2 connected to the flexible integrated daughter card	3	Slot 0 connected to the built-in 4x1GE SPA on the mainboard
2	Slot 1 connected to the half-height SPA slot	—	—

Cisco ASR 1001 Router Components

The Cisco ASR 1001 Router system is derived from the architecture of the other Cisco ASR 1000 Series routers. The Cisco ASR 1001 Router contains a single mainboard that provides all the functions of a Cisco ASR1000-RP (route processor), a Cisco ASR1000-SIP (carrier card), and a Cisco ASR1000-ESP (forwarding processor). This mainboard assembly also contains a built-in 4x1 GE SPA providing four SFP ports. The Cisco ASR1000-RP section of the mainboard provides all the traditional management interfaces (Ethernet, Console, Aux) and a storage interface (USB only). The Cisco ASR1000-SIP section provides one half-height SPA bay and supports a flexible integrated daughter card. The Cisco ASR1000-ESP section provides a CPP based forwarding engine including a security coprocessor.

The main components of the Cisco ASR 1001 Router, ASR1000-RP1, ASR1000-ESP5, and ASR1000-SIP10 are fixed in the chassis and are not upgradeable, except for the power supplies and SPAs.

Cisco Embedded ASR1000-RP1 for Cisco ASR 1001 Router Description

The Cisco ASR 1000 Series route processor (embedded for the Cisco ASR 1001 Router) is the central control processor and runs the network operating system.

The Cisco embedded ASR1000-RP1 supports management interfaces such as the Ethernet network management port and console and auxiliary serial ports. It has LED status indicators and one USB port that can be used with smart cards for either secure key distribution or image or configuration file updates.

The Cisco embedded ASR1000-RP1 deviates from the other ASR Series Route Processor 1 for the Cisco ASR 1006 router and the Cisco ASR 1004 Router in the following ways:

- Bulk file storage is on a large eUSB device (to 8 GB supported) with no SATA hard-drive supported.
- Redundant Cisco route processor is not supported.
- Network clock changes. No second BITS clock input supported.
- A built-in 4xGE SPA is included. This shared port adapter provides four SFP-based GE connections.

The Cisco route processor common LEDs and indicators are shown in the “Common LEDs for Cisco ASR 1001 Route Processor” figure in the *Cisco ASR 1001 Router Architecture* section. The following table describes the Cisco ASR 1000 Series Route Processor LEDs.

Table 1: Cisco ASR 1001 Series Route Processor LEDs

LED Label	LED	Color—State	Behavior Description
PWR	Power	Solid green	All power requirements are within specification
		Off	Off. The router is in standby mode.

LED Label	LED	Color—State	Behavior Description
STAT	System status	Solid green	Cisco IOSD and other required processes have loaded successfully and are operating.
		Yellow	ROMMON is running (including a permanent failure of RP software) or the Process Manager has declared a critical RP process (including IOSD) dead. A user can log in to recover.
		Red	Occurs during system failure or power-up.
CRIT	Critical	Solid Red	Functions as a critical alarm indicator. The LED is also a solid red during the boot process.
MAJ	Major	Solid Red	Major alarm indicator.
MIN	Minor	Amber	Minor alarm indicator.
BOOT	Internal eUSB bootflash LED	Green	Activity indicator.
LINK	10/100/1000 Interface LED	Solid green	Link with no activity.
		Flashing Green	MGMT Ethernet port activity.
		Off	No link.

Cisco Embedded ASR1000-SIP10 and SPAs for the Cisco ASR 1001 Router Description

The Cisco embedded ASR1000-SIP10 is built into the Cisco ASR 1001 Router. The Cisco embedded ASR1000-SIP10 provides the physical and electrical termination for up to three SPAs, built-in 4xGE SPA, one half-height SPA bay, and one integrated daughter card (system configurable).

The Cisco embedded ASR1000-SIP10 interface, like the Cisco ASR 1006 Router and Cisco ASR 1004 Router, supports all Cisco embedded ASR1000-SIP10 functions and services. However, the Cisco embedded ASR1000-SIP10 differs in the following areas:

- Functions as the base board for Cisco embedded ASR1000-RP1
- Is not a field-replaceable unit (FRU) and does not support online insertion and removal (OIR).



Note Only the shared port adapter (SPA) on the Cisco embedded ASR1000-SIP10 in SPA Bay 1 of the Cisco ASR 1001 Router supports OIR.

The Cisco ASR 1001 Router embedded ASR1000-RP1 also provides the circuitry for the built-in 4xGE SPA. [Table 2: Built-In SPA LEDs](#), on page 13 describes the built-in SPA LEDs.

Table 2: Built-In SPA LEDs

Function	Color	Description
GE SFP STATUS (one per port)	Amber	Indicates that the port is enabled by software, but there is a problem with the Ethernet link.
	Green	Indicates that the port is enabled by software and there is a valid Ethernet link.

Cisco ASR 1001 Router Integrated Daughter Card Description

The ASR 1001 Router supports different flexible integrated daughter cards with their own LEDs. Four of these integrated daughter cards are based on SPAs and use the same external I/O ports as those SPAs. One of the integrated daughter cards supports a single hard-disk-drive for other applications.

Table 3: Built-In SPA LEDs, on page 13 describes the built-in SPA LEDs.

Table 3: Built-In SPA LEDs

Function	Color	Description
Daughter Card Port Status (one per port)	Amber	Amber indicates the port is enabled by software, but there is a problem with a port connection.
	Green	Green indicates the port is enabled by software and operational.

Cisco ASR1000-ESP for the Cisco ASR 1001 Router Description

The Cisco ASR 1001 Router supports the Cisco ASR1000-ESP2.5 and Cisco ASR1000-ESP5 (with license) embedded services processors.

Table 4: Cisco ASR 1001 LEDs, on page 13 describes the Cisco ASR 1001 LEDs.

Table 4: Cisco ASR 1001 LEDs

No	LED Label	LED	Color	Behavior Description
1	PWR	Power	Solid green	All power supplies are within operational limits.
			Off	Off. The router is in standby mode.
2	ACTV	Active	Green	The embedded services processor is green when active.
3	STAT	STATUS	Green	Code has downloaded successfully and is operational.
			Yellow	BOOT ROM has loaded successfully.
			Red	Not booted.
4	STBY	Standby	None	Will always be off.

You can upgrade the throughput of the ESP from 2.5 Gbps to 5 Gbps by applying a software-activated performance upgrade license and then reloading the router. If you want to determine the current throughput level of the ESP, run the **show platform hardware throughput level** command. The following example shows the output of this command before the performance upgrade license is applied:

```
Router# show platform hardware throughput level
The current throughput level is 2500000 kb/s
```

The following example shows the output of this command after the performance upgrade license is applied:

```
Router# show platform hardware throughput level
The current throughput level is 5000000 kb/s
```

For more information about the software-activated performance upgrade license, see the *Cisco ASR 1000 Series Aggregation Services Routers Release Notes* at the following location:

http://www.cisco.com/en/US/docs/routers/asr1000/release/notes/asr1k_rm_rel_notes.html

Power Supplies in the Cisco ASR 1001 Router

The Cisco ASR 1001 Router power supply module supports the following Cisco power supplies:

- AC power supply operates between 85 to 264 VAC
- –48 VDC power supply input range supported is –40.5 to –72 VDC.

The power supply generates +12 V and +5 V, which is distributed to the mainboard and fans. The +5 V is used to operate the power control devices. It also provides an operational +5 V, as needed.

The power supply units contain one or two fans that are only used for cooling the power supply. Each power supply is self contained and controls its own fan speed and fan redundancy.

The power supplies are hot pluggable from the rear of the chassis and can be removed or installed while the system is operating, without affecting any aspect of system performance. The Cisco ASR 1001 Router supports up to seven chassis-mounted cooling fans. Each fan provides an alarm output for error indication speed measurement. The fans are not field replaceable, but the system can meet the cooling requirements in the event of a single-fan failure.

AC Power Supply for Cisco ASR 1001 Router

The AC power supply input inlet is an IEC connector. The current rating on the connector is 10 A. The AC power supply is secured into the chassis with two captive screws mounted on the faceplate.

The following image shows the AC power supply for the Cisco ASR 1001 Router.

Figure 10: AC Power Supply for the Cisco ASR 1001 Router

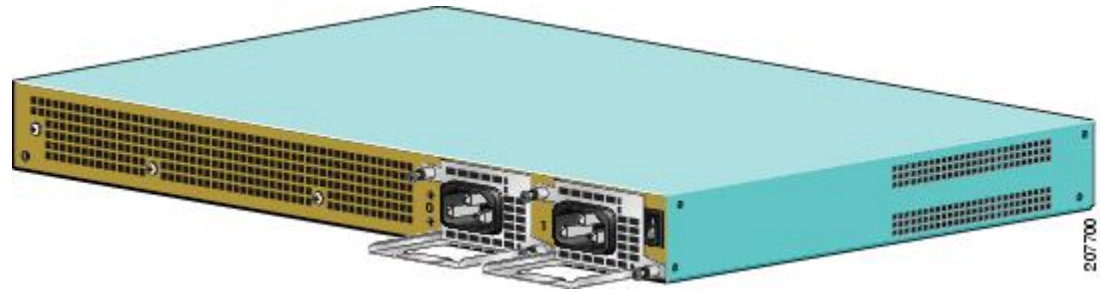

--48 VDC Power Supply for Cisco ASR 1001 Router

The –48 VDC power supply input connector accepts a Euro-style terminal block. It is compliant with safety agencies' guidelines and electrical requirements of the supply. The DC power supply operates within specification from –40.5 to –72 VDC continuously once the power supply DC input reaches the threshold of –43.5 V.

The –48 VDC power input connector Euro-style terminal block will accept three wires: one positive polarity, one negative polarity, and one ground wire. The connection order is negative (–), positive (+), and GND. The DC power supply is secured into the system chassis with two captive screws mounted on the faceplate.

The following image shows the –48 VDC power supplies for the Cisco ASR 1001 Router.

Figure 11: –48 VDC Power Supply for the Cisco ASR 1001 Router

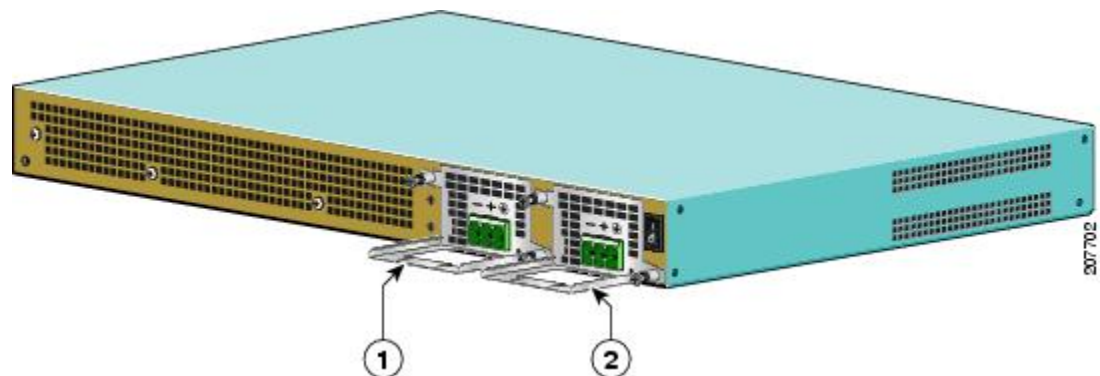

The output voltage alarm is declared when the output voltage is below the low end of the minimum or above the high end of the maximum limits. When the output voltage is above the high end of the minimum or below the low end of the maximum limits, the red state will not be activated.

The following table shows the –48 VDC power supply output voltage alarm ranges.

Table 5: –48 VDC Power Supply Output Voltage Alarm Threshold Ranges

Output	Minimum	Maximum
12V	10.0-11.2V	12.8-13.8V
3.3V	2.6 - 3.0 V	None

Power Cords Supported by the Cisco ASR 1001 Router

The following table lists the power cords that are supported by the Cisco ASR 1001 Router.

Table 6: Power Cords Supported by the Cisco ASR 1001 Router

Power Cord Item Number	Description
15454-M-ACCBL-R2	AC Power Cable ANSI 220VAC Right Exit
CAB-AC-RA	Power Cord, 110 V, Right Angle
CAB-ACA-RA	Plug, Power Cord, Australian, 10 A, Right Angle
CAB-ACC-RA	Power Cord China, Right Angle
CAB-ACE-RA	Power Cord Europe, Right Angle
CAB-ACI-RA	Power Cord, Italian, Right Angle
CAB-ACR-RA	Power Cord Argentina, Right Angle
CAB-ACS-RA	Power Cord, Switzerland, Right Angle
CAB-ACU-RA	Power Cord UK, Right Angle
CAB-IND-RA	Power Cord India, Right Angle
CAB-JPN-RA	Power Cord-Japan, Right Angle

Installation Methods

Cisco ASR 1001 Router is designed for standalone, two rail 19-inch rack-mount (front rail only), four rail 19-inch rack-mount (front and rear rail).

Although rack-mounting is the preferred method of installation for the Cisco ASR 1001 Router, you can mount the chassis on an equipment shelf or tabletop.



Warning This warning symbol means danger. You are in a situation that could cause bodily injury. Before you work on any equipment, be aware of the hazards involved with electrical circuitry and be familiar with standard practices for preventing accidents. Use the statement number provided at the end of each warning to locate its translation in the translated safety warnings that accompanied this device. Statement 1071



Warning Before you install, operate, or service the system, read the *Regulatory Compliance and Safety Information for Cisco ASR 1000 Series Aggregation Services Routers* publication. This document provides important safety information you should know before working with the system. Statement 200



Note You have already unpacked your chassis and read all the site requirements for your new equipment. Proceed with the installation.

General Rack Installation Guidelines

When planning your rack installation, consider the following guidelines:

- The Cisco ASR 1001 Router requires a minimum of 3.5 inches or 8.9 cm rack units of vertical rack space. Measure the proposed rack location before mounting the chassis in the rack.
- Before using a particular rack, check for obstructions (such as a power strip) that could impair rack-mount installation. If a power strip does impair a rack-mount installation, remove the power strip before installing the chassis, and then replace it after the chassis is installed.
- Allow sufficient clearance around the rack for maintenance. If the rack is mobile, you can push it back near a wall or cabinet for normal operation and pull it out for maintenance (installing or moving cards, connecting cables, or replacing or upgrading components). Otherwise, allow 19 inches (48.3 cm) of clearance to remove field-replaceable units.
- Maintain a minimum clearance of 3 inches on the front and back sides of the chassis for the cooling air inlet and exhaust ports, respectively. Avoid placing the chassis in an overly congested rack or directly next to another equipment rack; otherwise, the heated exhaust air from other equipment can enter the inlet air vents and cause an overtemperature condition inside the router.



Caution To prevent chassis overheating, never install a Cisco ASR 1001 Router in an enclosed room that is not properly ventilated or air conditioned.

- Always install heavier equipment in the lower half of a rack to maintain a low center of gravity to prevent the rack from falling over.
- Install and use the cable-management brackets included with the Cisco ASR 1001 Router to keep cables organized and out of the way of the cards and processors. Ensure that cables from other equipment already installed in the rack do not impair access to the cards or require you to disconnect cables unnecessarily to perform equipment maintenance or upgrades.
- Install rack stabilizers (if available) before you mount the chassis.
- Provide an adequate chassis ground (earth) connection for your router chassis.

In addition to the preceding guidelines, review the precautions for avoiding excessive temperature conditions in the “Site Environmental Requirements” section in the *Preparing Your Site for Installation* chapter.

The following table provides the Cisco ASR 1001 Router dimensions and weight information.

Table 7: Cisco ASR 1001 Router Dimensions and Weight

Cisco ASR 1001	Dimensions
Depth	22.50 in. (57.15 cm)

Cisco ASR 1001	Dimensions
Height	1.71 in. (43.43 mm) - 1RU rack-mount
Width	17.25 in. (43.815 cm) - 19 inch rack-mount
Weight	40 lb (18.143 k) - fully configured

Guidelines for an Equipment Shelf or Tabletop Installation

The chassis should already be in the area where you will install it. If you have not determined where to install your chassis, see the *Cisco ASR 1000 Series Routers Component Overview* chapter for information about site considerations.

If you are not rack-mounting your Cisco ASR 1000 series chassis, place it on a sturdy equipment shelf or tabletop.

When installing the Cisco ASR 1001 Router on an equipment shelf or tabletop, ensure that the surface is clean and that you have considered the following:

- The Cisco ASR 1001 Router requires at least 3 inches (7.62 cm) of clearance at the inlet and exhaust vents (the front and top/rear sides of the chassis).
- The Cisco ASR 1001 Router should be installed off the floor. Dust that accumulates on the floor is drawn into the interior of the router by the cooling fans. Excessive dust inside the router can cause overtemperature conditions and component failures.
- There must be approximately 19 inches (48.3 cm) of clearance at the front and rear of the chassis to install and replace FRUs, or to access network cables and equipment.
- The Cisco ASR 1001 Router needs adequate ventilation. Do not install it in an enclosed cabinet where ventilation is inadequate.
- Keep the cable-management bracket ready if you plan to install it on the front of the chassis.
- An adequate chassis ground (earth) connection exists for your router chassis (see the [Attaching a Chassis Ground Connection](#)).
- Always follow proper lifting practices as outlined in the “Electrical Safety” section in the *Preparing Your Site for Installation* chapter, when handling the chassis.

Mounting the Cisco ASR 1001 Router on an Equipment Shelf or Tabletop Installation

To mount your Cisco ASR 1001 Router on an equipment shelf or tabletop, follow these steps.

SUMMARY STEPS

1. Remove any debris and dust from the tabletop or platform, as well as the surrounding area.
2. Lift the chassis into position on the equipment shelf or tabletop.

3. Attach the front rack-mount brackets. Locate the threaded holes in the front sides of the chassis (first holes beyond the vent holes) and use the package of black screws that shipped with the chassis.
4. Align the front rack-mount bracket to one side of the chassis.
5. Insert and tighten the screws on one side.
6. Repeat Step 2 through Step 3 on the other side of the chassis. Use all screws to secure the rack-mount brackets to the chassis.
7. Gather the two cable-management brackets and screws shipped with your chassis. The following image shows cable-management brackets attached on the front of the Cisco ASR 1001 Router.
8. Screw the cable-management bracket to each side of the rack-mount brackets that are attached to the chassis. Use two screws for each cable-management bracket. Use a screw from the package of four screws.
9. Check that all screws are securely tightened.
10. Go to the [Attaching a Chassis Ground Connection](#) for instructions about continuing the installation.

DETAILED STEPS

Step 1 Remove any debris and dust from the tabletop or platform, as well as the surrounding area.

Step 2 Lift the chassis into position on the equipment shelf or tabletop.

Warning At least two people are required to lift the chassis onto a tabletop or platform. To prevent injury, keep your back straight and lift with your legs, not your back. Statement 164

Step 3 Attach the front rack-mount brackets. Locate the threaded holes in the front sides of the chassis (first holes beyond the vent holes) and use the package of black screws that shipped with the chassis.

Step 4 Align the front rack-mount bracket to one side of the chassis.

Step 5 Insert and tighten the screws on one side.

Step 6 Repeat Step 2 through Step 3 on the other side of the chassis. Use all screws to secure the rack-mount brackets to the chassis.

Note The chassis rack-mount brackets must be installed first so that you can attach the cable-management brackets to the chassis rack-mount brackets after the chassis is installed in the rack.

Step 7 Gather the two cable-management brackets and screws shipped with your chassis. The following image shows cable-management brackets attached on the front of the Cisco ASR 1001 Router.

Note Make certain that the cable-management ‘U’ feature device has the open end pointing upwards when you attach it to the chassis.

Figure 12: Attaching the Cable-Management Brackets to the Cisco ASR 1001 Router

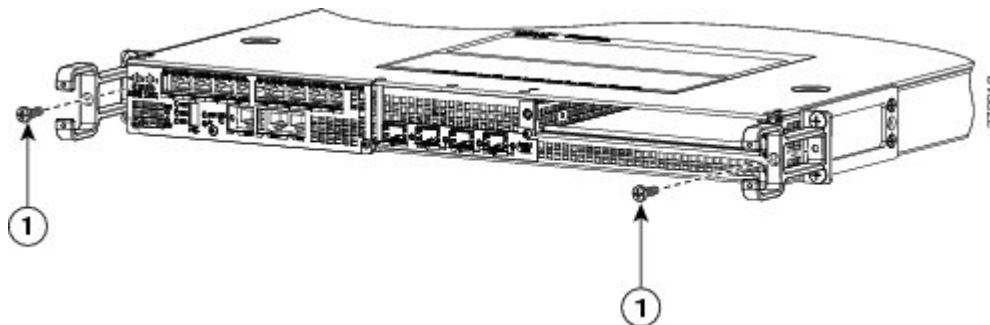

1	Cable-management bracket top and bottom screws	3	Chassis front rack-mount bracket
2	Cable-management bracket	—	—

- Step 8** Screw the cable-management bracket to each side of the rack-mount brackets that are attached to the chassis. Use two screws for each cable-management bracket. Use a screw from the package of four screws.
- Step 9** Check that all screws are securely tightened.
- Step 10** Go to the [Attaching a Chassis Ground Connection](#) for instructions about continuing the installation.

Rack-Mounting the Cisco ASR 1001 Router

The Cisco ASR 1001 Router can be installed in an existing rack with equipment or in an empty rack with no equipment: The chassis can be mounted in either rack types:

- Two-post rack, either 19 inch or 23 inch. Inner clearance (the width between the inner sides of the two posts or rails) must be at least 19 inches (48.26 cm). The height of the chassis is 3.47 inches (8.8 cm). Airflow through the chassis is from front to back.



Note If you are using a two-post rack secure the rack to the floor surface to prevent tipping and avoid bodily.

- Four post, 19-inch equipment rack. Inner clearance (the width between the inner sides of the two posts or rails) must be at least 19 inches (48.26 cm). The height of the chassis is 1.71 inches (43.43 mm). Airflow through the chassis is from front to back.



Note When handling the chassis, always follow proper lifting practices. See the “Chassis-Lifting Guidelines” section in the *Preparing Your Site for Installation* chapter.

The Cisco ASR 1001 Router can be installed with both front or rear rack-mount brackets.

Verifying Rack Dimensions

Before you install the chassis, measure the space between the vertical mounting flanges (rails) on your equipment rack to verify that the rack conforms to the measurements shown in the following image.

Figure 13: Verifying Equipment Rack Dimensions

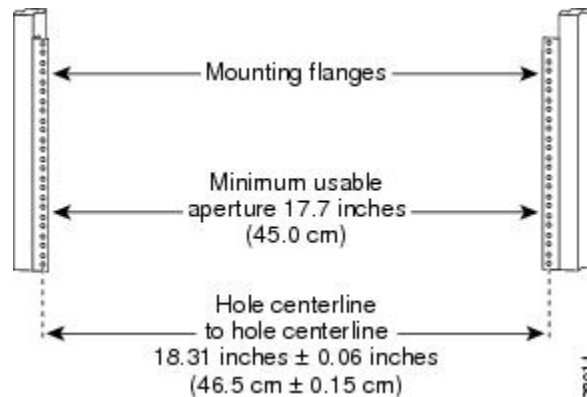

SUMMARY STEPS

1. Mark and measure the distance between two holes on the left and right mounting rails.
2. Measure the space between the inner edges of the left front and right front mounting flanges on the equipment rack.

DETAILED STEPS

Step 1 Mark and measure the distance between two holes on the left and right mounting rails.

The distance should measure 18.31 inches \pm 0.06 inches (46.5 cm \pm 0.15 cm).

Note Measure for pairs of holes near the bottom, middle and top of the equipment rack to ensure that the rack posts are parallel.

Step 2 Measure the space between the inner edges of the left front and right front mounting flanges on the equipment rack.

The space must be at least 17.7 inches (45 cm) to accommodate the chassis which is 17.25 inches (43.8 cm) wide and fits between the mounting posts on the rack.

Attaching the Chassis Rack-Mount Brackets

This section explains how to attach the front rack-mount brackets to the chassis. Before installing the chassis in the rack, you must install the rack-mount brackets on each side of the chassis.

The parts and tools required for installing the rack-mount brackets and cable-management brackets are listed in the “Tools and Equipment” section in the *Preparing Your Site for Installation* chapter.



Note The Cisco ASR 1001 Router also has a set of threaded features in the rear of the chassis to accommodate a set of rear mounting brackets, should the requirement arise.



Note The cable-management brackets are attached to the chassis after you install the chassis rack-mount brackets on the chassis and mount the chassis in the rack.

Chassis Front Rack-Mount Brackets

Determine where in the rack you want the chassis to be mounted. If you are mounting more than one chassis in the rack, then start from the bottom up or the center of the rack. [Figure 14: Attaching the Front Rack-Mount Brackets to the Cisco ASR 1001 Router, on page 22](#) shows the brackets attached to the chassis. Depending on the bracket holes you use, the chassis may protrude in the rack.

To install the front rack-mount brackets on the Cisco ASR 1001 Router, perform the following steps:

SUMMARY STEPS

1. Locate the threaded holes on the side of the chassis. Make certain that you hold the front rack-mount bracket with the ear and holes facing outward and towards the front of the chassis.
2. Position the front rack-mount bracket top hole with the chassis first top hole behind the side vent holes.
3. Insert and tighten the black screws on one side.
4. Repeat Step 1 through Step 3 on the other side of the chassis. Use black screws to secure the rack-mount brackets to the chassis.

DETAILED STEPS

Step 1 Locate the threaded holes on the side of the chassis. Make certain that you hold the front rack-mount bracket with the ear and holes facing outward and towards the front of the chassis.

The following image shows where to attach the front rack-mount brackets to the Cisco ASR 1001 Router.

Figure 14: Attaching the Front Rack-Mount Brackets to the Cisco ASR 1001 Router

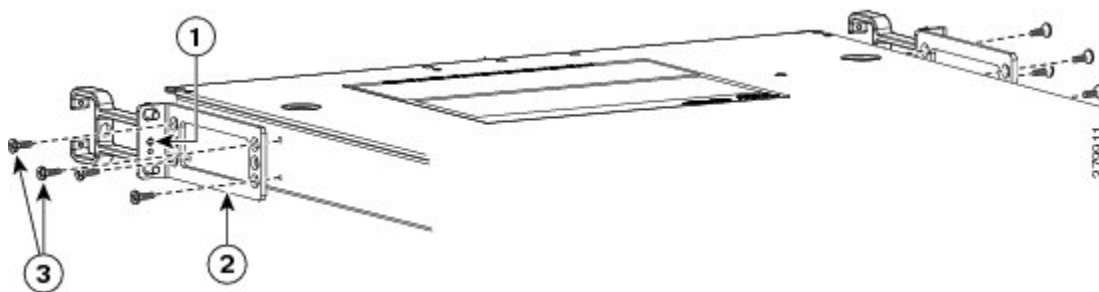

1	Front rack-mount bracket ear and holes	3	Front rack-mount bracket screws
2	Front rack-mount bracket	—	—

Step 2 Position the front rack-mount bracket top hole with the chassis first top hole behind the side vent holes.

Step 3 Insert and tighten the black screws on one side.

- Step 4** Repeat Step 1 through Step 3 on the other side of the chassis. Use black screws to secure the rack-mount brackets to the chassis.

What to do next

This completes the steps for attaching the front rack-mount brackets to the Cisco ASR 1001 Router.

Installing the Cisco ASR 1001 Router in a Rack

After installing the rack-mount brackets on the chassis, you mount the chassis by securing the rack-mount brackets to two posts or mounting strips in the rack using the screws provided. Because the rack-mount brackets support the weight of the entire chassis, be sure to use all screws to fasten the two rack-mount brackets to the rack posts.



Note To prevent bodily injury when mounting or servicing this unit in a rack, you must take special precautions to ensure that the system remains stable. The following guidelines are provided to ensure your safety:

- This unit should be mounted at the bottom of the rack if it is the only unit in the rack. When mounting this unit in a partially filled rack, load the rack from the bottom to the top with the heaviest component at the bottom of the rack.
- If the rack is provided with stabilizing devices, install the stabilizers before mounting or servicing the unit in the rack. Statement 1006

We recommend that you allow at least 1 or 2 inches (2.54 or 5.08 cm) of vertical clearance between the router and any equipment directly above and below it.

To install the chassis in the rack, perform the following steps:

SUMMARY STEPS

1. On the chassis, ensure that all screw fasteners on the installed components are securely tightened.
2. Make sure that your path to the rack is unobstructed. If the rack is on wheels, ensure that the brakes are engaged or that the rack is otherwise stabilized. See the next sections on the types of racks you can use to install the chassis.
3. (Optional) Install a shelf in the rack to support the Cisco ASR 1001 Router. If you use a shelf, this will help support the chassis while you secure it to the rack.
4. With two people, lift the chassis into position between the rack posts.
5. Align the mounting bracket holes with the rack post holes and attach the chassis to the rack.
6. Position the chassis until the rack-mounting flanges are flush against the mounting rails on the rack.
7. Hold the chassis in position against the mounting rails in the equipment rack and follow these steps:
8. Tighten all screws on each side to secure the chassis to the equipment rack.

DETAILED STEPS

-
- Step 1** On the chassis, ensure that all screw fasteners on the installed components are securely tightened.

- Step 2** Make sure that your path to the rack is unobstructed. If the rack is on wheels, ensure that the brakes are engaged or that the rack is otherwise stabilized. See the next sections on the types of racks you can use to install the chassis.
- Step 3** (Optional) Install a shelf in the rack to support the Cisco ASR 1001 Router. If you use a shelf, this will help support the chassis while you secure it to the rack.
- Step 4** With two people, lift the chassis into position between the rack posts.
- Step 5** Align the mounting bracket holes with the rack post holes and attach the chassis to the rack.
- Note** If you are using a shelf then raise the chassis to the level of the shelf. Let the bottom of the chassis rest on the brackets, but continue to support the chassis.
- Step 6** Position the chassis until the rack-mounting flanges are flush against the mounting rails on the rack.
- Tip** To allow space to attach the cable-management brackets to the chassis in the rack easily, use the rack-mount bracket ear holes mentioned in Steps 7 and 8.
- Step 7** Hold the chassis in position against the mounting rails in the equipment rack and follow these steps:
- Insert the bottom screw into the second hole up from the bottom of the rack-mount ear and use a hand-held screwdriver to tighten the screw to the rack rail.
- Tip** To make installation easier, insert one screw at the bottom of the chassis and the next screw at the top of the chassis diagonally from the first screw.
- Insert the top screw into the second hole from the top of the rack-mount ear diagonally from the bottom screw and tighten the screw to the rack rail.
 - Insert the four screws to secure the chassis to the rack equipment.
- Tip** By using the specified rack-mount bracket ear holes, the cable-management bracket can be easily attached to the rack-mount bracket when the chassis is in the rack.
- Step 8** Tighten all screws on each side to secure the chassis to the equipment rack.

Two-Post Rack Installation

The Cisco ASR 1001 Router can be installed on a two-post rack, either 19 inch or 23 inch.



Note Inner clearance (the width between the inner sides of the two posts or rails) must be at least 19 inches (48.26 cm). The height of the chassis is 1.71 inches (43.43 mm). Airflow through the chassis is from front to back.



Caution If you are using a two-post rack secure the rack to the floor surface to prevent tipping and avoid bodily injury and component damage.

SUMMARY STEPS

- Position the chassis so the front is closest to you and lift it carefully into the rack. To prevent injury, avoid any sudden twists or moves.

2. Slide the chassis into the rack, pushing it back until the brackets meet the mounting strips or posts on both sides of the rack.
3. Keeping the brackets flush against the posts or mounting strips, align the holes in the brackets with the holes on the rack or mounting strip.
4. For each bracket, insert and tighten two screws to the rack on both sides.

DETAILED STEPS

Step 1 Position the chassis so the front is closest to you and lift it carefully into the rack. To prevent injury, avoid any sudden twists or moves.

The following image shows the Cisco ASR 1001 Router on a two-post equipment rack.

Figure 15: Cisco ASR 1001 Router Installed on a Two-Post Equipment Rack

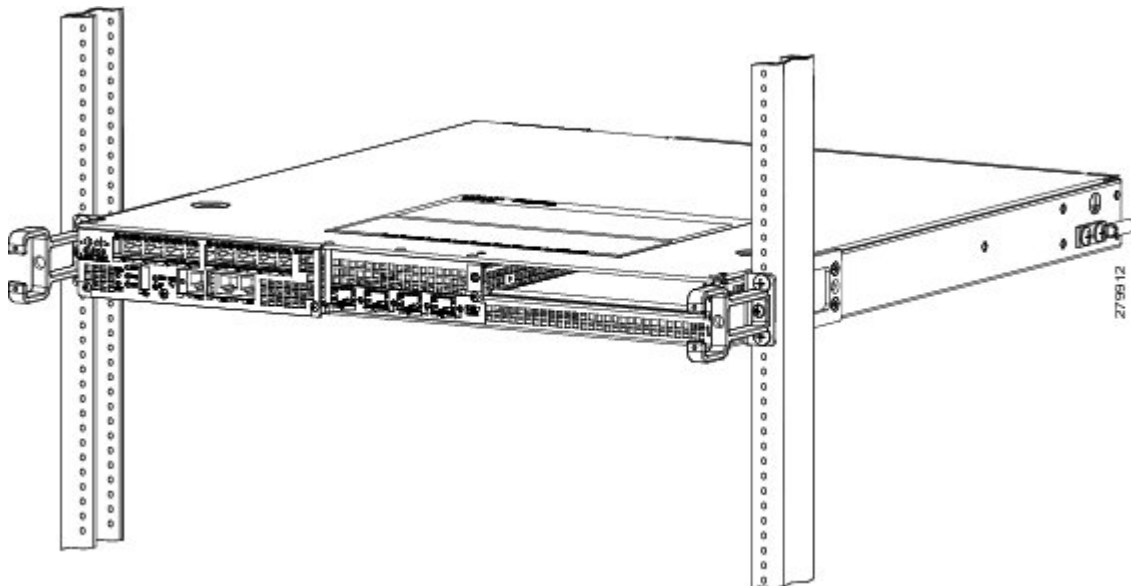

- Step 2** Slide the chassis into the rack, pushing it back until the brackets meet the mounting strips or posts on both sides of the rack.
- Step 3** Keeping the brackets flush against the posts or mounting strips, align the holes in the brackets with the holes on the rack or mounting strip.
- Step 4** For each bracket, insert and tighten two screws to the rack on both sides.

This completes the procedure for installing the chassis on a two-post rack. Proceed to the [Attaching a Chassis Ground Connection](#), on page 28 to continue the installation.

Four-Post Rack Installation

The Cisco ASR 1001 Router can be flush-mounted in a 19-inch equipment rack using the rack-mounting kit provided with your system. The Cisco ASR 1001 Router can be mounted into the rack using two recommended methods:

- Installing the chassis in an existing rack with equipment.
- Installing an empty chassis in a rack with no equipment installed.

When handling the chassis, always follow proper lifting practices. See the “Chassis-Lifting Guidelines” section in the *Preparing Your Site for Installation* chapter.



Note Inner clearance (the width between the inner sides of the two posts or rails) must be at least 19 inches (48.26 cm). The height of the chassis 1.71 inches (43.43 mm). Airflow through the chassis is from front to back.

Make sure the rack is stabilized.

SUMMARY STEPS

1. (Optional) Install a shelf in the rack to support the Cisco ASR 1001 Router. If you are using a shelf then raise the chassis to the level of the shelf. Let the bottom of the chassis rest on the brackets, but continue to support the chassis. Using two people, lift the chassis into the rack using the side handles and grasping underneath the power supply bays.
2. Position the chassis until the rack-mounting flanges are flush against the mounting rails on the rack.
3. Hold the chassis in position against the mounting rails while the second person finger-tightens a screw to the rack rails on each side of the chassis.
4. Finger-tighten screws to the rack rails on each side of the chassis.
5. Tighten all screws on each side to secure the chassis to the equipment rack.
6. Use a level to verify that the tops of the two brackets are level, or use a measuring tape to verify that both brackets are the same distance from the top of the rack rails.

DETAILED STEPS

Step 1 (Optional) Install a shelf in the rack to support the Cisco ASR 1001 Router. If you are using a shelf then raise the chassis to the level of the shelf. Let the bottom of the chassis rest on the brackets, but continue to support the chassis. Using two people, lift the chassis into the rack using the side handles and grasping underneath the power supply bays.

Step 2 Position the chassis until the rack-mounting flanges are flush against the mounting rails on the rack.

Note Use the second hole up from the bottom of the rack-mount bracket and the second hole down from the top of the rack-mount bracket. This will make it easier to attach the cable-management bracket to the chassis in the equipment rack.

Step 3 Hold the chassis in position against the mounting rails while the second person finger-tightens a screw to the rack rails on each side of the chassis.

Step 4 Finger-tighten screws to the rack rails on each side of the chassis.

Step 5 Tighten all screws on each side to secure the chassis to the equipment rack.

The following image shows front and rear rack-mounting of the Cisco ASR 1001 Router on a four-post rack.

Figure 16: Cisco ASR 1001 Router in a Four Post Rack—Front and Rear Rack-Mounting

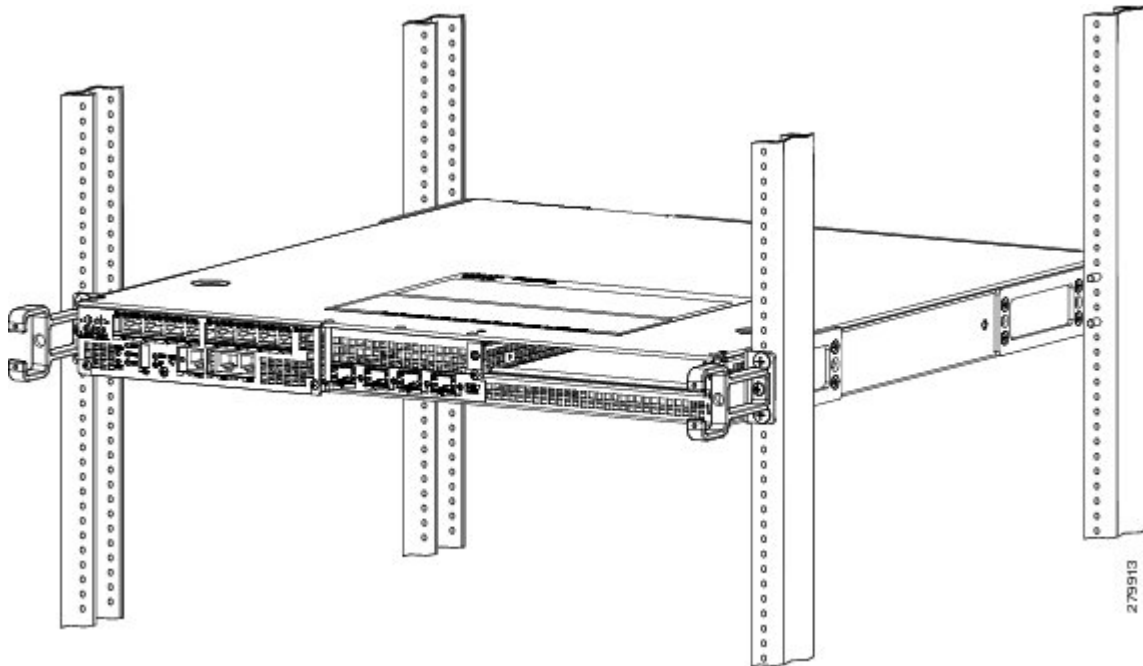

- Step 6** Use a level to verify that the tops of the two brackets are level, or use a measuring tape to verify that both brackets are the same distance from the top of the rack rails.

What to do next

This completes the procedure for installing the chassis in the rack. Proceed to the [Attaching the Cable-Management Bracket](#), on page 27 to continue the installation.

Attaching the Cable-Management Bracket

The cable-management brackets mount to each rack-mount bracket on the chassis to provide cable-management to both sides of the chassis (parallel with card orientation). These brackets are screw mounted to the rack-mount brackets to allow easy installation and removal of cables.

The cable-management brackets for the Cisco ASR 1001 Router contain one independent cable-management “U” type features with four screws and provides cable dressing of each card module slot.



- Note** Make certain that the cable-management bracket “U” type feature is facing upwards when you attach it to the chassis.

Follow these steps to attach the cable-management brackets to both sides of the Cisco ASR 1001 Router in the rack:

SUMMARY STEPS

1. Align the cable-management bracket to the rack-mount bracket on one side of the Cisco ASR 1001 Router. The cable-management bracket aligns to the top hole of the chassis rack-mount bracket.
2. Using a Phillips screwdriver, insert the screw through cable-management bracket and into the chassis rack-mount and tighten the screw.
3. Using the bottom rack-mount ear hole, insert the screw through cable-management bracket and into the chassis rack-mount (see [Figure 17: Chassis Rack-Mount Bracket Ear Holes for the Cable-Management Bracket, on page 28](#)).

DETAILED STEPS

Step 1 Align the cable-management bracket to the rack-mount bracket on one side of the Cisco ASR 1001 Router. The cable-management bracket aligns to the top hole of the chassis rack-mount bracket.

Step 2 Using a Phillips screwdriver, insert the screw through cable-management bracket and into the chassis rack-mount and tighten the screw.

Note Use the package of screws that came with your chassis containing four screws.

The following image shows where to attach the front rack-mount brackets to the Cisco ASR 1001 Router in a rack.

Figure 17: Chassis Rack-Mount Bracket Ear Holes for the Cable-Management Bracket

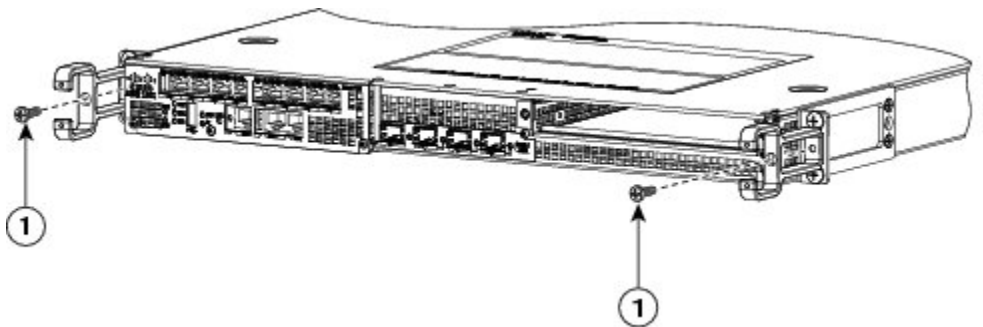

1	Secure the cable-management screw to the middle ear hole of the front rack-mount bracket on both sides of the Cisco ASR 1001 Router.
---	--

Step 3 Using the bottom rack-mount ear hole, insert the screw through cable-management bracket and into the chassis rack-mount (see [Figure 17: Chassis Rack-Mount Bracket Ear Holes for the Cable-Management Bracket, on page 28](#)).

What to do next

This completes the procedure for installing the cable-management brackets on the chassis.

Attaching a Chassis Ground Connection

Connecting the Cisco ASR 1000 Series Router to ground is required for all DC powered installations and any AC powered installation where compliance with Telcordia grounding requirements is necessary.



Caution The dual-lug chassis stud must be installed, the SIP and SPA must be fully inserted and screwed in and earthed to prevent a potential hazard in a telecom line.

Have the recommended tools and supplies available before you begin this procedure.

Recommended Tools and Supplies

The following tools, equipment, and supplies necessary to connect the system ground to the chassis:

- Phillips screwdriver
- 3.5 mm flat blade screwdriver (Phoenix # 1205053 or equivalent 3.5 mm flat blade)
- Dual-lug chassis ground component
- Grounding wire

The following image shows how to attach the ground lugs on the Cisco ASR 1000 Series chassis. The location of the ground lug on Cisco ASR 1000 Series Routers may not be the same on all routers; but the ground lug attachment instructions are similar.

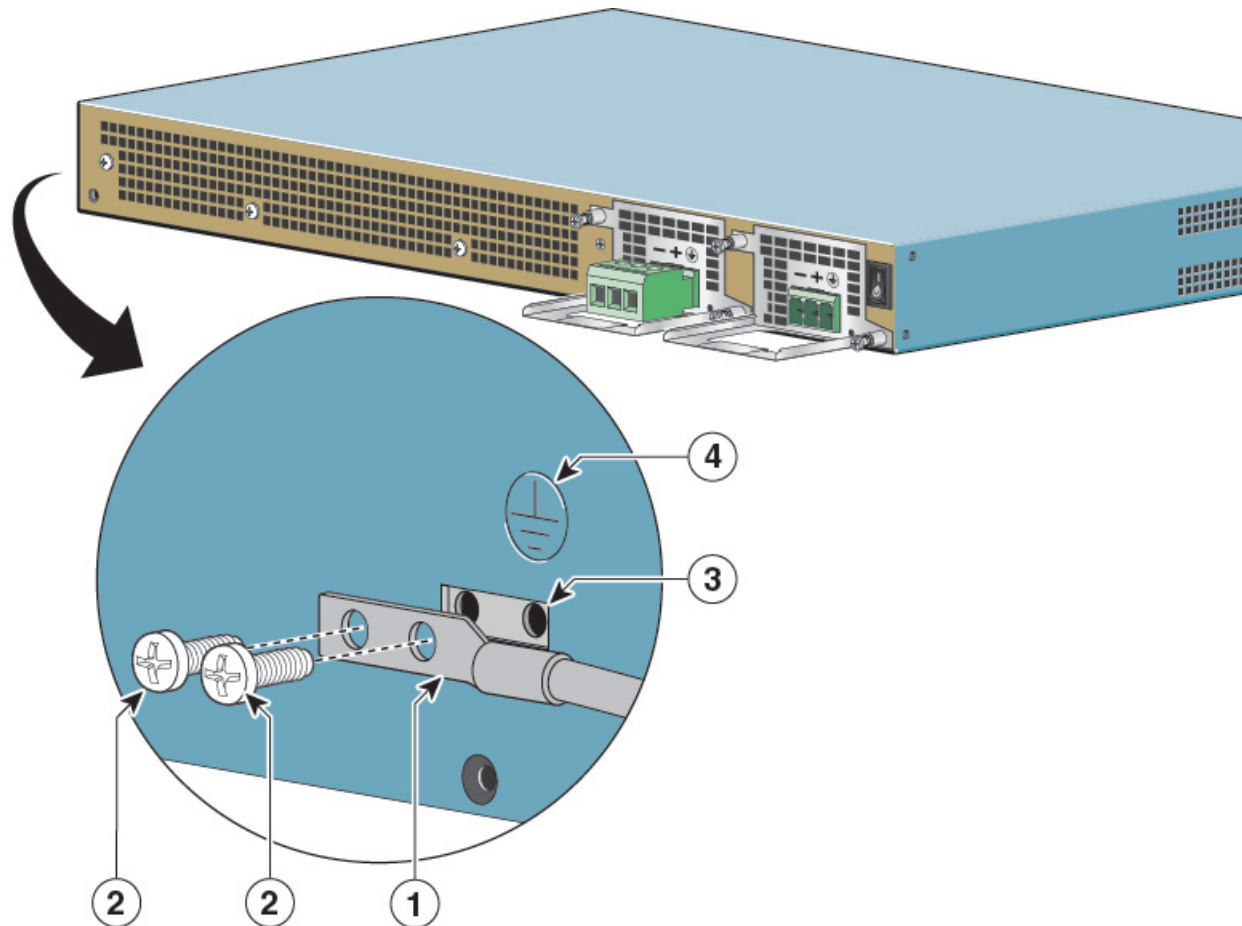

1	Chassis ground studs and lead wire	3	Ground connector on the chassis
2	Grounding screws	4	Ground symbol



Warning This equipment must be grounded. Never defeat the ground conductor or operate the equipment in the absence of a suitably installed ground conductor. Contact the appropriate electrical inspection authority or an electrician if you are uncertain that suitable grounding is available. Statement 1024

Before you connect power or turn on power to your chassis, you must provide an adequate chassis ground (earth) connection for the chassis. A chassis ground connector is provided on each Cisco ASR 1001 Router. There is a stud on the side of the chassis and on the DC power supply (primary grounding stud).



Caution The grounding wire is always the first to be installed or connected and the last to be removed or disconnected.

Use the following procedure to attach the grounding lug to the chassis ground connector on your chassis:

SUMMARY STEPS

1. Use the wire stripper to strip one end of the AWG #6 wire approximately 0.75 inches (19.05 mm).
2. Insert the AWG #6 wire into the wire receptacle on the grounding lug.
3. Use the crimping tool to carefully crimp the wire receptacle around the wire; this step is required to ensure a proper mechanical connection as shown in the next figure.
4. Attach the grounding lug with the wire so that the grounding wire does not overlap the power supply.
5. Locate the chassis ground connector on the side of your chassis.
6. Insert the two screws through the holes in the grounding lug.
7. Use the Number 2 Phillips screwdriver to carefully tighten the screws until the grounding lug is held firmly to the chassis. Do not overtighten the screws.
8. Connect the opposite end of the grounding wire to the appropriate grounding point at your site to ensure an adequate chassis ground.

DETAILED STEPS

- Step 1** Use the wire stripper to strip one end of the AWG #6 wire approximately 0.75 inches (19.05 mm).
- Step 2** Insert the AWG #6 wire into the wire receptacle on the grounding lug.
- Step 3** Use the crimping tool to carefully crimp the wire receptacle around the wire; this step is required to ensure a proper mechanical connection as shown in the next figure.
- Step 4** Attach the grounding lug with the wire so that the grounding wire does not overlap the power supply.

The following image shows how to attach a grounding lug to the chassis ground connector.

Figure 18: Attaching a Grounding Lug to the Chassis Ground Connector

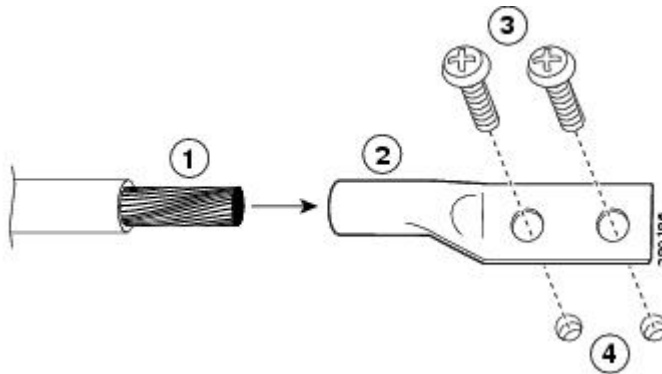

1	Chassis ground lead wire	3	Ground screws
2	Grounding stud	4	Chassis ground connector holes

- Step 5** Locate the chassis ground connector on the side of your chassis.
- Step 6** Insert the two screws through the holes in the grounding lug.
- Step 7** Use the Number 2 Phillips screwdriver to carefully tighten the screws until the grounding lug is held firmly to the chassis. Do not overtighten the screws.
- Step 8** Connect the opposite end of the grounding wire to the appropriate grounding point at your site to ensure an adequate chassis ground.

What to do next

This completes the procedure for attaching a chassis ground connection.

Connecting the Shared Port Adapter Cables

The instructions for connecting the cables for the shared port adapter installed in the Cisco ASR 1001 Router are contained in the respective configuration documents for each port adapter. For example, if you are connecting the optical fiber cables for the PA-POS-OC3 port adapter, see PA-POS-OC3 Port Adapter Installation and Configuration at the following location:

http://www.cisco.com/en/US/partner/docs/interfaces_modules/port_adapters/install_upgrade/pos/pa-pos-oc3_install_config/paposoc3.html

Connecting the Console and Auxiliary Port Cables

This section describes how to attach a cable to the Cisco embedded ASR1000-RP1 console or auxiliary ports on the Cisco ASR 1001 Router. The Cisco ASR 1001 Router uses RJ-45 ports for both the auxiliary port and console port to attach a console terminal.



Note Out of Band (OOB) or modem connection in the AUXILIARY and/ CONSOLE ports, regardless of the configuration, the connection is not established and calls cannot be setup. This is not supported on all the Cisco ASR 1000 Series Aggregation Services Routers and all its Cisco IOS XE versions.



Caution To meet Class A emission requirements, shielded cables must be used for the console and auxiliary port connectors.

Before you can use the console interface on the router using a terminal or PC, you must perform the following steps:

SUMMARY STEPS

1. Before connecting a terminal to the console port, configure the terminal to match the chassis console port as follows: 9600 baud, 8 data bits, no parity, 1 stop bits (9600 8N1).
2. Connect to the port using the RJ-45 to DB-9 cable.
3. After you establish normal router operation, you can disconnect the terminal.

DETAILED STEPS

Step 1 Before connecting a terminal to the console port, configure the terminal to match the chassis console port as follows: 9600 baud, 8 data bits, no parity, 1 stop bits (9600 8N1).

Step 2 Connect to the port using the RJ-45 to DB-9 cable.

Note For information about how to change the default settings to meet the requirements of your terminal or host, see [Cisco IOS Terminal Services Configuration Guide](#) .

Step 3 After you establish normal router operation, you can disconnect the terminal.

What to do next



Note A connection will not be established when setting up an out-of-band connection or modem connection in the auxiliary port and the console port.

Management Ethernet Port Cable Connection



Caution To comply with Class A emissions requirements, a shielded Ethernet cable must be used for the connection.

To use the Management Ethernet interface on the router, perform the following steps:

SUMMARY STEPS

1. Insert an Ethernet RJ-45 cable into the MGMT ETHERNET port (see “Common Connectors for Cisco ASR 1001 Route Processor” figure in the *Cisco ASR 1001 Router Faceplate Common Components* section).
2. Insert the other end of the RJ-45 cable to your management device or network.

DETAILED STEPS

Step 1 Insert an Ethernet RJ-45 cable into the MGMT ETHERNET port (see “Common Connectors for Cisco ASR 1001 Route Processor” figure in the *Cisco ASR 1001 Router Faceplate Common Components* section).

Step 2 Insert the other end of the RJ-45 cable to your management device or network.

Connecting a Terminal to the Cisco ASR1000-RP1 Console Port

The Cisco ASR 1001 embedded route processor has an asynchronous serial (EIA/TIA-232) RJ-45 console port labeled CON on its front panel. You can connect this port to most types of video terminals through use of the console cable kit that is included with your Cisco ASR 1001 Router. The console cable kit contains:

- One RJ-45 to RJ-45 crossover cable
- One RJ-45 to DB-25 (female) adapter
- One RJ-45 to DB-9 (female) adapter

A crossover cable reverses pin connections from one end to the other. In other words, it connects pin 1 (at one end) to pin 8 (at the other end), pin 2 to pin 7, pin 3 to pin 6, and so on. You can identify a crossover cable by comparing the two modular ends of the cable. Hold the cable ends in your hand, side-by-side, with the tabs at the back. Ensure that the wire connected to the outside (left) pin of the left plug (pin 1) is the same color as the wire connected to the outside (right) pin of the right plug (pin 8).

Use the following procedure to connect a video terminal to the console port on a route processor.



Note Each Cisco ASR 1000 Series Route Processor must have a console port connection (typically to a terminal server) if you are running a redundant configuration in the chassis.

SUMMARY STEPS

1. Connect one end of the RJ-45 cables to the serial RJ-45 port (CON) on the Cisco embedded ASR1000-RP1 (see “Common Connectors for Cisco ASR 1001 Route Processor” in the *Cisco ASR 1001 Router Faceplate Common Components* section).
2. Run the cable up and through the cable-management bracket and connect the other end of the RJ-45 cable to the RJ-45 adapter (see “Cisco ASR 1001 Router AC Power Supply and DC Power Supply” figure in the *Cisco ASR 1001 Router Power Supply Installation* section).
3. Connect the adapter to your video terminal to complete the cable connection.
4. Power on your video terminal.
5. Configure your video terminal to match the following default console port settings:

6. Go to the [Connecting Cables, on page 34](#) to continue the installation.

DETAILED STEPS

-
- Step 1** Connect one end of the RJ-45 cables to the serial RJ-45 port (CON) on the Cisco embedded ASR1000-RP1 (see “Common Connectors for Cisco ASR 1001 Route Processor” in the *Cisco ASR 1001 Router Faceplate Common Components* section).
- Step 2** Run the cable up and through the cable-management bracket and connect the other end of the RJ-45 cable to the RJ-45 adapter (see “Cisco ASR 1001 Router AC Power Supply and DC Power Supply” figure in the *Cisco ASR 1001 Router Power Supply Installation* section).
- Step 3** Connect the adapter to your video terminal to complete the cable connection.
- Step 4** Power on your video terminal.
- Step 5** Configure your video terminal to match the following default console port settings:
- 9600 baud
 - 8 data bits
 - No parity generation or checking
 - 1 stop bit
 - No flow control
- Step 6** Go to the [Connecting Cables, on page 34](#) to continue the installation.
-

Connecting Cables

Keep the following guidelines in mind when connecting external cables to the Cisco ASR 1001 Router:

- To reduce the chance of interference, avoid crossing high-power lines with any interface cables.
- Verify all cabling limitations (particularly distance) before powering on the system.

Overview of AC and DC Power Supplies for the Cisco ASR 1001 Router

The Cisco ASR 1001 Router power supplies each provide 400 W of output power and are used in a 1 + 1 redundant configuration. There is no input switch on the faceplate of the power supplies. The power supply will be switched from Standby to ON by way of a system chassis STANDBY/ON switch. The power supply slot numbers are on the rear of the chassis to the left side of each power supply. When facing the rear of the chassis, power supply slot 0 (PS0) is to the left and power supply slot 1 (PS1) is to the right (next to the power supply Standby switch).

The Cisco ASR 1001 Router supports the following power supplies:

- Cisco ASR 1001 Router AC power supply—Provides 400 watt output power with two DC voltage outputs: +12 V and +5 V. The AC power supply operates between 85 and 264 VAC. The AC power

supply current shares on the 12 V output and is used in a dual hot pluggable configuration. The AC power supply consumes a maximum of 471 W of input power.

- Cisco ASR 1001 Router DC power supply—Provides 400 watt output power with two DC voltage outputs: +12 V and +5.0 V. The power supply operates between -40.5 and -72 VDC. The DC power supply current shares on the 12 V output and is used in a dual hot pluggable configuration. The DC power supply consumes a maximum of 500 W of input power.

Cisco ASR 1001 Router Power Supply Installation

The Cisco ASR 1001 Router AC and DC power supplies are shipped installed in the chassis. You must connect the power supplies when they arrive.



Note The Cisco ASR 1001 Router can support two AC or two DC power supplies. Do not mix AC and DC power supply units in the same chassis.

The following image shows both the AC and DC power supplies for the Cisco ASR 1001 Router.

Figure 19: Cisco ASR 1001 Router AC Power Supply and DC Power Supply

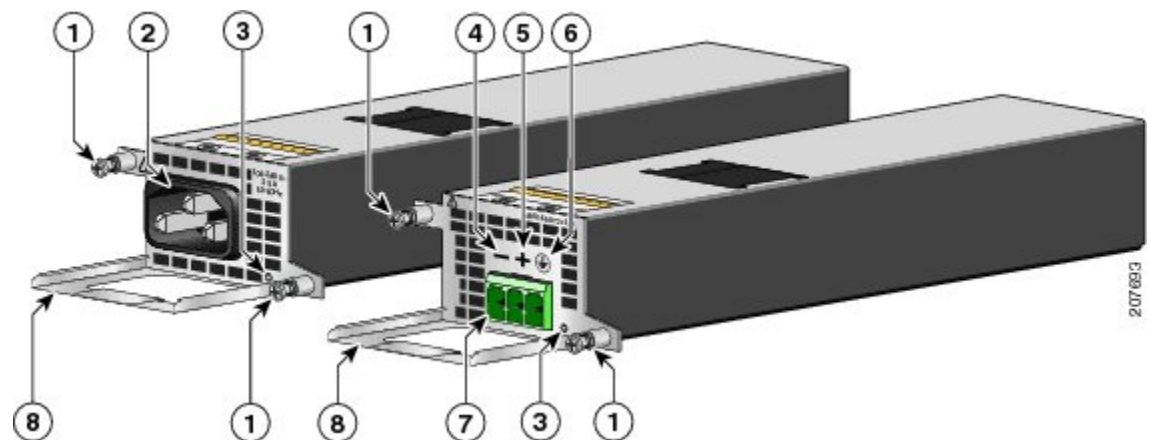

1 AC and DC power supply fasteners	5 DC power supply positive (+) connection
2 AC power supply inlet	6 DC power supply ground symbol
3 Power supply LED	7 DC power supply terminal block connection
4 DC power supply negative (-) connection	8 AC and DC power supply handles

The following table describes the power supply LED. The function of the LED is the same for both the AC and DC power supplies.

Table 8: Cisco ASR 1001 Router AC and DC Power Supply LED

LED Color and State	Description
Solid green	Power output is on and within the normal operating range.
Blinking green, at the rate of one blink per second	Input power that is within the normal operating range is being supplied, but the Standby switch is in the Standby position (and not in the On position).
Solid amber	A power supply critical event has occurred, and the power supply has shut down. The critical event can be temperature, voltage, current, or fan operating outside the normal operating range.
Blinking amber, at the rate of one blink per second	A power supply warning event has occurred, but the power supply can continue to operate. The warning event can be temperature, voltage, current, or fan operating outside the normal operating range.
Off	Power supply is shut down.

This section contains the following topics:



Warning The covers are an integral part of the safety design of the product. Do not operate the unit without the covers installed. Statement 1077



Warning When you install the unit, the ground connection must always be made first and disconnected last. Statement 1046



Warning Before performing any of the following procedures, ensure that power is removed from the DC circuit. Statement 1003



Warning Only trained and **qualified personnel should be allowed** to install, replace, or service this equipment. Statement 1030

Installing AC Input Power to Cisco ASR 1001 Router

The Cisco ASR 1001 Router has two AC power supplies in the rear of the chassis. The input receptacle is an IEC60320 C14 type of filtered AC inlet. The current rating on the connector is 10 A.



Warning Do not install the power supplies with the chassis cover off.

The following image shows the Cisco ASR 1001 Router AC power supplies.

Figure 20: Cisco ASR 1001 Router AC Power Supplies

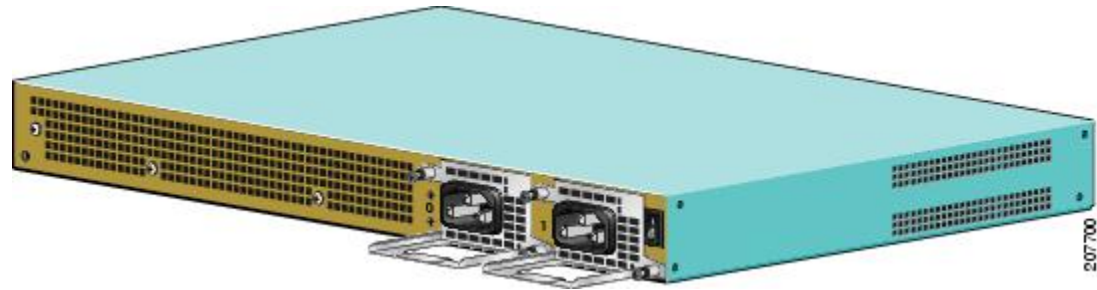

Follow these steps to connect an AC input power supply to the Cisco ASR 1001 Router.

SUMMARY STEPS

1. There are two power supplies installed. At the rear of the chassis, check that the power switch on the chassis is in the standby position.
2. Turn off the circuit breaker to the power supply.
3. For easier installation, plug the power cable into the inlet on power supply slot 1 first.
4. Then insert the power supply cable into the power supply in slot 0 on the right.
5. Make certain that the AC power cords are positioned as shown in the following image.
6. Plug the AC power supply cables into the AC power source.
7. Turn on the AC breaker.
8. Turn the Standby switch to On (I) on the chassis.
9. The power supply LED illuminates green.

DETAILED STEPS

-
- Step 1** There are two power supplies installed. At the rear of the chassis, check that the power switch on the chassis is in the standby position.
- The following image shows the Cisco ASR 1001 Router AC power supply standby switch.

Figure 21: Cisco ASR 1001 Router AC Power Supply Standby Switch

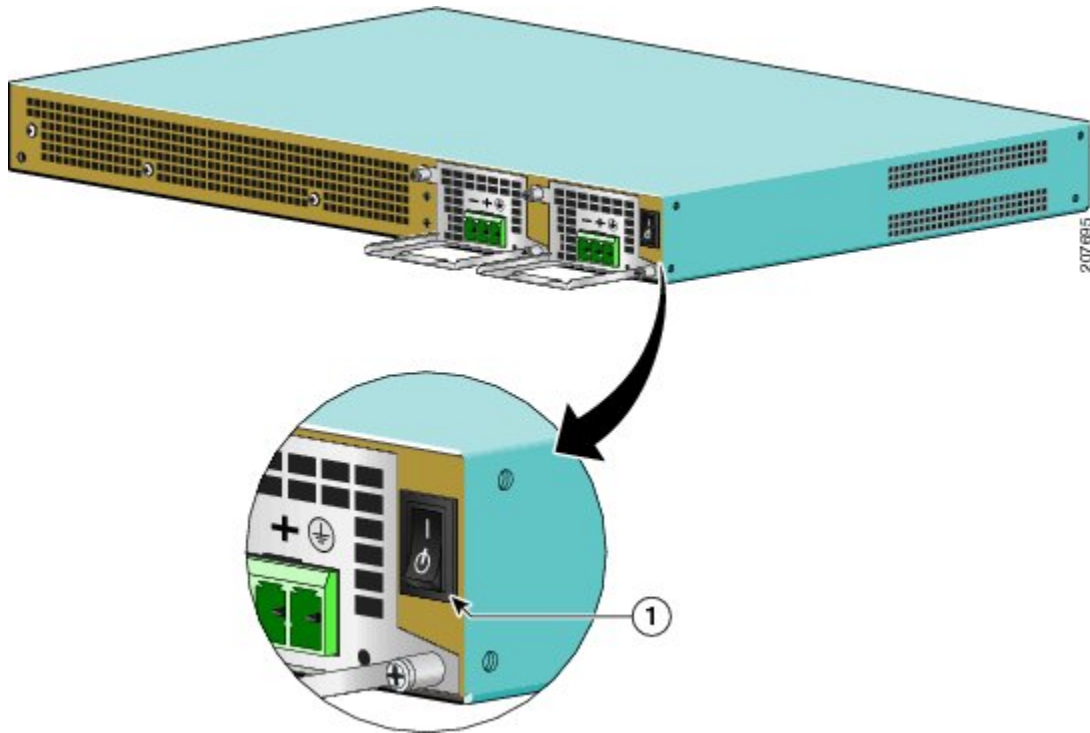

1	Cisco ASR 1001 Router Standby switch, which does not disconnect power from the power source.
---	--

- Step 2** Turn off the circuit breaker to the power supply.
- Step 3** For easier installation, plug the power cable into the inlet on power supply slot 1 first.
- Step 4** Then insert the power supply cable into the power supply in slot 0 on the right.
- Step 5** Make certain that the AC power cords are positioned as shown in the following image.

Figure 22: Correct Position of the Cisco ASR 1001 Router AC Power Supply Cables

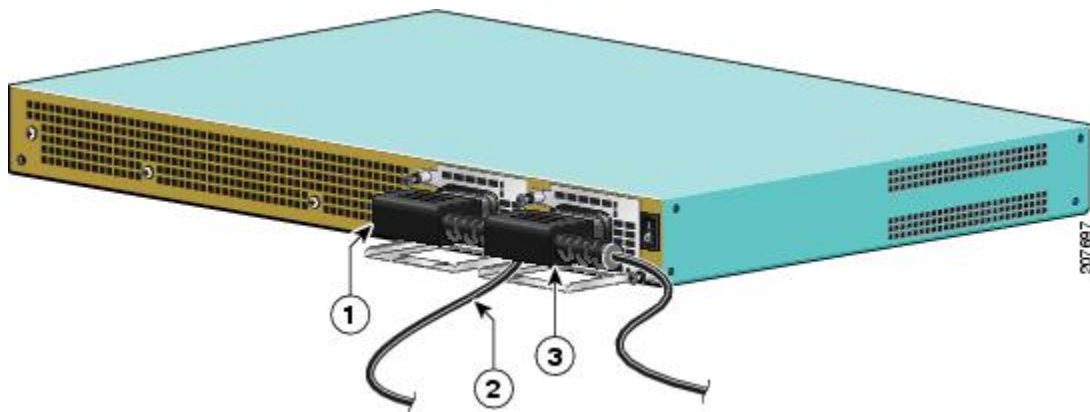

1	AC power supply in PS0	3	AC power supply in PS1
2	Position of power supply cable from PS0		

- Step 6** Plug the AC power supply cables into the AC power source.
- Step 7** Turn on the AC breaker.
- Step 8** Turn the Standby switch to On (I) on the chassis.
- Step 9** The power supply LED illuminates green.

What to do next

This completes the procedure for connecting AC input power.

Removing AC Power Supply from the Cisco ASR 1001 Router

This section describes how to remove an AC power supply from the Cisco ASR 1001 Router. The Cisco ASR 1001 Router has two power supply slots, power supply slot 1 (PS1) next to the Standby switch and power supply slot 0 (PS0) to the left, as shown in the following image.

Follow these steps to remove an AC power supply from the Cisco ASR 1001 router:

SUMMARY STEPS

1. Unplug the power cable from the power source.
2. To remove the power cord from PS1, position the power supply cable in order to access the power supply fasteners. Hold back the power supply cable in PS0, as shown in the following image, ensuring that you do not unplug the power cable.
3. Continue to hold back the power supply cable in PS0, to gain access to the fastener. Unscrew both fasteners on the power supply in slot 1.
4. After the power supply fasteners are loosened, grasp the handle with one hand, support the weight of the power supply with the other hand, and pull the power supply out of the slot. The following image shows how to remove the Cisco ASR 1001 Router AC power supply cables.
5. Repeat these steps to remove the AC power supply from Slot PS0.

DETAILED STEPS

-
- Step 1** Unplug the power cable from the power source.
- Step 2** To remove the power cord from PS1, position the power supply cable in order to access the power supply fasteners. Hold back the power supply cable in PS0, as shown in the following image, ensuring that you do not unplug the power cable.

Figure 23: Positioning the AC Power Supply Cable in Slot PS0

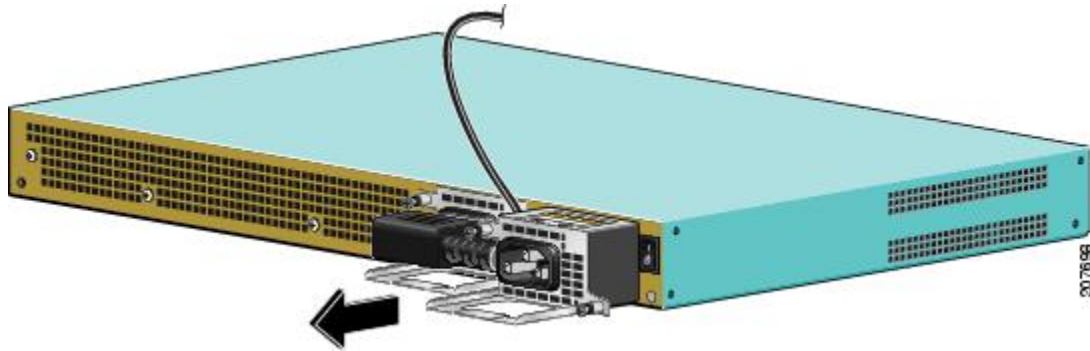

Step 3 Continue to hold back the power supply cable in PS0, to gain access to the fastener. Unscrew both fasteners on the power supply in slot 1.

Tip The Cisco ASR 1001 power supplies are long and narrow. It is recommended that when you pull the power supply out of the chassis, you support the power supply from the bottom with the other hand.

Step 4 After the power supply fasteners are loosened, grasp the handle with one hand, support the weight of the power supply with the other hand, and pull the power supply out of the slot. The following image shows how to remove the Cisco ASR 1001 Router AC power supply cables.

Figure 24: Removing the Cisco ASR 1001 Router AC Power Supply Cables

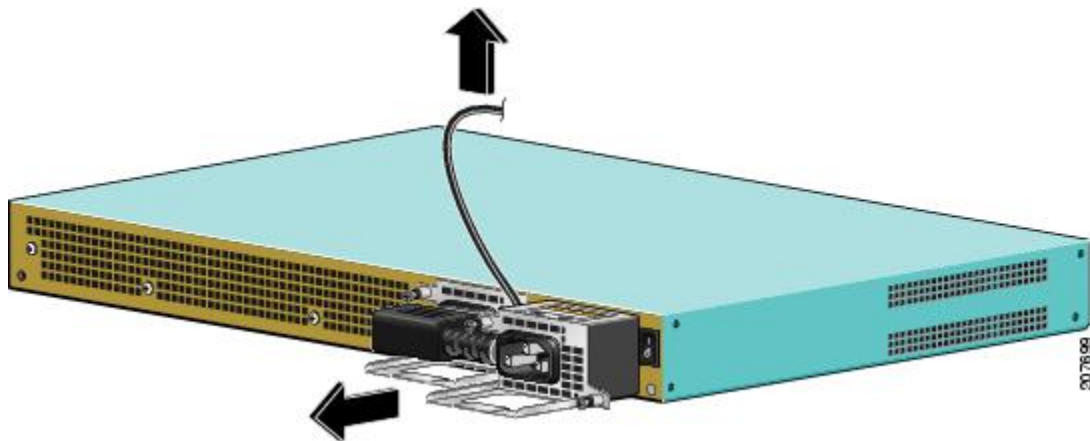

Step 5 Repeat these steps to remove the AC power supply from Slot PS0.

What to do next

This completes the procedure of removing the AC power supply from the Cisco ASR 1001 Router.

Installing DC Input Power on the Cisco ASR 1001 Router

The Cisco ASR 1001 Router DC input connector is compatible with a pluggable Euro-style plug. The input connector and plug must be UL recognized under UL 486 for field wiring. The connection polarity shall be

from left to right: negative (-), positive (+), and ground. See “Cisco ASR 1001 Router AC Power Supply and DC Power Supply” figure in the *Cisco ASR 1001 Router Power Supply Installation* section.

The power supply has a handle, to assist in insertion and extraction. The module must be supported with one hand because of its length. The following image shows the rear view of the Cisco ASR 1001 Router DC power supply.

Figure 25: Cisco ASR 1001 Router DC Power Supply Rear View

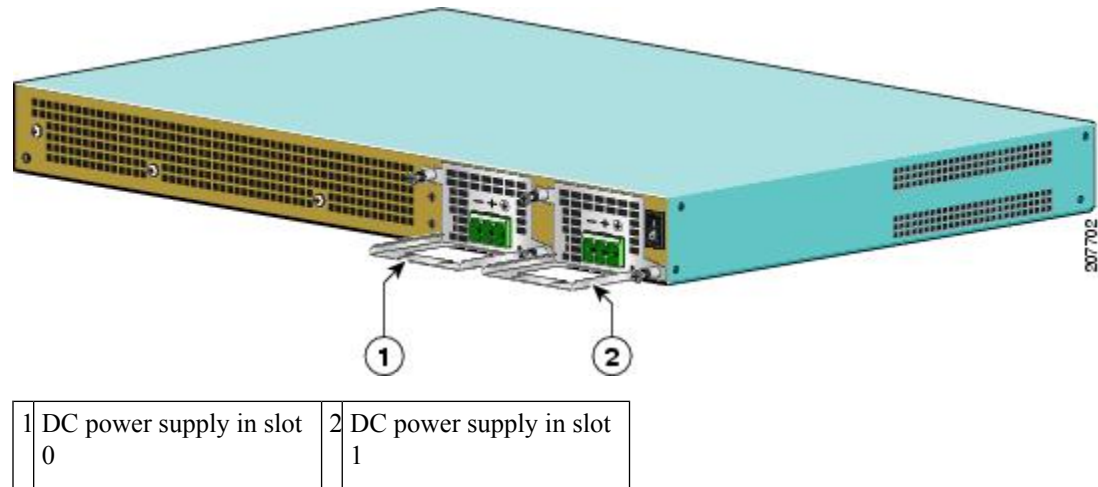

This section describes how to install the DC power supply ground leads and input power leads to the Cisco ASR 1001 Router DC input power supply. Before you begin, read these important notices:

- The color coding of the DC input power supply leads depends on the color coding of the DC power source at your site. Typically, green or green/yellow is used for ground (GND), black is used for -48 V on the negative (-) terminal, and red is used for RTN on the positive (+) terminal. Ensure that the lead color coding you choose for the DC input power supply matches the lead color coding used at the DC power source.
- Ensure that the chassis ground is connected on the chassis before you begin installing the DC power supply. Follow the steps provided in the [Attaching a Chassis Ground Connection, on page 28](#).



Warning When you install a power supply unit, the ground connection should always be made first and disconnected last. Statement 1046

To connect the DC power supply on the Cisco ASDR 1001 Router, follow these steps:

SUMMARY STEPS

1. Ensure that the chassis ground is connected on the chassis before you begin installing the DC power supply, as described in the [Attaching a Chassis Ground Connection, on page 28](#).
2. At the rear of the chassis, next to the power supply bay PS1, ensure that the power supply switch is in Standby position.
3. Turn off the circuit breaker to the power supply.

DETAILED STEPS

-
- Step 1** Ensure that the chassis ground is connected on the chassis before you begin installing the DC power supply, as described in the [Attaching a Chassis Ground Connection](#), on page 28.
- Step 2** At the rear of the chassis, next to the power supply bay PS1, ensure that the power supply switch is in Standby position.
- Step 3** Turn off the circuit breaker to the power supply.
-

Wiring the DC Input Power Source

The Cisco ASR 1001 Router DC power supply has a connector plug that is installed into the power supply terminal block header. The following figure shows a view of a DC power supply with a DC connector plug inserted (no wires installed) into the power supply block header in power supply PS0 (on the left), and the other power supply with no connector plug inserted into power supply PS1 (on the right).

Figure 26: Cisco ASR 1001 Router DC Power Supply Terminal Block With a Connector Plug in Slot 0 and Without a Connector Plug in Slot 1

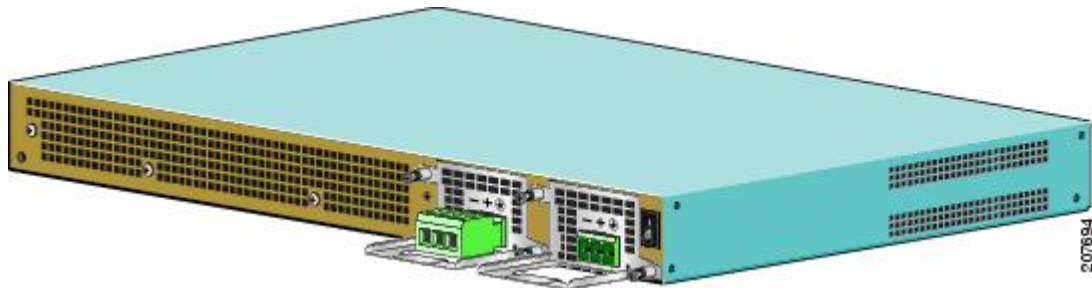

Note Two types of DC connector plugs are supported for use with the DC power supply for the Cisco ASR 1001 Router. In one type of connector plug, the screw holes are raised above the connector plug body. In the second type, the screw holes are not raised above the connector plug body. The figure in step 6 shows the connector plug in which the screw holes are not raised. The only difference in the method for using these two types of connector plugs is related to the wire-strip length, which is mentioned later in this section.



Danger When installing or replacing the unit, the ground connection must always be made first and disconnected last. Statement 1046



Danger This product relies on the building's installation for short-circuit (overcurrent) protection. Ensure that the protective device is rated not greater than: 120 VAC, 20A U.S. (240 VAC, 10A international). Statement 1005



Danger Before performing any of the following procedures, ensure that power is removed from the DC circuit. Statement 1003



Danger Only trained and qualified personnel should be allowed to install, replace, or service this equipment. Statement 1030

Use the information provided in this section to wire the DC input power source:

SUMMARY STEPS

1. At the front of the router, ensure that the power switch is in the Standby position.
2. Move the circuit-breaker switch handle to the Off position, and apply tape to hold it in the Off position.
3. Gather the DC power supply terminal block plug.
4. Insert the lead wires before inserting the plug into the terminal block header on the DC power supply.
5. Use a 10 gauge wire-stripping tool to strip each of the three wires coming from the DC input power source. If you are using the connector plug with the raised screw holes, strip the wires to 0.39 inch (10 mm) + 0.02 inch (0.5 mm). If you are using the connector plug with the screw holes that are not raised, strip the wires to 0.27 inch (7 mm) + 0.02 inch (0.5 mm). Do not strip more than the recommended length of wire because doing so could leave the wire exposed from the terminal block plug. The following figure shows a stripped DC input power source wire.
6. Identify the positive, negative, and ground feed positions for the terminal block connection. The recommended wiring sequence is:
7. Insert the exposed wire of one of the ground wire into the terminal block plug. Ensure that you cannot see any wire lead. Only wires with insulation should extend from the terminal block.
8. Use a ratcheting torque screwdriver to torque the terminal block plug captive screw (above the installed wire lead) to from 0.5 Nm (4.425 lbf in. to 0.6 Nm (5.310 lbf in.), as shown in the following figure.
9. Repeat Step 6 through Step 8 for the remaining two DC input power source wires, the positive lead wire and the negative lead wire.
10. Use a tie wrap to secure the wires to the rack, so that the wires are not pulled from the terminal block plug by casual contact. Make sure the tie wrap allows for some slack in the ground wire. The following figure shows the DC terminal block plug inserted and the tie wrap secured.
11. Ensure that the terminal block plug is fully seated in the terminal block header on the DC power supply panel. You will hear a snap or click when installed properly.
12. Remove the tape (if any) from the circuit breaker switch handle, and move the circuit breaker switch handle to the On position.
13. At the rear of the router, place the power supply Standby switch in the On position to turn on the router.

DETAILED STEPS

-
- Step 1** At the front of the router, ensure that the power switch is in the Standby position.
- Step 2** Move the circuit-breaker switch handle to the Off position, and apply tape to hold it in the Off position.
- Step 3** Gather the DC power supply terminal block plug.
- Step 4** Insert the lead wires before inserting the plug into the terminal block header on the DC power supply.

Step 5 Use a 10 gauge wire-stripping tool to strip each of the three wires coming from the DC input power source. If you are using the connector plug with the raised screw holes, strip the wires to 0.39 inch (10 mm) + 0.02 inch (0.5 mm). If you are using the connector plug with the screw holes that are not raised, strip the wires to 0.27 inch (7 mm) + 0.02 inch (0.5 mm). Do not strip more than the recommended length of wire because doing so could leave the wire exposed from the terminal block plug. The following figure shows a stripped DC input power source wire.

Figure 27: Stripping the DC Input Power Source Wire

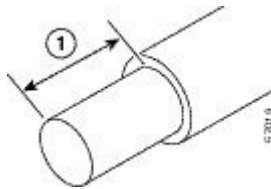

1	0.39 inch (10 mm) is the recommended wire-strip length for the connector plug that has raised screw holes. 0.27 inch (7 mm) is the recommended wire-strip length for the connector plug that does not have raised screw holes.
---	--

Danger An exposed wire lead from a DC input power source can conduct harmful levels of electricity. Be sure that no exposed portion of the DC input power source wire extends from the terminal block plug. Statement 122

Step 6 Identify the positive, negative, and ground feed positions for the terminal block connection. The recommended wiring sequence is:

- Ground lead wire (right)
- Positive (+) lead wire (middle)
- Negative (–) lead wire (left)

The following figure shows the DC power supply with lead wires.

Figure 28: DC Power Supply with Lead Wires

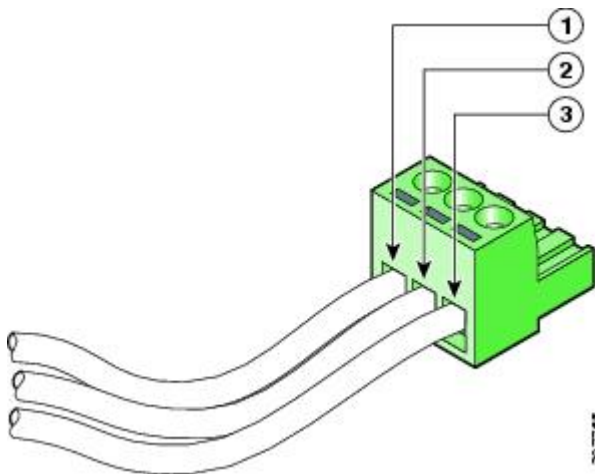

1	Negative (–) lead wire	3	Ground lead wire
2	Positive (+) lead wire	—	—

Step 7 Insert the exposed wire of one of the ground wire into the terminal block plug. Ensure that you cannot see any wire lead. Only wires with insulation should extend from the terminal block.

Caution Do not overtorque the terminal block plug captive screws. The recommended maximum torque is from 0.5 Nm (4.425 lbf in.) to 0.6 Nm (5.310 lbf in.).

Step 8 Use a ratcheting torque screwdriver to torque the terminal block plug captive screw (above the installed wire lead) to from 0.5 Nm (4.425 lbf in. to 0.6 Nm (5.310 lbf in.), as shown in the following figure.

Figure 29: Torquing the DC Power Supply Terminal Block Plug Screws

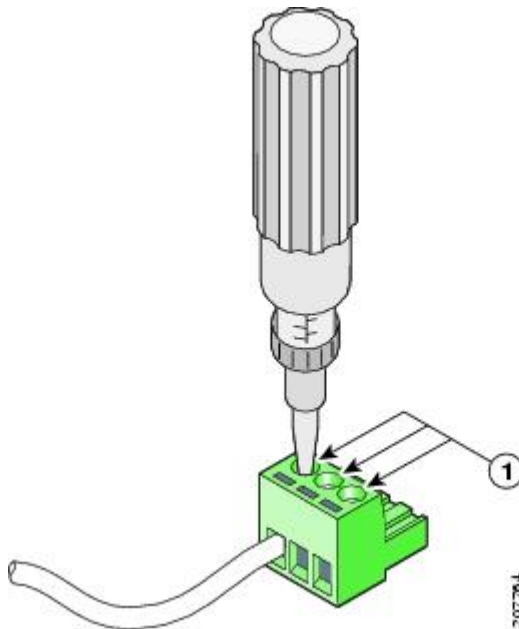

1	Torque is from 0.5 Nm (4.425 lbf in.) to 0.6 Nm (5.310 lbf in.)
---	---

Step 9 Repeat Step 6 through Step 8 for the remaining two DC input power source wires, the positive lead wire and the negative lead wire.

The following figure shows how to insert the DC power supply terminal block plug in the block header.

Figure 30: Inserting the DC Power Supply Terminal Block Plug in the Block Header

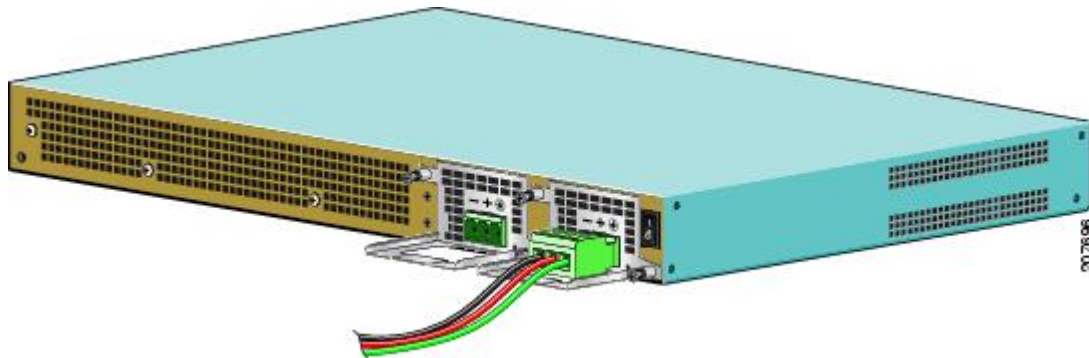

1	DC power supply negative (-) lead wire	3	DC power supply ground lead wire
---	--	---	----------------------------------

2 DC power supply positive (+) lead wire	—	—
--	---	---

Caution Secure the wires coming in from the terminal block plug so that they cannot be disturbed by casual contact.

Step 10

Use a tie wrap to secure the wires to the rack, so that the wires are not pulled from the terminal block plug by casual contact. Make sure the tie wrap allows for some slack in the ground wire. The following figure shows the DC terminal block plug inserted and the tie wrap secured.

Figure 31: Complete DC Terminal Block Plug Insertion and Secure Tie Wrap

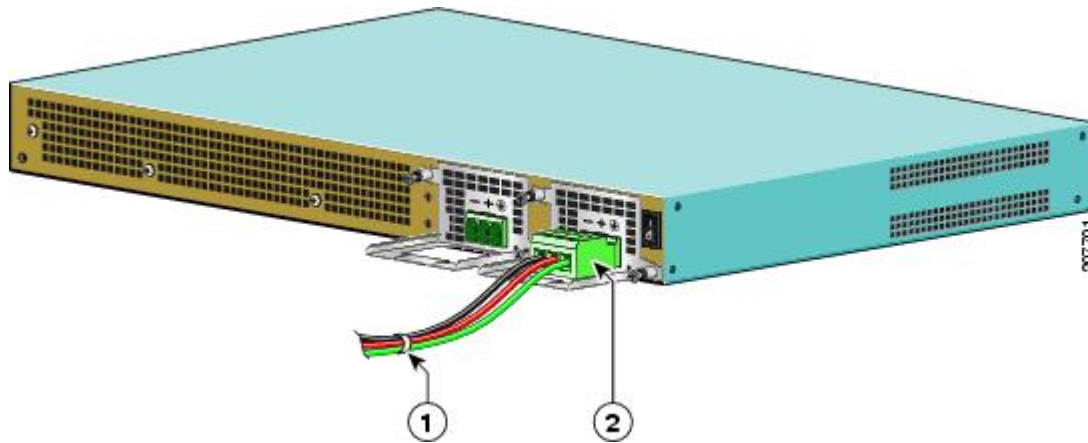

1 Lead wires secured with a tie wrap	2 DC power supply terminal block plug being inserted into terminal block header.
--------------------------------------	--

Step 11

Ensure that the terminal block plug is fully seated in the terminal block header on the DC power supply panel. You will hear a snap or click when installed properly.

Step 12

Remove the tape (if any) from the circuit breaker switch handle, and move the circuit breaker switch handle to the On position.

Step 13

At the rear of the router, place the power supply Standby switch in the On position to turn on the router. The power supply LEDs light up when power is supplied to the router.

What to do next

This completes the procedure for connecting the DC power supply in the Cisco ASR 1001 Router.

Removing DC Input Power from the Cisco ASR 1001 Router

This section describes how to remove a DC power supply from the Cisco ASR 1001 Router. Follow these steps:

SUMMARY STEPS

1. Turn off the circuit breaker.
2. Pull the terminal block plug connector out of the terminal block head in the power supply.
3. Unscrew the two power supply fasteners on the unit.

4. Grasping the power supply handle with one hand, pull the power supply out of the chassis while supporting it with the other hand.

DETAILED STEPS

- Step 1** Turn off the circuit breaker.
- Step 2** Pull the terminal block plug connector out of the terminal block head in the power supply.
- Step 3** Unscrew the two power supply fasteners on the unit.
- Step 4** Grasping the power supply handle with one hand, pull the power supply out of the chassis while supporting it with the other hand.
-

What to do next

This completes the procedure for removing the DC power supply from the Cisco ASR 1001 Router.

