



Cisco IR807 Industrial Integrated Services Router Hardware Installation Guide

First Published: 2017-11-10

Last Modified: 2021-02-15

Americas Headquarters

Cisco Systems, Inc.
170 West Tasman Drive
San Jose, CA 95134-1706
USA
<http://www.cisco.com>
Tel: 408 526-4000
800 553-NETS (6387)
Fax: 408 527-0883

THE SPECIFICATIONS AND INFORMATION REGARDING THE PRODUCTS IN THIS MANUAL ARE SUBJECT TO CHANGE WITHOUT NOTICE. ALL STATEMENTS, INFORMATION, AND RECOMMENDATIONS IN THIS MANUAL ARE BELIEVED TO BE ACCURATE BUT ARE PRESENTED WITHOUT WARRANTY OF ANY KIND, EXPRESS OR IMPLIED. USERS MUST TAKE FULL RESPONSIBILITY FOR THEIR APPLICATION OF ANY PRODUCTS.

THE SOFTWARE LICENSE AND LIMITED WARRANTY FOR THE ACCOMPANYING PRODUCT ARE SET FORTH IN THE INFORMATION PACKET THAT SHIPPED WITH THE PRODUCT AND ARE INCORPORATED HEREIN BY THIS REFERENCE. IF YOU ARE UNABLE TO LOCATE THE SOFTWARE LICENSE OR LIMITED WARRANTY, CONTACT YOUR CISCO REPRESENTATIVE FOR A COPY.

The Cisco implementation of TCP header compression is an adaptation of a program developed by the University of California, Berkeley (UCB) as part of UCB's public domain version of the UNIX operating system. All rights reserved. Copyright © 1981, Regents of the University of California.

NOTWITHSTANDING ANY OTHER WARRANTY HEREIN, ALL DOCUMENT FILES AND SOFTWARE OF THESE SUPPLIERS ARE PROVIDED "AS IS" WITH ALL FAULTS. CISCO AND THE ABOVE-NAMED SUPPLIERS DISCLAIM ALL WARRANTIES, EXPRESSED OR IMPLIED, INCLUDING, WITHOUT LIMITATION, THOSE OF MERCHANTABILITY, FITNESS FOR A PARTICULAR PURPOSE AND NON-INFRINGEMENT OR ARISING FROM A COURSE OF DEALING, USAGE, OR TRADE PRACTICE.

IN NO EVENT SHALL CISCO OR ITS SUPPLIERS BE LIABLE FOR ANY INDIRECT, SPECIAL, CONSEQUENTIAL, OR INCIDENTAL DAMAGES, INCLUDING, WITHOUT LIMITATION, LOST PROFITS OR LOSS OR DAMAGE TO DATA ARISING OUT OF THE USE OR INABILITY TO USE THIS MANUAL, EVEN IF CISCO OR ITS SUPPLIERS HAVE BEEN ADVISED OF THE POSSIBILITY OF SUCH DAMAGES.

Any Internet Protocol (IP) addresses and phone numbers used in this document are not intended to be actual addresses and phone numbers. Any examples, command display output, network topology diagrams, and other figures included in the document are shown for illustrative purposes only. Any use of actual IP addresses or phone numbers in illustrative content is unintentional and coincidental.

All printed copies and duplicate soft copies of this document are considered uncontrolled. See the current online version for the latest version.

Cisco has more than 200 offices worldwide. Addresses and phone numbers are listed on the Cisco website at www.cisco.com/go/offices.

Cisco and the Cisco logo are trademarks or registered trademarks of Cisco and/or its affiliates in the U.S. and other countries. To view a list of Cisco trademarks, go to this URL: <https://www.cisco.com/c/en/us/about/legal/trademarks.html>. Third-party trademarks mentioned are the property of their respective owners. The use of the word partner does not imply a partnership relationship between Cisco and any other company. (1721R)

© 2017–2021 Cisco Systems, Inc. All rights reserved.



CHAPTER 1

Preface

This preface describes the objectives, audience, organization, and conventions of this guide and describes related documents that have additional information. It contains the following sections:

- [Preface, on page 1](#)

Preface

This preface describes the objectives, audience, organization, and conventions of this guide and describes related documents that have additional information.



Note The documentation set for this product strives to use bias-free language. For purposes of this documentation set, bias-free is defined as language that does not imply discrimination based on age, disability, gender, racial identity, ethnic identity, sexual orientation, socioeconomic status, and intersectionality. Exceptions may be present in the documentation due to language that is hardcoded in the user interfaces of the product software, language used based on RFP documentation, or language that is used by a referenced third-party product.

It contains the following sections:

Objective

This guide provides an overview and explains how to install, connect, and perform initial configuration for the device.

Audience

This guide is intended for people who have a high level of technical ability, although they may not have experience with Cisco software.

Conventions

This section describes the conventions used in this guide.

NOTE: Means reader take note. Notes contain helpful suggestions or references to additional information and material.

CAUTION: This symbol means reader be careful. In this situation, you might do something that could result in equipment damage or loss of data.

TIP: Means *the following information will help you solve a problem*. The tip information might not be troubleshooting or even an action, but could be useful information.

WARNING: IMPORTANT SAFETY INSTRUCTIONS Means danger. You are in a situation that could cause bodily injury. Before you work on any equipment, be aware of the hazards involved with electrical circuitry and be familiar with standard practices for preventing accidents. Use the statement number provided at the end of each warning to locate its translation in the translated safety warnings that accompanied this device.

Safety Warnings

Note: If installing this product in a hazardous location (class I, zone/division 2), please refer to the Product Documentation and Compliance Information guide provided with each unit for additional instructions.

Warning	<p>IMPORTANT SAFETY INSTRUCTIONS</p> <p>This warning symbol means danger. You are in a situation that could cause bodily injury. Before you work on any equipment, be aware of the hazards involved with electrical circuitry and be familiar with standard practices for preventing accidents. Use the statement number provided at the end of each warning to locate its translation in the translated safety warnings that accompanied this device. Statement 1071</p> <p>SAVE THESE INSTRUCTIONS</p>
Waarschuwing	<p>BELANGRIJKE VEILIGHEIDSINSTRUCTIES</p> <p>Dit waarschuwingssymbool betekent gevaar. U verkeert in een situatie die lichamelijk letsel kan veroorzaken. Voordat u aan enige apparatuur gaat werken, dient u zich bewust te zijn van de bij elektrische schakelingen betrokken risico's en dient u op de hoogte te zijn van de standaard praktijken om ongelukken te voorkomen. Gebruik het nummer van de verklaring onderaan de waarschuwing als u een vertaling van de waarschuwing die bij het apparaat wordt geleverd, wilt raadplegen.</p> <p>BEWAAR DEZE INSTRUCTIES</p>
Varoitus	<p>TÄRKEITÄ TURVALLISUUSOHJEITA</p> <p>Tämä varoitusmerkki merkitsee vaaraa. Tilanne voi aiheuttaa ruumiillisia vammoja. Ennen kuin käsittelet laitteistoa, huomioi sähköpiirien käsittelyyn liittyvät riskit ja tutustu onnettomuuksien yleisiin ehkäisytapoihin. Turvallisuusvaroitusten käännökset löytyvät laitteen mukana toimitettujen käännettyjen turvallisuusvaroitusten joukosta varoitusten lopussa näkyvien lausuntonumeroiden avulla.</p> <p>SÄILYTÄ NÄMÄ OHJEET</p>

Attention	<p>IMPORTANTES INFORMATIONS DE SÉCURITÉ</p> <p>Ce symbole d'avertissement indique un danger. Vous vous trouvez dans une situation pouvant entraîner des blessures ou des dommages corporels. Avant de travailler sur un équipement, soyez conscient des dangers liés aux circuits électriques et familiarisez-vous avec les procédures couramment utilisées pour éviter les accidents. Pour prendre connaissance des traductions des avertissements figurant dans les consignes de sécurité traduites qui accompagnent cet appareil, référez-vous au numéro de l'instruction situé à la fin de chaque avertissement.</p> <p>CONSERVEZ CES INFORMATIONS</p>
Warnung	<p>WICHTIGE SICHERHEITSHINWEISE</p> <p>Dieses Warnsymbol bedeutet Gefahr. Sie befinden sich in einer Situation, die zu Verletzungen führen kann. Machen Sie sich vor der Arbeit mit Geräten mit den Gefahren elektrischer Schaltungen und den üblichen Verfahren zur Vorbeugung vor Unfällen vertraut. Suchen Sie mit der am Ende jeder Warnung angegebenen Anweisungsnummer nach der jeweiligen Übersetzung in den übersetzten Sicherheitshinweisen, die zusammen mit diesem Gerät ausgeliefert wurden.</p> <p>BEWAHREN SIE DIESE HINWEISE GUT AUF.</p>
Avvertenza	<p>IMPORTANTI ISTRUZIONI SULLA SICUREZZA</p> <p>Questo simbolo di avvertenza indica un pericolo. La situazione potrebbe causare infortuni alle persone. Prima di intervenire su qualsiasi apparecchiatura, occorre essere al corrente dei pericoli relativi ai circuiti elettrici e conoscere le procedure standard per la prevenzione di incidenti. Utilizzare il numero di istruzione presente alla fine di ciascuna avvertenza per individuare le traduzioni delle avvertenze riportate in questo documento.</p> <p>CONSERVARE QUESTE ISTRUZIONI</p>
Advarsel	<p>VIKTIGE SIKKERHETSINSTRUKSJONER</p> <p>Dette advarselssymbolet betyr fare. Du er i en situasjon som kan føre til skade på person. Før du begynner å arbeide med noe av utstyret, må du være oppmerksom på farene forbundet med elektriske kretser, og kjenne til standardprosedyrer for å forhindre ulykker. Bruk nummeret i slutten av hver advarsel for å finne oversettelsen i de oversatte sikkerhetsadvarslene som fulgte med denne enheten.</p> <p>TA VARE PÅ DISSE INSTRUKSJONENE</p>
Aviso	<p>INSTRUÇÕES IMPORTANTES DE SEGURANÇA</p> <p>Este símbolo de aviso significa perigo. Você está em uma situação que poderá ser causadora de lesões corporais. Antes de iniciar a utilização de qualquer equipamento, tenha conhecimento dos perigos envolvidos no manuseio de circuitos elétricos e familiarize-se com as práticas habituais de prevenção de acidentes. Utilize o número da instrução fornecido ao final de cada aviso para localizar sua tradução nos avisos de segurança traduzidos que acompanham este dispositivo.</p> <p>GUARDE ESTAS INSTRUÇÕES</p>

<p>¡Advertencia!</p>	<p>INSTRUCCIONES IMPORTANTES DE SEGURIDAD</p> <p>Este símbolo de aviso indica peligro. Existe riesgo para su integridad física. Antes de manipular cualquier equipo, considere los riesgos de la corriente eléctrica y familiarícese con los procedimientos estándar de prevención de accidentes. Al final de cada advertencia encontrará el número que le ayudará a encontrar el texto traducido en el apartado de traducciones que acompaña a este dispositivo.</p> <p>GUARDE ESTAS INSTRUCCIONES</p>
<p>Varning!</p>	<p>VIKTIGA SÄKERHETSANVISNINGAR</p> <p>Denna varningssignal signalerar fara. Du befinner dig i en situation som kan leda till personskada. Innan du utför arbete på någon utrustning måste du vara medveten om farorna med elkretsar och känna till vanliga förfaranden för att förebygga olyckor. Använd det nummer som finns i slutet av varje varning för att hitta dess översättning i de översatta säkerhetsvarningar som medföljer denna anordning.</p> <p>SPARA DESSA ANVISNINGAR</p>
<p>Figyelem</p>	<p>FONTOS BIZTONSÁGI ELOÍRÁSOK</p> <p>Ez a figyelmeztető jel veszélyre utal. Sérülésveszélyt rejte helyzetben van. Mielott bármely berendezésen munkát végezte, legyen figyelemmel az elektromos áramkörök okozta kockázatokra, és ismerkedjen meg a szokásos balesetvédelmi eljárásokkal. A kiadványban szereplő figyelmeztetések fordítása a készülékhez mellékelt biztonsági figyelmeztetések között található; a fordítás az egyes figyelmeztetések végén látható szám alapján kereshető meg.</p> <p>ORIZZE MEG EZEKET AZ UTASÍTÁSOKAT!</p>
<p>Предупреждение</p>	<p>ВАЖНЫЕ ИНСТРУКЦИИ ПО СОБЛЮДЕНИЮ ТЕХНИКИ БЕЗОПАСНОСТИ</p> <p>Этот символ предупреждения обозначает опасность. То есть имеет место ситуация, в которой следует опасаться телесных повреждений. Перед эксплуатацией оборудования выясните, каким опасностям может подвергаться пользователь при использовании электрических цепей, и ознакомьтесь с правилами техники безопасности для предотвращения возможных несчастных случаев. Воспользуйтесь номером заявления, приведенным в конце каждого предупреждения, чтобы найти его переведенный вариант в переводе предупреждений по безопасности, прилагаемом к данному устройству.</p> <p>СОХРАНИТЕ ЭТИ ИНСТРУКЦИИ</p>
<p>警告</p>	<p>重要的安全性说明</p> <p>此警告符号代表危险。您正处于可能受到严重伤害的工作环境中。在您使用设备开始工作之前，必须充分意识到触电的危险，并熟练掌握防止事故发生的标准工作程序。请根据每项警告结尾提供的声明号码来找到此设备的安全性警告说明的翻译文本。</p> <p>请保存这些安全性说明</p>
<p>警告</p>	<p>安全上の重要な注意事項</p> <p>「危険」の意味です。人身事故を予防するための注意事項が記述されています。装置の取り扱い作業を行うときは、電気回路の危険性に注意し、一般的な事故防止策に留意してください。警告の各国語版は、各注意事項の番号を基に、装置に付属の「Translated Safety Warnings」を参照してください。</p> <p>これらの注意事項を保管しておいてください。</p>

주의	<p>중요 안전 지침</p> <p>이 경고 기호는 위험을 나타냅니다. 작업자가 신체 부상을 일으킬 수 있는 위험한 환경에 있습니다. 장비에 작업을 수행하기 전에 전기 회로와 관련된 위험을 숙지하고 표준 작업 관례를 숙지하여 사고를 방지하십시오. 각 경고의 마지막 부분에 있는 경고문 번호를 참조하여 이 장치와 함께 제공되는 번역된 안전 경고문에서 해당 번역문을 찾으십시오.</p> <p>이 지시 사항을 보관하십시오.</p>
Aviso	<p>INSTRUÇÕES IMPORTANTES DE SEGURANÇA</p> <p>Este símbolo de aviso significa perigo. Você se encontra em uma situação em que há risco de lesões corporais. Antes de trabalhar com qualquer equipamento, esteja ciente dos riscos que envolvem os circuitos elétricos e familiarize-se com as práticas padrão de prevenção de acidentes. Use o número da declaração fornecido ao final de cada aviso para localizar sua tradução nos avisos de segurança traduzidos que acompanham o dispositivo.</p> <p>GUARDE ESTAS INSTRUÇÕES</p>
Advarsel	<p>VIGTIGE SIKKERHEDSANVISNINGER</p> <p>Dette advarselssymbol betyder fare. Du befinder dig i en situation med risiko for legemeskadedigelse. Før du begynder arbejde på udstyr, skal du være opmærksom på de involverede risici, der er ved elektriske kredsløb, og du skal sætte dig ind i standardprocedurer til undgåelse af ulykker. Brug erklæringsnummeret efter hver advarsel for at finde oversættelsen i de oversatte advarsler, der fulgte med denne enhed.</p> <p>GEM DISSE ANVISNINGER</p>
تحذير	<p>إرشادات الأمان الهامة</p> <p>يوضح رمز التحذير هذا وجود خطر. وهذا يعني أنك متواجد في مكان قد ينتج عنه التعرض لإصابات. قبل بدء العمل، احذر مخاطر التعرض للصدمة الكهربائية وكن على علم بالإجراءات القياسية للحيولة دون وقوع أي حوادث. استخدم رقم البيان الموجود في آخر كل تحذير لتحديد مكان ترجمته داخل تحذيرات الأمان المترجمة التي تأتي مع الجهاز. قم بحفظ هذه الإرشادات</p>
Upozorenje	<p>U električnoj mreži mora biti ugrađen lako dostupan dvopolni uređaj za isključivanje kruga.</p>
Upozornění	<p>DŮLEŽITÉ BEZPEČNOSTNÍ POKYNY</p> <p>Tento upozorňující symbol označuje nebezpečí. Jste v situaci, která by mohla způsobit nebezpečí úrazu. Před prací na jakémkoliv vybavení si uvědomte nebezpečí související s elektrickými obvody a seznamte se se standardními opatřeními pro předcházení úrazům. Podle čísla na konci každého upozornění vyhledejte jeho překlad v přeložených bezpečnostních upozorněních, která jsou přiložena k zařízení.</p> <p>USCHOVEJTE TYTO POKYNY</p>
Προειδοποίηση	<p>ΣΗΜΑΝΤΙΚΕΣ ΟΔΗΓΙΕΣ ΑΣΦΑΛΕΙΑΣ</p> <p>Αυτό το προειδοποιητικό σύμβολο σημαίνει κίνδυνο. Βρίσκεστε σε κατάσταση που μπορεί να προκαλέσει τραυματισμό. Πριν εργαστείτε σε οποιοδήποτε εξοπλισμό, να έχετε εξοικειωθεί με τις κινδύνους που σχετίζονται με τα ηλεκτρικά κυκλώματα και να έχετε εξοικειωθεί με τις συνήθειες πρακτικές για την αποφυγή ατυχημάτων. Χρησιμοποιήστε τον αριθμό δήλωσης που παραέχεται στο τέλος κάθε προειδοποίησης, για να εντοπίσετε τη μετάφρασή της στις μεταφρασμένες προειδοποιήσεις ασφαλείας που συνοδεύουν τη συσκευή.</p> <p>ΦΥΛΑΞΤΕ ΑΥΤΕΣ ΤΙΣ ΟΔΗΓΙΕΣ</p>
אזהרה	<p>הוראות בטיחות חשובות</p> <p>סימן אזהרה זה מסמל סכנה. אתה נמצא במצב העלול לגרום לפציעה. לפני שתעבוד עם ציוד כלשהו, עליך להיות מודע לסכנות הכרוכות במעגלים חשמליים ולהכיר את הנהלים המקובלים למניעת תאונות. השתמש במספר ההוראה המסופק בסופה של כל אזהרה כדי לאתר את התרגום באזהרות הבטיחות המתורגמות שמצורפות להתקן.</p> <p>שמור הוראות אלה</p>

Opomena	<p>ВАЖНИ БЕЗБЕДНОСНИ НАПАТСТВИЈА</p> <p>Симболот за предупредување значи опасност. Се наоѓате во ситуација што може да предизвика телесни повреди. Пред да работите со опремата, бидете свесни за ризикот што постои кај електричните кола и треба да ги познавате стандардните постапки за спречување на несреќни случаи. Искористете го бројот на изјавата што се наоѓа на крајот на секое предупредување за да го најдете неговиот период во преведените безбедносни предупредувања што се испорачани со уредот.</p> <p>ЧУВАЈТЕ ГИ ОВИЕ НАПАТСТВИЈА</p>
Ostrzeżenie	<p>WAŻNE INSTRUKCJE DOTYCZĄCE BEZPIECZEŃSTWA</p> <p>Ten symbol ostrzeżenia oznacza niebezpieczeństwo. Zachodzi sytuacja, która może powodować obrażenia ciała. Przed przystąpieniem do prac przy urządzeniach należy zapoznać się z zagrożeniami związanymi z układami elektrycznymi oraz ze standardowymi środkami zapobiegania wypadkom. Na końcu każdego ostrzeżenia podano numer, na podstawie którego można odszukać tłumaczenie tego ostrzeżenia w dołączonym do urządzenia dokumencie z tłumaczeniami ostrzeżeń.</p> <p>NINIEJSZE INSTRUKCJE NALEŻY ZACHOWAĆ</p>
Upozornenie	<p>DŮLEŽITÉ BEZPEČNOSTNÉ POKYNY</p> <p>Tento varovný symbol označuje nebezpečenstvo. Nachádzate sa v situácii s nebezpečenstvom úrazu. Pred prácou na akomkoľvek vybavení si uvedomte nebezpečenstvo súvisiace s elektrickými obvodmi a oboznámte sa so štandardnými opatreniami na predchádzanie úrazom. Podľa čísla na konci každého upozornenia vyhľadajte jeho preklad v preložených bezpečnostných upozorneniach, ktoré sú priložené k zariadeniu.</p> <p>USCHOVAJTE SI TENTO NÁVOD</p>
Opozorilo	<p>Ta naprava mora biti ozemljena. Nikoli ne odklapljajte ozemljitve oz. upravljajte naprave, ki ni primerno ozemljena. V primeru, da niste sigurni, ali imate primerno ozemljitev, nemudoma pokličite pooblaščen električni servis ali električarja.</p>
警告	<p>重要安全性指示</p> <p>此警告符號代表危險，表示可能造成人身傷害。使用任何設備前，請留心電路相關危險，並熟悉避免意外的標準作法。您可以使用每項警告後的聲明編號，查詢本裝置隨附之安全性警告譯文中的翻譯。</p> <p>請妥善保留此指示</p>

WARNING: When installing the product, please use the provided or designated connection cables/power cables/AC adapters. Using any other cables/adapters could cause a malfunction or a fire. Electrical Appliance and Material Safety Law prohibits the use of UL-certified cables (that have the “UL” shown on the code) for any other electrical devices than products designated by CISCO. The use of cables that are certified by Electrical Appliance and Material Safety Law (that have “PSE” shown on the code) is not limited to CISCO-designated products. Statement 371

WARNING: Read the wall-mounting instructions carefully before beginning installation. Failure to use the correct hardware or to follow the correct procedures could result in a hazardous situation to people and damage to the system. Statement 378

WARNING: To avoid electric shock, do not connect safety extra-low voltage (SELV) circuits to telephone-network voltage (TNV) circuits. LAN ports contain SELV circuits, and WAN ports contain TNV circuits. Some LAN and WAN ports both use RJ-45 connectors. Use caution when connecting cables. Statement 1021

WARNING: This equipment must be grounded. Never defeat the ground conductor or operate the equipment in the absence of a suitably installed ground conductor. Contact the appropriate electrical inspection authority or an electrician if you are uncertain that suitable grounding is available. Statement 1024

WARNING: If the symbol of suitability with an overlaid cross appears above a port, you must not connect the port to a public network that follows the European Union standards. Connecting the port to this type of public network can cause severe personal injury or can damage the unit. Statement 1031

WARNING: Connect the unit only to DC power source that complies with the safety extra-low voltage (SELV) requirements in IEC 60950 based safety standards. Statement 1033

WARNING: For connections outside the building where the equipment is installed, the following ports must be connected through an approved network termination unit with integral circuit protection: 10/100/1000 Ethernet. Statement 1044

WARNING: When installing or replacing the unit, the ground connection must always be made first and disconnected last. Statement 1046

WARNING: Do not locate the antenna near overhead power lines or other electric light or power circuits, or where it can come into contact with such circuits. When installing the antenna, take extreme care not to come into contact with such circuits, because they may cause serious injury or death. For proper installation and grounding of the antenna, please refer to national and local codes (for example, U.S.:NFPA 70, National Electrical Code, Article 810, Canada: Canadian Electrical Code, Section 54). Statement 1052

WARNING: No user-serviceable parts inside. Do not open. Statement 1073

WARNING: Installation of the equipment must comply with local and national electrical codes. Statement 1074

WARNING: Only trained and qualified personnel should be allowed to install, replace, or service this equipment. Statement 1030

WARNING: Read the installation instructions before connecting the system to the power source. Statement 1004

WARNING: Ultimate disposal of this product should be handled according to all national laws and regulations. Statement 1040

WARNING: The covers are an integral part of the safety design of the product. Do not operate the unit without the covers installed. Statement 1077

WARNING: Hot surface. Statement 1079

Searching Cisco Documents

To search an HTML document using a web browser, press **Ctrl-F** (Windows) or **Cmd-F** (Apple). In most browsers, the option to search whole words only, invoke case sensitivity, or search forward and backward is also available.

To search a PDF document in Adobe Reader, use the basic Find toolbar (**Ctrl-F**) or the Full Reader Search window (**Shift-Ctrl-F**). Use the Find toolbar to find words or phrases within a specific document. Use the Full Reader Search window to search multiple PDF files simultaneously and to change case sensitivity and other options. Adobe Reader's online help has more information about how to search PDF documents.



CHAPTER 2

Product Overview

This chapter provides an overview of the features available for the Cisco 807 Integrated Services Routers (ISRs) and contains the following sections:

- [Product Overview, on page 9](#)

Product Overview

This chapter provides an overview of the features available for the device and contains the following sections:

Hardware Overview

This section covers the overview of the IR807.

SKU Information

[Table 1: Supported SKUs for Cisco IR807s, on page 9](#) lists the different SKUs available for the Cisco 807 Integrated Services Router. All SKUs support external antenna.

Table 1: Supported SKUs for Cisco IR807s

SKU ID	Description	Modem Type
IR807G-LTE-VZ-K9	North America (Verizon)	WP7601
IR807G-LTE-NA-K9	North America (AT&T)	WP7504
IR807G-LTE-GA-K9	EMEA	WP7502







Note: The IR809G-LTE-VZ-K9 SKU has a single SIM card socket. The IR807G-LTE-NA-K9 and IR807G-LTE-GA-K9 are equipped with dual SIM card sockets. Graphics in this guide show the dual SIM SKUs.

Front Panel Icons and LEDs

The IR807 uses icons to show the different features of the device. [Table 2: Icons with LEDs, on page 10](#) shows Icons and their associated LEDs with descriptions. LEDs are visible from the top cover and from the

front panel. The LEDs allows easy visibility for wall and desk mounted installations regardless of chassis orientation. [Table 4: Icons only, on page 11](#) shows the Icons without associated LEDs and their descriptions.

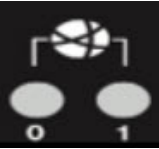
Table 2: Icons with LEDs

Icon	Description/Activity	Icon	Description/Activity
	System - Power and System Status. Off — No power Green Steady on — Normal operation Green Flashing — Boot up phase or in ROM Monitor mode Amber Steady on — Power is OK but possible internal FPGA program failure		Alarm - Alarm Input Status Off — Normal operation Red - Alarm State on the Alarm Input
	VPN Off — No VPN tunnel Steady Green — At least one VPN tunnel is up		User Configurable LED
	GPS - GPS Status Off — GPS not configured Steady Green — GPS configured Slow Flash — GPS Acquiring in Standalone GPS Fast Flash — GPS Acquiring in Assisted GPS Slow Flash is defined as the LED will be on for 0.25 seconds and off for 0.75 seconds. Fast Flash is defined as the LED will be on for 0.25 seconds and off for 0.25 seconds.		RJ45 Fast Ethernet Ports -Link Status 0:1 Off — No link Steady Green — Link is up Flashing — Transmitting and Receiving data
	RSSI - Received Signal Strength Indication The RSSI LEDs are a 3 LED bar graph to indicate signal strength. Their functionality is described in the RSSI LED Table 3: RSSI LEDs, on page 11 .		SIM Slots - SIM0/SIM1 Off — No USIM Green — USIM installed and active





Icon	Description/Activity	Icon	Description/Activity
			WWAN - Wireless WAN Activity Off — Offline On — In Service Flash (on 200ms off 5 sec) — No Service Flash (on 1 sec off 1 sec) — Low Power Mode Flash (on 5 sec off 200ms) — Roaming Flash (on 400ms off 100ms) — Data Active

Table 3: RSSI LEDs

RSSI	RSSI (2)	RSSI (1)	RSSI (0)
	Green	Green	Green/Amber
< -110dBm	Off	Off	Off
-110 to -90dBm	Off	Off	On - Amber
-90 to -75dBm	Off	Off	On - Green
-75 to -60dBm	Off	On - Green	On - Green
> -60dBm	On - Green	On - Green	On - Green

Table 4: Icons only

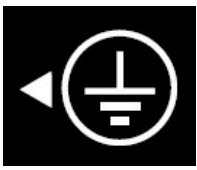
Icon	Description	Icon	Description
	Console		USB 2.0 Type A Port for Storage and Networking
	Grounding point (located on side of device)		Reset Button









Icon	Description	Icon	Description
	DC Power Input (12V to 48V)		DC Power Return
	Alarm Common		Alarm IN
	Serial Ports		Fast Ethernet Ports
	Antenna 1 (TNC) Main		Antenna 1 (TNC) Div
	Warning		

Figure 1: Cisco IR807 Front Panel, on page 13 shows the front panel details of the Cisco IR807.

Figure 1: Cisco IR807 Front Panel

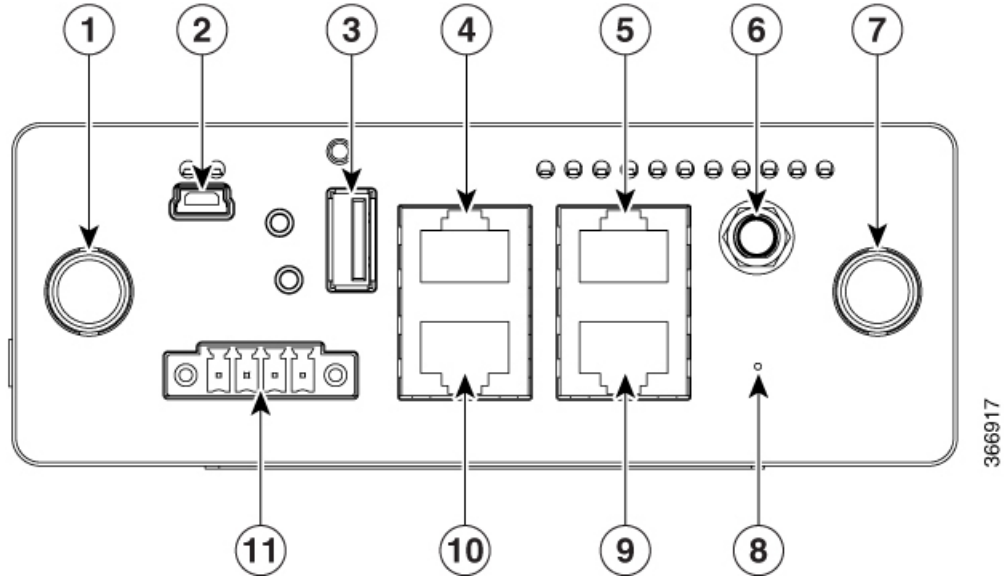

366917

1 Antenna 1 (TNC) MAIN	7 Antenna 2 (TNC) DIV
2 USB Console (Type B)	8 Reset Button
3 USB Type A	9 FE1 10/100 Base-T RJ-45
4 S0 (DTE)	10 S1 (DCE)
5 FE0 10/100 Base-T RJ-45	11 External DC Power Input and Alarm
6 GPS (SMA)	

Figure 2: Cisco IR807 Back Panel, on page 13 shows the back panels details of the Cisco IR807.

Figure 2: Cisco IR807 Back Panel

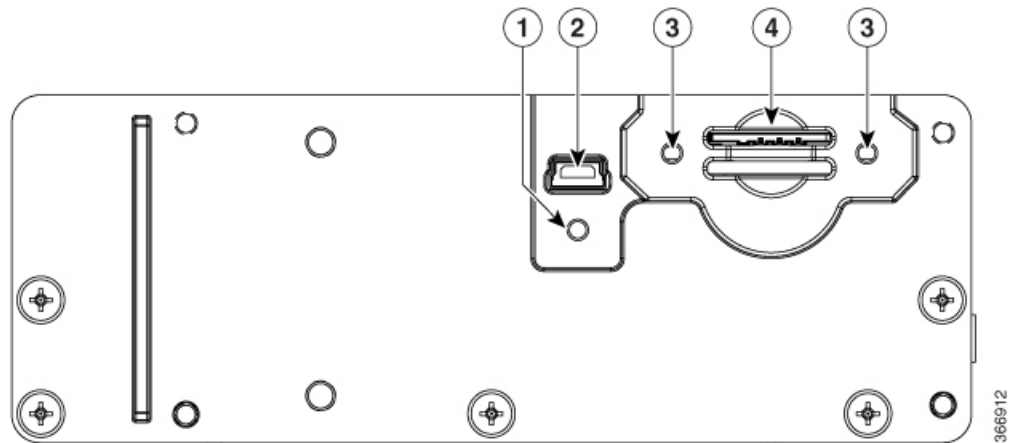

366912

1	Screw hole for protective cover over USB
2	USB Type B (under a protective cover) Reserved to be used with Modem for external provisioning.
3	Screw holes for protective cover over SIMs (one on each side)
4	SIM0 (bottom) and SIM1 (top) Slots

Memory

The Cisco IR807 uses flash memory and main memory. The flash memory contains the Cisco IOS software image and the boot flash contains the ROMMON boot code. All memory components are factory default and not upgradeable by the end user.

The following table shows the memory allocation.

Memory	Specification
Default and maximum DRAM	1GB
Default and maximum flash memory	4 GB eMMC

Antennas

The Cisco IR807 ships without antennas. All antennas are options that can be ordered separately.

There are two TNC connectors on the front side of the device. The TNC connectors are used to connect to the 4G modem. The SMA connector is for the GPS antenna.

NOTE: Before choosing your antenna type and installation scenario, read through the following information.

Supported Cisco Antennas and Cables

The following section lists the supported Antennas and Cables for the Cisco IR807. For detailed information about Cisco Antennas, please refer to the following guides:

Cisco Industrial Routers and Industrial Wireless Access Points Antenna Guide:

<http://www.cisco.com/c/en/us/td/docs/routers/connectedgrid/antennas/installing-combined/industrial-routers-and-industrial-wireless-antenna-guide.html>

Cisco Aironet Antennas and Accessories Reference Guide

http://www.cisco.com/c/en/us/products/collateral/wireless/aironet-antennas-accessories/product_data_sheet09186a008008883b.html

The following antennas and cables are available:

ANT-3-4G2G1-0

Description: Cisco Quinta 3 element 3-in-1 transportation antenna

- 2x 4G cellular, 1xGPS
- Color: Black radome
- RoHS compliant
- Environment: Outdoor

Electrical Specifications:

- Frequency ranges: 698 to 960 MHz and 1710 to 2700 MHz
- Typical gain (dBi): 698 to 960 MHz = 2.6 dBi, and 1710 to 2700 MHz = 4.6 dBi
- Efficiency: 60%
- Polarization: Linear and vertical
- Port impedance: 50 Ohms
- Voltage standing wave ratio (VSWR): < 2.1:1 (698 to 960 MHz) and < 2.0:1 (1710 to 2700 MHz)
- Radiation pattern: Omnidirectional
- Integrated RF cables: 2 ft, LMR-195 type, TNC (male)

GPS electrical specifications:

- Frequency range: 1575.42 MHz +/-1 MHz (GPS L1)
- Amplifier gain: 27dB +/-3dB
- Noise figure: 4dB max
- Port impedance: 50 Ohms
- Output VSWR: < 2.0:1
- Radiation pattern: RHCP
- DC voltage: 2.7–12V DC
- DC current: < 20 mA over -40 to 85°C temperature range
- Integrated RF cable: 17 ft, LMR-100 type, SMA(m)

Mechanical and environmental specifications:

- Mount style: Vehicular roof or similar; stud and nut mount
- Environment: Outdoor, vehicular roof, transportation ruggedized and qualified to subset of SAE1455 and MILSTD 810G
- Connectors: 2 x TNC(m) cellular and 1 x SMA(m) GPS
- Antenna dimensions: 7.1 in. diameter x 2.4 in. height (18.0 x 6.5 cm), excluding RF cables
- Weight: 1.48 lb (0.67 kg)
- Operating temperature range: -40 to 70°C
- Storage temperature: -40 to 85°C
- Maximum power: 10W
- Radome: Polycarbonate, UV, black
- Material substance compliance: ROHS compliant

ANT-4G-OMNI-OUT-N

Description: Cisco outdoor omnidirectional antenna for 2G, 3G, and 4G LTE cellular

- UV-stable radome
- Mast-mounting bracket
- Applicable for both 2G and 3G solutions
- Domestic LTE 700 band and global LTE 2600 band
- Domestic cellular and global GSM
- WiMAX 2300 and 2500

Electrical Specifications:

- Frequency ranges: 698 to 960 MHz, 1710 to 2170 MHz, and 2300 to 2700 MHz
- Nominal gain (dBi): 698 to 960 MHz = 1.5 dBi, and 1710 to 2700 MHz = 3.5 dBi

- 3 dB beam width (E plane): 698 to 960 MHz = 81 degrees, 1710 to 2170 MHz = 75 degrees, and 2300 to 2700 MHz = 100 degrees
- 3 dB beam width (H plane): 360 degrees, omnidirectional
- Polarization: vertical and linear
- Nominal impedance: 50 Ohms
- VSWR: < 2.5:1 (698 to 960 MHz) and < 2.0:1 (1710 to 2690 MHz)
- Radiation pattern: omnidirectional

Mechanical Specifications:

- Mount style: mast mount, upright position only
- Environment: outdoor
- Connector: N-type socket
- Antenna length (height): 9.8 x 1 in. (24.9 x 2.45 cm)
- Weight: 1.5 lb. (0.68 kg)
- Dimensions (H x Outside dimensions): 9.8 x 1 in. (248 x 24.5 mm)
- Operating temperature range: -22° to 158°F (-30° to 70°C)
- Storage temperature: -40° to 185°F (-40° to 85°C)
- Maximum power: 20W
- Radome: polycarbonate, UV, white
- Material substance compliance: ROHS compliant

ANT-4G-PNL-OUT-N

Description - Cisco multiband panel outdoor 4G LTE antenna:

- Supports 3G and 4G LTE solutions
- Multiband
- Wall mount and mast mount
- Indoor and outdoor
- Dual type-N socket connector

Electrical specifications:

- Frequency ranges: 698 to 960 MHz and 1710 to 2700 MHz
- VSWR: 2.0:1 maximum
- Gain: 5.5 to 10.5 dBi (698 to 960 MHz) and 6.5 to 9.0 dBi (1710 to 2700 MHz)
- 3-dB beam width (vertical plane): 55 to 70 degrees = 698 to 960 MHz, 53 to 98 degrees = 1710 to 2200 MHz, 60 to 70 degrees = 2200 to 2500 MHz, and 55 to 70 degrees = 2500 to 2700 MHz
- 3-dB beam width (horizontal plane): 55 to 70 degrees = 698 to 960 MHz and 50 to 90 degrees = 1710 to 2200 MHz
- F/B ratio: > 15 dB, typical 20 dB = 698 to 960 MHz, and > 17 dB, typical 23 dB = 1700 to 2700 MHz
- Isolation: > 30 dB
- Polarization: slant +/- 45 degrees
- Nominal impedance: 50 Ohms
- Radiation pattern: directional

Mechanical specifications:

- Mount style: wall or mast mount
- Environment: outdoor
- Connector: dual type N female (direct connect or dual 12 in (30 cm))

- Antenna length (height): 11.6" (2.95 cm)
- Temperature Range (Operating): -22 to 158-degrees F (-30 to 70° C)
- Storage temperature: -40 to +85° C
- Wind rating: 160 km/H
- IP rating: IP54
- Radome: polycarbonate, UV resistant, white
- Material substance compliance: ROHS compliant

ANT-4G-SR-OUT-TNC

Description - Cisco integrated 4G LTE low-profile outdoor saucer antenna:

- Applicable for both 3G and 4G LTE solutions
- Domestic LTE 700 band and global LTE 2600 band
- Domestic cellular and global GSM
- Weatherproof UV stable radome
- Performance optimized
- Excellent flame rating

Electrical specifications:

- Frequency ranges: 698 to 960 MHz and 1710 to 2700 MHz
- Peak gain with 1-ft cable: 1.5 dBi (698 to 960 MHz) and 3.7 dBi (1710 to 2700 MHz)
- Peak gain with 15-ft cable: 0.8 dBi (698 to 960 MHz) and 0.2 dBi (1710 to 2700 MHz)
- Average efficiency with 1-ft cable: 90% (698 to 960 MHz) and 82% (1710 to 2700 MHz)
- Average efficiency with 15-ft cable: 60% (698 to 960 MHz) and 40% (1710 to 2700 MHz)
- Nominal impedance: 50 Ohms
- VSWR (maximum): 2.0:1 (698 to 960 MHz) and 2.0:1 (1710 to 2700 MHz)

Mechanical specifications:

- H-plane 3 dB beam width: omnidirectional
- Polarization: linear and vertical
- Power: 3W
- Cable: 15-ft LMR 195
- RF connector: type N (f); TNC (plug) available
- Mount style: ceiling mount
- Radome: PC/ABS, UV stable, black
- Material substance compliance: RoHS compliant
- Operational temperature: -22° to 158°F (-30° to 70°C)
- Storage temperature: -40° to 185°F (-40° to 85°C)
- Environment: indoor
- Dimensions (H x Outside dimensions): 3.4 x 7.9 in. (87 x 200 mm)

ANT-4G-DP-IN-TNC

Description: Cisco indoor swivel-mount dipole antenna

- Low-profile blade style sheath
- Applicable for both 3G and 4G solutions
- Domestic LTE 700 and global LTE 2600 bands

- Domestic cellular and global GSM
- Conformance to RoHS
- Complete cellular and 4G data communications in a single antenna

Electrical Specifications:

- Operating frequency ranges: 698 to 806 MHz, 824 to 894 MHz, 880 to 960 MHz, 1710 to 1880 MHz, 1850 to 1990 MHz, 1920 to 2170MHz, 2100 to 2500 MHz and 2500 to 2690 MHz
- Peak gain: 0.5 dBi (698 to 960 MHz) and 2.2 dBi (1710 to 2700 MHz)
- Average efficiency: 55% (698 to 960 MHz) 73% (1710 to 2700 MHz)
- Maximum input power: 3 watts
- Voltage standing wave ratio (VSWR): < 2.5:1
- Characteristic impedance: 50 Ohms
- Polarization: linear

Mechanical Specifications:

- Type: dipole
- Antenna dimensions (L x W x D): 229 mm x 30.5 mm x 15 mm
- Mount style: direct mount
- Environment: indoor
- RF Connector: TNC (m)
- Antenna weight: 49 g
- Temperature rating: -31 to 158 degrees F (-35 to +70 degrees C)
- Material substance compliance: RoHS compliant

4G-LTE-ANTM-O-3-X

Description:

- Multiband low profile indoor or outdoor omnidirectional antenna (IP67 ingress protection)
- Ceiling mount, dual 4G LTE and standalone GPS

Electrical Specifications:

- Frequency range: 698 to 960 MHz and 1710 to 2700 MHz
- Gain: 2.5 dBi
- Maximum power: 3W
- Connector: SMA with TNC male adapters, and SMA for GPS
- VSWR: < 2.5:1
- Nominal impedance: 50 Ohms
- Polarization: linear vertical

Mechanical Specifications:

- Radome material: white, black, red, or blue ABS, UL-94 V0
- Cable: 4 ft RG174 VW-1 compliant
- Height and base diameter: 90 mm and 137 mm
- Temperature rating: -40° to 185°F (-40° to 85°C)
- Mounting: 5/8-inch lug with serrated face nut (5/8-inch diameter hole through mounting surface)
- Can be used with the following cable extensions: 4G-CAB-ULL-20 and 4G-CAB-ULL-50

4G-LTE-ANTM-0-3-X**Description:**

- Multiband low profile indoor or outdoor omnidirectional antenna (IP67 ingress protection)
- Ceiling mount, dual 4G LTE and standalone GPS

Electrical Specifications:

- Frequency range: 698 to 960 MHz and 1710 to 2700 MHz
- Gain: 2.5 dBi
- Maximum power: 3W
- Connector: SMA with TNC male adapters, and SMA for GPS
- VSWR: < 2.5:1
- Nominal impedance: 50 Ohms
- Polarization: linear vertical

Mechanical Specifications:

- Radome material: white, black, red, or blue ABS, UL-94 V0
- Cable: 4 ft RG174 VW-1 compliant
- Height and base diameter: 90 mm and 137 mm
- Temperature rating: -40° to 185°F (-40° to 85°C)
- Mounting: 5/8-inch lug with serrated face nut (5/8-inch diameter hole through mounting surface)
- Can be used with the following cable extensions: 4G-CAB-ULL-20 and 4G-CAB-ULL-50

4G-LTE-ANTM-D**Description:**

- Omnidirectional dipole antenna is designed for indoor use with Cisco 4G and Cisco 3G wireless Integrated Services Routers Generation 2 systems
- Articulating Joint —It can be rotated 360 degrees and is capable of maneuvering into three stop positions: 0 degrees, 45 degrees, and 90 degrees.
- Male threaded Neill-Concelman (TNC) Connector —It lets you directly mount the antenna to any Cisco 4G and Cisco 3G wireless Integrated Services Router (ISR) EHWIC with a TNC connector (Cisco 4G-LTE-ANTM-D Omnidirectional Dipole Antenna, TNC Connector, and Articulation Joint). The threads on the connector must comply with the ANSI 7/16-28 UNEF 2B thread specification.

Electrical Specifications:

- Frequency range:
 - 698–806 MHz
 - 824–894 MHz
 - 925–960 MHz
 - 1710–1885 MHz
 - 1920–1980 MHz
 - 2110–2170 MHz
 - 2500–2690 MHz
- Maximum input power: 3W
- Connector: TNC male
- VSWR: 2.5:1 or less

- Nominal impedance: 50 Ohms
- Maximum Peak Gain: 2 dBi

Mechanical Specifications:

- Antenna base and radome color: Cisco Raven Black
- Dimensions: 9 (L) x 1.2 (W) x 7/16 in (D) (229 x 30.5 x 11 mm)
- Temperature rating: -22° to 158°F (-30° to 70°C)

Antenna Extension 4G-AE015-R**Description:**

- Single-unit antenna extension base (15 ft [457.2 cm])

Electrical Specifications:

- Frequency range: 6 GHz
- Attenuation: less than 3 dB at or below 2.5 GHz
- Base connector: TNC socket
- Pigtail connector: TNC plug

Mechanical Specifications:

- Base material: Cisco gray UL94 V0 PC/ABS plastic
- Dimensions: 2.8 x 2.4 x 1.8 in. (7.1 x 6.1 x 4.6 cm)
- Weight: 6 oz. (0.17 kg)
- Cable: 15 ft. (457.2 cm) non-plenum rated Pro-Flex Plus 195

Antenna Extension 4G-AE010-R**Description:**

- Single-unit antenna extension base (10 ft. [304.8 cm], one cable included)

Electrical Specifications:

- Frequency range: 6 GHz
- Attenuation: less than 3 dB at or below 2.5 GHz
- Base connector: TNC socket
- Pigtail connector: TNC plug

Mechanical Specifications:

- Base material: UL 94 V0PC and ABS plastic
- Dimensions: 2.8 x 2.4 x 1.8 in. (7.1 x 6.1 x 4.6 cm)
- Weight: 6 oz. (0.17 kg)
- Cable: 10 ft. (304.8 cm) non-plenum rated Pro-Flex Plus 195

Modem Support

The Cisco IR807 uses the WP7502, WP7504, and WP7601 series modems. The software download page can be found here:

<https://software.cisco.com/download/navigator.html?mdfid=286288566&flowid=76082>

Region/Carrier	Modem Used	4G/LTE	3G UMTS/HSPA	2G GSM/GPRS/EDGE
US / Verizon	WP7601	700 MHz (band 13) 1700/2100 MHz (band 4 AWS)	N/A	N/A
North America/ AT&T	WP7504	700 MHz (band 17) 1900 MHz (band 2 PCS) 1700/2100 MHz (band 4 AWS) 1850-1915 (band 25) 814-849 (band 26)	850 MHz (band 5) 1900 MHz (band 2)	850 MHz 1900 MHz
EMEA	WP7502	800 MHz (band 20) 900 MHz (band 8) 1800 MHz (band 3) 2100 MHz (band 1) 2600 MHz (band 7)	850 MHz 900 MHz 1900 MHz 2100 MHz	850 MHz 900 MHz 1900 MHz 2100 MHz

Power Supply

The Cisco IR807 comes with an external DC power connector. The 4-pin power entry connector (receptacle) is mounted to the unit. The 4-pin power entry mating connector (plug) is attached to the receptacle. It is removed during installation and used to connect to the DC power source, then reattached to provide power to the unit.

Refer to [Figure 3: Power Connector Pin-Outs, on page 21](#) for the location and values of the power connector.

Figure 3: Power Connector Pin-Outs

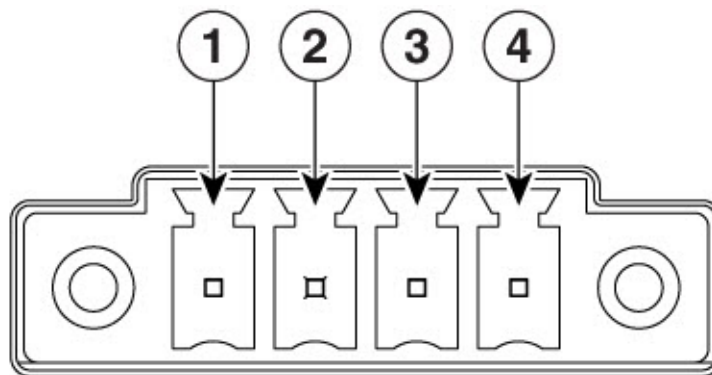

366912

Pin Number	Name	Description	Color
1	DC In +	DC Power Positive Input	Red
2	DC In -	DC Power Return	Black
3	ALM REF	Alarm Common	N/A
4	ALM IN	Alarm Input	N/A

RJ45 Ports

The IR807 supports two **ISOLATED** RS232 ports which conforms to EIA-561 standard. RS232 pin out is shown in the following figure applies to serial 0 and serial 1, but the directions of the DTE and DCE port are opposite.

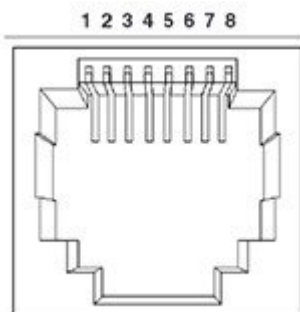

The RS232 DTE pin out applies to both serial 0 and serial 1. This port is not shared with the Console port.

Note: The RS232 DTE pin out is different from the Cisco standard Console/Auxiliary port.

The following figure shows the characteristics of the S0 and S1 ports:

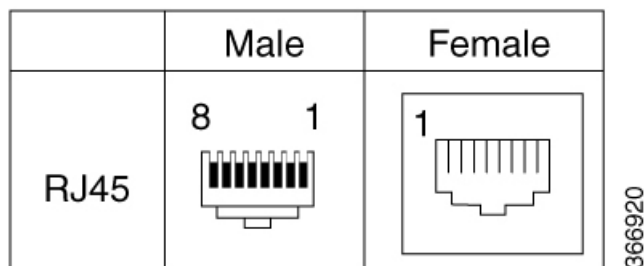

The following table shows the S0 and S1 Details

Pin Number	Description	Abbreviation	DTE	DCE
1	DCE Ready, Ring Indicator	DSR/RI	<—	—>
2	Received Line Signal Detector	DCD	<—	—>

Pin Number	Description	Abbreviation	DTE	DCE
3	DTE Ready	DTR	—>	<—
4	Signal Ground	COM		
5	Received Data	RxD	<—	—>
6	Transmitted Data	TxD	—>	<—
7	Clear To Send	CTS	<—	—>
8	Request To Send	RTS	—>	<—

Accessories

See the following table for a partial listing of IR807 Accessories.

Cisco Part Number	Accessory
PWR-IE50W-AC	DIN-rail mount AC/DC power supply - Input AC 100-240V/1.25A or Input DC 125-250V/1A, Output DC 24V/2.1A
IR807-DINRAIL(=)	Din rail kit and mounting screws for horizontal mounting
IR807-VM-DINRAIL(=)	Din rail kit and mounting screws for vertical mounting
IR807-WALLMNT(=)	Wall mount kit and mounting screws
CAB-CONSOLE-USB 37-1090-01	Cisco USB Type A Male to Mini B Male 6ft Console Cable

- Depending on your particular model of the router, there will be either a single hole or double hole grounding.
- 53-100629-01 - Contains Getting started with the Cisco 807 Integrated Services Router document, associated hardware, and the single hole grounding kit.
- 53-100797-01 - Contains Getting started with the Cisco 807 Integrated Services Router document, associated hardware, and the two hole grounding kit.



CHAPTER 3

Installing the Router

This chapter describes the equipment and the procedures for successfully installing the IR807 and contains the following sections:

- [Installing the Router, on page 25](#)

Installing the Router

This chapter describes the equipment and the procedures for successfully installing the IR807 and contains the following sections:

Before installing the IR807, make sure you have read and understood all of the information included in the documentation included with the product. An on-line version is also available here:

<http://www.cisco.com/c/dam/en/us/td/docs/routers/access/800/807/GettingStarted/78-101247.pdf>

CAUTION: Do not install the router or power supplies next to a heat source of any kind, including heating vents.

WARNING: Read the installation instructions before connecting the system to the power source. Statement 1004

WARNING: Only trained and qualified personnel should be allowed to install, replace, or service this equipment. Statement 1030

WARNING: No user-serviceable parts inside. Do not open. Statement 1073

WARNING: Ultimate disposal of this product should be handled according to all national laws and regulations. Statement 1040

WARNING: Do not locate the antenna near overhead power lines or other electric light or power circuits, or where it can come into contact with such circuits. When installing the antenna, take extreme care not to come into contact with such circuits, because they may cause serious injury or death. For proper installation and grounding of the antenna, please refer to national and local codes (for example, U.S.:NFPA 70, National Electrical Code, Article 810, Canada: Canadian Electrical Code, Section 54). Statement 1052

WARNING: This product is not intended to be directly connected to the Cable Distribution System. Additional regulatory compliance and legal requirements may apply for direct connection to the Cable Distribution System. This product may connect to the Cable Distribution System ONLY through a device that is approved for direct connection. Statement 1078

Equipment, Tools, and Connections

This section describes the equipment, tools, and connections necessary for installing your device. It contains the following topics:

Items Shipped with your Router

Unpack the box and verify that all items listed on the invoice were shipped with the Cisco 807 ISR.

The following items are shipped with your router:

- IR807 Printed Document Of Compliance
- Grounding Lug Kit
- Power Connector

Additional Items

The following items are not shipped with the router but are required for installation:

- Screws for mounting the router on a wall.
- Wire crimper for chassis grounding.
- Wire for connecting the chassis to an earth ground.
- Ethernet cables for connecting devices to the Ethernet ports.
- Ratcheting torque flathead screwdriver that exerts up to 15 in-lb (1.69 N-m) of pressure.
- A number-2 Phillips screwdriver.

Ethernet Devices

Identify the Ethernet devices that you will connect to the router: hub, servers, and workstations or PCs. Ensure that each device has a network interface card (NIC) for connecting to Ethernet ports.

Installing the Router

This section describes how to install the Cisco 807 ISR. This router can be installed on a table top or other flat horizontal surface, mounted on a wall, or DIN rail.

The recommended clearance when horizontally mounted is 1 inch on non-connector sides and 2 inches on bottom. Stacking heat-dissipating objects on top of the router is not allowed. I/O side clearance is needed as it is required to access the cable connections.

Clearance is required to attach, mount the DIN rail bracket, and Wall mount bracket. The same clearances apply when mounted vertically.

This section also describes how to attach external antennas to the routers and contains the following topics:

Warnings

WARNING: For NEC-compliant grounding, use size 14 AWG (1.6mm) or larger copper wire and a ring terminal with an inner diameter of 1/4 in. (5 to 7 mm).

Accessing the SIM Slots

Two USIM sockets are provided with easy access via a secured panel on the back side of the router. The SIM Slots will be connected directly to the 4G radio.

Note: The IR800 series of routers use the Mini-SIM (2FF). Specifications are:

- ISO/IEC 7810:2003, ID-000
- Length - 25mm, Width - 15mm, Thickness - 0.76mm

This section describes how to install and/or replace a SIM card. Ensure that the router is not mounted to a wall, floor, or DIN rail.

CAUTION: Do not touch any part of the exposed PCB circuit area when the SIM cover is removed.

WARNING: The covers are an integral part of the safety design of the product. Do not operate the unit without the covers installed. Statement 1077

WARNING: Hot surface. Statement 1079

To access the SIM card in the Cisco IR807, follow these steps:

1. Power off the router and disconnect the power cable from the power source.
2. Place the router on its bottom and ensure that any installed antennas are carefully oriented or disconnected to be out of the way.
3. Remove the protective cover (1) over the SIM slots by unscrewing the screws and setting them aside.

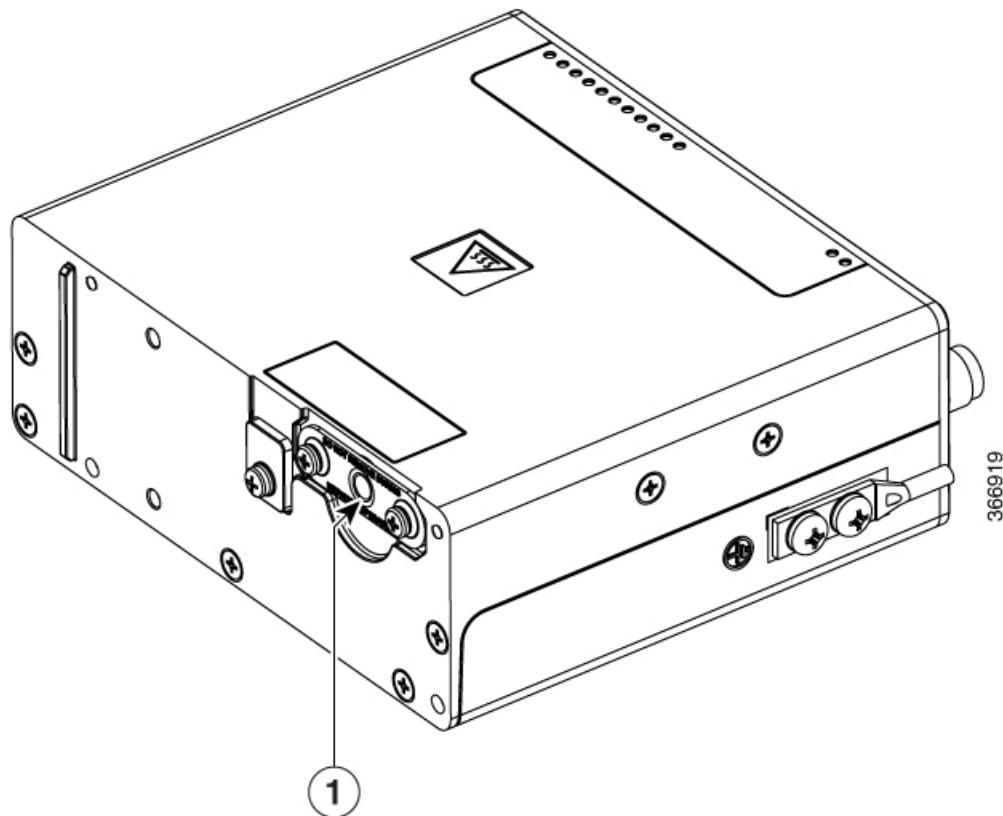

1. Locate the SIM card you wish to install/replace. SIM0 is the bottom and SIM1 is the top. The following figure shows the slots with the protective cover removed.

Note: The IR807G-LTE-GA-K9 and IR807G-LTE-NA-K9 will have 2 SIM slots. The IR807G-LTE-VZ-K9 has only 1 slot.

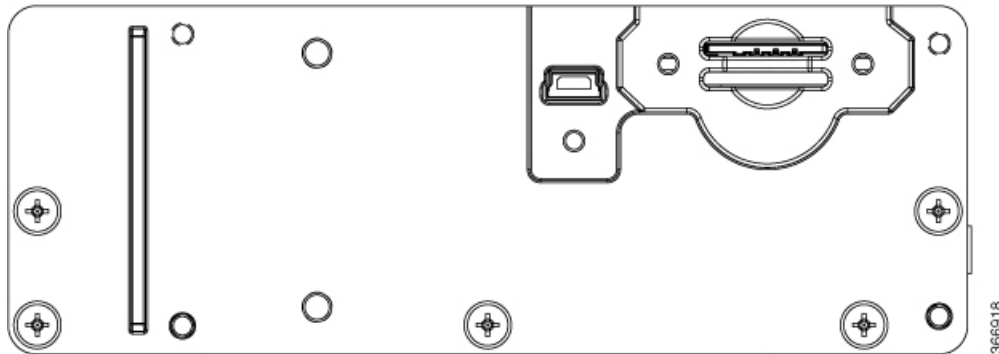

1. If SIM card is present, then push the SIM card to eject it out of the slot. Install the new SIM card by pushing it into the slot until you hear a clicking sound.
2. Replace the protective cover and the screws.

Modems

The Cisco IR807 uses the WP7502, WP7504, and WP7601 series modems:

Product	Carrier/Region	Modem Used	4G/LTE Bands Supported	3G UMTS Bands Supported	2G GSM/CDMA Bands supported
IR807-LTE-GA-K9	EMEA	WP7502	1, 3, 7, 8, 20	1, 8	E-GSM 900DCS 1800
IR807-LTE-NA-K9	North America/AT&T	WP7504	2, 4, 5, 12, 17, 25, 26	2, 4, 5	CDMA BC0,BC1BC1-
IR807-LTE-VZ-K9	Verizon, USA	WP7601	4, 13	N/A	N/A

Installing Antennas

There are two TNC connectors on the device. The TNC connectors are used to connect to the 4G modem. The SMA connector is for the GPS antenna.

Orient the antennas. For optimum wireless performance, the antennas should be perpendicular with respect to the floor.

If the router is being mounted on a desk, orient the antennas straight up.

To attach the radio antennas to your wireless router, follow these steps:

1. Manually screw the antenna tight to the TNC connectors on the front of the router.
2. Orient the antennas. For optimum wireless performance, antennas should be generally perpendicular to each other.

Dual Antennas

In all cases, an antenna must be connected to the main port. It is highly recommended in order to achieve optimal performance that a second antenna is connected to the diversity port:

- Sierra Wireless WP7xxx modem series supports SIMO on LTE. WCDMA UMTS HSPA DC-HSPA+ is diversity only, without SIMO.
- The IR807 must be installed with 2 antennas (Main & Aux) to guarantee the best performance level. Using a single antenna may impact downlink performance by a minimum of 3dB, and can be much more (10-20dB) due to multipath fading (destructive interference between direct and reflected radio waves).
- In case of 3G UMTS, a solo antenna would not be able to switch to the diversity port.

Mounting on a Wall, Table, or Other Flat Surface

The Cisco IR807 can be mounted in a vertical or horizontal orientation. It can be mounted to a wall or other flat surface, and can also be mounted to a DIN rail.

TIP: When choosing a location for wall-mounting the router, consider cable limitations and wall structure.

WARNING: Read the wall-mounting instructions carefully before beginning installation. Failure to use the correct hardware or to follow the correct procedures could result in a hazardous situation to people and damage to the system. Statement 378

To mount the router on a wall or other flat surface, follow these steps:

1. Mark the location for the mounting brackets to attach to the wall. The dimensions are described in [Figure 4: Wall Mount Dimensions](#), on page 29.

Figure 4: Wall Mount Dimensions

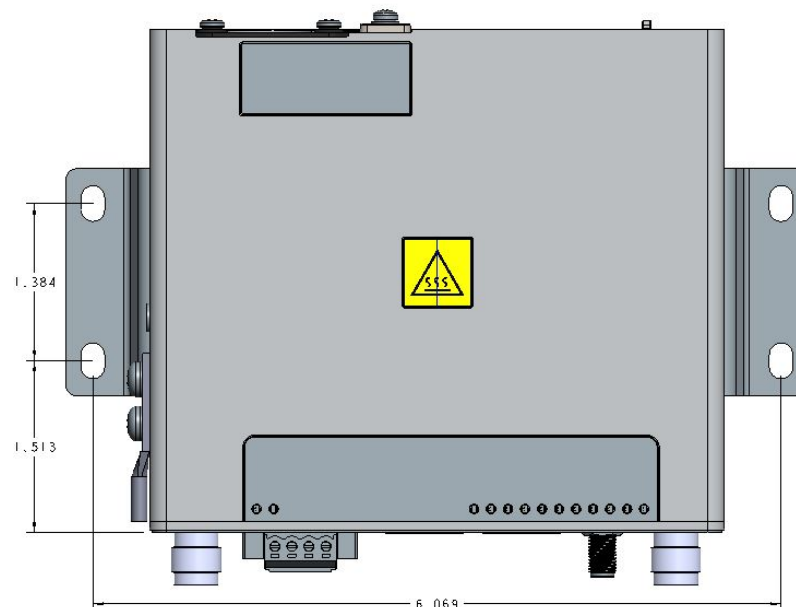

NOTE: For hollow-wall mounting, each bracket requires two wall anchors with washers. Wall anchors and washers must be size number 10.

1. Attach the mounting brackets to the bottom of the router.
2. Align the mounting brackets over the mounting holes so that the larger holes on the brackets extend out over the router.
3. Attach the brackets to the router with the 4 screws provided using a Phillips head driver. Torque to 13-15 in-lbs.

4. Mount the router with the attached brackets to the wall using screws that are adequate for your mounting area.
5. Route the cables so that they do not put a strain on the connectors or mounting hardware.

Installing a DIN Rail

The DIN Rail kit is ordered separately.

The DIN Rail can be installed in two different orientations, horizontally and vertically. There are two different mounting kits; IR807-DINRAIL(=) for horizontal mounting, and IR807-VM-DINRAIL(=) for vertical mounting.

To attach the DIN rail bracket to the Cisco IR807, follow these steps.

Mounting the DIN Rail Bracket on the Router

1. First, attach the DIN rail bracket to the back of the router. The DIN rail bracket mounts in two different ways, depending on the orientation you wish to use. See [Figure 5: Attaching the DIN Rail Bracket for vertical mounting, on page 30](#) for vertical orientation, and [Figure 6: Attaching the DIN Rail Bracket for horizontal mounting, on page 31](#) for horizontal orientation.

Figure 5: Attaching the DIN Rail Bracket for vertical mounting

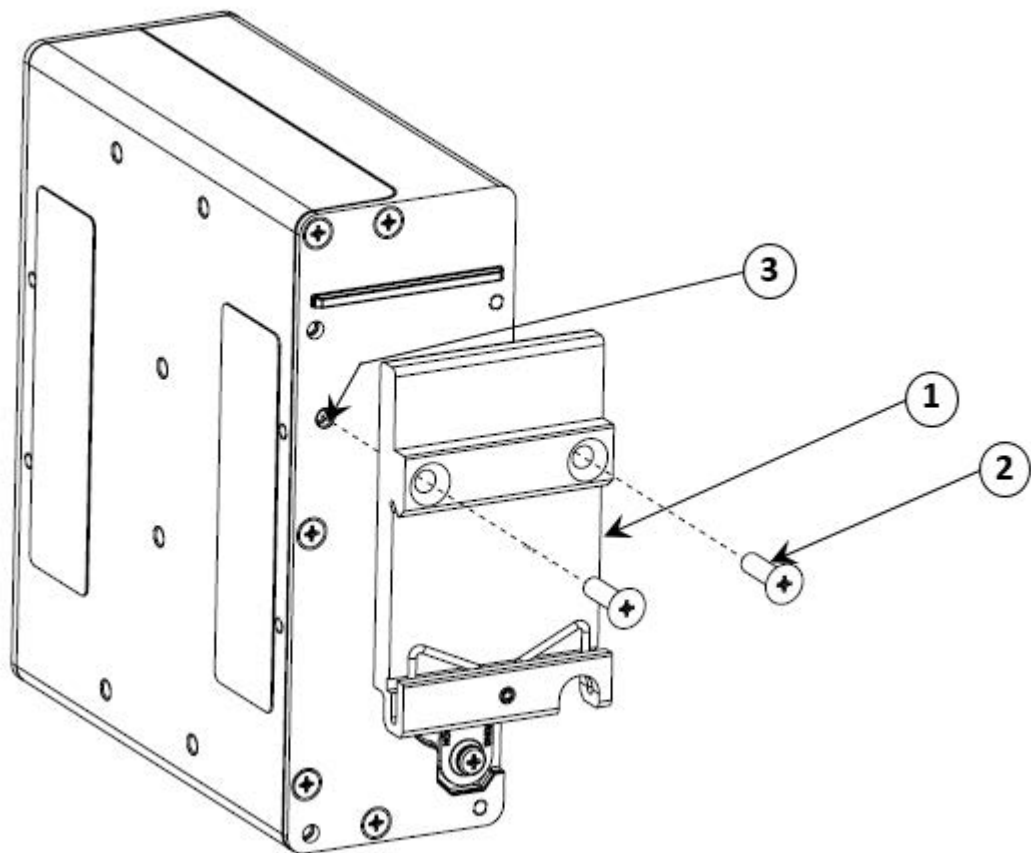
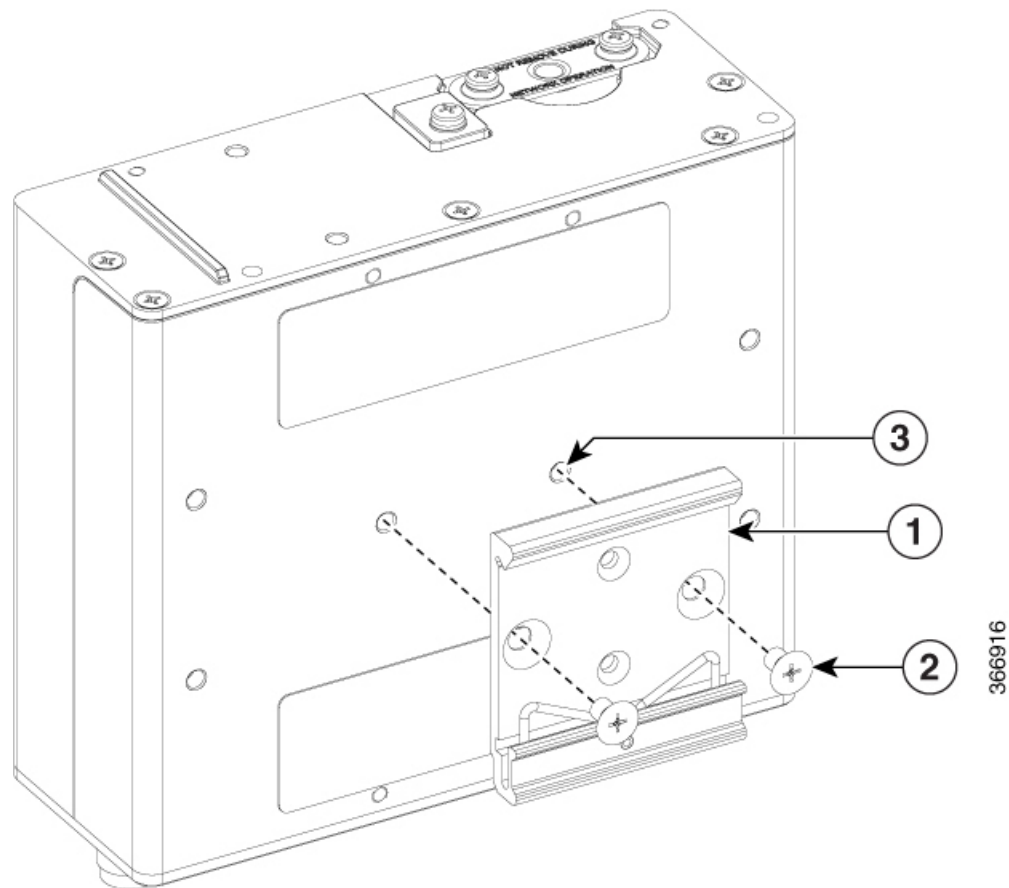

Figure 6: Attaching the DIN Rail Bracket for horizontal mounting



1. Attach the DIN mounting bracket (1) to the router using the two screws provided in the kit (2). Position the bracket over the two mounting holes (3) that correspond to your orientation. Then use 13-15 in-lbs pounds of torque to screw the bracket onto the router.
2. Once the bracket is attached to the router, it can be mounted onto the DIN Rail.

Attaching the Bracket onto the DIN Rail

To attach the Cisco IR807 with the bracket to a DIN rail, follow these steps. Refer to [Figure 7: Attaching the Bracket to the DIN Rail, on page 32](#) for details.



Note The rail is 35mm wide and can be either 7.5 or 15mm high.

Figure 7: Attaching the Bracket to the DIN Rail

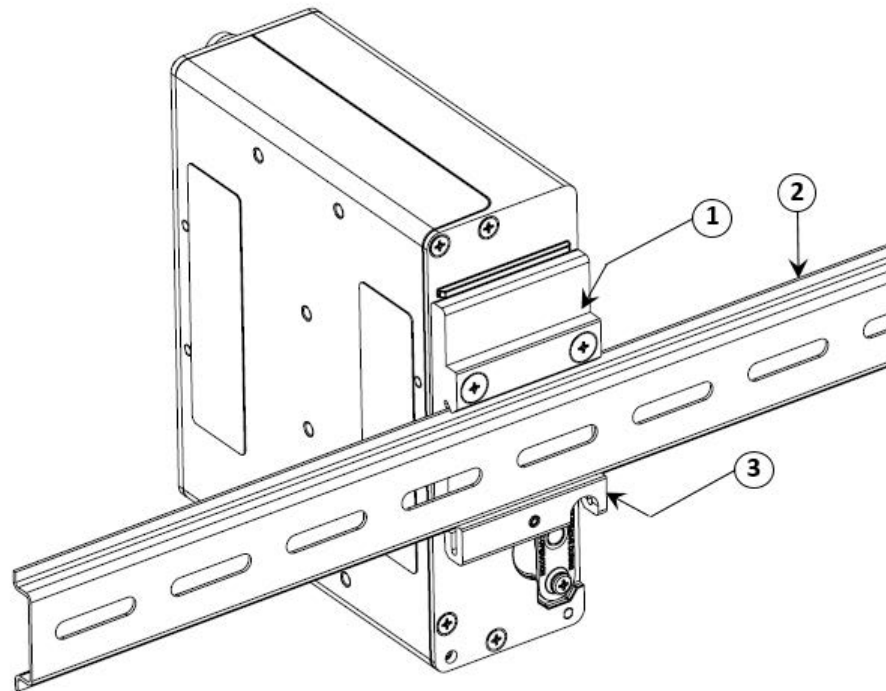

1. Position the router so that the spring of the Din clip (1) rest on the Din rail (2).
2. Push up the router so that the spring of the Din clip (1) compresses and the top hook of the Din clip (3) slides and clamps to the Din rail (2).
3. To remove the router from the DIN Rail, simply reverse the procedure.



Note The procedure to attach the unit to the rail is the same with both orientations.

Installing the Router Ground Connection

The router must be connected to a reliable earth ground. Install the ground wire in accordance with local electrical safety standards.

- For NEC-compliant grounding, use size 14 AWG (1.6mm) or larger copper wire and a ring terminal with an inner diameter of 1/4 in. (5 to 7 mm).
- For EN/IEC 60950-1 compliant grounding, use size 18 AWG (1.02mm) or larger copper wire.

WARNING: This equipment must be grounded. Never defeat the ground conductor or operate the equipment in the absence of a suitably installed ground conductor. Contact the appropriate electrical inspection authority or an electrician if you are uncertain that suitable grounding is available. Statement 1024

NOTE: Depending on the kit shipped with your router, the grounding lug may have one hole or two holes.

CAUTION: Cable distribution system should be grounded (earthed) in accordance with ANSI/NFPA 70, the National Electrical Code (NEC), in particular Section 820.93, Grounding of Outer Conductive Shield of a Coaxial Cable.

To install the ground connection, follow these steps:

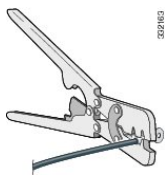
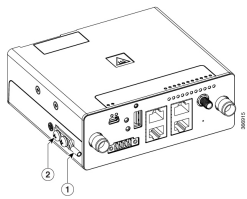
1.	Locate the ring terminal lug and screws in the packaging kit. Store the ground screws for later use.	
2.	Use a wire stripping tool to strip the 14 or 18 AWG (1.6mm or 1.02mm) grounding wire to 0.22 in. (5.56 mm).	
3.	Insert the ground wire into the ring terminal lug, and using a crimping tool, crimp the terminal to the wire.	
4.	Insert the ground screws (2) into the grounding lug (1) shown in the graphic and attach the lug to the router. NOTE: if your grounding lug is a single hole type, attach it in the same manner as the dual hole using the first hole from the front panel.	
5.	Use a ratcheting torque screwdriver to tighten the ground screw and ring terminal to the router side panel to 3.5 in-lb (0.4 N-m). The torque should not exceed 3.5 in-lb (0.4 N-m).	
6.	Attach the other end of the ground wire to a grounded bare metal surface, such as a ground bus, a grounded DIN rail, or a grounded bare rack.	



CHAPTER 4

Connecting the Router

This chapter describes how to connect Cisco IR807 Integrated Services Router to Ethernet devices and a network.

- [Connecting the Router, on page 35](#)

Connecting the Router

This chapter describes how to connect Cisco IR807 Integrated Services Router to Ethernet devices and a network. The chapter contains the following sections:

Preparing to Connect the Router

Before you connect the router to the devices, install the router according to the instructions in [Chapter 3, “Installing the Router”](#).

Preventing Damage to the Router

Before installation, observe these general guidelines:

- Proper ESD protection should be observed
- Ensure the router is properly grounded
- Ensure there is proper airflow around the router

If you must supply your own cable, see the [“Technical Specifications” section on page -41](#) for cabling specifications. If this appendix does not provide specifications for a particular cable, we strongly recommend ordering the cable from Cisco.

Connecting a Terminal or PC to the Console Port

The IR807 provides a mini type B USB console port. Connect a terminal or PC to the Console port either to configure the software by using the CLI or to troubleshoot problems with the router.

To connect a terminal or PC to the Console port on the router and access the CLI, follow these steps:

1. Connect the mini-USB console cable to the console port on the router. [Figure 8: Connecting a Terminal or PC to the Console Port, on page 36](#) shows the console location on the router.
1. Connect the opposite end of the mini-USB cable to the USB port on your laptop or PC.

2. To communicate with the router, wait for your laptop or PC to discover the new device.
3. If your laptop or PC warns you that you do not have the proper drivers to communicate with the router, you can obtain them from your computer's manufacturer, or go here: <https://www.silabs.com/developers/usb-to-uart-bridge-vcp-drivers>

Note: If you are connecting to the USB port:

- - a connection (to the USB port) can only be made in a non-hazardous environment
- - the USB port cover must be reinstalled before the router can be deployed in a hazardous environment

Figure 8: Connecting a Terminal or PC to the Console Port

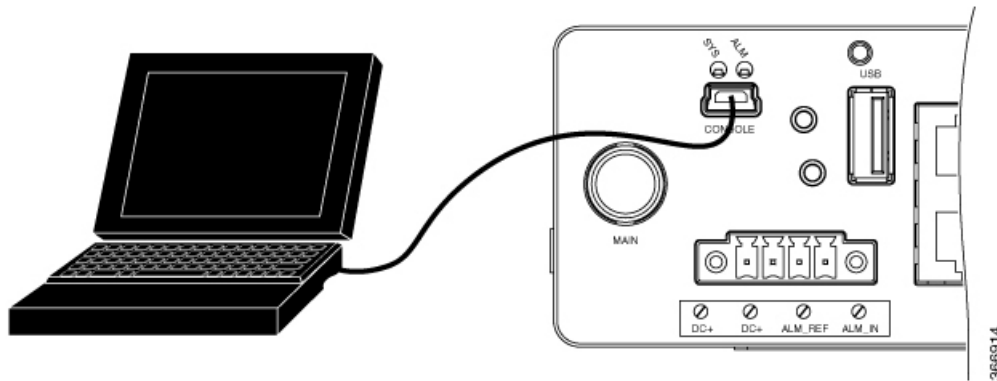

Connecting to DC Power

WARNING: This product relies on the building's installation for short-circuit (overcurrent) protection. Ensure that the protective device is rated not greater than 10A Statement 1005

WARNING: This product requires short-circuit (overcurrent) protection, to be provided as part of the building installation. Install only in accordance with national and local wiring regulations. Statement 1045

WARNING: Connect the unit only to DC power source that complies with the safety extra-low voltage (SELV) requirements in IEC 60950 based safety standards. Statement 1033.

Plugs and Pin-Outs

The IR807 ships with a DC power accessory kit.

The power entry receptacle is on the IR807. The pin-outs are shown in [Figure 9: Power Connector Pin-Outs, on page 37](#).

Figure 9: Power Connector Pin-Outs

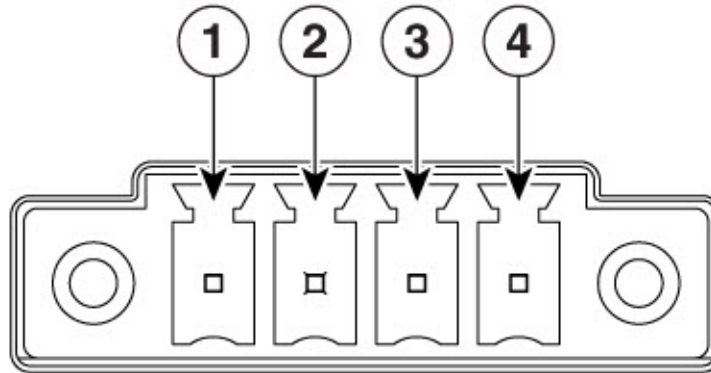

366912

Table 5: Pinout Descriptions

Pin Number	Name	Description	Color
1	DC In +	DC Power Positive Input	Red
2	DC In -	DC Power Return (GND-)	Black
3	AC	Alarm Common	N/A
4	AI	Alarm Input	N/A

Wiring the DC Power and Alarm Connections

To connect the DC power and alarm connections on the IR807, follow these steps:

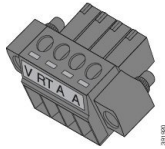
1.	<p>Locate the power and alarm connector on the router front panel.</p> <p>NOTE: Your connector may not have the labels V RT A A.</p> <p>In the labeled connector, the pins are:</p> <p>V—Positive DC power connection</p> <p>RT—Return DC power connection</p> <p>A— Alarm Common</p> <p>A— Alarm Input</p>	
----	--	---

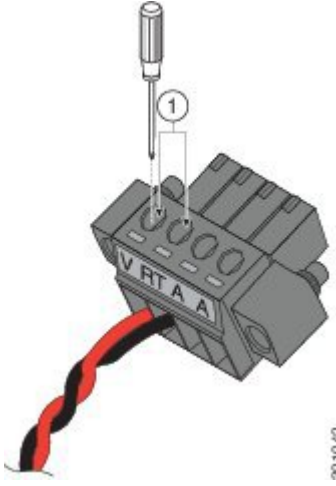
2.	<p>Identify the connector positive and return DC power connections. The connections left to right are:</p> <p>1—Positive DC power connection 2—Return DC power connection 3—Alarm Common 4—Alarm Input</p>	
3.	<p>Measure two strands of twisted-pair copper wire (18-to-20 AWG) long enough to connect to the DC power source.</p>	
4.	<p>Using an 18-gauge wire-stripping tool, strip each of the two twisted pair wires coming from each DC-input power source to 0.25 inch (6.3 mm) \pm 0.02 inch (0.5 mm). Do not strip more than 0.27 inch (6.8 mm) of insulation from the wire. Stripping more than the recommended amount of wire can leave exposed wire from the power connector after installation.</p>	 <p>333004</p>
5.	<p>Remove the two captive screws that attach the power and alarm connector to the router, and remove the connector.</p>	
6.	<p>On the power and alarm connector, insert the exposed part of the positive wire into the connection labeled "V" and the exposed part of the return wire into the connection labeled "RT". Make sure that you cannot see any wire lead. Only wire with insulation should extend from the connector.</p> <p>NOTE: Use the same method for wiring the alarm connections.</p>	 <p>381942</p> <p>1—Power connector captive screws</p>

7.	Use a ratcheting torque flathead screwdriver to torque the power connector captive screws (above the installed wire leads) to 2 in-lb (0.23 N-m).
8.	Connect the other end of the positive wire to the positive terminal on the DC power source, and connect the other end of the return wire to the return terminal on the DC power source. Connect the other end of the Alarm wires to your alarm source.

Verifying Connections

To verify that all devices are properly connected to the router, first turn on all the connected devices, then check the LEDs. To verify router operation, refer to the [Front Panel Icons and LEDs, page 10](#).



CHAPTER 5

Technical Specifications

Provides router, port, cabling specifications, and power adapters for the device.

- [Router Specifications, on page 41](#)

Router Specifications

The following information lists the operational limits of the Cisco IR807. Operating the router outside of the limits specified is not supported.

Table 6: Physical Characteristics

Description	Design Specification
Dimensions (H x W x D)	(height x width x depth x) are 1.85" x 5.07" x 4.50" (4.69 x 12.85 x 11.43 cm).

Table 7: Environmental Operating Ranges

Description	Design Specification
Operating Temperature and Altitude	-40° to 140°F (-40° to 60°C) in a sealed NEMA cabinet with no airflow -40° to 158°F (-40° to 70°C) in a vented cabinet with 40 lfm of air -40° to 167°F (-40° to 75°C) in a forced air enclosure with 200 lfm of air (type tested at +85C for 16 hours) NOTE: This product has been safety certified up to 60C maximum ambient. -500 to 5,000 feet. Derate max operating temperature 1.5°C per 1000 feet. 10,000 ft maximum
Operating Altitude	13,800 ft. (4206m)
Humidity	5% — 95% non-condensing

Table 8: Environmental Tests

Description	Design Specification
Vibration	IEC 61850-3, IEEE 1613
Shock	Half Sine (operating) Duration = <2 ms Velocity = 2.39 m/s Number of shocks: A series of 6 shocks, one on each side. IEEE 1613 and IEC61850-3 NUP T2 shock testing, non-NEBS 3396

Table 9: Certifications

Description	Design Specification
Standard Safety Certifications	UL 60950-1, 2nd edition CAN/CSA C22.2 No. 60950-1, 2nd edition EN 60950-1, 2nd edition CB to IEC 60950-1, 2nd edition with all group differences and national deviations
EMC Emissions	EN55022/CISPR22, CFR 47 Part 15, ICES003, VCCI-V-3, AS/NZS CISPR22, CNS13438, EN300-386, EN61000-3-2, EN61000-3-3, and EN55032/CISPR32
EMC Immunity	EN55024/CISPR24, (EN61000-4-2, EN61000-4-3, EN61000-4-4, EN61000-4-5, EN61000-4-6, EN61000-4-11), EN55035/CISPR35, and EN300-386
Cellular Radio	EN 301 908-1, EN 301 908-2, EN 301 511, and EN 301 908-13
Compliance	IP30 compliant when vertical and cables downward.
Radio Immunity	EN301 489-1, EN 303 413, EN 301 489-19, EN 301 489-52, and EN 62311

Table 10: Transportation/Storage Conditions

Description	Design Specification
Temperature	-40 to +85°C (-40 to +185°F)
Humidity	10 – 95%
Altitude	4570 m (15,000 ft)

Table 11: Router DC Power Adapter

Description	Design Specification
Input Voltage	Nominal voltage: 12V to 48V DC Absolute: 9.6 to 60V DC input
Maximum Power Consumption	10 Watts

Table 12: Country Marks

Description	Design Specification
Country marks	FCC, CE, BSMI, IC

Table 13: Hazardous Locations

Description	Design Specification
Hazardous Locations	<ul style="list-style-type: none"> • ANSI/ISA 12.12.01 (Gas groups A-D) • CSA 22.2 No 213 (Gas groups A-D) • UL/CSA 60079-0, -15 (Class I, Zone 2, Gas groups IIC) • IEC 60079-0, -15 IECEx test report • EN 60079-0, -15 ATEX certification (Class I, Zone 2, Gas groups IIC)

