



IRM-1100-4A2T Expansion Module

This chapter contains the following sections:

- [IRM-1100-4A2T Overview, on page 1](#)
- [Installing the IRM-1100-4A2T Expansion Module, on page 3](#)
- [Guidelines and Limitations, on page 3](#)
- [Deployment Scenarios, on page 4](#)
- [Inventory Details based on Deployment, on page 7](#)
- [Gigabit Ethernet Switch Ports, on page 8](#)
- [LEDs, on page 8](#)
- [Async Ports, on page 10](#)
- [GPIO Configuration Pins, on page 12](#)
- [Configuration Examples for Additional Async Interfaces, on page 14](#)
- [Scada Protocol Translations, on page 15](#)
- [Serial Relay, on page 17](#)
- [Using the WebUI to Configure Async Ports, on page 18](#)

IRM-1100-4A2T Overview

The IRM-1100-4A2T is an expansion module that can be attached to the IR1101. It offers an additional four asynchronous serial ports and two Ethernet interfaces to the IR1101. The following graphic shows the IRM-1100-4A2T.



The IRM-1100-4A2T Ethernet interfaces are Layer 2 RJ45 10/100/1000 Mbps ports.

The IRM-1100-4A2T serial ports are RJ45 combo ports (RS232/RS485/RS422).

The IR1101 has two sides that expansion modules mount to. The top is called the Expansion side, and the bottom is called the Compute side. If the additional module is connected to the top, then it is referenced as the Expansion Module (EM) side. If the additional module is connected on the bottom, then it is referenced as the Compute Module (CM) side. Functionality differs depending on which side the expansion module is attached to, and how many and type of expansion modules are in use.



Note For more information, see the [Installing the IRM-1100-4A2T Expansion Module, on page 3](#) section.

The IRM-1100-4A2T can be managed from the following tools:

- Cisco DNA Center
- WebUI

Router Switch Path

The switch path that is detected on the platform, is based on the type of additional module connected on the Expansion module (EM) side. Refer to the following table:

Additional Module	Switch Path
No Module Connected	IR1101-ES-5
IRM-1100-SPMI	IR1101-ES-6S
IRM-IR1100-4A2T	IR1101-ES-7G



Note When an IRM-IR1100-4A2T is connected on both sides of the IR1101-K9, there is a maximum of nine Async interfaces which can be enumerated. The switch path for the IR1101-K9 will be IR1101-ES-7G.

Serial Port Pinouts and Characteristics

The serial ports are intended as a DCE port, capable of both RS232 and RS485. RS485 can support full or half duplex.

The RJ45 pinouts are shown in the following figure and table:

Figure 1: Pinouts

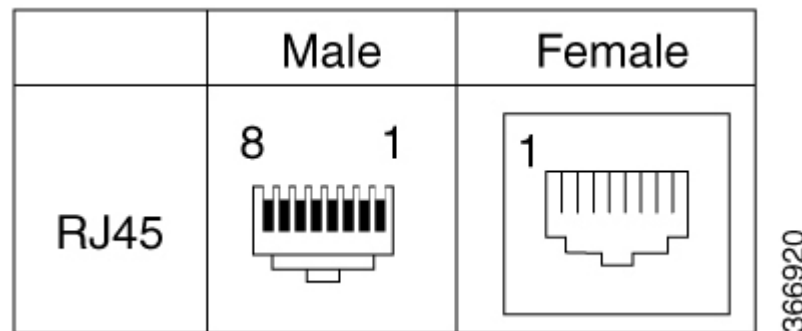

Table 1: Serial Port Characteristics

RS232					RS485 Full Duplex		RS485 Half Duplex	
Pin #	Signal Description	Abbr.	S0 (DTE)	S1 (DCE)	Signal	DIR	Signal	Direction
1	DCE ready. Used as DSR in Cisco IOS.	DSR/RI	Input	Output	TX-	Output	TX/RX+	<->
2	Received Line Signal Detector	DCD	Input	Output	TX+	Output	TX/RX-	<->
3	DTE Ready	DTR	Output	Input	RX-	Input	—	—
4	Signal Ground	COM	—	—	COM	—	COM	—
5	Received Data	RxD	Input	Output	—	—	—	—
6	Transmitted Data	TxD	Output	Input	RX+	Input	—	—
7	Clear To Send	CTS	Input	Output	—	—	—	—
8	Request To Send	RTS	Output	Input	—	—	—	—

Installing the IRM-1100-4A2T Expansion Module

This chapter contains the following sections:

Guidelines and Limitations

The IRM-1100-4A2T has the following guidelines and limitations:

- Available with IOS-XE release 17.7.1
- Supports four deployment scenarios
- No support for OIR
- Ethernet ports are L2 switchport only
- Switchports will not work if anything is connected to the Compute module (bottom) side

Both the IRM-1100-SPMI Expansion Module and the IRM-1100-4A2T Expansion Module have the following guidelines and limitations:

- The CAT18 LTE module is not supported on the Compute module (bottom) side
- MSATA and GPIO pins are not supported when attached to the Compute Module side.

- The IR1101 can only support a maximum of two LTE interfaces. This means connecting an Expansion Module with LTE interfaces on both the EM and CM side is not supported. If connected, only the EM side will be active.

Deployment Scenarios

The IRM-1100-4A2T supports four different deployment scenarios. This section discusses the differences in functionality between the four.

Interface numbering are enumerated based on the deployment of the IRM-1100-4A2T module.

Scenario One

In this scenario, the IRM-1100-4A2T is mounted on the Expansion side, or the top. See the following figure:



In this configuration, you get full functionality out of the Serial and Ethernet ports. There is support for 4 additional Async interfaces, and 2 Gigabit ethernet interfaces.

Interface numbering in this scenario is as follows:

- async 0/3/0 (corresponding line is: line 0/3/0) [Serial]
- async 0/3/1 (corresponding line is: line 0/3/1) [Serial]
- async 0/3/2 (corresponding line is: line 0/3/2) [Serial]

- async 0/3/3 (corresponding line is: line 0/3/3) [Serial]
- gigabitethernet 0/0/5 [Layer 2]
- gigabitethernet 0/0/6 [Layer 2]

Scenario Two

In this scenario, the IRM-1100-4A2T is mounted on the Compute side, or the bottom. In addition, the solution also has the IRM-1100-SPMI expansion module mounted on the Expansion side, or the top. See the following figure:

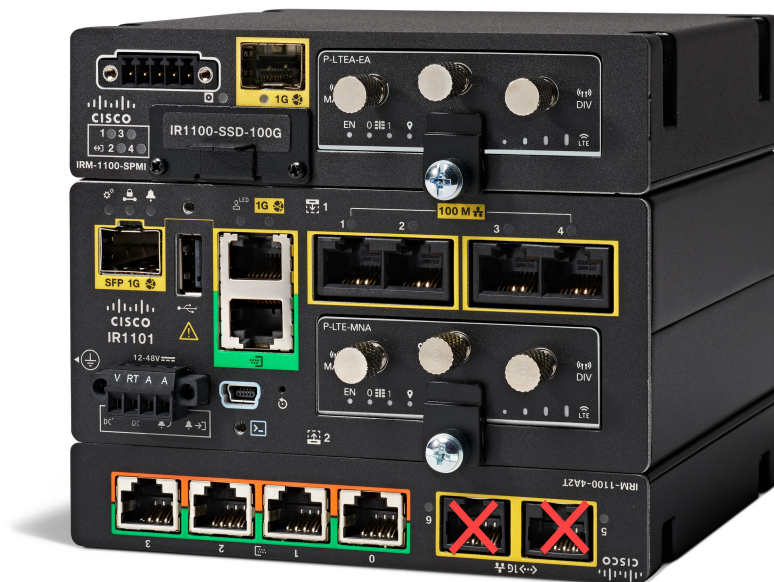

In this configuration, the ethernet ports on the IRM-1100-4A2T will not function. The serial ports have full functionality.

There is support for 4 Async interfaces and no support for additional layer 2 interfaces.

Interface numbering in this scenario is as follows:

- async 0/4/0 (corresponding line is: line 0/4/0) [Serial]
- async 0/4/1 (corresponding line is: line 0/4/1) [Serial]
- async 0/4/2 (corresponding line is: line 0/4/2) [Serial]
- async 0/4/3 (corresponding line is: line 0/4/3) [Serial]

Scenario Three

In this scenario, the IRM-1100-4A2T is mounted on the Expansion side, or the top. In addition, the configuration also has the IRM-1100-SPMI expansion module mounted on the Compute side, or the bottom. See the following figure:



In this configuration, the IRM-1100-4A2T is mounted on the Expansion side, or top, and has full functionality. The SFP port on the IRM-1100-SPMI mounted on the Compute side, or bottom, will not function.

Interface numbering in this scenario is as follows:

- Async 0/3/0 – 0/3/3 [Connected on EM side]
- Async 0/4/0 – 0/4/3 [Connected on CM side]
- Gi0/0/5 and Gi0/0/6 [Layer 2 interfaces from EM side]
- LTE interface on CM side, cellular 0/4/0 and cellular 0/4/1

Scenario Four

In this scenario, there are two IRM-1100-4A2T expansion modules mounted on both the Expansion side and the Compute side. See the following figure:



In this configuration, the IRM-1100-4A2T mounted on the Expansion side, or top, has full functionality. The Ethernet ports on the IRM-1100-4A2T mounted on the Compute side, or bottom, will not function.

There is support for 8 more Async interfaces, and 2 Gigabit ethernet interfaces.

Interface numbering in this scenario is as follows:

- Async 0/3/0 – 0/3/3 [Connected on EM side]
- Async 0/4/0 – 0/4/3 [Connected on CM side]
- Gi0/0/5 and Gi0/0/6 [Layer 2 interfaces from EM side]

Inventory Details based on Deployment

The output to the **show inventory** command will show different details based upon which side of the IR1101 base unit it is attached to.

```
Router#sh inv
+++++
INFO: Please use "show license UDI" to get serial number for licensing.
+++++

NAME: "Chassis", DESCR: "IR1101 Base Chassis"
PID: IR1101-K9          , VID: V03  , SN: FCW2452P561

NAME: "Module 0 - Mother Board", DESCR: "Cisco IR1101 motherboard"
PID: IR1101-K9          , VID: V03  , SN: FOC245126XR

NAME: "module subslot 0/0", DESCR: "IR1101-ES-7G"
```

```

PID: IR1101-ES-7G      , VID: V01  , SN:

NAME: "module subslot 0/4", DESCR: "P-LTE-MNA Module"
PID: P-LTE-MNA        , VID: V01  , SN: FOC24230U79

NAME: "Modem on Cellular0/4/0", DESCR: "Sierra Wireless WP7610"
PID: WP7610          , VID: 10000, SN: 356307100162618

NAME: "Module 2 - Compute Module", DESCR: "IR1100 expansion module with Pluggable slot,
SFP, mSATA SSD slot and Digital GPIO"
PID: IRM-1100-SPMI    , VID: V02  , SN: FCW2502PAP0

NAME: "Module 3 - Expansion Module", DESCR: "IR1100 expansion module with 4 Async ports and
2 copper ports"
PID: IRM-1100-4A2T    , VID: V00  , SN: FOC25150ZRJ

```

```

Router# sh ip int bri
Interface          IP-Address      OK? Method Status          Protocol
GigabitEthernet0/0/0 unassigned      YES NVRAM    administratively down down
FastEthernet0/0/1  unassigned      YES unset      administratively down down
FastEthernet0/0/2  unassigned      YES unset      administratively down down
FastEthernet0/0/3  unassigned      YES unset      administratively down down
FastEthernet0/0/4  unassigned      YES unset      down            down
GigabitEthernet0/0/5 unassigned      YES unset      administratively down down
GigabitEthernet0/0/6 unassigned      YES unset      down            down
Cellular0/1/0      unassigned      YES NVRAM    administratively down down
Cellular0/1/1      unassigned      YES NVRAM    administratively down down
Async0/2/0          unassigned      YES unset      up              up
Async0/3/0          unassigned      YES unset      up              ip
Async0/4/0          unassigned      YES unset      administratively down down
Async0/3/1          unassigned      YES unset      administratively down down
Async0/4/1          unassigned      YES unset      administratively down down
Async0/3/2          unassigned      YES unset      administratively down down
Async0/4/2          unassigned      YES unset      administratively down down
Async0/3/3          unassigned      YES unset      administratively down down
Async0/4/3          unassigned      YES unset      administratively down down
Vlan1               unassigned      YES unset      up              down

```

Gigabit Ethernet Switch Ports

The Ethernet ports are Layer 2 RJ45 10/100/1000 Mbps ports.

The base router (IR1101) GE port is named `gigabitethernet 0/0/0`. When the IRM-1100-4A2T is mounted on the Expansion side, or top, two additional ports are available:

- `gigabitethernet 0/0/5`
- `gigabitethernet 0/0/6`

LEDs

There are two LEDs on the front associated with the two Ethernet ports (5 and 6). See the following figure:

Figure 2: Ethernet Port LEDs

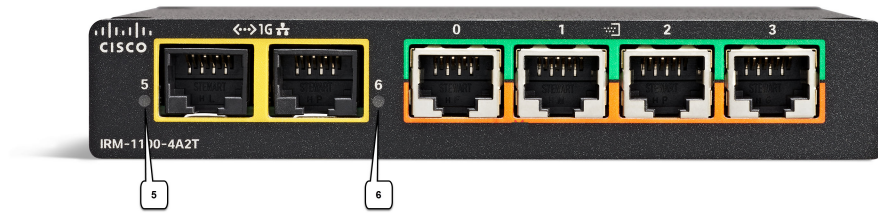

See the following table for the LED functionality:

Color/State	Description
Green	Port link, no activity
Flashing Green	Link healthy with activity
Off	No link

LED status is also available through the command line:

```
Router# show led

SYSTEM LED : Green

Custom LED : Off

VPN LED : Off

ALARM LED : Off

GigabitEthernet0/0/0 LED : On
FastEthernet0/0/1 LED : On
FastEthernet0/0/2 LED : Off
FastEthernet0/0/3 LED : Off
FastEthernet0/0/4 LED : Off
GigabitEthernet0/0/5 LED : On
GigabitEthernet0/0/6 LED : Off

*Cellular 0/1*
LTE module Enable LED : Green
LTE module SIM 0 LED : Off
LTE module SIM 1 LED : Off
LTE module GPS LED : Off
LTE module RSSI 0 LED : Off
LTE module RSSI 1 LED : Off
LTE module RSSI 2 LED : Off
LTE module RSSI 3 LED : Off
```

Async Ports

IOS-XE release 17.7.1 software provides support for an additional module (IRM-1100-4A2T) that has 4 Async ports and 2 gigabit ethernet interfaces. The software enumerates the interface numbers depending on which side of the Base IR1101 the expansion module is attached to.

The base router (IR1101) async port is async 0/2/0, with the out of bound management port being async 0/2/1.

When the IRM-1100-4A2T is mounted on the Expansion side, or top, the async ports are numbered as:

- async 0/3/0 (corresponding line is: line 0/3/0)
- async 0/3/1 (corresponding line is: line 0/3/1)
- async 0/3/2 (corresponding line is: line 0/3/2)
- async 0/3/3 (corresponding line is: line 0/3/3)

When the IRM-1100-4A2T is mounted on the Compute side, or bottom, the async ports are numbered as:

- async 0/4/0 (corresponding line is: line 0/4/0)
- async 0/4/1 (corresponding line is: line 0/4/1)
- async 0/4/2 (corresponding line is: line 0/4/2)
- async 0/4/3 (corresponding line is: line 0/4/3)

The async ports on the IRM-1100-4A2T support:

- media-type RS232 (DCE) and RS485 (RS422 and RS485 share the same configuration)
- full-duplex/half-duplex

Serial RJ45 Pin-Outs

All Serial ports can be in three operational modes:

- RS232
- RS485 Full Duplex
- RS485 Half Duplex

All ports follow the RS232 signal standard, with a max baud rate of 115Kbps supported. The following table shows pinouts for the four ports:

Pin Number	Description	Mode	Direction
1	Data Set Ready	DCE	OUT
2	DCD/Ring	DCE	OUT
3	Data Terminal Ready	DCE	IN

Pin Number	Description	Mode	Direction
4	Signal Ground	—	—
5	Receive Data	DCE	OUT
6	Transmit Data	DCE	IN
7	Clear to Send	DCE	OUT
8	Request to Send	DCE	IN

DCE Interface Configuration Steps

The default interface configuration for all ports on the serial expansion module is RS232. If the interface is configured for media-type RS485, the default configuration is in full-duplex mode.

- The configuration of Gi0/0/5 and Gi0/0/6 are similar to the L2 ports in the IR1101 base unit.
- The async ports support both RS232 and RS485/full/half-duplex. Additionally, "media-type", "full-duplex", and "half-duplex" are supported on the expansion module, compared to the async 0/2/0 in the IR1101 base unit.

Default Configuration

The default configuration for all ports of the serial expansion module is RS232.

```
Router#sh run int Async0/3/0
Building configuration...

Current configuration : 92 bytes

interface Async0/3/0
no ip address
encapsulation scada
shutdown
media-type rs232
```

Configuration Example for Media-Type RS232

The CLI **media-type ?** shows rs232 and rs485 available.

```
Router(config)#int Async0/3/3
Router(config-if)#media
Router(config-if)#media-type ?
  rs232 Set RS232 media type
  rs485 Set RS485 media type
```

Configure the media-type for RS232.

```
Router(config-if)#media-type rs232
Router(config-if)#no shut
Router(config-if)#end
```

```
Router#sh run int Async0/3/3
Building configuration...
!
```

```

Current configuration : 82 bytes
!
interface Async0/3/3
 no ip address
 encapsulation scada
 media-type rs232
 end

```

Configuration Example for Media-Type RS485

Configure the media-type for RS485.

```

Router#conf t
Enter configuration commands, one per line.
Router(config)#int Async0/3/0
Router(config-if)#media
Router(config-if)#media-type rs485
Router(config-if)#end

```

```

Router# sh run int Async0/3/0

```

```

Building configuration...

```

```

Current configuration : 105 bytes
!
interface Async0/3/0
 no ip address
 encapsulation scada
 shutdown
 media-type rs485
 full-duplex
 end

```

Configuration Example for Media-Type RS485 (half-duplex)

Configure the media-type for RS485 running half duplex.

```

Router(config)#int Async0/4/2
Router(config-if)#media
Router(config-if)#media-type rs485
Router(config-if)#half-duplex
Router(config-if)#end

```

```

Router#sh run int Async0/4/2

```

```

Building configuration...

```

```

Current configuration : 105 bytes
!
interface Async0/4/2
 no ip address
 encapsulation scada
 shutdown
 media-type rs485
 half-duplex

```

GPIO Configuration Pins

The IRM-1100-4A2T has four Async ports that send signals to hardware using GPIO pins, through which media-type and duplex settings are configured. The following are examples of standard signals if GPIO pin is set to '6' configured as RS232, '4' configured as RS485 full-duplex and 'C' configured as RS485 half-duplex.

```
Router#sh controllers Async0/3/0
Line: 0/3/0(74) Interface:Async0/3/0
State=6 encapsulation=95 speed=9600 maxmtu=1500
Duplex=0 ACCM_TX=0xFFFFFFFF ACCM_RX=0xFFFFFFFF
Max_idle=10 frame_size=100
Buffered bytes=0 tty capabilities=0x8 tty statbits=0x40 databits=8
TX packet cnt:0 Scattered: 0 Particle cnt:0 Request cnt:0
PPP in total:0
PPP Rx head:0x0 tail:0x0
GPIO read: 6666
```



Note Based on the above output, all the Async ports 0/3/0 to 0/3/3 are configured with default media-type RS232.

```
Router#sh controllers Async0/4/2
Line: 0/4/2(100) Interface:Async0/4/2
State=6 encapsulation=95 speed=9600 maxmtu=1500
Duplex=0 ACCM_TX=0xFFFFFFFF ACCM_RX=0xFFFFFFFF
Max_idle=10 frame_size=100
Buffered bytes=0 tty capabilities=0x8 tty statbits=0x40 databits=8
TX packet cnt:0 Scattered: 0 Particle cnt:0 Request cnt:0
PPP in total:0
PPP Rx head:0x0 tail:0x0
GPIO read: 6C66
```



Note Based on the above output, Async port 0/4/2 is configured with RS485 Half-duplex, and remaining ports Async0/4/0,0/4/1 and 0/4/3 are configured with default media-type RS232.

```
Router# sh controllers Async0/3/3
Line: 0/3/3(77) Interface:Async0/3/3
State=4 encapsulation=97 speed=9600 maxmtu=1500
Duplex=0 ACCM_TX=0xFFFFFFFF ACCM_RX=0xFFFFFFFF
Max_idle=10 frame_size=100
Buffered bytes=0 tty capabilities=0x8 tty statbits=0x440 databits=8
TX packet cnt:0 Scattered: 0 Particle cnt:0 Request cnt:0
PPP in total:0
PPP Rx head:0x0 tail:0x0
GPIO read: 4666
```



Note Based on the above output, Async port 0/3/3 is configured with RS485 Full-duplex, and the remaining ports Async0/3/0, Async0/3/1 and Async0/3/2 are configured with default media-type RS232.

Debug Commands

There is a debug command available for troubleshooting the GPIO configuration:

```
Router# debug condition interface <ASYNC_INTERFACE_SLOT> event
```



Note This command is not supported for the Async 0/2/0 interface.

Configuration Examples for Additional Async Interfaces

Further information can be found in the [Raw Socket Transport](#) chapter of the IR1101 Rugged Series Router Software Configuration Guide

Raw-TCP Multi-hop (daisy chain)

For raw-tcp, the user needs to configure encapsulation raw-tcp under the Async interface, and needs to configure associated line interface either as server or client. Maximum number of sessions per server is 32.

Figure 3: Raw-TCP Multi-hop Example

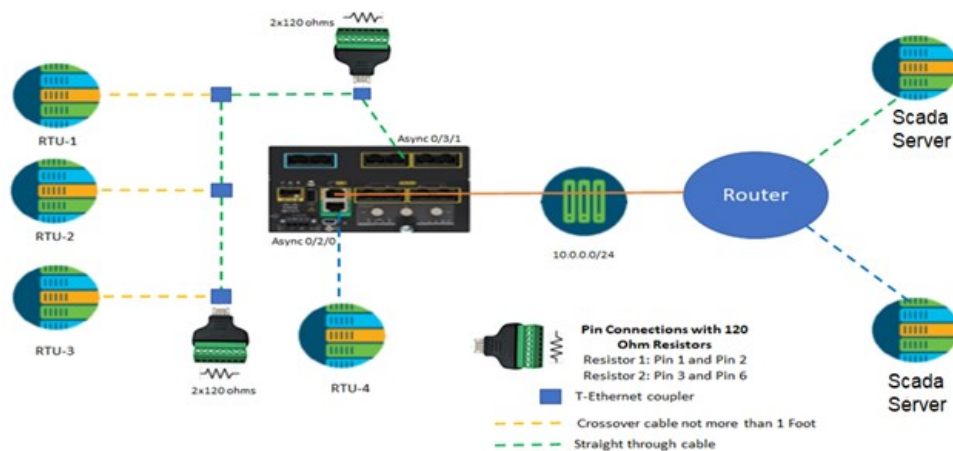

The following is an example configuration for two routers as shown above.

IR1101	Other Router
	Note Can be any IOS-XE router or IOS router, that supports at least 2 serial interfaces.
<pre> int Async0/2/0 encapsulation raw-tcp no shut int Async 0/3/1 encapsulation raw-tcp media-type rs485 full-duplex no shut line 0/2/0 raw-socket tcp client 10.0.0.2 6000 10.0.0.1 6001 line 0/3/1 raw-socket tcp client 10.0.0.2 5000 10.0.0.1 5001 </pre>	<pre> int Async 0/2/0 encapsulation raw-tcp no shut int Async 0/2/1 encapsulation raw-tcp no shut line 0/2/0 raw-socket tcp server 6000 line 0/2/1 raw-socket tcp server 5000 </pre>

Raw-UDP Multi-hop (daisy chain)

Figure 4: Raw-UDP Multi-hop Example

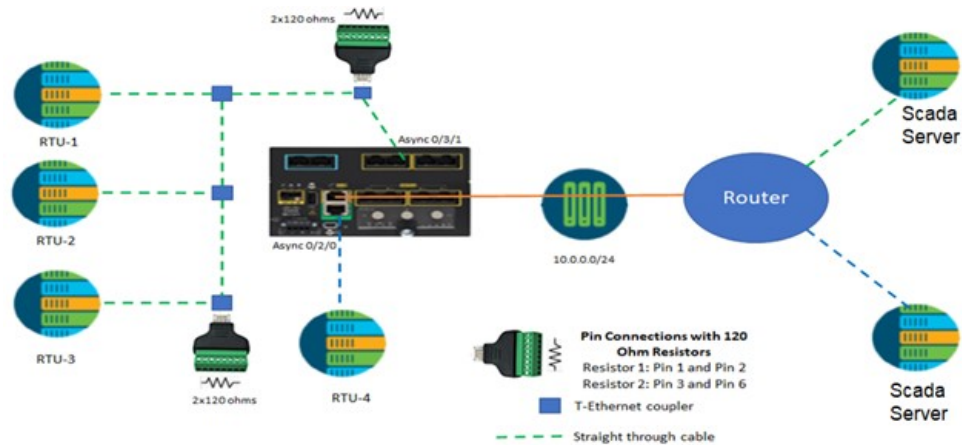

The following is an example configuration for two routers as shown above.

IR1101	Other Router
	Note Can be any IOS-XE router or IOS router, that supports at least 2 serial interfaces.
<pre> int Async0/2/0 encapsulation raw-udp no shut int Async 0/3/1 encapsulation raw-udp media-type rs485 half-duplex no shut line 0/2/0 raw-socket udp connection 10.0.0.2 6001 6000 10.0.0.1 line 0/3/1 raw-socket udp connection 10.0.0.2 5001 5000 10.0.0.1 </pre>	<pre> int Async 0/2/0 encapsulation raw-udp no shut int Async 0/2/1 encapsulation raw-udp no shut line 0/2/0 raw-socket udp connection 10.0.0.1 6000 6001 10.0.0.2 line 0/2/1 raw-socket udp connection 10.0.0.1 5000 5001 10.0.0.2 </pre>

Scada Protocol Translations

Further information can be found in the [Information About SCADA](#) chapter of the IR1101 Rugged Series Router Software Configuration Guide

T101/T104

Figure 5: T101/T104 Configuration Example

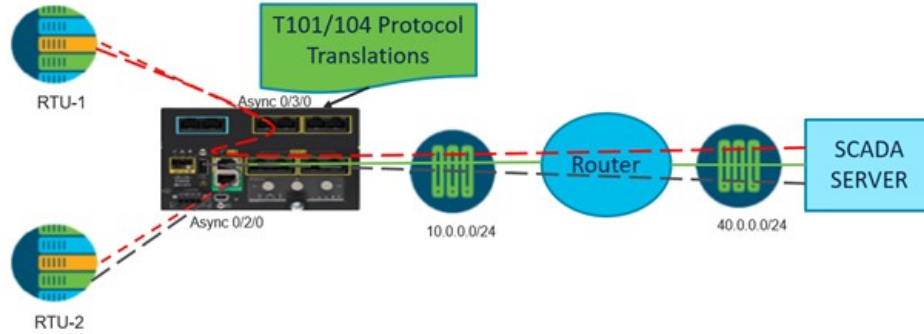

The following is an example configuration for the figure shown above.

Table 2: T101/T104 Configuration Example

<pre>int Async0/2/0 encapsulation scada no shut</pre>	<pre>scada-gw protocol t101 channel rt-chan-1 link-mode balanced bind-to-interface Async0/2/0 session rt-sess-1 attach-to-channel rt-chan-1 common-addr-size one cot-size two info-obj-addr-size three link-addr 31 sector rt-sec-1 attach-to-session rt-sess-1 asdu-addr 100</pre>	<pre>Scada-gw protocol t104 channel mt-chan-1 t3-timeout 20 tcp-connection 0 local-port 5000 remote-ip any attach-to-channel mt-chan-1 sector mt-sec-1 attach-to-session mt-sess-1 asdu-addr 120 map-to-sector rt-sec-1</pre>
<pre>int Async0/3/0 encapsulation scada media-type rs485 half-duplex no shut</pre>	<pre>channel rt-chan-2 link-mode balanced bind-to-interface Async0/3/0 session rt-sess-2 attach-to-channel rt-chan-2 common-addr-size one cot-size two info-obj-addr-size three link-addr 32 sector rt-sec-2 attach-to-session rt-sess-2 asdu-addr 101</pre>	<pre>channel mt-chan-2 t3-timeout 20 tcp-connection 0 local-port 6000 remote-ip any session mt-sess-2 attach-to-channel mt-chan-2 sector mt-sec-2 attach-to-session mt-sess-2 asdu-addr 121 map-to-sector rt-sec-2 scada-gw enable</pre>

DNP3 IP/Serial

Figure 6: DNP3 IP/Serial Configuration Example

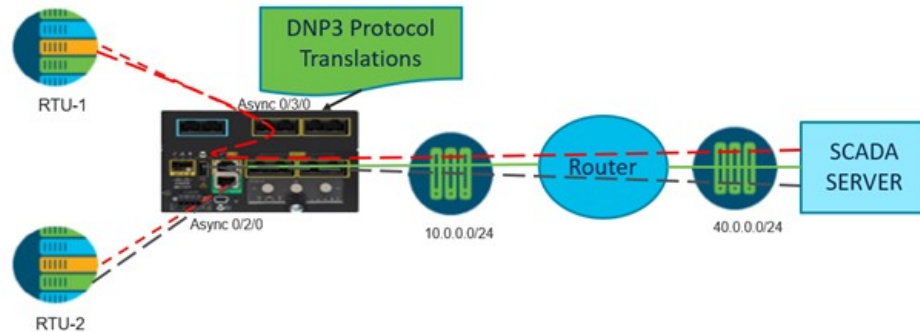

The following is an example configuration for the figure shown above.

Table 3: DNP3 IP/Serial Configuration Example

<pre>int Async0/2/0 encapsulation scada no shut</pre>	<pre>scada-gw protocol dnp3-serial channel dnp3_serial_channel_1 link-addr source 5 request-timeout 60 link-timeout 6 unsolicited-response enable bind-to-interface Async0/2/0 no protocol test-link session dnp3_serial_session_1 attach-to-channel dnp3_serial_channel_1 link-addr dest 1</pre>	<pre>scada-gw protocol dnp3-ip channel dnp3_ip_channel_1 link-addr dest 3 send-unsolicited-msg enable tcp-connection local-port 5000 remote-ip any session dnp3_ip_session_1 attach-to-channel dnp3_ip_channel_1 link-addr source 7 map-to-session dnp3_serial_session_1</pre>
<pre>int Async0/3/0 encapsulation scada media-type rs485 half-duplex no shut</pre>	<pre>channel dnp3_serial_channel_2 link-addr source 6 request-timeout 60 link-timeout 6 unsolicited-response enable bind-to-interface Async0/3/0 no protocol test-link session dnp3_serial_session_2 attach-to-channel dnp3_serial_channel_2 link-addr dest 2</pre>	<pre>channel dnp3_ip_channel_2 link-addr dest 5 send-unsolicited-msg enable tcp-connection local-port 6000 remote-ip any session dnp3_ip_session_2 attach-to-channel dnp3_ip_channel_2 link-addr source 8 map-to-session dnp3_serial_session_2 scada-gw protocol ignore direction scada-gw enable</pre>

Serial Relay

Serial relay can be supported on all of the Async ports of IRM-1100-4A2T. You can map in any order. Mapping of Async interfaces with “encapsulation relay-line” configured on interface. For Example:

- relay line 0/0/0 0/2/0
- relay line 0/0/1 0/3/2

- relay line 0/0/2 0/3/0
- relay line 0/0/3 0/3/1
- relay line 0/0/4 0/4/0

Refer to the [Serial Relay Service](#) chapter in the IR1101 Configuration Guide for additional detail.

Using the WebUI to Configure Async Ports

Use the following steps to configure Async ports through the WebUI.

Before you begin

Cisco IOS XE release supports WebUI support (Day-1) as basic template for configuration and validation for Async interfaces.

Ports can be monitored by navigating to **Monitoring > General > Ports**:

Figure 7: Monitor Ports

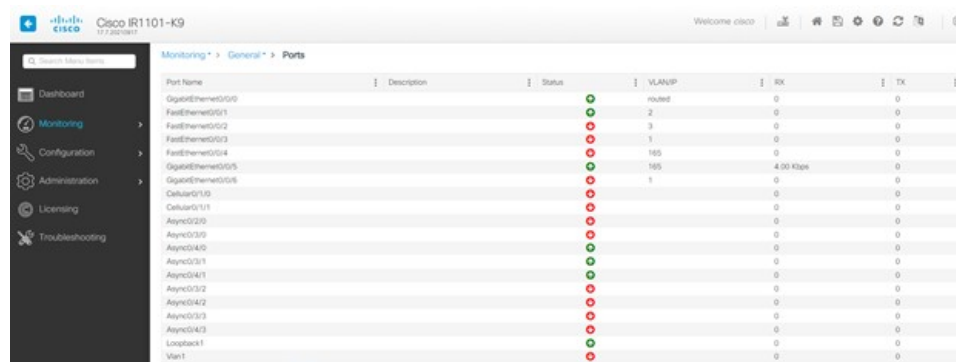

Port Name	Description	Status	VLAN/IP	RX	TX
GigabitEthernet0/0		●	routed	0	0
FastEthernet0/51		●	2	0	0
FastEthernet0/52		●	3	0	0
FastEthernet0/53		●	1	0	0
FastEthernet0/54		●	165	0	0
GigabitEthernet0/55		●	165	4.00 Kbps	0
GigabitEthernet0/56		●	1	0	0
Cellular0/1/0		●		0	0
Cellular0/1/1		●		0	0
Async0/2/0		●		0	0
Async0/3/0		●		0	0
Async0/4/0		●		0	0
Async0/3/1		●		0	0
Async0/4/1		●		0	0
Async0/3/2		●		0	0
Async0/4/2		●		0	0
Async0/3/3		●		0	0
Async0/4/3		●		0	0
Loopback1		●		0	0
Vlan1		●		0	0

Procedure

Step 1 Navigate to **Configuration > Interface > Serial**.

Figure 8: Serial Ports

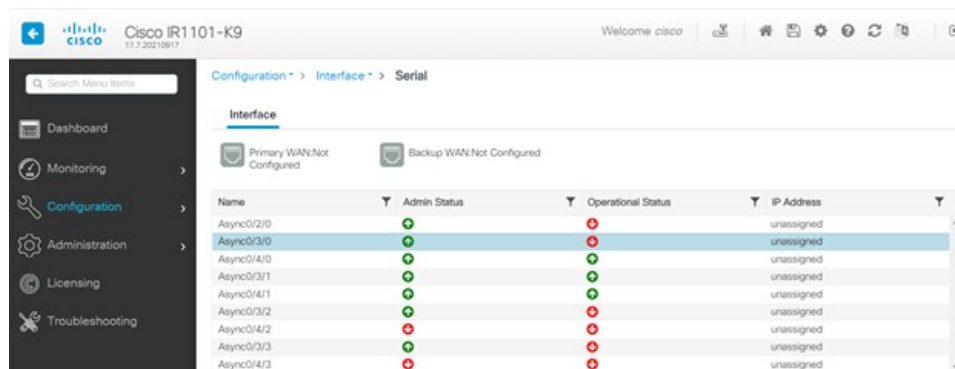

Name	Admin Status	Operational Status	IP Address
Async0/2/0	●	●	unassigned
Async0/3/0	●	●	unassigned
Async0/4/0	●	●	unassigned
Async0/3/1	●	●	unassigned
Async0/4/1	●	●	unassigned
Async0/3/2	●	●	unassigned
Async0/4/2	●	●	unassigned
Async0/3/3	●	●	unassigned
Async0/4/3	●	●	unassigned

Step 2 Double click on the interface you want to edit. The **Edit Interface** <Interface Number> window appears.

Figure 9: Edit Interface

The screenshot shows the 'Edit Interface Async0/2/0' window with the 'General' tab selected. The interface name is 'Async0/2/0'. The description field is empty. The admin status is 'UP' with a green arrow icon. The media type is 'RS232 (Default)'. At the bottom, there are 'Cancel' and 'Update & Apply to Device' buttons.

The Async0/2/0 interface on the base IR1101 supports media-type RS232 by default. You cannot change any media-type associated with this interface.

Step 3 Click on the Encapsulation tab of the Edit Interface window.

Figure 10: Edit Interface (Encapsulation)

The screenshot shows the 'Edit Interface Async0/2/0' window with the 'Encapsulation' tab selected. The encapsulation is set to 'Relay Line'. The interface is 'Line 0/2/0'. The speed is '9600', parity is 'None', stopbits is '2', and databits is '8'. At the bottom, there are 'Cancel' and 'Update & Apply to Device' buttons.

If needed, you can change the encapsulation for the Async0/2/0 interface, and the associated line interface. Select any value from the drop down list that is supported for the Async interface on the IR1101.

Step 4 Perform the same steps to navigate to the Edit Interface window to configure the Async ports on the IRM-1100-4A2T. For example, edit the Async0/3/3 interface:

Figure 11: Edit Interface Async0/3/3

The screenshot shows the 'Edit Interface Async0/3/3' window with the 'General' tab selected. The interface includes the following fields:

- Interface:** Async0/3/3
- Description:** (empty text box)
- Admin Status:** DOWN (with a red arrow icon)
- Media Type:** RS232 (dropdown menu)

At the bottom of the window, there are two buttons: 'Cancel' and 'Update & Apply to Device'.

The ports on the IRM-1100-4A2T can have the media type changed from the drop down box. If RS485 is selected, you can select either full or half duplex.

Figure 12: Edit Interface Async0/3/3 (Encapsulation Tab)

The screenshot shows the 'Edit Interface Async0/3/3' window with the 'Encapsulation' tab selected. The interface includes the following fields:

- Encapsulation:** Scada (dropdown menu)
- Interface:** Line 0/3/3
- Speed:** 9600 (dropdown menu)
- Parity:** None (dropdown menu)
- Stopbits:** 2 (dropdown menu)
- Databits:** 8 (dropdown menu)

At the bottom of the window, there are two buttons: 'Cancel' and 'Update & Apply to Device'.

Step 5 When satisfied with your selections, click on **Update & Apply to Device**.