



Cisco NCS 1010 Automation Workflows, Cisco IOS XR Releases

First Published: 2023-04-27

Last Modified: 2024-03-08

Americas Headquarters

Cisco Systems, Inc.
170 West Tasman Drive
San Jose, CA 95134-1706
USA
<http://www.cisco.com>
Tel: 408 526-4000
800 553-NETS (6387)
Fax: 408 527-0883



CONTENTS

CHAPTER 1

Plan Your Network Using Cisco Optical Network Planner 1

- Plan Your Network 1
- Reference Network Topology 1
- Design the Topology Using Cisco ONP 2
- Analyze the Network 4
- Export Planning Data for Cisco Optical Network Controller 5

CHAPTER 2

Bring Up NCS 1010 Network 7

- Bringup NCS 1010 Manually 7
 - DHCP Configuration 7
 - Manual Configuration Workflow 11
 - Cross-connect Configuration 27
- Bringup NCS 1010 Using ZTP 44
 - DHCP Configuration 44
 - ZTP Configuration Files Creation 47
 - ZTP Configuration Workflow 54
 - Cross-connect Configuration 69

CHAPTER 3

Network Set Up Using Cisco Optical Network Controller 87

- Cisco ONC Workflow 87
 - Onboard Devices in Cisco ONC 87
 - Import Planning Data in Cisco ONC 88
 - Import Planned Passives, Connections, Optical Attributes 88
 - Connect Passives and Cables 88
 - Monitor Connection Issues in Cisco ONC 89
 - Excel File for Onboarding Devices on Cisco ONC 89

CHAPTER 4	Network Discovery and Link Provisioning in Cisco Crosswork Hierarchical Controller	91
	Network Discovery in the Hierarchical Controller	91
	View Installed Crosswork Hierarchical Controller Applications	91
	Add Cisco Optical Network Controller Adapter	92
	Network Discovery for a New Network	93
	Onboard Devices in Cisco Optical Network Controller	93
	Create Sites for Network View	93
	Map Devices to Geographical Location	94
	Network Discovery for an Existing Network	94
	Network Discovery after Update of an Existing Network	94
	Delete Devices from the Network	94
	Delete Device from Cisco Optical Network Controller	94
	Remove Device from Crosswork Hierarchical Controller	95
	Provision End-to-End OCH-NC Link	95
	Before You Begin	95
	Create IPC Using Cisco Optical Network Controller	95
	Import Alien Wavelength to the Hierarchical Controller	96
	Create End-to-End OCH-NC Link	96
	Channel Validation Coloring	98
	Provision the IP Link	99
	Troubleshoot IP Link and OCH-NC through the Hierarchical Controller and Cisco Optical Network Controller	100



CHAPTER 1

Plan Your Network Using Cisco Optical Network Planner

This document provides instructions on how to deploy an NCS 1010 based network, using Cisco ONP, ZTP, and Cisco ONC. Cisco ONP helps with designing a topology with the required specifications, analyze it, and generate the planning data. ZTP, then sets up and brings up the devices. Cisco ONC uses the planning data from Cisco ONP to configure and manage the devices.

This chapter describes the Design and Analysis of Networks and how to Export Planning data from Cisco Optical Network Planner.

- [Plan Your Network, on page 1](#)
- [Reference Network Topology , on page 1](#)
- [Design the Topology Using Cisco ONP , on page 2](#)
- [Analyze the Network, on page 4](#)
- [Export Planning Data for Cisco Optical Network Controller, on page 5](#)

Plan Your Network

The following sections describe how to plan an NCS 1010 based network, using Cisco ONP. Cisco ONP helps with designing a topology with the required specifications, analyze it, and generate the planning data.

Reference Network Topology

The network topology that is shown in this section has been used to explain the NCS 1010 bring-up scenarios. It is a four-degree topology that uses 13 NCS 1010 nodes. The BRK-8 modules are used to create express interconnects among SITE-2, SITE-3, SITE-4, and SITE-5 using MPO cables.

Figure 1: Multi-degree Topology

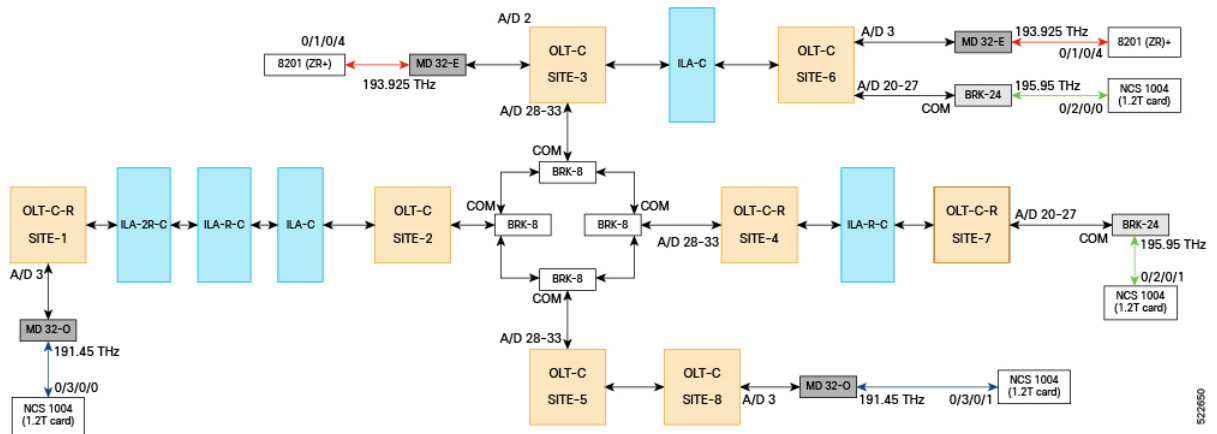

Design the Topology Using Cisco ONP

Use the following steps to design the topology in Cisco ONP:

-
- Step 1** Log in to Cisco ONP Web Interface.
- Step 2** Choose **File > New**.
The **Create New Network** dialog box appears.
- Step 3** From the **L0 Network Platform** drop-down list, choose **NCS1010**.
- Step 4** Click **Create**.
You can view the map and the design palette.
- Step 5** Click the **Drawing Tool** icon (pencil and ruler crossed).
- Step 6** Add sites to the map using the drawing tool.
- Zoom into the map to the desired level.
 - Click any of the site icons (ROADM, OLA) and drag it to the sites on the map. Drag or click the map where a site has to be placed, when the cursor changes to the site icon.
- To create this topology:
- Add four ROADM sites and name them as Site1, Site6, Site7, and Site8.
 - Set the site property, **Structure** as **Terminal** for all the sites.
 - Add five OLA sites as shown in the topology.
 - Add a ROADM site in the middle of the topology and name it as Multidegree.
- c) Click the Fiber icon and drag it to connect from one site to another site. Continue this for all sites.
- Note** By default, the fiber length is updated as 1 km for all the fibers. If you want the length to be auto updated based on the x, y coordinates, then enable the Use Coordinates Distance property under the network Properties.

Note In CONP topology, Site-2, Site-3, Site-4 and Site-5 are not separate nodes. These are all part of a single 4-degree node and represented as Sides of a 4-degree node. In case of NCS 1010, each side is considered as a device. After you connect the site with fiber, four sides are created. Rename the sides as Site-2, Site-3, Site-4, and Site-5.

Step 7 Set the properties of OLA nodes added in the topology to convert them into ILA- C, ILA-R-C, or ILA-2R-C nodes.

- a) Expand the OLA site in the network tree and drill-down until the C-band.
- b) Under the C-Band properties, choose **Raman** from the **Raman Amp** drop-down list.
- c) For ILA-2R-C, repeat steps B and C for another side under the site.

To summarize:

- ILA-C: No Raman is selected.
- ILA-R-C: Raman is selected in one side.
- ILA-2R-C: Raman is selected in two sides.

Step 8 Create circuits between Site-6 to Site-7, Multidegree Site to Site 6, and Site 1 to Site 8.

- a) Click the **Drawing Tool** icon, and select **Circuit** (purple in color).
- b) Add the circuit between the sites on the map.

Step 9 To add the MD-32-E and MD-32-O Mux/Demux patch panels, set the following properties:

- a) Choose **Network > Entity Editor**, and click the **Service** tab.
- b) In the left tree panel, expand the circuit connecting the site to which patch panel is connected, and drill-down to the trail properties.
- c) Under the trail properties, set the **Add/Drop** Type as **Colored**.
- d) Click **Select Similar** to apply the properties in bulk to all the trails.
- e) Click **Update**.
- f) Click the **Site** tab.
- g) Expand the site interface and drill-down to the Add/Drop properties of the side and set the **Colored Add/Drop** as **MD-32-Even** or **MD-32-Odd** as per the topology.
- h) Click **Select Similar** to apply the properties in bulk to all the add/drops.
- i) Click **Update**.

Step 10 To add BRK-24 and BRK-8 breakout panels, set the following properties:

- a) Choose **Network > Entity Editor**, and click the **Service** tab.
- b) In the left tree panel, expand the circuit connecting the site to which the breakout panel is connected, and drill-down to the trail properties.
- c) Under the trail properties, set the **Add/Drop** Type as **Colorless**.
- d) Click **Select Similar** to apply the properties in bulk to all the trails.
- e) Click **Update**.
- f) Click the **Site** tab.
- g) Expand the site interface and drill-down to the Add/Drop properties of the side and set the **Colorless Add/Drop** as **BRK-8** or **BRK-24** as per the topology.
- h) Click **Select Similar** to apply the properties in bulk to all the add/drops.
- i) Click **Update**.

Step 11 To add NCS 1004 (1.2T card), set the following properties:

- Expand the circuit connecting the site to which NCS 1004 (1.2T card) is connected, in the left tree panel, and drill-down to the trail properties.
- Under the trail properties, set the **Card Type** as **NCS1004_16QAM_400G_27%SDFEC_69GBd**.
- Click **Select Similar** to apply the properties in bulk to all the trails.
- Click **Update**.

Step 12 To add 8201 (ZR+) pluggable, set the following properties:

- Expand the circuit connecting the site to which the 8201 (ZR+) pluggable is connected, in the left tree panel, and drill-down to the trail properties.
- Under the trail properties, set the **Card Type** as **CFP2_400ZR+_TXP_GUA18_OFEC_15_DE_ON_16Q_OS_BR60_1**.

The topology looks like the following in the Cisco ONP UI.

Figure 2: Cisco ONP Topology

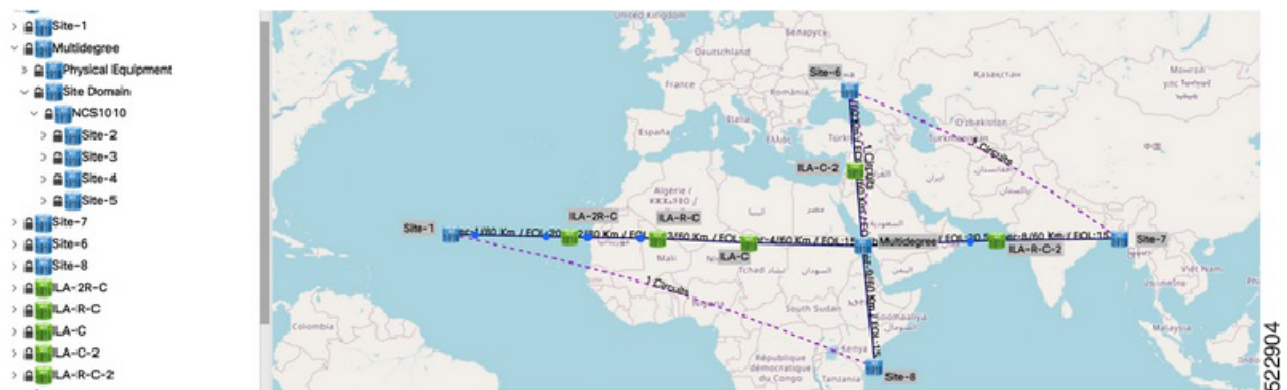

Step 13 Choose **File > Save As**.

Step 14 Enter a network name in the **Give a Network Name** dialog box.

Step 15 Click **Save**.

Analyze the Network

Analyze the designed sample network to check the feasibility of the network using the following steps:

Step 1 Log in to Cisco ONP Web Interface.

Step 2 Choose **File > Open**.

The **Select Network To Open** dialog box appears.

Step 3 Click the sample topology network that you have created, from the list of networks.

Step 4 Choose **Network > Analyze**.

The Cisco ONP analysis progress indicator indicates the analysis status.

If there is any failure in the analysis stage, a pop-up window appears with the message, “Analysis Failed.”

- Step 5** Choose the **Elements > Messages** tab to see the list of error details in the analyzed network.
- By default, it shows only the key messages when the Critical Only toggle button is enabled. If you want to view the entire network message, disable the Critical Only toggle button.
- Step 6** If you find an error message under the **Messages** tab, resolve the error and analyze the network again. Repeat this step until all errors are resolved.
-

What to do next

Export Planning Data for Cisco Optical Network Controller

Export the network planning data which is in the form of JSON file from Cisco ONP using the following steps. This JSON file is uploaded into Cisco ONC to configure the managed devices.

- Step 1** Log in to Cisco ONP Web Interface.
- Step 2** Choose **File > Open**.
- The **Select Network To Open** dialog box appears.
- Step 3** In the network tree panel, right-click the network name.
- Step 4** Click **Generate CONC JSON**.
- Step 5** In the **Export File** dialog box, enter the name of the JSON file.
- Step 6** Click **Export** to download the JSON file into your local system.
-



CHAPTER 2

Bring Up NCS 1010 Network

This chapter describes two ways to bring up an NCS 1010 network, Manual Bringup of NCS 1010 and Automatic Bring up of NCS 1010 using ZTP.

- [Bringup NCS 1010 Manually, on page 7](#)
- [Bringup NCS 1010 Using ZTP, on page 44](#)

Bringup NCS 1010 Manually

Perform the configurations in the following sequence to manually bring up NCS 1010.

- [DHCP Configuration, on page 7](#)
- [Manual Configuration Workflow, on page 11](#)
- [Cross-connect Configuration, on page 27](#)



Note When you boot up the NCS 1010 device for the first time, the ZTP process starts automatically and runs in the background. If the device is configured manually, the ZTP process continues to run in the background. If the ZTP process is not terminated gracefully, after an RP reload or power cycle, interfaces on the device can enter the *shutdown* state. To avoid this issue, it is suggested to disable the ZTP process gracefully. Use the following commands to disable the ZTP:

```
RP/0/RP0/CPU0:ios#ztp terminate
"ZTP Exited"
RP/0/RP0/CPU0:ios#ztp clean
RP/0/RP0/CPU0:ios#ztp disable
```

DHCP Configuration

DHCP configuration is required for both manual configuration and ZTP configuration.

To run iPXE and ZTP, you need a DHCP server. To configure a DHCP server, you must edit the `dhcpd.conf` file available at `/etc/dhcp/`. This configuration file stores the network information such as the path to the script, location of the ISO install file, location of the provisioning configuration (`.cfg`) file, and serial number or the MAC address of the chassis.

In the following example, the settings in the `dhcpd.conf` refers to the span connecting OLT-R-C-SITE-1 to OLT-C-SITE-2.

Figure 3: NetworkTopology Diagram

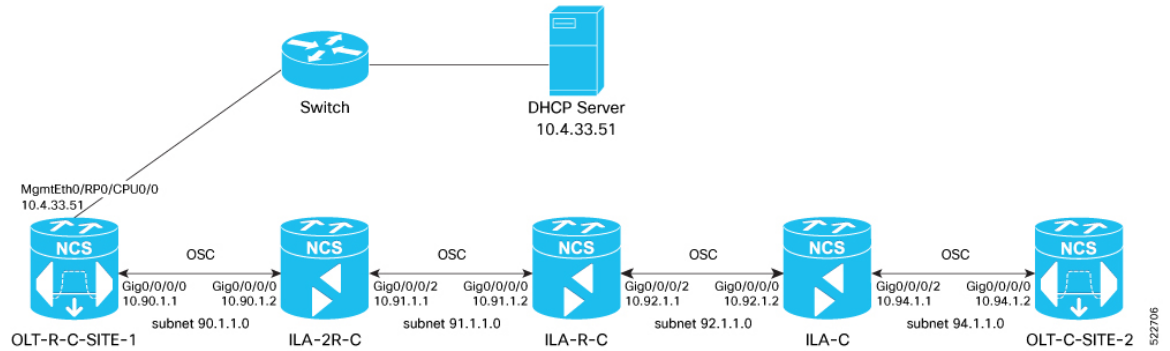

Note Restart the `dhcpd` service using the `service dhcpd restart` command every time you edit the `dhcpd.conf` file.

Add the following settings to the `dhcpd.conf` file :



Note The ZTP configuration files (*.cfg) that are referenced in the `dhcpd.conf` file are detailed in [ZTP Configuration Files Creation, on page 47](#).

```
# DHCP Server Configuration file
ddns-update-style none;
option domain-name "cisco.com";
option domain-name-servers dns-blr1.cisco.com;

default-lease-time 6000;
max-lease-time 72000;

log-facility local7;

option space VendorInfo;

option VendorInfo.clientId code 1 = string;

option VendorInfo.authCode code 2 = unsigned integer 8;

option VendorInfo.md5sum code 3 = string;

option vendor-specific code 43 = encapsulate VendorInfo;

option space cisco-vendor-id-vendor-class code width 1 length width 1;
option vendor-class.cisco-vendor-id-vendor-class code 9 = {string};
option bootstrap_servers code 143 = text;

ddns-update-style none;

#iPXE https specific configs
option space ipxe;
option ipxe-encap-opts code 175 = encapsulate ipxe;
option ipxe.crosscert code 93 = string;
```

```
option ipxe.crosscert "http://10.127.60.159/pub/mirror/ca.ipxe.org/auto";

#ZTP over OSC Configuration

subnet 10.90.1.0 netmask 255.255.255.0 {
  option domain-name-servers dns-blr1.cisco.com;
  option domain-name "cisco.com";
  option routers 10.90.1.1;
  #option netbios-name-serv;
}

subnet 10.91.1.0 netmask 255.255.255.0 {
  option domain-name-servers dns-blr1.cisco.com;
  option domain-name "cisco.com";
  option routers 10.91.1.1;
  #option netbios-name-serv;
}

subnet 10.92.1.0 netmask 255.255.255.0 {
  option domain-name-servers dns-blr1.cisco.com;
  option domain-name "cisco.com";
  option routers 10.92.1.1;
  #option netbios-name-serv;
}

subnet 10.94.1.0 netmask 255.255.255.0 {
  option domain-name-servers dns-blr1.cisco.com;
  option domain-name "cisco.com";
  option routers 10.94.1.1;
  #option netbios-name-serv;
}

#DHCP Relay Configuration

host OLT-R-C-SITE-1 {
  hardware ethernet 38:fd:f8:66:09:52;
  if exists user-class and option user-class = "iPXE" {
    filename "http://10.4.33.51/NCS1010/ncs1010-x64.iso";
  } else {
    filename "http://10.4.33.51/NCS1010_CFG/OLT-R-C-SITE-1.cfg";
  }
  fixed-address 10.4.33.131;
}

host ILA-2R-C {
  hardware ethernet 38:fd:f8:66:08:f6;
  fixed-address 10.90.1.2;
  if exists user-class and option user-class = "iPXE" {
    filename "http://10.4.33.51/NCS1010/ncs1010-x64.iso";
  }
  vendor-option-space VendorInfo;
  option VendorInfo.clientId "xr-config";
  option VendorInfo.authCode 0;
  option bootfile-name "http://10.4.33.51/NCS1010_CFG/ILA-2R-C.cfg";
}

host ILA-R-C {
  hardware ethernet 38:fd:f8:66:09:f2;
  fixed-address 10.91.1.2;
```

```

if exists user-class and option user-class = "iPXE" {
    filename "http://10.4.33.51/NCS1010/ncs1010-x64.iso";
}
vendor-option-space VendorInfo;
option VendorInfo.clientId "xr-config";
option VendorInfo.authCode 0;
option bootfile-name "http://10.4.33.51/NCS1010_CFG/ILA-R-C.cfg";

}

host ILA-C {
hardware ethernet 38:fd:f8:66:09:7d;
fixed-address 10.92.1.2;
if exists user-class and option user-class = "iPXE" {
    filename "http://10.4.33.51/NCS1010/ncs1010-x64.iso";
}
vendor-option-space VendorInfo;
option VendorInfo.clientId "xr-config";
option VendorInfo.authCode 0;
option bootfile-name "http://10.4.33.51/NCS1010_CFG/ILA-C.cfg";

}

host OLT-C-SITE-2 {
hardware ethernet 38:fd:f8:66:06:79;
if exists user-class and option user-class = "iPXE" {
    filename "http://10.4.33.51/NCS010/ncs1010-x64.iso";
} else {
    filename "http://10.4.33.51/NCS1010_CFG/OLT-C-SITE-2.cfg";
}
fixed-address 192.0.2.121;
}

```

To create the static routes in the DHCP server, use the following commands:

```
route add -net OLT-OSC-ip gw OLT-MGMT-ip netmask 255.255.255.255 dev eth3
```

```
route add -net ILA-OSC-ip gw OLT-MGMT-ip netmask 255.255.255.255 dev eth3
```

```

[root@vxr-ncs1010-02 ~]# route add -net 10.90.1.1 gw 10.4.33.131 netmask 255.255.255.255
dev eth3
[root@vxr-ncs1010-02 ~]# route add -net 10.90.1.2 gw 10.4.33.131 netmask 255.255.255.255
dev eth3
[root@vxr-ncs1010-02 ~]# route add -net 10.91.1.1 gw 10.4.33.131 netmask 255.255.255.255
dev eth3
[root@vxr-ncs1010-02 ~]# route add -net 10.91.1.2 gw 10.4.33.131 netmask 255.255.255.255
dev eth3
[root@vxr-ncs1010-02 ~]# route add -net 10.92.1.1 gw 10.4.33.131 netmask 255.255.255.255
dev eth3
[root@vxr-ncs1010-02 ~]# route add -net 10.92.1.2 gw 10.4.33.131 netmask 255.255.255.255
dev eth3
[root@vxr-ncs1010-02 ~]# route add -net 10.94.1.1 gw 10.4.33.131 netmask 255.255.255.255
dev eth3
[root@vxr-ncs1010-02 ~]# route add -net 10.94.1.2 gw 10.4.33.131 netmask 255.255.255.255
dev eth3

```

10.4.33.131 is the management IP address for the gateway node.

Manual Configuration Workflow

This section details how to manually bring up the nodes. Verification outputs have been added at various steps. The iPXE boot process via the BIOS interface has been used for this example.

The example used in this section is:

Figure 4: Network Topology Diagram

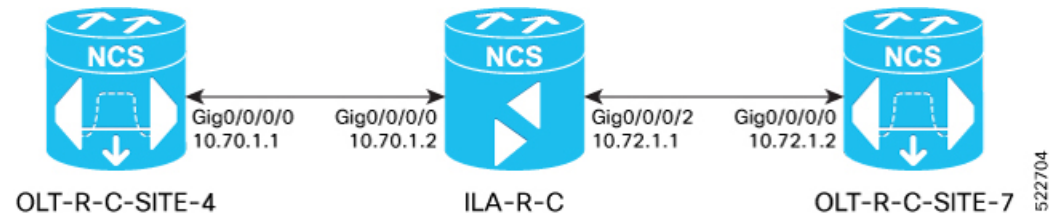

Note Before you use the iPXE boot, ensure that the DHCP server is set and is running. Create a `dhcpd.conf` file specific to the nodes in the network topology diagram. To see a sample `dhcpd.conf` file, see [DHCP Configuration, on page 7](#).

The boot process is initiated via the BIOS interface as follows:

1. The node is reloaded or can undergo a power cycle.
2. Press **Esc** to enter BIOS.
3. Select the **Save & Exit** tab of BIOS.
4. Choose **UEFI: iPXE Network Boot**.

```
Software Boot OK, Validated
```

```
iPXE initialising devices...ok
```

```
iPXE 1.0.0+ (c2215) -- Open Source Network Boot Firmware -- http://ipxe.org
Features: DNS HTTP TFTP VLAN EFI ISO9660 ISO9660_grub Menu
Trying net0-2051,net0-2052 and net0-2053...
net0-2051: 38:fd:f8:66:07:1b using NII on NII-PCI06:00.0 (open)
  [Link:down, TX:0 TXE:0 RX:0 RXE:0]
  [Link status: Unknown (http://ipxe.org/1a086194)]
Configuring (net0-2051 38:fd:f8:66:07:1b)..... ok
net0: fe80::3afd:f8ff:fe66:71b/64
net1: fe80::3afd:f8ff:fe66:71e/64 (inaccessible)
net2: fe80::3afd:f8ff:fe66:71f/64 (inaccessible)
net3: fe80::3afd:f8ff:fe66:720/64 (inaccessible)
net0-2051: 10.4.33.124/255.255.0.0 gw 10.4.33.1
net0-2051: fe80::3afd:f8ff:fe66:71b/64
net0-2051: 2002:420:54ff:93:3afd:f8ff:fe66:71b/64 gw fe80::6a9e:bff:feb8:6f4a
net0-2052: fe80::3afd:f8ff:fe66:71b/64
net0-2053: fe80::3afd:f8ff:fe66:71b/64
Filename: http://10.4.33.51/OLT4/ncs1010-x64.iso
http://10.4.33.51/OLT4/ncs1010-x64.iso... ok
Booting /EFI/BOOT/bootx64.efi
Welcome to GRUB!
```

```

Verifying (cd0)/EFI/BOOT/grub.cfg...
(cd0)/EFI/BOOT/grub.cfg verified using Pkcs7 signature.

015001H Booting `Install IOS-XR'

Booting from ISO image..
Loading Kernel..
Verifying /boot/bzImage...
/boot/bzImage verified using attached signature.
Loading initrd..
Verifying /boot/initrd.img...
/boot/initrd.img verified using Pkcs7 signature.
[ 1.989141] usbhid 1-1:1.0: couldn't find an input interrupt endpoint
2022 Jul 25 08:55:45.362 UTC: Prepare install environment
2022 Jul 25 08:55:45.365 UTC: Preparing installation environment
2022 Jul 25 08:55:45.819 UTC: Bootstrap watchdog punch start
2022 Jul 25 08:55:45.822 UTC: Wait for install device
2022 Jul 25 08:55:45.827 UTC: Create, format and mount partitions
2022 Jul 25 08:55:45.838 UTC: Creating partitions on /dev/sda
2022 Jul 25 08:55:45.867 UTC: Running disk_layout script for PID NCS1010
.
.snipped
.
.
[ OK ] Started IOS-XR ISO Installation.
[ 45.293622] xrnginstall[1292]: 2022 Jul 25 09:03:56.211 UTC: xrnginstall completed
successfully
[ OK ] Started Cisco Directory Services.
Starting Lightning Fast Webserver With Light System Requirements...
[ OK ] Started Lightning Fast Webserver With Light System Requirements.
Starting NOS Bootup FPD Upgrade Service...
[ OK ] Started NOS Bootup FPD Upgrade Service.
Starting IOS-XR Reaperd and Process Manager...
[ OK ] Started IOS-XR Reaperd and Process Manager.
Starting Setting Cgroups...
[ OK ] Started Shutdown start service.
[ OK ] Started Setting Cgroups.
[ OK ] Started Kdump.
[ OK ] Reached target Multi-User System.
[ OK ] Reached target XR installation and startup.
Starting Update UTMP about System Runlevel Changes...
[ OK ] Started Update UTMP about System Runlevel Changes.

ios con0/RP0/CPU0 is now available
!!!!!!!!!!!!!!!!!!!! NO root-system username is configured. Need to configure root-system
username. !!!!!!!!!!!!!!!!!!!!!

```

5. Enter a root username and password.



Note Setting the root system username and password causes the system to exit the ZTP process.

```
--- Administrative User Dialog ---
```

```
Enter root-system username:
```

```
% Entry must not be null.
```

```
Enter root-system username: cisco
```

```
Enter secret: RP/0/RP0/CPU0:Jul 25 09:08:37.522 UTC: ifmgr[234]:
```



```
%PKT_INFRA-LINK-3-UPDOWN : Interface GigabitEthernet0/0/0/0, changed state to Up
RP/0/RP0/CPU0:Jul 25 09:08:45.519 UTC: osa_driver[338]: %PKT_INFRA-FM-2-FAULT_CRITICAL
: ALARM_CRITICAL :RX-LOS-P :CLEAR :Osc0/0/0/0:
```

```
% Entry must not be null.
Enter secret:
Enter secret again:
Use the 'configure' command to modify this configuration.
User Access Verification
```

```
Username: cisco
Password:
RP/0/RP0/CPU0:ios#
```

6. Assign a hostname to the node.

```
RP/0/RP0/CPU0:ios#config
RP/0/RP0/CPU0:ios(config)#hostname OLT-R-C-SITE-4
RP/0/RP0/CPU0:ios(config)#commit
RP/0/RP0/CPU0:ios(config)#exit
```

7. View the interface status.

```
RP/0/RP0/CPU0:OLT-R-C-SITE-4#sh ipv4 interface brief
Mon Jul 25 09:14:23.072 UTC
```

Interface	IP-Address	Status	Protocol	Vrf-Name
GigabitEthernet0/0/0/0	unassigned	Shutdown	Down	default
MgmtEth0/RP0/CPU0/0	unassigned	Shutdown	Down	default
PTP0/RP0/CPU0/0	unassigned	Shutdown	Down	default
MgmtEth0/RP0/CPU0/1	unassigned	Shutdown	Down	default
PTP0/RP0/CPU0/1	unassigned	Shutdown	Down	default
MgmtEth0/RP0/CPU0/2	unassigned	Shutdown	Down	default

IP addresses must be assigned to the interfaces and the state must be changed to Up.

8. Assign IP addresses, for management, Gigabitethernet, and loopback interfaces.

```
RP/0/RP0/CPU0:OLT-R-C-SITE-4#config
Mon Jul 25 09:14:55.867 UTC
RP/0/RP0/CPU0:OLT-R-C-SITE-4(config)#interface MgmtEth 0/RP0/CPU0/0
RP/0/RP0/CPU0:OLT-R-C-SITE-4(config-if)#ipv4 address 10.4.33.124 255.255.255.0
RP/0/RP0/CPU0:OLT-R-C-SITE-4(config-if)#no shutdown
RP/0/RP0/CPU0:OLT-R-C-SITE-4(config-if)#exit
RP/0/RP0/CPU0:OLT-R-C-SITE-4(config)#interface MgmtEth 0/RP0/CPU0/2
RP/0/RP0/CPU0:OLT-R-C-SITE-4(config-if)#ipv4 address 10.127.59.153 255.255.255.0
RP/0/RP0/CPU0:OLT-R-C-SITE-4(config-if)#commit
RP/0/RP0/CPU0:OLT-R-C-SITE-4(config-if)#no shutdown
RP/0/RP0/CPU0:OLT-R-C-SITE-4(config-if)#commit
RP/0/RP0/CPU0:OLT-R-C-SITE-4(config-if)#exit
RP/0/RP0/CPU0:OLT-R-C-SITE-4-4#sh ipv4 interface brief
Mon Jul 25 09:17:14.247 UTC
```

Interface	IP-Address	Status	Protocol	Vrf-Name
GigabitEthernet0/0/0/0	unassigned	Shutdown	Down	default
MgmtEth0/RP0/CPU0/0	10.4.33.124	Up	Up	default
PTP0/RP0/CPU0/0	unassigned	Shutdown	Down	default
MgmtEth0/RP0/CPU0/1	unassigned	Shutdown	Down	default
PTP0/RP0/CPU0/1	unassigned	Shutdown	Down	default
MgmtEth0/RP0/CPU0/2	10.127.59.153	Up	Up	default

```
RP/0/RP0/CPU0:OLT-R-C-SITE-4#configure
Mon Jul 25 09:17:33.503 UTC
RP/0/RP0/CPU0:OLT-R-C-SITE-4(config)#interface GigabitEthernet 0/0/0/0
RP/0/RP0/CPU0:OLT-R-C-SITE-4(config-if)#ipv4 address 10.70.1.1 255.255.255.0
```

```
RP/0/RP0/CPU0:OLT-R-C-SITE-4(config-if)#exit
RP/0/RP0/CPU0:OLT-R-C-SITE-4(config)#interface loopback 0
RP/0/RP0/CPU0:OLT-R-C-SITE-4(config-if)#ipv4 address 10.124.1.1 255.255.255.255
RP/0/RP0/CPU0:OLT-R-C-SITE-4(config-if)#commit
RP/0/RP0/CPU0:OLT-R-C-SITE-4(config-if)#
RP/0/RP0/CPU0:OLT-R-C-SITE-4(config-if)#end
RP/0/RP0/CPU0:OLT-R-C-SITE-4#sh ipv4 interface brief
Mon Jul 25 09:20:06.585 UTC
```

Interface	IP-Address	Status	Protocol	Vrf-Name
Loopback0	10.124.1.1	Up	Up	default
GigabitEthernet0/0/0/0	10.70.1.1	Shutdown	Down	default
MgmtEth0/RP0/CPU0/0	10.4.33.124	Up	Up	default
PTP0/RP0/CPU0/0	unassigned	Shutdown	Down	default
MgmtEth0/RP0/CPU0/1	unassigned	Shutdown	Down	default
PTP0/RP0/CPU0/1	unassigned	Shutdown	Down	default
MgmtEth0/RP0/CPU0/2	10.127.59.153	Up	Up	default

```
RP/0/RP0/CPU0:OLT-R-C-SITE-4#config
Mon Jul 25 09:20:20.669 UTC
RP/0/RP0/CPU0:OLT-R-C-SITE-4(config)#interface GigabitEthernet 0/0/0/0
RP/0/RP0/CPU0:OLT-R-C-SITE-4(config-if)#no shutdown
RP/0/RP0/CPU0:OLT-R-C-SITE-4(config-if)#commit
RP/0/RP0/CPU0:OLT-R-C-SITE-4(config-if)#end
```

```
RP/0/RP0/CPU0:OLT-R-C-SITE-4#sh ipv4 interface brief
Mon Jul 25 09:20:06.585 UTC
```

Interface	IP-Address	Status	Protocol	Vrf-Name
Loopback0	10.124.1.1	Up	Up	default
GigabitEthernet0/0/0/0	10.70.1.1	Up	Up	default
MgmtEth0/RP0/CPU0/0	10.4.33.124	Up	Up	default
PTP0/RP0/CPU0/0	unassigned	Shutdown	Down	default
MgmtEth0/RP0/CPU0/1	unassigned	Shutdown	Down	default
PTP0/RP0/CPU0/1	unassigned	Shutdown	Down	default
MgmtEth0/RP0/CPU0/2	10.127.59.153	Up	Up	default

9. Configure OSPF.

```
RP/0/RP0/CPU0:OLT-R-C-SITE-4#config
Mon Jul 25 09:20:35.600 UTC
RP/0/RP0/CPU0:OLT-R-C-SITE-4(config)#router ospf 1
RP/0/RP0/CPU0:OLT-R-C-SITE-4(config-ospf)#distribute link-state instance-id 0 throttle
5
RP/0/RP0/CPU0:OLT-R-C-SITE-4(config-ospf)#router-id 10.124.1.1
RP/0/RP0/CPU0:OLT-R-C-SITE-4(config-ospf)#network point-to-point
RP/0/RP0/CPU0:OLT-R-C-SITE-4(config-ospf)#area 0
RP/0/RP0/CPU0:OLT-R-C-SITE-4(config-ospf-ar)#interface loopback 0
RP/0/RP0/CPU0:OLT-R-C-SITE-4(config-ospf-ar-if)#commit
RP/0/RP0/CPU0:OLT-R-C-SITE-4(config-ospf-ar-if)#
RP/0/RP0/CPU0:OLT-R-C-SITE-4(config-ospf-ar-if)#exit
RP/0/RP0/CPU0:OLT-R-C-SITE-4(config-ospf-ar)#interface GigabitEthernet 0/0/0/0
RP/0/RP0/CPU0:OLT-R-C-SITE-4(config-ospf-ar-if)#
RP/0/RP0/CPU0:OLT-R-C-SITE-4(config-ospf-ar-if)#commit
RP/0/RP0/CPU0:OLT-R-C-SITE-4(config-ospf-ar-if)#end
```

10. To view the OSPF neighbours:

```
RP/0/RP0/CPU0:OLT-R-C-SITE-4#sh ospf neighbor
Mon Jul 25 09:22:58.684 UTC
```

```
* Indicates MADJ interface
# Indicates Neighbor awaiting BFD session up
```

```
Neighbors for OSPF 1
```

```

Neighbor ID      Pri   State           Dead Time   Address      Interface
10.137.1.1      1    FULL/ -        00:00:38   10.70.1.2
GigabitEthernet0/0/0/0
    Neighbor is up for 00:00:20

Total neighbor count: 1

```



Note This output is displayed when the ILA-R-C node is brought up.

11. To view the status of the OSC controller:

```

RP/0/RP0/CPU0:OLT-R-C-SITE-4#sh controllers osc 0/0/0/0
Mon Jul 25 09:24:52.753 UTC

```

```

Controller State: Up

```

```

Transport Admin State: In Service

```

```

Laser State: On

```

```

Alarm Status:
-----
Detected Alarms: None

```

```

Alarm Statistics:
-----
RX-LOS-P = 2
TX-POWER-FAIL-LOW = 0

```

```

Parameter Statistics:
-----
Total TX Power = 0.09 dBm
Total RX Power = -17.82 dBm

```

```

Configured Parameters:
-----

```

12. To view the span loss:

```

RP/0/RP0/CPU0:OLT-R-C-SITE-4#sh olc span-loss
Mon Jul 25 09:25:09.572 UTC

```

```

Controller name           : Ots0/0/0/0
Neighbour RID            : 10.137.1.1
Apparent Rx Span Loss    : 15.9 dB
Rx Span Loss (with pumps off) : 19.2 dB
Rx Span Loss (with pumps off) measured at : 2022-07-25 09:24:37
Estimated Rx Span Loss   : NA
Apparent Tx Span Loss    : 16.0 dB
Tx Span Loss (with pumps off) : 16.8 dB
Tx Span Loss (with pumps off) measured at : 2022-07-25 09:23:12
Estimated Tx Span Loss   : NA

```



Note The optical applications such as Raman tuning, link tuner, gain estimator, and APC are disabled by default. To enable the optical applications, use the **automatic-link-bringup** as seen in the next step.

```
RP/0/RP0/CPU0:OLT-R-C-SITE-4#sh olc raman-tuning
Mon Jul 25 09:25:20.687 UTC
```

```
Controller                : Ots0/0/0/0
Raman-Tuning Status      : DISABLED
Tuning Complete Timestamp : N/A
Estimated Max Possible Gain : N/A dB
Raman Gain Target        : N/A dB
Gain Achieved on Tuning Complete : N/A dB
```

```
RP/0/RP0/CPU0:OLT-R-C-SITE-4#
RP/0/RP0/CPU0:OLT-R-C-SITE-4#
RP/0/RP0/CPU0:OLT-R-C-SITE-4#
RP/0/RP0/CPU0:OLT-R-C-SITE-4#sh olc apc
Mon Jul 25 09:25:39.292 UTC
```

```
Controller      : Ots0/0/0/0
APC Status    : DISABLED
```

```
RP/0/RP0/CPU0:OLT-R-C-SITE-4#sh olc link-tuner
Mon Jul 25 09:25:43.437 UTC
```

```
Controller      : Ots0/0/0/0
Link Tuner Status : DISABLED
Last PSD computation: NA
```

```
-----
Setpoint          : Computed PSD
                   (dBm/12.5 GHz)
-----
```

```
-----
01                NaN
02                NaN
03                NaN
04                NaN
05                NaN
06                NaN
07                NaN
08                NaN
09                NaN
10                NaN
11                NaN
12                NaN
13                NaN
14                NaN
15                NaN
16                NaN
17                NaN
18                NaN
19                NaN
20                NaN
21                NaN
22                NaN
23                NaN
24                NaN
25                NaN
26                NaN
27                NaN
28                NaN
29                NaN
30                NaN
31                NaN
32                NaN
33                NaN
-----
```

```
RP/0/RP0/CPU0:OLT-R-C-SITE-4#sh olc gain-estimator
Mon Jul 25 09:25:47.566 UTC
```

```

Controller                               : Ots0/0/0/0
Ingress Gain Estimator Status         : DISABLED
Ingress Estimated Gain                    : NA
Ingress Estimated Gain Mode               : NA
RP/0/RP0/CPU0:OLT-R-C-SITE-4#

```

13. To enable automatic link bringup, use the following command:

```

RP/0/RP0/CPU0:OLT-R-C-SITE-4#config
Mon Jul 25 09:30:38.919 UTC
RP/0/RP0/CPU0:OLT-R-C-SITE-4 (config)#optical-line-control
RP/0/RP0/CPU0:OLT-R-C-SITE-4 (config-olc)#
RP/0/RP0/CPU0:OLT-R-C-SITE-4 (config-olc)#automatic-link-bringup
RP/0/RP0/CPU0:OLT-R-C-SITE-4 (config-olc)#commit

```

14. Use the following show commands to verify the state of the operations.

```

RP/0/RP0/CPU0:OLT-R-C-SITE-4#sh olc raman-tuning
Mon Jul 25 09:31:51.508 UTC

```

```

Controller                               : Ots0/0/0/0
Raman-Tuning Status                   : WORKING - MEASUREMENT
Tuning Complete Timestamp                : N/A
Estimated Max Possible Gain              : N/A dB
Raman Gain Target                        : N/A dB
Gain Achieved on Tuning Complete         : N/A dB

```

```

RP/0/RP0/CPU0:OLT-R-C-SITE-4#sh olc apc
Mon Jul 25 09:31:56.769 UTC

```

```

Controller      : Ots0/0/0/0
APC Status      : BLOCKED

```

```

Node RID        : 10.124.1.1
Internal State  : BLOCKED
Blocked Reason  : [ AMPLI-SHUT ]

```

```

Node RID        : 10.137.1.1
Internal State  : DISCREPANCY

```

```

Node RID        : 10.129.1.1
Internal State  : DISCREPANCY

```

```

RP/0/RP0/CPU0:OLT-R-C-SITE-4#
RP/0/RP0/CPU0:OLT-R-C-SITE-4#sh alarms brief system active
Mon Jul 25 09:33:18.887 UTC

```

```

-----
Active Alarms
-----

```

Location	Severity	Group	Set Time	Description
0/PM1 Error (PM_VIN_VOLT_OOR)	Major	Environ	07/25/2022 09:04:20 UTC	Power Module
0/PM1 Output Disabled (PM_OUTPUT_DISABLED)	Major	Environ	07/25/2022 09:04:20 UTC	Power Module

```

0          Major      Environ      07/25/2022 09:04:20 UTC      Power Group
redundancy lost

0/0        Critical   Controller  07/25/2022 09:05:29 UTC      Ots0/0/0/1 -
Loss of Signal - Payload

0/0/NXR0   Minor        Software   07/25/2022 09:28:20 UTC      Ots0/0/0/0 -
APC Reached out-of-range condition in RX direction

0/0/NXR0   Major        Software   07/25/2022 09:31:37 UTC      Ots0/0/0/0 -
Raman Tuning procedure is running

0/0        Critical   Controller  07/25/2022 09:32:08 UTC      Ots0/0/0/0 -
Output OTS Power Reading Below The Fail-Low Threshold

0/0        Critical   Controller  07/25/2022 09:32:53 UTC      Ots0/0/0/1 -
Output OTS Power Reading Below The Fail-Low Threshold

RP/0/RP0/CPU0:OLT-R-C-SITE-4#sh alarms b s a | i 0/0RP/0/RP0/CPU0:Jul 25 09:33:23.520
UTC: osa_driver[338]: %PKT_INFRA-FM-2-FAULT_CRITICAL : ALARM_CRITICAL :TX-POWER-FAIL-LOW
:CLEAR :Ots0/0/0/1:
/0/0
Mon Jul 25 09:33:25.863 UTC
0/0/NXR0   Minor        Software   07/25/2022 09:28:20 UTC      Ots0/0/0/0 -
APC Reached out-of-range condition in RX direction

0/0/NXR0   Major        Software   07/25/2022 09:31:37 UTC      Ots0/0/0/0 -
Raman Tuning procedure is running

0/0        Critical   Controller  07/25/2022 09:32:08 UTC      Ots0/0/0/0 -
Output OTS Power Reading Below The Fail-Low Threshold

RP/0/RP0/CPU0:OLT-R-C-SITE-4#sh olc link-tuner
Mon Jul 25 09:33:38.414 UTC
Controller      : Ots0/0/0/0
Link Tuner Status : OPERATIONAL
Last PSD computation: 2022-07-25 09:33:13
-----
Setpoint      : Computed PSD
                (dBm/12.5 GHz)
-----
01             -7.8
02             -7.7
03             -7.7
04             -7.7
05             -7.6
06             -7.6
07             -7.6
08             -7.5
09             -7.5
10             -7.5
11             -7.4
12             -7.4
13             -7.4
14             -7.3

```

```

15          -7.3
16          -7.3
17          -7.3
18          -7.2
19          -7.2
20          -7.2
21          -7.1
22          -7.1
23          -7.1
24          -7.1
25          -7.0
26          -7.0
27          -6.9
28          -6.9
29          -6.9
30          -6.9
31          -6.8
32          -6.8
33          -6.8

```

```

RP/0/RP0/CPU0:OLT-R-C-SITE-4#
RP/0/RP0/CPU0:OLT-R-C-SITE-4#sh olc gain-estimator
Mon Jul 25 09:33:45.445 UTC
Controller          : Ots0/0/0/0
Ingress Gain Estimator Status      : BLOCKED
Ingress Estimated Gain          : NA
Ingress Estimated Gain Mode     : NA
Ingress Gain Estimation Timestamp : NA

```

```

RP/0/RP0/CPU0:OLT-R-C-SITE-4#sh olc apc
Mon Jul 25 09:33:58.419 UTC

```

```

Controller          : Ots0/0/0/0
APC Status          : WORKING
Correcting Node     : 10.124.1.1

Node RID            : 10.124.1.1
Internal State      : CORRECTING

Node RID            : 10.137.1.1
Internal State      : DISCREPANCY

Node RID            : 10.129.1.1
Internal State      : DISCREPANCY

```

```

RP/0/RP0/CPU0:OLT-R-C-SITE-4#sh olc raman-tuning
Mon Jul 25 09:34:03.907 UTC

```

```

Controller          : Ots0/0/0/0
Raman-Tuning Status          : WORKING - MEASUREMENT
Tuning Complete Timestamp          : N/A
Estimated Max Possible Gain        : N/A dB
Raman Gain Target                  : N/A dB
Gain Achieved on Tuning Complete   : N/A dB

```

```

RP/0/RP0/CPU0:OLT-R-C-SITE-4#sh olc raman-tuning
Mon Jul 25 09:36:52.841 UTC

```

```

Controller          : Ots0/0/0/0
Raman-Tuning Status          : WORKING - CALCULATION
Tuning Complete Timestamp          : N/A

```

```

Estimated Max Possible Gain      : N/A dB
Raman Gain Target                : 13.1 dB
Gain Achieved on Tuning Complete : N/A dB

RP/0/RP0/CPU0:OLT-R-C-SITE-4#sh olc apc
Mon Jul 25 09:37:16.073 UTC

Controller      : Ots0/0/0/0
APC Status      : WORKING
Correcting Node : 10.124.1.1

Node RID        : 10.124.1.1
Internal State  : CORRECTING

Node RID        : 10.137.1.1
Internal State  : DISCREPANCY

Node RID        : 10.129.1.1
Internal State  : DISCREPANCY

RP/0/RP0/CPU0:OLT-R-C-SITE-4#sh olc raman-tuning
Mon Jul 25 09:37:34.745 UTC

Controller      : Ots0/0/0/0
Raman-Tuning Status      : WORKING - CALCULATION
Tuning Complete Timestamp      : N/A
Estimated Max Possible Gain    : 20.6 dB
Raman Gain Target              : 13.1 dB
Gain Achieved on Tuning Complete : N/A dB

RP/0/RP0/CPU0:OLT-R-C-SITE-4#
RP/0/RP0/CPU0:OLT-R-C-SITE-4#
RP/0/RP0/CPU0:OLT-R-C-SITE-4#sh olc gain-estimator
Mon Jul 25 09:40:06.404 UTC
Controller      : Ots0/0/0/0
Ingress Gain Estimator Status : BLOCKED
Ingress Estimated Gain          : NA
Ingress Estimated Gain Mode     : NA
Ingress Gain Estimation Timestamp : NA

```

15. After the processes are complete, the status changes to IDLE for APC and gain estimator. The Raman tuning status changes to TUNED. The empty channels are loaded with noise by ASE.

```

P/0/RP0/CPU0:OLT-R-C-SITE-4#sh olc apc
Mon Jul 25 09:43:00.639 UTC

Controller      : Ots0/0/0/0
APC Status      : IDLE

Node RID        : 10.124.1.1
Internal State  : IDLE

Node RID        : 10.137.1.1
Internal State  : IDLE

Node RID        : 10.129.1.1
Internal State  : IDLE

RP/0/RP0/CPU0:OLT-R-C-SITE-4#sh olc gain-estimator
Mon Jul 25 09:45:05.539 UTC
Controller      : Ots0/0/0/0
Ingress Gain Estimator Status : IDLE
Ingress Estimated Gain        : 10.9 dB
Ingress Estimated Gain Mode   : Normal

```

Ingress Gain Estimation Timestamp : 2022-07-25 09:40:12

RP/0/RP0/CPU0:OLT-R-C-SITE-4#sh olc raman-tuning
 Mon Jul 25 09:45:51.487 UTC

Controller : Ots0/0/0/0
 Raman-Tuning Status : TUNED
 Tuning Complete Timestamp : 2022-07-25 09:40:12
 Estimated Max Possible Gain : 20.6 dB
 Raman Gain Target : 13.1 dB
 Gain Achieved on Tuning Complete : 13.0 dB

RP/0/RP0/CPU0:OLT-R-C-SITE-4#sh olc apc-local regulation-info controller ots 0\$
 Mon Jul 25 09:47:42.611 UTC

Controller : Ots0/0/0/0
 Domain Manager : 10.129.1.1
 Internal Status : IDLE
 Direction : RX
 PSD Minimum : -24.0 (dBm/12.5 GHz)
 Gain Range : Normal
 Last Correction : 2022-07-25 09:43:44

Device Parameters Operational	Min	Max	Configuration
Ingress Ampli Gain (dB) 16.7	10.9	23.9	16.7
Ingress Ampli Tilt (dB) -0.9	-5.0	3.4	-1.0
RX Ampli Power (dBm) 24.3	-	25.0	-
RX VOA Attenuation (dB) 0.0	0.0	0.0	0.0
Ingress WSS/DGE Attenuation (dB) -	0.0	25.0	-

Channel Center Target Frequency PSD (THz) (dBm/12.5 GHz)	Channel Current Width PSD (GHz) (dBm/12.5 GHz)	Channel Discrepancy ID (dB)	Channel Source Channel Attn Config (dB)	Spectrum Slice Slice Num (dB)	Ampli-Input PSD (dBm/12.5 GHz)
191.375000	75.00	64	ASE	13	-16.5
-	-24.8	0.0	25.0	37	-16.6
191.449997	75.00	63	ASE	61	-16.6
-	-24.9	0.0	25.0	85	-16.6
191.524994	75.00	62	ASE	109	-16.7
-	-24.9	0.0	25.0	133	-16.8
191.600006	75.00	61	ASE	157	-16.9
-	-25.0	0.0	25.0	181	-16.8
191.675003	75.00	60	ASE	205	-17.0
-	-25.1	0.0	25.0		
191.750000	75.00	59	ASE		
-	-25.2	0.0	25.0		
191.824997	75.00	58	ASE		
-	-25.3	0.0	25.0		
191.899994	50.00	57	ASE		
-	-25.2	0.0	25.0		
191.975006	75.00	56	ASE		

-	-25.4	0.0	25.0			
192.050003	75.00	-	ASE	229	-17.2	
-	-25.6	0.0	25.0			
192.125000	75.00	-	ASE	253	-17.2	
-	-25.6	0.0	25.0			
192.199997	75.00	-	ASE	277	-17.3	
-	-25.7	0.0	25.0			
192.274994	75.00	-	ASE	301	-17.3	
-	-25.7	0.0	25.0			
192.350006	75.00	-	ASE	325	-17.3	
-	-25.7	0.0	25.0			
192.425003	75.00	-	ASE	349	-17.5	
-	-25.9	0.0	25.0			
192.500000	75.00	-	ASE	373	-17.4	
-	-25.8	0.0	25.0			
192.574997	75.00	-	ASE	397	-17.7	
-	-26.1	0.0	25.0			
192.649994	75.00	-	ASE	421	-17.8	
-	-26.1	0.0	25.0			
192.725006	75.00	-	ASE	445	-17.7	
-	-26.1	0.0	25.0			
192.800003	75.00	-	ASE	469	-17.7	
-	-26.0	0.0	25.0			
192.875000	75.00	-	ASE	493	-17.8	
-	-26.1	0.0	25.0			
192.949997	75.00	-	ASE	517	-17.8	
-	-26.2	0.0	25.0			
193.024994	75.00	-	ASE	541	-17.9	
-	-26.2	0.0	25.0			
193.100006	75.00	-	ASE	565	-18.0	
-	-26.3	0.0	25.0			
193.175003	75.00	-	ASE	589	-17.8	
-	-26.2	0.0	25.0			
193.250000	75.00	-	ASE	613	-17.8	
-	-26.2	0.0	25.0			
193.324997	75.00	-	ASE	637	-17.9	
-	-26.2	0.0	25.0			
193.399994	75.00	-	ASE	661	-17.8	
-	-26.0	0.0	25.0			
193.475006	75.00	-	ASE	685	-17.6	
-	-25.8	0.0	25.0			
193.550003	75.00	35	ASE	709	-17.4	
-	-25.7	0.0	25.0			
193.625000	75.00	-	ASE	733	-17.2	
-	-25.5	0.0	25.0			
193.699997	75.00	-	ASE	757	-17.2	
-	-25.4	0.0	25.0			
193.774994	75.00	-	ASE	781	-17.1	
-	-25.3	0.0	25.0			
193.850006	75.00	-	ASE	805	-17.0	
-	-25.2	0.0	25.0			
193.925003	75.00	-	ASE	829	-17.0	
-	-25.2	0.0	25.0			
194.000000	75.00	-	ASE	853	-17.1	
-	-25.3	0.0	25.0			
194.074997	75.00	-	ASE	877	-16.9	
-	-25.1	0.0	25.0			
194.149994	75.00	-	ASE	901	-17.0	
-	-25.1	0.0	25.0			
194.225006	75.00	-	ASE	925	-17.1	
-	-25.1	0.0	25.0			
194.300003	75.00	-	ASE	949	-17.2	
-	-25.3	0.0	25.0			
194.375000	75.00	-	ASE	973	-17.3	

-	-25.3	0.0	25.0			
194.449997	75.00	-	ASE	997	-17.5	
-	-25.5	0.0	25.0			
194.524994	75.00	-	ASE	1021	-17.5	
-	-25.5	0.0	25.0			
194.600006	75.00	-	ASE	1045	-17.7	
-	-25.7	0.0	25.0			
194.675003	75.00	-	ASE	1069	-17.8	
-	-25.8	0.0	25.0			
194.750000	75.00	-	ASE	1093	-17.8	
-	-25.8	0.0	25.0			
194.824997	75.00	18	ASE	1117	-17.8	
-	-25.8	0.0	25.0			
194.899994	75.00	-	ASE	1141	-17.8	
-	-25.8	0.0	25.0			
194.975006	75.00	16	ASE	1165	-17.7	
-	-25.8	0.0	25.0			
195.050003	75.00	15	ASE	1189	-17.7	
-	-25.8	0.0	25.0			
195.125000	75.00	14	ASE	1213	-17.5	
-	-25.7	0.0	25.0			
195.199997	75.00	13	ASE	1237	-17.6	
-	-25.8	0.0	25.0			
195.274994	75.00	12	ASE	1261	-17.6	
-	-25.8	0.0	25.0			
195.350006	75.00	11	ASE	1285	-17.5	
-	-25.7	0.0	25.0			
195.425003	75.00	10	ASE	1309	-17.5	
-	-25.6	0.0	25.0			
195.500000	75.00	9	ASE	1333	-17.5	
-	-25.6	0.0	25.0			
195.574997	75.00	8	ASE	1357	-17.6	
-	-25.7	0.0	25.0			
195.649994	75.00	7	ASE	1381	-17.5	
-	-25.6	0.0	25.0			
195.725006	75.00	6	ASE	1405	-17.4	
-	-25.5	0.0	25.0			
195.800003	75.00	5	ASE	1429	-17.6	
-	-25.5	0.0	25.0			
195.875000	75.00	4	ASE	1453	-17.7	
-	-25.6	0.0	25.0			
195.949997	75.00	3	OCh	1477	-17.7	
-	-25.5	0.0	25.0			
196.024994	75.00	2	ASE	1501	-17.9	
-	-25.6	0.0	25.0			
196.100006	75.00	1	OCh	1525	-18.2	
-	-25.7	0.0	25.0			

ASE - Noise Loaded Channel

OCh - Optical Channel

RP/0/RP0/CPU0:OLT-R-C-SITE-4#sh olc span-loss

Mon Jul 25 09:51:46.279 UTC

```

Controller name                : Ots0/0/0/0
Neighbour RID                  : 10.137.1.1
Apparent Rx Span Loss         : 6.2 dB
Rx Span Loss (with pumps off) : 19.2 dB
Rx Span Loss (with pumps off) measured at : 2022-07-25 09:32:37
Estimated Rx Span Loss       : 19.2 dB
Apparent Tx Span Loss         : 4.9 dB
Tx Span Loss (with pumps off) : 16.8 dB
Tx Span Loss (with pumps off) measured at : 2022-07-25 09:23:12
Estimated Tx Span Loss       : 17.0 dB

```

```
RP/0/RP0/CPU0:OLT-R-C-SITE-4#sh olc apc
Mon Jul 25 09:51:56.858 UTC
```

```
Controller      : Ots0/0/0/0
APC Status      : IDLE
```

```
Node RID        : 10.124.1.1
Internal State  : IDLE
```

```
Node RID        : 10.137.1.1
Internal State  : IDLE
```

```
Node RID        : 10.129.1.1
Internal State  : IDLE
```

```
RP/0/RP0/CPU0:OLT-R-C-SITE-4#sh olc link-tuner
Mon Jul 25 09:52:00.272 UTC
```

```
Controller      : Ots0/0/0/0
```

```
Link Tuner Status : OPERATIONAL
```

```
Last PSD computation: 2022-07-25 09:33:13
```

```
-----
Setpoint        : Computed PSD
                  (dBm/12.5 GHz)
-----
```

```
01              -7.8
02              -7.7
03              -7.7
04              -7.7
05              -7.6
06              -7.6
07              -7.6
08              -7.5
09              -7.5
10              -7.5
11              -7.4
12              -7.4
13              -7.4
14              -7.3
15              -7.3
16              -7.3
17              -7.3
18              -7.2
19              -7.2
20              -7.2
21              -7.1
22              -7.1
23              -7.1
24              -7.1
25              -7.0
26              -7.0
27              -6.9
28              -6.9
29              -6.9
30              -6.9
31              -6.8
32              -6.8
33              -6.8
```

16. Repeat steps 1 through 15 to configure the ILA-R-C and OLT-R-C-SITE-7 nodes.
17. Configure the cross-connects for the OLT-R-C-SITE-4 and OLT-R-C-SITE-7 nodes. For a sample cross-connect configuration, see [Cross-connect Configuration, on page 27](#).

The following sample displays the running configuration of the OLT-R-C-SITE-4 node that was configured earlier.

```
!! IOS XR Configuration 7.7.1.34I
!! Last configuration change at Mon Jul 25 09:31:37 2022 by cisco
!
hostname OLT-R-C-SITE-4
username cisco
  group root-lr
  group cisco-support
  secret 10
$6$apz9n/xzmQjA5n/.$1bqshQ3JznivW1890NY4e7s5ckBTzVxKk8..gz0Ms7Oe5DYNBGa4hSzKVSoi0EgqK8OIgBebdtXopXzU4kPSb1
!
call-home
  service active
  contact smart-licensing
  profile CiscoTAC-1
    active
  destination transport-method email disable
  destination transport-method http
!
!
interface Loopback0
  ipv4 address 10.124.1.1 255.255.255.255
!
interface MgmtEth0/RP0/CPU0/0
  ipv4 address 10.4.33.124 255.255.255.0
!
interface MgmtEth0/RP0/CPU0/1
  shutdown
!
interface MgmtEth0/RP0/CPU0/2
  ipv4 address 10.127.59.153 255.255.255.0
!
interface GigabitEthernet0/0/0/0
  ipv4 address 10.70.1.1 255.255.255.0
!
interface PTP0/RP0/CPU0/0
  shutdown
!
interface PTP0/RP0/CPU0/1
  shutdown
!
router ospf 1
  distribute link-state instance-id 0 throttle 5
  router-id 10.124.1.1
  network point-to-point
  area 0
    interface Loopback0
      !
    interface GigabitEthernet0/0/0/0
      !
  !
!
optical-line-control
  automatic-link-bringup
!
end
```

The following sample displays the running configuration of the ILA-R-C node.

```
hostname ILA-R-C
username cisco
  group root-lr
  group cisco-support
```

```

secret 10
$6$kkAus0AXCicX9s0.$eOFMOC3oIJO8yoGC6SeZR5SUyy1A2XThloqu4BKtazw8Tmg0xccyhq0p43q5UVHXMZHoNppSiX/R14WF4EZka/
password 7 05080F1C221C1F5B4A
!
call-home
service active
contact smart-licensing
profile CiscoTAC-1
  active
  destination transport-method email disable
  destination transport-method http
!
!
interface Loopback0
ipv4 address 10.137.1.1 255.255.255.255
!
interface MgmtEth0/RP0/CPU0/0
ipv4 address 10.4.33.137 255.255.255.0
!
interface MgmtEth0/RP0/CPU0/1
shutdown
!
interface MgmtEth0/RP0/CPU0/2
ipv4 address 10.127.59.157 255.255.255.0
!
interface GigabitEthernet0/0/0/0
ipv4 address 10.70.1.2 255.255.255.0
!
interface GigabitEthernet0/0/0/2
ipv4 address 10.72.1.1 255.255.255.0
!
interface PTP0/RP0/CPU0/0
shutdown
!
interface PTP0/RP0/CPU0/1
shutdown
!
router ospf 1
  distribute link-state instance-id 0 throttle 5
  router-id 10.137.1.1
  network point-to-point
  redistribute connected
  area 0
    interface Loopback0
    !
    interface GigabitEthernet0/0/0/0
    !
    interface GigabitEthernet0/0/0/2
    !
  optical-line-control
  automatic-link-bringup
!
End

```

The following sample displays the running configuration of the OLT-R-C-SITE-7 node.

```

hostname OLT-R-C-SITE-7
username cisco
group root-lr
group cisco-support
secret 10
$6$USjBp0rPHhqI9p0.$adQMhZ6N8KqfHtgCFx00IcxN5F.QxeyzXsoJ2IKeJx4tU/hhEmTcrEJL2z5Z1UA79CPMjdrECaTtmXBswm0s/
password 7 110A101614425A5E57

```

```

!
call-home
service active
contact smart-licensing
profile CiscoTAC-1
  active
  destination transport-method email disable
  destination transport-method http
!
!
interface Loopback0
ipv4 address 10.129.1.1 255.255.255.255
!
interface MgmtEth0/RP0/CPU0/0
ipv4 address 10.4.33.127 255.255.255.0
!
interface MgmtEth0/RP0/CPU0/1
ipv4 address dhcp
shutdown
!
interface MgmtEth0/RP0/CPU0/2
ipv4 address 10.127.59.151 255.255.255.0
!
interface GigabitEthernet0/0/0/0
ipv4 address 10.72.1.2 255.255.255.0
!
interface PTP0/RP0/CPU0/0
shutdown
!
interface PTP0/RP0/CPU0/1
shutdown
!
router ospf 1
distribute link-state instance-id 0 throttle 5
router-id 10.129.1.1
network point-to-point
area 0
  interface Loopback0
  !
  interface GigabitEthernet0/0/0/0
  !
!
!
optical-line-control
automatic-link-bringup
!
end

```

Cross-connect Configuration

The OTS-OCH controllers are not created by default when the cards (NCS1K-ILA-2R-C, NCS1K-ILA-R-C, NCS1K-ILA-C, NCS1K-OLT-R-C, and NCS1K-OLT-C) are brought up. The LINE OTS-OCH controllers can be created using the **hw-module** command.

Optical Cross Connections can be configured only on OLT nodes. In these nodes, the OTS-OCH controller is not created automatically on the Add/Drop ports (COM side). The optical cross connect configuration defines the line side OTS-OCH channel as the source and creates an OTS-OCH controller on the ADD/Drop port to which the cross connection is made. The channel ID must be the same for both the LINE side and COM side OTS-OCH controller.

To illustrate the creation of the cross-connects, we are going to create a single channel from OLT-R-C-SITE-1 to OLT-C-SITE-8 in the topology diagram. The channel is mapped to **191.45 THz**.

Configuration for OLT-R-C-SITE-1

```
P/0/RP0/CPU0:OLT-R-C-SITE-1#config
Tue Jul 26 06:30:25.087 UTC
RP/0/RP0/CPU0:OLT-R-C-SITE-1(config)#hw-module location 0/0/NXR0 terminal-ampli grid-mode
flex
RP/0/RP0/CPU0:OLT-R-C-SITE-1(config-hwmod-olt-flexi)#channel-id 63 centre-freq 191.45 width
75
RP/0/RP0/CPU0:OLT-R-C-SITE-1(config-hwmod-olt-flexi)#commit
Tue Jul 26 06:33:03.824 UTC
RP/0/RP0/CPU0:OLT-R-C-SITE-1(config-hwmod-olt-flexi)#end
RP/0/RP0/CPU0:OLT-R-C-SITE-1#sh hw-module location 0/0/NXR0 terminal-ampli
Tue Jul 26 06:33:13.093 UTC
```

Legend:

```
NXC - Channel not cross-connected
ACTIVE - Channel cross-connected to data port
ASE - Channel filled with ASE
FAILED - Data channel failed, pending transition to ASE
```

```
Location:          0/0/NXR0
```

```
Status:           Provisioned
```

Flex Grid Info

Channel Number	Centre Frequency (THz)	Channel Width (GHz)	Channel Status
2	196.025000	75.000	ASE
17	194.900000	75.000	ACTIVE
63	191.450000	75.000	NXC

```
RP/0/RP0/CPU0:OLT-R-C-SITE-1#config
Tue Jul 26 06:33:29.885 UTC
RP/0/RP0/CPU0:OLT-R-C-SITE-1(config)#controller ots-Och 0/0/0/0/63
RP/0/RP0/CPU0:OLT-R-C-SITE-1(config-Ots)#add-drop-channel ots-Och 0/0/0/3/63
RP/0/RP0/CPU0:OLT-R-C-SITE-1(config-Ots)#commit
RP/0/RP0/CPU0:OLT-R-C-SITE-1(config-Ots)#end
RP/0/RP0/CPU0:OLT-R-C-SITE-1#sh hw-module location 0/0/NXR0 terminal-ampli
Tue Jul 26 06:34:27.110 UTC
```

Legend:

```
NXC - Channel not cross-connected
ACTIVE - Channel cross-connected to data port
ASE - Channel filled with ASE
FAILED - Data channel failed, pending transition to ASE
```

```
Location:          0/0/NXR0
```

```
Status:           Provisioned
```

Flex Grid Info

Channel Number	Centre Frequency (THz)	Channel Width (GHz)	Channel Status
2	196.025000	75.000	ASE
17	194.900000	75.000	ACTIVE
63	191.450000	75.000	ACTIVE

Configuration for ILA-2R-C

```
RP/0/RP0/CPU0:ILA-2R-C#config
Tue Jul 26 06:35:12.145 UTC
RP/0/RP0/CPU0:ILA-2R-C(config)#hw-module location 0/0/NXR0 inline-ampli
```



```
RP/0/RP0/CPU0:ILA-2R-C(config-hwmod-ila)#grid-mode flex
RP/0/RP0/CPU0:ILA-2R-C(config-hwmod-ila-flexi)#channel-id 63 centre-freq 191.45 width 75
RP/0/RP0/CPU0:ILA-2R-C(config-hwmod-ila-flexi)#commit
RP/0/RP0/CPU0:ILA-2R-C(config-hwmod-ila-flexi)#end
RP/0/RP0/CPU0:ILA-2R-C#sh hw-module location 0/0/NXR0 inline-ampli
Tue Jul 26 06:36:33.333 UTC
```

Location: 0/0/NXR0

Status: Provisioned

Flex Grid Info

Channel Number	Centre Frequency (THz)	Channel Width (GHz)
63	191.450000	75.000

```
RP/0/RP0/CPU0:ILA-2R-C#sh controllers ots-Och 0/0/0/63
Tue Jul 26 06:36:41.935 UTC
```

Controller State: Up

Transport Admin State: In Service

Alarm Status:

Detected Alarms: None

Parameter Statistics:

Total RX Power = -13.40 dBm
Total TX Power = 0.99 dBm

Configured Parameters:

```
RP/0/RP0/CPU0:ILA-2R-C#sh controllers ots-Och 0/0/0/2/63
Tue Jul 26 06:36:52.466 UTC
```

Controller State: Up

Transport Admin State: In Service

Alarm Status:

Detected Alarms: None

Parameter Statistics:

Total RX Power = -5.50 dBm
Total TX Power = 2.29 dBm

Configured Parameters:

Configuration for ILA-R-C

```
RP/0/RP0/CPU0:ILA-R-C#config
Tue Jul 26 06:36:45.377 UTC
RP/0/RP0/CPU0:ILA-R-C(config)#hw-module location 0/0/NXR0 inline-ampli grid-mode flex
```

```
RP/0/RP0/CPU0:ILA-R-C(config-hwmod-ila-flexi)#channel-id 63 centre-freq 191.45 width 75
RP/0/RP0/CPU0:ILA-R-C(config-hwmod-ila-flexi)#commit
RP/0/RP0/CPU0:ILA-R-C(config-hwmod-ila-flexi)#end
RP/0/RP0/CPU0:ILA-R-C#sh hw-module location 0/0/NXR0 inline-ampli
Tue Jul 26 06:37:08.127 UTC
```

Location: 0/0/NXR0

Status: Provisioned

Flex Grid Info

Channel Number	Centre Frequency (THz)	Channel Width (GHz)
63	191.450000	75.000

```
RP/0/RP0/CPU0:ILA-R-C#sh controllers ots-Och 0/0/0/0/63
Tue Jul 26 07:08:07.280 UTC
```

Controller State: Up

Transport Admin State: In Service

Alarm Status:

Detected Alarms: None

Parameter Statistics:

Total RX Power = -12.40 dBm

Total TX Power = 1.19 dBm

Configured Parameters:

```
RP/0/RP0/CPU0:ILA-R-C#sh controllers ots-Och 0/0/0/2/63
Tue Jul 26 07:08:10.854 UTC
```

Controller State: Up

Transport Admin State: In Service

Alarm Status:

Detected Alarms: None

Parameter Statistics:

Total RX Power = -9.10 dBm

Total TX Power = 1.39 dBm

Configured Parameters:

Configuration for ILA-C

```
RP/0/RP0/CPU0:ILA-C#config
Tue Jul 26 06:38:56.584 UTC
RP/0/RP0/CPU0:ILA-C(config)#hw-module location 0/0/NXR0 inline-ampli grid-mode flex

RP/0/RP0/CPU0:ILA-C(config-hwmod-ila-flexi)#channel-id 63 centre-freq 191.45 width 75
```

```

RP/0/RP0/CPU0:ILA-C(config-hwmod-ila-flexi)#commit
Tue Jul 26 06:39:24.378 UTC
RP/0/RP0/CPU0:ILA-C(config-hwmod-ila-flexi)#end
RP/0/RP0/CPU0:ILA-C#
RP/0/RP0/CPU0:ILA-C#sh hw-module location 0/0/NXR0 inline-ampli
Tue Jul 26 06:39:43.874 UTC

Location:                0/0/NXR0

Status:                   Provisioned

Flex Grid Info

Channel Number           Centre Frequency (THz)           Channel Width (GHz)
63                     191.450000                     75.000

RP/0/RP0/CPU0:ILA-C#sh controllers ots-Och 0/0/0/0/63
Tue Jul 26 07:10:32.333 UTC

Controller State: Up

Transport Admin State: In Service

Alarm Status:
-----
Detected Alarms: None

Parameter Statistics:
-----
Total RX Power = -15.80 dBm
Total TX Power = -0.60 dBm

Configured Parameters:
-----

RP/0/RP0/CPU0:ILA-C#sh controllers ots-Och 0/0/0/2/63
Tue Jul 26 07:10:38.238 UTC

Controller State: Up

Transport Admin State: In Service

Alarm Status:
-----
Detected Alarms: None

Parameter Statistics:
-----
Total RX Power = -11.00 dBm
Total TX Power = -1.60 dBm

Configured Parameters:
-----

```

Configuration for OLT-C-SITE-2

```

RP/0/RP0/CPU0:OLT-C-SITE-2#config
Tue Jul 26 06:38:54.139 UTC
RP/0/RP0/CPU0:OLT-C-SITE-2(config)#hw-module location 0/0/NXR0 terminal-ampli
RP/0/RP0/CPU0:OLT-C-SITE-2(config-hwmod-olt)#grid-mode flex
RP/0/RP0/CPU0:OLT-C-SITE-2(config-hwmod-olt-flexi)#channel-id 63 centre-freq 191.45 width
75

```

```
RP/0/RP0/CPU0:OLT-C-SITE-2(config-hwmod-olt-flexi)#commit
RP/0/RP0/CPU0:OLT-C-SITE-2(config-hwmod-olt-flexi)#end
RP/0/RP0/CPU0:OLT-C-SITE-2#sh hw-module location 0/0/NXR0 terminal-ampli
Tue Jul 26 06:39:23.878 UTC
```

Legend:

```
NXC - Channel not cross-connected
ACTIVE - Channel cross-connected to data port
ASE - Channel filled with ASE
FAILED - Data channel failed, pending transition to ASE
```

Location: 0/0/NXR0

Status: Provisioned

Flex Grid Info

Channel Number	Centre Frequency (THz)	Channel Width (GHz)	Channel Status
2	196.025000	75.000	ASE
17	194.900000	75.000	ACTIVE
63	191.450000	75.000	NXC

```
RP/0/RP0/CPU0:OLT-C-SITE-2#config
Tue Jul 26 06:48:25.732 UTC
RP/0/RP0/CPU0:OLT-C-SITE-2(config)#controller ots-Och 0/0/0/0/63
RP/0/RP0/CPU0:OLT-C-SITE-2(config-Ots)#add-drop-channel ots-Och 0/0/0/30/63
RP/0/RP0/CPU0:OLT-C-SITE-2(config-Ots)#commit
RP/0/RP0/CPU0:OLT-C-SITE-2(config-Ots)#end
RP/0/RP0/CPU0:OLT-C-SITE-2#sh controllers ots-Och 0/0/0/0/63
Tue Jul 26 07:10:28.928 UTC
```

Controller State: Up

Transport Admin State: In Service

```
Alarm Status:
-----
Detected Alarms: None
```

```
Parameter Statistics:
-----
Total RX Power = -11.80 dBm
Total TX Power = 0.99 dBm
```

```
Cross Connect Info:
-----
Add-Drop Channel = Ots-Och0/0/0/30/63
```

```
Configured Parameters:
-----
```

```
RP/0/RP0/CPU0:OLT-C-SITE-2#sh controllers ots-Och 0/0/0/30/63
Tue Jul 26 07:10:33.899 UTC
```

Controller State: Up

Transport Admin State: In Service

```
Alarm Status:
-----
Detected Alarms: None
```

Parameter Statistics:

```
-----
Total RX Power = -4.50 dBm
Total TX Power = -2.20 dBm
```

Cross Connect Info:

```
-----
line Channel = Ots-Och0/0/0/0/63
```

Configured Parameters:

Configuration for OLT-C-SITE-5

```
RP/0/RP0/CPU0:OLT-C-SITE-5#config
Tue Jul 26 06:50:27.739 UTC
Current Configuration Session Line User Date Lock
00001000-000044b2-00000000 con0_RP0_C cisco Fri Jul 22 11:53:12 2022
RP/0/RP0/CPU0:OLT-C-SITE-5(config)#hw-module location 0/0/NXR0 terminal-ampli grid-mode
flex
RP/0/RP0/CPU0:OLT-C-SITE-5(config-hwmod-olt-flexi)#channel-id 63 centre-freq 191.45 width
75
RP/0/RP0/CPU0:OLT-C-SITE-5(config-hwmod-olt-flexi)#commit
Tue Jul 26 06:50:54.786 UTC
RP/0/RP0/CPU0:OLT-C-SITE-5(config-hwmod-olt-flexi)#end
RP/0/RP0/CPU0:OLT-C-SITE-5#sh hw-module location 0/0/NXR0 terminal-ampli
Tue Jul 26 06:51:01.966 UTC
```

Legend:

```
NXC - Channel not cross-connected
ACTIVE - Channel cross-connected to data port
ASE - Channel filled with ASE
FAILED - Data channel failed, pending transition to ASE
```

```
Location: 0/0/NXR0
```

```
Status: Provisioned
```

Flex Grid Info

Channel Number	Centre Frequency (THz)	Channel Width (GHz)	Channel Status
1	196.100000	75.000	ACTIVE
3	195.950000	75.000	ASE
5	195.800000	75.000	ASE
17	194.900000	75.000	ACTIVE
59	191.750000	75.000	ACTIVE
61	191.600000	75.000	ACTIVE
62	191.525000	75.000	ASE
63	191.450000	75.000	NXC
64	191.375000	75.000	ACTIVE

```
RP/0/RP0/CPU0:OLT-C-SITE-5#config
Tue Jul 26 06:51:05.833 UTC
Current Configuration Session Line User Date Lock
00001000-000044b2-00000000 con0_RP0_C cisco Fri Jul 22 11:53:12 2022
RP/0/RP0/CPU0:OLT-C-SITE-5(config)#controller ots-Och 0/0/0/0/63
RP/0/RP0/CPU0:OLT-C-SITE-5(config-Ots)#add-drop-channel ots-Och 0/0/0/30/63
RP/0/RP0/CPU0:OLT-C-SITE-5(config-Ots)#commit
RP/0/RP0/CPU0:OLT-C-SITE-5(config-Ots)#end
RP/0/RP0/CPU0:OLT-C-SITE-5#
RP/0/RP0/CPU0:OLT-C-SITE-5#sh controllers ots-Och 0/0/0/0/63
Tue Jul 26 07:12:50.904 UTC
```

Controller State: Up

Transport Admin State: In Service

Alarm Status:

Detected Alarms: None

Parameter Statistics:

Total RX Power = -11.00 dBm
Total TX Power = 1.89 dBm

Cross Connect Info:

Add-Drop Channel = Ots-Och0/0/0/30/63

Configured Parameters:

RP/0/RP0/CPU0:OLT-C-SITE-5#sh controllers ots-Och 0/0/0/30/63
Tue Jul 26 07:12:54.871 UTC

Controller State: Up

Transport Admin State: In Service

Alarm Status:

Detected Alarms: None

Parameter Statistics:

Total RX Power = -3.70 dBm
Total TX Power = -2.70 dBm

Cross Connect Info:

line Channel = Ots-Och0/0/0/0/63

Configured Parameters:

Configuration for OLT-C-SITE-8

```
RP/0/RP0/CPU0:OLT-C-SITE-8#config
Tue Jul 26 06:56:26.764 UTC
Current Configuration Session Line      User      Date                               Lock
00001000-0000345b-00000000      con0_RP0_C cisco     Fri Jul 22 11:54:38 2022
RP/0/RP0/CPU0:OLT-C-SITE-8(config)#controller ots-Och 0/0/0/0/63
RP/0/RP0/CPU0:OLT-C-SITE-8(config-Ots)#add-drop-channel ots-Och 0/0/0/3/63
RP/0/RP0/CPU0:OLT-C-SITE-8(config-Ots)#commit
Tue Jul 26 06:56:46.290 UTC
RP/0/RP0/CPU0:OLT-C-SITE-8(config-Ots)#end
RP/0/RP0/CPU0:OLT-C-SITE-8#sh hw-module location 0/0/NXR0 terminal-ampli
Tue Jul 26 06:57:06.011 UTC
```

Legend:
NXC - Channel not cross-connected

ACTIVE - Channel cross-connected to data port
 ASE - Channel filled with ASE
 FAILED - Data channel failed, pending transition to ASE

Location: 0/0/NXR0

Status: Provisioned

Flex Grid Info

Channel Number	Centre Frequency (THz)	Channel Width (GHz)	Channel Status
1	196.100000	75.000	ACTIVE
3	195.950000	75.000	NXC
5	195.800000	75.000	ACTIVE
17	194.900000	75.000	ACTIVE
59	191.750000	75.000	ACTIVE
63	191.450000	75.000	ACTIVE
64	191.375000	75.000	ACTIVE

RP/0/RP0/CPU0:OLT-C-SITE-8#sh controllers ots-Och 0/0/0/0/63
 Tue Jul 26 06:57:28.630 UTC

Controller State: Up

Transport Admin State: In Service

Alarm Status:

 Detected Alarms: None

Parameter Statistics:

 Total RX Power = -13.20 dBm
 Total TX Power = -1.50 dBm

Cross Connect Info:

 Add-Drop Channel = Ots-Och0/0/0/3/63

Configured Parameters:

RP/0/RP0/CPU0:OLT-C-SITE-8#sh controllers ots-Och 0/0/0/3/63
 Tue Jul 26 06:57:35.129 UTC

Controller State: Up

Transport Admin State: Automatic In Service

Alarm Status:

 Detected Alarms: None

Parameter Statistics:

 Total RX Power = -7.50 dBm
 Total TX Power = -21.80 dBm

```
Cross Connect Info:
-----
line Channel = Ots-Och0/0/0/0/63
```

```
Configured Parameters:
-----
```

After the cross-connects are created on the OLT nodes, APC regulates the power on each node. The APC status moves from WORKING to IDLE when the process completes. Use the **show olc apc** command to view the status of the operation. The following samples are for OLT-C-SITE-8.

```
RP/0/RP0/CPU0:OLT-C-SITE-8#sh olc apc
Tue Jul 26 06:57:16.020 UTC
```

```
Controller      : Ots0/0/0/0
APC Status    : WORKING
Correcting Node : 10.123.1.1
```

```
Node RID       : 10.125.1.1
Internal State : IDLE
```

```
Node RID       : 10.123.1.1
Internal State : CORRECTING
```

```
RP/0/RP0/CPU0:OLT-C-SITE-8#sh olc apc
Tue Jul 26 06:59:11.985 UTC
```

```
Controller      : Ots0/0/0/0
APC Status    : IDLE
```

```
Node RID       : 10.125.1.1
Internal State : IDLE
```

```
Node RID       : 10.123.1.1
Internal State : IDLE
```

After the APC process is complete, the link comes up. You can view the details using the **sh olc apc-local regulation-info controller ots** command on the near-end and far-end nodes.

OLT-R-C-SITE-1:

```
RP/0/RP0/CPU0:OLT-R-C-SITE-1#sh olc apc-local regulation-info controller ots 0/0/0/0
Tue Jul 26 07:02:57.244 UTC
Controller      : Ots0/0/0/0
Domain Manager  : 10.131.1.1
Internal Status : IDLE
Direction      : TX
PSD Minimum     : -22.0 (dBm/12.5 GHz)
Gain Range      : Normal
Last Correction : 2022-07-26 06:34:43
```

Device Parameters	Min	Max	Configuration	Operational
Egress Ampli Gain (dB)	15.3	29.3	17.9	17.9
Egress Ampli Tilt (dB)	-5.0	4.3	-1.6	-1.6
TX Ampli Power (dBm)	-	22.3	-	21.6
TX VOA Attenuation (dB)	0.0	20.0	1.3	1.3
Egress WSS/DGE Attenuation (dB)	0.0	25.0	-	-

Channel Center Frequency (THz)	Channel Slice Width (GHz)	Channel ID	Channel Source	Spectrum Slice Num	Ampli-Input PSD (dBm/12.5 GHz)	Target PSD (dBm/12.5 GHz)	Current PSD (dBm/12.5 GHz)
Discrepancy							

191.375000	75.00	-	ASE	13	-21.2	-5.7	-5.7
0.0	7.3						
191.449997	75.00	63	OCh	37	-21.5	-5.7	-5.9
0.2	19.0						
191.524994	75.00	-	ASE	61	-21.3	-5.7	-5.7
0.0	7.3						
191.600006	75.00	-	ASE	85	-21.2	-5.6	-5.6
0.0	7.3						
191.675003	75.00	-	ASE	109	-21.2	-5.6	-5.6
0.0	7.4						
191.750000	75.00	-	ASE	133	-21.1	-5.5	-5.5
0.0	7.3						
191.824997	75.00	-	ASE	157	-21.1	-5.5	-5.5
0.0	7.3						
191.899994	75.00	-	ASE	181	-21.1	-5.5	-5.5
0.0	7.3						
191.975006	75.00	-	ASE	205	-21.2	-5.5	-5.5
0.0	7.4						
192.050003	75.00	-	ASE	229	-21.1	-5.4	-5.4
0.0	7.2						
192.125000	75.00	-	ASE	253	-21.1	-5.4	-5.4
0.0	7.2						
192.199997	75.00	-	ASE	277	-21.0	-5.4	-5.4
0.0	7.2						
192.274994	75.00	-	ASE	301	-21.1	-5.4	-5.4
0.0	7.2						
192.350006	75.00	-	ASE	325	-21.0	-5.3	-5.3
0.0	7.0						
192.425003	75.00	-	ASE	349	-21.0	-5.3	-5.3
0.0	6.9						
192.500000	75.00	-	ASE	373	-21.0	-5.3	-5.4
0.1	7.0						
192.574997	75.00	-	ASE	397	-20.9	-5.3	-5.3
0.0	7.0						
192.649994	75.00	-	ASE	421	-20.9	-5.2	-5.2
0.0	7.0						
192.725006	75.00	-	ASE	445	-20.9	-5.2	-5.2
0.0	6.9						
192.800003	75.00	-	ASE	469	-20.9	-5.2	-5.2
0.0	6.9						
192.875000	75.00	-	ASE	493	-20.9	-5.2	-5.2
0.0	6.9						
192.949997	75.00	-	ASE	517	-20.8	-5.1	-5.1
0.0	6.8						
193.024994	75.00	-	ASE	541	-20.9	-5.1	-5.1
0.0	6.8						
193.100006	75.00	-	ASE	565	-20.9	-5.1	-5.1
0.0	6.7						
193.175003	75.00	-	ASE	589	-20.9	-5.1	-5.1
0.0	6.6						
193.250000	75.00	-	ASE	613	-20.8	-5.0	-5.0
0.0	6.5						
193.324997	75.00	-	ASE	637	-20.9	-5.0	-5.1
0.0	6.6						
193.399994	75.00	-	ASE	661	-20.8	-5.0	-5.0
0.0	6.5						
193.475006	75.00	-	ASE	685	-20.9	-5.0	-5.0
0.0	6.5						
193.550003	75.00	-	ASE	709	-20.9	-4.9	-4.9
0.0	6.5						
193.625000	75.00	-	ASE	733	-20.9	-4.9	-4.9
0.0	6.5						
193.699997	75.00	-	ASE	757	-20.9	-4.9	-4.9
0.0	6.5						
193.774994	75.00	-	ASE	781	-21.0	-4.9	-4.9
0.0	6.6						
193.850006	75.00	-	ASE	805	-20.9	-4.8	-4.8
0.0	6.5						
193.925003	75.00	-	ASE	829	-21.0	-4.8	-4.8
0.0	6.6						
194.000000	75.00	-	ASE	853	-21.0	-4.8	-4.8
0.0	6.6						
194.074997	75.00	-	ASE	877	-21.0	-4.8	-4.7
0.0	6.6						
194.149994	75.00	-	ASE	901	-21.0	-4.7	-4.7
0.0	6.7						
194.225006	75.00	-	ASE	925	-21.0	-4.7	-4.7
0.0	6.8						
194.300003	75.00	-	ASE	949	-21.1	-4.7	-4.7
0.0	6.9						
194.375000	75.00	-	ASE	973	-21.0	-4.7	-4.6
0.0	6.9						
194.449997	75.00	-	ASE	997	-21.0	-4.6	-4.6
0.0	6.9						

Cross-connect Configuration

194.524994	75.00	-	ASE	1021	-21.1	-4.6	-4.7
0.0	7.0						
194.600006	75.00	-	ASE	1045	-21.1	-4.6	-4.6
0.0	6.9						
194.675003	75.00	-	ASE	1069	-21.1	-4.6	-4.6
0.0	6.9						
194.750000	75.00	-	ASE	1093	-21.1	-4.5	-4.5
0.0	6.8						
194.824997	75.00	-	ASE	1117	-21.0	-4.5	-4.5
0.0	6.7						
194.899994	75.00	17	OCh	1141	-21.2	-4.5	-4.5
0.0	19.5						
194.975006	75.00	-	ASE	1165	-21.1	-4.5	-4.5
0.0	6.6						
195.050003	75.00	-	ASE	1189	-21.0	-4.4	-4.4
0.0	6.4						
195.125000	75.00	-	ASE	1213	-21.1	-4.4	-4.4
0.0	6.4						
195.199997	75.00	-	ASE	1237	-21.1	-4.4	-4.4
0.0	6.3						
195.274994	75.00	-	ASE	1261	-21.2	-4.4	-4.5
0.1	6.3						
195.350006	75.00	-	ASE	1285	-21.2	-4.3	-4.3
0.0	6.2						
195.425003	75.00	-	ASE	1309	-21.3	-4.3	-4.3
0.0	6.2						
195.500000	75.00	-	ASE	1333	-21.3	-4.3	-4.3
0.0	6.2						
195.574997	75.00	-	ASE	1357	-21.5	-4.3	-4.4
0.1	6.3						
195.649994	75.00	-	ASE	1381	-21.5	-4.2	-4.3
0.0	6.4						
195.725006	75.00	-	ASE	1405	-21.5	-4.2	-4.1
-0.1	6.5						
195.800003	75.00	-	ASE	1429	-21.7	-4.2	-4.2
0.0	6.8						
195.875000	75.00	-	ASE	1453	-21.9	-4.2	-4.3
0.1	7.1						
195.949997	75.00	-	ASE	1477	-21.8	-4.2	-4.0
-0.1	7.1						
196.024994	75.00	2	ASE	1501	-21.9	-4.1	-4.1
0.0	7.3						
196.100006	75.00	-	ASE	1525	-21.9	-4.1	-4.0
-0.1	7.4						

```

Controller          : Ots0/0/0/0
Domain Manager     : 10.126.1.1
Internal Status    : IDLE
Direction          : RX
PSD Minimum        : -22.0 (dBm/12.5 GHz)
Gain Range         : Normal
Last Correction    : 2022-07-26 06:57:17

```

Device Parameters	Min	Max	Configuration	Operational
Ingress Ampli Gain (dB)	10.9	23.9	10.9	10.9
Ingress Ampli Tilt (dB)	-5.0	5.0	-1.6	-1.6
RX Ampli Power (dBm)	-	25.0	-	24.2
RX VOA Attenuation (dB)	0.0	0.0	0.0	0.0
Ingress WSS/DGE Attenuation (dB)	0.0	25.0	-	-

Channel Center Frequency (THz)	Channel Channel Width Attn Config (GHz)	Channel ID	Channel Source	Spectrum Slice Num	Ampli-Input PSD (dBm/12.5 GHz)	Target PSD (dBm/12.5 GHz)	Current PSD (dBm/12.5 GHz)
191.375000	75.00	-	ASE	13	-11.1	-	-25.5
0.0	25.0						
191.449997	75.00	63	OCh	37	-11.1	-8.0	-8.1
0.0	2.9						
191.524994	75.00	-	ASE	61	-11.0	-	-25.4
0.0	25.0						
191.600006	75.00	-	ASE	85	-11.0	-	-25.2
0.0	25.0						
191.675003	75.00	-	ASE	109	-11.0	-	-25.3
0.0	25.0						
191.750000	75.00	-	ASE	133	-11.0	-	-25.4
0.0	25.0						
191.824997	75.00	-	ASE	157	-11.4	-	-25.6

0.0	25.0						
191.899994	75.00	-	ASE	181	-11.4	-	-25.6
0.0	25.0						
191.975006	75.00	-	ASE	205	-11.1	-	-25.4
0.0	25.0						
192.050003	75.00	-	ASE	229	-11.0	-	-25.3
0.0	25.0						
192.125000	75.00	-	ASE	253	-11.1	-	-25.4
0.0	25.0						
192.199997	75.00	-	ASE	277	-11.4	-	-25.6
0.0	25.0						
192.274994	75.00	-	ASE	301	-11.5	-	-25.7
0.0	25.0						
192.350006	75.00	-	ASE	325	-11.3	-	-25.7
0.0	25.0						
192.425003	75.00	-	ASE	349	-11.5	-	-25.7
0.0	25.0						
192.500000	75.00	-	ASE	373	-11.6	-	-25.8
0.0	25.0						
192.574997	75.00	-	ASE	397	-11.6	-	-25.7
0.0	25.0						
192.649994	75.00	-	ASE	421	-11.7	-	-25.9
0.0	25.0						
192.725006	75.00	-	ASE	445	-11.8	-	-26.1
0.0	25.0						
192.800003	75.00	-	ASE	469	-11.9	-	-26.1
0.0	25.0						
192.875000	75.00	-	ASE	493	-11.8	-	-26.0
0.0	25.0						
192.949997	75.00	-	ASE	517	-12.0	-	-26.2
0.0	25.0						
193.024994	75.00	-	ASE	541	-12.0	-	-26.1
0.0	25.0						
193.100006	75.00	-	ASE	565	-11.9	-	-26.1
0.0	25.0						
193.175003	75.00	-	ASE	589	-12.0	-	-26.3
0.0	25.0						
193.250000	75.00	-	ASE	613	-11.9	-	-26.1
0.0	25.0						
193.324997	75.00	-	ASE	637	-11.9	-	-26.1
0.0	25.0						
193.399994	75.00	-	ASE	661	-12.0	-	-26.2
0.0	25.0						
193.475006	75.00	-	ASE	685	-12.0	-	-26.2
0.0	25.0						
193.550003	75.00	-	ASE	709	-12.0	-	-26.1
0.0	25.0						
193.625000	75.00	-	ASE	733	-11.9	-	-26.0
0.0	25.0						
193.699997	75.00	-	ASE	757	-11.6	-	-25.8
0.0	25.0						
193.774994	75.00	-	ASE	781	-11.6	-	-25.7
0.0	25.0						
193.850006	75.00	-	ASE	805	-11.5	-	-25.6
0.0	25.0						
193.925003	75.00	-	ASE	829	-11.4	-	-25.6
0.0	25.0						
194.000000	75.00	-	ASE	853	-11.5	-	-25.6
0.0	25.0						
194.074997	75.00	-	ASE	877	-11.6	-	-25.6
0.0	25.0						
194.149994	75.00	-	ASE	901	-11.7	-	-25.6
0.0	25.0						
194.225006	75.00	-	ASE	925	-11.8	-	-25.6
0.0	25.0						
194.300003	75.00	-	ASE	949	-12.0	-	-25.8
0.0	25.0						
194.375000	75.00	-	ASE	973	-12.0	-	-25.8
0.0	25.0						
194.449997	75.00	-	ASE	997	-12.1	-	-25.9
0.0	25.0						
194.524994	75.00	-	ASE	1021	-12.2	-	-25.9
0.0	25.0						
194.600006	75.00	-	ASE	1045	-12.2	-	-26.0
0.0	25.0						
194.675003	75.00	-	ASE	1069	-12.2	-	-26.0
0.0	25.0						
194.750000	75.00	-	ASE	1093	-12.3	-	-26.0
0.0	25.0						
194.824997	75.00	-	ASE	1117	-12.4	-	-26.1
0.0	25.0						
194.899994	75.00	17	OCh	1141	-12.3	-8.0	-8.1
-0.1	2.0						
194.975006	75.00	-	ASE	1165	-12.1	-	-26.0
0.0	25.0						
195.050003	75.00	-	ASE	1189	-12.0	-	-25.9

Cross-connect Configuration

```

0.0          25.0
195.125000  75.00 - ASE 1213 -12.0 - -25.9
0.0          25.0
195.199997  75.00 - ASE 1237 -12.0 - -26.0
0.0          25.0
195.274994  75.00 - ASE 1261 -11.8 - -25.7
0.0          25.0
195.350006  75.00 - ASE 1285 -11.7 - -25.6
0.0          25.0
195.425003  75.00 - ASE 1309 -11.6 - -25.5
0.0          25.0
195.500000  75.00 - ASE 1333 -11.7 - -25.6
0.0          25.0
195.574997  75.00 - ASE 1357 -11.8 - -25.4
0.0          25.0
195.649994  75.00 - ASE 1381 -11.4 - -25.1
0.0          25.0
195.725006  75.00 - ASE 1405 -11.5 - -25.1
0.0          25.0
195.800003  75.00 - ASE 1429 -11.7 - -25.1
0.0          25.0
195.875000  75.00 - ASE 1453 -11.8 - -25.0
0.0          25.0
195.949997  75.00 - ASE 1477 -11.6 - -24.7
0.0          25.0
196.024994  75.00 2 ASE 1501 -11.9 -9.0 -8.9
-0.1        4.5
196.100006  75.00 - ASE 1525 -11.9 - -24.8
0.0          25.0

```

OLT-C-SITE-8:

```

RP/0/RP0/CPU0:OLT-C-SITE-8#sh olc apc-local regulation-info controller ots 0/0/0 tX
Tue Jul 26 06:59:33.786 UTC
Controller      : Ots0/0/0/0
Domain Manager  : 10.125.1.1
Internal Status : IDLE
Direction      : TX
PSD Minimum    : -24.0 (dBm/12.5 GHz)
Gain Range     : Normal
Last Correction : 2022-07-26 06:57:09

```

Device Parameters	Min	Max	Configuration	Operational
Egress Ampli Gain (dB)	16.0	30.0	20.3	20.3
Egress Ampli Tilt (dB)	-5.0	3.0	-1.5	-1.5
TX Ampli Power (dBm)	-	23.0	-	22.1
TX VOA Attenuation (dB)	0.0	20.0	5.5	5.5
Egress WSS/DGE Attenuation (dB)	0.0	25.0	-	-

Channel Center Frequency (THz)	Channel Channel Slice Width Attn Config (GHz)	Channel ID	Channel Source	Spectrum Slice Num	Ampli-Input PSD (dBm/12.5 GHz)	Target PSD (dBm/12.5 GHz)	Current PSD (dBm/12.5 GHz)
191.375000	75.00	64	OCh	13	-23.0	-8.6	-8.6
0.0	20.2						
191.449997	75.00	63	OCh	37	-23.0	-8.6	-8.6
0.0	18.3						
191.524994	75.00	-	ASE	61	-23.0	-8.6	-8.6
0.0	7.7						
191.600006	75.00	-	ASE	85	-23.1	-8.6	-8.7
0.1	7.8						
191.675003	75.00	-	ASE	109	-23.0	-8.6	-8.6
0.0	7.6						
191.750000	75.00	59	OCh	133	-23.0	-8.5	-8.6
0.0	20.0						
191.824997	75.00	-	ASE	157	-23.1	-8.5	-8.5
0.0	7.8						
191.899994	75.00	-	ASE	181	-23.0	-8.5	-8.5
0.0	7.7						
191.975006	75.00	-	ASE	205	-23.0	-8.5	-8.5
0.0	7.7						
192.050003	75.00	-	ASE	229	-23.0	-8.4	-8.4
0.0	7.6						
192.125000	75.00	-	ASE	253	-23.0	-8.4	-8.5
0.0	7.7						
192.199997	75.00	-	ASE	277	-23.1	-8.4	-8.5
0.1	7.8						

192.274994	75.00	-	ASE	301	-22.9	-8.4	-8.3
0.0	7.6						
192.350006	75.00	-	ASE	325	-22.9	-8.3	-8.4
0.0	7.5						
192.425003	75.00	-	ASE	349	-22.9	-8.3	-8.3
0.0	7.5						
192.500000	75.00	-	ASE	373	-22.8	-8.3	-8.3
0.0	7.5						
192.574997	75.00	-	ASE	397	-23.0	-8.3	-8.4
0.1	7.6						
192.649994	75.00	-	ASE	421	-22.8	-8.2	-8.2
0.0	7.4						
192.725006	75.00	-	ASE	445	-22.8	-8.2	-8.3
0.0	7.4						
192.800003	75.00	-	ASE	469	-22.9	-8.2	-8.3
0.1	7.5						
192.875000	75.00	-	ASE	493	-22.8	-8.2	-8.3
0.1	7.5						
192.949997	75.00	-	ASE	517	-22.7	-8.1	-8.0
-0.1	7.3						
193.024994	75.00	-	ASE	541	-22.7	-8.1	-8.2
0.0	7.3						
193.100006	75.00	-	ASE	565	-22.7	-8.1	-8.1
0.0	7.2						
193.175003	75.00	-	ASE	589	-22.7	-8.1	-8.2
0.1	7.2						
193.250000	75.00	-	ASE	613	-22.7	-8.1	-8.1
0.0	7.2						
193.324997	75.00	-	ASE	637	-22.6	-8.0	-8.0
0.0	7.0						
193.399994	75.00	-	ASE	661	-22.7	-8.0	-8.1
0.0	7.1						
193.475006	75.00	-	ASE	685	-22.7	-8.0	-8.0
0.0	7.1						
193.550003	75.00	-	ASE	709	-22.6	-8.0	-7.9
0.0	7.1						
193.625000	75.00	-	ASE	733	-22.6	-7.9	-7.9
0.0	7.1						
193.699997	75.00	-	ASE	757	-22.7	-7.9	-7.9
0.0	7.1						
193.774994	75.00	-	ASE	781	-22.6	-7.9	-7.9
0.0	7.0						
193.850006	75.00	-	ASE	805	-22.8	-7.9	-8.0
0.1	7.2						
193.925003	75.00	-	ASE	829	-22.6	-7.8	-7.8
0.0	7.0						
194.000000	75.00	-	ASE	853	-22.8	-7.8	-8.0
0.1	7.1						
194.074997	75.00	-	ASE	877	-22.7	-7.8	-7.8
0.0	7.1						
194.149994	75.00	-	ASE	901	-22.8	-7.8	-7.8
0.0	7.2						
194.225006	75.00	-	ASE	925	-22.8	-7.8	-7.8
0.0	7.2						
194.300003	75.00	-	ASE	949	-22.9	-7.7	-7.8
0.0	7.3						
194.375000	75.00	-	ASE	973	-22.8	-7.7	-7.7
0.0	7.3						
194.449997	75.00	-	ASE	997	-22.9	-7.7	-7.8
0.1	7.4						
194.524994	75.00	-	ASE	1021	-22.7	-7.7	-7.5
-0.1	7.2						
194.600006	75.00	-	ASE	1045	-22.8	-7.6	-7.6
0.0	7.3						
194.675003	75.00	-	ASE	1069	-22.8	-7.6	-7.6
0.0	7.3						
194.750000	75.00	-	ASE	1093	-22.8	-7.6	-7.6
0.0	7.2						
194.824997	75.00	-	ASE	1117	-22.8	-7.6	-7.5
0.0	7.1						
194.899994	75.00	17	OCh	1141	-22.9	-7.5	-7.5
0.0	18.8						
194.975006	75.00	-	ASE	1165	-22.8	-7.5	-7.5
0.0	7.0						
195.050003	75.00	-	ASE	1189	-22.9	-7.5	-7.5
0.0	7.1						
195.125000	75.00	-	ASE	1213	-22.8	-7.5	-7.4
0.0	6.9						
195.199997	75.00	-	ASE	1237	-22.9	-7.4	-7.4
0.0	6.8						
195.274994	75.00	-	ASE	1261	-22.9	-7.4	-7.4
0.0	6.8						
195.350006	75.00	-	ASE	1285	-23.0	-7.4	-7.4
0.0	6.9						
195.425003	75.00	-	ASE	1309	-23.1	-7.4	-7.4
0.0	7.0						

Cross-connect Configuration

195.500000	75.00	-	ASE	1333	-23.1	-7.3	-7.4
0.0	6.8						
195.574997	75.00	-	ASE	1357	-23.1	-7.3	-7.3
0.0	6.8						
195.649994	75.00	-	ASE	1381	-23.3	-7.3	-7.4
0.1	7.0						
195.725006	75.00	-	ASE	1405	-23.3	-7.3	-7.4
0.1	7.1						
195.800003	75.00	5	OCh	1429	-23.3	-7.2	-7.2
0.0	19.1						
195.875000	75.00	-	ASE	1453	-23.5	-7.2	-7.2
0.0	7.3						
195.949997	75.00	-	ASE	1477	-23.6	-7.2	-7.2
0.0	7.4						
196.024994	75.00	-	ASE	1501	-23.8	-7.2	-7.3
0.1	7.6						
196.100006	75.00	1	OCh	1525	-23.7	-7.2	-7.1
0.0	19.4						

ASE - Noise Loaded Channel
OCh - Optical Channel

```
RP/0/RP0/CPU0:OLT-C-SITE-8#sh olc apc-local regulation-info controller ots 0/0/0/0 rx
Tue Jul 26 06:59:42.151 UTC
Controller      : Ots0/0/0/0
Domain Manager  : 10.123.1.1
Internal Status : DISCREPANCY
Direction      : RX
PSD Minimumum  : -24.0 (dBm/12.5 GHz)
Gain Range     : Normal
Last Correction : 2022-07-26 06:59:39
```

Device Parameters	Min	Max	Configuration	Operational
Ingress Ampli Gain (dB)	12.0	25.0	19.7	19.7
Ingress Ampli Tilt (dB)	-5.0	1.8	0.4	0.4
RX Ampli Power (dBm)	-	25.0	-	24.2
RX VOA Attenuation (dB)	0.0	0.0	0.0	0.0
Ingress WSS/DGE Attenuation (dB)	0.0	25.0	-	-

Channel Center Discrepancy	Channel Channel Slice Frequency Width Attn Config (GHz)	Channel ID	Channel Source	Spectrum Slice Num	Ampli-Input PSD (dBm/12.5 GHz)	Target PSD (dBm/12.5 GHz)	Current PSD (dBm/12.5 GHz)
191.375000	75.00	64	OCh	13	-20.7	-8.0	-8.1
0.1	5.1						
191.449997	75.00	63	OCh	37	-20.6	-8.0	-22.4
14.4	15.3						
191.524994	75.00	62	ASE	61	-20.6	-	-25.6
0.0	25.0						
191.600006	75.00	61	OCh	85	-20.6	-	-25.6
0.0	25.0						
191.675003	75.00	-	ASE	109	-20.4	-	-25.4
0.0	25.0						
191.750000	75.00	59	OCh	133	-20.4	-8.0	-8.1
0.0	5.4						
191.824997	75.00	-	ASE	157	-20.4	-	-25.4
0.0	25.0						
191.899994	75.00	-	ASE	181	-20.5	-	-25.5
0.0	25.0						
191.975006	75.00	-	ASE	205	-20.4	-	-25.4
0.0	25.0						
192.050003	75.00	-	ASE	229	-20.4	-	-25.4
0.0	25.0						
192.125000	75.00	-	ASE	253	-20.3	-	-25.3
0.0	25.0						
192.199997	75.00	-	ASE	277	-20.4	-	-25.4
0.0	25.0						
192.274994	75.00	-	ASE	301	-20.5	-	-25.4
0.0	25.0						
192.350006	75.00	-	ASE	325	-20.1	-	-25.2
0.0	25.0						
192.425003	75.00	-	ASE	349	-20.2	-	-25.3
0.0	25.0						
192.500000	75.00	-	ASE	373	-20.3	-	-25.3
0.0	25.0						
192.574997	75.00	-	ASE	397	-20.4	-	-25.4
0.0	25.0						

192.649994	75.00	-	ASE	421	-20.4	-	-25.3
0.0	25.0						
192.725006	75.00	-	ASE	445	-20.3	-	-25.3
0.0	25.0						
192.800003	75.00	-	ASE	469	-20.3	-	-25.3
0.0	25.0						
192.875000	75.00	-	ASE	493	-20.3	-	-25.4
0.0	25.0						
192.949997	75.00	-	ASE	517	-20.3	-	-25.3
0.0	25.0						
193.024994	75.00	-	ASE	541	-20.2	-	-25.3
0.0	25.0						
193.100006	75.00	-	ASE	565	-20.3	-	-25.4
0.0	25.0						
193.175003	75.00	-	ASE	589	-20.3	-	-25.3
0.0	25.0						
193.250000	75.00	-	ASE	613	-20.3	-	-25.5
0.0	25.0						
193.324997	75.00	-	ASE	637	-20.2	-	-25.3
0.0	25.0						
193.399994	75.00	-	ASE	661	-20.4	-	-25.5
0.0	25.0						
193.475006	75.00	-	ASE	685	-20.4	-	-25.5
0.0	25.0						
193.550003	75.00	-	ASE	709	-20.5	-	-25.6
0.0	25.0						
193.625000	75.00	-	ASE	733	-20.4	-	-25.5
0.0	25.0						
193.699997	75.00	-	ASE	757	-20.3	-	-25.4
0.0	25.0						
193.774994	75.00	-	ASE	781	-20.4	-	-25.5
0.0	25.0						
193.850006	75.00	-	ASE	805	-20.4	-	-25.5
0.0	25.0						
193.925003	75.00	-	ASE	829	-20.3	-	-25.4
0.0	25.0						
194.000000	75.00	-	ASE	853	-20.3	-	-25.4
0.0	25.0						
194.074997	75.00	-	ASE	877	-20.4	-	-25.5
0.0	25.0						
194.149994	75.00	-	ASE	901	-20.5	-	-25.5
0.0	25.0						
194.225006	75.00	-	ASE	925	-20.4	-	-25.4
0.0	25.0						
194.300003	75.00	-	ASE	949	-20.4	-	-25.5
0.0	25.0						
194.375000	75.00	-	ASE	973	-20.4	-	-25.4
0.0	25.0						
194.449997	75.00	-	ASE	997	-20.4	-	-25.5
0.0	25.0						
194.524994	75.00	-	ASE	1021	-20.4	-	-25.4
0.0	25.0						
194.600006	75.00	-	ASE	1045	-20.4	-	-25.4
0.0	25.0						
194.675003	75.00	-	ASE	1069	-20.4	-	-25.5
0.0	25.0						
194.750000	75.00	-	ASE	1093	-20.4	-	-25.4
0.0	25.0						
194.824997	75.00	-	ASE	1117	-20.4	-	-25.4
0.0	25.0						
194.899994	75.00	17	OCh	1141	-20.2	-8.0	-8.0
0.0	2.1						
194.975006	75.00	-	ASE	1165	-20.3	-	-25.5
0.0	25.0						
195.050003	75.00	-	ASE	1189	-20.2	-	-25.5
0.0	25.0						
195.125000	75.00	-	ASE	1213	-20.3	-	-25.6
0.0	25.0						
195.199997	75.00	-	ASE	1237	-20.3	-	-25.6
0.0	25.0						
195.274994	75.00	-	ASE	1261	-20.2	-	-25.6
0.0	25.0						
195.350006	75.00	-	ASE	1285	-20.2	-	-25.6
0.0	25.0						
195.425003	75.00	-	ASE	1309	-20.0	-	-25.5
0.0	25.0						
195.500000	75.00	-	ASE	1333	-20.1	-	-25.6
0.0	25.0						
195.574997	75.00	-	ASE	1357	-20.1	-	-25.6
0.0	25.0						
195.649994	75.00	-	ASE	1381	-19.9	-	-25.5
0.0	25.0						
195.725006	75.00	-	ASE	1405	-19.8	-	-25.4
0.0	25.0						
195.800003	75.00	5	ASE	1429	-19.9	-8.0	-7.9
0.0	1.8						

195.875000	75.00	-	ASE	1453	-19.8	-	-25.3
0.0	25.0						
195.949997	75.00	3	ASE	1477	-19.7	-	-25.2
0.0	25.0						
196.024994	75.00	-	ASE	1501	-19.7	-	-25.0
0.0	25.0						
196.100006	75.00	1	OCh	1525	-19.5	-8.0	-8.1
0.0	6.0						

ASE - Noise Loaded Channel
OCh - Optical Channel

Bringup NCS 1010 Using ZTP

Perform the configurations in the following sequence to bring up NCS 1010 using ZTP.

- [DHCP Configuration, on page 7](#)
- [ZTP Configuration Files Creation, on page 47](#)
- [ZTP Configuration Workflow, on page 54](#)
- [Cross-connect Configuration, on page 27](#)

DHCP Configuration

DHCP configuration is required for both manual configuration and ZTP configuration.

To run iPXE and ZTP, you need a DHCP server. To configure a DHCP server, you must edit the `dhcpd.conf` file available at `/etc/dhcp/`. This configuration file stores the network information such as the path to the script, location of the ISO install file, location of the provisioning configuration (`.cfg`) file, and serial number or the MAC address of the chassis.

In the following example, the settings in the `dhcpd.conf` refers to the span connecting OLT-R-C-SITE-1 to OLT-C-SITE-2.

Figure 5: Network Topology Diagram

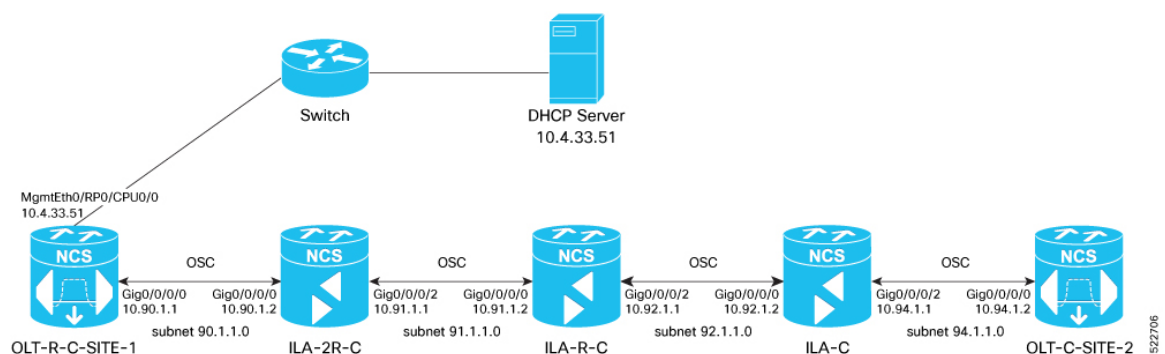

Note Restart the `dhcpd` service using the `service dhcpd restart` command every time you edit the `dhcpd.conf` file.

Add the following settings to the `dhcpd.conf` file :



Note The ZTP configuration files (*.cfg) that are referenced in the `dhcpd.conf` file are detailed in [ZTP Configuration Files Creation](#), on page 47.

```
# DHCP Server Configuration file
ddns-update-style none;
option domain-name "cisco.com";
option domain-name-servers dns-blr1.cisco.com;

default-lease-time 6000;
max-lease-time 72000;

log-facility local7;

option space VendorInfo;

option VendorInfo.clientId code 1 = string;

option VendorInfo.authCode code 2 = unsigned integer 8;

option VendorInfo.md5sum code 3 = string;

option vendor-specific code 43 = encapsulate VendorInfo;

option space cisco-vendor-id-vendor-class code width 1 length width 1;
option vendor-class.cisco-vendor-id-vendor-class code 9 = {string};
option bootstrap_servers code 143 = text;

ddns-update-style none;

#iPXE https specific configs
option space ipxe;
option ipxe-encap-opts code 175 = encapsulate ipxe;
option ipxe.crosscert code 93 = string;
option ipxe.crosscert "http://10.127.60.159/pub/mirror/ca.ipxe.org/auto";

#ZTP over OSC Configuration

subnet 10.90.1.0 netmask 255.255.255.0 {
  option domain-name-servers dns-blr1.cisco.com;
  option domain-name "cisco.com";
  option routers 10.90.1.1;
  #option netbios-name-serv;
}

subnet 10.91.1.0 netmask 255.255.255.0 {
  option domain-name-servers dns-blr1.cisco.com;
  option domain-name "cisco.com";
  option routers 10.91.1.1;
  #option netbios-name-serv;
}

subnet 10.92.1.0 netmask 255.255.255.0 {
  option domain-name-servers dns-blr1.cisco.com;
  option domain-name "cisco.com";
  option routers 10.92.1.1;
  #option netbios-name-serv;
}

subnet 10.94.1.0 netmask 255.255.255.0 {
  option domain-name-servers dns-blr1.cisco.com;
  option domain-name "cisco.com";
```

```

option routers 10.94.1.1;
#option netbios-name-serv;
}

#DHCP Relay Configuration

host OLT-R-C-SITE-1 {
hardware ethernet 38:fd:f8:66:09:52;
if exists user-class and option user-class = "iPXE" {
    filename "http://10.4.33.51/NCS1010/ncs1010-x64.iso";
} else {

    filename "http://10.4.33.51/NCS1010_CFG/OLT-R-C-SITE-1.cfg";
}
fixed-address 10.4.33.131;
}

host ILA-2R-C {
hardware ethernet 38:fd:f8:66:08:f6;
fixed-address 10.90.1.2;
if exists user-class and option user-class = "iPXE" {
    filename "http://10.4.33.51/NCS1010/ncs1010-x64.iso";
}
vendor-option-space VendorInfo;
option VendorInfo.clientId "xr-config";
option VendorInfo.authCode 0;
option bootfile-name "http://10.4.33.51/NCS1010_CFG/ILA-2R-C.cfg";
}

host ILA-R-C {
hardware ethernet 38:fd:f8:66:09:f2;
fixed-address 10.91.1.2;
if exists user-class and option user-class = "iPXE" {
    filename "http://10.4.33.51/NCS1010/ncs1010-x64.iso";
}
vendor-option-space VendorInfo;
option VendorInfo.clientId "xr-config";
option VendorInfo.authCode 0;
option bootfile-name "http://10.4.33.51/NCS1010_CFG/ILA-R-C.cfg";
}

host ILA-C {
hardware ethernet 38:fd:f8:66:09:7d;
fixed-address 10.92.1.2;
if exists user-class and option user-class = "iPXE" {
    filename "http://10.4.33.51/NCS1010/ncs1010-x64.iso";
}
vendor-option-space VendorInfo;
option VendorInfo.clientId "xr-config";
option VendorInfo.authCode 0;
option bootfile-name "http://10.4.33.51/NCS1010_CFG/ILA-C.cfg";
}

host OLT-C-SITE-2 {
hardware ethernet 38:fd:f8:66:06:79;
if exists user-class and option user-class = "iPXE" {
    filename "http://10.4.33.51/NCS010/ncs1010-x64.iso";
}
}

```

```

} else {

    filename "http://10.4.33.51/NCS1010_CFG/OLT-C-SITE-2.cfg";
}
fixed-address 192.0.2.121;
}

```

To create the static routes in the DHCP server, use the following commands:

```
route add -net OLT-OSC-ip gw OLT-MGMT-ip netmask 255.255.255.255 dev eth3
```

```
route add -net ILA-OSC-ip gw OLT-MGMT-ip netmask 255.255.255.255 dev eth3
```

```

[root@vxr-ncs1010-02 ~]# route add -net 10.90.1.1 gw 10.4.33.131 netmask 255.255.255.255
dev eth3
[root@vxr-ncs1010-02 ~]# route add -net 10.90.1.2 gw 10.4.33.131 netmask 255.255.255.255
dev eth3
[root@vxr-ncs1010-02 ~]# route add -net 10.91.1.1 gw 10.4.33.131 netmask 255.255.255.255
dev eth3
[root@vxr-ncs1010-02 ~]# route add -net 10.91.1.2 gw 10.4.33.131 netmask 255.255.255.255
dev eth3
[root@vxr-ncs1010-02 ~]# route add -net 10.92.1.1 gw 10.4.33.131 netmask 255.255.255.255
dev eth3
[root@vxr-ncs1010-02 ~]# route add -net 10.92.1.2 gw 10.4.33.131 netmask 255.255.255.255
dev eth3
[root@vxr-ncs1010-02 ~]# route add -net 10.94.1.1 gw 10.4.33.131 netmask 255.255.255.255
dev eth3
[root@vxr-ncs1010-02 ~]# route add -net 10.94.1.2 gw 10.4.33.131 netmask 255.255.255.255
dev eth3

```

10.4.33.131 is the management IP address for the gateway node.

ZTP Configuration Files Creation

You can build the ZTP configuration files based on your network requirements. The sample ZTP files created below are used to configure the nodes from OLT-R-C-SITE-1 to OLT-C-SITE-2 as shown in the figure below. You can create similar ZTP configuration files for the rest of the NCS 1010 nodes.

Figure 6: Network Topology Diagram

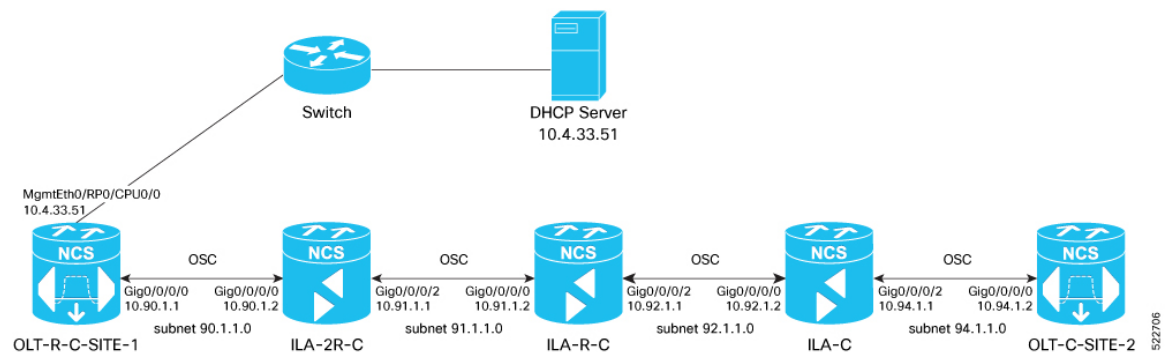

Note You can remotely manage an ILA node that is not connected to a management network through an OLT gateway node via an OSC interface. ZTP can be initiated from a remote node through DHCP relay. For more information see, [Remote Node Management in NCS 1010](#).

Build the ZTP configuration files by typing the following in Notepad and save them as .cfg files in the DHCP server.

OLT-R-C-SITE-1 node:

```
!! IOS XR Configuration 7.7.1.31I
!! Last configuration change at Mon Jul  4 11:10:16 2022 by cisco
!
hostname OLT-R-C-SITE-1
logging console informational
username cisco
group root-lr
group cisco-support
password 7 01100F17585B575D72
!
grpc
port 57400
!

dhcp ipv4
profile r1 relay
  helper-address vrf default 10.4.33.51 giaddr 10.90.1.1
!
interface GigabitEthernet0/0/0/0 relay profile r1

interface Loopback0
ipv4 address 10.131.1.1 255.255.255.255
!
interface MgmtEth0/RP0/CPU0/0
ipv4 address 10.4.33.131 255.255.255.0
!
interface MgmtEth0/RP0/CPU0/1
shutdown
!
interface MgmtEth0/RP0/CPU0/2
ipv4 address 10.127.59.22 255.255.255.0
!
interface GigabitEthernet0/0/0/0
ipv4 address 10.90.1.1 255.255.255.0
!

router static
address-family ipv4 unicast
  0.0.0.0/0 10.4.33.1
  0.0.0.0/0 10.127.59.1
!
!
router ospf 1
distribute link-state
network point-to-point
redistribute connected
area 0
  interface Loopback0
  !
  interface GigabitEthernet0/0/0/0
  !
ssh server rate-limit 600
ssh server session-limit 110
ssh server v2
ssh server netconf vrf default

optical-line-control
automatic-link-bringup
```

!

Save this file as **OLT-R-C-SITE-1.cfg**.

ILA-2R-C node:

```
!! IOS XR Configuration 7.7.1.31I
!! Last configuration change at Fri Jul 1 05:44:39 2022 by cisco
!
hostname ILA-2R-C
logging console debugging
domain name cisco.com
domain name-server 198.51.100.123
username cisco
group root-lr
group cisco-support
password 7 070C285F4D59485744
!
grpc
!
line console
exec-timeout 0 0
absolute-timeout 0
session-timeout 0
!
line default
exec-timeout 0 0
absolute-timeout 0
session-timeout 0
!
dhcp ipv4
profile r1 relay
  helper-address vrf default 10.4.33.51 giaddr 10.91.1.1
!
interface GigabitEthernet0/0/0/2 relay profile r1
!
!
netconf-yang agent
ssh
!
interface Loopback0
ipv4 address 10.128.1.1 255.255.255.255
!
interface MgmtEth0/RP0/CPU0/0
ipv4 address 10.4.33.128 255.255.255.0
!
interface MgmtEth0/RP0/CPU0/1
ipv4 address dhcp
shutdown
!
interface MgmtEth0/RP0/CPU0/2
ipv4 address 10.127.59.24 255.255.255.0
!
interface GigabitEthernet0/0/0/0
ipv4 address 10.90.1.2 255.255.255.0
!
interface GigabitEthernet0/0/0/2
ipv4 address 10.91.1.1 255.255.255.0
!
interface PTP0/RP0/CPU0/0
shutdown
!
interface PTP0/RP0/CPU0/1
shutdown
```

```

!
router static
address-family ipv4 unicast
 0.0.0.0/0 10.4.33.1
 0.0.0.0/0 10.127.59.1
!
!
router ospf 1
distribute link-state instance-id 0 throttle 5
network point-to-point
redistribute connected
area 0
 interface Loopback0
  !
 interface GigabitEthernet0/0/0/0
  !
 interface GigabitEthernet0/0/0/2
  !
!
!
optical-line-control
automatic-link-bringup

ssh server rate-limit 600
ssh server session-limit 110
ssh server v2
ssh server netconf vrf default
end

!! Last configuration change at Mon Jul 4 08:22:51 2022 by cisco

```

Save this file as **ILA-2R-C.cfg**.

ILA-R-C node:

```

!! IOS XR Configuration 7.7.1.31I
!! Last configuration change at Fri Jun 3 06:26:03 2022 by cisco
!
hostname ILA-R-C
username test
password 7 094F471A1A55464058
!
username cisco
group root-lr
group cisco-support
password 7 110A101614425A5E57
!
grpc
!
line console
exec-timeout 0 0
absolute-timeout 0
session-timeout 0
!
line default
exec-timeout 0 0
absolute-timeout 0
session-timeout 0
!

dhcp ipv4
profile r1 relay
 helper-address vrf default 10.4.33.51 giaddr 10.92.1.1
!
interface GigabitEthernet0/0/0/2 relay profile r1

```

```

!
!

netconf-yang agent
ssh
!
interface Loopback0
ipv4 address 10.134.1.1 255.255.255.255
!
interface MgmtEth0/RP0/CPU0/0
ipv4 address 10.4.33.134 255.255.255.0
!
interface MgmtEth0/RP0/CPU0/1
shutdown
!
interface MgmtEth0/RP0/CPU0/2
ipv4 address 10.127.59.28 255.255.255.0
!
interface GigabitEthernet0/0/0/0
ipv4 address 10.91.1.2 255.255.255.0
!
interface GigabitEthernet0/0/0/2
ipv4 address 10.92.1.1 255.255.255.0
!
interface PTP0/RP0/CPU0/0
shutdown
!
interface PTP0/RP0/CPU0/1
shutdown
!
router static
address-family ipv4 unicast
  0.0.0.0/0 10.4.33.1
  0.0.0.0/0 10.127.59.1
!
!
router ospf 1
distribute link-state instance-id 0 throttle 5
network point-to-point
redistribute connected
area 0
  interface Loopback0
  !
  interface GigabitEthernet0/0/0/0
  !
  interface GigabitEthernet0/0/0/2
  !
!
!
optical-line-control
automatic-link-bringup
ssh server rate-limit 600
!
ssh server session-limit 110
ssh server v2
ssh server netconf vrf default
end

```

Save this file as **ILA-R-C.cfg**.

ILA-C node:

```

Building configuration...
!! IOS XR Configuration 7.7.1.31I

```

```

!! Last configuration change at Fri Jun  3 06:26:55 2022 by cisco
!
hostname ILA-C
logging console informational
username cisco
group root-lr
group cisco-support
password 7 01100F17585B575D72
!
grpc
!
line console
exec-timeout 0 0
absolute-timeout 0
session-timeout 0
!
line default
exec-timeout 0 0
absolute-timeout 0
session-timeout 0
!
dhcp ipv4
profile r1 relay
  helper-address vrf default 10.4.33.51 giaddr 10.94.1.1
!
interface GigabitEthernet0/0/0/2 relay profile r1
!

netconf-yang agent
ssh
!
interface Loopback0
ipv4 address 10.122.1.1 255.255.255.255
!
interface MgmtEth0/RP0/CPU0/0
ipv4 address 10.4.33.122 255.255.255.0
!
interface MgmtEth0/RP0/CPU0/1
shutdown
!
interface MgmtEth0/RP0/CPU0/2
ipv4 address 10.127.59.54 255.255.255.0
!
interface GigabitEthernet0/0/0/0
ipv4 address 10.92.1.2 255.255.255.0
!
interface GigabitEthernet0/0/0/2
ipv4 address 10.94.1.1 255.255.255.0
!
!
interface PTP0/RP0/CPU0/0
shutdown
!
interface PTP0/RP0/CPU0/1
shutdown
!
router static
address-family ipv4 unicast
  0.0.0.0/0 10.4.33.1
  0.0.0.0/0 10.127.59.1
!
!
router ospf 1
distribute link-state

```



```

segment-routing mpls
network point-to-point
redistribute connected
area 0
 interface Loopback0
 !
 interface GigabitEthernet0/0/0/0
 !
 interface GigabitEthernet0/0/0/2
 !

ssh server rate-limit 600
ssh server session-limit 110
ssh server v2
ssh server netconf vrf default
optical-line-control
automatic-link-bringup
end

```

Save this file as **ILA-C.cfg**.

OLT-C-SITE-2 node:

```

!! IOS XR Configuration 7.7.1.31I
!! Last configuration change at Mon Jul  4 08:22:51 2022 by cisco
!
hostname OLT-C-SITE-2
username cisco
group root-lr
group cisco-support
password 7 02050D4808565E731F
!
grpc
!
line console
exec-timeout 0 0
absolute-timeout 0
session-timeout 0
!
line default
exec-timeout 0 0
absolute-timeout 0
session-timeout 0
!
interface Loopback0
ipv4 address 10.126.1.1 255.255.255.255
!

interface MgmtEth0/RP0/CPU0/0
ipv4 address 10.4.33.126 255.255.255.0
!
interface MgmtEth0/RP0/CPU0/1
ipv4 address 10.127.59.98 255.255.255.0
!
interface MgmtEth0/RP0/CPU0/2
ipv4 address 10.127.59.98 255.255.255.0
!
interface GigabitEthernet0/0/0/0
ipv4 address 10.94.1.2 255.255.255.0
!
interface PTP0/RP0/CPU0/0
shutdown
!
interface PTP0/RP0/CPU0/1
shutdown

```

```

!
router static
address-family ipv4 unicast
 0.0.0.0/0 10.4.33.1
 0.0.0.0/0 10.127.59.1
!
!
router ospf 1
distribute link-state instance-id 0 throttle 5
network point-to-point
redistribute connected
area 0
 interface Loopback0
  !
 interface GigabitEthernet0/0/0/0
  !
!

optical-line-control
automatic-link-bringup

ssh server rate-limit 600
ssh server session-limit 110
ssh server v2
ssh server netconf vrf default
end

```

Save this file as `OLT-C-SITE-2.cfg`.

These configuration files are referenced in the `dhcpd.conf` file.

For more information on ZTP, see [Boot Using Zero Touch Provisioning](#).

ZTP Configuration Workflow

This section details how to bringup NCS 1010 nodes using ZTP. Verification outputs have been added at various steps. The iPXE CLI boot process has been used for this example.

The example used in this section is part of the overall network topology.

Figure 7: Network Topology Diagram

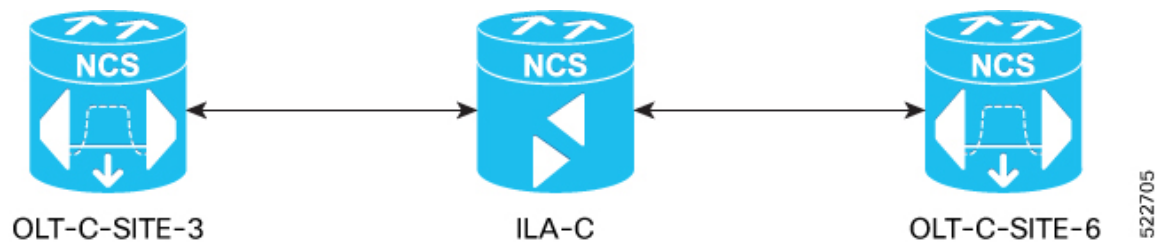

Note Before you use the iPXE boot, ensure that the DHCP server is set and is running. Create a `dhcpd.conf` file and the required ZTP configuration files specific to the nodes in the network topology diagram shown above. For samples of the `dhcpd.conf` file and the ZTP configuration files, see [DHCP Configuration, on page 7](#) and [ZTP Configuration Files Creation, on page 47](#).

1. Run the following CLI command to invoke the iPXE boot process to reimage the chassis:



Note This command deletes the existing configuration on the node.

```

RP/0/RP0/CPU0:ios#reload bootmedia network location 0/RP0/CPU0 noprompt
Mon Aug  1 11:49:27.269 UTC

Preparing system for backup. This may take a few minutes especially for large
configurations.
  Status report: node0_RP0_CPU0: START TO BACKUP
RP/0/RP0/CPU0:ios# Status report: node0_RP0_CPU0: BACKUP HAS COMPLETED SUCCESSFULLY
[Done]
[ OK ] Stopped Docker Application Container Engine.
[ OK ] Stopped target Network is Online.
[ OK ] Stopped target Network.
        Stopping Network Service...
[ OK ] Stopped Network Service.
        Stopping D-Bus System Message Bus...
.
.
snipped
.
.
[ OK ] Stopped Patch Sirius specific OS-SDK.
[ OK ] Reached target Shutdown.
[513293.089137] reboot: Restarting system

..
System Initializing..
..

ERROR: Class:0; Subclass:10000; Operation: 1004

CPU Rese

..
System Initializing..

NCS1010, Initializing Devices

Bootng from Primary Flash
Aldrin: Skipping reprogram

Version 2.19.1266. Copyright (C) 2022 American Megatrends, Inc.
BIOS Date: 05/20/2022 10:47:39 Ver: 0ACHI0410
Press <DEL> or <ESC> to enter setup.
TAM Chipguard Validate Observed DB Error: 0x48

WARNING!!! TAM: Empty Chip DB

Software Boot OK, Validated

iPXE initialising devices...ok

iPXE 1.0.0+ (c2215) -- Open Source Network Boot Firmware -- http://ipxe.org
Features: DNS HTTP TFTP VLAN EFI ISO9660 ISO9660_grub Menu
Trying net0-2051,net0-2052 and net0-2053...
net0-2051: 38:fd:f8:66:09:49 using NII on NII-PCI06:00.0 (open)

```

```

[Link:down, TX:0 TXE:0 RX:0 RXE:0]
[Link status: Unknown (http://ipxe.org/1a086194)]
Configuring (net0-2051 38:fd:f8:66:09:49)..... ok
net0: fe80::3afd:f8ff:fe66:949/64
.
.
snipped
.
.
[ OK ] Started Cisco Directory Services.
[ OK ] Started Lightning Fast Webserver With Light System Requirements.
        Starting NOS Bootup FPD Upgrade Service...
[ OK ] Started NOS Bootup FPD Upgrade Service.
        Starting IOS-XR Reaperd and Process Manager...
[ OK ] Started IOS-XR Reaperd and Process Manager.
        Starting Setting Cgroups...
[ OK ] Started Shutdown start service.
[ OK ] Started Setting Cgroups.
[ OK ] Started Kdump.
[ OK ] Reached target Multi-User System.
        Starting Update UTMP about System Runlevel Changes...
[ OK ] Reached target XR installation and startup.
[ OK ] Started Update UTMP about System Runlevel Changes.

```

ios con0/RP0/CPU0 is now available

Press RETURN to get started.

This product contains cryptographic features and is subject to United States and local country laws governing import, export, transfer and use. Delivery of Cisco cryptographic products does not imply third-party authority to import, export, distribute or use encryption. Importers, exporters, distributors and users are responsible for compliance with U.S. and local country laws. By using this product you agree to comply with applicable laws and regulations. If you are unable to comply with U.S. and local laws, return this product immediately.

A summary of U.S. laws governing Cisco cryptographic products may be found at:

<http://www.cisco.com/wwl/export/crypto/tool/stqrg.html>

If you require further assistance please contact us by sending email to export@cisco.com.

```

RP/0/RP0/CPU0:Aug  1 12:02:22.779 UTC: ifmgr[338]: %PKT_INFRA-LINK-3-UPDOWN : Interface
GigabitEthernet0/0/0/0, changed state to Down
RP/0/RP0/CPU0:Aug  1 12:02:23.100 UTC: osa_driver[254]: %PKT_INFRA-FM-4-FAULT_MINOR :
ALARM_MINOR :PROV-INPROGRESS :DECLARE :Oms0/2/0/8:
RP/0/RP0/CPU0:Aug  1 12:02:23.101 UTC: osa_driver[254]: %PKT_INFRA-FM-4-FAULT_MINOR :
ALARM_MINOR :PROV-INPROGRESS :DECLARE :Oms0/2/0/9:
.
.
snipped
.
.

```

```

!!!!!!!!!!!!!!!!!!!!!!!!!!!! NO root-system username is configured. Need to configure root-system
username. !!!!!!!!!!!!!!!!!!!!!!!!!!!!!

```

```

--- Administrative User Dialog ---

Enter root-system username: cisco
Enter secret:
Enter secret again:
Use the 'configure' command to modify this configuration.
User Access Verification

Username: cisco
Password:

RP/0/RP0/CPU0:ios#show running-config
Mon Aug  1 12:10:54.415 UTC
Building configuration...
!! IOS XR Configuration 7.7.1
!! Last configuration change at Mon Aug  1 12:10:44 2022 by SYSTEM
!
username cisco
  group root-lr
  group cisco-support
  secret 10
$6$lyk2E/DA/IH.3E/.$zxY.C0dcbPVwRQ.N5GKPrnXFx1ExAHYtnF45MvsBzhNVy15TyleF1x.Xbx1c8.JPMubwGlFkauRfeqAAjPrOTr1
!
call-home
  service active
  contact smart-licensing
  profile CiscoTAC-1
    active
    destination transport-method email disable
    destination transport-method http
!
!
interface MgmtEth0/RP0/CPU0/0
  ipv6 enable
!
interface MgmtEth0/RP0/CPU0/1
  ipv6 enable
!
interface MgmtEth0/RP0/CPU0/2
  ipv6 enable
!
interface GigabitEthernet0/0/0/0
  ipv6 enable
!
interface PTP0/RP0/CPU0/0
  shutdown
!
interface PTP0/RP0/CPU0/1
  shutdown
!
end

```

2. To remove all the ZTP logs and saved settings, use the following command:

```

RP/0/RP0/CPU0:ios#ztp clean
Mon Aug  1 12:11:07.816 UTC
This would remove all ZTP temporary files.
Would you like to proceed? [no]: yes
2022-08-01 12:11:10.674178:          ztp[ 1900, t 1900]: ERROR: ztp_proc_start
: 104: Failed to start process with error: 'processmgr' detected
the 'warning' condition 'The target process is already running.'
All ZTP operation files have been removed.

```

```
ZTP logs are present in /var/log/ztp*.log for logrotate.
Please remove manually if needed.
If you now wish ZTP to run again from boot, do 'conf t/commit replace' followed by reload.
RP/0/RP0/CPU0:ios#
```

3. To invoke ZTP manually, use the following command:

```
RP/0/RP0/CPU0:ios#ztp initiate
Mon Aug 1 12:11:24.572 UTC
Initiating ZTP may change your configuration.
Interfaces might be brought up if they are in shutdown state
Would you like to proceed? [no]: yes
ZTP will now run in the background.
RP/0/RP0/CPU0:ios#show logging | i ztp
Mon Aug 1 12:12:05.736 UTC
RP/0/RP0/CPU0:Aug 1 12:02:10.074 UTC: pyztp2[196]: %INFRA-ZTP-6-START : ZTP has started.
Interfaces might be brought up if they are shutdown
RP/0/RP0/CPU0:Aug 1 12:03:18.574 UTC: pyztp2[196]: %INFRA-ZTP-6-DISCOVERY_COMPLETED :
Discovery successful on MgmtDhcp4Fetcher. Will proceed with fetching.
.
.
snipped
.
.
RP/0/RP0/CPU0:Aug 1 12:12:40.784 UTC: osa_driver[254]: %PKT_INFRA-FM-4-FAULT_MINOR :
ALARM_MINOR :PROV-INPROGRESS :CLEAR :Oms0/2/0/13:
RP/0/RP0/CPU0:Aug 1 12:12:42.011 UTC: config[69106]: %MGBL-CONFIG-6-DB_COMMIT :
Configuration committed by user 'ZTP'. Use 'show configuration commit changes 1000000018'
to view the changes.
RP/0/RP0/CPU0:Aug 1 12:12:50.103 UTC: pyztp2[196]: %INFRA-ZTP-6-PROVISIONING_COMPLETED
: Provisioning successful
RP/0/RP0/CPU0:Aug 1 12:12:52.464 UTC: ospf[1036]: %ROUTING-OSPF-5-ADJCHG : Process 1,
Nbr 10.121.1.1 on GigabitEthernet0/0/0/0 in area 0 from LOADING to FULL, Loading Done,
vrf default vrfid 0x60000000
RP/0/RP0/CPU0:Aug 1 12:12:57.733 UTC: olc[159]: %PKT_INFRA-FM-4-FAULT_MINOR : ALARM_MINOR
:APC-BLOCKED :CLEAR :Ots0/0/0/0:
RP/0/RP0/CPU0:Aug 1 12:12:58.997 UTC: pyztp2[196]: %INFRA-ZTP-4-EXITED : ZTP exited
```

4. To view the running configuration on OLT-C-SITE-3:

```
RP/0/RP0/CPU0:OLT-C-SITE-3#show running-config
Mon Aug 1 12:13:07.535 UTC
Building configuration...
!! IOS XR Configuration 7.7.1
!! Last configuration change at Mon Aug 1 12:12:28 2022 by ZTP
!
hostname OLT-C-SITE-3
logging console informational
username cisco
 group root-lr
 group cisco-support
 password 7 1511021F077A7A767B67
!
grpc
 port 57400
 no-tls
!
address-family ipv4 unicast
!
line console
 exec-timeout 0 0
 absolute-timeout 0
 session-timeout 0
```

```

!
line default
  exec-timeout 0 0
  absolute-timeout 0
  session-timeout 0
!
.
.
snipped
.
.
!
!
ssh server rate-limit 600
ssh server session-limit 110
ssh server v2
ssh server vrf default
ssh server netconf vrf default
auto-ip-ring
end

```

5. Use the following show commands to view the status of the optical applications that are running on OLT-C-SITE-3:

```

RP/0/RP0/CPU0:OLT-C-SITE-3#show olc apc
Mon Aug  1 12:13:15.379 UTC

```

```

Controller      : Ots0/0/0/0
APC Status      : WORKING
Correcting Node : 10.120.1.1

```

```

Node RID        : 10.120.1.1
Internal State  : CORRECTING

```

```

Node RID        : 10.121.1.1
Internal State  : DISCREPANCY

```

```

RP/0/RP0/CPU0:OLT-C-SITE-3#show olc apc
Mon Aug  1 12:20:48.513 UTC

```

```

Controller      : Ots0/0/0/0
APC Status      : IDLE

```

```

Node RID        : 10.120.1.1
Internal State  : IDLE

```

```

Node RID        : 10.121.1.1
Internal State  : IDLE

```

```

RP/0/RP0/CPU0:OLT-C-SITE-3#show olc span-loss
Mon Aug  1 12:23:19.827 UTC

```

```

Controller name           : Ots0/0/0/0
Neighbour RID             : 10.121.1.1
Rx Span Loss              : 10.3 dB
Rx Span Loss (with pumps off) : NA
Rx Span Loss (with pumps off) measured at : NA
Estimated Rx Span Loss   : NA
Tx Span Loss              : 15.3 dB
Tx Span Loss (with pumps off) : NA
Tx Span Loss (with pumps off) measured at : NA
Estimated Tx Span Loss   : NA

```

```
RP/0/RP0/CPU0:OLT-C-SITE-3#show olc gain-estimator
Mon Aug 1 12:23:27.016 UTC
Controller                : Ots0/0/0/0
Ingress Gain Estimator Status : IDLE
Ingress Estimated Gain      : 17.0 dB
Ingress Estimated Gain Mode  : Normal
Ingress Gain Estimation Timestamp : 2022-08-01 12:14:05
```

```
RP/0/RP0/CPU0:OLT-C-SITE-3#show olc link-tuner
Mon Aug 1 12:23:32.651 UTC
Controller                : Ots0/0/0/0
Link Tuner Status        : OPERATIONAL
Last PSD computation: 2022-08-01 12:14:29
```

```
-----
Setpoint                  : Computed PSD
                          (dBm/12.5 GHz)
-----
```

```
-----
01                        -6.4
02                        -6.4
03                        -6.3
04                        -6.3
05                        -6.3
06                        -6.2
07                        -6.2
08                        -6.2
09                        -6.1
10                        -6.1
11                        -6.1
12                        -6.0
13                        -6.0
14                        -6.0
15                        -5.9
16                        -5.9
17                        -5.8
18                        -5.8
19                        -5.8
20                        -5.7
21                        -5.7
22                        -5.7
23                        -5.6
24                        -5.6
25                        -5.6
26                        -5.5
27                        -5.5
28                        -5.4
29                        -5.4
30                        -5.4
31                        -5.3
32                        -5.3
33                        -5.3
-----
```

6. To view the running configuration on OLT-C-SITE6:

```
RP/0/RP0/CPU0:OLT-C-SITE6#show running-config
Tue Aug 2 05:07:27.989 UTC
Building configuration...
!! IOS XR Configuration 7.7.1.33I
!! Last configuration change at Mon Aug 1 12:29:44 2022 by cisco
!
hostname OLT-C-SITE6
logging console informational
username cisco
group root-lr
group cisco-support
```



```
password 7 02050D4808565E731F1A
!
grpc
port 57400
no-tls
!
line console
exec-timeout 0 0
absolute-timeout 0
session-timeout 0
!
line default
exec-timeout 0 0
absolute-timeout 0
session-timeout 0
!
vty-pool default 0 99 line-template default
ntp
server 10.4.33.51 burst iburst
!
alias fpd show hw-module fpd
alias plat show platform
alias alarm show alarms brief system active
call-home
service active
contact smart-licensing
profile CiscoTAC-1
active
destination transport-method email disable
destination transport-method http
!
!
netconf-yang agent
ssh
!
.
.
snipped
.
.
!
!
interface PTP0/RP0/CPU0/0
shutdown
!
interface PTP0/RP0/CPU0/1
shutdown
!
router static
address-family ipv4 unicast
0.0.0.0/0 10.4.33.1
!
!
router ospf 1
distribute link-state instance-id 0 throttle 5
network point-to-point
redistribute connected
area 0
interface Loopback0
!
interface GigabitEthernet0/0/0/0
!
!
netconf agent tty
```

```

!
ssh server rate-limit 600
ssh server session-limit 110
ssh server v2
ssh server netconf vrf default
optical-line-control
  automatic-link-bringup

```

7. Use the following show commands to view the status of the optical applications that are running on OLT-C-SITE6:

```

RP/0/RP0/CPU0:OLT-C-SITE6#show olc apc
Mon Aug 1 12:23:46.224 UTC

```

```

Controller      : Ots0/0/0/0
APC Status      : IDLE

```

```

Node RID        : 10.121.1.1
Internal State  : IDLE

```

```

Node RID        : 10.120.1.1
Internal State  : IDLE

```

```

RP/0/RP0/CPU0:OLT-C-SITE6#show olc span-loss
Mon Aug 1 12:24:06.632 UTC

```

```

Controller name           : Ots0/0/0/0
Neighbour RID             : 10.120.1.1
Rx Span Loss              : 15.3 dB
Rx Span Loss (with pumps off) : NA
Rx Span Loss (with pumps off) measured at : NA
Estimated Rx Span Loss    : NA
Tx Span Loss              : 10.3 dB
Tx Span Loss (with pumps off) : NA
Tx Span Loss (with pumps off) measured at : NA
Estimated Tx Span Loss    : NA

```

```

RP/0/RP0/CPU0:OLT-C-SITE6#show olc gain-estimator
Mon Aug 1 12:23:50.246 UTC

```

```

Controller           : Ots0/0/0/0
Ingress Gain Estimator Status : IDLE
Ingress Estimated Gain : 19.0 dB
Ingress Estimated Gain Mode : Normal
Ingress Gain Estimation Timestamp : 2022-07-19 07:58:12

```

```

RP/0/RP0/CPU0:OLT-C-SITE6#show olc link-tuner
Mon Aug 1 12:24:00.355 UTC

```

```

Controller      : Ots0/0/0/0
Link Tuner Status : OPERATIONAL
Last PSD computation: 2022-08-01 12:14:05

```

```

-----
Setpoint           : Computed PSD
                   (dBm/12.5 GHz)
-----s-----

```

```

01                -8.0
02                -8.0
03                -8.0
04                -8.0
05                -7.9
06                -7.9
07                -7.9
08                -7.9
09                -7.8
10                -7.8

```

```

11                -7.8
12                -7.8
13                -7.7
14                -7.7
15                -7.7
16                -7.6
17                -7.6
18                -7.6
19                -7.6
20                -7.5
21                -7.5
22                -7.5
23                -7.4
24                -7.4
25                -7.4
26                -7.4
27                -7.3
28                -7.3
29                -7.3
30                -7.3
31                -7.2
32                -7.2
33                -7.2

```

```
RP/0/RP0/CPU0:OLT-C-SITE6#
```

- Configure the optical cross-connects for OLT-C-SITE-3 and OLT-C-SITE6. We are going to create a single channel from OLT-C-SITE-3 to OLT-C-SITE6 . The channel is mapped to **193.925 THz**.

Configuration for OLT-C-SITE-3

```

RP/0/RP0/CPU0:OLT-C-SITE-3#config
Tue Jul 26 06:30:25.087 UTC
RP/0/RP0/CPU0:OLT-C-SITE-3(config)#hw-module location 0/0/NXR0 terminal-ampli grid-mode
flex
RRP/0/RP0/CPU0:OLT-C-SITE-3(config-hwmod-olt-flexi)#channel-id 30 centre-freq 193.925
width 75
RP/0/RP0/CPU0:OLT-C-SITE-3(config-hwmod-olt-flexi)#commit
Tue Jul 26 06:33:03.824 UTC
RP/0/RP0/CPU0:OLT-C-SITE-3(config-hwmod-olt-flexi)#end

RP/0/RP0/CPU0:OLT-C-SITE-3#config
Tue Jul 26 06:33:29.885 UTC
RP/0/RP0/CPU0:OLT-C-SITE-3(config)#controller ots-Och 0/0/0/0/30
RP/0/RP0/CPU0:OLT-C-SITE-3(config-Ots)#add-drop-channel ots-Och 0/0/0/3/30
RP/0/RP0/CPU0:OLT-C-SITE-3(config-Ots)#commit
RP/0/RP0/CPU0:OLT-C-SITE-3(config-Ots)#end
RP/0/RP0/CPU0:OLT-C-SITE-3#sh hw-module location 0/0/NXR0 terminal-ampli
Mon Aug 1 12:36:23.954 UTC

```

Legend:

```

NXC      - Channel not cross-connected
ACTIVE   - Channel cross-connected to data port
ASE      - Channel filled with ASE
FAILED   - Data channel failed, pending transition to ASE

```

```
Location:          0/0/NXR0
```

```
Status:           Provisioned
```

Flex Grid Info

Channel Number	Centre Frequency(THz)	Channel Width(GHz)	Channel Status
30	193.925000	75.000	ACTIVE

```
RP/0/RP0/CPU0:OLT-C-SITE-3#
```

Configuration for OLT-C-SITE-6

```
RP/0/RP0/CPU0:OLT-C-SITE-6#config
Tue Jul 26 06:30:25.087 UTC
RP/0/RP0/CPU0:OLT-C-SITE-6(config)#hw-module location 0/0/NXR0 terminal-ampli grid-mode
flex
RP/0/RP0/CPU0:OLT-C-SITE-6(config-hwmod-olt-flexi)#channel-id 30 centre-freq 193.925
width 75
RP/0/RP0/CPU0:OLT-C-SITE-6(config-hwmod-olt-flexi)#commit
Tue Jul 26 06:33:03.824 UTC
RP/0/RP0/CPU0:OLT-C-SITE-6(config-hwmod-olt-flexi)#end
```

```
RP/0/RP0/CPU0:OLT-C-SITE-6#config
Mon Aug 1 12:42:09.686 UTC
```

```
RP/0/RP0/CPU0:OLT-C-SITE-6(config)#controller ots-Och 0/0/0/0/30
RP/0/RP0/CPU0:OLT-C-SITE-6(config-Ots)#add-drop-channel ots-Och 0/0/0/3/30
RP/0/RP0/CPU0:OLT-C-SITE-6(config-Ots)#commit
RP/0/RP0/CPU0:OLT-C-SITE-6(config-Ots)#end
RP/0/RP0/CPU0:OLT-C-SITE-6#sh hw-module location 0/0/NXR0 terminal-ampli
Mon Aug 1 12:36:23.954 UTC
```

Legend:

```
NXC - Channel not cross-connected
ACTIVE - Channel cross-connected to data port
ASE - Channel filled with ASE
FAILED - Data channel failed, pending transition to ASE
```

```
Location: 0/0/NXR0
```

```
Status: Provisioned
```

Flex Grid Info

Channel Number	Centre Frequency (THz)	Channel Width (GHz)	Channel Status
30	193.925000	75.000	ACTIVE

```
RP/0/RP0/CPU0:OLT-C-SITE-6#
```

After the cross-connects are created on the OLT nodes, APC regulates the power on each node. The APC status moves from WORKING to IDLE when the process completes. Use the **show olc apc** command to view the status of the operation. The following samples are for OLT-C-SITE-3.

```
RP/0/RP0/CPU0:OLT-C-SITE-3#show olc apc
Mon Aug 1 12:33:15.671 UTC
```

```
Controller      : Ots0/0/0/0
APC Status      : WORKING
Correcting Node : 10.120.1.1
```

```
Node RID        : 10.120.1.1
Internal State   : CORRECTING
```

```
Node RID        : 10.121.1.1
Internal State   : DISCREPANCY
```

```
RP/0/RP0/CPU0:OLT-C-SITE-3#show olc apc
Mon Aug 1 12:39:57.187 UTC
```

```
Controller      : Ots0/0/0/0
APC Status      : IDLE
```

```
Node RID      : 10.120.1.1
Internal State : IDLE
```

```
Node RID      : 10.121.1.1
Internal State : IDLE
```

```
RP/0/RP0/CPU0:OLT-C-SITE-3#
```

After the APC process is complete, the link comes up. You can view the details using the **sh olc apc-local regulation-info controller ots** command on the near-end and far-end nodes.

OLT-C-SITE-3:

```
RP/0/RP0/CPU0:OLT-C-SITE-3#sh olc apc-local regulation-info controller ots 0/0/0 rx
Mon Aug 1 12:44:42.887 UTC
Controller      : Ots0/0/0/0
Domain Manager  : 10.121.1.1
Internal Status : IDLE
Direction      : RX
PSD Minimum    : -22.0 (dBm/12.5 GHz)
Gain Range     : Normal
Last Correction : 2022-08-01 12:35:29
```

Device Parameters	Min	Max	Configuration	Operational
Ingress Ampli Gain (dB)	12.0	25.0	17.7	17.7
Ingress Ampli Tilt (dB)	-5.0	3.4	0.4	0.4
RX Ampli Power (dBm)	-	25.0	-	24.5
RX VOA Attenuation (dB)	0.0	0.0	0.0	0.0
Ingress WSS/DGE Attenuation (dB)	0.0	25.0	-	-

Channel Center Discrepancy Frequency (THz) (dB)	Channel Slice Width Attn Config (GHz) (dB)	Channel ID	Channel Source	Spectrum Slice Num	Ampli-Input PSD (dBm/12.5 GHz)	Target PSD (dBm/12.5 GHz)	Current PSD (dBm/12.5 GHz)
191.375000	75.00	-	ASE	13	-18.4	-	-25.6
0.0	25.0						
191.449997	75.00	-	ASE	37	-18.3	-	-25.4
0.0	25.0						
191.524994	75.00	-	ASE	61	-18.4	-	-25.7
0.0	25.0						
191.600006	75.00	-	ASE	85	-18.3	-	-25.5
0.0	25.0						
191.675003	75.00	-	ASE	109	-18.2	-	-25.5
0.0	25.0						
191.750000	75.00	-	ASE	133	-18.2	-	-25.5
0.0	25.0						
191.824997	75.00	-	ASE	157	-18.2	-	-25.5
0.0	25.0						
191.899994	75.00	-	ASE	181	-18.1	-	-25.5
0.0	25.0						
191.975006	75.00	-	ASE	205	-18.2	-	-25.6
0.0	25.0						
192.050003	75.00	-	ASE	229	-18.1	-	-25.4
0.0	25.0						
192.125000	75.00	-	ASE	253	-18.0	-	-25.4
0.0	25.0						
192.199997	75.00	-	ASE	277	-18.1	-	-25.5
0.0	25.0						
192.274994	75.00	-	ASE	301	-18.0	-	-25.5
0.0	25.0						
192.350006	75.00	-	ASE	325	-18.0	-	-25.5
0.0	25.0						
192.425003	75.00	-	ASE	349	-17.9	-	-25.4
0.0	25.0						
192.500000	75.00	-	ASE	373	-18.0	-	-25.4
0.0	25.0						
192.574997	75.00	-	ASE	397	-18.0	-	-25.5
0.0	25.0						
192.649994	75.00	-	ASE	421	-18.0	-	-25.4
0.0	25.0						

192.725006	75.00	-	ASE	445	-17.9	-	-25.3
0.0	25.0						
192.800003	75.00	-	ASE	469	-17.8	-	-25.2
0.0	25.0						
192.875000	75.00	-	ASE	493	-17.9	-	-25.4
0.0	25.0						
192.949997	75.00	-	ASE	517	-17.9	-	-25.3
0.0	25.0						
193.024994	75.00	-	ASE	541	-17.9	-	-25.4
0.0	25.0						
193.100006	75.00	-	ASE	565	-17.9	-	-25.4
0.0	25.0						
193.175003	75.00	-	ASE	589	-17.8	-	-25.4
0.0	25.0						
193.250000	75.00	-	ASE	613	-17.9	-	-25.4
0.0	25.0						
193.324997	75.00	-	ASE	637	-17.8	-	-25.3
0.0	25.0						
193.399994	75.00	-	ASE	661	-17.7	-	-25.2
0.0	25.0						
193.475006	75.00	-	ASE	685	-17.8	-	-25.3
0.0	25.0						
193.550003	75.00	-	ASE	709	-17.9	-	-25.4
0.0	25.0						
193.625000	75.00	-	ASE	733	-17.8	-	-25.3
0.0	25.0						
193.699997	75.00	-	ASE	757	-17.7	-	-25.2
0.0	25.0						
193.774994	75.00	-	ASE	781	-17.7	-	-25.1
0.0	25.0						
193.850006	75.00	-	ASE	805	-17.7	-	-25.2
0.0	25.0						
193.925003	75.00	30	OCh	829	-18.0	-9.4	-9.1
-0.2	3.8						
194.000000	75.00	-	ASE	853	-17.6	-	-25.1
0.0	25.0						
194.074997	75.00	-	ASE	877	-17.6	-	-25.1
0.0	25.0						
194.149994	75.00	-	ASE	901	-17.7	-	-25.1
0.0	25.0						
194.225006	75.00	-	ASE	925	-17.7	-	-25.1
0.0	25.0						
194.300003	75.00	-	ASE	949	-17.8	-	-25.1
0.0	25.0						
194.375000	75.00	-	ASE	973	-17.6	-	-25.1
0.0	25.0						
194.449997	75.00	-	ASE	997	-17.7	-	-25.0
0.0	25.0						
194.524994	75.00	-	ASE	1021	-17.5	-	-25.0
0.0	25.0						
194.600006	75.00	-	ASE	1045	-17.6	-	-25.1
0.0	25.0						
194.675003	75.00	-	ASE	1069	-17.6	-	-25.0
0.0	25.0						
194.750000	75.00	-	ASE	1093	-17.6	-	-25.0
0.0	25.0						
194.824997	75.00	-	ASE	1117	-17.6	-	-25.2
0.0	25.0						
194.899994	75.00	-	ASE	1141	-17.6	-	-25.2
0.0	25.0						
194.975006	75.00	-	ASE	1165	-17.6	-	-25.3
0.0	25.0						
195.050003	75.00	-	ASE	1189	-17.5	-	-25.3
0.0	25.0						
195.125000	75.00	-	ASE	1213	-17.6	-	-25.5
0.0	25.0						
195.199997	75.00	-	ASE	1237	-17.6	-	-25.7
0.0	25.0						
195.274994	75.00	-	ASE	1261	-17.5	-	-25.7
0.0	25.0						
195.350006	75.00	-	ASE	1285	-17.5	-	-25.7
0.0	25.0						
195.425003	75.00	-	ASE	1309	-17.5	-	-25.8
0.0	25.0						
195.500000	75.00	-	ASE	1333	-17.5	-	-25.9
0.0	25.0						
195.574997	75.00	-	ASE	1357	-17.5	-	-25.8
0.0	25.0						
195.649994	75.00	-	ASE	1381	-17.4	-	-25.7
0.0	25.0						
195.725006	75.00	-	ASE	1405	-17.5	-	-25.7
0.0	25.0						
195.800003	75.00	-	ASE	1429	-17.5	-	-25.6
0.0	25.0						
195.875000	75.00	-	ASE	1453	-17.6	-	-25.6
0.0	25.0						

195.949997	75.00	-	ASE	1477	-17.4	-	-25.4
0.0	25.0						
196.024994	75.00	-	ASE	1501	-17.6	-	-25.4
0.0	25.0						
196.100006	75.00	-	ASE	1525	-17.6	-	-25.3
0.0	25.0						

ASE - Noise Loaded Channel
 OCh - Optical Channel

RP/0/RP0/CPU0:OLT-C-SITE-3#

OLT-C-SITE-6:

```
RP/0/RP0/CPU0:OLT-C-SITE6#sh olc apc-local regulation-info controller ots 0/0/0/0 rx
Mon Aug 1 12:42:41.213 UTC
Controller      : Ots0/0/0/0
Domain Manager  : 10.120.1.1
Internal Status : IDLE
Direction      : RX
PSD Minimumum  : -22.0 (dBm/12.5 GHz)
Gain Range     : Normal
Last Correction : 2022-08-01 12:36:44
```

Device Parameters	Min	Max	Configuration	Operational
Ingress Ampli Gain (dB)	12.0	25.0	20.4	20.4
Ingress Ampli Tilt (dB)	-5.0	1.3	0.3	0.3
RX Ampli Power (dBm)	-	25.0	-	24.0
RX VOA Attenuation (dB)	0.0	0.0	0.0	0.0
Ingress WSS/DGE Attenuation (dB)	0.0	25.0	-	-

Channel Center Discrepancy Frequency (THz) (dB)	Channel Channel Slice Width Attn Config (GHz) (dB)	Channel ID	Channel Source	Spectrum Slice Num	Ampli-Input PSD (dBm/12.5 GHz)	Target PSD (dBm/12.5 GHz)	Current PSD (dBm/12.5 GHz)
191.375000	75.00	-	ASE	13	-21.6	-	-25.6
0.0	25.0						
191.449997	75.00	-	ASE	37	-21.5	-	-25.6
0.0	25.0						
191.524994	75.00	-	ASE	61	-21.5	-	-25.6
0.0	25.0						
191.600006	75.00	-	ASE	85	-21.5	-	-25.6
0.0	25.0						
191.675003	75.00	-	ASE	109	-21.4	-	-25.6
0.0	25.0						
191.750000	75.00	-	ASE	133	-21.6	-	-25.8
0.0	25.0						
191.824997	75.00	-	ASE	157	-21.6	-	-25.8
0.0	25.0						
191.899994	75.00	-	ASE	181	-21.5	-	-25.8
0.0	25.0						
191.975006	75.00	-	ASE	205	-21.3	-	-25.7
0.0	25.0						
192.050003	75.00	-	ASE	229	-21.4	-	-25.8
0.0	25.0						
192.125000	75.00	-	ASE	253	-21.5	-	-25.9
0.0	25.0						
192.199997	75.00	-	ASE	277	-21.4	-	-25.9
0.0	25.0						
192.274994	75.00	-	ASE	301	-21.3	-	-25.8
0.0	25.0						
192.350006	75.00	-	ASE	325	-21.3	-	-25.9
0.0	25.0						
192.425003	75.00	-	ASE	349	-21.4	-	-26.0
0.0	25.0						
192.500000	75.00	-	ASE	373	-21.3	-	-26.0
0.0	25.0						
192.574997	75.00	-	ASE	397	-21.4	-	-26.0
0.0	25.0						
192.649994	75.00	-	ASE	421	-21.3	-	-25.9
0.0	25.0						

192.725006	75.00	-	ASE	445	-21.3	-	-26.0
0.0	25.0						
192.800003	75.00	-	ASE	469	-21.3	-	-26.0
0.0	25.0						
192.875000	75.00	-	ASE	493	-21.3	-	-26.0
0.0	25.0						
192.949997	75.00	-	ASE	517	-21.3	-	-26.0
0.0	25.0						
193.024994	75.00	-	ASE	541	-21.2	-	-25.8
0.0	25.0						
193.100006	75.00	-	ASE	565	-21.3	-	-26.0
0.0	25.0						
193.175003	75.00	-	ASE	589	-21.2	-	-26.0
0.0	25.0						
193.250000	75.00	-	ASE	613	-21.2	-	-25.9
0.0	25.0						
193.324997	75.00	-	ASE	637	-21.2	-	-25.9
0.0	25.0						
193.399994	75.00	-	ASE	661	-21.3	-	-26.0
0.0	25.0						
193.475006	75.00	-	ASE	685	-21.2	-	-25.9
0.0	25.0						
193.550003	75.00	-	ASE	709	-21.1	-	-25.9
0.0	25.0						
193.625000	75.00	-	ASE	733	-21.2	-	-25.9
0.0	25.0						
193.699997	75.00	-	ASE	757	-21.2	-	-25.9
0.0	25.0						
193.774994	75.00	-	ASE	781	-21.2	-	-25.9
0.0	25.0						
193.850006	75.00	-	ASE	805	-21.1	-	-25.8
0.0	25.0						
193.925003	75.00	30	OCh	829	-21.2	-9.4	-9.4
0.0	2.1						
194.000000	75.00	-	ASE	853	-21.1	-	-25.8
0.0	25.0						
194.074997	75.00	-	ASE	877	-21.1	-	-25.8
0.0	25.0						
194.149994	75.00	-	ASE	901	-21.0	-	-25.7
0.0	25.0						
194.225006	75.00	-	ASE	925	-21.0	-	-25.7
0.0	25.0						
194.300003	75.00	-	ASE	949	-21.0	-	-25.7
0.0	25.0						
194.375000	75.00	-	ASE	973	-21.0	-	-25.7
0.0	25.0						
194.449997	75.00	-	ASE	997	-21.0	-	-25.7
0.0	25.0						
194.524994	75.00	-	ASE	1021	-21.0	-	-25.6
0.0	25.0						
194.600006	75.00	-	ASE	1045	-21.0	-	-25.7
0.0	25.0						
194.675003	75.00	-	ASE	1069	-21.0	-	-25.7
0.0	25.0						
194.750000	75.00	-	ASE	1093	-21.0	-	-25.6
0.0	25.0						
194.824997	75.00	-	ASE	1117	-20.8	-	-25.6
0.0	25.0						
194.899994	75.00	-	ASE	1141	-20.9	-	-25.6
0.0	25.0						
194.975006	75.00	-	ASE	1165	-21.0	-	-25.8
0.0	25.0						
195.050003	75.00	-	ASE	1189	-20.9	-	-25.7
0.0	25.0						
195.125000	75.00	-	ASE	1213	-20.8	-	-25.6
0.0	25.0						
195.199997	75.00	-	ASE	1237	-20.7	-	-25.7
0.0	25.0						
195.274994	75.00	-	ASE	1261	-20.8	-	-25.8
0.0	25.0						
195.350006	75.00	-	ASE	1285	-20.9	-	-25.9
0.0	25.0						
195.425003	75.00	-	ASE	1309	-20.7	-	-25.9
0.0	25.0						
195.500000	75.00	-	ASE	1333	-20.7	-	-26.0
0.0	25.0						
195.574997	75.00	-	ASE	1357	-20.6	-	-25.9
0.0	25.0						
195.649994	75.00	-	ASE	1381	-20.6	-	-26.0
0.0	25.0						
195.725006	75.00	-	ASE	1405	-20.7	-	-26.0
0.0	25.0						
195.800003	75.00	-	ASE	1429	-20.6	-	-26.0
0.0	25.0						
195.875000	75.00	-	ASE	1453	-20.6	-	-25.9
0.0	25.0						

```

195.949997    75.00    -    ASE    1477    -20.5    -    -25.8
   0.0        25.0
196.024994    75.00    -    ASE    1501    -20.6    -    -25.7
   0.0        25.0
196.100006    75.00    -    ASE    1525    -20.5    -    -25.6
   0.0        25.0

ASE - Noise Loaded Channel
OCh - Optical Channel

RP/0/RP0/CPU0:OLT-C-SITE6#

```

Cross-connect Configuration

The OTS-OCH controllers are not created by default when the cards (NCS1K-ILA-2R-C, NCS1K-ILA-R-C, NCS1K-ILA-C, NCS1K-OLT-R-C, and NCS1K-OLT-C) are brought up. The LINE OTS-OCH controllers can be created using the **hw-module** command.

Optical Cross Connections can be configured only on OLT nodes. In these nodes, the OTS-OCH controller is not created automatically on the Add/Drop ports (COM side). The optical cross connect configuration defines the line side OTS-OCH channel as the source and creates an OTS-OCH controller on the ADD/Drop port to which the cross connection is made. The channel ID must be the same for both the LINE side and COM side OTS-OCH controller.

To illustrate the creation of the cross-connects, we are going to create a single channel from OLT-R-C-SITE-1 to OLT-C-SITE-8 in the topology diagram. The channel is mapped to **191.45 THz**.

Configuration for OLT-R-C-SITE-1

```

P/0/RP0/CPU0:OLT-R-C-SITE-1#config
Tue Jul 26 06:30:25.087 UTC
RP/0/RP0/CPU0:OLT-R-C-SITE-1(config)#hw-module location 0/0/NXR0 terminal-ampli grid-mode
flex
RP/0/RP0/CPU0:OLT-R-C-SITE-1(config-hwmod-olt-flexi)#channel-id 63 centre-freq 191.45 width
75
RP/0/RP0/CPU0:OLT-R-C-SITE-1(config-hwmod-olt-flexi)#commit
Tue Jul 26 06:33:03.824 UTC
RP/0/RP0/CPU0:OLT-R-C-SITE-1(config-hwmod-olt-flexi)#end
RP/0/RP0/CPU0:OLT-R-C-SITE-1#sh hw-module location 0/0/NXR0 terminal-ampli
Tue Jul 26 06:33:13.093 UTC

```

Legend:

```

NXC    - Channel not cross-connected
ACTIVE - Channel cross-connected to data port
ASE    - Channel filled with ASE
FAILED - Data channel failed, pending transition to ASE

```

Location: 0/0/NXR0

Status: Provisioned

Flex Grid Info

Channel Number	Centre Frequency (THz)	Channel Width (GHz)	Channel Status
2	196.025000	75.000	ASE
17	194.900000	75.000	ACTIVE
63	191.450000	75.000	NXC

```

RP/0/RP0/CPU0:OLT-R-C-SITE-1#config
Tue Jul 26 06:33:29.885 UTC
RP/0/RP0/CPU0:OLT-R-C-SITE-1(config)#controller ots-Och 0/0/0/0/63
RP/0/RP0/CPU0:OLT-R-C-SITE-1(config-Ots)#add-drop-channel ots-Och 0/0/0/3/63
RP/0/RP0/CPU0:OLT-R-C-SITE-1(config-Ots)#commit

```

```
RP/0/RP0/CPU0:OLT-R-C-SITE-1(config-Ots)#end
RP/0/RP0/CPU0:OLT-R-C-SITE-1#sh hw-module location 0/0/NXR0 terminal-ampli
Tue Jul 26 06:34:27.110 UTC
```

Legend:

```
NXC - Channel not cross-connected
ACTIVE - Channel cross-connected to data port
ASE - Channel filled with ASE
FAILED - Data channel failed, pending transition to ASE
```

```
Location: 0/0/NXR0
```

```
Status: Provisioned
```

Flex Grid Info

Channel Number	Centre Frequency (THz)	Channel Width (GHz)	Channel Status
2	196.025000	75.000	ASE
17	194.900000	75.000	ACTIVE
63	191.450000	75.000	ACTIVE

Configuration for ILA-2R-C

```
RP/0/RP0/CPU0:ILA-2R-C#config
Tue Jul 26 06:35:12.145 UTC
RP/0/RP0/CPU0:ILA-2R-C(config)#hw-module location 0/0/NXR0 inline-ampli
RP/0/RP0/CPU0:ILA-2R-C(config-hwmod-ila)#grid-mode flex
RP/0/RP0/CPU0:ILA-2R-C(config-hwmod-ila-flexi)#channel-id 63 centre-freq 191.45 width 75
RP/0/RP0/CPU0:ILA-2R-C(config-hwmod-ila-flexi)#commit
RP/0/RP0/CPU0:ILA-2R-C(config-hwmod-ila-flexi)#end
RP/0/RP0/CPU0:ILA-2R-C#sh hw-module location 0/0/NXR0 inline-ampli
Tue Jul 26 06:36:33.333 UTC
```

```
Location: 0/0/NXR0
```

```
Status: Provisioned
```

Flex Grid Info

Channel Number	Centre Frequency (THz)	Channel Width (GHz)
63	191.450000	75.000

```
RP/0/RP0/CPU0:ILA-2R-C#sh controllers ots-Och 0/0/0/0/63
Tue Jul 26 06:36:41.935 UTC
```

```
Controller State: Up
```

```
Transport Admin State: In Service
```

```
Alarm Status:
```

```
-----
```

```
Detected Alarms: None
```

```
Parameter Statistics:
```

```
-----
```

```
Total RX Power = -13.40 dBm
```

```
Total TX Power = 0.99 dBm
```

```
Configured Parameters:
```

```
-----
```

```
RP/0/RP0/CPU0:ILA-2R-C#sh controllers ots-Och 0/0/0/2/63
Tue Jul 26 06:36:52.466 UTC
```

```

Controller State: Up

Transport Admin State: In Service

Alarm Status:
-----
Detected Alarms: None

Parameter Statistics:
-----
Total RX Power = -5.50 dBm
Total TX Power = 2.29 dBm

Configured Parameters:
-----

```

Configuration for ILA-R-C

```

RP/0/RP0/CPU0:ILA-R-C#config
Tue Jul 26 06:36:45.377 UTC
RP/0/RP0/CPU0:ILA-R-C(config)#hw-module location 0/0/NXR0 inline-ampli grid-mode flex
RP/0/RP0/CPU0:ILA-R-C(config-hwmod-ila-flexi)#channel-id 63 centre-freq 191.45 width 75
RP/0/RP0/CPU0:ILA-R-C(config-hwmod-ila-flexi)#commit
RP/0/RP0/CPU0:ILA-R-C(config-hwmod-ila-flexi)#end
RP/0/RP0/CPU0:ILA-R-C#sh hw-module location 0/0/NXR0 inline-ampli
Tue Jul 26 06:37:08.127 UTC

```

Location: 0/0/NXR0

Status: Provisioned

Flex Grid Info

Channel Number	Centre Frequency (THz)	Channel Width (GHz)
63	191.450000	75.000

```

RP/0/RP0/CPU0:ILA-R-C#sh controllers ots-Och 0/0/0/0/63
Tue Jul 26 07:08:07.280 UTC

```

Controller State: Up

Transport Admin State: In Service

```

Alarm Status:
-----
Detected Alarms: None

```

```

Parameter Statistics:
-----
Total RX Power = -12.40 dBm
Total TX Power = 1.19 dBm

```

```

Configured Parameters:
-----

```

```

RP/0/RP0/CPU0:ILA-R-C#sh controllers ots-Och 0/0/0/2/63
Tue Jul 26 07:08:10.854 UTC

```

```
Controller State: Up

Transport Admin State: In Service
```

```
Alarm Status:
-----
Detected Alarms: None
```

```
Parameter Statistics:
-----
Total RX Power = -9.10 dBm
Total TX Power = 1.39 dBm
```

```
Configured Parameters:
-----
```

Configuration for ILA-C

```
RP/0/RP0/CPU0:ILA-C#config
Tue Jul 26 06:38:56.584 UTC
RP/0/RP0/CPU0:ILA-C(config)#hw-module location 0/0/NXR0 inline-ampli grid-mode flex

RP/0/RP0/CPU0:ILA-C(config-hwmod-ila-flexi)#channel-id 63 centre-freq 191.45 width 75
RP/0/RP0/CPU0:ILA-C(config-hwmod-ila-flexi)#commit
Tue Jul 26 06:39:24.378 UTC
RP/0/RP0/CPU0:ILA-C(config-hwmod-ila-flexi)#end
RP/0/RP0/CPU0:ILA-C#
RP/0/RP0/CPU0:ILA-C#sh hw-module location 0/0/NXR0 inline-ampli
Tue Jul 26 06:39:43.874 UTC
```

```
Location:          0/0/NXR0

Status:            Provisioned
```

Flex Grid Info

Channel Number	Centre Frequency (THz)	Channel Width (GHz)
63	191.450000	75.000

```
RP/0/RP0/CPU0:ILA-C#sh controllers ots-Och 0/0/0/0/63
Tue Jul 26 07:10:32.333 UTC
```

```
Controller State: Up

Transport Admin State: In Service
```

```
Alarm Status:
-----
Detected Alarms: None
```

```
Parameter Statistics:
-----
Total RX Power = -15.80 dBm
Total TX Power = -0.60 dBm
```

```
Configured Parameters:
-----
```

```
RP/0/RP0/CPU0:ILA-C#sh controllers ots-Och 0/0/0/2/63
Tue Jul 26 07:10:38.238 UTC
```

```
Controller State: Up

Transport Admin State: In Service
```

```
Alarm Status:
-----
Detected Alarms: None
```

```
Parameter Statistics:
-----
Total RX Power = -11.00 dBm
Total TX Power = -1.60 dBm
```

```
Configured Parameters:
-----
```

Configuration for OLT-C-SITE-2

```
RP/0/RP0/CPU0:OLT-C-SITE-2#config
Tue Jul 26 06:38:54.139 UTC
RP/0/RP0/CPU0:OLT-C-SITE-2(config)#hw-module location 0/0/NXR0 terminal-ampli
RP/0/RP0/CPU0:OLT-C-SITE-2(config-hwmod-olt)#grid-mode flex
RP/0/RP0/CPU0:OLT-C-SITE-2(config-hwmod-olt-flexi)#channel-id 63 centre-freq 191.45 width
75
RP/0/RP0/CPU0:OLT-C-SITE-2(config-hwmod-olt-flexi)#commit
RP/0/RP0/CPU0:OLT-C-SITE-2(config-hwmod-olt-flexi)#end
RP/0/RP0/CPU0:OLT-C-SITE-2#sh hw-module location 0/0/NXR0 terminal-ampli
Tue Jul 26 06:39:23.878 UTC
```

```
Legend:
NXC - Channel not cross-connected
ACTIVE - Channel cross-connected to data port
ASE - Channel filled with ASE
FAILED - Data channel failed, pending transition to ASE
```

```
Location:          0/0/NXR0

Status:            Provisioned
```

Flex Grid Info

Channel Number	Centre Frequency (THz)	Channel Width (GHz)	Channel Status
2	196.025000	75.000	ASE
17	194.900000	75.000	ACTIVE
63	191.450000	75.000	NXC

```
RP/0/RP0/CPU0:OLT-C-SITE-2#config
Tue Jul 26 06:48:25.732 UTC
RP/0/RP0/CPU0:OLT-C-SITE-2(config)#controller ots-Och 0/0/0/0/63
RP/0/RP0/CPU0:OLT-C-SITE-2(config-Ots)#add-drop-channel ots-Och 0/0/0/30/63
RP/0/RP0/CPU0:OLT-C-SITE-2(config-Ots)#commit
RP/0/RP0/CPU0:OLT-C-SITE-2(config-Ots)#end
RP/0/RP0/CPU0:OLT-C-SITE-2#sh controllers ots-Och 0/0/0/0/63
Tue Jul 26 07:10:28.928 UTC
```

```
Controller State: Up

Transport Admin State: In Service
```

```
Alarm Status:
-----
Detected Alarms: None
```

Parameter Statistics:

```
-----
Total RX Power = -11.80 dBm
Total TX Power = 0.99 dBm
```

Cross Connect Info:

```
-----
Add-Drop Channel = Ots-Och0/0/0/30/63
```

Configured Parameters:

```
-----
RP/0/RP0/CPU0:OLT-C-SITE-2#sh controllers ots-Och 0/0/0/30/63
Tue Jul 26 07:10:33.899 UTC
```

Controller State: Up

Transport Admin State: In Service

Alarm Status:

```
-----
Detected Alarms: None
```

Parameter Statistics:

```
-----
Total RX Power = -4.50 dBm
Total TX Power = -2.20 dBm
```

Cross Connect Info:

```
-----
line Channel = Ots-Och0/0/0/0/63
```

Configured Parameters:

Configuration for OLT-C-SITE-5

```
RP/0/RP0/CPU0:OLT-C-SITE-5#config
Tue Jul 26 06:50:27.739 UTC
Current Configuration Session Line User Date Lock
00001000-000044b2-00000000 con0_RP0_C cisco Fri Jul 22 11:53:12 2022
RP/0/RP0/CPU0:OLT-C-SITE-5(config)#hw-module location 0/0/NXR0 terminal-ampli grid-mode
flex
RP/0/RP0/CPU0:OLT-C-SITE-5(config-hwmod-olt-flexi)#channel-id 63 centre-freq 191.45 width
75
RP/0/RP0/CPU0:OLT-C-SITE-5(config-hwmod-olt-flexi)#commit
Tue Jul 26 06:50:54.786 UTC
RP/0/RP0/CPU0:OLT-C-SITE-5(config-hwmod-olt-flexi)#end
RP/0/RP0/CPU0:OLT-C-SITE-5#sh hw-module location 0/0/NXR0 terminal-ampli
Tue Jul 26 06:51:01.966 UTC
```

Legend:

```
NXC - Channel not cross-connected
ACTIVE - Channel cross-connected to data port
ASE - Channel filled with ASE
FAILED - Data channel failed, pending transition to ASE
```

Location: 0/0/NXR0

Status: Provisioned

Flex Grid Info

Channel Number	Centre Frequency (THz)	Channel Width (GHz)	Channel Status
1	196.100000	75.000	ACTIVE
3	195.950000	75.000	ASE
5	195.800000	75.000	ASE
17	194.900000	75.000	ACTIVE
59	191.750000	75.000	ACTIVE
61	191.600000	75.000	ACTIVE
62	191.525000	75.000	ASE
63	191.450000	75.000	NXC
64	191.375000	75.000	ACTIVE

```
RP/0/RP0/CPU0:OLT-C-SITE-5#config
```

```
Tue Jul 26 06:51:05.833 UTC
```

```
Current Configuration Session Line User Date Lock
```

```
00001000-000044b2-00000000 con0_RP0_C cisco Fri Jul 22 11:53:12 2022
```

```
RP/0/RP0/CPU0:OLT-C-SITE-5(config)#controller ots-Och 0/0/0/0/63
```

```
RP/0/RP0/CPU0:OLT-C-SITE-5(config-Ots)#add-drop-channel ots-Och 0/0/0/30/63
```

```
RP/0/RP0/CPU0:OLT-C-SITE-5(config-Ots)#commit
```

```
RP/0/RP0/CPU0:OLT-C-SITE-5(config-Ots)#end
```

```
RP/0/RP0/CPU0:OLT-C-SITE-5#
```

```
RP/0/RP0/CPU0:OLT-C-SITE-5#sh controllers ots-Och 0/0/0/0/63
```

```
Tue Jul 26 07:12:50.904 UTC
```

```
Controller State: Up
```

```
Transport Admin State: In Service
```

```
Alarm Status:
```

```
-----
```

```
Detected Alarms: None
```

```
Parameter Statistics:
```

```
-----
```

```
Total RX Power = -11.00 dBm
```

```
Total TX Power = 1.89 dBm
```

```
Cross Connect Info:
```

```
-----
```

```
Add-Drop Channel = Ots-Och0/0/0/30/63
```

```
Configured Parameters:
```

```
-----
```

```
RP/0/RP0/CPU0:OLT-C-SITE-5#sh controllers ots-Och 0/0/0/30/63
```

```
Tue Jul 26 07:12:54.871 UTC
```

```
Controller State: Up
```

```
Transport Admin State: In Service
```

```
Alarm Status:
```

```
-----
```

```
Detected Alarms: None
```

```
Parameter Statistics:
```

```
-----
```

```
Total RX Power = -3.70 dBm
Total TX Power = -2.70 dBm
```

```
Cross Connect Info:
```

```
-----
line Channel = Ots-Och0/0/0/0/63
```

```
Configured Parameters:
```

Configuration for OLT-C-SITE-8

```
RP/0/RP0/CPU0:OLT-C-SITE-8#config
Tue Jul 26 06:56:26.764 UTC
Current Configuration Session Line User Date Lock
00001000-0000345b-00000000 con0_RP0_C cisco Fri Jul 22 11:54:38 2022
RP/0/RP0/CPU0:OLT-C-SITE-8(config)#controller ots-Och 0/0/0/0/63
RP/0/RP0/CPU0:OLT-C-SITE-8(config-Ots)#add-drop-channel ots-Och 0/0/0/3/63
RP/0/RP0/CPU0:OLT-C-SITE-8(config-Ots)#commit
Tue Jul 26 06:56:46.290 UTC
RP/0/RP0/CPU0:OLT-C-SITE-8(config-Ots)#end
RP/0/RP0/CPU0:OLT-C-SITE-8#sh hw-module location 0/0/NXR0 terminal-ampli
Tue Jul 26 06:57:06.011 UTC
```

```
Legend:
```

```
NXC - Channel not cross-connected
ACTIVE - Channel cross-connected to data port
ASE - Channel filled with ASE
FAILED - Data channel failed, pending transition to ASE
```

```
Location: 0/0/NXR0
```

```
Status: Provisioned
```

```
Flex Grid Info
```

Channel Number	Centre Frequency (THz)	Channel Width (GHz)	Channel Status
1	196.100000	75.000	ACTIVE
3	195.950000	75.000	NXC
5	195.800000	75.000	ACTIVE
17	194.900000	75.000	ACTIVE
59	191.750000	75.000	ACTIVE
63	191.450000	75.000	ACTIVE
64	191.375000	75.000	ACTIVE

```
RP/0/RP0/CPU0:OLT-C-SITE-8#sh controllers ots-Och 0/0/0/0/63
Tue Jul 26 06:57:28.630 UTC
```

```
Controller State: Up
```

```
Transport Admin State: In Service
```

```
Alarm Status:
```

```
-----
Detected Alarms: None
```

```
Parameter Statistics:
```

```
-----
Total RX Power = -13.20 dBm
Total TX Power = -1.50 dBm
```



```

Cross Connect Info:
-----
Add-Drop Channel = Ots-Och0/0/0/3/63

Configured Parameters:
-----

RP/0/RP0/CPU0:OLT-C-SITE-8#sh controllers ots-Och 0/0/0/3/63
Tue Jul 26 06:57:35.129 UTC

Controller State: Up

Transport Admin State: Automatic In Service

Alarm Status:
-----
Detected Alarms: None

Parameter Statistics:
-----
Total RX Power = -7.50 dBm
Total TX Power = -21.80 dBm

Cross Connect Info:
-----
line Channel = Ots-Och0/0/0/0/63

Configured Parameters:
-----

```

After the cross-connects are created on the OLT nodes, APC regulates the power on each node. The APC status moves from WORKING to IDLE when the process completes. Use the **show olc apc** command to view the status of the operation. The following samples are for OLT-C-SITE-8.

```

RP/0/RP0/CPU0:OLT-C-SITE-8#sh olc apc
Tue Jul 26 06:57:16.020 UTC

Controller      : Ots0/0/0/0
APC Status    : WORKING
Correcting Node : 10.123.1.1

Node RID       : 10.125.1.1
Internal State : IDLE

Node RID       : 10.123.1.1
Internal State : CORRECTING

RP/0/RP0/CPU0:OLT-C-SITE-8#sh olc apc
Tue Jul 26 06:59:11.985 UTC

Controller      : Ots0/0/0/0
APC Status    : IDLE

Node RID       : 10.125.1.1
Internal State : IDLE

Node RID       : 10.123.1.1
Internal State : IDLE

```

After the APC process is complete, the link comes up. You can view the details using the **sh olc apc-local regulation-info controller ots** command on the near-end and far-end nodes.

OLT-R-C-SITE-1:

```
RP/0/RP0/CPU0:OLT-R-C-SITE-1#sh olc apc-local regulation-info controller ots 0/0/0/0
Tue Jul 26 07:02:57.244 UTC
Controller          : Ots0/0/0/0
Domain Manager     : 10.131.1.1
Internal Status    : IDLE
Direction         : TX
PSD Minimum       : -22.0 (dBm/12.5 GHz)
Gain Range        : Normal
Last Correction    : 2022-07-26 06:34:43
```

Device Parameters	Min	Max	Configuration	Operational
Egress Ampli Gain (dB)	15.3	29.3	17.9	17.9
Egress Ampli Tilt (dB)	-5.0	4.3	-1.6	-1.6
TX Ampli Power (dBm)	-	22.3	-	21.6
TX VOA Attenuation (dB)	0.0	20.0	1.3	1.3
Egress WSS/DGE Attenuation (dB)	0.0	25.0	-	-

Channel Center Frequency (THz)	Channel Slice Width Attn Config (GHz)	Channel ID	Channel Source	Spectrum Slice Num	Ampli-Input PSD (dBm/12.5 GHz)	Target PSD (dBm/12.5 GHz)	Current PSD (dBm/12.5 GHz)
191.375000	75.00	-	ASE	13	-21.2	-5.7	-5.7
0.0	7.3						
191.449997	75.00	63	OCh	37	-21.5	-5.7	-5.9
0.2	19.0						
191.524994	75.00	-	ASE	61	-21.3	-5.7	-5.7
0.0	7.3						
191.600006	75.00	-	ASE	85	-21.2	-5.6	-5.6
0.0	7.3						
191.675003	75.00	-	ASE	109	-21.2	-5.6	-5.6
0.0	7.4						
191.750000	75.00	-	ASE	133	-21.1	-5.5	-5.5
0.0	7.3						
191.824997	75.00	-	ASE	157	-21.1	-5.5	-5.5
0.0	7.3						
191.899994	75.00	-	ASE	181	-21.1	-5.5	-5.5
0.0	7.3						
191.975006	75.00	-	ASE	205	-21.2	-5.5	-5.5
0.0	7.4						
192.050003	75.00	-	ASE	229	-21.1	-5.4	-5.4
0.0	7.2						
192.125000	75.00	-	ASE	253	-21.1	-5.4	-5.4
0.0	7.2						
192.199997	75.00	-	ASE	277	-21.0	-5.4	-5.4
0.0	7.2						
192.274994	75.00	-	ASE	301	-21.1	-5.4	-5.4
0.0	7.2						
192.350006	75.00	-	ASE	325	-21.0	-5.3	-5.3
0.0	7.0						
192.425003	75.00	-	ASE	349	-21.0	-5.3	-5.3
0.0	6.9						
192.500000	75.00	-	ASE	373	-21.0	-5.3	-5.4
0.1	7.0						
192.574997	75.00	-	ASE	397	-20.9	-5.3	-5.3
0.0	7.0						
192.649994	75.00	-	ASE	421	-20.9	-5.2	-5.2
0.0	7.0						
192.725006	75.00	-	ASE	445	-20.9	-5.2	-5.2
0.0	6.9						
192.800003	75.00	-	ASE	469	-20.9	-5.2	-5.2
0.0	6.9						
192.875000	75.00	-	ASE	493	-20.9	-5.2	-5.2
0.0	6.9						
192.949997	75.00	-	ASE	517	-20.8	-5.1	-5.1
0.0	6.8						
193.024994	75.00	-	ASE	541	-20.9	-5.1	-5.1
0.0	6.8						
193.100006	75.00	-	ASE	565	-20.9	-5.1	-5.1
0.0	6.7						
193.175003	75.00	-	ASE	589	-20.9	-5.1	-5.1
0.0	6.6						
193.250000	75.00	-	ASE	613	-20.8	-5.0	-5.0

0.0	6.5								
193.324997	75.00	-	ASE	637	-20.9	-5.0	-5.1		
0.0	6.6								
193.399994	75.00	-	ASE	661	-20.8	-5.0	-5.0		
0.0	6.5								
193.475006	75.00	-	ASE	685	-20.9	-5.0	-5.0		
0.0	6.5								
193.550003	75.00	-	ASE	709	-20.9	-4.9	-4.9		
0.0	6.5								
193.625000	75.00	-	ASE	733	-20.9	-4.9	-4.9		
0.0	6.5								
193.699997	75.00	-	ASE	757	-20.9	-4.9	-4.9		
0.0	6.5								
193.774994	75.00	-	ASE	781	-21.0	-4.9	-4.9		
0.0	6.6								
193.850006	75.00	-	ASE	805	-20.9	-4.8	-4.8		
0.0	6.5								
193.925003	75.00	-	ASE	829	-21.0	-4.8	-4.8		
0.0	6.6								
194.000000	75.00	-	ASE	853	-21.0	-4.8	-4.8		
0.0	6.6								
194.074997	75.00	-	ASE	877	-21.0	-4.8	-4.7		
0.0	6.6								
194.149994	75.00	-	ASE	901	-21.0	-4.7	-4.7		
0.0	6.7								
194.225006	75.00	-	ASE	925	-21.0	-4.7	-4.7		
0.0	6.8								
194.300003	75.00	-	ASE	949	-21.1	-4.7	-4.7		
0.0	6.9								
194.375000	75.00	-	ASE	973	-21.0	-4.7	-4.6		
0.0	6.9								
194.449997	75.00	-	ASE	997	-21.0	-4.6	-4.6		
0.0	6.9								
194.524994	75.00	-	ASE	1021	-21.1	-4.6	-4.7		
0.0	7.0								
194.600006	75.00	-	ASE	1045	-21.1	-4.6	-4.6		
0.0	6.9								
194.675003	75.00	-	ASE	1069	-21.1	-4.6	-4.6		
0.0	6.9								
194.750000	75.00	-	ASE	1093	-21.1	-4.5	-4.5		
0.0	6.8								
194.824997	75.00	-	ASE	1117	-21.0	-4.5	-4.5		
0.0	6.7								
194.899994	75.00	17	OCh	1141	-21.2	-4.5	-4.5		
0.0	19.5								
194.975006	75.00	-	ASE	1165	-21.1	-4.5	-4.5		
0.0	6.6								
195.050003	75.00	-	ASE	1189	-21.0	-4.4	-4.4		
0.0	6.4								
195.125000	75.00	-	ASE	1213	-21.1	-4.4	-4.4		
0.0	6.4								
195.199997	75.00	-	ASE	1237	-21.1	-4.4	-4.4		
0.0	6.3								
195.274994	75.00	-	ASE	1261	-21.2	-4.4	-4.5		
0.1	6.3								
195.350006	75.00	-	ASE	1285	-21.2	-4.3	-4.3		
0.0	6.2								
195.425003	75.00	-	ASE	1309	-21.3	-4.3	-4.3		
0.0	6.2								
195.500000	75.00	-	ASE	1333	-21.3	-4.3	-4.3		
0.0	6.2								
195.574997	75.00	-	ASE	1357	-21.5	-4.3	-4.4		
0.1	6.3								
195.649994	75.00	-	ASE	1381	-21.5	-4.2	-4.3		
0.0	6.4								
195.725006	75.00	-	ASE	1405	-21.5	-4.2	-4.1		
-0.1	6.5								
195.800003	75.00	-	ASE	1429	-21.7	-4.2	-4.2		
0.0	6.8								
195.875000	75.00	-	ASE	1453	-21.9	-4.2	-4.3		
0.1	7.1								
195.949997	75.00	-	ASE	1477	-21.8	-4.2	-4.0		
-0.1	7.1								
196.024994	75.00	2	ASE	1501	-21.9	-4.1	-4.1		
0.0	7.3								
196.100006	75.00	-	ASE	1525	-21.9	-4.1	-4.0		
-0.1	7.4								

```

Controller          : Ots0/0/0/0
Domain Manager     : 10.126.1.1
Internal Status    : IDLE
Direction         : RX
PSD Minimum       : -22.0 (dBm/12.5 GHz)
Gain Range        : Normal
Last Correction    : 2022-07-26 06:57:17

```

Cross-connect Configuration

Device Parameters		Min	Max	Configuration	Operational
Ingress Ampli Gain (dB)	:	10.9	23.9	10.9	10.9
Ingress Ampli Tilt (dB)	:	-5.0	5.0	-1.6	-1.6
RX Ampli Power (dBm)	:	-	25.0	-	24.2
RX VOA Attenuation (dB)	:	0.0	0.0	0.0	0.0
Ingress WSS/DGE Attenuation (dB)	:	0.0	25.0	-	-

Channel Center Discrepancy	Channel Frequency	Channel Slice Width Attn Config	Channel ID	Channel Source	Spectrum Slice Num	Ampli-Input PSD	Target PSD	Current PSD
(THz)	(GHz)	(dB)	ID	Source	Slice Num	(dBm/12.5 GHz)	(dBm/12.5 GHz)	(dBm/12.5 GHz)
191.375000	75.00	-	ASE	13	-11.1	-	-25.5	
0.0	25.0							
191.449997	75.00	63	OCh	37	-11.1	-8.0	-8.1	
0.0	2.9							
191.524994	75.00	-	ASE	61	-11.0	-	-25.4	
0.0	25.0							
191.600006	75.00	-	ASE	85	-11.0	-	-25.2	
0.0	25.0							
191.675003	75.00	-	ASE	109	-11.0	-	-25.3	
0.0	25.0							
191.750000	75.00	-	ASE	133	-11.0	-	-25.4	
0.0	25.0							
191.824997	75.00	-	ASE	157	-11.4	-	-25.6	
0.0	25.0							
191.899994	75.00	-	ASE	181	-11.4	-	-25.6	
0.0	25.0							
191.975006	75.00	-	ASE	205	-11.1	-	-25.4	
0.0	25.0							
192.050003	75.00	-	ASE	229	-11.0	-	-25.3	
0.0	25.0							
192.125000	75.00	-	ASE	253	-11.1	-	-25.4	
0.0	25.0							
192.199997	75.00	-	ASE	277	-11.4	-	-25.6	
0.0	25.0							
192.274994	75.00	-	ASE	301	-11.5	-	-25.7	
0.0	25.0							
192.350006	75.00	-	ASE	325	-11.3	-	-25.7	
0.0	25.0							
192.425003	75.00	-	ASE	349	-11.5	-	-25.7	
0.0	25.0							
192.500000	75.00	-	ASE	373	-11.6	-	-25.8	
0.0	25.0							
192.574997	75.00	-	ASE	397	-11.6	-	-25.7	
0.0	25.0							
192.649994	75.00	-	ASE	421	-11.7	-	-25.9	
0.0	25.0							
192.725006	75.00	-	ASE	445	-11.8	-	-26.1	
0.0	25.0							
192.800003	75.00	-	ASE	469	-11.9	-	-26.1	
0.0	25.0							
192.875000	75.00	-	ASE	493	-11.8	-	-26.0	
0.0	25.0							
192.949997	75.00	-	ASE	517	-12.0	-	-26.2	
0.0	25.0							
193.024994	75.00	-	ASE	541	-12.0	-	-26.1	
0.0	25.0							
193.100006	75.00	-	ASE	565	-11.9	-	-26.1	
0.0	25.0							
193.175003	75.00	-	ASE	589	-12.0	-	-26.3	
0.0	25.0							
193.250000	75.00	-	ASE	613	-11.9	-	-26.1	
0.0	25.0							
193.324997	75.00	-	ASE	637	-11.9	-	-26.1	
0.0	25.0							
193.399994	75.00	-	ASE	661	-12.0	-	-26.2	
0.0	25.0							
193.475006	75.00	-	ASE	685	-12.0	-	-26.2	
0.0	25.0							
193.550003	75.00	-	ASE	709	-12.0	-	-26.1	
0.0	25.0							
193.625000	75.00	-	ASE	733	-11.9	-	-26.0	
0.0	25.0							
193.699997	75.00	-	ASE	757	-11.6	-	-25.8	
0.0	25.0							
193.774994	75.00	-	ASE	781	-11.6	-	-25.7	
0.0	25.0							

193.850006	75.00	-	ASE	805	-11.5	-	-25.6
0.0	25.0						
193.925003	75.00	-	ASE	829	-11.4	-	-25.6
0.0	25.0						
194.000000	75.00	-	ASE	853	-11.5	-	-25.6
0.0	25.0						
194.074997	75.00	-	ASE	877	-11.6	-	-25.6
0.0	25.0						
194.149994	75.00	-	ASE	901	-11.7	-	-25.6
0.0	25.0						
194.225006	75.00	-	ASE	925	-11.8	-	-25.6
0.0	25.0						
194.300003	75.00	-	ASE	949	-12.0	-	-25.8
0.0	25.0						
194.375000	75.00	-	ASE	973	-12.0	-	-25.8
0.0	25.0						
194.449997	75.00	-	ASE	997	-12.1	-	-25.9
0.0	25.0						
194.524994	75.00	-	ASE	1021	-12.2	-	-25.9
0.0	25.0						
194.600006	75.00	-	ASE	1045	-12.2	-	-26.0
0.0	25.0						
194.675003	75.00	-	ASE	1069	-12.2	-	-26.0
0.0	25.0						
194.750000	75.00	-	ASE	1093	-12.3	-	-26.0
0.0	25.0						
194.824997	75.00	-	ASE	1117	-12.4	-	-26.1
0.0	25.0						
194.899994	75.00	17	OCh	1141	-12.3	-8.0	-8.1
-0.1	2.0						
194.975006	75.00	-	ASE	1165	-12.1	-	-26.0
0.0	25.0						
195.050003	75.00	-	ASE	1189	-12.0	-	-25.9
0.0	25.0						
195.125000	75.00	-	ASE	1213	-12.0	-	-25.9
0.0	25.0						
195.199997	75.00	-	ASE	1237	-12.0	-	-26.0
0.0	25.0						
195.274994	75.00	-	ASE	1261	-11.8	-	-25.7
0.0	25.0						
195.350006	75.00	-	ASE	1285	-11.7	-	-25.6
0.0	25.0						
195.425003	75.00	-	ASE	1309	-11.6	-	-25.5
0.0	25.0						
195.500000	75.00	-	ASE	1333	-11.7	-	-25.6
0.0	25.0						
195.574997	75.00	-	ASE	1357	-11.8	-	-25.4
0.0	25.0						
195.649994	75.00	-	ASE	1381	-11.4	-	-25.1
0.0	25.0						
195.725006	75.00	-	ASE	1405	-11.5	-	-25.1
0.0	25.0						
195.800003	75.00	-	ASE	1429	-11.7	-	-25.1
0.0	25.0						
195.875000	75.00	-	ASE	1453	-11.8	-	-25.0
0.0	25.0						
195.949997	75.00	-	ASE	1477	-11.6	-	-24.7
0.0	25.0						
196.024994	75.00	2	ASE	1501	-11.9	-9.0	-8.9
-0.1	4.5						
196.100006	75.00	-	ASE	1525	-11.9	-	-24.8
0.0	25.0						

OLT-C-SITE-8:

```

RF/0/RF0/CPU0:OLT-C-SITE-8#sh olc apc-local regulation-info controller ots 0/0/0/0 tX
Tue Jul 26 06:59:33.786 UTC
Controller      : Ots0/0/0/0
Domain Manager  : 10.125.1.1
Internal Status : IDLE
Direction      : TX
PSD Minimumum  : -24.0 (dBm/12.5 GHz)
Gain Range     : Normal
Last Correction : 2022-07-26 06:57:09
    
```

Device Parameters	Min	Max	Configuration	Operational
Egress Ampli Gain (dB)	16.0	30.0	20.3	20.3
Egress Ampli Tilt (dB)	-5.0	3.0	-1.5	-1.5
TX Ampli Power (dBm)	-	23.0	-	22.1
TX VOA Attenuation (dB)	0.0	20.0	5.5	5.5
Egress WSS/DGE Attenuation (dB)	0.0	25.0	-	-

Cross-connect Configuration

Channel Discrepancy	Center Frequency (THz)	Channel Channel Slice Width Attn Config (GHz)	Channel ID	Channel Source	Spectrum Slice Num	Ampli-Input PSD (dBm/12.5 GHz)	Target PSD (dBm/12.5 GHz)	Current PSD (dBm/12.5 GHz)
(dB)	(THz)	(GHz)				(dBm/12.5 GHz)	(dBm/12.5 GHz)	(dBm/12.5 GHz)
191.375000	0.0	75.00	64	OCh	13	-23.0	-8.6	-8.6
0.0	191.449997	20.2						
0.0	191.449997	75.00	63	OCh	37	-23.0	-8.6	-8.6
0.0	191.524994	7.7						
191.524994	0.0	75.00	-	ASE	61	-23.0	-8.6	-8.6
0.0	191.600006	7.8						
191.600006	0.1	75.00	-	ASE	85	-23.1	-8.6	-8.7
0.0	191.675003	7.6						
191.675003	0.0	75.00	-	ASE	109	-23.0	-8.6	-8.6
0.0	191.750000	20.0						
191.750000	0.0	75.00	59	OCh	133	-23.0	-8.5	-8.6
0.0	191.824997	7.8						
191.824997	0.0	75.00	-	ASE	157	-23.1	-8.5	-8.5
0.0	191.899994	7.7						
191.899994	0.0	75.00	-	ASE	181	-23.0	-8.5	-8.5
0.0	191.975006	7.7						
191.975006	0.0	75.00	-	ASE	205	-23.0	-8.5	-8.5
0.0	192.050003	7.6						
192.050003	0.0	75.00	-	ASE	229	-23.0	-8.4	-8.4
0.0	192.125000	7.7						
192.125000	0.0	75.00	-	ASE	253	-23.0	-8.4	-8.5
0.0	192.199997	7.8						
192.199997	0.1	75.00	-	ASE	277	-23.1	-8.4	-8.5
0.0	192.274994	7.6						
192.274994	0.0	75.00	-	ASE	301	-22.9	-8.4	-8.3
0.0	192.350006	7.5						
192.350006	0.0	75.00	-	ASE	325	-22.9	-8.3	-8.4
0.0	192.425003	7.5						
192.425003	0.0	75.00	-	ASE	349	-22.9	-8.3	-8.3
0.0	192.500000	7.5						
192.500000	0.0	75.00	-	ASE	373	-22.8	-8.3	-8.3
0.0	192.574997	7.6						
192.574997	0.1	75.00	-	ASE	397	-23.0	-8.3	-8.4
0.0	192.649994	7.4						
192.649994	0.0	75.00	-	ASE	421	-22.8	-8.2	-8.2
0.0	192.725006	7.4						
192.725006	0.0	75.00	-	ASE	445	-22.8	-8.2	-8.3
0.0	192.800003	7.5						
192.800003	0.1	75.00	-	ASE	469	-22.9	-8.2	-8.3
0.0	192.875000	7.5						
192.875000	0.1	75.00	-	ASE	493	-22.8	-8.2	-8.3
0.0	192.949997	7.3						
192.949997	-0.1	75.00	-	ASE	517	-22.7	-8.1	-8.0
0.0	193.024994	7.3						
193.024994	0.0	75.00	-	ASE	541	-22.7	-8.1	-8.2
0.0	193.100006	7.2						
193.100006	0.0	75.00	-	ASE	565	-22.7	-8.1	-8.1
0.0	193.175003	7.2						
193.175003	0.1	75.00	-	ASE	589	-22.7	-8.1	-8.2
0.0	193.250000	7.2						
193.250000	0.0	75.00	-	ASE	613	-22.7	-8.1	-8.1
0.0	193.324997	7.0						
193.324997	0.0	75.00	-	ASE	637	-22.6	-8.0	-8.0
0.0	193.399994	7.1						
193.399994	0.0	75.00	-	ASE	661	-22.7	-8.0	-8.1
0.0	193.475006	7.1						
193.475006	0.0	75.00	-	ASE	685	-22.7	-8.0	-8.0
0.0	193.550003	7.1						
193.550003	0.0	75.00	-	ASE	709	-22.6	-8.0	-7.9
0.0	193.625000	7.1						
193.625000	0.0	75.00	-	ASE	733	-22.6	-7.9	-7.9
0.0	193.699997	7.1						
193.699997	0.0	75.00	-	ASE	757	-22.7	-7.9	-7.9
0.0	193.774994	7.0						
193.774994	0.0	75.00	-	ASE	781	-22.6	-7.9	-7.9
0.0	193.850006	7.2						
193.850006	0.1	75.00	-	ASE	805	-22.8	-7.9	-8.0
0.0	193.925003	7.0						
193.925003	0.0	75.00	-	ASE	829	-22.6	-7.8	-7.8
0.0	194.000000	7.1						
194.000000	0.1	75.00	-	ASE	853	-22.8	-7.8	-8.0
0.0	194.074997	7.1						
194.074997	0.0	75.00	-	ASE	877	-22.7	-7.8	-7.8
0.0	194.149994	7.2						
194.149994	0.0	75.00	-	ASE	901	-22.8	-7.8	-7.8
0.0	194.225006	7.2						
194.225006	0.0	75.00	-	ASE	925	-22.8	-7.8	-7.8

194.300003	75.00	-	ASE	949	-22.9	-7.7	-7.8
0.0	7.3						
194.375000	75.00	-	ASE	973	-22.8	-7.7	-7.7
0.0	7.3						
194.449997	75.00	-	ASE	997	-22.9	-7.7	-7.8
0.1	7.4						
194.524994	75.00	-	ASE	1021	-22.7	-7.7	-7.5
-0.1	7.2						
194.600006	75.00	-	ASE	1045	-22.8	-7.6	-7.6
0.0	7.3						
194.675003	75.00	-	ASE	1069	-22.8	-7.6	-7.6
0.0	7.3						
194.750000	75.00	-	ASE	1093	-22.8	-7.6	-7.6
0.0	7.2						
194.824997	75.00	-	ASE	1117	-22.8	-7.6	-7.5
0.0	7.1						
194.899994	75.00	17	OCh	1141	-22.9	-7.5	-7.5
0.0	18.8						
194.975006	75.00	-	ASE	1165	-22.8	-7.5	-7.5
0.0	7.0						
195.050003	75.00	-	ASE	1189	-22.9	-7.5	-7.5
0.0	7.1						
195.125000	75.00	-	ASE	1213	-22.8	-7.5	-7.4
0.0	6.9						
195.199997	75.00	-	ASE	1237	-22.9	-7.4	-7.4
0.0	6.8						
195.274994	75.00	-	ASE	1261	-22.9	-7.4	-7.4
0.0	6.8						
195.350006	75.00	-	ASE	1285	-23.0	-7.4	-7.4
0.0	6.9						
195.425003	75.00	-	ASE	1309	-23.1	-7.4	-7.4
0.0	7.0						
195.500000	75.00	-	ASE	1333	-23.1	-7.3	-7.4
0.0	6.8						
195.574997	75.00	-	ASE	1357	-23.1	-7.3	-7.3
0.0	6.8						
195.649994	75.00	-	ASE	1381	-23.3	-7.3	-7.4
0.1	7.0						
195.725006	75.00	-	ASE	1405	-23.3	-7.3	-7.4
0.1	7.1						
195.800003	75.00	5	OCh	1429	-23.3	-7.2	-7.2
0.0	19.1						
195.875000	75.00	-	ASE	1453	-23.5	-7.2	-7.2
0.0	7.3						
195.949997	75.00	-	ASE	1477	-23.6	-7.2	-7.2
0.0	7.4						
196.024994	75.00	-	ASE	1501	-23.8	-7.2	-7.3
0.1	7.6						
196.100006	75.00	1	OCh	1525	-23.7	-7.2	-7.1
0.0	19.4						

ASE - Noise Loaded Channel
OCh - Optical Channel

```
RP/0/RP0/CPU0:OLT-C-SITE-8#sh olc apc-local regulation-info controller ots 0/0/0/0 rx
Tue Jul 26 06:59:42.151 UTC
Controller          : Ots0/0/0/0
Domain Manager     : 10.123.1.1
Internal Status    : DISCREPANCY
Direction         : RX
PSD Minumum       : -24.0 (dBm/12.5 GHz)
Gain Range        : Normal
Last Correction    : 2022-07-26 06:59:39
```

Device Parameters	Min	Max	Configuration	Operational
Ingress Ampli Gain (dB)	12.0	25.0	19.7	19.7
Ingress Ampli Tilt (dB)	-5.0	1.8	0.4	0.4
RX Ampli Power (dBm)	-	25.0	-	24.2
RX VOA Attenuation (dB)	0.0	0.0	0.0	0.0
Ingress WSS/DGE Attenuation (dB)	0.0	25.0	-	-

Channel Discrepancy	Channel Center Frequency (THz)	Channel Slice Width (GHz)	Channel ID	Channel Source	Spectrum Slice Num	Ampli-Input PSD (dBm/12.5 GHz)	Target PSD (dBm/12.5 GHz)	Current PSD (dBm/12.5 GHz)
0.1	191.375000	75.00	64	OCh	13	-20.7	-8.0	-8.1
0.1		5.1						

Cross-connect Configuration

191.449997	75.00	63	OCh	37	-20.6	-8.0	-22.4
14.4	15.3						
191.524994	75.00	62	ASE	61	-20.6	-	-25.6
0.0	25.0						
191.600006	75.00	61	OCh	85	-20.6	-	-25.6
0.0	25.0						
191.675003	75.00	-	ASE	109	-20.4	-	-25.4
0.0	25.0						
191.750000	75.00	59	OCh	133	-20.4	-8.0	-8.1
0.0	5.4						
191.824997	75.00	-	ASE	157	-20.4	-	-25.4
0.0	25.0						
191.899994	75.00	-	ASE	181	-20.5	-	-25.5
0.0	25.0						
191.975006	75.00	-	ASE	205	-20.4	-	-25.4
0.0	25.0						
192.050003	75.00	-	ASE	229	-20.4	-	-25.4
0.0	25.0						
192.125000	75.00	-	ASE	253	-20.3	-	-25.3
0.0	25.0						
192.199997	75.00	-	ASE	277	-20.4	-	-25.4
0.0	25.0						
192.274994	75.00	-	ASE	301	-20.5	-	-25.4
0.0	25.0						
192.350006	75.00	-	ASE	325	-20.1	-	-25.2
0.0	25.0						
192.425003	75.00	-	ASE	349	-20.2	-	-25.3
0.0	25.0						
192.500000	75.00	-	ASE	373	-20.3	-	-25.3
0.0	25.0						
192.574997	75.00	-	ASE	397	-20.4	-	-25.4
0.0	25.0						
192.649994	75.00	-	ASE	421	-20.4	-	-25.3
0.0	25.0						
192.725006	75.00	-	ASE	445	-20.3	-	-25.3
0.0	25.0						
192.800003	75.00	-	ASE	469	-20.3	-	-25.3
0.0	25.0						
192.875000	75.00	-	ASE	493	-20.3	-	-25.4
0.0	25.0						
192.949997	75.00	-	ASE	517	-20.3	-	-25.3
0.0	25.0						
193.024994	75.00	-	ASE	541	-20.2	-	-25.3
0.0	25.0						
193.100006	75.00	-	ASE	565	-20.3	-	-25.4
0.0	25.0						
193.175003	75.00	-	ASE	589	-20.3	-	-25.3
0.0	25.0						
193.250000	75.00	-	ASE	613	-20.3	-	-25.5
0.0	25.0						
193.324997	75.00	-	ASE	637	-20.2	-	-25.3
0.0	25.0						
193.399994	75.00	-	ASE	661	-20.4	-	-25.5
0.0	25.0						
193.475006	75.00	-	ASE	685	-20.4	-	-25.5
0.0	25.0						
193.550003	75.00	-	ASE	709	-20.5	-	-25.6
0.0	25.0						
193.625000	75.00	-	ASE	733	-20.4	-	-25.5
0.0	25.0						
193.699997	75.00	-	ASE	757	-20.3	-	-25.4
0.0	25.0						
193.774994	75.00	-	ASE	781	-20.4	-	-25.5
0.0	25.0						
193.850006	75.00	-	ASE	805	-20.4	-	-25.5
0.0	25.0						
193.925003	75.00	-	ASE	829	-20.3	-	-25.4
0.0	25.0						
194.000000	75.00	-	ASE	853	-20.3	-	-25.4
0.0	25.0						
194.074997	75.00	-	ASE	877	-20.4	-	-25.5
0.0	25.0						
194.149994	75.00	-	ASE	901	-20.5	-	-25.5
0.0	25.0						
194.225006	75.00	-	ASE	925	-20.4	-	-25.4
0.0	25.0						
194.300003	75.00	-	ASE	949	-20.4	-	-25.5
0.0	25.0						
194.375000	75.00	-	ASE	973	-20.4	-	-25.4
0.0	25.0						
194.449997	75.00	-	ASE	997	-20.4	-	-25.5
0.0	25.0						
194.524994	75.00	-	ASE	1021	-20.4	-	-25.4
0.0	25.0						
194.600006	75.00	-	ASE	1045	-20.4	-	-25.4
0.0	25.0						

194.675003	75.00	-	ASE	1069	-20.4	-	-25.5
0.0	25.0						
194.750000	75.00	-	ASE	1093	-20.4	-	-25.4
0.0	25.0						
194.824997	75.00	-	ASE	1117	-20.4	-	-25.4
0.0	25.0						
194.899994	75.00	17	OCh	1141	-20.2	-8.0	-8.0
0.0	2.1						
194.975006	75.00	-	ASE	1165	-20.3	-	-25.5
0.0	25.0						
195.050003	75.00	-	ASE	1189	-20.2	-	-25.5
0.0	25.0						
195.125000	75.00	-	ASE	1213	-20.3	-	-25.6
0.0	25.0						
195.199997	75.00	-	ASE	1237	-20.3	-	-25.6
0.0	25.0						
195.274994	75.00	-	ASE	1261	-20.2	-	-25.6
0.0	25.0						
195.350006	75.00	-	ASE	1285	-20.2	-	-25.6
0.0	25.0						
195.425003	75.00	-	ASE	1309	-20.0	-	-25.5
0.0	25.0						
195.500000	75.00	-	ASE	1333	-20.1	-	-25.6
0.0	25.0						
195.574997	75.00	-	ASE	1357	-20.1	-	-25.6
0.0	25.0						
195.649994	75.00	-	ASE	1381	-19.9	-	-25.5
0.0	25.0						
195.725006	75.00	-	ASE	1405	-19.8	-	-25.4
0.0	25.0						
195.800003	75.00	5	ASE	1429	-19.9	-8.0	-7.9
0.0	1.8						
195.875000	75.00	-	ASE	1453	-19.8	-	-25.3
0.0	25.0						
195.949997	75.00	3	ASE	1477	-19.7	-	-25.2
0.0	25.0						
196.024994	75.00	-	ASE	1501	-19.7	-	-25.0
0.0	25.0						
196.100006	75.00	1	OCh	1525	-19.5	-8.0	-8.1
0.0	6.0						

ASE - Noise Loaded Channel
OCh - Optical Channel



CHAPTER 3

Network Set Up Using Cisco Optical Network Controller

This chapter describes how to Onboard devices, Import Planning data, and Monitor Connection Issues in Cisco Optical Network Controller.

- [Cisco ONC Workflow, on page 87](#)

Cisco ONC Workflow

In Cisco ONC, you import the planning data from Cisco ONP and associate the hardware brought up using CLI or ZTP to the planned devices. For this, you must first onboard the devices in Cisco ONC. After associating actual devices to planned data, you can push the necessary configurations for planned passives, connections, and optical attributes on to the devices from the Cisco ONC web interface. The following sections describe the Cisco ONC workflow to onboard devices, import planning data, associate planned devices to actual devices, and push configurations on to the devices in bulk.

Onboard Devices in Cisco ONC

Before you begin

You need an XLSX file that contains the information required to onboard the devices in Cisco ONC. See [Excel File for Onboarding Devices on Cisco ONC , on page 89](#)

-
- Step 1** Log in to Cisco ONC Web Interface.
 - Step 2** Click **Devices** in the left panel
 - Step 3** Click **Import Devices**.
 - Step 4** Select the spreadsheet which has all the device details and click Open.

Cisco ONC takes a few seconds to import each device. While the import is in progress, Cisco ONC displays **XLS import in progress**.

Note You can manually add each device using by clicking **+New** from the **Devices** page and entering the device information.

Import Planning Data in Cisco ONC

Before you begin

You need the planning data JSON file generated using Cisco ONP.

- Step 1** Log in to Cisco ONC web Interface.
- Step 2** Hover over the **Import** icon in the left panel and click **Planning Data Import**.
- Step 3** Click **Import**.
- Step 4** Upload the JSON file from Cisco Optical Network Planner.
The Planning Data Import page displays the details of the imported devices.

Note Map the planning data to actual data in the next step.

Import Planned Passives, Connections, Optical Attributes

- Step 1** Log in to Cisco ONC web Interface.
- Step 2** Hover over the **Import** icon in the left panel and click **Planning Data Import**.
- Step 3** Click **Edit**.
The fields Actual Site Name and Actual Device Name become editable.
- Step 4** From the drop-down boxes, select the actual device and Site names for each of the planned devices and click **Apply Changes**.
- Step 5** Select all the planned devices in the table.
- Step 6** Click **Bulk Push**.
- Step 7** Select **Equipments**, **Internal Patch Cord**, and **Optical Attributes** and click **Push**.

Note You can see the status of the push in the Last Push Status field for each device.

Connect Passives and Cables

Create port connections as seen in the [Reference Network Topology](#) . For more information on port connections between the devices, see [NCS 1010 Overview](#).

Monitor Connection Issues in Cisco ONC

You can monitor the following connection issues using the Cisco ONC web interface:

- **Passive slot mismatch due to USB connection issues**

If a passive module is placed in an incorrect slot, it may cause errors. Connection Verification of all connections to the passive module in an incorrect slot fails.

To identify a module in an incorrect slot, follow these steps:

1. Log in to Cisco ONC Web Interface.
2. Click **Sites** in the left panel.
3. Click the target site.
4. Click Inventory.
5. In the inventory table, check if there are any entries where **Eqpt Type** and **Actual Eqpt Type** are different.

If there is a mismatch between Eqpt Type and Actual Eqpt Type for a passive module, the module may be in an incorrect slot.

- **Wrong patch cord connections**

To identify an incorrect patch cord connection, follow these steps:

1. Log in to Cisco ONC web Interface.
2. Click **Sites** in the left panel.
3. Click the target site.
4. Click **Optical Configurations**.
5. Under **Internal Patch Cords**, select the patch cord you want to check and click **Verify Connection**.

Cisco ONC performs connection verification. If the Forward CV Status or Reverse CV Status is **FAILED**, it may be an incorrect connection.

Excel File for Onboarding Devices on Cisco ONC

Use this Excel file to onboard devices on Cisco ONC. The information in this file is based on the sample topology and ZTP configuration discussed in previous sections of this document.

Host Name	Node IP	Password Type	User Name	Password	Product Type	Connectivity Type	Con Port
OLT-C-SITE-2	10.4.33.126	USER_NEICONF	cisco	cisco123	NCS1010	NETCONF	830
OLT-C-SITE-3	10.4.33.121	USER_NEICONF	cisco	cisco123	NCS1010	NETCONF	830
OLT-C-SITE-4	10.4.33.124	USER_NEICONF	cisco	cisco123	NCS1010	NETCONF	830
OLT-C-SITE-5	10.4.33.123	USER_NEICONF	cisco	cisco123	NCS1010	NETCONF	830
OLT-C-R-SITE-1	10.4.33.131	USER_NEICONF	cisco	cisco123	NCS1010	NETCONF	830

OLT-C-R-SITE-7	10.4.33.127	USER_NEICONF	cisco	cisco123	NCS1010	NETCONF	830
OLT-C-SITE-6	10.4.33.125	USER_NEICONF	cisco	cisco123	NCS1010	NETCONF	830
OLT-C-SITE-8	10.4.33.129	USER_NEICONF	cisco	cisco123	NCS1010	NETCONF	830
ILA-2R-C-SITE-1	10.4.33.128	USER_NEICONF	cisco	cisco123	NCS1010	NETCONF	830
ILA-R-C-SITE-2	10.4.33.134	USER_NEICONF	cisco	cisco123	NCS1010	NETCONF	830
ILA-C-SITE-3	10.4.33.122	USER_NEICONF	cisco	cisco123	NCS1010	NETCONF	830
ILA-R-C-SITE-4	10.4.33.137	USER_NEICONF	cisco	cisco123	NCS1010	NETCONF	830
ILA-C-SITE-5	10.4.33.135	USER_NEICONF	cisco	cisco123	NCS1010	NETCONF	830



CHAPTER 4

Network Discovery and Link Provisioning in Cisco Crosswork Hierarchical Controller

This chapter describes Network Discovery in the Hierarchical Controller, Provisioning end-to-end OCH-NC and IP Links, and Troubleshooting OCH-NC and IP Links using the Hierarchical Controller and Cisco Optical Network Controller

- [Network Discovery in the Hierarchical Controller, on page 91](#)
- [Provision End-to-End OCH-NC Link, on page 95](#)
- [Provision the IP Link, on page 99](#)
- [Troubleshoot IP Link and OCH-NC through the Hierarchical Controller and Cisco Optical Network Controller, on page 100](#)

Network Discovery in the Hierarchical Controller

Prerequisite:

Verify the following Crosswork Hierarchical Controller Applications are installed and enabled.

- Explorer
- Network Inventory
- Link Assurance
- Service Manager
- Device Manager

View Installed Crosswork Hierarchical Controller Applications

Use this procedure to view the installed Crosswork Hierarchical Controller Applications.

Step 1 To view the installed Crosswork Hierarchical Controller applications:

After the installation is complete, ensure that you have root access to the OS where Crosswork Hierarchical Controller is installed, and type `sedo -h` to open the sedo utility.

Step 2 Run the following command to see which applications are installed:

```
sedo apps list
```

The output displays the installed applications with their ID, name and if they are enabled or not. All applications, except system applications (for example, Device Manager) are disabled by default.

Add Cisco Optical Network Controller Adapter

Use this procedure to add Cisco ONC adapter.

Step 1 In the applications bar in Crosswork Hierarchical Controller, select **Services > Device Manager**.

A list of the adapters appears in the Adapters pane.

Step 2 Click **Add new adapter**.

Step 3 Enter the adapter details:

- **Adapter Type:** Select the adapter type from the list of available adapter types currently installed in Crosswork Hierarchical Controller. The Cisco Optical Network Controller adapter is `cisco-onc-adpt`.
- **Adapter Name:** Unique user defined name of this adapter type instance (there can be several instances of the same adapter type).

Step 4 Click **Add**.

Step 5 To configure the adapter, select the adapter in the **Adapters** pane.

- **Enabled:** Whether the adapter is enabled or disabled.
- **Logging Level:** The logging level (Info, Critical, Error, Warning, Debug). Info by default.
- **Polling Cycle (sec):** The polling interval in seconds. The Polling cycle must be set to 300s or higher.
- **Number of concurrent routers collected:** The number of network elements that can be concurrently polled in a polling cycle.
- **Enable provisioning support:** Whether or not to enable provisioning support. For example, if provisioning is enabled, creating a new tunnel or service.

Step 6 Click the **General** tab.

Step 7 Configure the following options:

- **Enabled:** Whether the adapter is enabled or disabled.
- **Logging Level:** The logging level (Info, Critical, Error, Warning, Debug). Info by default.
- **Polling Cycle (sec):** The polling interval in seconds.
- **Number of concurrent routers collected:** The number of network elements that can be concurrently polled in a polling cycle.
- **Enable provisioning support:** Whether or not to enable provisioning support. For example, if provisioning is enabled, creating a new tunnel or service.

- Step 8** Configure Connection Properties.
- **Host:** This is the URL to access the Cisco Optical Network Controller TAPI interface. The format is `https://<ip>:<port>/crosswork/onc-tapi/`.
 - **Timeout**
 - **Credentials:** The TAPI credentials that you have added using the Credentials Manager.
- Step 9** Configure the FILE BRINGER PARAMETERS:
- **Enable File Bringer:** This enables the module in the adapter to transfer the files from the remote file server to Crosswork Hierarchical Controller.
 - **File Server Location:** The file server location. The format is `http/sftp://<ip>:port/<path>`.
 - **File Type:** For example, CSV, JSON.
 - **Authentication**
- Step 10** Configure Notifications.
- **Enabled:** Whether notifications are enabled or disabled.
 - **URL Sub-part:** Set CONC_NETCONF
- Step 11** Configure Stats Collection.
- **Enabled:** Whether Stats Collection is enabled or disabled.
 - **Stats Interval Polling (sec):** The polling interval in seconds.
- Step 12** Click **Save**.
-

Network Discovery for a New Network

Onboard Devices in Cisco Optical Network Controller

Follow the steps in [Onboard Devices in Cisco ONC](#), [Import Planning Data in Cisco ONC](#), and [Import Planned Passives, Connections, Optical Attributes](#) from Cisco Optical Network Controller workflows.

After onboarding is complete in Cisco Optical Network Controller, the devices are automatically populated in the Hierarchical Controller.

Create Sites for Network View

To add sites in Sites Manager:

- Step 1** In the applications bar in Crosswork Hierarchical Controller, select **Services > Model Settings**.
- Step 2** Select the **Sites** tab.
- Step 3** Click **Add New Site**.
- Step 4** Enter the site details. For example, ST/London.

Step 5 Click **Save Site**.

Map Devices to Geographical Location

To map devices to sites in Device Manager:

Step 1 In the applications bar in Crosswork Hierarchical Controller, select **Device Manager > Adapters > Devices**.

Step 2 Click a device.

Step 3 In the general tab, select the site for the device.

Step 4 Click **Save**.

Step 5 Repeat for all devices.

Network discovery in Crosswork Hierarchical Controller is complete. You can view devices and links in the Network Explorer app.

Network Discovery for an Existing Network

If a network has already been onboarded on to Cisco Optical Network Controller before adding the Optical Network Controller adapter to Crosswork Hierarchical Controller, the devices get automatically populated in the Hierarchical Controller after the adapter is added. After the devices are populated on the Hierarchical Controller, [Create Sites for Network View](#) and [Map Devices to Geographical Location](#). You can view devices and links in the Network Explorer app.

Network Discovery after Update of an Existing Network

In case of a network update follow the same procedure as for a new network. [Onboard Devices in Cisco ONC](#), [Create Sites for Network View](#), and [Map Devices to Geographical Location](#). You can view the new devices and links in the Network Explorer app.

Delete Devices from the Network

To delete a device from Crosswork Hierarchical Controller:

Prerequisites

You must remove all the circuits passing through that device to delete a device from the Hierarchical Controller.

Delete Device from Cisco Optical Network Controller

Use this task to delete the devices onboarded to Cisco Optical Network Controller.



Restriction Do not delete more than 10 devices in a 5 minute interval.

Step 1 Log into Cisco Optical Network Controller.

Step 2 Click **Devices** in the left panel.

Step 3 Select the target device and click **Delete**.

Note You cannot delete a device if collection is in progress. The Cisco Optical Network Controller UI shows the device status. Verify the status is not collection in progress before deleting a device.

You cannot delete devices if they have circuits provisioned. Remove the circuits before deleting the devices. If you try to delete a device that has circuits passing through it, the delete operation fails.

Remove Device from Crosswork Hierarchical Controller

You can delete a device and unassign it from its adapters. The device is deleted from the model.

To delete a device:

Step 1 In the applications bar in Crosswork Hierarchical Controller, select **Services > Device Manager**.

Step 2 Select the required adapter.

Step 3 Select the **Managed Devices** tab.

Step 4 Click on the required device row (not on the link in the Name column).

Step 5 Click **Delete device**.

A confirmation message appears.

Step 6 Click **Confirm** to delete the device, unassign it from all adapters and delete the device from the mode.

You can view the updated devices and links in the Network Explorer app.

Provision End-to-End OCH-NC Link

Before You Begin

- [Network Discovery in the Hierarchical Controller](#)
- [Create IPC Using Cisco Optical Network Controller](#)
- [Import Alien Wavelength to the Hierarchical Controller](#)

Create IPC Using Cisco Optical Network Controller

IPCs are created between the OCH ports of the OLT device and the OMS ports of the passive device. This is needed to expose the service end points to the Hierarchical Controller.

To create IPC in Cisco Optical Network Controller:

-
- Step 1** Log into Cisco Optical Network Controller.
 - Step 2** Click **Sites** in the left panel.
 - Step 3** Click the site that you want to add the details of.
 - Step 4** Click **Optical Configurations**.
 - Step 5** Click **Add**.
 - Step 6** Select the source and destination devices and ports from the respective drop-down lists.
 - Step 7** Click **Add**.
-

Import Alien Wavelength to the Hierarchical Controller

Importing Alien wavelength to the Hierarchical Controller involves the following steps:

-
- Step 1** Download the optical source from an Excel sheet in Cisco Optical Network Planner, customize the excel template based on the requirements, and import the customized excel template in Cisco Optical Network Planner. See [Import Optical Sources](#).
 - Step 2** Download Optical Source in XML format in Cisco Optical Network Planner. See [Download Optical Sources](#).
 - Step 3** Import the Alien wavelength in Cisco Optical Network Controller from Cisco Optical Network Planner. See [Use Alien Import](#).
 - Step 4** Export the Alien wavelength from Cisco Optical Network Controller. See [Use Alien Import](#).
 - Step 5** Import the Alien wavelength to the Hierarchical Controller.
 - In the applications bar in Crosswork Hierarchical Controller, select **Services > Services Manager > Settings**.
A list of the service settings appears.
 - In OPTICAL TRANSCEIVERS APPLICATION CODES, click the **hamburger** icon to select an XML file with the application codes.
 - Click **Import**.
-

Create End-to-End OCH-NC Link

-
- Step 1** In the applications bar in Crosswork Hierarchical Controller, select **Services > Services Manager**.
 - Step 2** Select the **Point to Point** tab.
 - Step 3** Click **OCH-NC Link**.
The **OCH-NC Link** wizard appears.
 - Step 4** In the **GENERAL** pane of the wizard, specify the following:

- **Name:** The unique user-defined name of this link.
- **Description:** A description of the link.

Step 5 Click **Next**.

Step 6 In the **SETTINGS** pane of the wizard, specify the following:

- **Optical Feasibility Threshold:** Indicates the optical feasibility of the OCH-NC link to ensure that the link is operational after provisioning. The optical feasibility is represented by the following colors: Choose **RED**, **GREEN**, **YELLOW** or **NONE**. For more information, see the [Channel Validation Coloring](#) section.
- **Admin State:** Choose **ENABLED** or **DISABLED**.
- **Central Frequency (THz):** (Optional) The frequency for this OCH-NC link. A number in range of nine digits, with a dot after the first 3 digits (xxx.xxxxxx). The range is between 000.000000 to 999.999999 in steps of 000.000001. If the value is blank, the first suitable wavelength is automatically assigned.

Step 7 Click **Next**.

Step 8 In the **APPLICATION CODE** pane of the wizard, specify the following:

- **Vendor Name:** The vendor name.
- **Product ID:** The product ID which is the Alien wavelength.
- **FEC:** The FEC depends on the product, for example, CFEC or OFEC.
- **Data Rate:** The data rate supported by the selected product.
- **Baud Rate:** The baud rate supported by the selected product.
- **Sub Mode:** This may appear depending on the other settings.

Application code is generated from the above parameters and is unique for each interface.

Step 9 Click **Next**.

Step 10 In the **ENDPOINTS** pane of the wizard, specify the following:

- Choose **Single Channel** or **Multiple Channel**. There will be multiple endpoints for Multiple Channel.
- **Endpoint A:** Click the **Search** icon and in the **Advanced** tab, select an NMC port, or click the **3D Explorer** tab and select an endpoint.
- **Endpoint B:** Click the **Search** icon and in the **Advanced** tab, select an NMC port, or click the **3D Explorer** tab and select an endpoint.

Step 11 Click **Next**.

Step 12 In the **PATH** pane of the wizard, specify the following:

- **Optimization Goal:** The optimization goal (**Number of Hops** or **Admin Cost**).
- **Disjoint From Link:** (Optional) Click the **Search** icon and in the **Advanced** tab, select an OCH-NC link, or click the **3D Explorer** tab to select an OCH-NC link. This means that the new OCH-NC link must not traverse this path.
- **Include Nodes or Links:** (Optional) Click the **Search** icon and in the **Advanced** tab, select a link, or click the **3D Explorer** tab to select a link.

- **Exclude Nodes or Links:** (Optional) Click the **Search** icon and in the **Advanced** tab, select a link, or click the **3D Explorer** tab to select a link.

Step 13 Click **Next**.

Step 14 In the **SUMMARY** pane of the wizard, review the details provided and click **Finish** to create an OCH-NC link.

Channel Validation Coloring

The optical power and OSNR of each channel are simulated over a specific optical path with average value (considering typical values) and variance (considering statistical propagation of variances). The simulation provides the statistical optical power and OSNR at the RX side of the optical interface. The statistical optical power and OSNR values delivered from the DWDM system are compared with the target optical power and OSNR values requested at the RX side of the optical interface for error-free post-FEC. This comparison provides channel validation coloring.

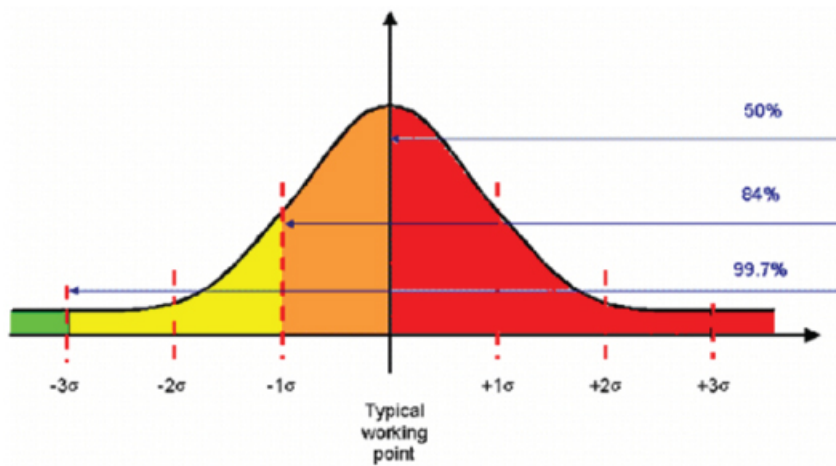

- Average-OSNR $- 3x\sigma >$ target-OSNR \Rightarrow GREEN or working probability $> 99\%$
- Average-OSNR $- 1xs >$ target-OSNR \Rightarrow YELLOW or $99\% >$ working probability $> 84\%$
- Average-OSNR $<$ target-OSNR \Rightarrow RED or working probability less than 50%

For each channel, optical power and OSNR margins are calculated considering the statistical worst case.

The following figure describes the (Typical_value -3σ) working point with respect to the optical interface working area (including penalties).

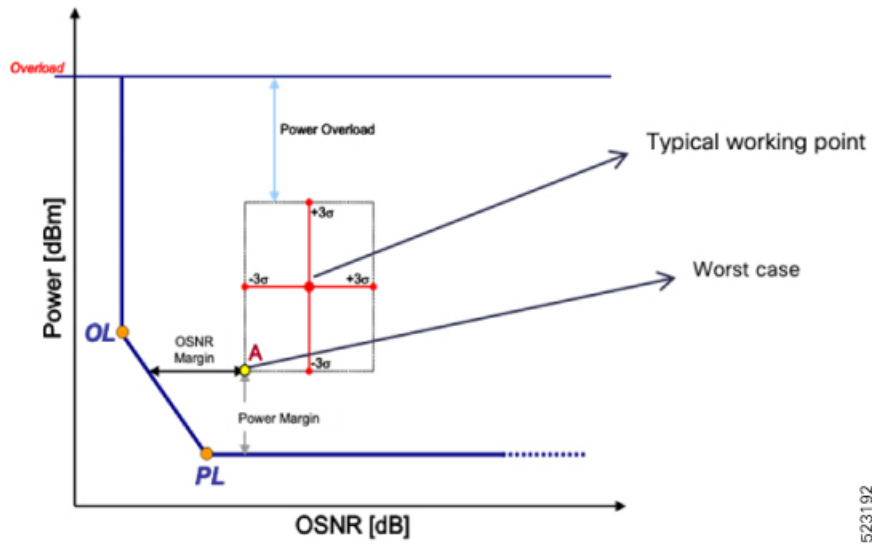

Provision the IP Link

See [Provision Routed Optical Networking ML Service Using Crosswork Hierarchical Controller](#).

Troubleshoot IP Link and OCH-NC through the Hierarchical Controller and Cisco Optical Network Controller

Device Addition Failure

Reason	Description/Details	Troubleshooting	Workarounds/Remarks
Connection Failure	UI status – Disconnected	Check connectivity to the device by – Check if the user provided details like Device type, IP, Port, Protocol, and device credentials are correctly mentioned in Cisco Optical Network Controller UI.	Correct the details provided in the Cisco Optical Network Controller UI.
		Check if Ping to the device is working	Check if the device is properly configured and has proper network configuration.
		Check if the Netconf and gRPC (for NCS1010) connectivity to the device on the Netconf/gRPC port is working.	Check if the Netconf/gRPC and XR configuration is proper on the NCS1010 device
Collection Failure	UI status – Failed/Errored	Check the release on the NCS1010/SVO device.	NCS1010 should be running Release 7.7.1. SVO should be running one of the following releases – 12.2, 12.3, 12.3.1 If the issue occurs even when the required software versions are present call TAC.

Device Deletion Failure

Reason	Description/Details	Troubleshooting	Workarounds/Remarks
Device is part of a Circuit	UI status – Circuit/Service spanning over the device - TBD	This is expected Cisco Optical Network Controller behavior.	Delete the Circuit/Connectivity-service (via NBI) and then try Device deletion.

Reason	Description/Details	Troubleshooting	Workarounds/Remarks
Collection In Progress	UI Status – Device cannot be deleted because Collection is in Progress	This is expected Cisco Optical Network Controller behavior.	Wait for the collection to be completed and then try device deletion.
Resync in Progress	UI status – Device cannot be deleted because Collection is in Progress	This is expected Cisco Optical Network Controller behavior.	Wait for the Resync to be completed and then try device deletion.
Connectivity Check in Progress	UI status – Device cannot be deleted because Waiting for Connection	This is expected Cisco Optical Network Controller behavior.	Wait for the Resync/Recollection to be completed and then try device deletion.

IPC Creation Creation/Deletion Failure

Reason	Description/Details	Troubleshooting	Workaround/Remarks
Invalid Port Selected	UI status – Invalid port selected on OLT for a MPO passive type	This is expected Cisco Optical Network Controller behavior.	Select the Correct Source and Destination ports.
UI not Refreshed/Updated	UI Status – No IPC found between given source and destination ports OR Either or both the ports are already mapped!	This could be expected Cisco Optical Network Controller behavior.	Click the Refresh button on the IPC tab and try IPC creation/deletion again.
Device Not Reachable	UI Status – IPC Creation Failed	This could be expected Cisco Optical Network Controller behavior.	Please verify Device Reachability.

Resync Operation failure

Reason	Description/Details	Troubleshooting	Workaround/Remarks
Device not reachable	UI status – Device – Disconnected Status – Blank/Resync pending/Resync Failed	This is expected Cisco Optical Network Controller behavior.	Check if the device is properly configured and has proper network configuration. Check if the Netconf/gRPC and XR configuration is proper on the NCS1010 device. Try Resync again Check the release on the SVO/NCS1010 device for compatibility with Cisco Optical Network Controller release.
Device credentials changed on the device	UI status – Device – Disconnected Status – Blank/Resync pending/Resync Failed	This is expected Cisco Optical Network Controller behavior.	Edit the device credentials via Optical Network Controller UI and click OK. Resync will happen automatically.

Circuit Creation Failure

Reason	Description/Details	Troubleshooting	Workaround/Remarks
No Route Available	Cisco Optical Network Controller UI status – NA	No route can be found by the Path Computation Engine. Could be expected behavior.	Check the topology and the route for the currently created services.
Wrong SIP Selection	Cisco Optical Network Controller status – NA	SIP UUIDs are not proper	Check the list of available SIPs and supply only SIPs returned from the T-API topology-context fetched by the Hierarchical Controller from Optical Network Controller as part of the get call.
Device(s) not reachable	Cisco Optical Network Controller status – NA	Circuit will move to Pending-Removal lifecycle state.	Check the device reachability and fix it Delete the connectivity-service Recreate the connectivity-service.

Reason	Description/Details	Troubleshooting	Workaround/Remarks
Routing constraint is Invalid	Cisco Optical Network Controller status – NA	Could be due to invalid UUIDs provided in the connectivity-service request constraints.	Check the list of available constraints and supply only valid constraints.
Routing Constraint Not Feasible	Cisco Optical Network Controller status – NA	Could be expected behavior since a route may not be available meeting the Constraint provided.	Check the topology and the constraint provided.

Circuit Deletion Failure

Reason	Description/Details	Troubleshooting	Workaround/Remarks
Circuit Deletion attempted before circuit creation is completed	Connectivity-service lifecycle-state is Planned and same service deletion is attempted.	This is expected behavior.	Wait till the circuit lifecycle-state is either Installed or Pending-removal .
Invalid Circuit ID	Invalid connectivity-service UUID is provided	This is expected behavior.	Connectivity-service should be of an existing connectivity-service in the T-API connectivity-context.

Planning Data Import Failure

Reason	Description/Details	Troubleshooting	Workaround/Remarks
Planning data file format is not proper	UI status – Request Failed	This is expected Cisco Optical Network Controller behavior.	Please check the file format. Cisco Optical Network Controller supports JSON file format from Cisco Optical Network Planner only.
Passive cards are already connected to OLT	UI status – Error - Equipment Failed	This is expected Cisco Optical Network Controller behavior.	Please physically remove and disconnect the Passive cards before pushing the data.
IPC already created in Optical Network Controller	UI status – Error – Internal Patch cord Failed	This is expected Cisco Optical Network Controller behavior.	Please remove the IPC from Cisco Optical Network Controller before pushing the data.

Reason	Description/Details	Troubleshooting	Workaround/Remarks
Optical attributes are not compatible with the device	UI status – Error – Optical attributes Failed	This is expected Cisco Optical Network Controller behavior.	Please check and ensure that the actual hardware connected matches with the planned devices on Cisco Optical Network Planner. You can check this on the Cisco Optical Network Planner Planning data import screen using the actual device field.

Alien import failure

Reason	Description/Details	Troubleshooting	Workaround/Remarks
Alien file format is not proper	UI status – Request Failed	This is expected Cisco Optical Network Controller behavior.	Please check the file format. Cisco Optical Network Controller supports XML file format from Cisco Optical Network Planner only.

CV failure

Reason	Description/Details	Troubleshooting	Workaround/Remarks
Empty tone ID	UI status – Empty Tone ID	This is expected Cisco Optical Network Controller behavior.	Please remove the IPC and all related services and recreate it setting the tone ID to have CV working. This is a traffic affecting operation. Please see the connection verification workflow.
Degraded or broken IPC	UI status – Failed	This is expected Cisco Optical Network Controller behavior.	Please check the integrity of the IPC (physical fiber) and replace it if needed. To check the integrity, you need a reference power source and a power meter. Inject light on one end of the patch cord and measure the loss at other end of the patch cord.

PM failure

Reason	Description/Details	Troubleshooting	Workaround/Remarks
Device Reachability	Cisco Optical Network Controller UI status – Device Status – Disconnected	This is expected Cisco Optical Network Controller behavior if the device is not reachable or the gRPC interface is not UP/Working on the device.	Check the device connectivity to the NCS 1010 node using Ping. Check the Telemetry Connection (gRPC for NCS1010 device) using <code>show grpc</code> and <code>show grpc status</code> on the NCS 1010 node.

