



## Ethernet Cards

---

**Note**

The terms “Unidirectional Path Switched Ring” and “UPSR” may appear in Cisco literature. These terms do not refer to using Cisco ONS 15xxx products in a unidirectional path switched ring configuration. Rather, these terms, as well as “Path Protected Mesh Network” and “PPMN,” refer generally to Cisco’s path protection feature, which may be used in any topological network configuration. Cisco does not recommend using its path protection feature in any particular topological network configuration.

The Cisco ONS 15454 integrates Ethernet into a SONET platform through the use of Ethernet cards. This chapter describes the E-Series, G-Series, and ML-Series Ethernet cards. For installation and card turn-up procedures, refer to the *Cisco ONS 15454 Procedure Guide*. For ML-Series configuration information, see the *Ethernet Card Software Feature and Configuration Guide for the ONS 15454 SDH, ONS 15454, and ONS 15327*.

Chapter topics include:

- [5.1 Ethernet Card Overview, page 5-1](#)
- [5.2 E100T-12 Card, page 5-3](#)
- [5.3 E100T-G Card, page 5-5](#)
- [5.4 E1000-2 Card, page 5-7](#)
- [5.5 E1000-2-G Card, page 5-10](#)
- [5.6 G1000-4 Card, page 5-12](#)
- [5.7 G1K-4 Card, page 5-15](#)
- [5.8 ML100T-12 Card, page 5-18](#)
- [5.9 ML1000-2 Card, page 5-20](#)
- [5.10 CE-100T-8 Card, page 5-22](#)
- [5.11 GBICS and SFPs, page 5-25](#)

### 5.1 Ethernet Card Overview

The card overview section lists the Ethernet cards and their overall functions and gives their software compatibility.

**Note**

Each card is marked with a symbol that corresponds to a slot (or slots) on the ONS 15454 shelf assembly. The cards are then installed into slots displaying the same symbols. Refer to the *Cisco ONS 15454 Procedure Guide* for a list of slots and symbols.

## 5.1.1 Ethernet Cards

Table 5-1 lists the Cisco ONS 15454 Ethernet cards.

**Table 5-1 Ethernet Cards for the ONS 15454**

Card	Port Description	For Additional Information...
E100T-12	The E100T-12 card provides 12 switched, autosensing, 10/100BaseT Ethernet ports.	See the “5.2 E100T-12 Card” section on page 5-3.
E100T-G	The E100T-G card provides 12 switched, autosensing, 10/100BaseT Ethernet ports and is compatible with the XC10G card.	See the “5.3 E100T-G Card” section on page 5-5.
E1000-2	The E1000-2 card provides two IEEE-compliant, 1000-Mbps ports. Gigabit Interface Converters (GBICs) are separate.	See the “5.4 E1000-2 Card” section on page 5-7.
E1000-2-G	The E1000-2-G card provides two IEEE-compliant, 1000-Mbps ports. GBICs are separate. The E1000-2-G card is compatible with the XC10G card.	See the “5.5 E1000-2-G Card” section on page 5-10.
G1000-4	The G1000-4 card provides four IEEE-compliant, 1000-Mbps ports. GBICs are separate. The G1000-4 requires the XC10G card.	See the “5.6 G1000-4 Card” section on page 5-12.
G1K-4	The G1K-4 card provides four IEEE-compliant, 1000-Mbps ports. GBICs are separate. The G1K-4 card is functionally identical to the G1000-4 card, but can operate with XC, XCVT, or XC10G cross-connect cards.	See the “5.7 G1K-4 Card” section on page 5-15.
ML100T-12	The ML100T-12 card provides 12 switched, autosensing, 10/100Base-T Ethernet ports.	See the “5.8 ML100T-12 Card” section on page 5-18.
ML1000-2	The ML1000-2 card provides two IEEE-compliant, 1000-Mbps ports. Small form-factor pluggable (SFP) connectors are separate.	See the “5.9 ML1000-2 Card” section on page 5-20.
CE-100T-8	The CE-100T-8 card provides eight IEEE-compliant, 10/100-Mbps ports. The CE-100T-8 can operate with the XC10G or XCVT cross-connect cards.	See the “5.10 CE-100T-8 Card” section on page 5-22.

## 5.1.2 Card Compatibility

Table 5-2 lists the CTC software compatibility for each Ethernet card. See Table 2-6 on page 2-5 to determine Ethernet card cross-connect compatibility.

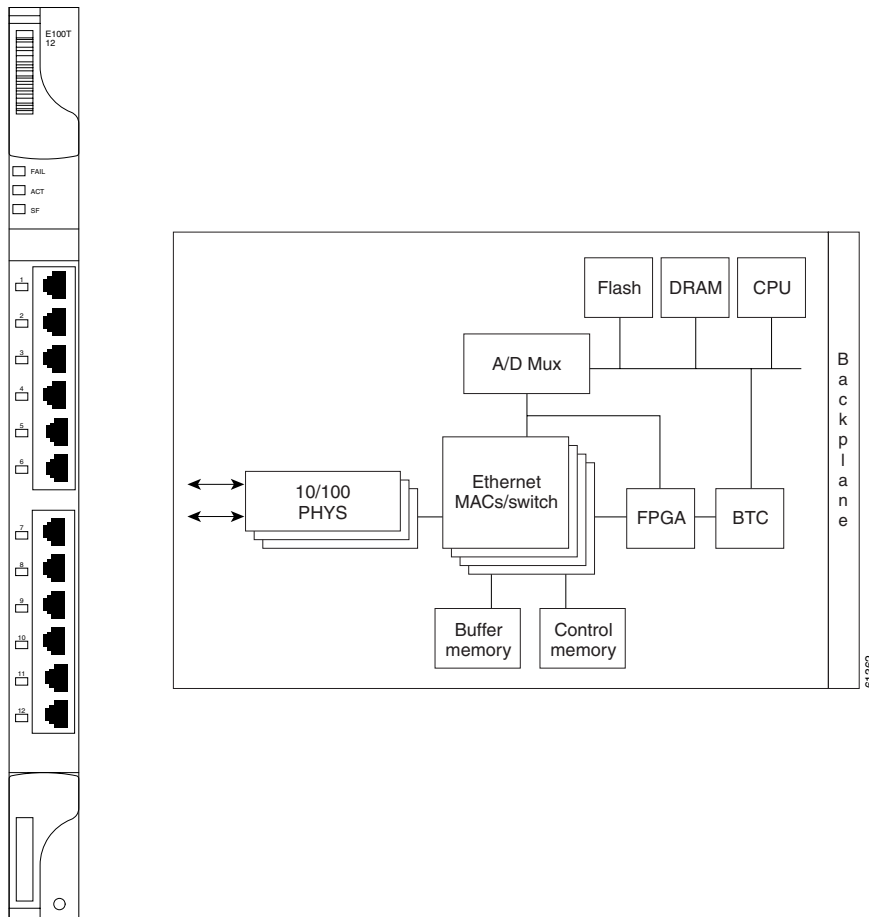
Table 5-2 Ethernet Card Software Compatibility

Ethernet Cards	R2.2.1	R2.2.2	R3.0.1	R3.1	R3.2	R3.3	R3.4	R4.0	R4.1	R4.5	R4.6	R4.7	R5.0
E100T-12	Yes	Yes	Yes	Yes	Yes	Yes	Yes	Yes	Yes	—	Yes	—	Yes
E1000-2	Yes	Yes	Yes	Yes	Yes	Yes	Yes	Yes	Yes	—	Yes	—	Yes
E100T-G	Yes	Yes	Yes	Yes	Yes	Yes	Yes	Yes	Yes	—	Yes	—	Yes
E1000-2-G	Yes	Yes	Yes	Yes	Yes	Yes	Yes	Yes	Yes	—	Yes	—	Yes
G1000-4	—	—	—	—	Yes	Yes	Yes	Yes	Yes	—	Yes	—	Yes
G1K-4	—	—	—	—	Yes	Yes	Yes	Yes	Yes	—	Yes	—	Yes
ML100T-12	—	—	—	—	—	—	—	Yes	Yes	—	Yes	—	Yes
ML1000-2	—	—	—	—	—	—	—	Yes	Yes	—	Yes	—	Yes
CE-100T-8	—	—	—	—	—	—	—	—	—	—	—	—	Yes

## 5.2 E100T-12 Card

The ONS 15454 uses E100T-12 cards for Ethernet (10 Mbps) and Fast Ethernet (100 Mbps). Each card provides 12 switched, IEEE 802.3-compliant, 10/100BaseT Ethernet ports that can independently detect the speed of an attached device (autosense) and automatically connect at the appropriate speed. The ports autoconfigure to operate at either half or full duplex and determine whether to enable or disable flow control. You can also configure Ethernet ports manually. [Figure 5-1](#) shows the faceplate and a block diagram of the card.

**Figure 5-1 E100T-12 Faceplate and Block Diagram**



The E100T-12 Ethernet card provides high-throughput, low-latency packet switching of Ethernet traffic across a SONET network while providing a greater degree of reliability through SONET self-healing protection services. This Ethernet capability enables network operators to provide multiple 10/100-Mbps access drops for high-capacity customer LAN interconnects, Internet traffic, and cable modem traffic aggregation. It enables the efficient transport and co-existence of traditional time-division multiplexing (TDM) traffic with packet-switched data traffic.

Each E100T-12 card supports standards-based, wire-speed, Layer 2 Ethernet switching between its Ethernet interfaces. The IEEE 802.1Q tag logically isolates traffic (typically subscribers). IEEE 802.1Q also supports multiple classes of service.

## 5.2.1 Slot Compatibility

You can install the E100T-12 card in Slots 1 to 6 and 12 to 17. Multiple E-Series Ethernet cards installed in an ONS 15454 can act independently or as a single Ethernet switch. You can create logical SONET ports by provisioning STS channels to the packet switch entity within the ONS 15454. Logical ports can be created with a bandwidth granularity of STS-1. The E100T-12 supports STS-1, STS-3c, STS-6c, and STS-12c circuit sizes.

**Note**

When making an STS-12c Ethernet circuit, the E-Series cards must be configured as single-card EtherSwitch.

## 5.2.2 E100T-12 Card-Level Indicators

The E100T-12 card faceplate has two card-level LED indicators, described in [Table 5-3](#).

**Table 5-3** *E100T-12 Card-Level Indicators*

Card-Level Indicators	Description
Red Fail LED	The red FAIL LED indicates that the card's processor is not ready or that a catastrophic software failure occurred on the E100T-12 card. As part of the boot sequence, the FAIL LED is on until the software deems the card operational.
Green ACT LED	A green ACT LED provides the operational status of the E100T-12. If the ACT LED is green, it indicates that the E100T-12 card is active and the software is operational.
SF LED	Not used.

## 5.2.3 E100T-12 Port-Level Indicators

The E100T-12 card has 12 pairs of LEDs (one pair for each port) to indicate port conditions. [Table 5-4](#) lists the port-level indicators. You can find the status of the E100T-12 card port using the LCD on the ONS 15454 fan-tray assembly. Use the LCD to view the status of any port or card slot; the screen displays the number and severity of alarms for a given port or slot.

**Table 5-4** *E100T-12 Port-Level Indicators*

LED State	Description
Amber	The port is active (transmitting and receiving data).
Solid green	The link is established.
Off	The connection is inactive, or traffic is unidirectional.

## 5.2.4 Cross-Connect Compatibility

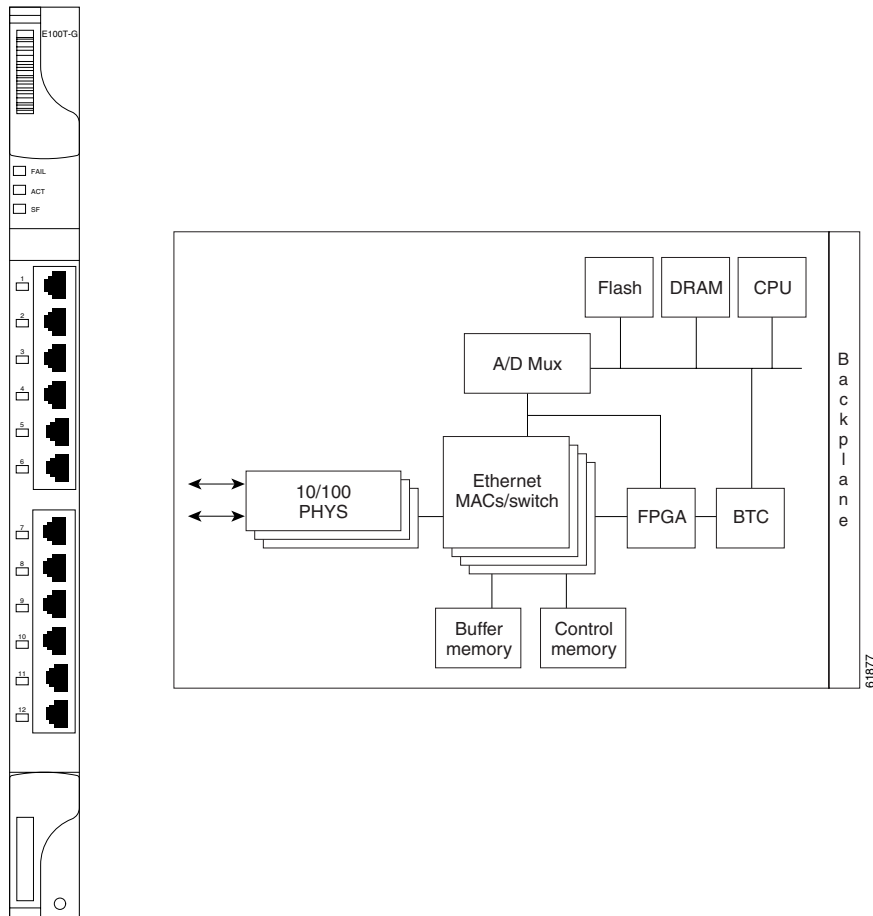
The E100T-12 card is compatible with the XCVT card. Do not use the E100T-12 card with the XC10G card.

## 5.3 E100T-G Card

Use the E100T-G card when the XC10G card is in use. The ONS 15454 uses E100T-G cards for Ethernet (10 Mbps) and Fast Ethernet (100 Mbps). Each card provides 12 switched, IEEE 802.3-compliant, 10/100BaseT Ethernet ports that can independently detect the speed of an attached device (autosense)

and automatically connect at the appropriate speed. The ports autoconfigure to operate at either half or full duplex and determine whether to enable or disable flow control. You can also configure Ethernet ports manually. Figure 5-2 shows the faceplate and a block diagram of the card.

**Figure 5-2** E100T-G Faceplate and Block Diagram



The E100T-G Ethernet card provides high-throughput, low-latency packet switching of Ethernet traffic across a SONET network while providing a greater degree of reliability through SONET self-healing protection services. This Ethernet capability enables network operators to provide multiple 10/100 Mbps access drops for high-capacity customer LAN interconnects, Internet traffic, and cable modem traffic aggregation. It enables the efficient transport and co-existence of traditional TDM traffic with packet-switched data traffic.

Each E100T-G card supports standards-based, wire-speed, Layer 2 Ethernet switching between its Ethernet interfaces. The IEEE 802.1Q tag logically isolates traffic (typically subscribers). IEEE 802.1Q also supports multiple classes of service.



**Note**

When making an STS-12c Ethernet circuit, the E-Series cards must be configured as single-card EtherSwitch.

### 5.3.1 Slot Compatibility

You can install the E100T-G card in Slots 1 to 6 and 12 to 17. Multiple E-Series Ethernet cards installed in an ONS 15454 can act independently or as a single Ethernet switch. You can create logical SONET ports by provisioning a number of STS channels to the packet switch entity within the ONS 15454. Logical ports can be created with a bandwidth granularity of STS-1. The ONS 15454 supports STS-1, STS-3c, STS-6c, or STS-12c circuit sizes.

### 5.3.2 E100T-G Card-Level Indicators

The E100T-G card faceplate has two card-level LED indicators, described in [Table 5-5](#).

**Table 5-5** E100T-G Card-Level Indicators

Card-Level Indicators	Description
<b>Red FAIL LED</b>	The red FAIL LED indicates that the card's processor is not ready or that a catastrophic software failure occurred on the E100T-G card. As part of the boot sequence, the FAIL LED is turned on until the software deems the card operational.
<b>Green ACT LED</b>	A green ACT LED provides the operational status of the E100T-G. If the ACT LED is green it indicates that the E100T-G card is active and the software is operational.
<b>SF LED</b>	Not used.

### 5.3.3 E100T-G Port-Level Indicators

The E100T-G card has 12 pairs of LEDs (one pair for each port) to indicate port conditions ([Table 5-6](#)). You can find the status of the E100T-G card port using the LCD screen on the ONS 15454 fan-tray assembly. Use the LCD to view the status of any port or card slot; the screen displays the number and severity of alarms for a given port or slot.

**Table 5-6** E100T-G Port-Level Indicators

LED State	Description
<b>Yellow (Active)</b>	Port is active (transmitting or receiving data). By default, indicates the transmitter is active but can be software controlled to indicate link status, duplex status, or receiver active.
<b>Solid Green (Link)</b>	Link is established. By default, indicates the link for this port is up, but can be software controlled to indicate duplex status, operating speed, or collision.

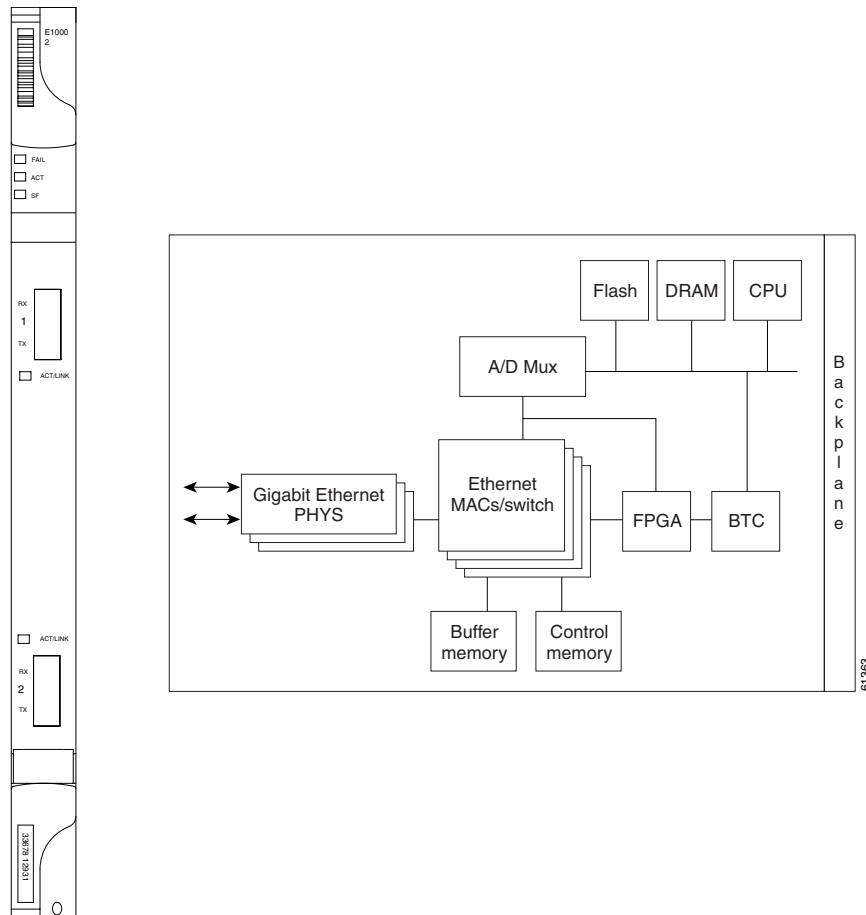
## 5.4 E1000-2 Card

The ONS 15454 uses E1000-2 cards for Gigabit Ethernet (1000 Mbps). The E1000-2 card provides two IEEE-compliant, 1000-Mbps ports for high-capacity customer LAN interconnections. Each port supports full-duplex operation.

The E1000-2 card uses GBIC modular receptacles for the optical interfaces. For details, see the “5.11 GBICS and SFPs” section on page 5-25.

Figure 5-3 shows the card faceplate and a block diagram of the card.

**Figure 5-3 E1000-2 Faceplate and Block Diagram**



The E1000-2 Gigabit Ethernet card provides high-throughput, low-latency packet switching of Ethernet traffic across a SONET network while providing a greater degree of reliability through SONET self-healing protection services. This enables network operators to provide multiple 1000-Mbps access drops for high-capacity customer LAN interconnects. It enables efficient transport and co-existence of traditional TDM traffic with packet-switched data traffic.

Each E1000-2 card supports standards-based, Layer 2 Ethernet switching between its Ethernet interfaces and SONET interfaces on the ONS 15454. The IEEE 802.1Q VLAN tag logically isolates traffic (typically subscribers).

Multiple E-Series Ethernet cards installed in an ONS 15454 can act together as a single switching entity or as independent single switches supporting a variety of SONET port configurations.

You can create logical SONET ports by provisioning STS channels to the packet switch entity within the ONS 15454. Logical ports can be created with a bandwidth granularity of STS-1. The ONS 15454 supports STS-1, STS-3c, STS-6c, or STS-12c circuit sizes.



**Note**

When making an STS-12c circuit, the E-Series cards must be configured as single-card EtherSwitch.

## 5.4.1 Slot Compatibility

You can install the E1000-2 card in Slots 1 to 6 and 12 to 17. The E1000-2 is compatible with the XCVT card but not the XC10G card. The E1000-2-G is compatible with the XC10G.

## 5.4.2 E1000-2 Card-Level Indicators

The E1000-2 card faceplate has two card-level LED indicators, described in [Table 5-7](#).

**Table 5-7** E1000-2 Card-Level Indicators

Card-Level Indicators	Description
Red FAIL LED	The red FAIL LED indicates that the card's processor is not ready or that a catastrophic software failure occurred on the E1000-2 card. As part of the boot sequence, the FAIL LED is turned on until the software deems the card operational.
Green ACT LED	A green ACT LED provides the operational status of the E1000-2. When the ACT LED is green it indicates that the E1000-2 card is active and the software is operational.
SF LED	Not used.

## 5.4.3 E1000-2 Port-Level Indicators

The E1000-2 card has one bicolor LED per port ([Table 5-8](#)). When the LED is solid green, it indicates that carrier is detected, meaning an active network cable is installed. When the LED is off, it indicates that an active network cable is not plugged into the port, or the card is carrying unidirectional traffic. When the LED flashes amber, it does so at a rate proportional to the level of traffic being received and transmitted over the port.

**Table 5-8** E1000-2 Port-Level Indicators

LED State	Description
Amber	The port is active (transmitting and receiving data).
Solid green	The link is established.
Off	The connection is inactive, or traffic is unidirectional.

## 5.4.4 E1000-2 Compatibility

The E1000-2 is compatible with XC or XCVT cross-connect cards. The XC10G requires the E1000-2-G.

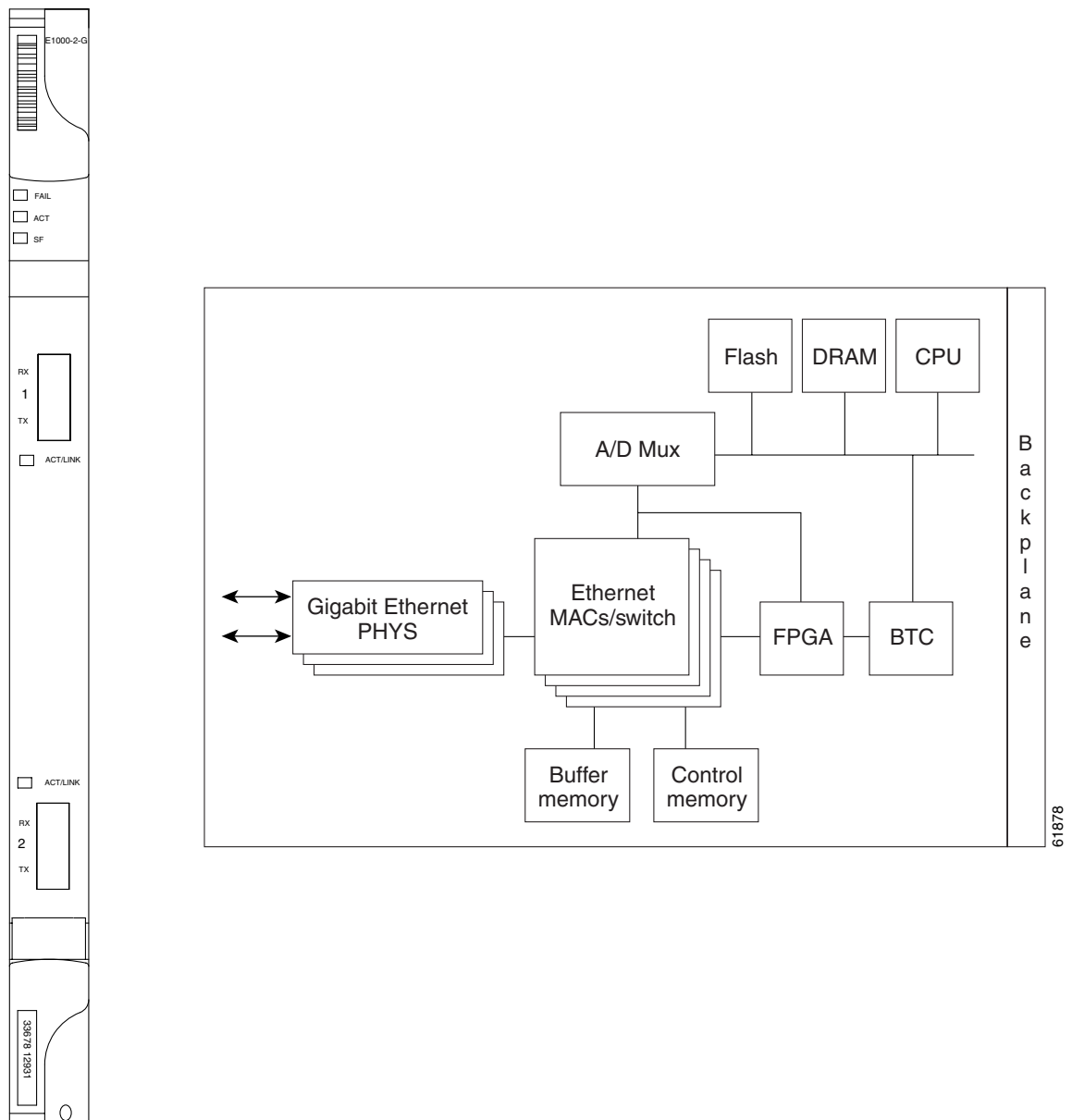
## 5.5 E1000-2-G Card

Use the E1000-2-G with the XC10G card. The ONS 15454 uses E1000-2-G cards for Gigabit Ethernet (1000 Mbps). The E1000-2-G card provides two IEEE-compliant, 1000-Mbps ports for high-capacity customer LAN interconnections. Each port supports full-duplex operation.

The E1000-2-G card uses GBIC modular receptacles for the optical interfaces. For details, see the [“5.11 GBICS and SFPs” section on page 5-25](#).

Figure 5-4 shows the card faceplate and a block diagram of the card.

**Figure 5-4** E1000-2-G Faceplate and Block Diagram



The E1000-2-G Gigabit Ethernet card provides high-throughput, low-latency packet switching of Ethernet traffic across a SONET network while providing a greater degree of reliability through SONET self-healing protection services. This enables network operators to provide multiple 1000-Mbps access drops for high-capacity customer LAN interconnects. It enables efficient transport and co-existence of traditional TDM traffic with packet-switched data traffic.

Each E1000-2-G card supports standards-based, Layer 2 Ethernet switching between its Ethernet interfaces and SONET interfaces on the ONS 15454. The IEEE 802.1Q VLAN tag logically isolates traffic (typically subscribers).

Multiple E-Series Ethernet cards installed in an ONS 15454 can act together as a single switching entity or as independent single switches supporting a variety of SONET port configurations.

You can create logical SONET ports by provisioning STS channels to the packet switch entity within the ONS 15454. Logical ports can be created with a bandwidth granularity of STS-1. The ONS 15454 supports STS-1, STS-3c, STS-6c, or STS-12c circuit sizes.



**Note**

When making an STS-12c Ethernet circuit, the E-Series cards must be configured as a single-card EtherSwitch.

## 5.5.1 Cross-Connect Compatibility

The E1000-2-G is compatible with the XCVT and XC10G cards. You can install the card in Slots 1 to 6 and 12 to 17.

## 5.5.2 E1000-2-G Card-Level Indicators

The E1000-2-G card faceplate has two card-level LED indicators, described in [Table 5-9](#).

**Table 5-9** E1000-2-G Card-Level Indicators

Card-Level Indicators	Description
Red FAIL LED	The red FAIL LED indicates that the card's processor is not ready or that a catastrophic software failure occurred on the E1000-2-G card. As part of the boot sequence, the FAIL LED is turned on until the software deems the card operational.
Green ACT LED	A green ACT LED provides the operational status of the E1000-2-G. If the ACT LED is green it indicates that the E1000-2-G card is active and the software is operational.
SF LED	The SF LED is not used in the current release.

## 5.5.3 E1000-2-G Port-Level Indicators

The E1000-2-G card has one bicolor LED per port ([Table 5-10](#)). When the green LINK LED is on, carrier is detected, meaning an active network cable is installed. When the green LINK LED is off, an active network cable is not plugged into the port, or the card is carrying unidirectional traffic. The amber port ACT LED flashes at a rate proportional to the level of traffic being received and transmitted over the port.

**Table 5-10** E1000-2-G Port-Level Indicators

LED State	Description
Amber	The port is active (transmitting and receiving data).
Solid green	The link is established.
Off	The connection is inactive, or traffic is unidirectional.

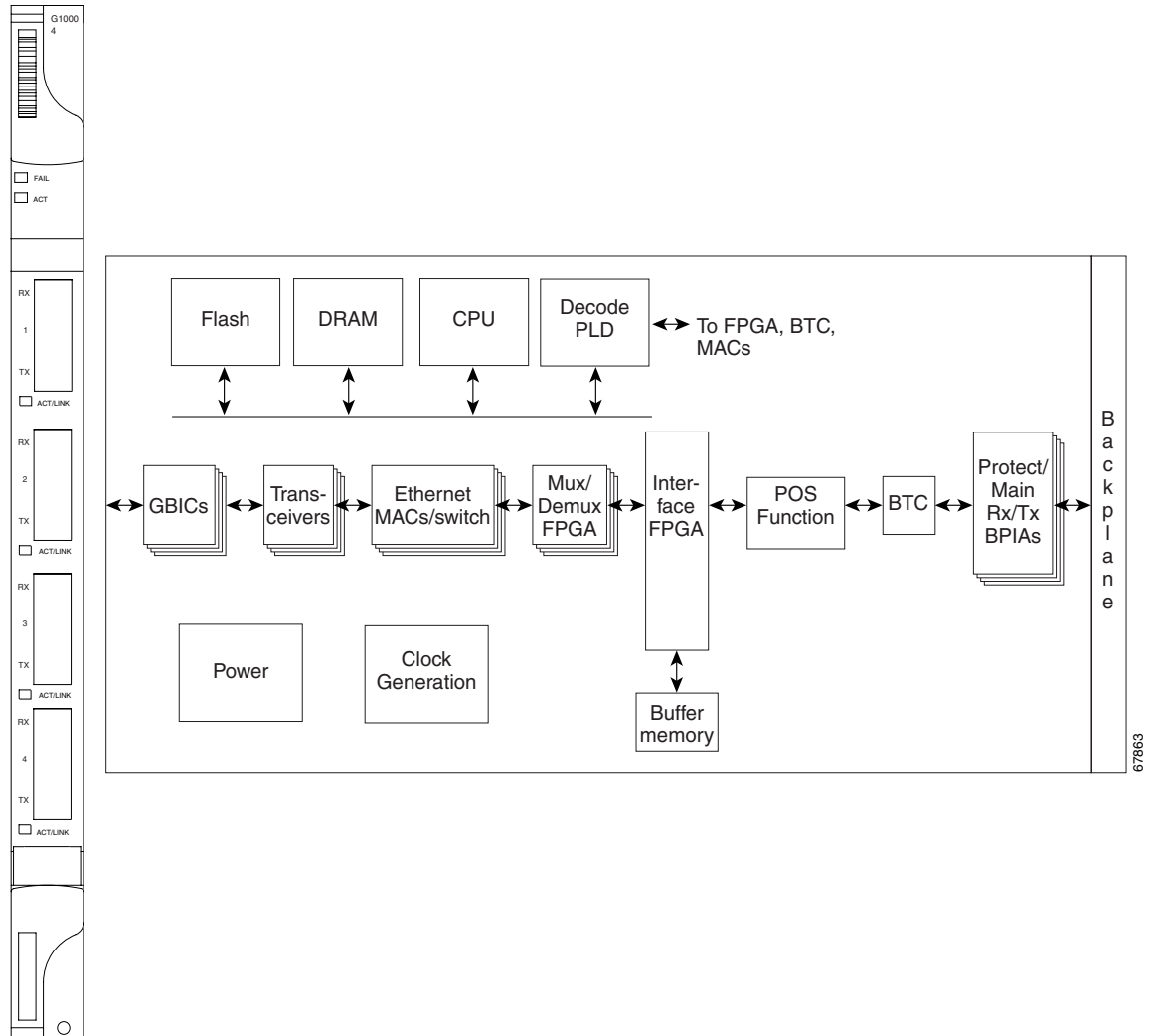
## 5.6 G1000-4 Card

The G1000-4 card requires the XC10G card. The ONS 15454 uses G1000-4 cards for Gigabit Ethernet (1000 Mbps). The G1000-4 card provides four ports of IEEE-compliant, 1000-Mbps interfaces. Each port supports full-duplex operation for a maximum bandwidth of OC-48 on each card.

The G1000-4 card uses GBIC modular receptacles for the optical interfaces. For details, see the [“5.11 GBICS and SFPs”](#) section on page 5-25.

Figure 5-5 shows the card faceplate and the block diagram of the card.

Figure 5-5 G1000-4 Faceplate and Block Diagram



The G1000-4 Gigabit Ethernet card provides high-throughput, low latency transport of Ethernet encapsulated traffic (IP and other Layer 2 or Layer 3 protocols) across a SONET network. Carrier-class Ethernet transport is achieved by hitless (< 50 ms) performance in the event of any failures or protection switches (such as 1+1 automatic protection switching [APS], path protection, or bidirectional line switch ring [BLSR]). Full provisioning support is possible through Cisco Transport Controller (CTC), Transaction Language One (TL1), or Cisco Transport Manager (CTM).

The circuit sizes supported are STS-1, STS-3c, STS-6c, STS-9c, STS-12c, STS-24c, and STS-48c.

## 5.6.1 STS-24c Restriction

Due to hardware constraints, the card imposes an additional restriction on the combinations of circuits that can be dropped onto a G-Series card. These restrictions are transparently enforced by the ONS 15454, and you do not need to keep track of restricted circuit combinations.

When a single STS-24c terminates on a card, the remaining circuits on that card can be another single STS-24c or any combination of circuits of STS-12c size or less that add up to no more than 12 STSs (that is a total of 36 STSs on the card).

If STS-24c circuits are not being dropped on the card, the full 48 STSs bandwidth can be used with no restrictions (for example, using either a single STS-48c or 4 STS-12c circuits).

**Note**

The STS-24c restriction only applies when a single STS-24c circuit is dropped; therefore, you can easily minimize the impact of this restriction. Group the STS-24c circuits together on a card separate from circuits of other sizes. The grouped circuits can be dropped on other G-Series cards on the ONS 15454.

## 5.6.2 G1000-4 Card-Level Indicators

The G1000-4 card faceplate has two card-level LED indicators, described in [Table 5-11](#).

**Table 5-11** G1000-4 Card-Level Indicators

Card-Level LEDs	Description
FAIL LED (red)	The red FAIL LED indicates that the card's processor is not ready or that a catastrophic software failure occurred on the G1000-4 card. As part of the boot sequence, the FAIL LED is turned on, and it turns off if the software is deemed operational.  The red FAIL LED blinks when the card is loading software.
ACT LED (green)	A green ACT LED provides the operational status of the G1000-4. If the ACT LED is green, it indicates that the G1000-4 card is active and the software is operational.

## 5.6.3 G1000-4 Port-Level Indicators

The G1000-4 card has one bicolor LED per port. [Table 5-12](#) describes the status that each color represents.

**Table 5-12** G1000-4 Port-Level Indicators

Port-Level LED Status	Description
Off	No link exists to the Ethernet port.
Steady amber	A link exists to the Ethernet port, but traffic flow is inhibited. For example, an unconfigured circuit, an error on line, or a nonenabled port might inhibit traffic flow.
Solid green	A link exists to the Ethernet port, but no traffic is carried on the port.
Flashing green	A link exists to the Ethernet port, and traffic is carried on the port. The LED flash rate reflects the traffic rate for the port.

## 5.6.4 Slot Compatibility

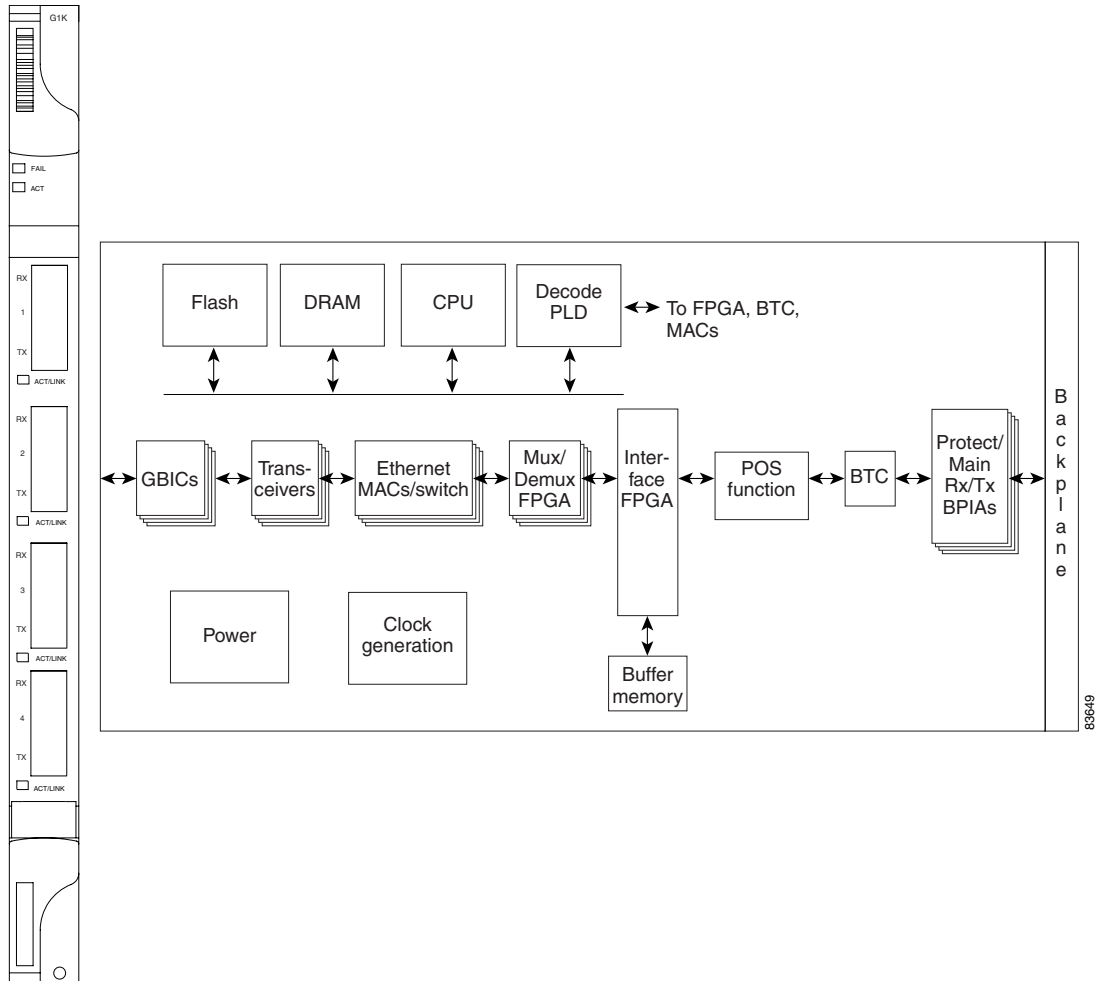
The G1000-4 card requires Cisco ONS 15454 Release 3.2 or later system software and the XC10G cross-connect card. You can install the card in Slots 1 to 6 and 12 to 17, for a total shelf capacity of 48 Gigabit Ethernet ports. The practical G1000-4 port per shelf limit is 40, because at least two slots are typically filled by OC-N trunk cards such as the OC-192.

## 5.7 G1K-4 Card

The G1K-4 card is the functional equivalent of the G1000-4 card and provides four ports of IEEE-compliant, 1000-Mbps interfaces. Each interface supports full-duplex operation for a maximum bandwidth of 1 Gbps or 2 Gbps bidirectional per port, and 2.5 Gbps or 5 Gbps bidirectional per card. Each port autonegotiates for full duplex and IEEE 802.3x flow control. The G1K-4 card uses GBIC modular receptacles for the optical interfaces. For details, see the [“5.11 GBICS and SFPs” section on page 5-25](#).

Figure 5-6 shows the card faceplate and the block diagram of the card.

Figure 5-6 G1K-4 Faceplate and Block Diagram



The G1K-4 Gigabit Ethernet card provides high-throughput, low-latency transport of Ethernet encapsulated traffic (IP and other Layer 2 or Layer 3 protocols) across a SONET network while providing a greater degree of reliability through SONET self-healing protection services. Carrier-class Ethernet transport is achieved by hitless (< 50 ms) performance in the event of any failures or protection switches (such as 1+1 APS, path protection, BLSR, or optical equipment protection) and by full provisioning and manageability, as in SONET service. Full provisioning support is possible through CTC or CTM. Each G1K-4 card performs independently of the other cards in the same shelf.

## 5.7.1 STS-24c Restriction

Due to hardware constraints, the card imposes an additional restriction on the combinations of circuits that can be dropped onto a G-Series card. These restrictions are transparently enforced by the ONS 15454, and you do not need to keep track of restricted circuit combinations.

When a single STS-24c terminates on a card, the remaining circuits on that card can be another single STS-24c or any combination of circuits of STS-12c size or less that add up to no more than 12 STSs (that is a total of 36 STSs on the card).



If STS-24c circuits are not being dropped on the card, the full 48 STSs bandwidth can be used with no restrictions (for example, using either a single STS-48c or 4 STS-12c circuits).

**Note**

The STS-24c restriction only applies when a single STS-24c circuit is dropped; therefore, you can easily minimize the impact of this restriction. Group the STS-24c circuits together on a card separate from circuits of other sizes. The grouped circuits can be dropped on other G-Series cards on the ONS 15454.

## 5.7.2 G1K-4 Compatibility

When installed in ONS 15454s running software prior to Software Release 4.0, the G1K-4 cards require the XC10G card to operate. Software R4.0 and later identifies G1K-4 cards as G1K-4s upon physical installation. Software prior to R4.0 identifies both G1000-4 and G1K-4 cards as G1000-4s upon physical installation.

You can install the G1K-4 card in Slots 1 to 6 and 12 to 17, for a total shelf capacity of 48 Gigabit Ethernet ports. (The practical limit is 40 ports because at least two slots are typically populated by optical cards such as OC-192).

However, when installed on an ONS 15454 running Software R4.0 and later, the G1K-4 card is not limited to installation in ONS 15454s with XC10G cards but can also be installed in ONS 15454s with XC and XCVT cards. When used with XC and XCVT cards on an ONS 15454 running Release 4.0 and later, the G1K-4 is limited to the high-speed slots (Slots 5, 6, 12, and 13).

## 5.7.3 G1K-4 Card-Level Indicators

The G1K-4 card faceplate has two card-level LED indicators, described in [Table 5-13](#).

**Table 5-13** G1K-4 Card-Level Indicators

Card-Level LEDs	Description
FAIL LED (red)	<p>The red FAIL LED indicates that the card's processor is not ready or that a catastrophic software failure occurred on the G1K-4 card. As part of the boot sequence, the FAIL LED is turned on, and it goes off when the software is deemed operational.</p> <p>The red FAIL LED blinks when the card is loading software.</p>
ACT LED (green)	<p>A green ACT LED provides the operational status of the G1K-4. If the ACT LED is green, it indicates that the G1K-4 card is active and the software is operational.</p>

## 5.7.4 G1K-4 Port-Level Indicators

The G1K-4 card has four bicolor LEDs (one LED per port). [Table 5-14](#) describes the status that each color represents.

**Table 5-14 G1K-4 Port-Level Indicators**

Port-Level LED Status	Description
Off	No link exists to the Ethernet port.
Steady amber	A link exists to the Ethernet port, but traffic flow is inhibited. For example, a lack of circuit setup, an error on the line, or a nonenabled port might inhibit traffic flow.
Solid green	A link exists to the Ethernet port, but no traffic is carried on the port.
Flashing green	A link exists to the Ethernet port, and traffic is carried on the port. The LED flash rate reflects the traffic rate for the port.

## 5.8 ML100T-12 Card

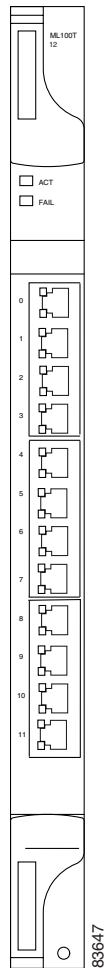
The ML100T-12 card provides 12 ports of IEEE 802.3-compliant, 10/100 interfaces. Each interface supports full-duplex operation for a maximum bandwidth of 200 Mbps per port and 2.488 Gbps per card. Each port independently detects the speed of an attached device (autosenses) and automatically connects at the appropriate speed. The ports autoconfigure to operate at either half or full duplex and can determine whether to enable or disable flow control. For ML-Series configuration information, see the *Ethernet Card Software Feature and Configuration Guide for the ONS 15454 SDH, ONS 15454, and ONS 15327*.

Figure 5-7 shows the card faceplate.



### Caution

Shielded twisted-pair cabling should be used for inter-building applications.

**Figure 5-7 ML100T-12 Faceplate**

The card features two virtual packet over SONET (POS) ports with a maximum combined bandwidth of STS-48. The ports function in a manner similar to OC-N card ports, and each port carries an STS circuit with a size of STS-1, STS-3c, STS-6c, STS-9c, STS-12c, or STS-24c. For step-by-step instructions on configuring an ML-Series card SONET STS circuit, refer to the “Create Circuits and VT Tunnels” chapter of the *Cisco ONS 15454 Procedure Guide*.

The ML-Series POS ports supports virtual concatenation (VCAT) of SONET circuits and a software link capacity adjustment scheme (SW-LCAS). The ML-Series card supports a maximum of two VCAT groups with each group corresponding to one of the POS ports. Each VCAT group must be provisioned with two circuit members. An ML-Series card supports STS-1c-2v, STS-3c-2v and STS-12c-2v. For step-by-step instructions on configuring an ML-Series card SONET VCAT circuit, refer to the “Create Circuits and VT Tunnels” chapter of the *Cisco ONS 15454 Procedure Guide*.

## 5.8.1 ML100T-12 Card-Level Indicators

The ML00T-12 card supports two card-level LED indicators. The card-level indicators are described in [Table 5-15](#).

**Table 5-15 ML100T-12 Card-Level Indicators**

Card-Level LEDs	Description
Red FAIL LED	The red FAIL LED indicates that the card's processor is not ready or that a catastrophic software failure occurred on the ML100T-12 card. As part of the boot sequence, the FAIL LED is turned on until the software deems the card operational.
Green ACT LED	A green ACT LED provides the operational status of the ML100T-12. If the ACT LED is green, it indicates that the ML100T-12 card is active and the software is operational.

## 5.8.2 ML100T-12 Port-Level Indicators

The ML100T-12 card provides a pair of LEDs for each Fast Ethernet port: an amber LED for activity (ACT) and a green LED for LINK. The port-level indicators are described in [Table 5-16](#).

**Table 5-16 ML100T-12 Port-Level Indicators**

Port-Level Indicators	Description
ACT LED (Amber)	A steady amber LED indicates a link is detected, but there is an issue inhibiting traffic. A blinking amber LED means traffic is flowing.
LINK LED (Green)	A steady green LED indicates that a link is detected, but there is no traffic. A blinking green LED flashes at a rate proportional to the level of traffic being received and transmitted over the port.
Both ACT and LINK LED	Unlit green and amber LEDs indicate no traffic.

## 5.8.3 Cross-Connect and Slot Compatibility

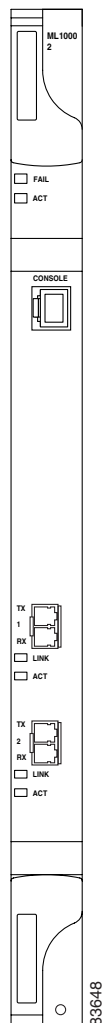
The ML100T-12 card works in Slots 1 to 6 or 12 to 17 with the XC10G cross-connect card. It works only in high-speed slots (Slots 5, 6, 12, or 13) with the XC or XCVT cross-connect card.

## 5.9 ML1000-2 Card

The ML1000-2 card provides two ports of IEEE-compliant, 1000-Mbps interfaces. Each interface supports full-duplex operation for a maximum bandwidth of 2 Gbps per port and 4 Gbps per card. Each port autoconfigures for full duplex and IEEE 802.3x flow control.

SFP modules are offered as separate orderable products for maximum customer flexibility. For details, see the [“5.11 GBICS and SFPs”](#) section on page 5-25.

[Figure 5-8](#) shows the ML1000-2 card faceplate.

**Figure 5-8 ML1000-2 Faceplate**

The card features two virtual packet over SONET (POS) ports with a maximum combined bandwidth of STS-48. The ports function in a manner similar to OC-N card ports, and each port carries an STS circuit with a size of STS-1, STS-3c, STS-6c, STS-9c, STS-12c, or STS-24c. For step-by-step instructions on configuring an ML-Series card SONET STS circuit, refer to the “Create Circuits and VT Tunnels” chapter of the *Cisco ONS 15454 Procedure Guide*.

The ML-Series POS ports supports VCAT of SONET circuits and a software link capacity adjustment scheme (SW-LCAS). The ML-Series card supports a maximum of two VCAT groups with each group corresponding to one of the POS ports. Each VCAT group must be provisioned with two circuit members. An ML-Series card supports STS-1c-2v, STS-3c-2v and STS-12c-2v. For step-by-step instructions on configuring an ML-Series card SONET VCAT circuit, refer to the “Create Circuits and VT Tunnels” chapter of the *Cisco ONS 15454 Procedure Guide*.

## 5.9.1 ML1000-2 Card-Level Indicators

The ML1000-2 card faceplate has two card-level LED indicators, described in [Table 5-17](#).

**Table 5-17 ML1000-2 Card-Level Indicators**

Card-Level LEDs	Description
SF LED (Red)	The red FAIL LED indicates that the card's processor is not ready or that a catastrophic software failure occurred on the ML1000-2 card. As part of the boot sequence, the FAIL LED is turned on until the software deems the card operational.
ACT LED (Green)	A green ACT LED provides the operational status of the ML1000-2. When the ACT LED is green, it indicates that the ML1000-2 card is active and the software is operational.

## 5.9.2 ML1000-2 Port-Level Indicators

The ML1000-2 card has three LEDs for each of the two Gigabit Ethernet ports, described in [Table 5-17](#).

**Table 5-18 ML1000-2 Port-Level Indicators**

Port-Level Indicators	Description
ACT LED (Amber)	A steady amber LED indicates a link is detected, but there is an issue inhibiting traffic. A blinking amber LED means traffic flowing.
LINK LED (Green)	A steady green LED indicates that a link is detected, but there is no traffic. A blinking green LED flashes at a rate proportional to the level of traffic being received and transmitted over the port.
Both ACT and LINK LED	Unlit green and amber LEDs indicate no traffic.

## 5.9.3 Cross-Connect and Slot Compatibility

The ML1000-2 card works in Slots 1 to 6 or 12 to 17 with the XC10G cross-connect card. It works only in high-speed slots (Slots 5, 6, 12, or 13) with the XC or XCVT cross-connect card.

## 5.10 CE-100T-8 Card

The CE-100T-8 card provides mapping of 10/100 Mbps Ethernet traffic into SONET STS-12 payloads, making use of low order (VT1.5) virtual concatenation, high order (STS-1) virtual concatenation, GFP-Mapped Ethernet, and Ethernet over HDLC (LEX). It also supports the link capacity adjustment scheme (LCAS), which allows hitless dynamic adjustment of SONET link bandwidth. The CE-100T-8 card provides eight RJ-45 10/100 Mbps Ethernet ports on the faceplate of the card. An inactive RJ-45 console port is also on the faceplate.

The circuit types supported are:

- HO-CCAT
- LO-VCAT with no HW-LCAS
- LO-VCAT with HW-LCAS
- HO-VCAT with no HW-LCAS
- HO-VCAT with HW-LCAS

- STS-1-2v SW-LCAS with ML only.

Each 10/100 Ethernet port can be mapped to a SONET channel in increments of VT1.5 or STS-1 granularity, allowing an efficient transport of Ethernet and IP over the SONET infrastructure.

Figure 5-9 shows the CE-100T-8 card faceplate.

**Figure 5-9 CE-100T-8 Faceplate**

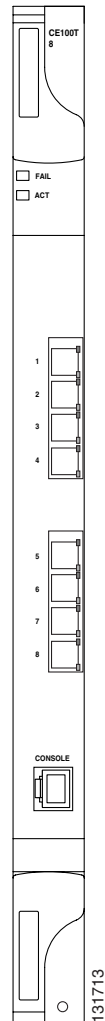
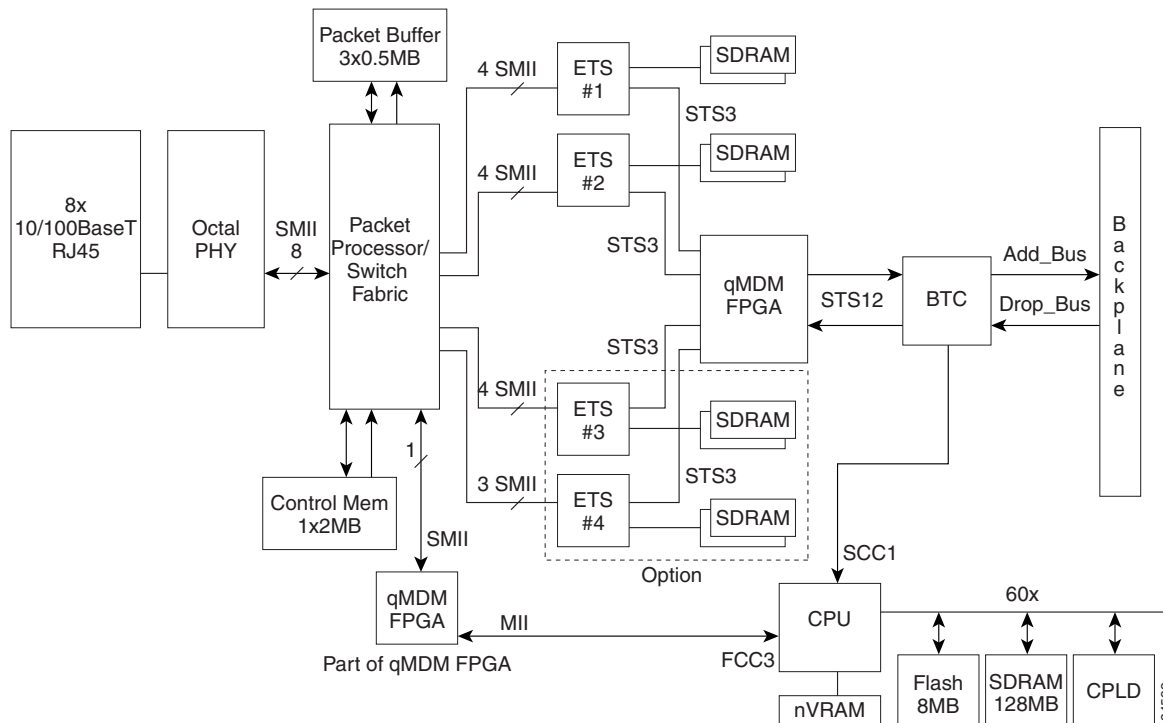


Figure 5-10 shows the CE-100T-8 card functional block diagram. The following paragraphs describe the general functions of the CE-100T-8 card and relate to the block diagram.

In the ingress direction, (Ethernet-to-SONET), the PHY, which performs all of the physical layer interface functions for 10/100 Mbps Ethernet, sends the frame to the network processor for queuing in the respective packet buffer memory. The network processor performs packet processing, packet switching, and classification. The Ethernet frames are then passed to the Ethermap where Ethernet traffic is terminated and is encapsulated using HDLC or GFP framing on a per port basis. The encapsulated Ethernet frames are then mapped into a configurable number of virtual concatenated low- or high-order payloads, such as VT1.5 synchronous payload envelope (SPE), STS-1 SPE, or a contiguous concatenated payload such as STS-3c SPE. Up to 64 VT1.5 SPEs or 3 STS-1 SPEs can be virtually

concatenated. The SONET SPE carrying encapsulated Ethernet frames are passed onto the qMDM FPGA, where four STS-3 frames are multiplexed to form a STS-12 frame for transport over the SONET network by means of the Bridging Convergence Transmission (BTC) ASIC.

**Figure 5-10 CE-100T-8 Block Diagram**



In the Egress direction (SONET-to-Ethernet), the FPGA extracts four STS-3 SPEs from the STS-12 frame it receives from the BTC and sends each of the STS-3s to the ET3 mappers. The STS-3 SONET SPE carrying GFP or PPP/HDLC encapsulated Ethernet frames is then extracted and buffered in Ethermap's external memory. This memory is used for providing alignment and differential delay compensation for the received low-order and high-order virtual concatenated payloads. After alignment and delay compensation have been done, the Ethernet frames are decapsulated with one of the framing protocols (GFP or HDLC). Decapsulated Ethernet frames are then passed onto the network processor for QoS queuing and traffic scheduling. The network processor switches the frame to one of the corresponding PHY channels and then to the Ethernet port for transmission to the external client(s).

For information on the CE-100T-8 QoS features, see the "CE-100T-8 Operations" chapter of the *Ethernet Card Software Feature and Configuration Guide for the ONS 15454 SDH, ONS 15454, and ONS 15327*.

## 5.10.1 CE-100T-8 Card-Level Indicators

The CE-100T-8 card faceplate has two card-level LED indicators, described in [Table 5-19](#).



**Table 5-19** CE-100T-8 Card-Level Indicators

Card-Level LEDs	Description
SF LED (Red)	The red FAIL LED indicates that the card's processor is not ready or that a catastrophic software failure occurred on the CE-100T-8 card. As part of the boot sequence, the FAIL LED is turned on until the software deems the card operational.
ACT LED (Green)	A green ACT LED provides the operational status of the CE-100T-8. When the ACT LED is green, it indicates that the CE-100T-8 card is active and the software is operational.

## 5.10.2 CE-100T-8 Port-Level Indicators

The CE-100T-8 card has two LEDs embedded into each of the eight Ethernet port RJ-45 connectors. The LEDs are described in [Table 5-20](#).

**Table 5-20** CE-100T-8 Port-Level Indicators

Port-Level Indicators	Description
ACT LED (Amber)	A blinking amber LED flashes at a rate proportional to the level of traffic being received and transmitted over the port.
LINK LED (Green)	A steady green LED indicates that a link is detected.
Both ACT and LINK LED OFF	Unlit green and amber LEDs indicate no traffic and link.

## 5.10.3 Cross-Connect and Slot Compatibility

The CE-100T-8 card works in Slots 1 to 6 or 12 to 17 with the XC10G or XCVT cross-connect cards.

# 5.11 GBICS and SFPs

This section describes the GBICs and SFPs used with the Ethernet cards.

The ONS 15454 Ethernet cards use industry standard small form-factor pluggable connectors (SFPs) and Gigabit Interface Converter (GBIC) modular receptacles. The ML-Series Gigabit Ethernet cards use standard Cisco SFPs. The Gigabit E-Series card and the G-Series card use standard Cisco GBICs. With Software Release 4.1 and later, G-Series cards can also be equipped with dense wavelength division multiplexing (DWDM) and coarse wavelength division multiplexing (CWDM) GBICs to function as Gigabit Ethernet transponders.

For all Ethernet cards, the type of GBIC or SFP plugged into the card is displayed in CTC and TL1. Cisco offers SFPs and GBICs as separate orderable products.

## 5.11.1 Compatibility by Card

[Table 5-21](#) lists Cisco ONS 15454 Ethernet cards with their compatible GBICs and SFPs.

**Caution**

Only use GBICs and SFPs certified for use in Cisco Optical Networking Systems. The qualified Cisco GBIC and SFP pluggable module's top assembly numbers (TANs) are provided in [Table 5-21](#).

[Table 5-21](#) lists Cisco ONS 15454 SONET cards with their compatible GBICs and SFPs.

**Table 5-21 GBIC and SFP Card Compatibility**

Card	Compatible GBIC or SFP (Cisco Product ID)	Cisco Top Assembly Number (TAN)
E1000-2-G (ONS 15454 SONET) E1000-2 (ONS 15454 SONET/SDH)	15454-GBIC-SX 15454E-GBIC-SX 15454-GBIC-LX/LH 15454E-GBIC-LX/LH	30-0759-01 800-06780-01 <sup>1</sup> 10-1743-01 30-0703-01
FC-MR-4 (ONS 15454 SONET/SDH)	15454-GBIC-SX 15454E-GBIC-SX 15454-GBIC-LX/LH 15454E-GBIC-LX/LH ONS-GX-2FC-MMI ONS-GX-2FC-SML	30-0759-01 800-06780-01 10-1743-01 30-0703-01 10-2015-01 10-2016-01
G1K-4 (ONS 15454 SONET/SDH) G1000-4 (ONS 15454 SONET/SDH)	15454-GBIC-SX 15454E-GBIC-SX 15454-GBIC-LX/LH 15454E-GBIC-LX/LH 15454-GBIC-ZX 15454E-GBIC-ZX 15454-GBIC-xx.x <sup>2</sup> 15454E-GBIC-xx.x <sup>2</sup> 15454-GBIC-xxxx <sup>3</sup> 15454E-GBIC-xxxx <sup>3</sup>	30-0759-01 800-06780-01 10-1743-01 30-0703-01 30-0848-01 10-1744-01 10-1845-01 through 10-1876-01 10-1845-01 through 10-1876-01 10-1453-01 through 10-1460-01 10-1453-01 through 10-1460-01
ML1000-2 (ONS 15454 SONET/SDH)	15454-SFP-LC-SX 15454E-SFP-LC-SX 15454-SFP-LC-LX/LH 15454E-SFP-LC-LX/LH	30-1301-01 30-1301-01 30-1299-01 30-1299-01

1. This TAN is only compatible with ONS 15454-E1000-2 or 15454-E1000-2-G cards.
2. xx.x defines the 32 possible wavelengths.
3. xxxx defines the 8 possible wavelengths as shown in [Table 5-22 on page 5-28](#).

## 5.11.2 GBIC Description

GBICs are integrated fiber optic transceivers that provide high speed serial links from a port or slot to the network. Various latching mechanisms can be utilized on the GBIC pluggable modules. There is no correlation between the type of latch to the model type (such as SX or LX/LH) or technology type (such as Gigabit Ethernet). See the label on the GBIC for technology type and model. One GBIC model has two clips (one on each side of the GBIC) that secure the GBIC in the slot on the Ethernet card; the other has a locking handle. Both types are shown in [Figure 5-11](#).

GBIC dimensions are:

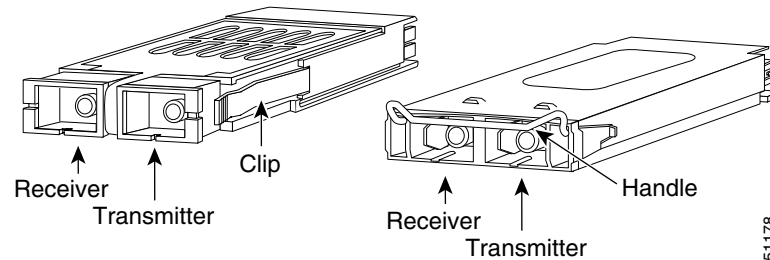
- Height 0.39 in. (1 cm)

- Width 1.18 in. (3 cm)
- Depth 2.56 in. (6.5 cm)

GBIC temperature ranges are:

- COM—commercial operating temperature range -5°C to 70°C
- EXT—extended operating temperature range 0°C to 85°C
- IND—industrial operating temperature range -40°C to 85°C

**Figure 5-11 GBICs with Clips (left) and with a Handle (right)**



### 5.11.3 G-Series DWDM and CWDM GBICs

DWDM (15454-GBIC-xx.x, 15454E-GBIC-xx.x) and CWDM (15454-GBIC-xxxx, 15454E-GBIC-xxxx) GBICs operate in the ONS 15454 G-Series card when the card is configured in Gigabit Ethernet Transponding mode or in Ethernet over SONET mode. DWDM and CWDM GBICs are both wavelength division multiplexing (WDM) technologies and operate over single-mode fibers with SC connectors. Cisco CWDM GBIC technology uses a 20 nm wavelength grid and Cisco ONS 15454 DWDM GBIC technology uses a 1 nm wavelength grid. CTC displays the specific wavelengths of the installed CWDM or DWDM GBICs. DWDM wavelengths are spaced closer together and require more precise lasers than CWDM. The DWDM spectrum allows for optical signal amplification. For more information on G-Series card transponding mode, see the *Ethernet Card Software Feature and Configuration Guide for the ONS 15454 SDH, ONS 15454, and ONS 15327*.

The DWDM and CWDM GBICs receive across the full 1300 nm and 1500 nm bands, which includes all CWDM, DWDM, LX/LH, ZX wavelengths, but transmit on one specified wavelength. This capability can be exploited in some of the G-Series transponding modes by receiving wavelengths that do not match the specific transmission wavelength.



#### Note

G1000-4 cards support CWDM and DWDM GBICs. G1K-4 cards with the Common Language Equipment Identification (CLEI) code of WM5IRWPCAA (manufactured after August 2003) support CWDM and DWDM GBICs. G1K-4 cards manufactured prior to August 2003 do not support CWDM or DWDM GBICs.

The ONS 15454-supported CWDM GBICs reach up to 100 to 120 km over single-mode fiber and support eight wavelengths as shown in [Table 5-22](#).

**Table 5-22 Supported Wavelengths for CWDM GBICs**

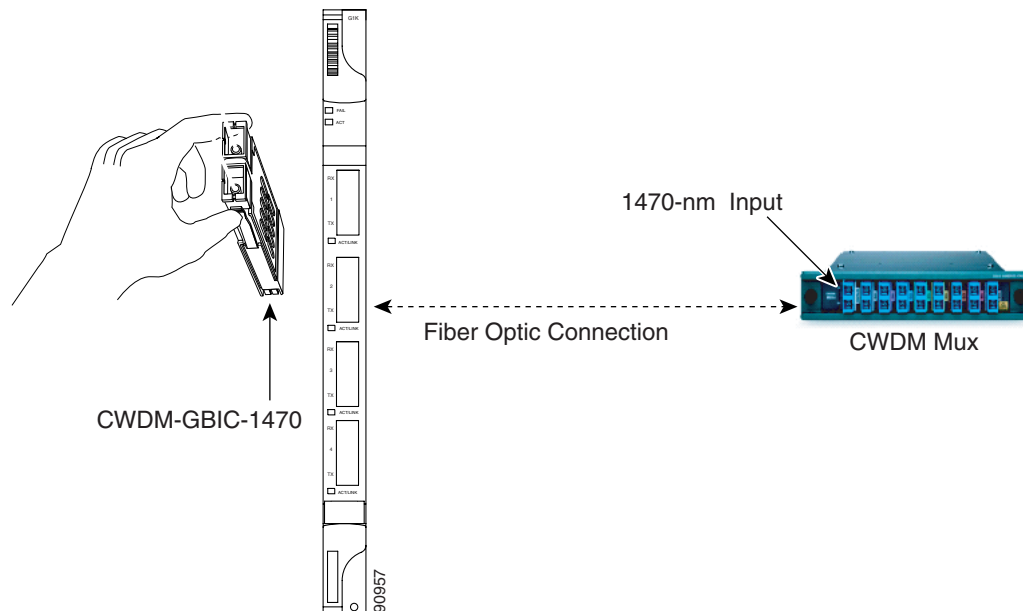
CWDM GBIC Wavelengths	1470 nm	1490 nm	1510 nm	1530 nm	1550 nm	1570 nm	1590 nm	1610 nm
Corresponding GBIC Colors	Gray	Violet	Blue	Green	Yellow	Orange	Red	Brown
Band	47	49	51	53	55	57	59	61

The ONS 15454-supported DWDM GBICs reach up to 100 to 120 km over single-mode fiber and support 32 different wavelengths in the red and blue bands. Paired with optical amplifiers, such as the Cisco ONS 15216, the DWDM GBICs allow maximum unregenerated spans of approximately 300 km (Table 5-23).

**Table 5-23 Supported Wavelengths for DWDM GBICs**

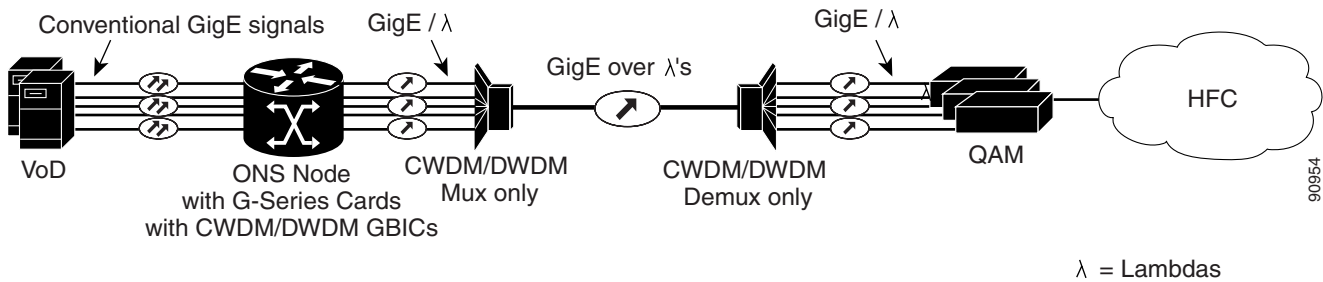
<b>Blue Band</b>	1530.33 nm	1531.12 nm	1531.90 nm	1532.68 nm	1534.25 nm	1535.04 nm	1535.82 nm	1536.61 nm
	1538.19 nm	1538.98 nm	1539.77 nm	1540.56 nm	1542.14 nm	1542.94 nm	1543.73 nm	1544.53 nm
<b>Red Band</b>	1546.12 nm	1546.92 nm	1547.72 nm	1548.51 nm	1550.12 nm	1550.92 nm	1551.72 nm	1552.52 nm
	1554.13 nm	1554.94 nm	1555.75 nm	1556.55 nm	1558.17 nm	1558.98 nm	1559.79 nm	1560.61 nm

CWDM or DWDM GBICs for the G-Series card come in set wavelengths and are not provisionable. The wavelengths are printed on each GBIC, for example, CWDM-GBIC-1490. The user must insert the specific GBIC transmitting the wavelength required to match the input of the CWDM/DWDM device for successful operation (Figure 5-12). Follow your site plan or network diagram for the required wavelengths.

**Figure 5-12 CWDM GBIC with Wavelength Appropriate for Fiber-Connected Device**

A G-Series card equipped with CWDM or DWDM GBICs supports the delivery of unprotected Gigabit Ethernet service over Metro DWDM (Figure 5-13). It can be used in short-haul and long-haul applications.

**Figure 5-13 G-Series with CWDM/DWDM GBICs in Cable Network**



## 5.11.4 SFP Description

SFPs are integrated fiber optic transceivers that provide high speed serial links from a port or slot to the network. Various latching mechanisms can be utilized on the SFP modules. There is no correlation between the type of latch to the model type (such as SX or LX/LH) or technology type (such as Gigabit Ethernet). See the label on the SFP for technology type and model. One type of latch available is a mylar tab (Figure 5-14), a second type of latch available is an actuator/button (Figure 5-15), and a third type of latch is a bail clasp (Figure 5-16).

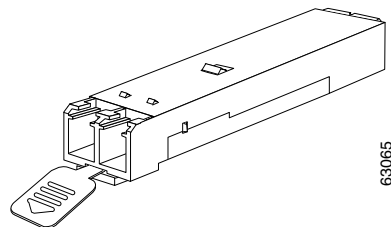
SFP dimensions are:

- Height 0.03 in. (8.5 mm)
- Width 0.53 in. (13.4 mm)
- Depth 2.22 in. (56.5 mm)

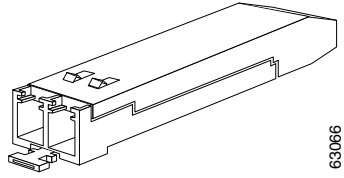
SFP temperature ranges for are:

- COM—commercial operating temperature range -5°C to 70°C
- EXT—extended operating temperature range -5°C to 85°C
- IND—industrial operating temperature range -40°C to 85°C

**Figure 5-14 Mylar Tab SFP**

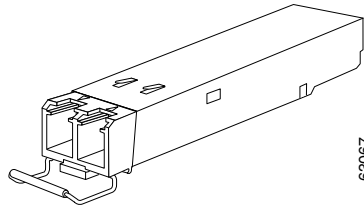


**Figure 5-15** *Actuator/Button SFP*



63066

**Figure 5-16** *Bail Clasp SFP*



63067