



Electrical Cards

This chapter describes Cisco ONS 15454 electrical card features and functions. For installation and card turn-up procedures, refer to the *Cisco ONS 15454 Procedure Guide*. For information on the electrical interface assemblies (EIAs), see the “[1.5 Electrical Interface Assemblies](#)” section on page 1-15.

Chapter topics include:

- [3.1 Electrical Card Overview](#), page 3-1
- [3.2 Electrical Card Warnings](#), page 3-2
- [3.3 EC1-12 Card](#), page 3-3
- [3.4 DS1-14 and DS1N-14 Cards](#), page 3-6
- [3.5 DS3-12 and DS3N-12 Cards](#), page 3-10
- [3.6 DS3i-N-12 Card](#), page 3-14
- [3.7 DS3-12E and DS3N-12E Cards](#), page 3-17
- [3.8 DS3XM-6 Card](#), page 3-22

3.1 Electrical Card Overview

For software and cross-connect card compatibility information, see the “[2.1.2 Card Compatibility](#)” section on page 2-2.

Each card is marked with a symbol that corresponds to a slot (or slots) on the ONS 15454 shelf assembly. The cards are then installed into slots displaying the same symbols. See the “[1.13 Cards and Slots](#)” section on page 1-42 for a list of slots and symbols.

Table 3-1 lists the Cisco ONS 15454 electrical cards.

Table 3-1 Cisco ONS 15454 Electrical Cards

Card Name	Description	For Additional Information
EC1-12	The EC1-12 card provides 12 Telcordiacompliant, GR-253 STS-1 electrical ports per card. Each port operates at 51.840 Mbps over a single 750-ohm, 728A or equivalent coaxial span.	See the “3.3 EC1-12 Card” section on page 3-3.
DS1-14	The DS1-14 card provides 14 Telcordiacompliant GR-499 DS-1 ports. Each port operates at 1.544 Mbps over a 100-ohm, twisted-pair copper cable.	See the “3.4 DS1-14 and DS1N-14 Cards” section on page 3-6.
DS1N-14	The DS1N-14 card supports the same features as the DS1-14 card but can also provide 1:N (N <= 5) protection.	See the “3.4 DS1-14 and DS1N-14 Cards” section on page 3-6.
DS3-12	The DS3-12 card provides 12 Telcordiacompliant GR-499 DS-3 ports per card. Each port operates at 44.736 Mbps over a single 75-ohm, 728A or equivalent coaxial span.	See the “3.5 DS3-12 and DS3N-12 Cards” section on page 3-10.
DS3N-12	The DS3N-12 supports the same features as the DS3-12 but can also provide 1:N (N <= 5) protection.	See the “3.5 DS3-12 and DS3N-12 Cards” section on page 3-10.
DS3i-N-12	Provides 12 DS-3 ports and supports 1:1 or 1:N protection. It operates in Slots 1 to 6 and Slots 12 to 17.	See the “3.6 DS3i-N-12 Card” section on page 3-14.
DS3-12E	The DS3-12E card provides 12 Telcordiacompliant ports per card. Each port operates at 44.736 Mbps over a single 75-ohm, 728A or equivalent coaxial span. The DS3-12E card provides enhanced performance monitoring functions.	See the “3.7 DS3-12E and DS3N-12E Cards” section on page 3-17.
DS3N-12E	The DS3N-12E card supports the same features as the DS3-12E but can also provide 1:N (N <= 5) protection.	See the “3.7 DS3-12E and DS3N-12E Cards” section on page 3-17.
DS3XM-6 (Transmux)	The DS3XM-6 card provides six Telcordiacompliant GR-499-CORE M13 multiplexing functions. The DS3XM-6 converts six framed DS-3 network connections to 28x6 or 168 VT1.5s.	See the “3.8 DS3XM-6 Card” section on page 3-22.

3.2 Electrical Card Warnings



Warning

Do not directly touch the backplane with your hand or any metal tool, or you could shock yourself.



Caution

When working with cards, wear the supplied ESD wristband to avoid ESD damage to the card. Plug the wristband cable into the ESD jack located on the lower-right outside edge of the shelf assembly.

3.3 EC1-12 Card

The EC1-12 card provides 12 Telcordiacompliant, GR-253 STS-1 electrical ports per card. Each port operates at 51.840 Mbps over a single 75-ohm, 728A or equivalent coaxial span.

STS path selection for UNEQ-P, AIS-P, and bit error rate (BER) thresholds is done on the SONET ring interfaces (optical cards) in conjunction with the STS cross-connect. The EC1-12 terminates but does not select the 12 working STS-1 signals from the backplane. The EC1-12 maps each of the 12 received EC1 signals into 12 STS-1s with visibility into the SONET path overhead.

An EC1-12 card can be 1:1 protected with another EC1-12 card but cannot protect more than one EC1-12 card. You must install the EC1-12 in an even-numbered slot to serve as a working card and in an odd-numbered slot to serve as a protect card.

3.3.1 EC1-12 Slots and Connectors

You can install the EC1-12 card in Slots 1 to 6 or 12 to 17 on the ONS 15454. Each EC1-12 interface features DSX-level (digital signal cross-connect frame) outputs supporting distances up to 450 feet (137 meters) depending on facility conditions. See [“7.2 Electrical Card Protection and the Backplane” section on page 7-4](#) for more information about electrical card slot protection and restrictions.

3.3.2 EC1-12 Faceplate and Block Diagram

[Figure 3-1](#) shows the EC1-12 faceplate and a block diagram of the card.

Figure 3-1 EC1-12 Faceplate and Block Diagram

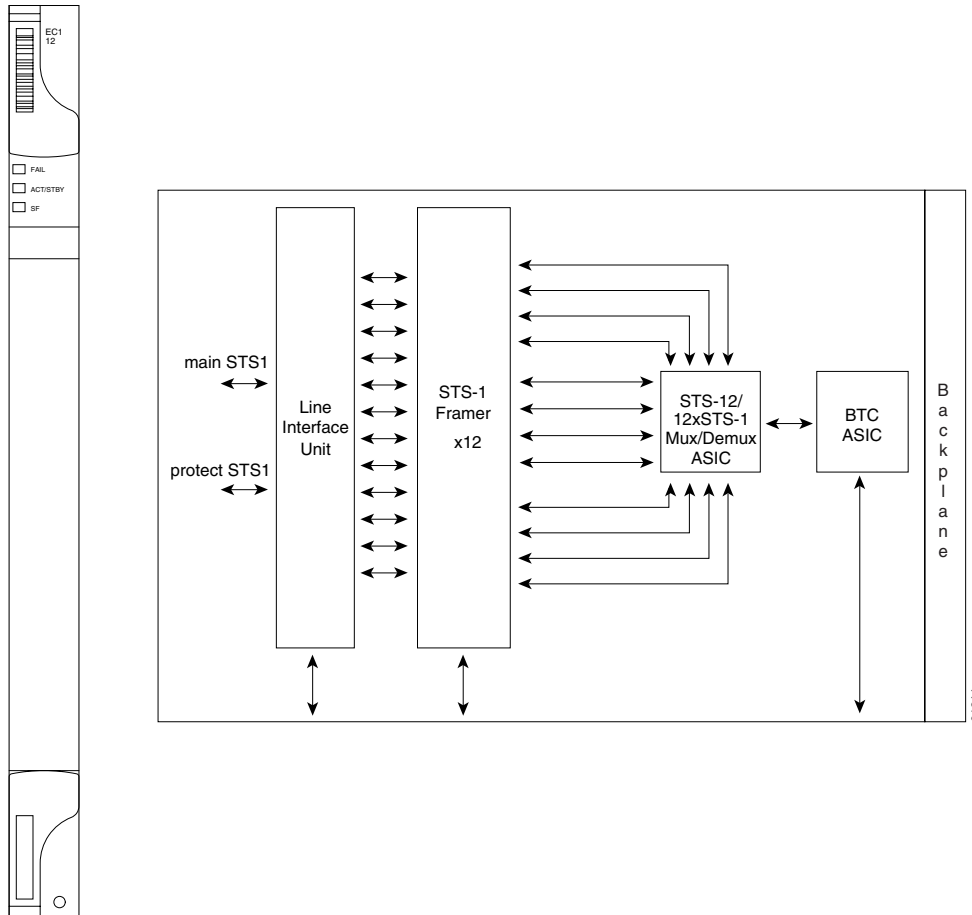

3.3.3 EC1-12 Hosted by XC, XCVT, or XC10G

All 12 STS-1 payloads from an EC1-12 card are carried to the XC, XCVT, or XC10G card where the payload is further aggregated for efficient transport. XC and XCVT cards can host a maximum of 288 bidirectional STS-1s. XC10G can host up to 1152 bidirectional STS-1s.

3.3.4 EC1-12 Card-Level Indicators

Table 3-2 describes the three card-level LEDs on the EC1-12 card.

Table 3-2 EC1-12 Card-Level Indicators

Card-Level Indicators	Description
Red FAIL LED	The red FAIL LED indicates that the EC1-12 card's processor is not ready. Replace the unit if the FAIL LED persists.

Table 3-2 EC1-12 Card-Level Indicators (continued)

Card-Level Indicators	Description
Green ACT LED	The green ACT LED indicates that the EC1-12 card is operational and ready to carry traffic.
Amber SF LED	The amber SF LED indicates a signal failure or condition such as loss of signal (LOS), loss of frame (LOF) or high bit error rate (BER) on one or more of the card's ports.

3.3.5 EC1-12 Port-Level Indicators

You can obtain the status of the EC1-12 card ports using the LCD screen on the ONS 15454 fan tray. Use the LCD to view the status of any port or card slot; the screen displays the number and severity of alarms for a given port or slot.

3.3.6 EC1-12 Card Specifications

The EC1-12 card has the following specifications:

- Input:
 - Bit rate: 51.84 Mbps +/- 20 ppm
 - Frame format: SONET
 - Line code: B3ZS
 - Termination: Unbalanced coaxial cable
 - Input impedance: 75 ohms +/- 5%
 - Cable loss: Max 450 feet 734A, RG-59, 728A/Max 79 feet RG-179
 - AIS: TR-TSY-000191 compliant
- Output:
 - Bit rate: 51.84 Mbps +/- 20 ppm
 - Frame format: SONET
 - Line code: B3ZS
 - Termination: Unbalanced coaxial cable
 - Input impedance: 75 ohms +/- 5%
 - Cable loss: Max 450 feet 734A, RG-59, 728A/Max 79 feet RG-179
 - AIS: TR-TSY-000191 compliant
 - Power level: -1.8 +/- 5.7 dBm
 - Pulse shape: ANSI T1.102-1988 Figure 8
 - Pulse amplitude: 0.36 to 0.85 V peak to peak
 - Loopback modes: Terminal and facility
 - Line build out: 0 to 225 feet; 226 to 450 feet
- Electrical interface: BNC or SMB connectors

- Operating temperature:
 - C-Temp (15454-EC1-12): 0 to +55 degrees Celsius (0 to 131 degrees Fahrenheit)
 - I-Temp (15454-EC1-12-T): –40 to +65 degrees Celsius (–40 to 149 degrees Fahrenheit)



Note The I-Temp symbol is displayed on the faceplate of an I-Temp compliant card. A card without this symbol is C-Temp compliant.

- Operating humidity: 5 to 95%, noncondensing
- Power consumption: 36.60 W, 0.76 A, 124.97 BTU/hr
- Dimensions:
 - Height: 321.3 mm (12.650 inches)
 - Width: 18.2 mm (0.716 inches)
 - Depth: 228.6 mm (9.000 inches)
 - Card weight: 0.9 kg (2.0 lb)
- Compliance:
 - For compliance information, refer to the *Cisco Optical Transport Products Safety and Compliance Information*.

3.4 DS1-14 and DS1N-14 Cards

The ONS 15454 DS1-14 card provides 14 Telcordiacompliant, GR-499 DS-1 ports. Each port operates at 1.544 Mbps over a 100-ohm, twisted-pair copper cable. The DS1-14 card can function as a working or protect card in 1:1 protection schemes and as a working card in 1:N protection schemes.

The DS1-14 card supports 1:1 protection. The DS1-14 can be a working card in a 1:N protection scheme with the proper backplane EIA and wire-wrap or AMP Champ connectors. You can also provision the DS1-14 to monitor for line and frame errors in both directions.

You can group and map DS1-14 card traffic in STS-1 increments to any other card in an ONS 15454 except DS-3 cards. Each DS-1 is asynchronously mapped into a SONET VT1.5 payload and the card carries a DS-1 payload intact in a VT1.5. For performance monitoring purposes, you can gather bidirectional DS-1 frame-level information (loss of frame, parity errors, cyclic redundancy check [CRC] errors, and so on).

3.4.1 DS1N-14 Features and Functions

The DS1N-14 card supports the same features as the DS1-14 card in addition to enhanced protection schemes. The DS1N-14 is capable of 1:N ($N \leq 5$) protection with the proper backplane EIA and wire-wrap or AMP Champ connectors. The DS1N-14 card can function as a working or protect card in 1:1 or 1:N protection schemes.

3.4.2 DS1-14 and DS1N-14 Slots and Connectors

You can install the DS1-14 card in Slots 1 to 6 or 12 to 17 on the ONS 15454. Each DS1-14 port has DSX-level (digital signal cross-connect frame) outputs supporting distances up to 655 feet.

If you use the DS1N-14 as a standard DS-1 card in a 1:1 protection group, you can install the DS1N-14 card in Slots 1 to 6 or 12 to 17 on the ONS 15454. If you use the card's 1:N functionality, you must install a DS1N-14 card in Slots 3 and 15. Each DS1N-14 port features DS-n-level outputs supporting distances of up to 655 feet depending on facility conditions.

3.4.3 DS1-14 and DS1N-14 Faceplate and Block Diagram

Figure 3-2 shows the DS1-14 faceplate and the block diagram of the card.

Figure 3-2 DS1-14 Faceplate and Block Diagram

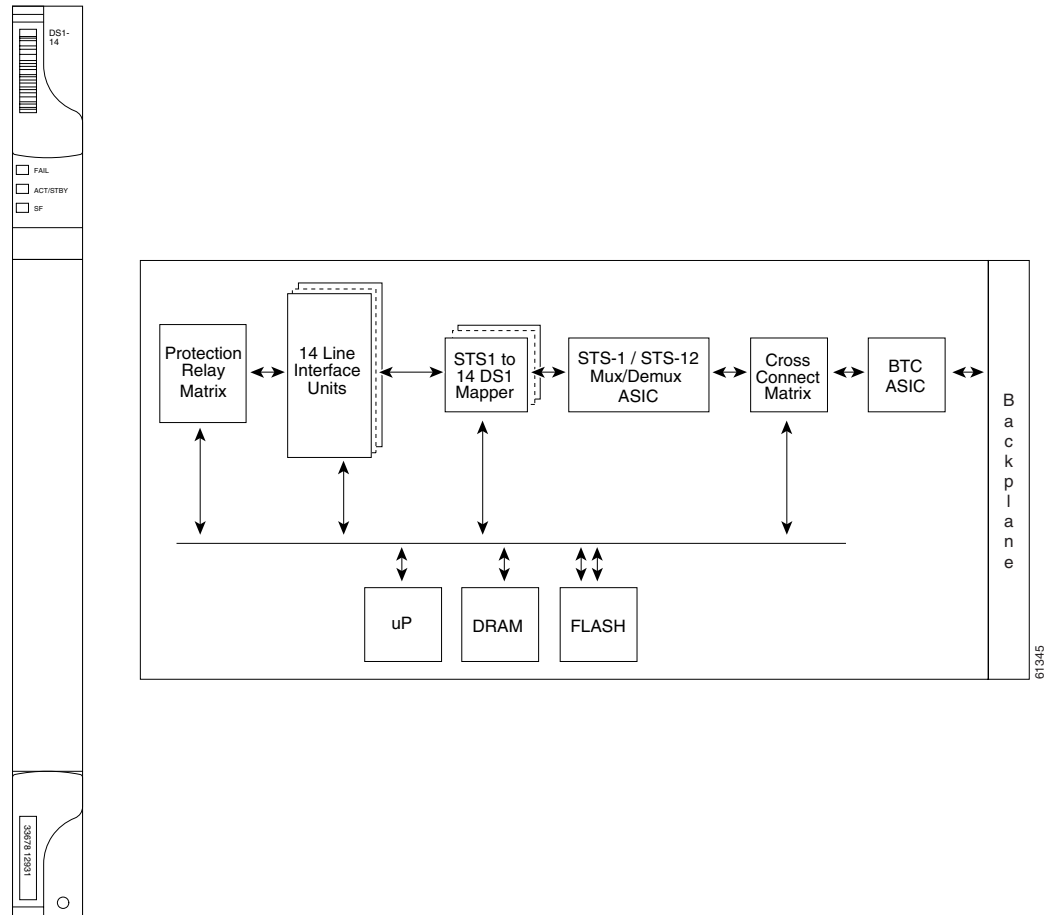
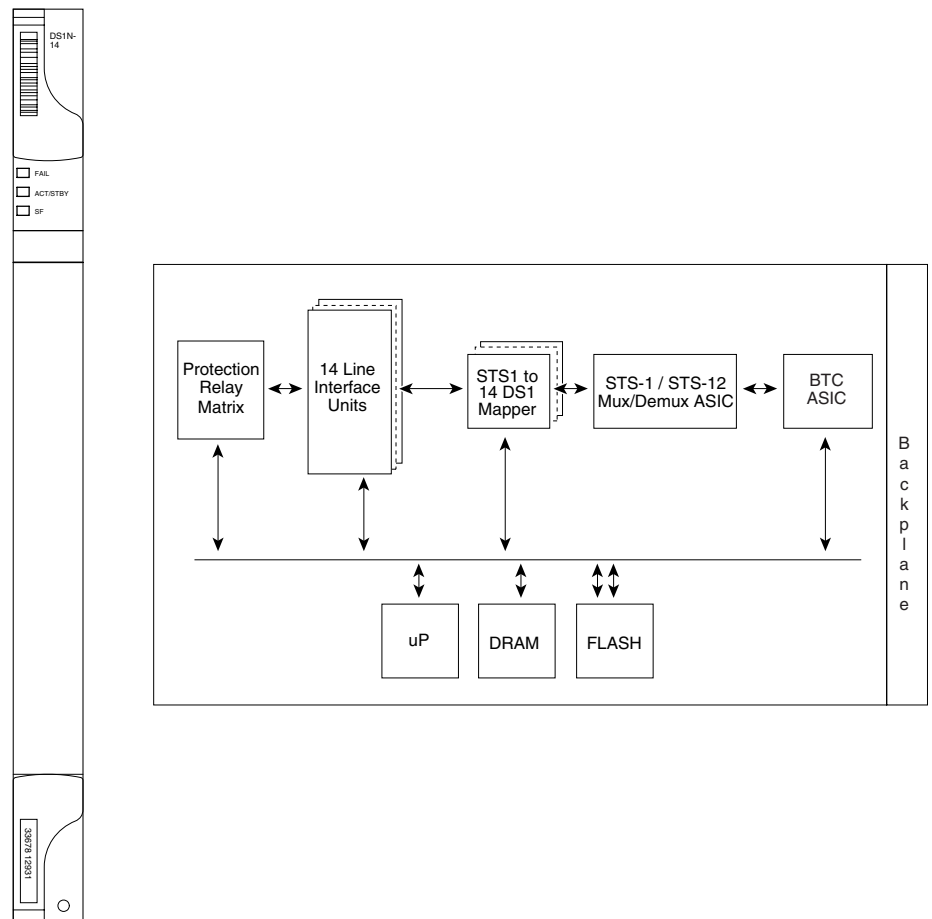

Figure 3-3 shows the DS1N-14 faceplate and a block diagram of the card.

Figure 3-3 DS1N-14 Faceplate and Block Diagram



3.4.4 DS1-14 and DS1N-14 Hosted by the Cross-Connect

All 14 VT1.5 payloads from DS1-14 and DS1N-14 cards are carried in a single STS-1 to the XCVT or XC10G card where the payload is further aggregated for efficient STS-1 transport. The XC10G and XCVT cards manage up to 336 bidirectional VT1.5 ports.

3.4.5 DS1-14 and DS1N-14 Card-Level Indicators

Table 3-3 describes the three card-level LEDs on the DS1-14 and DS1N-14 card faceplates.

Table 3-3 DS1-14 and DS1N-14 Card-Level Indicators

Card-Level Indicators	Description
Red FAIL LED	The red FAIL LED indicates that the card's processor is not ready. Replace the card if the red FAIL LED persists.
ACT/STBY LED Green (Active) Amber (Standby)	The green/amber ACT/STBY LED indicates whether the card is operational and ready to carry traffic (green) or in standby mode (amber).
Amber SF LED	The amber SF LED indicates a signal failure or condition such as LOS, LOF, or high BERs on one or more of the card's ports.

3.4.6 DS1-14 and DS1N-14 Port-Level Indicators

You can obtain the status of the DS1-14 and DS1N-14 card ports using the LCD screen on the ONS 15454 fan-tray assembly. Use the LCD to view the status of any port or card slot; the screen displays the number and severity of alarms for a given port or slot.

3.4.7 DS1-14 and DS1N-14 Card Specifications

DS1-14 and DS1N-14 cards have the following specifications:

- Input:
 - Bit rate: 1.544 Mbps +/- 32 ppm
 - Frame format: Off, SF (D4), ESF
 - Line code: AMI, B8ZS
 - Termination: Wire-wrap, AMP Champ
 - Input impedance: 100 ohms
 - Cable loss: Max 655 feet ABAM #22 AWG
 - AIS: TR-TSY-000191 compliant
- Output:
 - Bit rate: 1.544 Mbps +/- 32 ppm
 - Frame format: Off, SF (D4), ESF
 - Line code: AMI, B8ZS
 - Termination: Wire-wrap, AMP Champ
 - Input impedance: 100 ohms
 - Cable loss: Max 655 feet ABAM #22 AWG
 - AIS: TR-TSY-000191 compliant
 - Power level: 12.5 to 17.9 dBm centered at 772 KHz, -16.4 to -11.1 dBm centered at 1544 KHz
 - Pulse shape: Telcordia GR-499-CORE Figure 9-5
 - Pulse amplitude: 2.4 to 3.6 V peak-to-peak
 - Loopback modes: Terminal and facility

- Electrical interface: BNC or SMB connectors
- Surge protection: Telcordia GR-1089
- Operating temperature:
 - C-Temp (15454-DS1-14 and 15454-DS1N-14): 0 to +55 degrees Celsius (0 to 131 degrees Fahrenheit)
 - I-Temp (15454-DS1-14-T and 15454-DS1N-14-T): –40 to +65 degrees Celsius (–40 to 149 degrees Fahrenheit)



Note The I-Temp symbol is displayed on the faceplate of an I-Temp compliant card. A card without this symbol is C-Temp compliant.

- Operating humidity: 5 to 95%, noncondensing
- Power consumption: 12.60 W, 0.26 A, 43.02 BTU/hr
- Dimensions:
 - Height: 321.3 mm (12.650 inches)
 - Width: 18.2 mm (0.716 inches)
 - Depth: 228.6 mm (9.000 inches)
 - Card weight: 0.8 kg (1.8 lb)
- Compliance:
 - For compliance information, refer to the *Cisco Optical Transport Products Safety and Compliance Information*.

3.5 DS3-12 and DS3N-12 Cards

The ONS 15454 DS3-12 card provides 12 Telcordia-compliant, GR-499 DS-3 ports per card. Each port operates at 44.736 Mbps over a single 75-ohm 728A or equivalent coaxial span. The DS3-12 card operates as a working or protect card in 1:1 protection schemes and as a working card in 1:N protection schemes.

The DS3-12 card supports 1:1 protection with the proper backplane EIA. EIAs are available with BNC, SMB, or SCSI connectors.



Caution

When a protection switch moves traffic from the DS3-12 working/active card to the DS3-12 protect/standby card, ports on the now active/standby card cannot be taken out of service. Lost traffic can result if you take a port out of service even if the DS3-12 standby card no longer carries traffic.

Other than the protection capabilities, the DS3-12 and DS3N-12 cards are identical. The DS3N-12 can operate as the protect card in a 1:N (N ≤ 5) DS3 protection group. It has additional circuitry not present on the basic DS3-12 card that allows it to protect up to five working DS3-12 cards. The basic DS3-12 card can only function as the protect card for one other DS3-12 card.

3.5.1 DS3-12 and DS3N-12 Slots and Connectors

You can install the DS3-12 or DS3N-12 card in Slots 1 to 6 or 12 to 17 on the ONS 15454. Each DS3-12 or DS3N-12 card port features DSX-level outputs supporting distances up to 137 meters (450 feet) depending on facility conditions. With the proper backplane EIA, the card supports BNC or SMB connectors. See the “7.2 Electrical Card Protection and the Backplane” section on page 7-4 for more information about electrical card slot protection and restrictions.

3.5.2 DS3-12 and DS3N-12 Faceplate and Block Diagram

Figure 3-4 shows the DS3-12 faceplate and a block diagram of the card.

Figure 3-4 DS3-12 Faceplate and Block Diagram

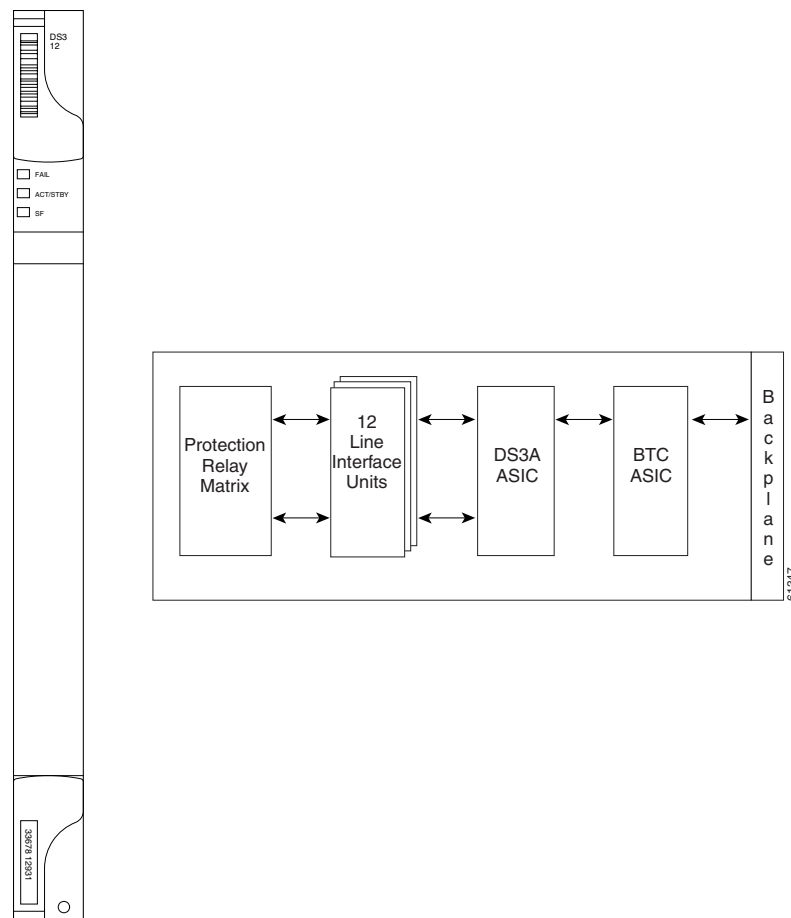
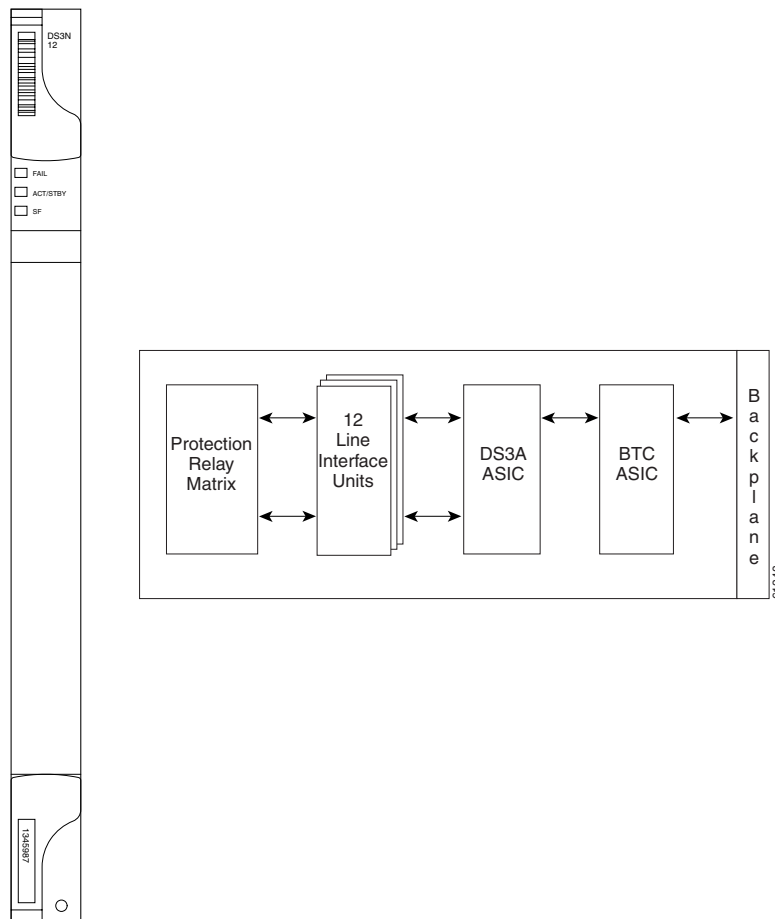

Figure 3-5 shows the DS3N-12 faceplate and a block diagram of the card.

Figure 3-5 DS3N-12 Faceplate and Block Diagram



3.5.3 DS3-12 and DS3N-12 Card-Level Indicators

Table 3-4 describes the three card-level LEDs on the DS3-12 and DS3N-12 card faceplates.

Table 3-4 DS3-12 and DS3N-12 Card-Level Indicators

Card-Level Indicators	Description
Red FAIL LED	The red FAIL LED indicates that the card's processor is not ready. Replace the card if the red FAIL LED persists.
ACT/STBY LED Green (Active) Amber (Standby)	When the ACT/STBY LED is green, the card is operational and ready to carry traffic. When the ACT/STBY LED is amber, the card is operational and in standby (protect) mode.
Amber SF LED	The amber SF LED indicates a signal failure or condition such as port LOS.

3.5.4 DS3-12 and DS3N-12 Port-Level Indicators

You can find the status of the 12 DS3-12 and 12 DS3N-12 card ports using the LCD screen on the ONS 15454 fan-tray assembly. Use the LCD to view the status of any port or card slot; the screen displays the number and severity of alarms for a given port or slot.

3.5.5 DS3-12 and DS3N-12 Card Specifications

DS3-12 and DS3N-12 cards have the following specifications:

- Input:
 - Bit rate: 44.736 Mbps +/- 20 ppm
 - Frame format: DS-3 ANSI T1.107-1988
 - Line code: B3ZS
 - Termination: Unbalanced coaxial cable
 - Input impedance: 75 ohms +/-5%
 - Cable loss: Max 450 feet 734A, RG-59, 728A/Max 79 feet RG-179
 - AIS: TR-TSY-000191 compliant
- Output:
 - Bit rate: 44.736 Mbps +/- 20 ppm
 - Frame format: DS-3 ANSI T1.107-1988
 - Line code: B3ZS
 - Termination: Unbalanced coaxial cable
 - Input impedance: 75 ohms +/-5%
 - Cable loss: Max 450 feet 734A, RG-59, 728A/Max 79 feet RG-179
 - AIS: TR-TSY-000191 compliant
 - Power level: -1.8 to +5.7 dBm
 - Pulse shape: ANSI T1.102-1988 Figure 8
 - Pulse amplitude: 0.36 to 0.85 V peak-to-peak
 - Loopback modes: Terminal and facility
 - Line build out: 0 to 225 feet; 226 to 450 feet
- Electrical interface: BNC or SMB connectors
- Surge protection: Telcordia GR-1089
- Operating temperature:
 - C-Temp (15454-DS3-12 and 15454-DS3N-12): 0 to +55 degrees Celsius (0 to 131 degrees Fahrenheit)
 - I-Temp (15454-DS3-12-T and 15454-DS3N-12-T): -40 to +65 degrees Celsius (-40 to 149 degrees Fahrenheit)



Note The I-Temp symbol is displayed on the faceplate of an I-Temp compliant card. A card without this symbol is C-Temp compliant.

- Operating humidity: 5 to 95%, noncondensing
- Power consumption: 38.20 W, 0.79 A, 130.43 BTU/hr
- Dimensions:
 - Height: 321.3 mm (12.650 inches)
 - Width: 18.2 mm (0.716 inches)
 - Depth: 228.6 mm (9.000 inches)
 - DS3-12 card weight: 0.7 kg (1.7 lb)
 - DS3N-12 card weight: 0.8 kg (1.8 lb)
- Compliance:
 - For compliance information, refer to the *Cisco Optical Transport Products Safety and Compliance Information*.

3.6 DS3i-N-12 Card

The 12-port ONS 15454 DS3i-N-12 card provides 12 ITU-T G.703, ITU-T G.704, and Telcordia GR-499-CORE compliant DS-3 ports per card. Each port operates at 44.736 Mbps over a 75-ohm coaxial cable. The DS3i-N-12 card supports 1:1 or 1:N protection with the proper backplane EIA. Each DS3-12 or DS3N-12 card port features DSX-level outputs supporting distances up to 137 meters (450 feet) depending on facility conditions. The DS3i-N-12 card works with the XCVT and XC10G cross-connect cards. Four sets of three adjacent DS-3 signals (Port 1 through Port 3, Port 4 through Port 6, Port 7 through Port 9, and Port 10 through Port 12) are mapped to VC3s into a VC4 and transported as an STC-3c.

The DS3i-n-12 can also aggregate DS3 and E1 traffic and transport it between SONET and SDH networks through AU4/STS 3 trunks, with the ability to add and drop DS3s to an STS3 trunk at intermediate nodes.

3.6.1 DS3i-N-12 Slots and Connectors

You can install the DS3i-N-12 card in Slots 1 to 6 and 12 to 17. The DS3i-N-12 can operate as the protect card in a 1:N ($N \leq 5$) DS-3 protection group on a half-shelf basis, with protection cards in Slots 3 and 15. It has circuitry that allows it to protect up to five working DS3i-N-12 cards. With the proper backplane EIA, the card supports BNC or SMB connectors. See [“7.2 Electrical Card Protection and the Backplane” section on page 7-4](#) for more information about electrical card slot protection and restrictions.

[Figure 3-6](#) shows the DS3i-N-12 faceplate and block diagram.

Figure 3-6 DS3i-N-12 Faceplate and Block Diagram

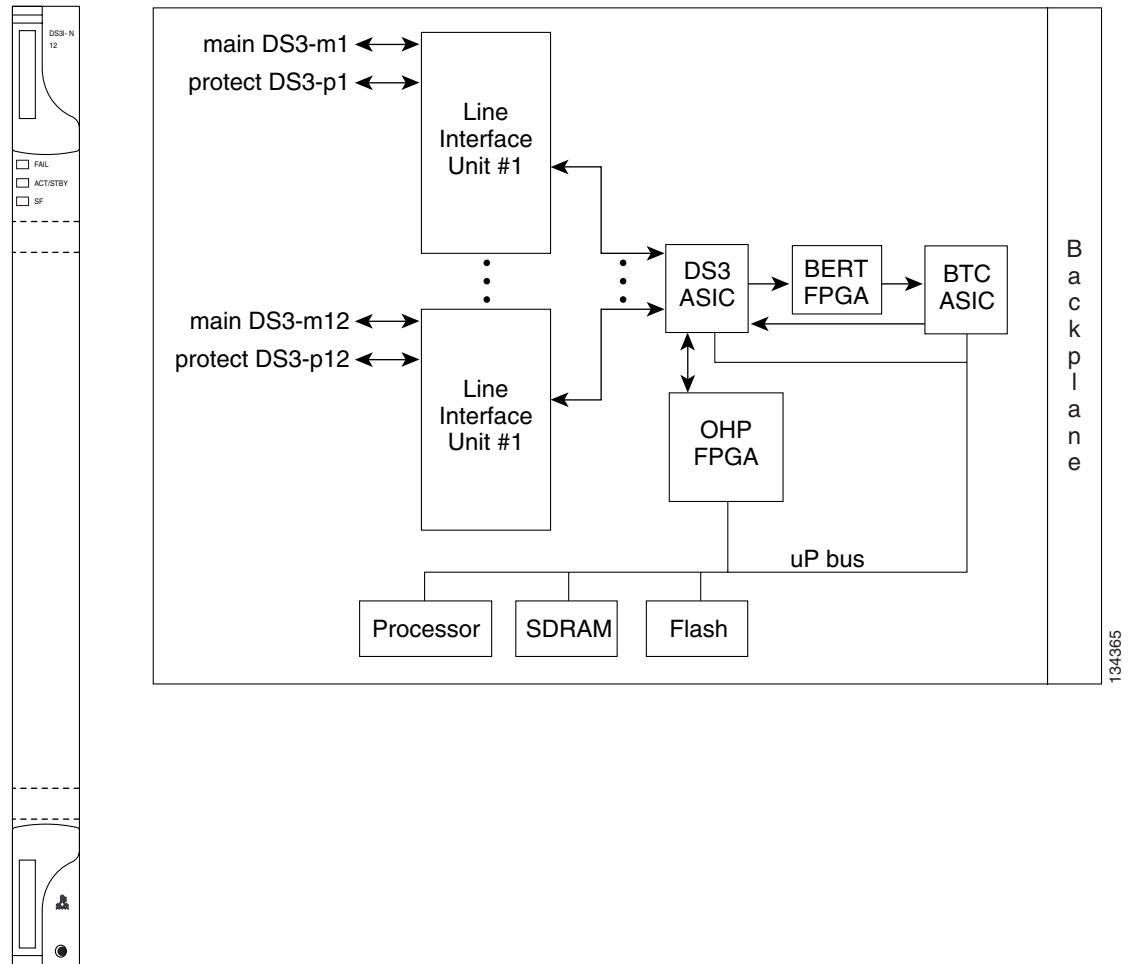

The following list summarizes the DS3i-N-12 card features:

- Provisionable framing format (M23, C-bit, or unframed)
- Autorecognition and provisioning of incoming framing
- VC-3 payload mapping as per ITU-T G.707, mapped into VC-4 and transported as STS-3c
- Idle signal (“1100”) monitoring as per Telcordia GR-499-CORE
- P-bit monitoring
- C-bit parity monitoring
- X-bit monitoring
- M-bit monitoring
- F-bit monitoring
- Far-end block error (FEBE) monitoring
- Far-end alarm and control (FEAC) status and loop code detection
- Path trace byte support with TIM-P alarm generation

3.6.2 DS3i-N-12 Card-Level Indicators

Table 3-5 describes the three LEDs on the DS3i-N-12 card faceplate.

Table 3-5 DS3i-N-12 Card-Level Indicators

Card-Level LEDs	Description
Red FAIL LED	Indicates that the card's processor is not ready. This LED is on during reset. The FAIL LED flashes during the boot process. Replace the card if the red FAIL LED persists in flashing.
ACT/STBY LED Green (Active) Amber (Standby)	When the ACT/STBY LED is green, the DS3i-N-12 card is operational and ready to carry traffic. When the ACT/STBY LED is amber, the DS3i-N-12 card is operational and in Standby (protect) mode.
Amber SF LED	Indicates a signal failure or condition such as LOS or LOF on one or more of the card's ports.

3.6.3 DS3i-N-12 Port-Level Indicators

You can find the status of the DS3i-N-12 card ports using the LCD screen on the ONS 15454 fan-tray assembly. Use the LCD to view the status of any port or card slot; the screen displays the number and severity of alarms for a given port or slot. Refer to the *Cisco ONS 15454 Troubleshooting Guide* for a complete description of the alarm messages.

3.6.4 DS3i-N-12 Card Specifications

The DS3i-N-12 card has the following specifications:

- DS3i-N-12 input
 - Bit rate: 44.736 Mbps +/-20 ppm
 - Frame format: ITU-T G.704, ITU-T G.752/DS-3 ANSI T1.107-1988
 - Line code: B3ZS
 - Termination: Unbalanced coaxial cable
 - Input impedance: 75 ohms +/- 5%
 - Cable loss:
 - Maximum 137 m (450 ft): 734A, RG59, 728A
 - Maximum 24 m (79 ft): RG179
 - AIS: ITU-T G.704 compliant
- DS3i-N-12 output
 - Bit rate: 44.736 Mbps +/- 20 ppm
 - Frame format: ITU-T G.704 , ITU-T G.752/DS-3 ANSI T1.107-1988
 - Line code: B3ZS
 - Termination: Unbalanced coaxial cable
 - Output impedance: 75 ohms +/-5%

- AIS: ITU-T G.704 compliant
- Power level: -1.8 to $+5.7$ dBm (The power level is for a signal of all ones and is measured at a center frequency of 22.368 MHz (3 \pm 1 kHz) bandwidth.)
- Pulse shape: ITU-T G.703, Figure 14/ANSI T1.102-1988, Figure 8
- Pulse amplitude: 0.36 to 0.85 V peak-to-peak
- Loopback modes: terminal and facility
- Line build out: 0 to 69 m (0 to 225 ft); 69 to 137 m (226 to 450 ft)
- DS3i-N-12 electrical interface
 - Connectors: SMB, BNC
- Environmental
 - Overvoltage protection: As in ITU-T G.703 Annex B
 - Operating temperature: -5 to $+45$ degrees Celsius ($+23$ to $+113$ degrees Fahrenheit)
 - Operating humidity: 5 to 95%, noncondensing
 - Power consumption: 26.80 W, 0.56 A at -48 V, 91.5 BTU/hr
- Dimensions
 - Height: 321.3 mm (12.650 inches)
 - Width: 18.2 mm (0.716 inches)
 - Depth: 228.6 mm (9.000 inches)
 - Depth with backplane connector: 235 mm (9.250 inches)
 - Weight not including clam shell: 0.8 kg (1.9 lb)
- Compliance
 - For compliance information, refer to the *Cisco Optical Transport Products Safety and Compliance Information*.

3.7 DS3-12E and DS3N-12E Cards

The ONS 15454 DS3-12E card provides 12 Telcordiacompliant GR-499 DS-3 ports per card. Each port operates at 44.736 Mbps over a single 75 ohm 728A or equivalent coaxial span. The DS3-12E card provides enhanced performance monitoring functions. The DS3-12E can detect several different errored logic bits within a DS3 frame. This function allows the ONS 15454 to identify a degrading DS3 facility caused by upstream electronics (DS3 Framer). In addition, DS3 frame format autodetection and J1 path trace are supported. By monitoring additional overhead in the DS3 frame, subtle network degradations can be detected.

The following list summarizes DS3-12E card features:

- Provisionable framing format M23, C-bit or unframed
- Autorecognition and provisioning of incoming framing
- P-bit monitoring
- C-bit parity monitoring
- X-bit monitoring
- M-bit monitoring

- F-bit monitoring
- FEBE monitoring
- FEAC status and loop code detection
- Path trace byte support with TIM-P alarm generation

The DS3-12E supports a 1:1 protection scheme, meaning it can operate as the protect card for one other DS3-12E card.

The DS3N-12E can operate as the protect card in a 1:N ($N \leq 5$) DS3 protection group. It has additional circuitry not present on the basic DS3-12E card that allows it to protect up to five working DS3-12E cards. The basic DS3-12E card can only function as the protect card for one other DS3-12E card.

3.7.1 DS3-12E and DS3N-12E Slots and Connectors

You can install the DS3-12E and DS3N-12E cards in Slots 1 to 6 or 12 to 17 on the ONS 15454. Each DS3-12E and DS3N-12E port features DSX-level outputs supporting distances up to 137 meters (450 feet). With the proper backplane EIA, the card supports BNC or SMB connectors. See [“7.2 Electrical Card Protection and the Backplane” section on page 7-4](#) for more information about electrical card slot protection and restrictions.

3.7.2 DS3-12E Faceplate and Block Diagram

[Figure 3-7](#) shows the DS3-12E faceplate and a block diagram of the card.

Figure 3-7 DS3-12E Faceplate and Block Diagram

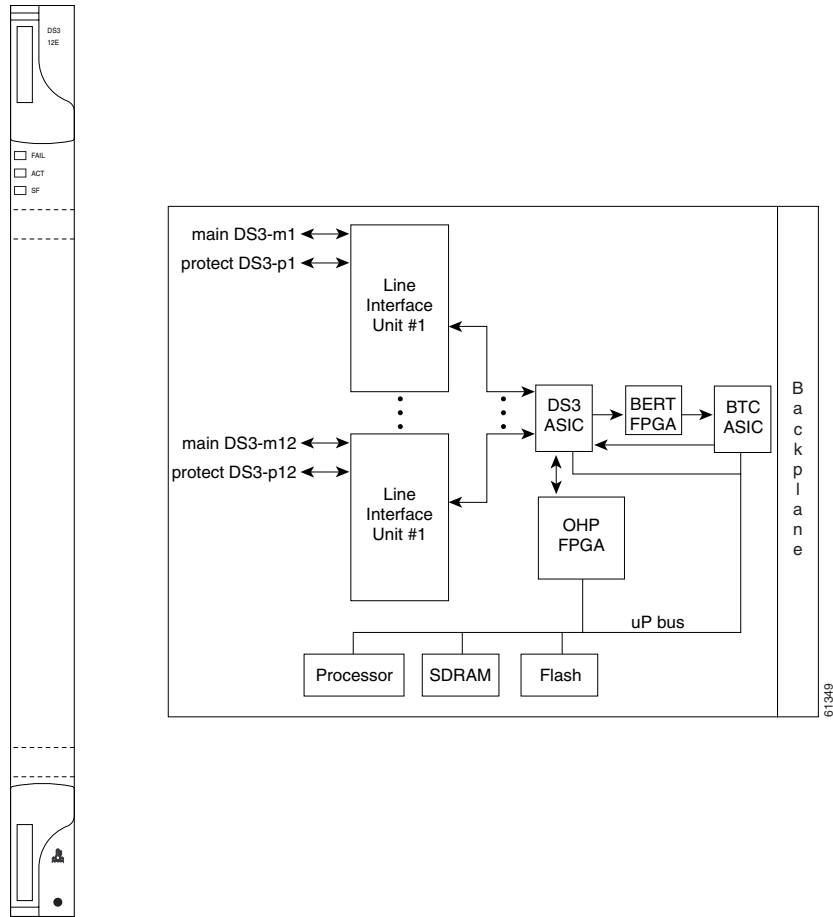
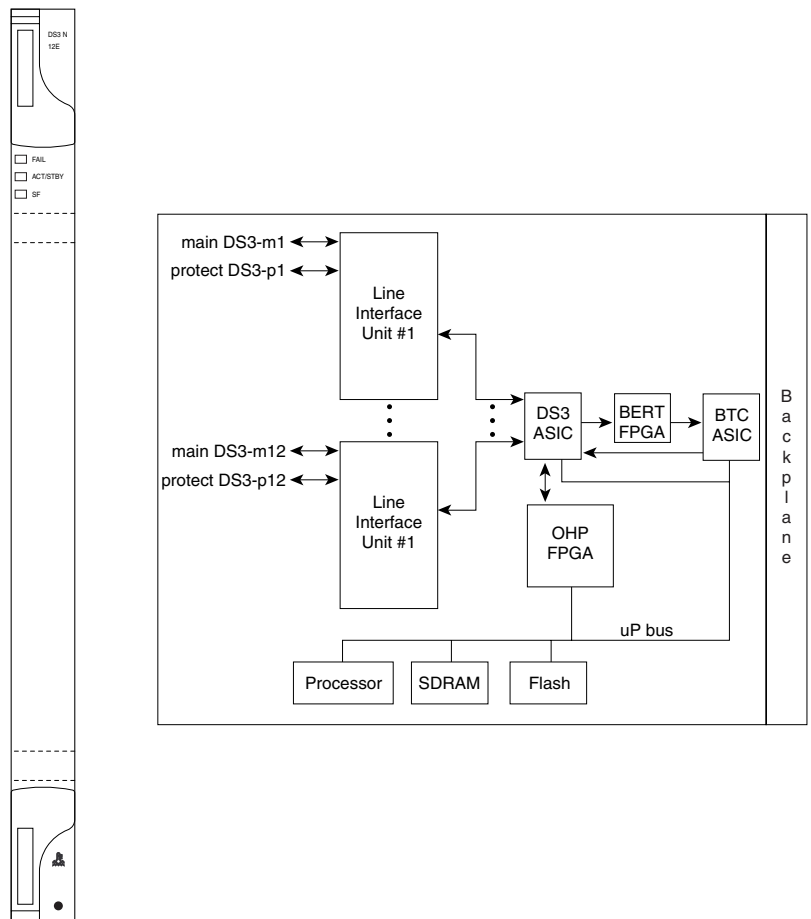

Figure 3-8 shows the DS3N-12E faceplate and a block diagram of the card.

Figure 3-8 DS3N-12E Faceplate and Block Diagram



3.7.3 DS3-12E and DS3N-12E Card-Level Indicators

Table 3-6 describes the three card-level LEDs on the DS3-12E and DS3N-12E card faceplates.

Table 3-6 DS3-12E and DS3N-12E Card-Level Indicators

Card-Level Indicators	Description
Red FAIL LED	The red FAIL LED indicates that the card's processor is not ready. Replace the card if the red FAIL LED persists.
ACT/STBY LED Green (Active) Amber (Standby)	When the ACT/STBY LED is green, the card is operational and ready to carry traffic. When the ACT/STBY LED is amber, the card is operational and in standby (protect) mode.
Amber SF LED	The amber SF LED indicates a signal failure or condition such as port LOS or AIS.

3.7.4 DS3-12E and DS3N-12E Port-Level Indicators

You can find the status of the DS3-12E and DS3N-12E card ports using the LCD screen on the ONS 15454 fan-tray assembly. Use the LCD to quickly view the status of any port or card slot; the screen displays the number and severity of alarms for a given port or slot.

3.7.5 DS3-12E and DS3N-12E Card Specifications

DS3-12E and DS3N-12E cards have the following specifications:

- Input:
 - Bit rate: 44.736 Mbps +/- 20 ppm
 - Frame format: DS-3 ANSI T1.107-1988
 - Line code: B3ZS
 - Termination: Unbalanced coaxial cable
 - Input impedance: 75 ohms +/-5%
 - Cable loss: Max 450 feet 734A, RG-59, 728A/Max 79 feet RG-179
 - AIS: TR-TSY-000191compliant
- Output:
 - Bit rate: 44.736 Mbps +/- 20 ppm
 - Frame format: DS-3 ANSI T1.107-1988
 - Line code: B3ZS
 - Termination: Unbalanced coaxial cable
 - Input impedance: 75 ohms +/-5%
 - Cable loss: Max 450 feet 734A, RG-59, 728A/Max 79 feet RG-179
 - AIS: TR-TSY-000191compliant
 - Power level: -1.8 to +5.7 dBm



Note The power level is for a signal of all ones and is measured at a center frequency of 22.368 MHz (+/- KHz) bandwidth.

- Pulse shape: ANSI T1.102-1988 Figure 8
- Pulse amplitude: 0.36 to 0.85 V peak-to-peak
- Loopback modes: Terminal and facility
- Line build out: 0 to 225 feet; 226 to 450 feet
- Electrical interface: Connectors: BNC or SMB
- Surge protection: Telcordia GR-1089
- Operating temperature: I-Temp (15454-DS3-12E-T and 15454-DS3N-12E-T): -40 to +65 degrees Celsius (-40 to 149 degrees Fahrenheit)



Note The I-Temp symbol is displayed on the faceplate of an I-Temp compliant card. A card without this symbol is C-Temp compliant.

- Operating humidity: 5 to 95%, noncondensing
- Power consumption: 26.80 W, 0.56 A, 91.51 BTU/hr
- Dimensions:
 - Height: 321.3 mm (12.650 in.)
 - Width: 18.2 mm (0.716 in.)
 - Depth: 228.6 mm (9.000 in.)
 - Depth with backplane connector: 235.0 mm (9.250 in.)
 - DS3-12E card weight: 0.8 kg (1.8 lb)
 - DS3N-12E card weight: 0.8 kg (1.8 lb)
- Compliance:
 - For compliance information, refer to the *Cisco Optical Transport Products Safety and Compliance Information*.

3.8 DS3XM-6 Card

The DS3XM-6 card, commonly referred to as a transmux card, provides six Telcordiacompliant, GR-499-CORE M13 multiplexing functions. The DS3XM-6 converts six framed DS-3 network connections to 28 x6 or 168 VT1.5s. You cannot create circuits from a DS3XM-6 card to a DS-3 card. DS3XM-6 cards operate at the VT1.5 level.

3.8.1 DS3XM-6 Slots and Connectors

The DS3XM-6 card supports 1:1 protection with the proper backplane EIA. EIAs are available with BNC or SMB connectors.

You can install the DS3XM-6 in Slots 1 to 6 or 12 to 17. Each DS3XM-6 port features DSX-level outputs supporting distances up to 137 meters (450 feet) depending on facility conditions. See [“7.2 Electrical Card Protection and the Backplane”](#) section on page 7-4 for more information about electrical card slot protection and restrictions.

3.8.2 DS3XM-6 Faceplate and Block Diagram

[Figure 3-9](#) shows the DS3XM-6 faceplate and a block diagram of the card.

Figure 3-9 DS3XM-6 Faceplate and Block Diagram

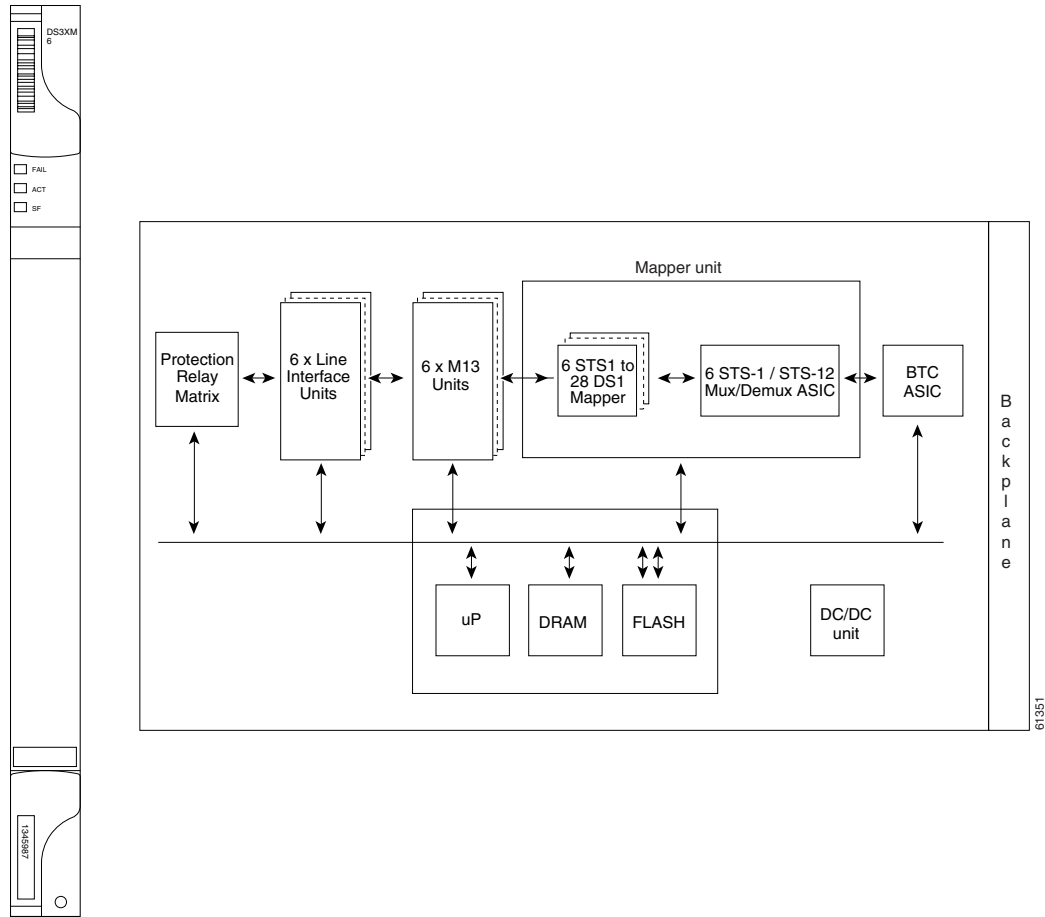

3.8.3 DS3XM-6 Hosted By XCVT

The DS3XM-6 card works in conjunction with the XCVT card. A single DS3XM-6 can demultiplex six DS-3 signals into 168 VT1.5s that the XCVT card then manages and cross connects. XCVT cards host a maximum of 336 bidirectional VT1.5s or two DS3XM-6 cards. In most network configurations, two DS3XM-6 cards are paired together as working and protect cards.

3.8.4 DS3XM-6 Card-Level Indicators

Table 3-7 describes the three card-level LEDs on the DS3XM-6 card faceplate.

Table 3-7 DS3XM-6 Card-Level Indicators

Card-Level Indicators	Description
Red FAIL LED	The red FAIL LED indicates that the card's processor is not ready. Replace the card if the red FAIL LED persists.
ACT/STBY LED Green (Active) Amber (Standby)	When the ACT/STBY LED is green, the DS3XM-6 card is operational and ready to carry traffic. When the ACT/STBY LED is amber, the DS3XM-6 card is operational and in standby in a 1:1 protection group.
Amber SF LED	The amber SF LED indicates a signal failure or condition such as LOS, LOF, or high BER on one or more of the card's ports.

3.8.5 DS3XM-6 Port-Level Indicators

You can find the status of the six DS3XM-6 card ports using the LCD screen on the ONS 15454 fan-tray assembly. Use the LCD to quickly view the status of any port or card slot; the screen displays the number and severity of alarms for a given port or slot.

3.8.6 DS3XM-6 Card Specifications

DS3XM-6 cards have the following specifications:

- Input:
 - Bit rate: 44.736 Mbps +/-20 ppm
 - Frame format: DS-3 ANSI T1.107-1988
 - Line code: B3ZS
 - Termination: Unbalanced coaxial cable
 - Input impedance: 75 ohms +/-5%
 - Cable loss: Max 450 feet 734A, RG-59, 728A/Max 79 feet RG-179
 - AIS: TR-TSY-000191compliant
- Output:
 - Bit rate: 44.736 Mbps +/- 20 ppm
 - Frame format: DS-3 ANSI T1.107-1988
 - Line code: B3ZS
 - Termination: Unbalanced coaxial cable
 - Input impedance: 75 ohms +/-5%
 - Cable loss: Max 450 feet 734A, RG-59, 728A/Max 79 feet RG-179
 - AIS: TR-TSY-000191compliant
 - Power level: -1.8 to +5.7 dBm

- Pulse shape: ANSI T1.102-1988 Figure 8
- Pulse amplitude: 0.36 to 0.85 V peak-to-peak
- Loopback modes: Terminal and facility
- Line build out: 0 to 225 feet; 226 to 450 feet
- Interface: BNC or SMB connectors
- Surge protection: Telcordia GR-1089
- Operating temperature:
 - C-Temp (15454-DS3XM-6): 0 to +55 degrees Celsius (0 to 131 degrees Fahrenheit)
 - I-Temp (15454-DS3XM-6-T): –40 to +65 degrees Celsius (–40 to 149 degrees Fahrenheit)



Note The I-Temp symbol is displayed on the faceplate of an I-Temp compliant card. A card without this symbol is C-Temp compliant.

- Operating humidity: 5 to 95%, noncondensing
- Power consumption: 20 W, 0.42 A, 68 BTU/hr
- Dimensions:
 - Height: 321.3 mm (12.650 in.)
 - Width: 18.2 mm (0.716 in.)
 - Depth: 228.6 mm (9.000 in.)
 - Card weight: 0.8 kg (1.8 lb)
- Compliance:
 - For compliance information, refer to the *Cisco Optical Transport Products Safety and Compliance Information*.

