



Cisco Network Convergence System 540 Large Density Routers Hardware Installation Guide

First Published: 2021-06-02

Americas Headquarters

Cisco Systems, Inc.
170 West Tasman Drive
San Jose, CA 95134-1706
USA
<http://www.cisco.com>
Tel: 408 526-4000
800 553-NETS (6387)
Fax: 408 527-0883



CONTENTS

CHAPTER 1

Safety Warnings 1

- Standard Warning Statements 1
- Safety Guidelines for Personal Safety and Equipment Protection 2
- Safety with Electricity 3
- Cautions and Regulatory Compliance Statements for NEBS 4
- Power Supply Considerations 5
 - Power Connection Guidelines 5
 - Guidelines for DC-Powered Systems 6
 - Guidelines for AC-Powered Systems 6
 - Preventing ESD Damage 6

CHAPTER 2

Cisco NCS 540 Large Density Routers Overview 9

- Features 9
- Specification 10
- Interface Naming 10
- Network Timing Interfaces 11
- GNSS Receiver 11
 - GNSS Receiver RF Input Requirements 11
- External Alarm Inputs 12
- Console 13
 - USB Console 13
- Online Insertion and Removal 13
- Supported Transceiver Modules 13

CHAPTER 3

Prepare for Installation 15

- General Precautions 15

Site Planning Checklist	16
Environmental Requirements	16
Airflow Guidelines	16
Recommended Airflow	18
Site Power Guidelines	18
Electrical Circuit Requirements	19
Site Cabling Guidelines	19
Asynchronous Terminal Connections	20
Interference Considerations	20
Electromagnetic Interference	20
Radio Frequency Interference	20
Lightning and AC Power Fault Interference	20
Tools and Equipment	20
Prepare Your Location	21
Prepare Yourself	22
Prepare Rack for Router Installation	23
Cabinet Selection Guidelines	23
Unpack the Cisco NCS 540 Large Density Routers	24

CHAPTER 4

Install the Device	29
Rack Compatibility	29
Rack Types	30
Set up Device on Rack	32
Rack Mount	32
Ground the Device	37
Install the AC Power Cables	38
Activate an AC Power Supply Module	39
Install the DC Power Cables	40
Activate a DC Power Supply Module	41
Port Connection Guidelines	41
Connect to the Console Port	42
Connect to the Management Ethernet Port	44
Connecting Timing Cables	45
Connecting a Cable to the Input 10MHz or 1PPS Interface	45

Connecting a Cable to the Output 10MHz or 1PPS Interface	46
Connecting a Cable to the GNSS Antenna Interface	46
Install and Remove Transceiver Module	47
Safety Precautions for Module Installation and Removal	47
Install and Remove SFP56, SFP28, SFP10, and SFP Modules	47
Bale Clasp SFP56, SFP28, SFP10, and SFP Module	49
Install a Bale SFP56, SFP28, SFP10, and SFP Module	49
Remove a Bale Clasp SFP56, SFP28, SFP10, and SFP Module	50
Install and Remove QSFP+, QSFP28, or QSFP-DD Transceiver Modules	51
Required Tools and Equipment	54
Install the 40-Gigabit QSFP+, 100-Gigabit QSFP28, or 200/400-Gigabit QSFP-DD Transceiver Module	54
Attach the Optical Network Cable	55
Removing the 40-Gigabit QSFP+, 100-Gigabit QSFP28, or 200/400-Gigabit QSFP-DD Transceiver Module	56
Connect Interface Ports	57
Connect a Fiber-Optic Port to the Network	57
Disconnect Optical Ports from the Network	57
Maintain Transceivers and Optical Cables	58

CHAPTER 5
Configure the Device 59

Create the Initial Router Configuration	59
Verify Device Installation	61

CHAPTER 6
Replace Power Supply 63

Remove the DC Power Supply Module	63
Install the DC Power Supply Module	64
Remove the AC Power Supply Module	65
Install the AC Power Supply Module	65

CHAPTER 7
Appendix 67

LEDs	67
Router LEDs	67
System Fans LED	68

Power Status LEDs	69
Power Supply LEDs (PM0/PM1)	69
Front Panel Power LED and Fan LED Combination	70
System Specifications	70
Weight and Power Consumption	71
Environmental Specifications	71
Transceiver and Cable Specifications	71
RJ-45 Connectors	71
Console Port Pinouts	71
Management Ethernet Port Pinouts	72
Timing Port Pinouts	72
Time-of-Day Port Pinouts	73
USB Port Pinouts	73
Alarm Port Pinouts	74
AC Power Cord Specifications	74



CHAPTER 1

Safety Warnings

This handout lists the safety warnings necessary for handling this chassis. Before you install or service the chassis, review these safety warnings to avoid injuring yourself or damaging the equipment.

For a complete list of translated safety warnings, see the [Regulatory Compliance and Safety Information — Cisco NCS 500 Series Routers document](#).

The safety warnings are grouped under the following sections:

- [Standard Warning Statements, on page 1](#)
- [Safety Guidelines for Personal Safety and Equipment Protection, on page 2](#)
- [Safety with Electricity, on page 3](#)
- [Cautions and Regulatory Compliance Statements for NEBS, on page 4](#)
- [Power Supply Considerations, on page 5](#)
- [Preventing ESD Damage, on page 6](#)

Standard Warning Statements



Warning IMPORTANT SAFETY INSTRUCTIONS

This warning symbol means danger. You are in a situation that could cause bodily injury. Before you work on any equipment, be aware of the hazards involved with electrical circuitry and be familiar with standard practices for preventing accidents. Use the statement number provided at the end of each warning to locate its translation in the translated safety warnings that accompanied this device. Statement 1071

SAVE THESE INSTRUCTIONS



Warning This unit is intended for installation in restricted access areas. A restricted access area can be accessed only by using a special tool, lock and key, or other means of security. Statement 1017

Warning Ultimate disposal of this product must be handled according to all national laws and regulations. Statement 1040



Warning To prevent the system from overheating, do not operate it in an area that exceeds the maximum recommended ambient temperature of -40C to +65C. Statement 1047



Warning Mount the device on a rack that is permanently affixed to the building. Statement 1049



Warning This device is a Class A Device and is registered for EMC requirements for industrial use. You must be aware. If sold or purchased by mistake, do replace with a residential-use type. Statement 294



Warning This equipment needs to be grounded. Use a green and yellow 6AWG ground wire to connect the host to earth ground during normal use. Statement 383



Warning Do not stare into the beam or view it directly with optical instruments. Statement 1011



Warning Invisible laser radiation present. Statement 1016



Warning The plug-socket combination must be accessible at all times, because it serves as the main disconnecting device. Statement 1019

Safety Guidelines for Personal Safety and Equipment Protection

The following guidelines ensure your safety and protect the equipment. This list does not include all the potentially hazardous situations. Therefore, you must be alert.

- Before moving the system, always disconnect all power cords and interface cables.
- Never assume that power is disconnected from a circuit; always check.
- Before and after installation, keep the chassis area clean and dust free.
- Keep tools and assembly components away from walk areas where you or others can trip over them.
- Do not work alone if potentially hazardous conditions exist.
- Do not perform any action that creates a potential hazard to people or makes the equipment unsafe.
- Do not wear loose clothing that may get caught in the chassis.
- When working under conditions that may be hazardous to your eyes, wear safety glasses.

Safety with Electricity



Warning Before working on a chassis or with power supplies, unplug the power cord on AC units. Disconnect the power at the circuit breaker on DC units. Statement 12



Warning Before working on equipment that is connected to power lines, remove jewelry (including rings, necklaces, and watches). Metal objects heat up when connected to power and ground and can cause serious burns or weld the metal object to the terminals. Statement 43



Warning Read the installation instructions before connecting the system to the power source. Statement 1004



Warning The plug-socket combination must be accessible always, because it serves as the main disconnecting device. Statement 1019



Warning

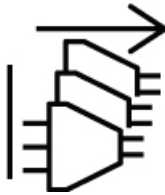

This unit may have more than one power supply connection. All connections must be removed to de-energize the unit. Statement 1028



Warning When installing or replacing the unit, ensure the ground connection first and disconnected last. Statement 1046



Warning This equipment is intended to be grounded to comply with emission and immunity requirements. Ensure that the switch functional ground lug is connected to earth ground during normal use. Statement 1064



Warning Installation of the equipment must comply with local and national electrical codes. Statement 1074

When working on equipment that is powered by electricity, follow these guidelines:

- Locate the room's emergency power-off switch. If an electrical accident occurs, you know where to quickly turn off the power.
- Before starting work on the system, turn off the DC main circuit breaker and disconnect the power terminal block cable.
- Disconnect all power when:
 - Working on or near power supplies
 - Installing or removing a device chassis or network processor module
 - Performing most hardware upgrades
- Never install equipment that appears damaged.
- Carefully examine your work area for possible hazards, such as moist floors, ungrounded power extension cables, and missing safety grounds.
- Never assume that power is disconnected from a circuit; always check.
- Never perform any action that creates a potential hazard to people or makes the equipment unsafe.
- If an electrical accident occurs and you are uninjured:
 - Use caution to avoid injuring yourself.
 - Turn off power to the device.
 - Seek medical attention, if necessary.

Use the following guidelines when working with any equipment that is disconnected from a power source, but connected to telephone wiring or network cabling:

- When installing or modifying telephone lines, use caution.
- Never install telephone jacks in wet locations unless the jack is designed to handle such locations.
- Never install telephone wiring during a lightning storm.

Cautions and Regulatory Compliance Statements for NEBS

The NEBS-GR-1089-CORE regulatory compliance statements and requirements are discussed in this section.



Warning

The intrabuilding port(s) of the equipment or subassembly, which is the management Ethernet port, must use shielded intrabuilding cabling/wiring that is grounded at both ends. Statement 7003

**Warning**

The intrabuilding port(s) of the equipment or subassembly, which is the management Ethernet port, must not be metallically connected to interfaces that connect to the OSP or its wiring. These interfaces are designed for use as intrabuilding interfaces only (Type 2 or Type 4 ports as described in GR-1089-CORE) and require isolation from the exposed OSP cabling. The addition of Primary Protectors is not sufficient protection in order to connect these interfaces metallically to OSP wiring. Statement 7005

**Warning**

This equipment shall be connected to AC mains provided with a surge protective device (SPD) at the service equipment complying with NFPA 70, the National Electrical Code (NEC). Statement 7012

**Warning**

This equipment is suitable for installations utilizing the Common Bonding Network (CBN). Statement 7013

**Warning**

The battery return conductor of this equipment shall be treated as (DC-I). Statement 7016

**Warning**

This equipment is suitable for installation in Network Telecommunications Facilities. Statement 8015

**Warning**

This equipment is suitable for installation in locations where the NEC applies. Statement 8016

Power Supply Considerations

Check the power at your site to ensure that you are receiving clean power (free of spikes and noise). If necessary, install a power conditioner.

Power Connection Guidelines

This section provides guidelines for connecting the device power supplies to the site power source.

**Warning**

Never defeat the ground conductor or operate the equipment in the absence of a suitably installed ground conductor. Contact the appropriate electrical inspection authority or an electrician if you are uncertain that suitable grounding is available. Statement 1024

**Warning**

The plug-socket combination must be accessible always because it serves as the main disconnecting device. Statement 1019

**Warning**

This product requires short-circuit (overcurrent) protection, to be provided as part of the building installation. Install only in accordance with national and local wiring regulations. Statement 1045

Guidelines for DC-Powered Systems

Basic guidelines for DC-powered systems include the following:

- Each chassis power supply has its own dedicated input power source. The source must comply with the safety extra-low voltage (SELV) requirements in the UL 60950, CSA 60950, EN 60950, and IEC 60950 standards.
- Protect the circuit by a dedicated two-pole circuit breaker. Ensure that the circuit breaker is 12A rated.
- The circuit breaker is considered as the disconnect device and is easily accessible.
- The system ground is the power supply and chassis ground.
- Use the grounding lug to attach a wrist strap for ESD protection during servicing.
- Do not connect the DC return wire to the system frame or to the system-grounding equipment.
- Ensure that the DC return is grounded at the source side.

Guidelines for AC-Powered Systems

Basic guidelines for AC-powered systems include the following:

- Each chassis power supply has its own dedicated branch circuit.
- Ensure that the circuit breaker is 7A rated.
- The AC power receptacles that are used to plug in the chassis must be the grounding type. The grounding conductors that connect to the receptacles must connect to protective earth ground at the service equipment.

Preventing ESD Damage

Electrostatic Discharge (ESD) can damage equipment and impair electrical circuitry. ESD may occur when electronic printed circuit cards are improperly handled and can cause complete or intermittent failures. When removing and replacing modules, always follow these ESD prevention procedures:

- Ensure that the device chassis is electrically connected to earth ground.
- Wear an ESD-preventive wrist strap, ensuring that it makes good skin contact. To channel unwanted ESD voltages safely to ground, connect the clip to an unpainted surface of the chassis frame. To guard against ESD damage and shocks, the wrist strap and cord must operate effectively.
- If no wrist strap is available, ground yourself by touching a metal part of the chassis.
- When installing a component, use any available ejector levers or captive installation screws to properly seat the bus connectors in the backplane or midplane. These devices prevent accidental removal, provide proper grounding for the system, and help to ensure that bus connectors are properly seated.
- When removing a component, use available ejector levers or captive installation screws, if any, to release the bus connectors from the backplane or midplane.
- Handle components by only their handles or edges; do not touch the printed circuit boards or connectors.

- Place a removed component board side up on an antistatic surface or in a static-shielding container. If you plan to return the component to the factory, immediately place it in a static-shielding container.
- Avoid contact between the printed circuit boards and clothing. The wrist strap only protects components from ESD voltages on the body; ESD voltages on clothing can still cause damage.
- Never attempt to remove the printed circuit board from the metal carrier.

For the safety of your equipment, periodically check the resistance value of the antistatic wrist strap. Maintain the value between 1 and 10 Mohm.



CHAPTER 2

Cisco NCS 540 Large Density Routers Overview

Cisco NCS 540 large density router is a 1RU, cost optimized platform supporting QSFP56-DD ports, that offers customers 400G coherent transport solution. NCS 540 large density platform enhances the existing NCS 540 portfolio offering high throughput and flexible 400/200/100/50/40/25/10/1GE interfaces.

For more information about its features and benefits, see the *Cisco Network Convergence System 540 Large Density Routers Datasheet*

- [Features, on page 9](#)
- [Specification, on page 10](#)
- [Interface Naming, on page 10](#)
- [Network Timing Interfaces, on page 11](#)
- [GNSS Receiver, on page 11](#)
- [External Alarm Inputs, on page 12](#)
- [Console, on page 13](#)
- [Online Insertion and Removal, on page 13](#)
- [Supported Transceiver Modules, on page 13](#)

Features

The key features include:

- 1RU small form factor with depth 299mm
- Front-to-back airflow
- Environmental hardened, suitable for deployments in indoor or outdoor sealed cabinets
- Low latency forwarding, Class C compliant
- 400G/100G ZR/ZR+ optics support
- Integrated GNSS receiver

The Cisco N540-24Q8L2DD-SYS router has the following hardware features:

- 2 x 40G/100G/200G/400G QDD ports
- 8 x 1G/10G/25G/50G SFP56 ports
- 24 x 1G/10G/25G SFP28 ports

Figure 1: N540-24Q8L2DD-SYS Front View

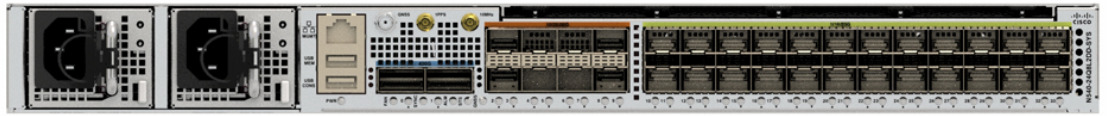

521699

Figure 2: N540-24Q8L2DD-SYS Rear View

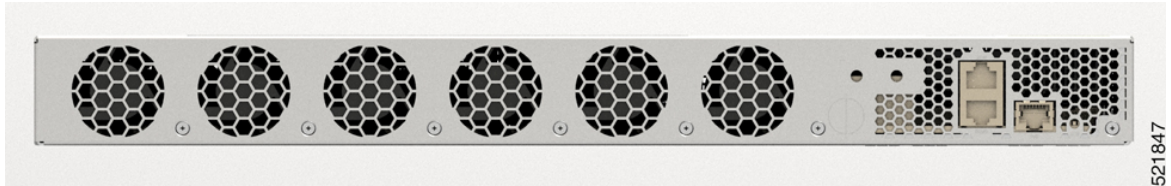

521847

Specification

For information on physical specification, temperature, Route Processor, and other details, see *Cisco NCS 540 chassis specification* in the *Cisco Network Convergence System 540 Large Density Routers Data Sheet*.

Interface Naming

The following table shows the interface naming of the N540-24Q8L2DD-SYS:

Table 1: Port Numbering

40G/100G/200G/400G (QDD)		1G/10G/25G/50G (SFP56)			1G/10G/25G (SFP28)		
0	1	2	to	8	10	to	32
		3		9	11		33

The interface-path-id is rack/slot/module/port. The slashes between values are required as part of the notation.



Note Multi-rate functionality is supported only with the supported SFP.

Table 2: Maximum Number of Interfaces for Cisco N540-24Q8L2DD-SYS

Category	Maximum Port Number Interface	Port Number
1GE	32	0/2-0/33
10GE	32	0/2-0/33

Category	Maximum Port Number Interface	Port Number
25GE	32	0/2-0/33
40GE	2	0/0-0/1
50GE	8	0/2-0/9
100GE	2	0/0-0/1
200GE	2	0/0-0/1
400GE	2	0/0-0/1

Network Timing Interfaces

- 1PPS input or output and ToD input or output—This shielded RJ-45 interface is used for input or output of time-of-day (ToD) and 1PPS pulses. ToD format includes both NTP and IEEE 1588-2008 time formats.

The same RS422 pins for 1PPS and TOD are shared between input and output directions. The direction for each can be independently configurable through software.

Use an SMB connector on the front panel for the following:

- Timing 10Mhz input and output—10MHz input for timing synchronization
- Timing 1 PPS input and output—1 PPS input for timing synchronization

GNSS Receiver

The chassis has in-built GNSS receiver with SMA connector present at the front panel. GNSS supports the following constellations:

- GPS
- Galileo
- Glonass
- BeiDou

GNSS Receiver RF Input Requirements

- The antenna connector specification is as follows:
 - SMA Female 50 Ohm connector
 - 50 Ohm antenna cable with SMA Male connector

- For optimal performance, the GNSS receiver requires an active GNSS antenna with built-in Low-Noise Amplifier (LNA). The antenna LNA amplifies the received satellite signals for two purposes:
 - Compensation of losses on the cable
 - Lifting the signal amplitude to the suitable range for the receiver frontend

The Amplification required is 22dB gain + cable/connector loss + Splitter signal loss.

The recommended range of LNA gain (minus all cable and connector losses) at the connector of the receiver module is 22dB to 30dB with a minimum of 20dB and a maximum of 35dB.

- GNSS receiver provides 5V to the active antenna through the same RF input.
- Surge requirement:
 - GNSS receivers have built-in ESD protections on all pins, including the RF-input pin. However, additional surge protection may be required if rooftop antennas are to be connected, to meet the regulations and standards for lightning protection of countries where the end-product is installed.
 - A lightning protection must be mounted at the place where the antenna cable enters the building. The primary lightning protection must be capable of conducting all potentially dangerous electrical energy to Protection Earth or Protection Ground (PE).
 - Surge arrestors should support DC-pass and suitable for the timing frequency range (1.575GHz) with low attenuation.
- Antenna Sky visibility:
 - Timing signals can only be received on a direct line of sight between antenna and satellite. The antenna must have a clear view of the sky. For proper timing, minimum of four satellites should be locked.



Note The antenna terminal should be earthed at the building entrance in accordance with the ANSI/NFPA 70, the National Electrical Code (NEC), in particular Section 820.93, Grounding of Outer Conductive Shield of a Coaxial Cable.

- Use a passive splitter if more than one GNSS receivers are fed from a single antenna.



Note The splitter should have all the RF ports capable of DC-pass, if the antenna needs to feed power from GNSS receiver.

External Alarm Inputs

The router supports four dry contact alarm inputs through an RJ-45 jack at the rear panel.

- Normally Open—indicates that no current flows through the alarm circuit and the alarm is generated when the current is flowing.

Each alarm input can be provisioned as critical, major, or minor.

Console

The RS232 console port, connected through RJ-45 jack at rear panel, provides transmission (Tx), reception (Rx), and ground (Gnd).

USB Console

A single USB 2.0 and 3.0 Type-A receptacle on the front panel of the router provides console access to Cisco IOS XR, and diagnostics. While it uses the Type-A connector, it operates as a USB peripheral only for connection to an external host computer.



Note Use of the USB console is mutually exclusive of the RS232 console port. This interface requires the use of a Type-A to Type-A USB cable.

Online Insertion and Removal

The router supports the following Online Insertion and Removal (OIR) operations:

- When an QSFP-DD/QSFP28 is removed, there is no effect on traffic flowing on other ports.
- When an QSFP-DD/QSFP28 is installed, the system initializes that port for operation based on the current configuration. If the inserted QSFP-DD/QSFP28 is incompatible with the current configuration of that port, the port does not become operational until the configuration is updated.
- When both power supplies are installed and active, the load may be shared between them or a single PSU supports the whole load. When a power supply is not working or the input cable is removed, the remaining power supply takes the entire load without disruption.

Supported Transceiver Modules

For more information on the supported transceiver modules, see [Transceiver Module Group \(TMG\) Compatibility Matrix](#). In the **Begin your Search** search box, enter the keyword and click **Enter**.



CHAPTER 3

Prepare for Installation

Before you install the Cisco NCS 540 large density routers, you must prepare your site for installation.

Preparing your site involves these tasks:

- [General Precautions, on page 15](#)
- [Site Planning Checklist, on page 16](#)
- [Environmental Requirements, on page 16](#)
- [Airflow Guidelines, on page 16](#)
- [Recommended Airflow, on page 18](#)
- [Site Power Guidelines, on page 18](#)
- [Site Cabling Guidelines, on page 19](#)
- [Interference Considerations, on page 20](#)
- [Tools and Equipment, on page 20](#)
- [Prepare Your Location , on page 21](#)
- [Prepare Yourself , on page 22](#)
- [Prepare Rack for Router Installation, on page 23](#)
- [Cabinet Selection Guidelines, on page 23](#)
- [Unpack the Cisco NCS 540 Large Density Routers, on page 24](#)

General Precautions

Observe the following general precautions when using and working with your router:

- Keep your system components away from radiators and heat sources, and do not block cooling vents.
- Do not spill food or liquids on your system components, and never operate the product in a wet environment.
- Do not push any objects into the openings of your system components. Doing so can cause fire or electric shock by shorting out interior components.
- Position system cables and power supply cable carefully. Route system cables, the power supply cable, and plug so that they are not stepped on or tripped over. Be sure that nothing else rests on your system component cables or power cable.
- Do not modify power cables or plugs. Consult a licensed electrician or your power company for site modifications. Always follow your local and national wiring rules.

- If you turn off your system, wait at least 30 seconds before turning it on again to avoid damage to the system components.

Site Planning Checklist

Use the following checklist to perform and account for all the site planning tasks described in this chapter:

- The site meets the environmental requirements.
- The site's air conditioning system can compensate for the heat dissipation of the router.
- The floor space that the router occupies can support the weight of the system.
- Electrical service to the site complies with the requirements.
- The electrical circuit servicing the router complies with the requirements.
- Consideration has been given to the console port wiring and limitations of the cabling involved, according to TIA/EIA-232F.
- The router Ethernet cabling distances are within the prescribed limitations.
- The equipment rack in which you plan to install the router complies with prescribed requirements.
- The following factors have been carefully considered when selecting the location of the rack: safety, ease of maintenance, and proper airflow.

Environmental Requirements

For outside plant installation (cell site cabinet, hut, and so on), you must protect the router against airborne contaminants, dust, moisture, insects, pests, corrosive gases, polluted air, or other reactive elements. Sealed equipment chamber with air-conditioning or a heat exchanger is recommended for OSP deployments. The equipment chamber must comply with the temperature and clearance requirements. Sealed equipment chamber with air-conditioning or a heat exchanger is recommended for OSP deployments. Examples of such cabinets include IP66 cabinets with heat exchanger complying with Telcordia GR487. Temperature must be maintained within -40°C to 65°C .

The equipment shall be placed inside an enclosure (that is protected from direct outside weather and environmental stresses by the enclosure), and where the operating climate, as defined by Class 2 of GR-3108-CORE, is between:

- -40 to 158°F (-40 to 65°C)
- 5% and 85% RH

For more information on environmental properties and regulatory standards, see the *Cisco Network Convergence System 540 Large Density Routers Data Sheet*.

Airflow Guidelines

Cool air is circulated through the router by fans that are located along the rear side of the router. The internal fans maintain acceptable operating temperatures for the internal components by drawing in cool air through the vents, and circulating the air through the router.

To ensure adequate airflow, we recommended that you always maintain this minimum clearance distance:

- Front clearance—5 inches (12.7 centimeters)
- Rear clearance—2 inches (5.08 centimeters)

Figure 3: Airflow Side View for N540-24Q8L2DD-SYS

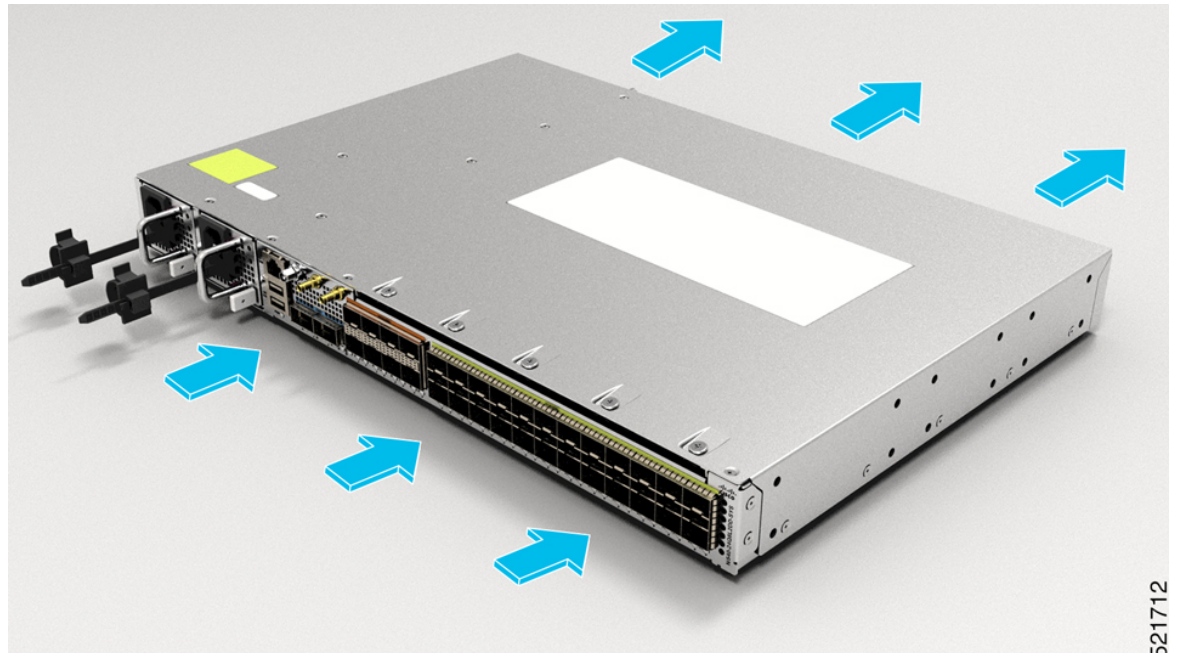

521712

Note the following points:

- When installing the router in a back-to-back position with another device, ensure that there is a minimum of 3.9 inches (10 centimeters) airflow clearance between the two devices.
- If airflow through the equipment rack and the routers that occupy it is blocked or restricted, or if the ambient air being drawn into the rack is too warm, an overtemperature condition may occur within the rack and the routers that occupy it.
- The site must be as dust-free as possible. Dust tends to clog the router fans, reducing the flow of cooling air through the equipment rack and the routers that occupy it, thereby increasing the risk of an overtemperature condition.
- Enclosed racks must have adequate ventilation. Ensure that the rack is not congested because each router generates heat. An enclosed rack must have louvered sides and a fan to provide cooling air. The equipment generates heat near the bottom of the rack, which can be drawn upward into the intake ports of the equipment above.
- When mounting a router in an open rack, ensure that the rack frame does not block the exhaust fans.
- When rack-installed equipment fails, especially equipment in an enclosed rack, try operating the equipment by itself, if possible. Power off all the other equipment in the rack (and in adjacent racks) to give the router maximum cooling air and clean power.
- Avoid installing the router in a location in which the router air intake vents may draw in the exhaust air from adjacent equipment. Consider how the air flows through the router; the airflow direction is front to back, with ambient air drawn in from the vents located on the sides of the router.

Recommended Airflow

The movement of air around the router should not be more than 1 m/s from 5 inches front clearance.

Site Power Guidelines

The chassis has specific power and electrical wiring requirements. Adhering to these requirements ensures the reliable operation of the system. Follow these precautions and recommendations when planning your site power for the chassis:

- The redundant power option provides a second, identical power supply to ensure uninterrupted power supply.
- Connect each power supply to a separate input power source. Otherwise, it results in a total power failure to the system due to a fault in the external wiring or a tripped circuit breaker.
- To prevent loss of input power, ensure that the maximum load on each circuit is within the current ratings of the wiring and the breakers.
- Check the power at your site before installation, and periodically after installation, to ensure that you are receiving clean power. If necessary, install a power conditioner.
- Provide proper grounding to avoid personal injury and damage to the equipment due to power surges or lightning striking power lines. The chassis ground must be attached to a central office or other interior ground system.



Warning

This product requires short-circuit (overcurrent) protection to be provided as part of the building installation. Install only in accordance with national and local wiring regulations. Statement 1045



Caution

This product requires external surge protection device for both AC and DC power feeds to the equipment. For DC power feed, the surge protective device (SPD) must handle common mode and differential mode surge as per the local standards.



Note

The chassis installation must comply with all the applicable codes, and is approved for use with only copper conductors. The ground bond-fastening hardware must be compatible and preclude loosening, deterioration, and electrochemical corrosion of hardware and joined material. Attachment of the chassis ground to a central office or other interior ground system must be made with a 6-AWG gauge wire copper ground conductor.



Note The AC PSU requires external surge protection devices for installations where electrical surges higher than 2KV common mode and 2KV differential mode are expected. Failure to do so can result in permanent damage to the product.

The DC PSU requires external surge protection devices for installations where electrical surges higher than 2KV common mode and 1KV differential mode are expected. Failure to do so can result in permanent damage to the product.

Electrical Circuit Requirements

Each router requires a dedicated electrical circuit. If you equip the router with dual-power feeds, provide a separate circuit for each power supply to avoid compromising the power redundancy feature.

The routers can be powered by a DC source. Ensure that equipment grounding is present and observe the power-strip ratings. Make sure that the total ampere rating of all the products plugged into the power strip does not exceed 80% of the rating.

Site Cabling Guidelines

This section contains guidelines for wiring and cabling at your site. When preparing your site for network connections to the router, consider the type of cable required for each component, and the cable limitations. Consider the distance limitations for signaling, ElectroMagnetic Interference (EMI), and connector compatibility. Possible cable types are fiber, thick or thin coaxial, foil twisted-pair, or unshielded twisted-pair cabling.

Also consider any additional interface equipment you need, such as transceivers, hubs, switches, modems, Channel Service Units (CSU), or Data Service Units (DSU).

Before you install the router, have all the additional external equipment and cables on hand. For information about ordering, contact a Cisco customer service representative.

The extent of your network and the distances between the network interface connections depend, in part, on the following factors:

- Signal type
- Signal speed
- Transmission medium

The distance and rate limits referenced in the following sections are the IEEE-recommended maximum speeds and distances for signaling purposes. Use this information as a guideline when planning your network connections *prior to* installing the router.

If wires exceed the recommended distances, or if wires pass between buildings, give special consideration to the effect of a lightning strike in your vicinity. The electromagnetic pulse caused by lightning or other high-energy phenomena can easily couple enough energy into unshielded conductors to destroy electronic devices. If you have had problems of this sort in the past, you may want to consult experts in electrical surge suppression and shielding.

Asynchronous Terminal Connections

The router provides a console port to connect a terminal or computer for local console access. The router supports RS-232 asynchronous data with distance recommendations specified in the IEEE RS-232 standard.

Interference Considerations

When wires are run for any significant distance, there is a risk that stray signals will be induced on the wires as interference. If interference signals are strong, they may cause data errors or damage to the equipment.

The following sections describe the sources of interference and how to minimize their effects on the router system.

Electromagnetic Interference

All the equipment powered by AC current can propagate electrical energy that can cause EMI and possibly affect the operation of other equipment. The typical sources of EMI are equipment power cords and power service cables from electric utility companies.

Strong EMI can destroy the signal drivers and receivers in the router and even create an electrical hazard by causing power surges through the power lines into installed equipment. These problems are rare, but could be catastrophic.

To resolve these problems, you need specialized knowledge and equipment that could consume substantial time and money. However, you can ensure that you have a properly grounded and shielded electrical environment, paying special attention to the need for electrical surge suppression.

Radio Frequency Interference

When electromagnetic fields act over a long distance, Radio Frequency Interference (RFI) may be propagated. Building wiring can often act as an antenna, receiving the RFI signals and creating more EMI on the wiring.

If you use twisted-pair cable in your plant wiring with a good distribution of grounding conductors, the plant wiring is unlikely to emit radio interference. If you exceed the recommended distances, use a high-quality twisted-pair cable with one ground conductor for each data signal.

Lightning and AC Power Fault Interference

If signal wires exceed the recommended cabling distances, or if signal wires pass between buildings, you should consider the effect that a lightning strike in your vicinity might have on the router.

The Electromagnetic Pulse (EMP) generated by lightning or other high-energy phenomena can couple enough energy into unshielded conductors to damage or destroy electronic equipment. If you have previously experienced such problems, you should consult with RFI and EMI experts to ensure that you have adequate electrical surge suppression and shielding of signal cables in your router operating environment.

Tools and Equipment

You need the following tools and equipment to install and upgrade the router and its components:

- ESD-preventive cord and wrist strap
- Antistatic mat or antistatic foam
- Number 1 and Number 2 Phillips-head screwdrivers
- #12-24 pan-head screws to secure the router to the equipment rack
- Cables for connecting to the network ports (depending on the configuration)

For more information about cable specifications, see the *Troubleshooting* section.

- Ethernet hub, switch, or PC with a network interface card for connecting to the Ethernet ports
- Console terminal (an ASCII terminal or a PC running terminal emulation software) that is configured for 115200 baud, 8 data bits, no parity, no flow control, and 1stop bit
- Console cable for connecting to the console port
- Ratcheting torque screwdriver with a Phillips head that exerts up to 30-pound force per square inch (in-lb) or 0.02-kilograms force per square millimeter (kgf/mm²) of pressure
- Crimping tool as specified by the ground lug manufacturer
- Wire-stripping tools for stripping both 6-AWG and 14-AWG wires
- Tape measure and level



Warning

Only trained and qualified personnel should be allowed to install, replace, or service this equipment. Statement 1030

Prepare Your Location

This section illustrates how the building that houses the chassis must be properly grounded to the earth ground.

Figure 4: Building with Rack Room Connected to Earth Ground

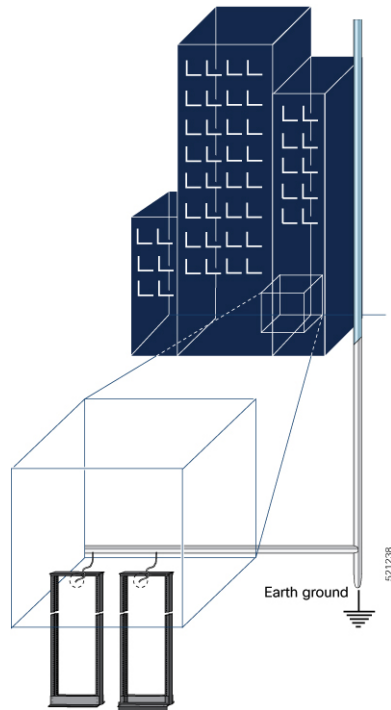

Prepare Yourself

This section illustrates how to prepare yourself before removing the chassis from the sealed antistatic bag. The figures show how to wear the ESD strap around the wrist and how to connect the other end of the strap to the ground. ESD wrist straps are the primary means of controlling static charge on personnel.

Note: These images are for only representation purposes. The chassis' actual appearance and size would vary.

Figure 5: Wearing the ESD Strap

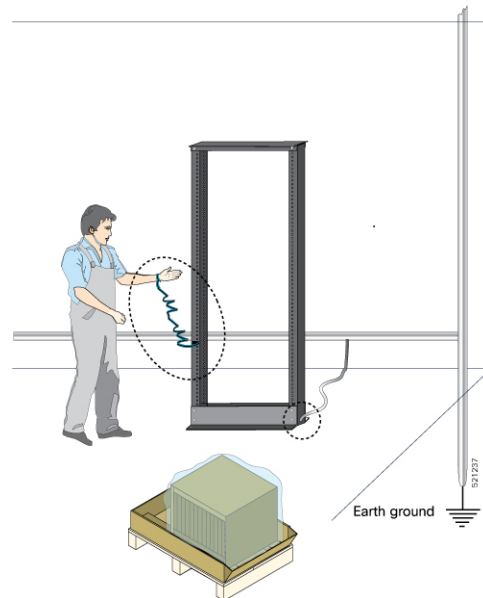

Prepare Rack for Router Installation

Install the chassis into a two-post standard rack with standard horizontal mounting rails. Before you mount the chassis into the rack, we recommend that you do the following:

Step 1 Place the rack where you plan to install the chassis. Ensure that the rack is grounded to earth.

Step 2 Secure the rack to the floor.

To bolt the rack to the floor, a floor bolt kit (also called an anchor embedment kit) is required. For information on bolting the rack to the floor, consult a company that specializes in floor mounting kits (such as Hilti; see Hilti.com for details). Make sure that floor mounting bolts are accessible, especially if an annual retorquing of bolts is required.

Cabinet Selection Guidelines

Equipment that is intended for installation in controlled environmental space has average yearly levels of contamination. Ventilated cabinets or racks can be used if pollutant levels are maintained within allowable limits.

Equipment intended for installation in outside plant (OSP) areas must have sealed cabinets with heat exchanger that meet the IP66 or IP65 protection and low average yearly levels of concentration of contaminants inside the cabinet.



Note Ventilated cabinets and racks are not recommended for OSP applications.

Table 3: Cabinet Type for Indoor and Outdoor Installation

Cabinet Type	Suitable for Indoor Installation?	Suitable for Outdoor Installation?
Open rack with no front and rear doors	Yes	No
Ventilated cabinets with normal air filter at intake and fans	Yes	No
Sealed cabinets with heat exchanger that meet NEMA -4 or IP66 protection	Yes	Yes
Sealed cabinets with air-conditioners that meet NEMA -4 or IP66/IP65 protection	Yes	Yes

Allowable limits for Environmental Pollutants

Concentration of pollutant levels in outdoor and indoor environment must be less than pollutant levels mentioned in Table 2.3 and Table 2.4 of *NEBS GR-63-CORE Issue 5 Dec 2017*, respectively. High concentrations of pollutants have a negative impact on the equipment life time.

Allowable Temperature and Humidity

Maximum allowable temperature and humidity levels must be within the values that are mentioned in the data sheets. Do not install in places where condensation may occur, or where equipment is exposed to high humidity for long time, such as near the sea, rivers, and large water bodies.

Installations in Highly-corrosive Environment

Installation in highly corrosive area is not recommended. Examples of highly corrosive areas are seashore, less than 10 meters from high traffics roadway, and areas having high industrial pollutants.

Periodic Measurement of Environmental Pollutants

We recommend that you check concentration of pollutants periodically. Necessary protection should be provided to ensure the equipment is not exposed to high concentration level of pollutants.

Unpack the Cisco NCS 540 Large Density Routers

Ensure that there is sufficient room around the chassis pallet for unpacking.

1. Remove the accessory tray and the packing material.
2. Carefully set the packing material aside.



Tip Be sure to save the packaging in case you need to return any of the components products.



Note These images are for only representation purposes. The chassis' actual appearance and size would vary.

Figure 6: Unpacking the Device

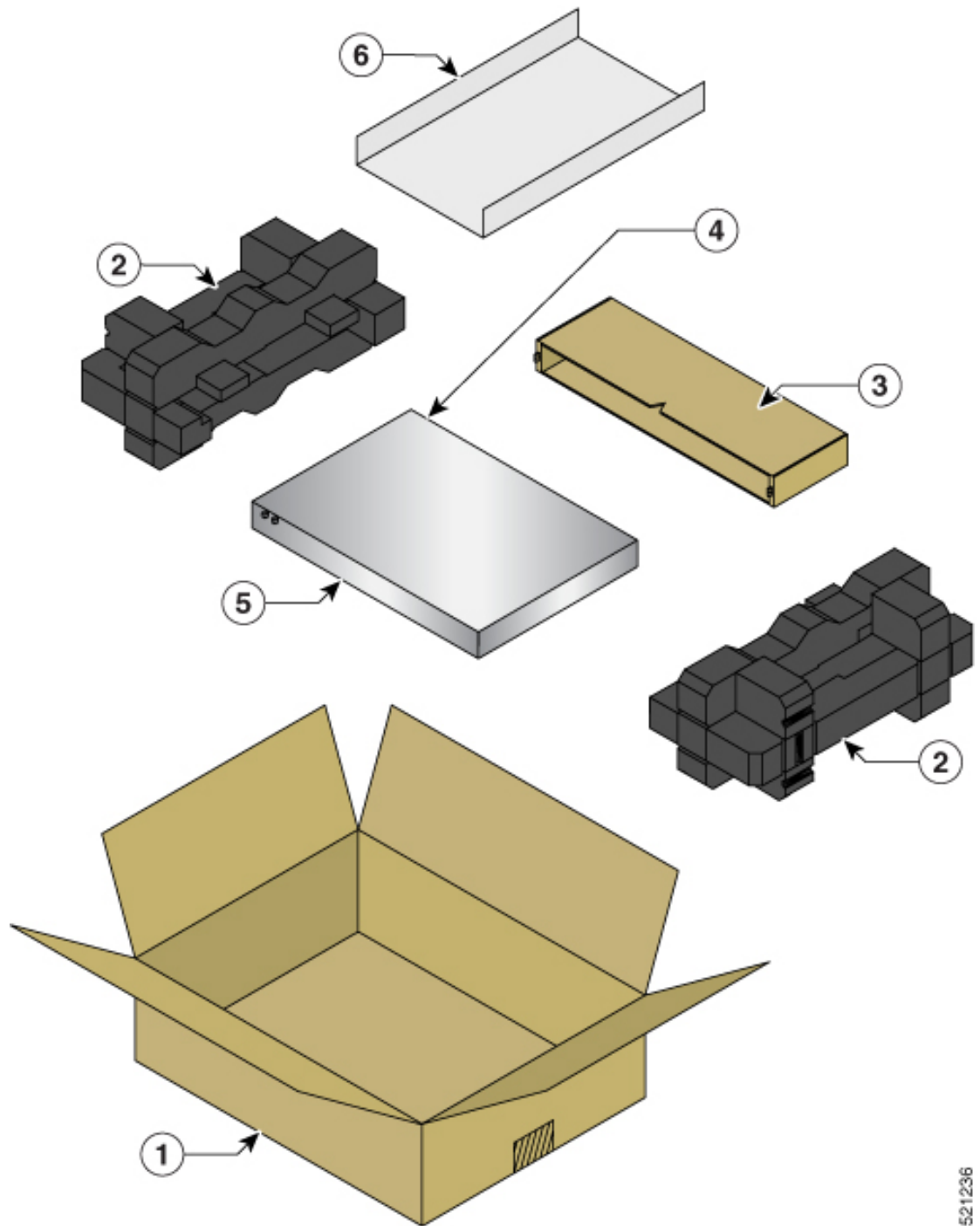

521236

1	Regular Slotted Container (shipping box)	2	Foam end caps
3	Front corrugated cap	4	Front end of the product
5	Back end of the product	6	Accessory tray

Table 4: Accessories Kit

19- inch Rack Mount Brackets	23- inch Rack Mount Brackets	ETSI Rack Mount Brackets	Wall Mount Brackets	Desktop Brackets	Cable Management Brackets
N540DD-RKM-19	N540-RKM-23-FHC	N540-RKM-ETSI-FHC	NA	NA	N540-CBL-BRKT-FHC



Note Most Cisco documentation is available online. The chassis Pointer Card that is shipped with your Cisco NCS 500 Series Services Routers contains links and information to other online documentation.



Note If the product is not in use, store the device in the initial packaged condition or in an ESD PE sealed bag with silica gel.



CHAPTER 4

Install the Device

Before you begin this task, ensure that you have read and understood the safety warnings in the *Standard Warning Statements* section of the *Safety Warnings* handout.

Installing the Cisco N540-24Q8L2DD-SYS involves these tasks:

- [Rack Compatibility, on page 29](#)
- [Set up Device on Rack, on page 32](#)
- [Ground the Device, on page 37](#)
- [Install the AC Power Cables, on page 38](#)
- [Install the DC Power Cables, on page 40](#)
- [Port Connection Guidelines , on page 41](#)
- [Connect to the Console Port , on page 42](#)
- [Connect to the Management Ethernet Port, on page 44](#)
- [Connecting Timing Cables, on page 45](#)
- [Connecting a Cable to the GNSS Antenna Interface, on page 46](#)
- [Install and Remove Transceiver Module, on page 47](#)
- [Install and Remove QSFP+, QSFP28, or QSFP-DD Transceiver Modules, on page 51](#)
- [Removing the 40-Gigabit QSFP+, 100-Gigabit QSFP28, or 200/400-Gigabit QSFP-DD Transceiver Module, on page 56](#)
- [Connect Interface Ports, on page 57](#)
- [Maintain Transceivers and Optical Cables, on page 58](#)

Rack Compatibility

We recommend that you follow these rack specifications.

Rack Types

Figure 7: Rack specification EIA (19 inches and 23 inches)

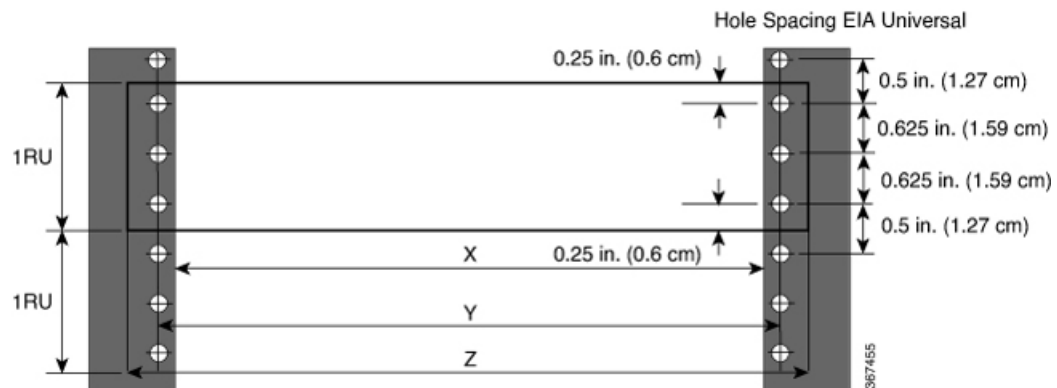

Table 5: Rack specification EIA (19 inches and 23 inches)



Post Type	Rack Type	Rack Front Opening (X)	Rack Mounting Hole Centre-Centre (Y)	Mounting Flange Dimension (Z)
4 Post	19 inches (48.3 centimeters)	17.75 inches (45 centimeters)	18.31 inches (46.5 centimeters)	19 inches (48.2 centimeters)
2 Post				
4 Post	23 inches (58.4 centimeters)	21.75 inches (55.24 centimeters)	22.31 inches (56.6 centimeters)	23 inches (58.4 centimeters)
2 Post				

Figure 8: Four Post Rack Type

4 – Post Type (Hole EIA Universal)		Width Available (X)	Compatibility
All 23" Type rack		552.45mm (21.75")	Yes
All ETSI rack (21" rack)		500.0mm (19.68")	Yes
19" Type rack L-Type Post		17.75" (450.8 mm)	Yes
		17.50" (444.5 mm)	No
19" Type Racks Flat-Post		17.75" (450.8 mm)	Yes
		17.50" (444.5 mm)	No
19" Type racks C- Type Post		17.75" (450.8 mm)	Yes
		17.50" (444.5 mm)	No

387456

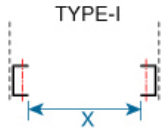
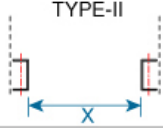
Figure 9: Two Post Rack Type

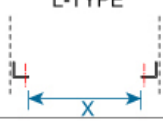
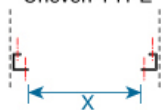
2 – Post Type (Hole EIA Universal)	X – 19" Rack	Compatibility	X-23" Rack	Compatibility
TYPE-I 	17.75" (450.8 mm)	Yes	21.75" (552.45mm)	Yes
	17.50" (444.5 mm)	No	21.75" (552.45mm)	Yes
TYPE-II 	17.75" (450.8 mm)	Yes	21.75" (552.45mm)	Yes
	17.50" (444.5 mm)	No	21.75" (552.45mm)	Yes
TYPE-III 	17.75" (450.8 mm)	Yes	21.75" (552.45mm)	Yes
	17.50" (444.5 mm)	No	21.75" (552.45mm)	Yes
L-TYPE 	17.75" (450.8 mm)	Yes	21.75" (552.45mm)	Yes
	17.50" (444.5 mm)	No	21.75" (552.45mm)	Yes
Uneven-TYPE 	17.75" (450.8 mm)	Yes	21.75" (552.45mm)	Yes
	17.50" (444.5 mm)	No	21.75" (552.45mm)	Yes

367457

Set up Device on Rack

You can set up the Cisco N540-24Q8L2DD-SYS on a rack.

Rack Mount

The device is shipped with rack mounting brackets that are to be secured on the sides of the device.



Note For rack mounting brackets details, refer to *Table 5*.



Caution If the rack is on wheels, ensure that the brakes are engaged or the rack is otherwise stabilized.

Table 6: Cisco N540-24Q8L2DD-SYS Router Rack-Mount Kit

Quantity	Part Description
2	Rack-mount brackets

Quantity	Part Description
8	M4 x 0.7 x 7-mm Phillips flat-head screws
4	12-24 x 0.49 inches L, Philips pan head screws

1. Attach the rack-mount brackets and the cable guides to the router as follows:
 - a. The router has port-side intake modules, position the router so that its ports are facing the cold aisle.
 - b. Position the bracket ears facing front or middle rack-mount, on the side of the chassis so that the holes are aligned.
 - c. Use four M4 screws to attach the brackets to the chassis.
 - d. Repeat Steps 1b and 1c with the other rack-mount bracket on the other side of the router.

Figure 10: Installing 19-inch Rack-Mount Brackets (N540DD-RKM-19)

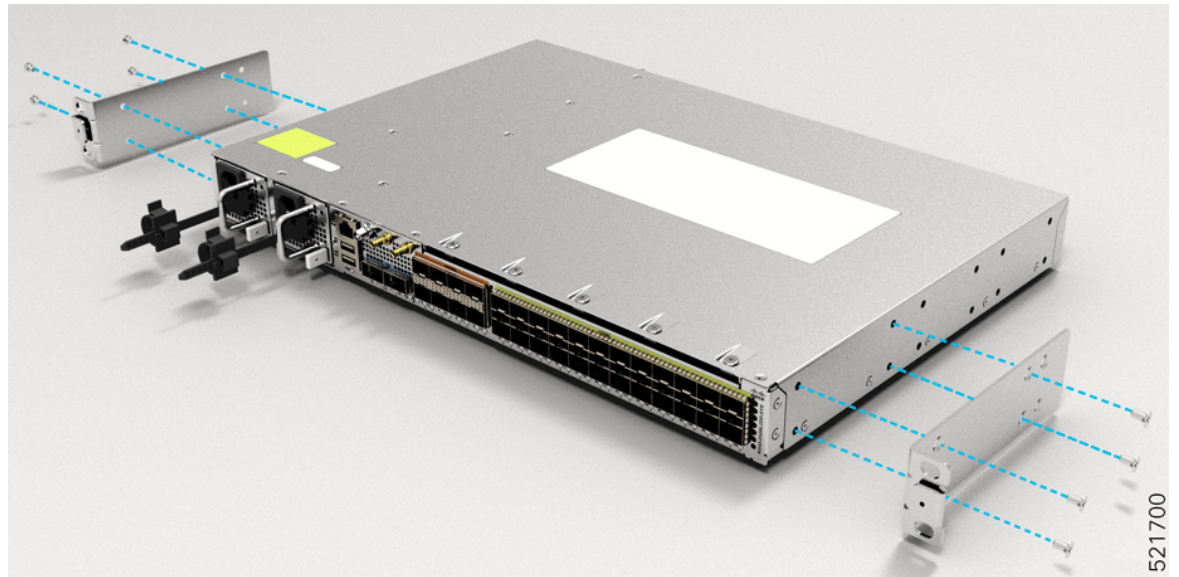
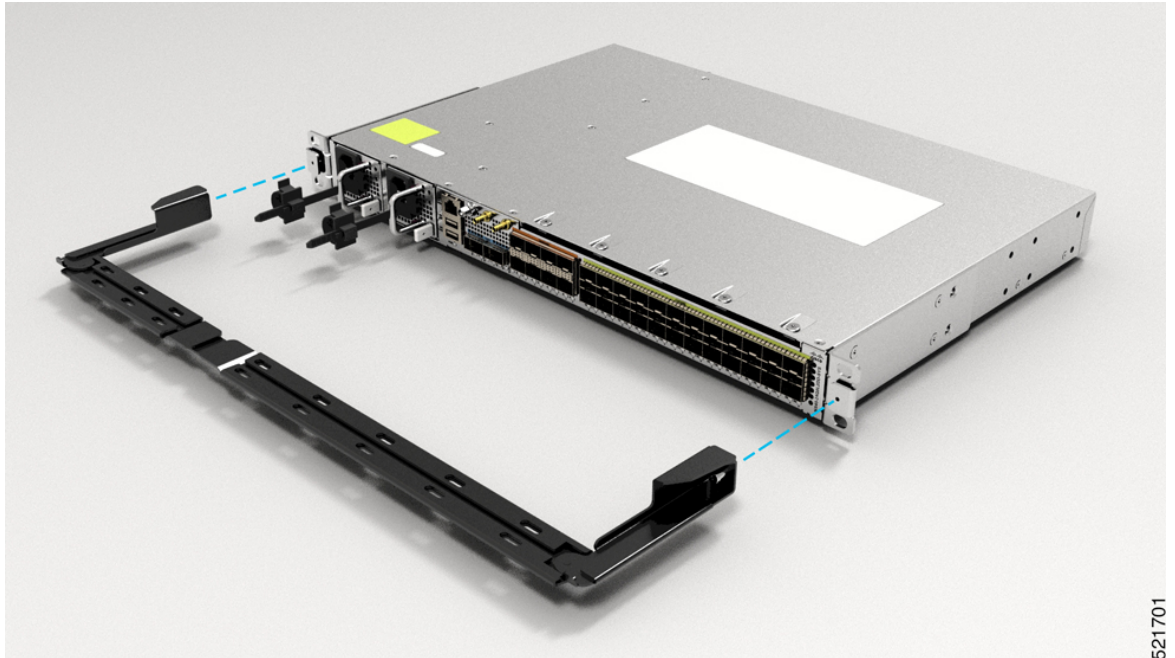
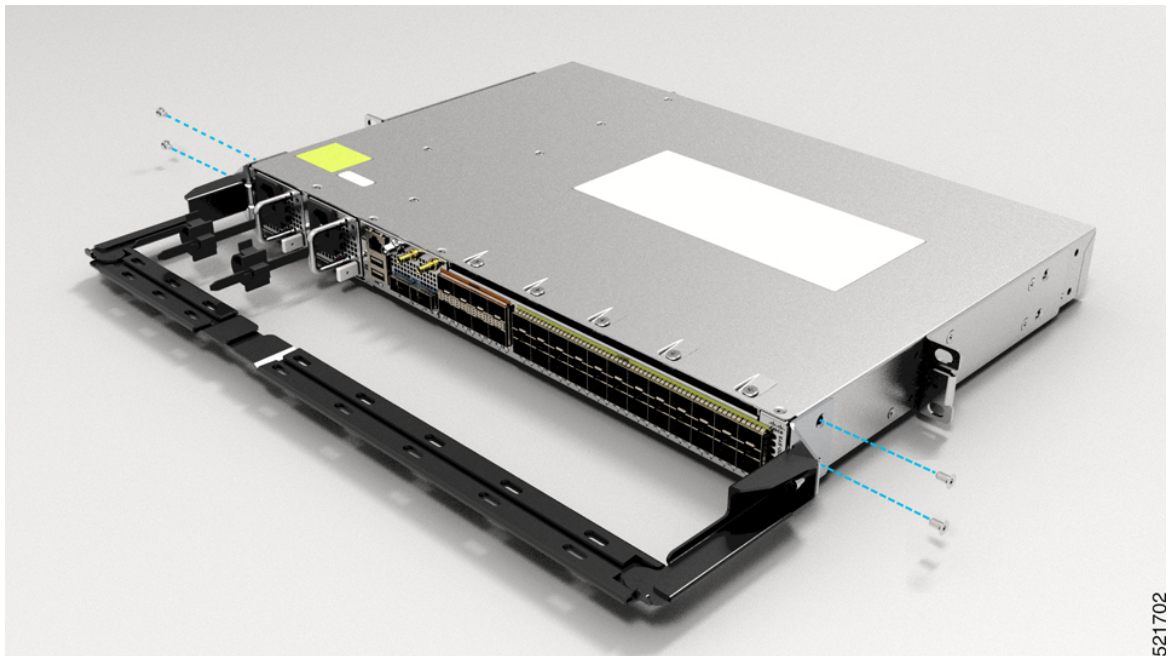

Figure 11: Installing Cable Management (N540-CBL-BRKT-FHC) and 19 inch Rack-Mount Brackets (N540DD-RKM-19) in the Front



521701

Figure 12: Installing Cable Management (N540-CBL-BRKT-FHC) and 19 inch Rack-Mount Brackets (N540DD-RKM-19) in the Middle



521702

Figure 13: Installing Cable Management (N540-CBL-BRKT-FHC) and 19 inch Rack-Mount Brackets (N540DD-RKM-19) in the Rear

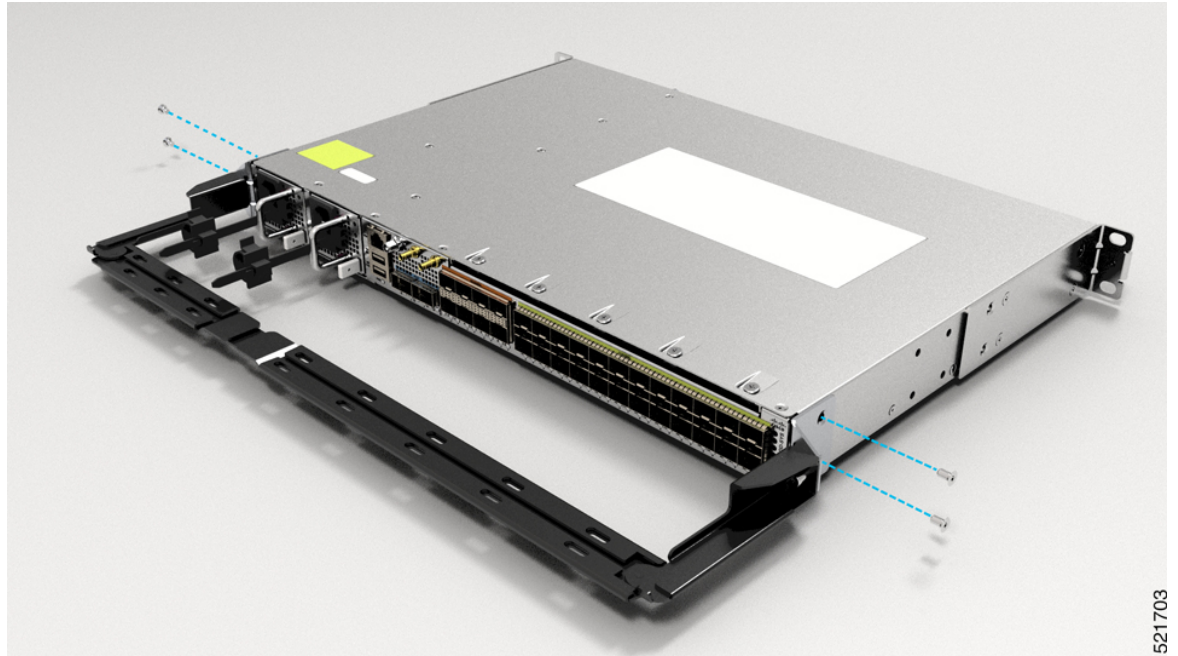

521703

Figure 14: Installing 23-inch Rack-Mount Brackets (N540-RKM-23-FHC)

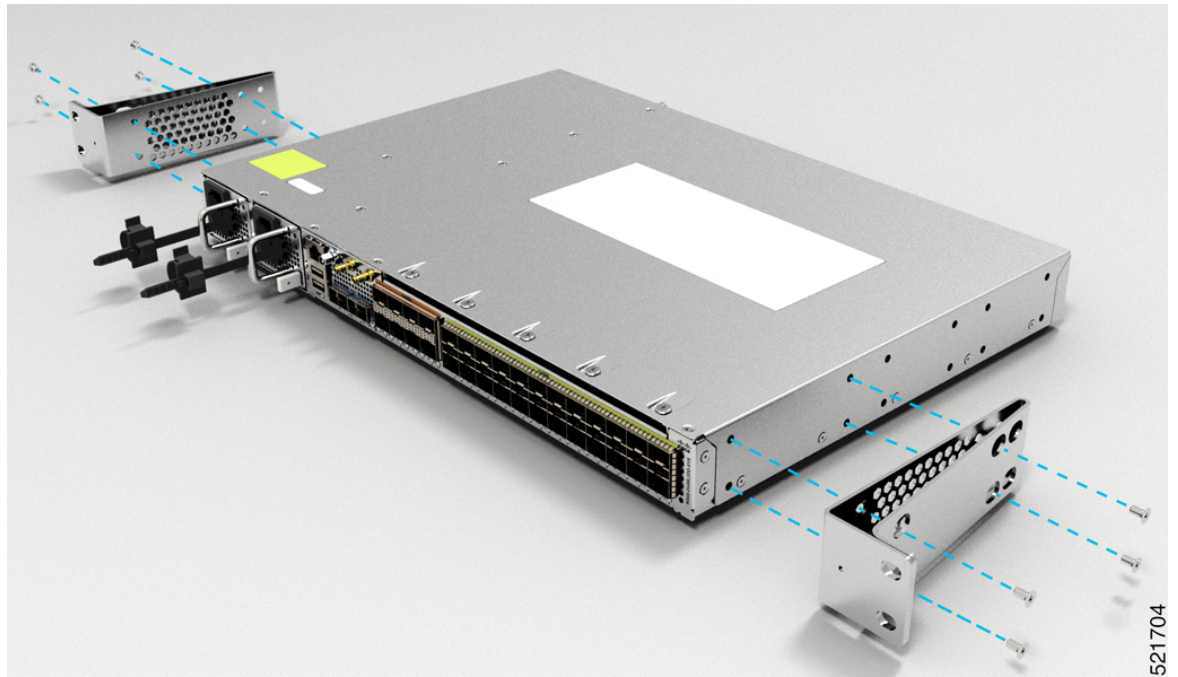

521704

Figure 15: Installing Cable Management (N540-CBL-BRKT-FHC) and 23-inch Rack-Mount Brackets (N540-RKM-23-FHC) in the Front

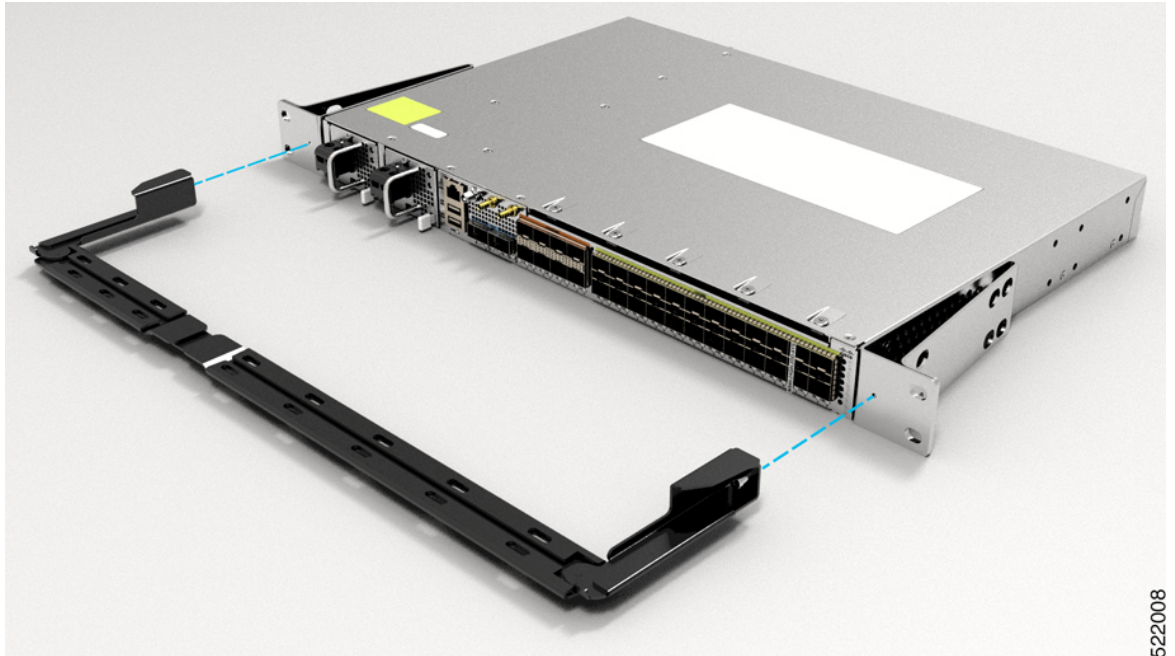

522008

Figure 16: Installing ETSI Rack-Mount Brackets (N540-RKM-ETSI-FHC)

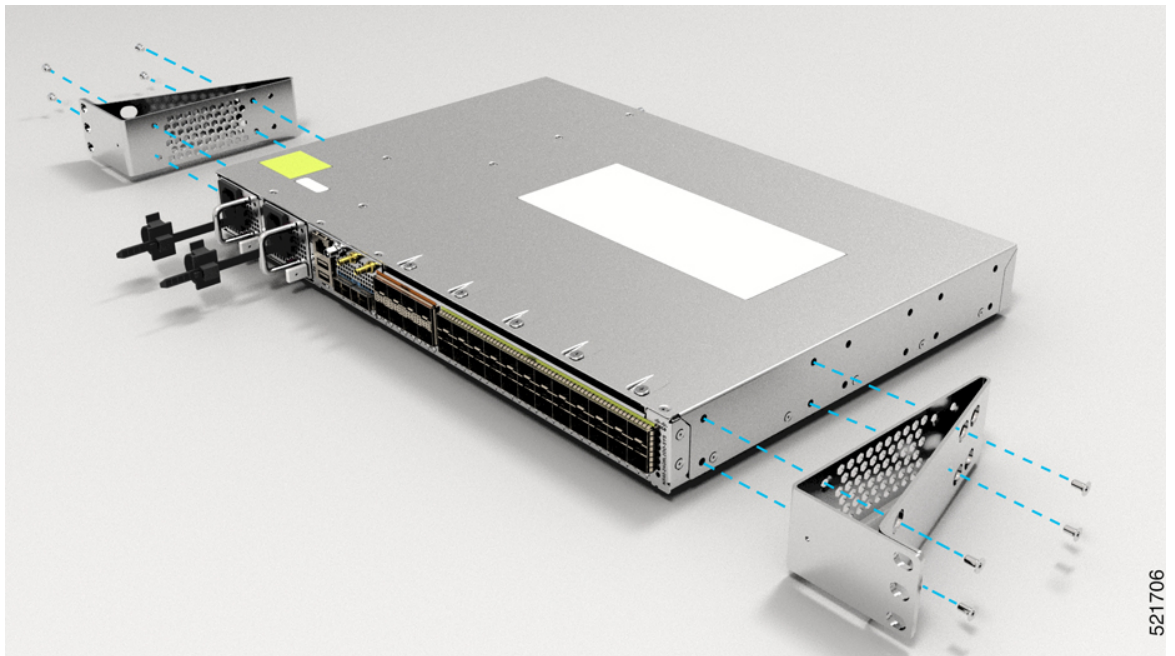

521706

Figure 17: Installing Cable Management (N540-CBL-BRKT-FHC) and ETSI Rack-Mount Brackets (N540-RKM-ETSI-FHC) in the Front

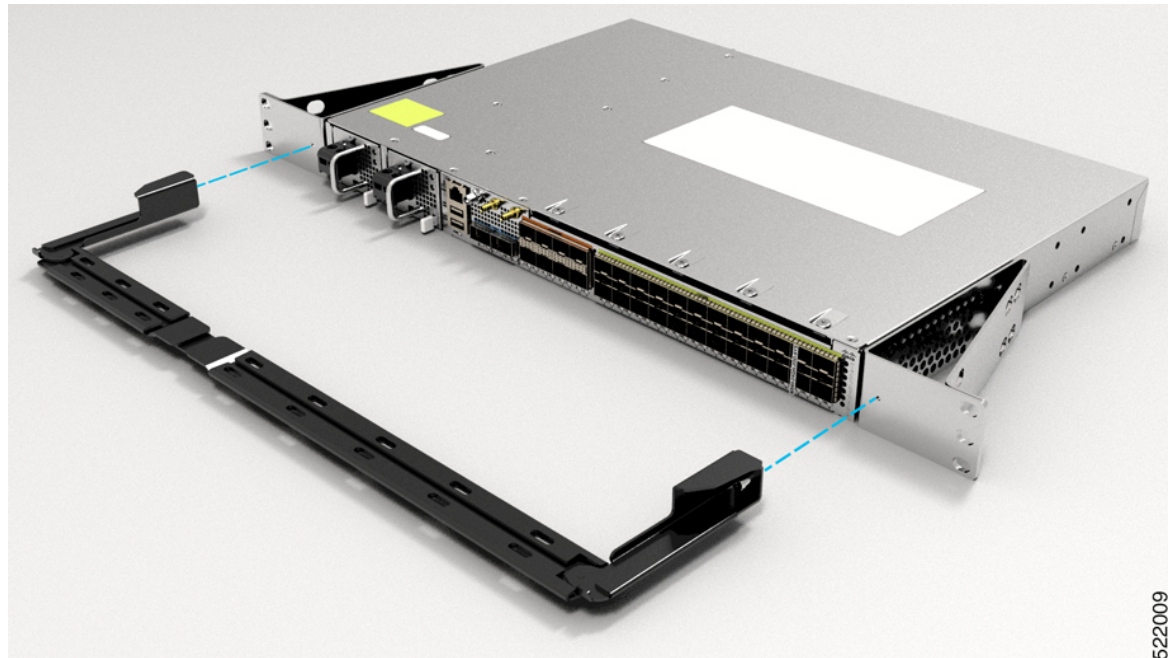

522009

Ground the Device

Before you begin this task, ensure that you have read and understood the safety warnings in the Preventing ESD Damage section of the *Safety Warnings* handout.

Before you connect the power or turn on the power to the device, you must provide an adequate device ground (earth) connection to your device.

This section describes how to ground the device. The grounding lug location is on the back panel of the device.

1. Verify that the ground cable is connected to the top of the rack and according to local site practice.

Figure 18: Ground Lug



521708

2. Attach one end of the shelf ground cable (#6 AWG cable) to the ground point on the rear of the chassis using the specified dual-hole lug connector.
 - Use a wire-stripping tool to remove approximately 0.75 inches (19 mm) of the covering from the end of the grounding cable.
 - Insert the stripped end of the grounding cable into the open end of the grounding lug.
 - Use the crimping tool to secure the grounding cable in the grounding lug.
 - Remove the adhesive label from the grounding pad on the chassis.
 - Place the grounding lug against the grounding pad so that there is solid metal-to-metal contact, and insert the two M4 screws with washers through the holes in the grounding lug and into the grounding pad.
 - Ensure that the lug and cable do not interfere with other equipment.
 - Prepare the other end of the grounding cable and connect it to an appropriate grounding point in your site to ensure adequate earth ground.

Install the AC Power Cables

Refer *Chapter 6: Replace Power Supply* for more information about AC power cables installation.

To install the AC power cables in the power supply slots:

1. Plug the power supply cord in the power supply module.

2. Insert the power supply cord into the tie [1, 3] and tighten the tie around the power supply cord as shown in [2, 4] in the figure below.

Figure 19: Attach the AC Power Tie-and-Clip Cord

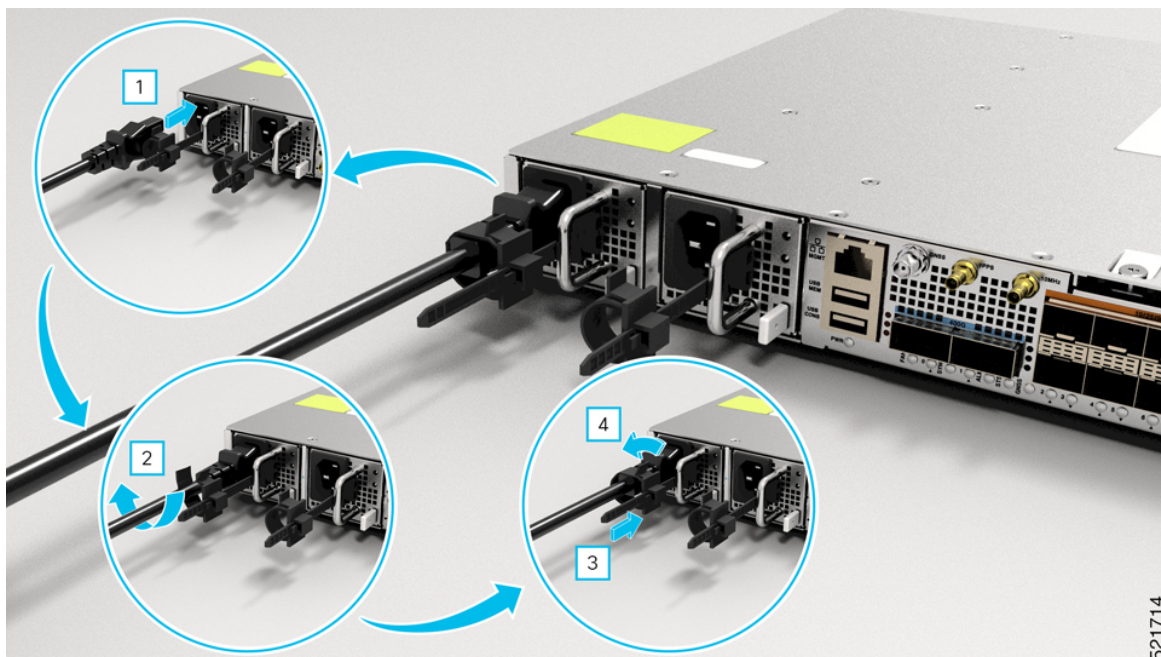

Note These images are for only representation purposes.

Activate an AC Power Supply Module

Perform the following procedure to activate an AC power supply:

-
- Step 1** Plug the power cord into the power supply.
 - Step 2** Connect the other end of the power cord to an AC-input power source.
 - Step 3** Verify power supply operation by checking if the respective power supply front panel LED (PM0 or PM1) is green.
 - Step 4** If the LEDs indicate a power problem, see *Troubleshooting* for troubleshooting information.
 - Step 5** If you are also connecting a redundant AC power supply, repeat these steps for the second power source.
- Note** If you are connecting a redundant AC power supply, ensure that each power supply is connected to a separate power source in order to prevent power loss in the event of a power failure.
-

Install the DC Power Cables



Note When installing DC power supply, use 12AWG, 90°C temperature rated cable. The recommended cable length is three meters maximum from source. For lengths up to five meters, use 10AWG, and for lengths up to three meters, use 12AWG, 90°C temperature rated cable. For other lengths, contact Cisco.



Note

- Always ensure that the building's installation for short-circuit (overcurrent) protection does not exceed 15A.
- We recommend using a circuit breaker or a fast acting fuse with a maximum DC rating of 10A for over current protection.



Note The DC connector or terminal block has an in-built screw and cage nut to which a torque of 1.3 to 1.8 N-m may be applied.

Figure 20: DC Connector with In built Screw

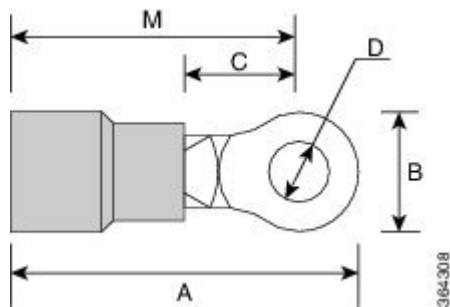

A	0.74 in. (1.88 cm)	C	0.18 in. (0.46 cm)
B	0.25 in. (0.64 cm)	D	0.14 in. (0.36 cm)
M	0.62 in. (1.58 cm)		

To attach the DC power supplies:

1. Locate the terminal block plug.
2. Insert the DC-input power source wires into the terminal block plug.
3. Attach the DC supply wires using the designated screws.

4. Use a ratcheting torque screwdriver to torque the terminal block plug captive screw. (See the following figure)

Figure 21: Attach the DC Power Supply Wires

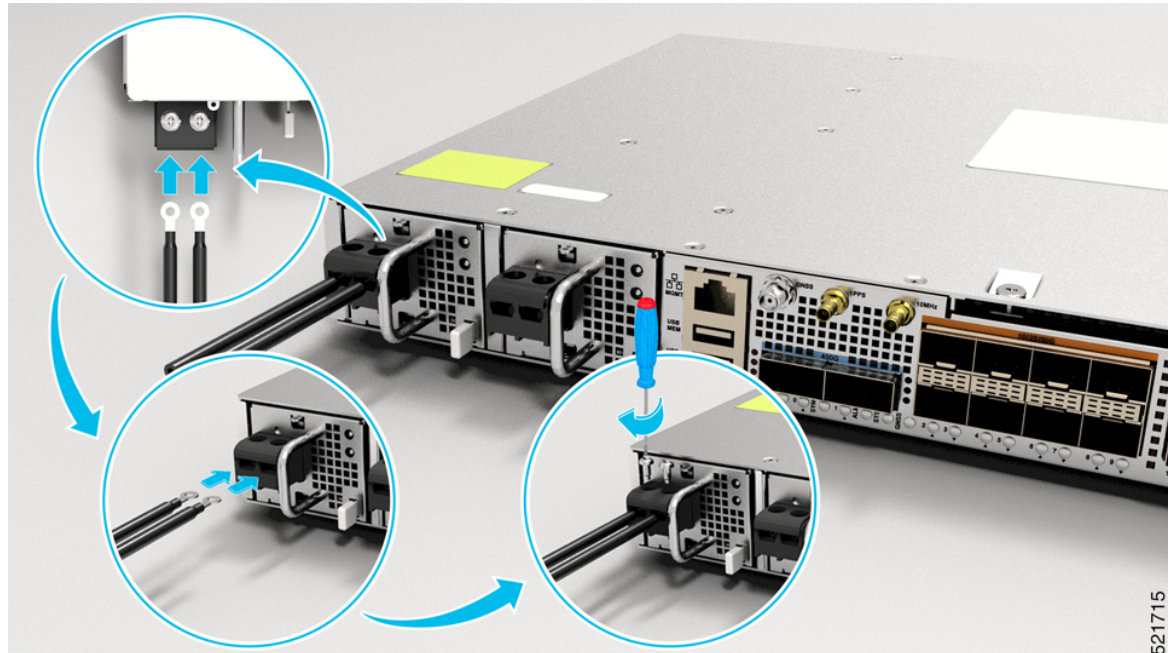

Activate a DC Power Supply Module

Perform the following procedure to activate a DC power supply:

-
- Step 1** Remove the tape from the circuit-breaker router handle, and restore power by moving the circuit-breaker router handle to the On (I) position.
 - Step 2** Verify the power supply operation by checking whether the respective power supply front panel LED (PM0 or PM1) is green.
 - Step 3** If the LEDs indicate any issues with power problem, see *Troubleshooting*.
 - Step 4** If you are also connecting a redundant DC power supply, repeat these steps for the second power source.

Note If you are connecting a redundant DC power supply, ensure that each power supply is connected to a separate power source in order to prevent power loss in the event of a power failure.

Port Connection Guidelines

Depending on the chassis and installed line cards, you can use pluggables QSFP56-DD, QSFP28-DD, QSFP28, QSFP, SFP56, SFP28, SFP10, SFP, USB console, and RJ-45 connectors to connect the ports on the line cards to other network devices.

To prevent damage to the fiber-optic cables, we recommend that you keep the transceivers disconnected from their fiber-optic cables when installing the transceiver in the line card. Before removing a transceiver from the router, remove the cable from the transceiver.

To maximize the effectiveness and life of your transceivers and optical cables, do the following:

- Wear an ESD-preventative wrist strap that is connected to an earth ground whenever handling transceivers. The router is typically grounded during installation and provides an ESD port to which you can connect your wrist strap.
- Do not remove and insert a transceiver more often than is necessary. Repeated removals and insertions can shorten its useful life.
- Keep the transceivers and fiber-optic cables clean and dust free to maintain high signal accuracy and to prevent damage to the connectors. Attenuation (loss of light) is increased by contamination and should be kept below 0.35 dB.
 - Clean these parts before installation to prevent dust from scratching the fiber-optic cable ends.
 - Clean the connectors regularly; the required frequency for cleaning depends upon the environment. In addition, clean connectors when they are exposed to dust or accidentally touched. Both wet and dry cleaning techniques can be effective; refer to your site's fiber-optic connection cleaning procedures.
 - Do not touch the ends of connectors. Touching the ends can leave fingerprints and cause other contamination.
- Inspect routinely for dust and damage. If you suspect damage, clean and then inspect fiber ends under a microscope to determine if damage has occurred.

Connect to the Console Port

- The router must be fully installed in its rack, connected to a power source, and grounded.
- The necessary cabling for the console, management, and network connections must be available.
 - Network cabling should already be routed to the location of the installed router.

Before you create a network management connection for the router or connect the router to the network, you must create a local management connection through a console terminal and configure an IP address for the router. You also can use the console to perform the following functions (each of which can be performed through the management interface after you make that connection):

- Configure the router using the command-line interface (CLI).
- Monitor network statistics and errors.
- Configure Simple Network Management Protocol (SNMP) agent parameters.
- Download software updates.

The system console port is an RJ-45 receptacle or USB console for connecting a data terminal to perform the initial configuration of the router.

Figure 22: Connecting the USB Console Cable to the Front of Chassis

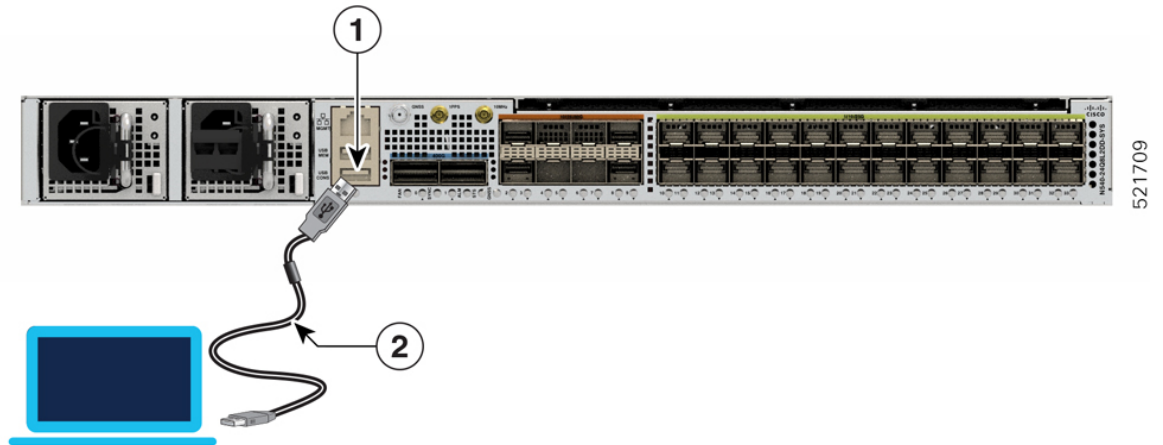

1	USB Type-A connector	2	USB cable
---	----------------------	---	-----------

Figure 23: Connecting RJ-45 Console Cable to the RJ-45 Console Port at Rear End of the Chassis

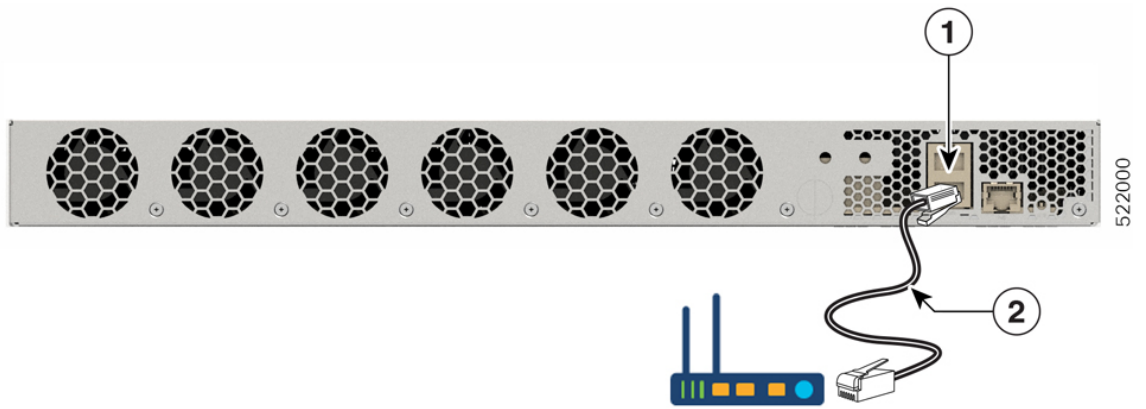

1	RJ-45 console port	2	RJ-45 console cable
---	--------------------	---	---------------------

Follow this procedure to connect a data terminal to the console port:

1. Set your terminal to these operational values: 115200 bps, 8 data bits, no parity, and two stop bits.
2. Attach the terminal end of the cable to the interface port on the data terminal.
3. Attach the other end of the cable to the console port.

Table 7: RJ-45 Straight-through Cable Pin-outs

RJ-45 Pin	Signal
1	—

RJ-45 Pin	Signal
2	—
3	Tx
4	Ground (GND)
5	GND
6	Rx
7	—
8	—

Connect to the Management Ethernet Port

You must complete the initial router configuration.

The management Ethernet port provides out-of-band management, which enables you to use the Command Line Interface (CLI) to manage the router by its IP address. This port uses a 10/100/1000 Ethernet connection with an RJ-45 interface.



Note To prevent an IP address conflict, do not connect the management Ethernet port until the initial configuration is complete.

To connect cables to the system management port, attach Category 5 cables directly to the RJ-45 receptacle on the management Ethernet port.

Figure 24: Management Ethernet Port

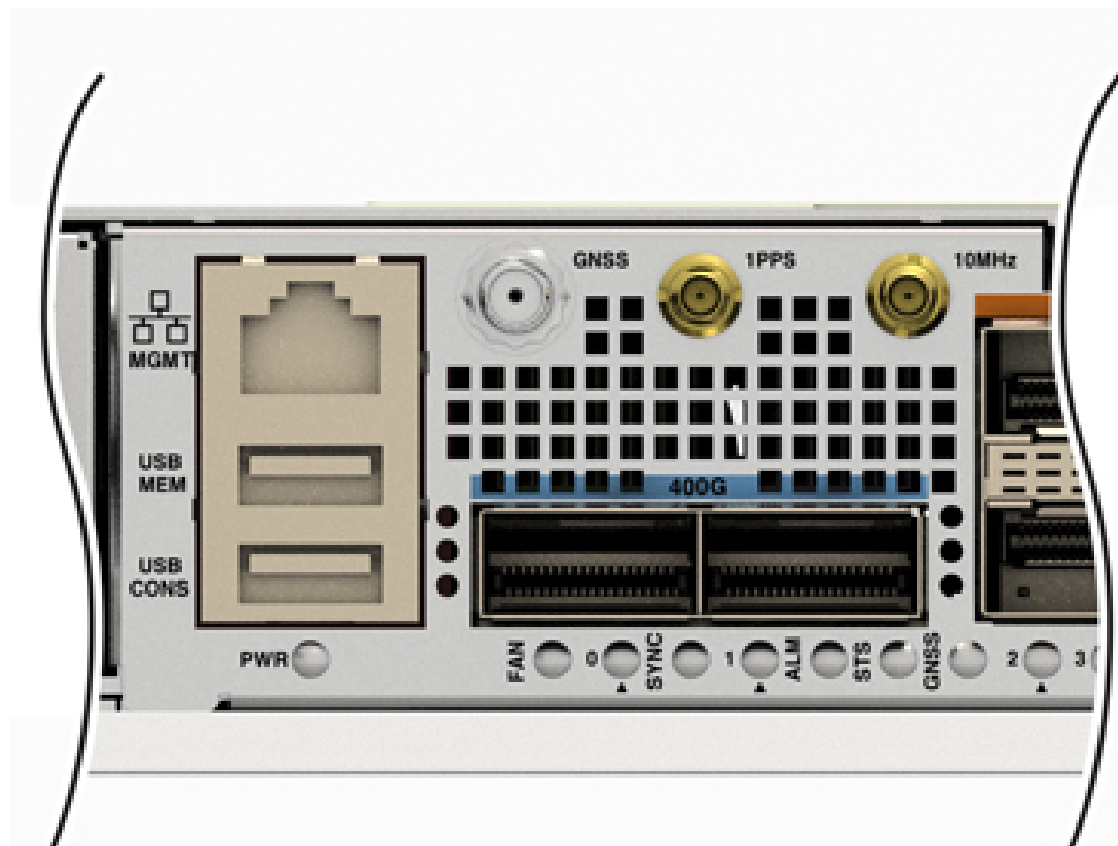

Note To comply with GR-1089-CORE, the intra-building port(s) of the equipment must use shielded intra-building cabling or wiring that is grounded at both ends.

1. Plug the cable directly into the RJ-45 receptacle.
2. Connect the network end of your RJ-45 cable to a switch, hub, repeater, or other external equipment.

Connecting Timing Cables

The following sections describe how to connect timing cables.

Connecting a Cable to the Input 10MHz or 1PPS Interface

1. Connect one end of a mini-coax cable to the timing unit.
2. Connect the other end of the mini-coax cable to the 10MHz or 1PPS port on the router.

Connecting a Cable to the Output 10MHz or 1PPS Interface

- Step 1** Connect one end of a mini-coax cable to the Slave unit.
- Step 2** Connect the other end of the mini-coax cable to the 10MHz or 1PPS port of the router.

Connecting a Cable to the GNSS Antenna Interface

1. Connect one end of a shielded coaxial cable to the GNSS RF IN port.
2. Connect the other end of the shielded coaxial cable to the GNSS antenna after the primary protector.



Note The GNSS RF In port should have a primary protector installed to meet the Local Safety guidelines.

The GNSS RF In coaxial cable shield must be connected to the Facility Equipment Ground through the chassis. The chassis must have the ground wire connected to the Facility Equipment Ground.

Figure 25: GNSS Receiver

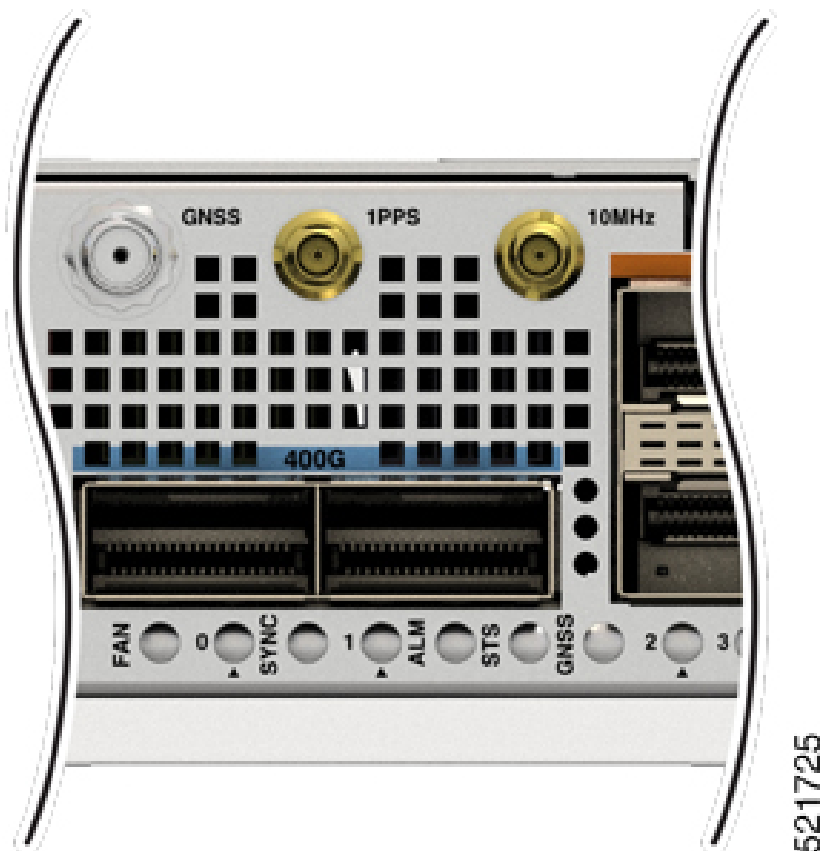

Install and Remove Transceiver Module

This section shows how to install and remove transceiver module.

Safety Precautions for Module Installation and Removal

Be sure to observe the following safety precautions when you work on the chassis.

**Warning**

To prevent bodily injury when mounting or servicing this unit in a rack, you must take special precautions to ensure that the system remains stable. The following guidelines are provided to ensure your safety:

- This unit should be mounted at the bottom of the rack if it is the only unit in the rack.
- When mounting this unit in a partially filled rack, load the rack from the bottom to the top with the heaviest component at the bottom of the rack.
- If the rack is provided with stabilizing devices, install the stabilizers before mounting or servicing the unit in the rack.

**Warning**

This product is a Class 1 laser product.

**Warning**

An instructed person is someone who has been instructed and trained by a skilled person and takes the necessary precautions when working with equipment.

A skilled person or qualified personnel is someone who has training or experience in the equipment technology and understands potential hazards when working with equipment.

There are no serviceable parts inside. To avoid risk of electric shock, do not open.

**Warning**

Only a skilled person should be allowed to install, replace, or service this equipment. See statement 1089 for the definition of a skilled person.

There are no serviceable parts inside. To avoid risk of electric shock, do not open.

Install and Remove SFP56, SFP28, SFP10, and SFP Modules

Before you remove or install an SFP56, SFP28, SFP10, and SFP module, read the installation information in this section.

**Warning**

Class I (CDRH) and Class 1M (IEC) laser products. Statement 1055

**Warning**

Invisible laser radiation may be emitted from the end of the unterminated fiber cable or connector. Do not view directly with optical instruments. Viewing the laser output with certain optical instruments (for example, eye loupes, magnifiers, and microscopes) within a distance of 100 mm may pose an eye hazard. Statement 1056

Fiber type and Core diameter (μm)	Wavelength (nm)	Max. Power (mW)	Beam divergence (rad)
SM 11	1200 - 1400	39 - 50	0.1 - 0.11
MM 62.5	1200 - 1400	150	0.18 NA
MM 50	1200 - 1400	135	0.17 NA
SM 11	1400 - 1600	112 - 145	0.11 - 0.13

348377

**Caution**

Protect the line card by inserting a clean SFP56, SFP28, SFP10, and SFP module cage cover, shown in the figure below, into the optical module cage when there is no SFP56, SFP28, SFP10, and SFP module installed.

Figure 26: SFP56, SFP28, SFP10, and SFP Module Cage Cover



521295

**Caution**

Protect the SFP56, SFP28, SFP10, and SFP modules by inserting clean dust covers into them after the cables are removed. Be sure to clean the optic surfaces of the fiber cables before you plug them back into the optical ports of another module. Avoid getting dust and other contaminants into the optical ports of your SFP56, SFP28, SFP10, and SFP modules, because the optics do not work correctly when obstructed by dust.

**Caution**

We strongly recommended that you do not install or remove the SFP56, SFP28, SFP10, and SFP module with fiber-optic cables attached to it because of the potential of damaging the cable, the cable connector, or the optical interfaces in the module. Disconnect all cables before removing or installing an SFP56, SFP28, SFP10, and SFP module. Removing and inserting a module can shorten its useful life; so you should not remove and insert modules more than it is absolutely necessary.

**Note**

When installing an SFP56, SFP28, SFP10, and SFP module, you would hear a click as the triangular pin on the bottom of the module snaps into position into the hole in the receptacle. The click indicates that the module is correctly seated and secured in the receptacle. Verify that the modules are completely seated and secured in their assigned receptacles on the line card by firmly pushing on each SFP56, SFP28, SFP10, and SFP module.

Bale Clasp SFP56, SFP28, SFP10, and SFP Module

The bale clasp SFP56, SFP28, SFP10, and SFP module has a clasp that you use to remove or install the module. (See the figure below.)

Figure 27: Bale Clasp SFP56, SFP28, SFP10, and SFP Module

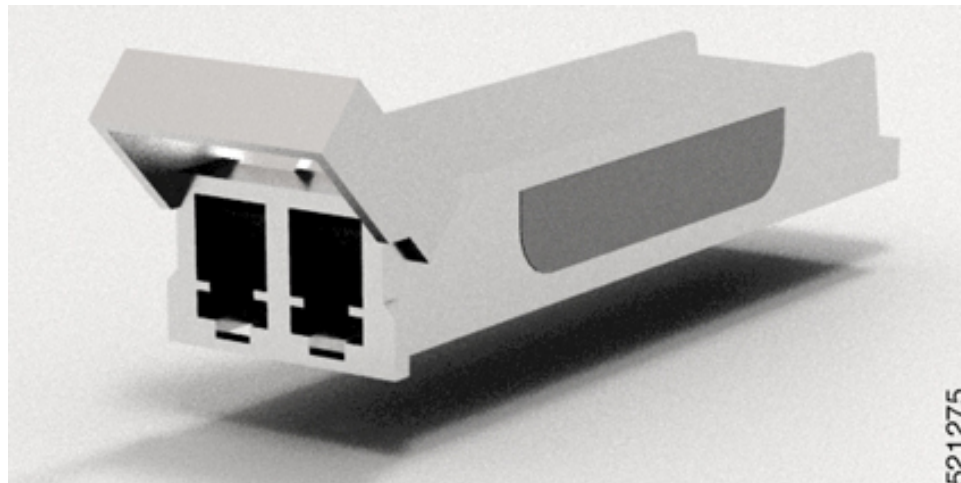

Install a Bale SFP56, SFP28, SFP10, and SFP Module

To install this type of SFP56, SFP28, SFP10, and SFP module:

1. Attach an ESD-preventive wrist or ankle strap and follow its instructions for use.
2. Close the bale clasp before inserting the SFP56, SFP28, SFP10, and SFP module.
3. Line up the SFP56, SFP28, SFP10, and SFP module with the port and slide it into the port. (See the figure below.)

Figure 28: Installing a Bale Clasp SFP56, SFP28, SFP10, and SFP Module into a Port

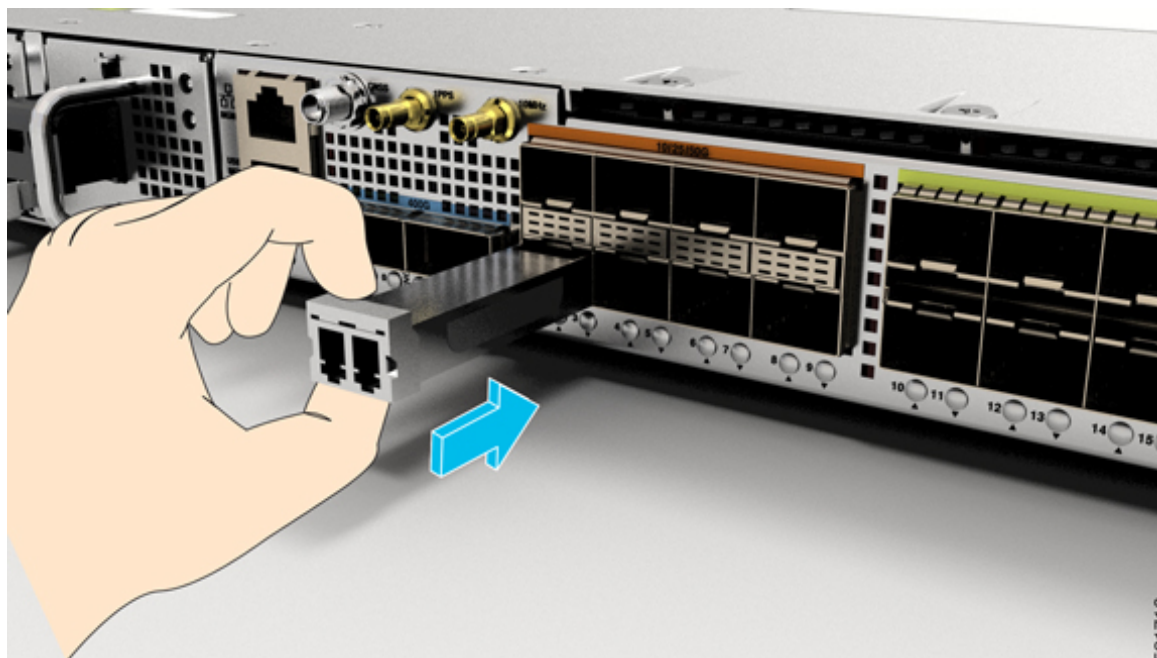

Note When installing an SFP56, SFP28, SFP10, and SFP module, you should hear a click as the triangular pin on the bottom of the SFP56, SFP28, SFP10, and SFP module snaps into the hole in the receptacle. This click indicates that the module is correctly seated and secured in the receptacle. Verify that the SFP56, SFP28, SFP10, and SFP modules are completely seated and secured in their assigned receptacles on the line card by firmly pushing on each SFP56, SFP28, SFP10, and SFP module.

Remove a Bale Clasp SFP56, SFP28, SFP10, and SFP Module

To remove this type of SFP56, SFP28, SFP10, and SFP module:

1. Attach an ESD-preventive wrist or ankle strap and follow its instructions for use.
2. Disconnect and remove all interface cables from the ports; note the current connections of the cables to the ports on the line card.
3. Open the bale clasp on the SFP56, SFP28, SFP10, and SFP module with your index finger, as shown in the figure below. If the bale clasp is obstructed and if you cannot open it, use your index finger, use a small flat-blade screwdriver or other long, narrow instrument to open the bale clasp.
4. Grasp the SFP56, SFP28, SFP10, and SFP module between your thumb and index finger and carefully remove it from the port, as shown in the figure below.



Note This action must be performed during your first instance. After all ports are populated, this may not be possible.

Figure 29: Removing a Bale Clasp SFP56, SFP28, SFP10, and SFP Module

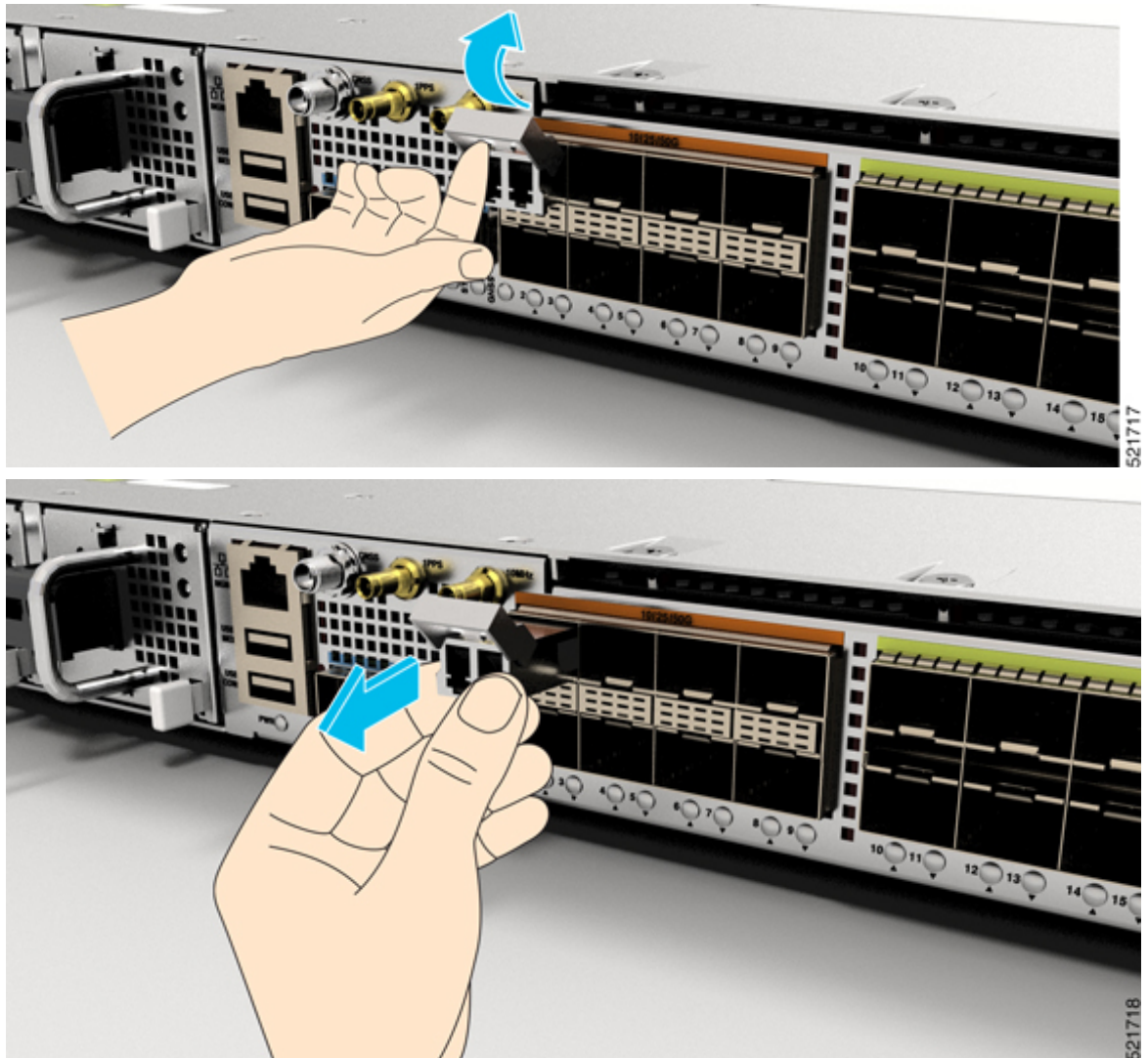

5. Place the SFP56, SFP28, SFP10, and SFP module that you removed on an antistatic mat, or immediately place it in a static shielding bag if you plan to return it to the factory.
6. Protect your line card by inserting a clean SFP56, SFP28, SFP10, and SFP module cage covers into the optical module cage when there is no SFP56, SFP28, SFP10, and SFP module installed.

Install and Remove QSFP+, QSFP28, or QSFP-DD Transceiver Modules

Before you remove or install an QSFP+, QSFP28, or QSFP-DD module, read the installation information in this section.



Warning Only trained and qualified personnel should be allowed to install, replace, or service this equipment. Statement 1030



Warning No serviceable parts inside. To avoid risk of electric shock, do not open. Statement 1073



Warning Instructed person is someone who has been instructed and trained by a skilled person and takes the necessary precautions when working with equipment.

Skilled person/Qualified personnel is someone who have training or experience in the equipment technology and understand potential hazards when working with equipment. Statement 1089



Warning Only skilled person should be allowed to install, replace, or service this equipment. Refer to statement 1089 for description of skilled person. Statement 1090



Warning Only instructed person or skilled person should be allowed to install, replace, or service this equipment. Refer to statement 1089 for description of skilled person. Statement 1091



Warning



Hot surface. Use care when handling. Statement 1092

This section provides the installation, cabling, and removal instructions for the 40-Gigabit Quad Small Form-Factor Pluggable Plus (QSFP+), 100 Gigabit (QSFP28), and 200/400-Gigabit QSFP-DD transceiver modules. The modules are hot-swappable input/output (I/O) devices that connect the system's module port electrical circuitry with either a copper or a fiber-optic network. The 100-Gigabit QSFP28 and 40-Gigabit QSFP+ optical transceivers are similar to QSFP-DD optical transceiver shown in the figure below.

Figure 30: QSFP-DD Transceiver Module (Optical)

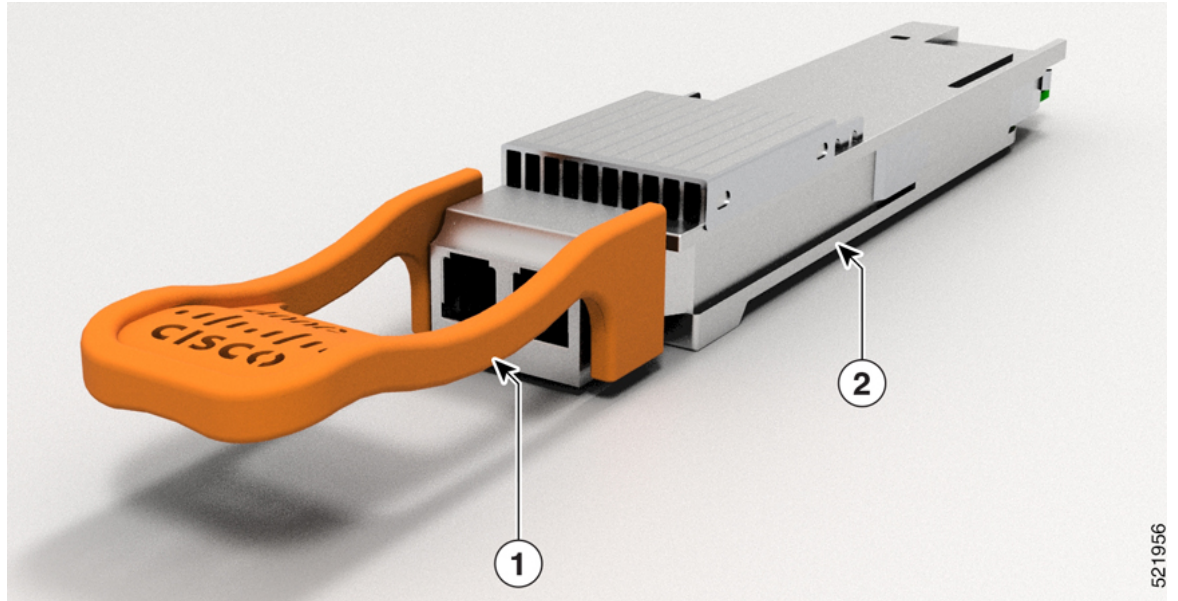

1	Bale clasp latch
2	QSFP-DD transceiver body

Figure 31: QSFP-DD Transceiver Module (Optical)

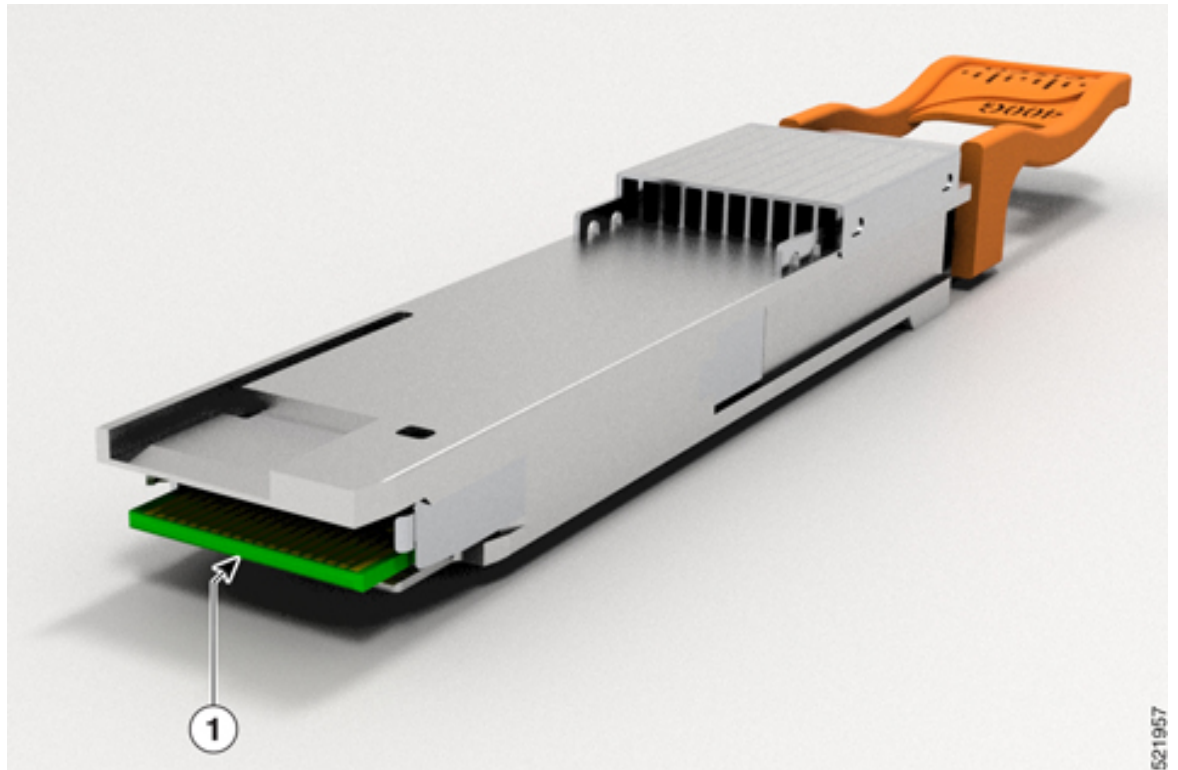

1	Electrical connection to the module circuitry
---	---

Required Tools and Equipment

You need these tools to install the transceiver modules:

- Wrist strap or other personal grounding device to prevent ESD occurrences.
- Antistatic mat or antistatic foam to set the transceiver on.
- Fiber-optic end-face cleaning tools and inspection equipment.

Install the 40-Gigabit QSFP+, 100-Gigabit QSFP28, or 200/400-Gigabit QSFP-DD Transceiver Module



Note The QSFP+, QSFP28, or QSFP-DD transceiver module can have either a bale-clasp latch or a pull-tab latch. Installation procedures for both types of latches are provided.



Caution The QSFP+, QSFP28, or QSFP-DD transceiver module is a static-sensitive device. Always use an ESD wrist strap or similar individual grounding device when handling QSFP+, QSFP28, or QSFP-DD transceiver modules or coming into contact with system modules.

To install an QSFP+, QSFP28, or QSFP-DD transceiver module, follow these steps:

1. Attach an ESD wrist strap to yourself and a properly grounded point on the chassis or the rack.
2. Remove the transceiver module from its protective packaging.
3. Check the label on the transceiver module body to verify that you have the correct model for your network.
4. For transceiver modules, remove the optical bore dust plug and set it aside.
5. For transceiver modules equipped with a pull-tab, hold the transceiver so that the identifier label is on the top.
6. For transceiver modules equipped with a bale clasp latch, keep the bale clasp aligned in a vertical position.
7. Align the transceiver module in front of the module's transceiver socket opening and carefully slide the transceiver into the socket until the transceiver makes contact with the socket electrical connector (see the figure below).

Figure 32: Installing a Bale Clasp QSFP+, QSFP28, or QSFP-DD Transceiver Module

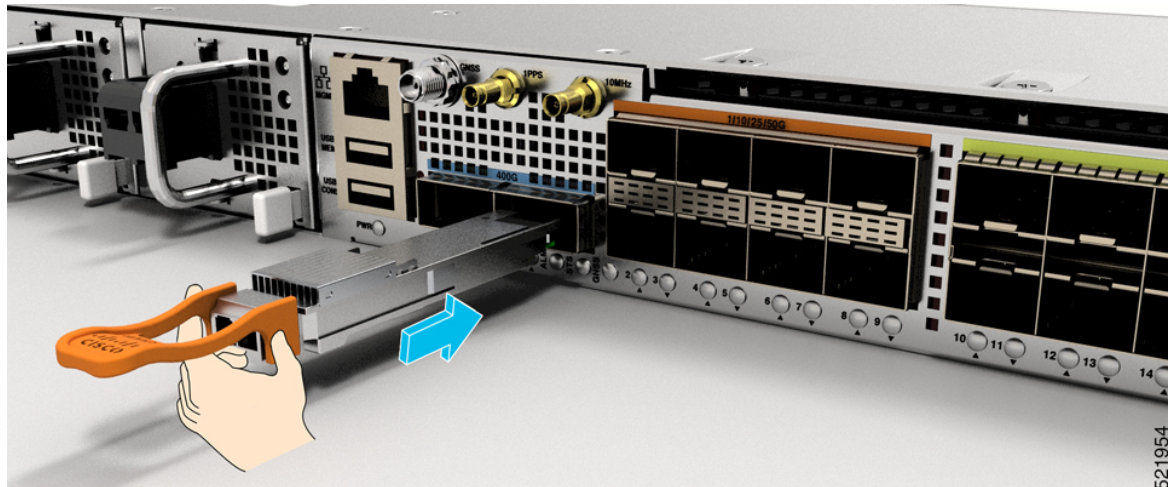

8. Press firmly on the front of the QSFP+, QSFP28, or QSFP-DD transceiver module with your thumb to fully seat the transceiver in the module's transceiver socket.



Caution If the latch is not fully engaged, you might accidentally disconnect the QSFP+, QSFP28, or QSFP-DD transceiver module.

9. For optical QSFP+, QSFP28, or QSFP-DD transceiver modules, reinstall the dust plug into the transceivers optical bore until you are ready to attach the network interface cable. Do not remove the dust plug until you are ready to attach the network interface cable.

Attach the Optical Network Cable

Before you begin

Before you remove the dust plugs and make any optical connections, follow these guidelines:

- Keep the protective dust plugs installed in the unplugged fiber-optic cable connectors and in the transceiver optical bores until you are ready to make a connection.
- Inspect and clean the MPO connector end faces just before you make any connections.
- Grasp the MPO connector only by the housing to plug or unplug a fiber-optic cable.



Note 40-Gigabit QSFP+, QSFP28, or QSFP-DD transceiver modules are keyed to prevent incorrect insertion.



Note The Multiple-fiber Push-On (MPO) connectors on the optical QSFP+, QSFP28, or QSFP-DD transceivers support network interface cables with either physical contact (PC) or ultra-physical contact (UPC) flat polished face types. The MPO connectors on the optical QSFP+, QSFP28, or QSFP-DD transceivers do not support network interface cables with an angle-polished contact (APC) face type.

To attach the optical network cable:

1. Remove the dust plugs from the optical network interface cable MPO connectors. Save the dust plugs for future use.
2. Inspect and clean the MPO connector's fiber-optic end faces.
3. Remove the dust plugs from the transceiver module optical bores.
4. Immediately attach the network interface cable MPO connectors to the transceiver module.

Removing the 40-Gigabit QSFP+, 100-Gigabit QSFP28, or 200/400-Gigabit QSFP-DD Transceiver Module



Caution The QSFP+, QSFP28, or QSFP-DD transceiver module is a static-sensitive device. Always use an ESD wrist strap or similar individual grounding device when handling QSFP+ or QSFP28 transceiver modules or when coming into contact with modules.

To remove a QSFP+, QSFP28, or QSFP-DD transceiver module:

- For transceiver modules, disconnect the network interface cable from the transceiver connector.
- For transceiver modules equipped with a bale clasp latch:
 1. Pivot the bale clasp down to the horizontal position.
 2. Immediately install the dust plug into the transceivers optical bore.
 3. Grasp the sides of the transceiver and slide it out of the module socket.
- For transceivers equipped with a pull tab latch:
 1. Immediately install the dust plug into the transceiver's optical bore.
 2. Grasp the tab and gently pull to release the transceiver from the socket.
 3. Slide the transceiver out of the socket.

Figure 33: Removing a Bale Clasp QSFP+, QSFP28, or QSFP-DD Transceiver Module

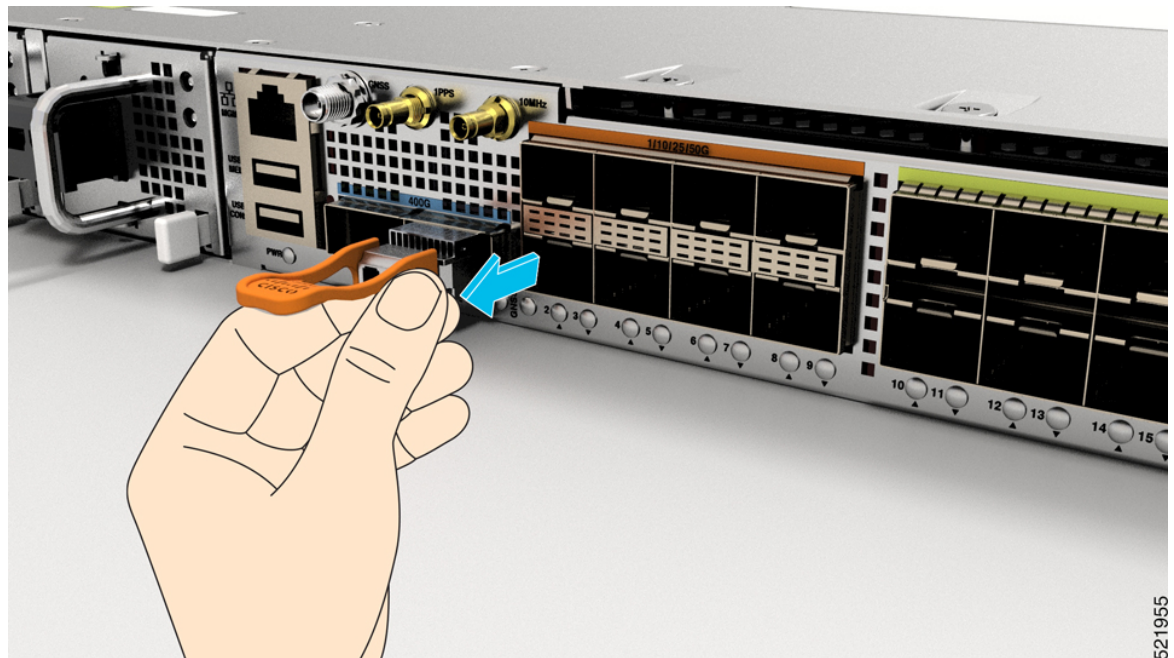

Connect Interface Ports

You can connect optical interface ports on line cards with other devices for network connectivity.

Connect a Fiber-Optic Port to the Network

Depending on the line card model that you are using, you can use either QSFP-DD or QSFP28 transceivers. Some transceivers work with fiber-optic cables that you attach to the transceivers and other transceivers work with pre-attached copper cables.



Caution

Removing and installing a transceiver can shorten its useful life. Do not remove and insert transceivers more than it is absolutely necessary. We recommend that you disconnect cables before installing or removing transceivers to prevent damage to the cable or transceiver.

Disconnect Optical Ports from the Network

When you need to remove fiber-optic transceivers, you must first remove the fiber-optic cables from the transceiver before you remove the transceiver from the port.

Maintain Transceivers and Optical Cables

To maintain high signal accuracy and to prevent damage to the connectors, transceivers and fiber-optic cables must be kept clean and free of dust. Attenuation (loss of light) is increased by contamination and should be below 0.35 dB.

Consider the following maintenance guidelines:

- Transceivers are static sensitive. To prevent ESD damage, wear an ESD-preventative wrist strap that is connected to the grounded chassis.
- Do not remove and insert a transceiver more than it is necessary. Repeated removals and insertions can shorten its useful life.
- Keep all optical connections covered when not in use. Clean them before use to prevent dust from scratching the fiber-optic cable ends.
- Do not touch the ends of connectors. Touching the ends would leave fingerprints and cause other contamination.
- Clean the connectors regularly; the required frequency of cleaning depends upon the environment. In addition, clean connectors if they are exposed to dust or have been accidentally touched. Both wet and dry cleaning techniques can be effective; refer to your site's fiber-optic connection cleaning procedures.
- Inspect routinely for dust and damage. Clean and then inspect fiber ends under a microscope to determine whether any damage has occurred.



CHAPTER 5

Configure the Device

Before you begin this task, ensure that you have read and understood the safety warnings in the *Safety with Electricity* section of the *Safety Warnings* handout.



Note This equipment is designed to boot up in less than 30 minutes, depending on its neighbouring devices that must be fully up and running.

Configuring the Cisco N540-24Q8L2DD-SYS involves these tasks:

- [Create the Initial Router Configuration, on page 59](#)
- [Verify Device Installation, on page 61](#)

Create the Initial Router Configuration

You must assign an IP address to the router management interface so that you can then connect the router to the network.

When you initially power up the router, it boots up and asks a series of questions to help configure the router. To enable you to connect the router to the network, you can use the default choices for each configuration except for the IP address, which you must provide.



Note These routers are designed to boot up in less than 30 minutes, provided the neighboring devices are in full operational state.



Note Be aware of the router's unique name to identify it among the other devices in the network.

Before you begin

- A console device must be connected with the router.
- The router must be connected to a power source.

- Determine the IP address and netmask needed for the Management interfaces: `MgmtEth0/RP0/CPU0/0` and `MgmtEth0/RP1/CPU0/0`:

Step 1 Power up the router.

The LEDs on each power supply light up (green) when the power supply units are sending power to the router, and the software asks you to specify a password to use with the router.

Step 2 When the system is booted up for the first time, a new username and a password is to be created. The following prompt appears:

```
!!!!!!!!!!!!!!!!!!!!!! NO root-system username is configured. Need to configure root-system username.
!!!!!!!!!!!!!!!!!!!!!!

--- Administrative User Dialog ---

Enter root-system username:
% Entry must not be null.

Enter root-system username: root
Enter secret:
Use the 'configure' command to modify this configuration.
User Access Verification

Username: root
Password:

RP/0/RP0/CPU0:ios#
```

Step 3 Enter a new password to use for this router.

The software checks the security strength of it and rejects your password if it is not considered to be a strong password. To increase the security strength of your password, make sure that it adheres to the following guidelines:

- At least eight characters
- Minimizes or avoids the use of consecutive characters (such as "abcd")
- Minimizes or avoids repeating characters (such as "aaa")
- Does not contain recognizable words from the dictionary
- Does not contain proper names
- Contains both uppercase and lowercase characters
- Contains both numbers and letters

Note Clear text passwords cannot include the dollar sign (\$) special character.

Tip If a password is trivial (such as a short, easy-to-decipher password), the software rejects the password configuration. Be sure to configure a strong password as described by the guidelines in this step. Passwords are case sensitive.

If you enter a strong password, the software asks you to confirm the password.

Step 4 Reenter the password.

When you enter the same password, the software accepts the password .

- Step 5** Enter the IP address for the management interface.
- Step 6** Enter a network mask for the management interface.
- Step 7** The software asks whether you want to edit the configuration. Enter **no** to not edit the configuration.
- Step 8** The software asks whether you want to save the configuration. Enter **yes** to save the configuration.
-

Verify Device Installation

After installing the Cisco router, you use the **show** commands to verify the installation and configuration. If any issue is detected, take corrective action before continuing with further configurations.

1. **show inventory**

Displays information about the field replaceable units (FRUs), including product IDs, serial numbers, and version IDs.

Example:

```
#show inventory
```

2. **admin show environment**

Displays all environment-related router information.

Example:

```
#admin show environment
```

3. **show environment temperature**

Displays temperature readings for on-board temperature sensors and for PSU. Each temperature sensor has three thresholds:

- Minor temperature threshold: When a minor threshold is exceeded, a minor alarm occurs and the following actions occur for all sensors:
 - System messages are displayed
 - SNMP notifications (if configured) are sent
 - Log environmental alarm event is triggered (Run the **show alarm** command to review this.)
- Major temperature threshold: When a major threshold is exceeded, a major alarm occurs and the following actions occur for all sensors:
 - System messages are displayed
 - SNMP notifications (if configured) are sent
 - Log environmental alarm event is triggered (Run the **show alarm** command to review this.)
- Critical temperature threshold: When a critical threshold is exceeded, a critical alarm occurs and the following actions occurs:
 - For all the main board sensors the system is shut down.

- For the PSU sensor, the particular PSU is turned off .

4. **show environment power**

Displays the power usage information for the entire router.

Example:

```
#show environment power
```

5. **show environment voltage**

Displays the voltage for the entire router.

Example:

```
#show environment voltage
```

6. **show environment current**

Displays current for different voltage rails of the router.

Example:

```
#show environment current
```

7. **show environment fan**

Displays the speed of all the fans including the fan in PSU.

Example:

```
#show environment fan
```



CHAPTER 6

Replace Power Supply

The router provides a choice of two different power supplies:

- DC power—The DC power supply uses two-position terminal block-style connector with positive latching or securing, and labeled connections for +48V, GRD, -48V. The terminal block connector is of suitable size to carry the appropriate AWG wire size to handle the input current of the power supply. No ON/OFF switch is provided.
- AC power—The AC power supply has an IEC 320-type power receptacle and a 15 Amp service connector. You can use standard right angle power cords with the AC power supply. The power supply includes a power cord retainer. No ON/OFF switch is provided.

You can install dual power supplies for redundancy.



Note Router does not support a combination of AC and DC power supplies together.



Note Products that have an AC power connection are required to have an external SPD provided as part of the building installation to comply with the Telcordia GR-1089 NEBS standard for electromagnetic compatibility and safety.



Caution Do not use interface module and power supply ejector handles to lift the chassis; using the handles to lift the chassis can deform or damage the handles.

- [Remove the DC Power Supply Module, on page 63](#)
- [Install the DC Power Supply Module, on page 64](#)
- [Remove the AC Power Supply Module, on page 65](#)
- [Install the AC Power Supply Module, on page 65](#)

Remove the DC Power Supply Module

This section provides information about removing and replacing the DC power supply.



Warning To reduce risk of electric shock or personal injury, disconnect DC power before removing or replacing components or performing upgrades.

Follow these steps to remove and replace the DC power supply:

-
- Step 1** Before servicing the power supply, switch off the circuit breaker in your equipment area. As an additional precaution, tape the circuit-breaker switch in the Off position.
 - Step 2** Slip on the ESD-preventive wrist strap that is included in the accessory kit.
 - Step 3** Switch the power supply circuit-breaker switch to the Off (O) position.
 - Step 4** Pull the terminal block plug connector out of the terminal block head in the power supply. (See the following figure.)
 - Step 5** Loosen the captive screws on the DC power supply.
 - Step 6** Grasp the power supply handle. Press the power supply lock towards the left and simultaneously pull the power supply out from the chassis while supporting it with the other hand.
-

Install the DC Power Supply Module

This equipment is suitable for installation in network telecommunications facilities and locations where the NEC applies.

This equipment is suitable for installations utilizing the Common Bonding Network (CBN).

The grounding architecture of this product is DC-Isolated (DC-I) for DC-powered products. DC-powered products have a nominal operating DC voltage of 48 VDC.

Perform the following procedure to install the power supply module:

1. Ensure that the system (earth) ground connection is made. (See the following figure.)
2. If necessary, remove the blank power supply filler plate from the chassis power supply bay opening by loosening the captive installation screws.
3. Verify that power to the DC circuit connected to the power supply you are installing is turned off. To ensure that power has been removed from the DC circuits, locate the circuit breakers for the DC circuits, switch the circuit breakers to the OFF position, and tape the circuit-breaker switches in the OFF position.
4. Grasp the power supply handle with one hand. Place your other hand underneath the power supply. Slide the power supply into the power supply bay. Make sure that the power supply is fully seated in the bay.
5. Tighten the captive installation screws of the power supply. The recommended maximum torque is 5.5 in.-lb (0.62 N-m).

Figure 34: Install DC Power Supply Module for Cisco N540-24Q8L2DD-SYS

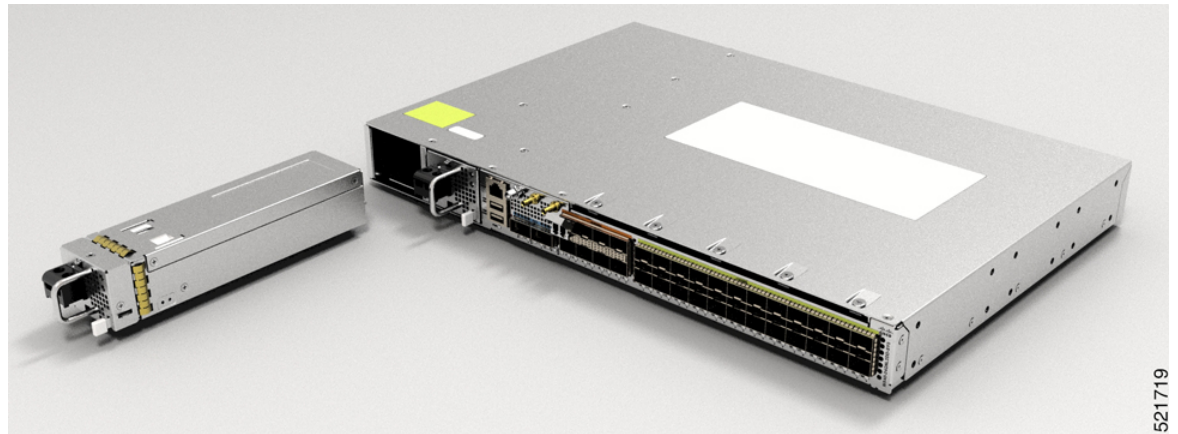

521719

Remove the AC Power Supply Module

This section describes how to remove and replace the AC power supply.



Warning To reduce risk of electric shock, when installing or replacing the unit, the ground connection must always be made first and disconnected last.

If your unit has modules, secure them with the provided screws.



Warning To reduce risk of electric shock or fire, installation of the equipment must comply with local and national electrical codes.

Follow these steps to remove and replace the AC power supply:

- Step 1** Disconnect the power cord from the power source. Do not touch any metal on the power cord when it is still connected to the power supply.
- Step 2** Loosen the tie and remove the power cord from the tie-and holder.
- Step 3** Remove the power cord from the power connection on the power supply. Do not touch the metal prongs embedded in the power supply.
- Step 4** Grasp the power supply handle. Press the power supply lock towards the left and simultaneously pull the power supply out from the chassis while supporting it with the other hand.

Install the AC Power Supply Module

Follow these steps to install the AC power supply module:

1. Ensure that the system (earth) ground connection is made.
2. If necessary, remove the blank power supply filler plate from the chassis power supply bay opening by loosening the captive installation screws.
3. Grasp the power supply handle with one hand. Place your other hand underneath the power supply. Slide the power supply into the power supply bay. Make sure that the power supply is fully seated in the bay. (See the following figure.)

Figure 35: Install AC Power Supply Module for Cisco N540-24Q8L2DD-SYS

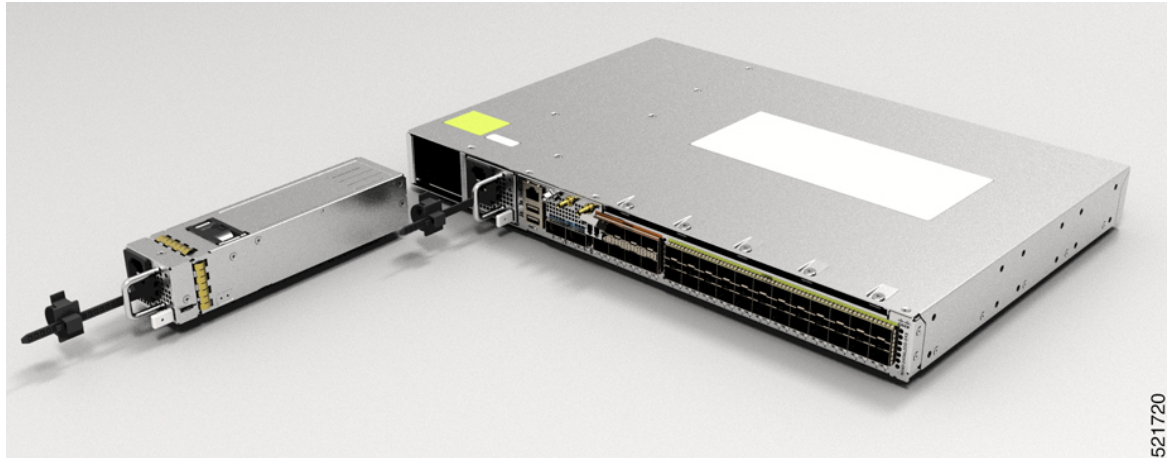

521720

4. Slide the AC power supply cord inside the tie of the tie-and-holder and tighten the tie around the power supply cord.
5. Plug the power supply cord into the AC power supply.



CHAPTER 7

Appendix

Certain troubleshooting aids of the Cisco N540-24Q8L2DD-SYS enable you to perform these tasks that assist the troubleshooting process:

- [LEDs, on page 67](#)
- [System Specifications, on page 70](#)

LEDs

The details of LEDs are listed in this section.

Router LEDs

All the data port LEDs in the Cisco NCS 540 Router is at the front panel. There are 5 LEDs that reflect the different statuses of the system.

Table 8: Router LED Descriptions

LED	Color	Status
Alarm	Red	Critical alarm - system-scope (including RP0).
	Amber	Major alarm - system-scope (including RP0).
	Flashing Amber	Minor alarm - system-scope (including RP0).
	Off	No alarm.
Status	Green	The module is operational but has no active major or critical alarms.
	Amber	Host kernel booted and XR is booting.
	Flashing Red	Not Applicable.

LED	Color	Status
SYNC	Green	Time core is synchronized to an external source including IEEE1588.
	Flashing Green	System is in Synchronous Ethernet mode.
	Amber	Acquiring state or Holdover: Time core is in acquiring state or holdover mode.
	Off	Time core clock synchronization is disabled or in free-running state.
GNSS	Off	GNSS is not configured.
	Green	GNSS Normal State. Self-survey is complete.
	Red	Power up. GNSS is not tracking any satellite.
	Amber	Auto holdover.
	Flashing Green	Learning state-normal. Self-survey is not completed.

System Fans LED

Cisco N540-24Q8L2DD-SYS has six fans at the back panel.

Table 9: Fan Assembly LED Descriptions

LED	Color	Status
STATUS	Green	Fans are operating normally.
	Amber	Single fan failure.
	Red	More than one fan failure or a single PSU fan failure.
	Off	Fan tray is not receiving power.

Power Status LEDs

Table 10: Power Status LEDs

LED Label	Color	Status
PWR	Off	System is powered off
	Green	All the power supplies are on and operating normally.
	Amber	Standby FPGA upgrade is in progress (this is expected to take about three to five minutes).
	Red	Power redundancy is lost due to a power feed failure or an internal power supply failure.

Power Supply LEDs (PM0/PM1)

Table 11: Power Supply LED (PM0/PM1) Descriptions

POWER LED	FAIL LED	Power Supply Condition
Green	Off	Power Supply ON; valid input/output.
Amber 1Hz flashing	Red 1Hz flashing	PSU Warning due to: <ul style="list-style-type: none"> • Over current • Over temperature • Under voltage • Over voltage • Over power • Fan failure
Off	On	PSU failure due to: <ul style="list-style-type: none"> • Over current • Over temperature • Under voltage • Over voltage • Over power • Fan failure

POWER LED	FAIL LED	Power Supply Condition
Green 1Hz flashing	Off	Power supply is not plugged in to the chassis or shutdown by the system.
Off	Off	No valid power input.
Amber	Off	Low input voltage.

Front Panel Power LED and Fan LED Combination

Table 12: Front Panel Power LED and Fan LED Combination

Fan LED	Power LED	Status
Off	Red	Power failure with one of the input power feeds failed or one of the on-board voltage rails has failed.
—	Amber	STDBY FPGA upgrade is in progress due to post Reload/Power cycle after HW FPD upgrade All. Note Upgrade of the STDBY FPGA takes 3–5 minutes.
Green	Flashing Amber	Thermal shutdown with no fan
Flashing Red	Flashing Red	Thermal shutdown
Flashing Red	Flashing Amber	MSS Ready=0
Flashing Amber	Flashing Green	TAM init fail
Flashing Amber	Flashing Red	TAM Not Ready
Flashing Amber	Flashing Amber	SECURE JTAG Fail
Flashing Green	Flashing Green	BIOS Validation Failure
Off	Green	Power Supply ON and operating normally.

System Specifications

For information on the system specifications, see the *Cisco Network Convergence System Large Density 540 Routers Data Sheet*.

Weight and Power Consumption

For information on physical specifications and power consumption, see the *Cisco Network Convergence System Large Density 540 Routers Data Sheet*.

Environmental Specifications

For information on environmental specifications, see table Environmental properties for NCS 540 fixed systems on the *Cisco Network Convergence System 540 Large Density Routers Data Sheet*.

Transceiver and Cable Specifications

To determine which transceivers and cables are supported by this router, see [Cisco Transceiver Modules Compatibility Information](#).

To see the transceiver specifications and installation information, see [Cisco Transceiver Modules Install and Upgrade Guides](#).

RJ-45 Connectors

The RJ-45 connector connects Category 3, Category 5, Category 5e, Category 6, or Category 6A foil twisted-pair or unshielded twisted-pair cable from the external network to the following module interface connectors:

- Router chassis
 - CONSOLE port
 - MGMT ETH port

The following figure shows the RJ-45 connector.

Figure 36: RJ-45 Connector

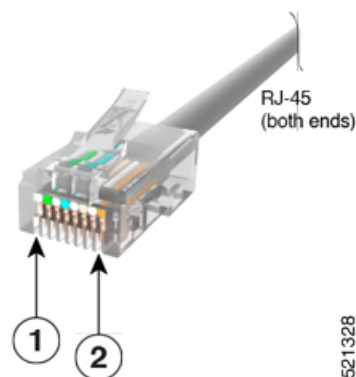

Console Port Pinouts

This following table summarizes the Console port pinouts:

Table 13: Console Port Pinouts

Pin	Signal Name	Direction	Description
1	ACONS-TX	Output	Aux Consoles transmit output, RS232
2	NC	NA	NA
3	CONS-TX	Output	Console RS232 transmit
4	Gnd	NA	Ground
5	Gnd	NA	Ground
6	CONS-RX	Input	Console RS232 receive
7	ACONS-RTX	Input	Aux Consoles receive input, RS232
8	NC	NA	NA

Management Ethernet Port Pinouts

This following table summarizes the Management Ethernet port pinouts:

Table 14: Management and PTP Ethernet Port Pinouts

Pin	Signal Name
1	TRP0+
2	TRP0-
3	TRP1+
4	TRP1-
5	TRP2+
6	TRP2-
7	TRP3+
8	TRP3-

Timing Port Pinouts

The platform is capable of receiving or sourcing timing signals of 1 PPS & 10 MHz. These interfaces are provided by two mini-coax 50-Ohm, 1.0/2.3 DIN series connector on the front panel. Similarly there are two mini-coax 50-Ohm connectors provided in the front panel to output this 1PPS and 10MHz.

This table below summarizes the timing port pinouts:

Table 15: Timing Port Pinouts

	10 MHz (Input and Output)	1PPS (Input and Output)
Waveform	Input—Sine wave Output—Square wave	Input—Rectangular pulse Output—Rectangular pulse
Amplitude	Input— > 1.7 volt p-p(+8 to +10 dBm) Output— > 2.4 volts TTL compatible	Input— > 2.4 volts TTL compatible Output— > 2.4 volts TTL compatible
Impedance	50 ohms	50 ohms
Pulse Width	50% duty cycle	26 microseconds
Rise Time	Input—AC coupled Output—5 nanoseconds	40 nanoseconds

Time-of-Day Port Pinouts

This table summarizes the ToD/1-PPS port pinouts:

Table 16: RJ-45 ToD/1-PPS Port Pinouts

Pin	Signal Name	Direction	Description
1	—	—	—
2	—	—	—
3	1PPS_N	Output or Input	1PPS RS422 signal
4	GND	—	—
5	GND	—	—
6	1PPS_P	Output or Input	1PPS RS422 signal
7	TOD_N	Output or Input	Time-of-Day character
8	TOD_P	Output or Input	Time-of-Day character

USB Port Pinouts

This following table summarizes the USB port pinouts:

Table 17: USB Port Pinouts

Pin	Signal Name	Description
A1	Vcc	+5 VDC

Pin	Signal Name	Description
A2	D-	Data -
A3	D+	Data +
A4	Gnd	Ground

Alarm Port Pinouts

This following table summarizes the external alarm input pinouts:

Table 18: External Alarm Input Pinouts

Pin	Signal Name	Description
1	ALARM0_IN	Alarm input 0
2	ALARM1_IN	Alarm input 1
3	—	—
4	ALARM2_IN	Alarm input 2
5	ALARM3_IN	Alarm input 3
6	—	—
7	—	—
8	ALARM_IN_COMMON	Alarm Input Common

AC Power Cord Specifications

For more information on the supported power cables, see *Ordering information for power cables supported on NCS 540 on the Cisco Network Convergence System 540 Large Density Routers Data Sheet*.



INDEX

C

coaxial cable [19](#)

I

interface ports [57](#)
connecting [57](#)

R

RJ-45 connectors [20](#)
RS-232 asynchronous data [20](#)

