



Configure Segment Routing over IPv6 (SRv6) with Micro-SIDs



Note IOS XR release 7.3.2 supports SRv6 with Full-length SID and Micro-SID formats; however, only one format is supported in the network at a time.

To use SRv6 Micro-SID (uSID), enter the **hw-module profile segment-routing srv6 mode micro-segment format f3216** command in config mode, then reload the router or line card. See [Configuring SRv6, on page 17](#) for more information.

To use SRv6 Full-length SID, see the [Configure Segment Routing over IPv6 \(SRv6\) with Full-Length SIDs](#).

Segment Routing for IPv6 (SRv6) is the implementation of Segment Routing over the IPv6 dataplane.

- [Segment Routing over IPv6 Overview, on page 2](#)
- [SRv6 Micro-Segment \(uSID\), on page 6](#)
- [Usage Guidelines and Limitations, on page 15](#)
- [Configuring SRv6, on page 17](#)
- [Configuring SRv6 under IS-IS, on page 25](#)
- [Configuring SRv6 Flexible Algorithm under IS-IS, on page 26](#)
- [Configuring SRv6 Locator Prefix Summarization, on page 28](#)
- [Configuring TI-LFA with SRv6 IS-IS, on page 28](#)
- [Configuring SRv6 IS-IS Microloop Avoidance, on page 31](#)
- [Configuring Static SIDs, on page 32](#)
- [Configuring SRv6 BGP-Based Services, on page 34](#)
- [SRv6/MPLS L3 Service Interworking Gateway, on page 102](#)
- [L3 EVPN/SRv6 and L3 EVPN/MPLS Interworking Gateway, on page 107](#)
- [L3 EVPN/SRv6 and L3VPN/MPLS Interworking Gateway, on page 110](#)
- [SRv6/MPLS Dual-Connected PE, on page 113](#)
- [SRv6 SID Information in BGP-LS Reporting, on page 114](#)
- [DHCPv4 Relay Agent and Proxy Support over SRv6, on page 115](#)
- [DHCPv6 Relay Agent Support over SRv6, on page 116](#)
- [Full-Replace Migration to SRv6 Micro-SID, on page 117](#)
- [SRv6 Traffic Accounting, on page 121](#)
- [Path Maximum Transmission Unit \(MTU\) Discovery for SRv6 Encapsulated Packets, on page 130](#)

Segment Routing over IPv6 Overview

Segment Routing (SR) can be applied on both MPLS and IPv6 data planes. Segment Routing over IPv6 (SRv6) extends Segment Routing support with IPv6 data plane.

In an SR-MPLS enabled network, an MPLS label represents an instruction. The source nodes programs the path to a destination in the packet header as a stack of labels.

SRv6 introduces the Network Programming framework that enables a network operator or an application to specify a packet processing program by encoding a sequence of instructions in the IPv6 packet header. Each instruction is implemented on one or several nodes in the network and identified by an SRv6 Segment Identifier (SID) in the packet. The SRv6 Network Programming framework is defined in [IETF RFC 8986 SRv6 Network Programming](#).

In SRv6, an IPv6 address represents an instruction. SRv6 uses a new type of IPv6 Routing Extension Header, called the Segment Routing Header (SRH), in order to encode an ordered list of instructions. The active segment is indicated by the destination address of the packet, and the next segment is indicated by a pointer in the SRH.

Figure 1: Network Program in the Packet Header

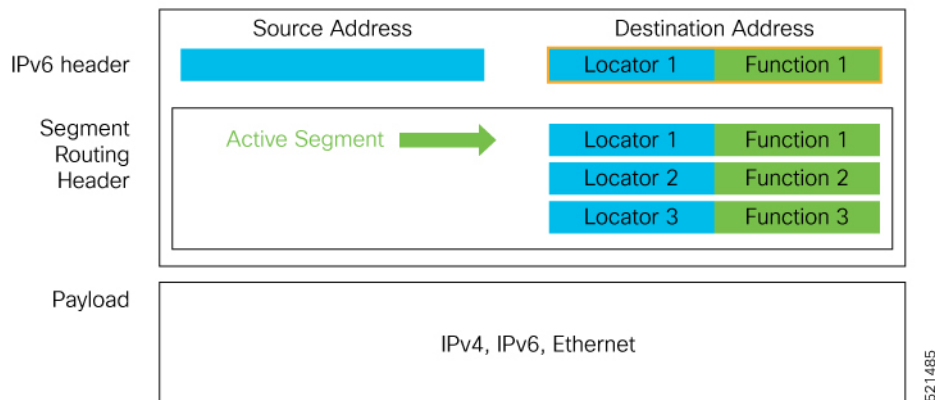

521485

The SRv6 SRH is documented in IETF RFC [IPv6 Segment Routing Header \(SRH\)](#).

The SRH is defined as follows:

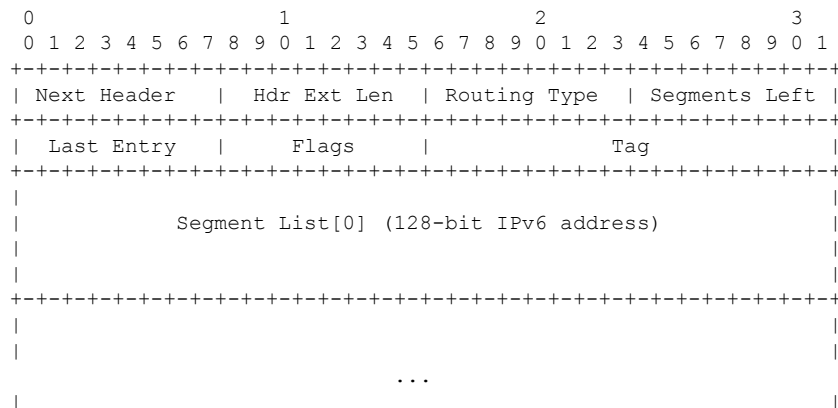

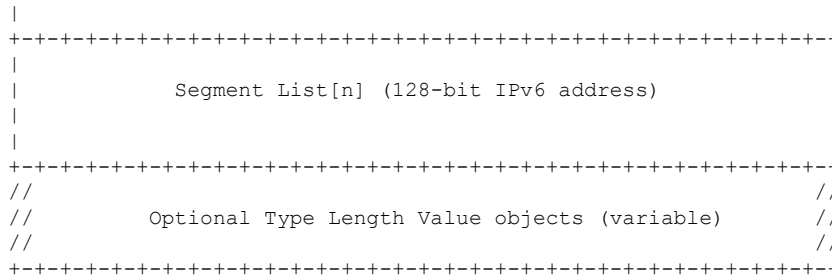

The following list explains the fields in SRH:

- Next header—Identifies the type of header immediately following the SRH.
- Hdr Ext Len (header extension length)—The length of the SRH in 8-octet units, not including the first 8 octets.
- Segments left—Specifies the number of route segments remaining. That means, the number of explicitly listed intermediate nodes still to be visited before reaching the final destination.
- Last Entry—Contains the index (zero based) of the last element of the segment list.
- Flags— Contains 8 bits of flags.
- Tag—Tag a packet as part of a class or group of packets like packets sharing the same set of properties.
- Segment list—128-bit IPv6 addresses representing the *n*th segment in the segment list. The segment list encoding starts from the last segment of the SR policy (path). That means the first element of the segment list (Segment list [0]) contains the last segment of the SR policy, the second element contains the penultimate segment of the SR policy and so on.

In SRv6, a SID represents a 128-bit value, consisting of the following three parts:

- Locator: This is the first part of the SID with most significant bits and represents an address of a specific SRv6 node.
- Function: This is the portion of the SID that is local to the owner node and designates a specific SRv6 function (network instruction) that is executed locally on a particular node, specified by the locator bits.
- Args: This field is optional and represents optional arguments to the function.

The locator part can be further divided into two parts:

- SID Block: This field is the SRv6 network designator and is a fixed or known address space for an SRv6 domain. This is the most significant bit (MSB) portion of a locator subnet.
- Node Id: This field is the node designator in an SRv6 network and is the least significant bit (LSB) portion of a locator subnet.

SRv6 Node Roles

Each node along the SRv6 packet path has a different functionality:

- Source node—A node that can generate an IPv6 packet with an SRH (an SRv6 packet), or an ingress node that can impose an SRH on an IPv6 packet.

- Transit node—A node along the path of the SRv6 packet (IPv6 packet and SRH). The transit node does not inspect the SRH. The destination address of the IPv6 packet does not correspond to the transit node.
- Endpoint node—A node in the SRv6 domain where the SRv6 segment is terminated. The destination address of the IPv6 packet with an SRH corresponds to the end point node. The segment endpoint node executes the function bound to the SID

SRv6 Head-End Behaviors

The SR Headend with Encapsulation behaviors are documented in the [IETF RFC 8986 SRv6 Network Programming](#).

The SR Headend with Insertion head-end behaviors are documented in the following IETF draft:

<https://datatracker.ietf.org/doc/draft-filsfils-spring-srv6-net-pgm-insertion/>

This section describes a set of SR Policy headend behaviors. The following list summarizes them:

- H.Encaps—SR Headend Behavior with Encapsulation in an SRv6 Policy
- H.Encaps.Red—H.Encaps with Reduced Encapsulation
- H.Insert—SR Headend with insertion of an SRv6 Policy
- H.Insert.Red—H.Insert with reduced insertion

SRv6 Endpoint Behaviors

The SRv6 endpoint behaviors are documented in the [IETF RFC 8986 SRv6 Network Programming](#).

The following is a subset of defined SRv6 endpoint behaviors that can be associated with a SID.

- End—Endpoint function. The SRv6 instantiation of a Prefix SID [[RFC8402](#)].
- End.X—Endpoint with Layer-3 cross-connect. The SRv6 instantiation of an Adj SID [[RFC8402](#)].
- End.DX6—Endpoint with decapsulation and IPv6 cross-connect (IPv6-L3VPN - equivalent to per-CE VPN label).
- End.DX4—Endpoint with decapsulation and IPv4 cross-connect (IPv4-L3VPN - equivalent to per-CE VPN label).
- End.DT6—Endpoint with decapsulation and IPv6 table lookup (IPv6-L3VPN - equivalent to per-VRF VPN label).
- End.DT4—Endpoint with decapsulation and IPv4 table lookup (IPv4-L3VPN - equivalent to per-VRF VPN label).
- End.DT46—Endpoint with decapsulation and specific IP table lookup (IP-L3VPN - equivalent to per-VRF VPN label).
- End.DX2—Endpoint with decapsulation and L2 cross-connect (L2VPN use-case).
- End.B6.Encaps—Endpoint bound to an SRv6 policy with encapsulation. SRv6 instantiation of a Binding SID.
- End.B6.Encaps.RED—End.B6.Encaps with reduced SRH. SRv6 instantiation of a Binding SID.

SRv6 Endpoint Behavior Variants

Depending on how the SRH is handled, different behavior variants are defined for the End and End.X behaviors. The End and End.X behaviors can support these variants, either individually or in combinations.

- **Penultimate Segment Pop (PSP) of the SRH variant**—An SR Segment Endpoint Nodes receive the IPv6 packet with the Destination Address field of the IPv6 Header equal to its SID address.

A penultimate SR Segment Endpoint Node is one that, as part of the SID processing, copies the last SID from the SRH into the IPv6 Destination Address and decrements the Segments Left value from one to zero.

The PSP operation takes place only at a penultimate SR Segment Endpoint Node and does not happen at non-penultimate endpoint nodes. When a SID of PSP-flavor is processed at a non-penultimate SR Segment Endpoint Node, the PSP behavior is not performed since Segments Left would not be zero.

The SR Segment Endpoint Nodes advertise the SIDs instantiated on them via control plane protocols. A PSP-flavored SID is used by the Source SR Node when it needs to instruct the penultimate SR Segment Endpoint Node listed in the SRH to remove the SRH from the IPv6 header.

- **Ultimate Segment Pop (USP) of the SRH variant**—The SRH processing of the End and End.X behaviors are modified as follows:

If Segments Left is 0, then:

1. Update the Next Header field in the preceding header to the Next Header value of the SRH
2. Decrease the IPv6 header Payload Length by $8 * (\text{Hdr Ext Len} + 1)$
3. Remove the SRH from the IPv6 extension header chain
4. Proceed to process the next header in the packet

One of the applications of the USP flavor is when a packet with an SRH is destined to an application on hosts with smartNICs implementing SRv6. The USP flavor is used to remove the consumed SRH from the extension header chain before sending the packet to the host.

- **Ultimate Segment Decapsulation (USD) variant**—The Upper-layer header processing of the End and End.X behaviors are modified as follows:

- **End** behavior: If the Upper-layer Header type is 41 (IPv6), then:
 1. Remove the outer IPv6 Header with all its extension headers
 2. Submit the packet to the egress IPv6 FIB lookup and transmission to the new destination
 3. Else, if the Upper-layer Header type is 4 (IPv4)
 4. Remove the outer IPv6 Header with all its extension headers
 5. Submit the packet to the egress IPv4 FIB lookup and transmission to the new destination
 6. Else, process as per Section 4.1.1 (Upper-Layer Header) of [IETF RFC 8986 SRv6 Network Programming](#)
- **End.X** behavior: If the Upper-layer Header type is 41 (IPv6) or 4 (IPv4), then:
 1. Remove the outer IPv6 Header with all its extension headers
 2. Forward the exposed IP packet to the L3 adjacency J

3. Else, process as per Section 4.1.1 (Upper-Layer Header) of [IETF RFC 8986 SRv6 Network Programming](#)

One of the applications of the USD flavor is the case of TI-LFA in P routers with encapsulation with H.Encaps. The USD flavor allows the last Segment Endpoint Node in the repair path list to decapsulate the IPv6 header added at the TI-LFA Point of Local Repair and forward the inner packet.

SRv6 Micro-Segment (uSID)

Table 1: Feature History Table

Feature Name	Release Information	Feature Description
Cisco NC57 Native Mode: SRv6 Micro-Segment (uSID)	Release 7.5.2	<p>SRv6 Micro-Segment (uSID) is an extension of the SRv6 architecture. It leverages the existing SRv6 Network Programming architecture to encode up to six SRv6 Micro-SID (uSID) instructions within a single 128-bit SID address. Such a SID address is called a uSID Carrier.</p> <p>The following features are now supported on Cisco NCS 5700 series fixed port routers and the Cisco NCS 5500 series routers that have Cisco NC57 line cards installed and operating in the native mode:</p> <ul style="list-style-type: none"> • SRv6 Micro SID (uSID) • IS-IS: Configuring TI-LFA with SRv6 IS-IS, Configuring SRv6 IS-IS Microloop Avoidance, Configuring SRv6 Flexible Algorithm under IS-IS • SRv6 BGP Services: SRv6 Services: IPv4 L3VPN, SRv6 Services: IPv6 L3VPN, SRv6 Services: IPv4 BGP Global, SRv6 Services: IPv6 BGP Global • SRv6 Services: Configuring SRv6 BGP-Based Services (IPv4 BGP global, IPv6 BGP global), SRv6 Services: EVPN VPWS — All-Active Multi-Homing • SRv6/MPLS L3 Service Interworking Gateway

Feature Name	Release Information	Feature Description
SRv6 Micro-Segment (uSID)	Release 7.3.1	<p>This feature is an extension of the SRv6 architecture. It leverages the existing SRv6 Network Programming architecture to encode up to six SRv6 Micro-SID (uSID) instructions within a single 128-bit SID address. Such a SID address is called a uSID Carrier.</p> <p>In addition, this feature leverages the existing SRv6 data plane and control plane with no changes. It also provides low MTU overhead; for example, 6 uSIDs per uSID carrier results in 18 source-routing waypoints in only 40 bytes of overhead (in SRH).</p>

The SRv6 micro-segment (uSID) is an extension of the SRv6 architecture. It leverages the SRv6 Network Programming architecture to encode several SRv6 Micro-SID (uSID) instructions within a single 128-bit SID address. Such a SID address is called a uSID Carrier.

SRv6 uSID is documented in the IETF drafts [Network Programming extension: SRv6 uSID instruction](#) and [Compressed SRv6 Segment List Encoding in SRH](#).

Throughout this chapter, we will refer to SRv6 micro-segment as “uSID”.

The SRv6 uSID provides the following benefits:

- Leverages the SRv6 Network Programming with no change. SRv6 uSID is a new pseudo code in the existing SRv6 network programming framework.
- Leverages the SRv6 data plane (SRH) with no change. Any SID in the destination address or SRH can be an SRv6 uSID carrier.
- Leverages the SRv6 control plane with no change.
- Ultra-Scale—Scalable number of globally unique nodes in the domain, for example:
 - 16-bit uSID ID size: 65k uSIDs per domain block
 - 32-bit uSID ID size: 4.3M uSIDs per domain block
- Lowest MTU overhead
 - 6 uSIDs per uSID carrier
 - For example, 18 source-routing waypoints in only 40 bytes of overhead
- Hardware-friendliness:
 - Leverages mature hardware capabilities (inline IP Destination Address edit, IP Destination Address longest match).
 - Avoids any extra lookup in indexed mapping tables.
 - A micro-program with 6 or fewer uSIDs requires only legacy IP-in-IP encapsulation behavior.
- Scalable Control Plane:
 - Summarization at area/domain boundary provides massive scaling advantage.

- No routing extension is required, a simple prefix advertisement suffices.
- Seamless Deployment:
 - A uSID may be used as a SID (the carrier holds a single uSID).
 - The inner structure of an SR Policy can stay opaque to the source. A carrier with uSIDs is just seen as a SID by the policy headend Security.
 - Leverages SRv6's native SR domain security.

SRv6 uSID Terminology

The SRv6 Network Programming is extended with the following terms:

- uSID—An identifier that specifies a micro-segment.

A uSID has an associated behavior that is the SRv6 function (for example, a node SID or Adjacency SID) associated with the given ID. The node at which an uSID is instantiated is called the “Parent” node.

- uSID Carrier—A 128-bit IPv6 address (carried in either in the packet destination address or in the SRH) in the following format:

```
<uSID-Block><Active-uSID><Next-uSID>...<Last-uSID><End-of-Carrier>...<End-of-Carrier>
```

where:

- uSID Block—An IPv6 prefix that defines a block of SRv6 uSIDs.
- Active uSID—The first uSID that follows the uSID block.
- Next uSID—The next uSID after the Active uSID.
- Last uSID—The last uSID in the carrier before the End-of-Carrier uSID.
- End-of-Carrier —A globally reserved uSID that marks the end of a uSID carrier. The End-of-Carrier ID is **0000**. All empty uSID carrier positions must be filled with the End-of-Carrier ID; therefore, a uSID carrier can have more than one End-of-Carrier.

The following is an example of an SRH with 3 Micro-SID carriers for a total of up to 18 micro-instructions:

Micro-SID Carrier1: {uInstruction1, uInstruction2... uInstruction6}
Micro-SID Carrier2: {uInstruction7, uInstruction8... uInstruction12}
Micro-SID Carrier3: {uInstruction13, uInstruction14... uInstruction18}

SRv6 uSID Carrier Format

The uSID carrier format specifies the type of uSID carrier supported in an SRv6 network. The format specification includes Block size and ID size.

- **uSID Block**

The uSID block is an IPv6 prefix that defines a block of SRv6 uSIDs. This can be an IPv6 prefix allocated to the provider (for example, /22, /24, and so on.), or it can be any well-known IPv6 address block generally available for private use, such as the ULA space FC/8, as defined in IETF draft [RFC4193](#).

An SRv6 network may support more than a single uSID block.

The length of block [prefix] is defined in bits. From a hardware-friendliness perspective, it is expected to use sizes on byte boundaries (16, 24, 32, and so on).

- **uSID ID**

The length of uSID ID is defined in bits. From a hardware-friendliness perspective, it is expected to use sizes on byte boundaries (8, 16, 24, 32, and so on).

The uSID carrier format is specified using the notation "Fbbuu", where "bb" is size of block and "uu" is size of ID. For example, "F3216" is a format with a 32-bit uSID block and 16-bit uSID IDs.



Note F3216 is the default format, and the only format that is supported in IOS XR 7.3.1 release.

SRv6 uSID Allocation Within a uSID Block

The architecture for uSID specifies both globally scoped and locally scoped uSIDs, where a globally scoped uSID is the type of uSID that provides reachability to the node.

On the other hand, a locally scoped uSID is associated to a local behavior, and therefore *must* be preceded by a globally scoped uSID of the parent node when relying on routing to forward the packet.

The Global ID block (GIB) is the set of IDs available for globally scoped uSID allocation. The Local ID block (LIB) is the set of IDs available for locally scoped uSID allocation.

A globally scoped uSID is a uSID from the GIB. A globally scoped uSID typically identifies a shortest path to a node in the SR domain. An IP route (for example, /48) is advertised by the parent node to each of its globally scoped uSIDs, under the associated uSID block. The parent node executes a variant of the END behavior.

The "Nodal" uSID (uN) is an example of a globally scoped behavior defined in uSID architecture.

A node can have multiple globally scoped uSIDs under the same uSID blocks (for example, one per IGP flex-algorithm). Multiple nodes may share the same globally scoped uSID (Anycast).

A locally scoped uSID is a uSID from the LIB. A locally scoped uSID identifies a local micro-instruction on the parent node; for example, it may identify a cross-connect to a direct neighbor over a specific interface or a VPN context. Locally scoped uSIDs are not routeable.

For example, if N1 and N2 are two different physical nodes of the uSID domain and *L* is a locally scoped uSID value, then N1 and N2 may bind two different behaviors to *L*.

The uSIDs are allocated in one of following ways: auto, dynamic, or explicit.

- The request to allocate locally scoped uSIDs comes from SRv6 clients (such as IS-IS or BGP). The request can be to allocate any available ID (dynamic allocation) or to allocate a specific ID (explicit allocation).

SRv6 Endpoint Behaviors Associated with uSID

The SRv6 Network Programming is extended with new types of SRv6 SID endpoint behaviors:

- uN—A short notation for the NEXT-CSID (Compressed SID) End behavior with a pseudocode of shift-and-lookup, and PSP/USD flavors
- uA—A short notation for the NEXT-CSID End.X behavior with a pseudocode of shift-and-xconnect, and PSP/USD flavors
- uDT—A short notation for the NEXT-CSID End.DT behavior with the same pseudocode as End.DT4/End.DT6/End.DT46/End.DT2U/End.DT2M
- uDX—A short notation for the NEXT-CSID End.DX behavior with the same pseudocode as End.DX4/End.DX6/End.DX2

SRv6 uSID in Action - Example

This example highlights an integrated VPN and Traffic Engineering use-case leveraging SRv6 uSID.

VPNv4 site A connected to Node 1 sends packets to VPNv4 site B connected to Node 2 alongside a traffic engineered path via Node 8 and Node 7 using a single 128-bit SRv6 SID.

Node 1 is the ingress PE; Node 2 is the egress PE.

Nodes 3, 4, 5, and 6 are classic IPv6 nodes. Traffic received on these nodes use classic IP forwarding without changing the outer DA.

Nodes 1, 8, 7 and 2 are SRv6 capable configured with:

- 32-bit SRv6 block = fcbb:bb01
- 16-bit SRv6 ID

For example:

- Node 7 uN = fcbb:bb01:0700::/48
- Node 8 uN = fcbb:bb01:0800::/48

The following IGP routes are advertised:

- Node 8 advertises the IGP route fcbb:bb01:**0800**::/48
- Node 7 advertises the IGP route fcbb:bb01:**0700**::/48
- Node 2 advertises the IGP route fcbb:bb01:**0200**::/48

Figure 2: Integrated VPN and Traffic Engineering SRv6 uSID Use-case

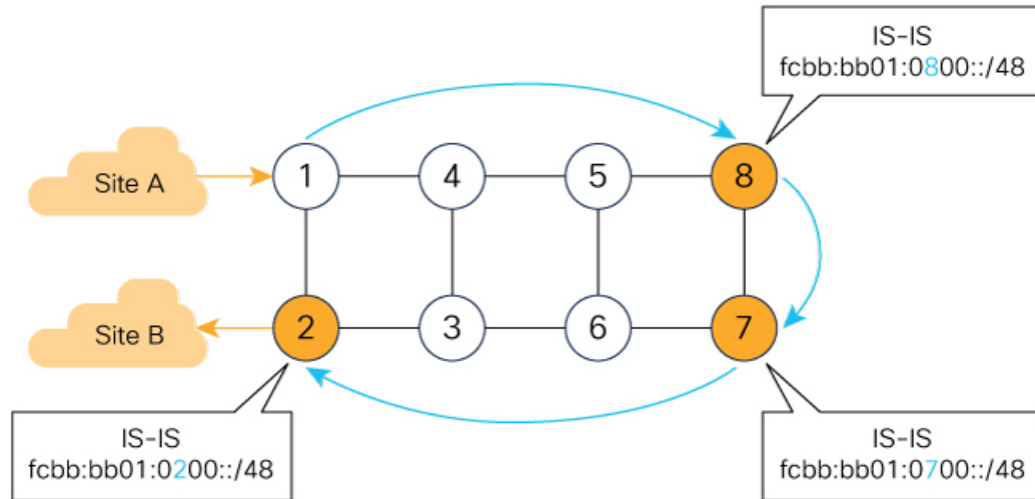

- Node 1 encapsulates IPv4 packet from Site A and sends an IPv6 packet with DA = `fcbb:bb01:0800:0700:0200:f001:0000:0000`
- Traffic engineered path via 8 and 7 using a single 128-bit SRv6 SID
- One single micro-program in the DA is enough

521410

Node 1 encapsulates an IPv4 packet from VPN Site A and sends an IPv6 packet with destination address `fcbb:bb01:0800:0700:0200:f001:0000:0000`. This is a uSID carrier, with a list of micro-instructions (uSIDs) (0800, 0700, 0200, f001, and 0000 – indicating the end of the instruction).

uSIDs (uNs) 0800, 0700, 0200 are used to realize the traffic engineering path to Node 2 with way points at Nodes 8 and 7. uSID f001 is the BGP-signalled instruction (uDT4) advertised by Node 2 for the VPNv4 service

Figure 3: Node 1: End.B6.Encaps Behavior

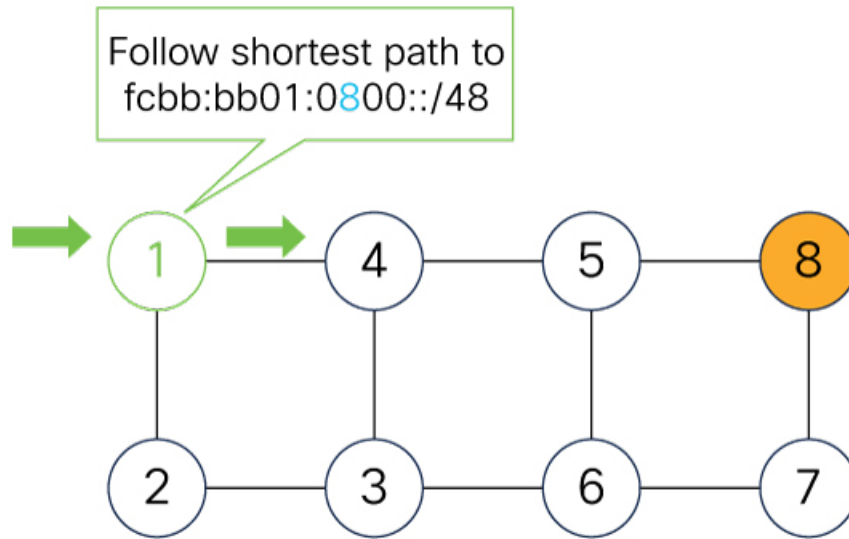

DA = fcbb:bb01:0800:0700:0200:f001:0000:0000

521411

Nodes 4 and 5 simply forward the packet along the shortest path to Node 8, providing seamless deployment through classic IPv6 nodes.

Figure 4: Node 4 and Node 5: Classic IPv6 Nodes

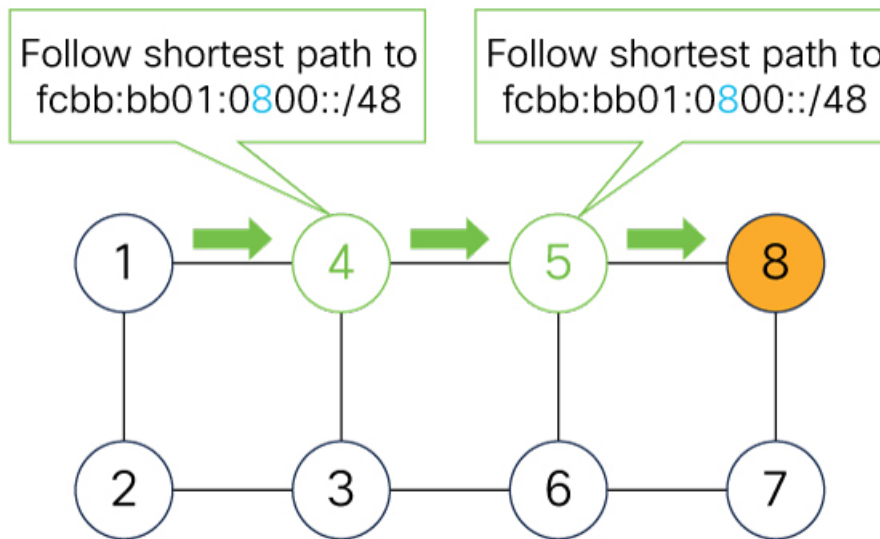

DA = fcbb:bb01:0800:0700:0200:f001:0000:0000

521412

When Node 8 receives the packet, it performs SRv6 uN behavior (shift-and-lookup with PSP/USD). It removes its outer DA (0800) and advances the micro program to the next micro instruction by doing the following:

1. Pops its own uSID (0800)

2. **Shifts** the remaining DA by 16-bits to the left
3. Fills the remaining bits with 0000 (End-of-Carrier)
4. Performs a **lookup** for the shortest path to the next DA (fcbb:bb01:0700::/48)
5. Forwards it using the new DA fcbb:bb01:0700:0200:f001:0000:0000:0000

Figure 5: Node 8: SRv6 uN Behavior (Shift and Forward)

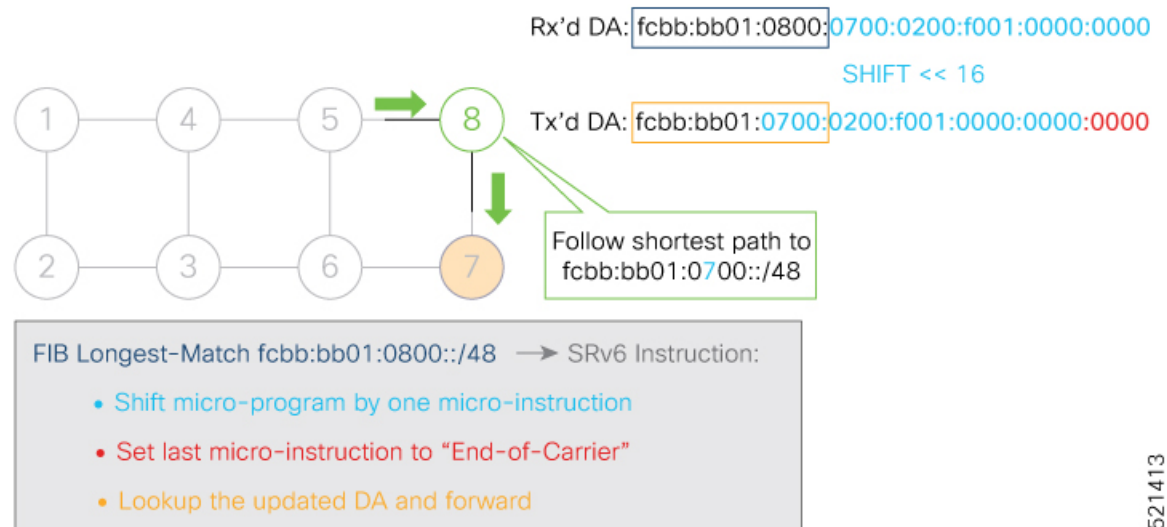

521413

When Node 7 receives the packet, it performs the same SRv6 uN behavior (shift-and-lookup with PSP/USD), forwarding it using the new DA fcbb:bb01:0200:f001:0000:0000:0000:0000

Figure 6: Node 7: SRv6 uN Behavior (Shift and Forward)

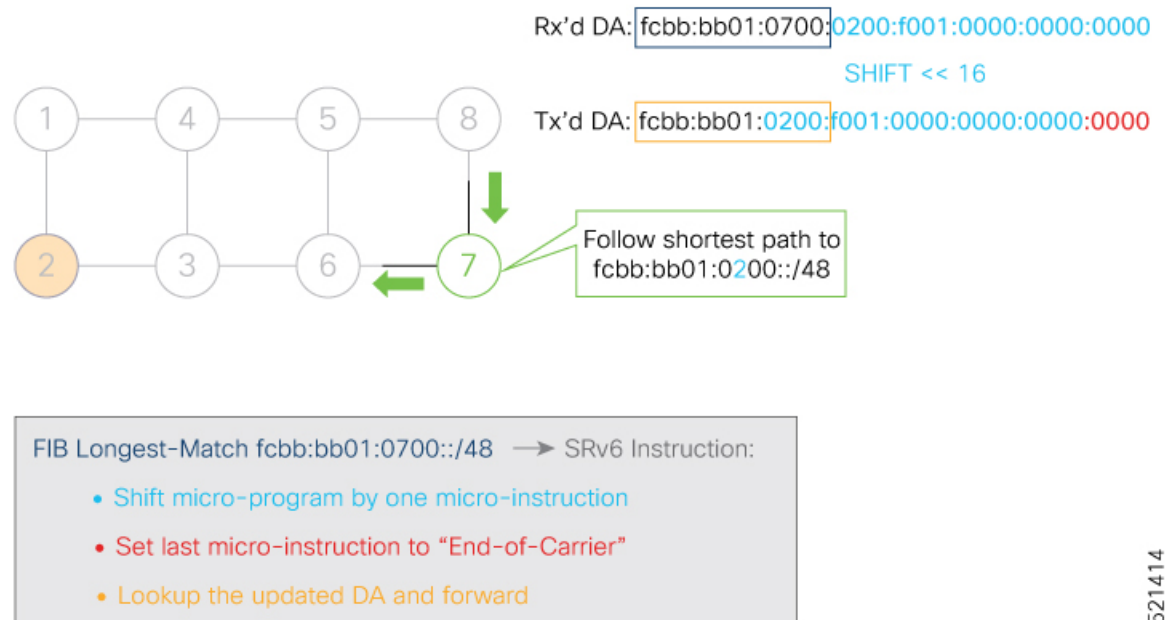

521414

Nodes 6 and 3 simply forward the packet along the shortest path to Node 2, providing seamless deployment through classic IPv6 nodes.

Figure 7: Node 6 and Node 3: Classic IPv6 Nodes

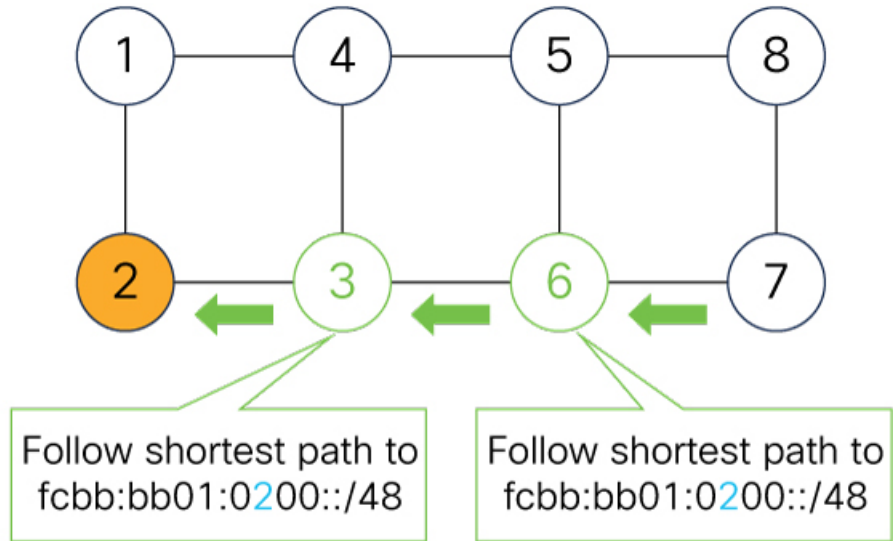

521415

DA = fcbb:bb01:0200:f001:0000:0000:0000:0000

When Node 2 receives the packet, it performs an SRv6 uDT4 behavior (End.DT4—Endpoint with decapsulation and IPv4 table lookup) to VPNv4 Site B.

Figure 8: Node 2: SRv6 uDT4 Behavior

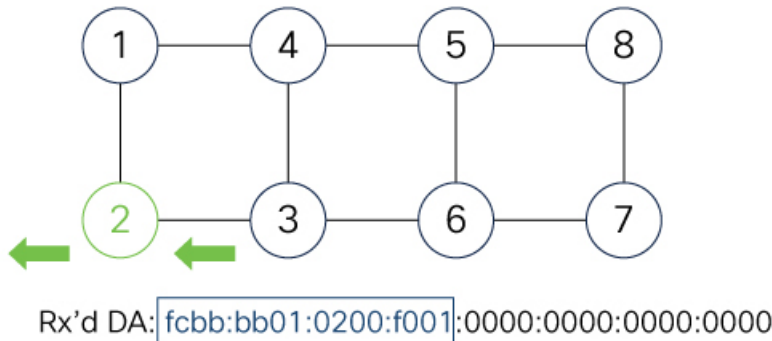

FIB Longest-Match fcbb:bb01:0200:f001::/64 → SRv6 Instruction:

- Decapsulate and Lookup of inner IPv4 packet

521416

To recap, this example showed an integrated VPN and Traffic Engineering use-case, where VPNv4 site A connected to Node 1 sent packets to VPNv4 site B connected to Node 2 alongside a traffic engineered path via Node 8 and Node 7 using a single 128-bit SRv6 SID:

- @1: inner packet P encapsulated with outer DA fcbb:bb01:0800:0700:0200:f001:0000:0000

- @4 & @5: classic IP forwarding, outer DA unchanged
- @8: SRv6 uN behavior: shift and lookup, outer DA becomes fcbb:bb01:0700:0200:f001:0000:0000:0000
- @7: SRv6 uN behavior: shift and lookup, outer DA becomes fcbb:bb01:0200:f001:0000:0000:0000:0000
- @6 & @3: classic IP forwarding, outer DA unchanged
- @2: SRv6 End.DT4: Decapsulate and IPv4 table lookup

Usage Guidelines and Limitations

General Guidelines and Limitations

- Cisco IOS XR supports uSIDs with 32-bit uSID block and 16-bit uSID IDs (3216).
A single UCF format must be used for uSID locators in a SRv6 uSID domain.
- Cisco IOS XR supports up to 8 uSID locator prefixes.
Multiple locator prefixes are used when configuring Anycast locators or SRv6 Flexible Algorithm instances, for example.
- Cisco IOS XR supports uSID locator prefixes from different uSID blocks.
Up to 64 uSID blocks can be used across all uSID locators in the network.
- Cisco IOS XR Release 7.3.1 and later supports the following SRv6 uSID behaviors and variants:
 - uN with PSP/USD
 - uA with PSP/USD
 - uDT4
 - uDT6
- SRv6 Underlay support includes:
 - IGP redistribution/leaking between levels
 - Prefix Summarization on ABR routers
 - IS-IS TI-LFA
 - Microloop Avoidance
 - Flex-algo
- SRv6 over GRE interface is not supported
- SRv6 over BVI interface is not supported

uSID Allocation Recommendation

We recommend that the uSID block allocation is made from the IPv6 Unique Local Address (ULA) range.



Note Allocation from the public Global Unicast Addresses (GUA) range is also supported.

- Use ULA /24 base from FC00::/8 space
 - FCBB:BB/24, with *B* indicating a nibble value picked by operator
- 256 uSID blocks possible from this allocation
 - In this release, 64 uSID blocks are supported
 - FCBB:BBVV/32, with *VV* two variable nibbles. The supported values for *VV* in Cisco IOS XR Release 7.3.1 are 0x00 to 0x3F.

For example:

- ULA /24 base = FC00:01/24
- uSID block space = 64 uSID blocks (from FC00:0100/32 to FC00:013F/32)

Platform-Specific Guidelines and Limitations

SRv6 is supported on NCS 5500 series routers and NCS 5700 series routers/NC57 line cards.

This release supports the following SID Encap budget:

- P role:
 - Underlay H-Insert: 6 sids (1 carrier with 6 sids per carrier)
- PE role:
 - Underlay H-Insert: 3 sids (1 carrier with 3 sids per carrier)
 - Overlay H-Encaps: 3 sids (1 carrier with 3 sids per carrier)

SRv6 is supported on NCS 5500 series routers and NCS 5700 series routers/NC57 line cards.

This release supports the following SID Encap budget:

- P role:
 - Underlay H-Insert: 6 sids (1 carrier with 6 sids per carrier)
- PE role:
 - Underlay H-Insert: 3 sids (1 carrier with 3 sids per carrier)
 - Overlay H-Encaps: 3 sids (1 carrier with 3 sids per carrier)

Configuring SRv6

Table 2: Feature History Table

Feature Name	Release Information	Feature Description
SRv6 Traffic Class DSCP Marking Enhancement for QoS	Release 24.2.1	<p><i>Introduced in this release on: NCS 5500 fixed port routers; NCS 5500 modular routers</i></p> <p>This feature allows you to set the traffic class values to use the full range of DSCP (6 bits) for SRv6 packets that are encapsulated.</p> <p>The feature extends the existing policy-map setting of 3-bit traffic class DSCP marking to 6 bits using the new policy-map-extend option in the configuration for L2 and L3 traffic for SRv6.</p> <p>This is a mutually inclusive feature for L2 and L3 traffic. Therefore, this feature cannot be used in the individual configuration for L2 and L3 traffic.</p> <p>This feature introduces this change:</p> <p>CLI: The policy-map-extend keyword is introduced in the hw-module profile segment-routing srv6 mode microsegment f3216 encapsulation traffic-class command.</p>
SRv6 Traffic Class QoS Enhancement	Release 7.7.1	<p>The modified hw-module profile segment-routing srv6 mode command option provides you with better flexibility to customize the optional SRv6 encapsulation parameters. The updated command supports both L2 and L3 traffic types of SRv6 parameters.</p> <p>Encapsulation is a sub-mode from Release 7.7.1.</p> <p>The l3-traffic configuration supports the additional policy-map option that sets SRv6 traffic-class DSCP based on qos-group selected by input policy-map.</p> <p>The following commands are updated:</p> <ul style="list-style-type: none"> hw-module profile segment-routing srv6 mode: Mode is a mandatory parameter <p>The following commands are introduced:</p> <ul style="list-style-type: none"> encapsulation l2-traffic encapsulation l3-traffic

Enabling SRv6 involves the following high-level configuration steps:

- Enable SRv6 on the platform
- Configure SRv6 locator(s)
- Enable SRv6 under IS-IS
- Enable SRv6 Services under BGP

Enable SRv6 on the Platform

Before configuring SRv6 on the Cisco NCS 5500 Series Routers router, you must first use the following command:

- **hw-module profile segment-routing srv6 mode micro-segment format f3216**



Note You must reload the router after enabling this command.

(Optional) Configure Network Role

By default, after enabling SRv6 on the platform, the node can serve as both edge (services) and core roles.

Optionally, you can customize the node role as "core-only" using the following command:

- **hw-module profile network-role core-only**



Note You must reload the router after enabling this command.

Given that there is different budget for underlay SID encap based on the node role in the network (P-only vs Edge), an operator can use this configuration to provide a hint to the platform and control plane to use a larger SID encap budget when operating as a P-only node.

(Optional) Configure Merge Overlay/Underlay SID Mode

One of the main benefits of SRv6 uSID is compression (or packing) of multiple uSIDs into a uSID carrier. This is possible when they share the same uSID block and when there is enough space in the carrier.

The underlay SIDs are always programmed in compressed form, if possible. The overlay SID is programmed separately.

The **segment-routing srv6 micro-segment merge-overlay-underlay-sids** command is used to enable the platform to merge overlay/underlay SIDs.



Note From Cisco IOS XR Release 7.7.1 and later, the compression/merging of uSID lists is automatically done in the dataplane during imposition. This configuration option is ignored by the dataplane.

When there is a need to send overlay traffic, the data path implementation attempts to merge the underlay SIDs and overlay SIDs into a single carrier, if possible. With H.Encaps.Red encapsulation, this yields a packet with no SRH.



Note If the overlay and underlay use different uSID blocks, this merge is not possible.

By default, the Cisco NCS platform does not automatically merge the overlay/underlay SIDs.

To enable the platform to merge overlay/underlay SIDs, use the following command:

- **segment-routing srv6 micro-segment merge-overlay-underlay-sids**



Caution This command should only be enabled when a single block is required.

After you enable this command, this CLI will modify the behavior for all new overlay routes being programmed afterwards.

If you enable this command after SRv6 overlay routes are already programmed, we recommend that you clear the SRv6 overlay routes (using the **clear route [vrf WORD]** command) in order to trigger the re-programming in the “merge” mode.

If you do not clear the overlay routes, those routes would continue to be programmed in the “non-merge” mode.

(Optional) Customize SRv6 Encapsulation Parameters

From Cisco IOS XR Release 7.7.1, the **hw-module profile segment-routing srv6 mode** command has been updated to support both L2 and L3 traffic types of SRv6 parameters. The existing traffic-class CLI (common to L2 and L3) is still accepted in the ASCII format, but will be converted into the new **l2-traffic** and **l3-traffic** submenu format after the config is committed.

From Cisco IOS XR Release 7.7.1, ensure that you use mandatory keyword **mode**. Note that **encapsulation** is now a sub-mode and not a configuration option.

The following example shows how to configure the traffic-class field settings on the IPv6 header:

```
Router(config)#hw-module profile segment-routing srv6 mode micro-segment format f3216
Router(config-srv6)#encapsulation
Router(config-srv6-encap)#l2-traffic
Router(config-srv6-encap-l2)#traffic-class propagate
```

```
Router(config)#hw-module profile segment-routing srv6 mode micro-segment format f3216
Router(config-srv6)#encapsulation
Router(config-srv6-encap)#l3-traffic
Router(config-srv6-encap-l3)#traffic-class policy-map
```

```
Router(config)#hw-module profile segment-routing srv6 mode micro-segment format f3216
Router(config-srv6)#encapsulation
Router(config-srv6-encap)#traffic-class policy-map-extend
```

The **l2-traffic** and **l3-traffic** are SRv6 parameters for L2 traffic type and L3 traffic type respectively. The **traffic-class** parameter controls the traffic-class field of SRv6 IPv6 header for inner L2 and L3 traffic. Use **propagate** to set the traffic-class value by propagation (from incoming packet/frame). Use **policy-map** to set traffic-class DSCP to qos-group selected by input policy-map.

The **l3-traffic** configuration supports the additional **policy-map** option that sets SRv6 traffic-class DSCP based on qos-group selected by input **policy-map**.

The **l2-traffic** configuration continues to support the **propagate** option that sets the SRv6 traffic-class based on either the inner packet (default) or input **policy-map** (if match action found).

Starting with Cisco IOS XR Software Release 24.2.1, both the L2 and L3 traffic configurations support the **policy-map-extend** option to set the SRv6 traffic-class DSCP marking to 6 bits. This is a mutually inclusive feature for L2 and L3 traffic. Therefore, this feature cannot be used in the individual configuration for L2 and L3 traffic.

When you use the **policy-map-extend** keyword in the **hw-module profile segment-routing srv6 mode microsegment f3216 encapsulation traffic-class** CLI, the existing 3-bit DSCP marking set by the **hw-module profile segment-routing srv6 mode microsegment f3216 encapsulation traffic-class l3-traffic policy-map** CLI in the L3 traffic configuration is modified to 6-bits.

Go through the following topics for more information on the CLI:

- [hw-module profile segment-routing srv6 mode](#)
- [encapsulation l2-traffic](#)
- [encapsulation l3-traffic](#)
- [traffic-class policy-map-extend](#)

Specify the *value* (as 2 hexadecimal nibbles) for traffic class; valid values are from 0x0 to 0xff.

Configure SRv6 Locator Name, Prefix, and uSID-Related Parameters

This section shows how to globally enable SRv6 and configure locator.

- **segment-routing srv6 locators locator** *locator*—Globally enable SRv6 and configure the locator.
- **segment-routing srv6 locators locator** *locator* **prefix** *ipv6_prefix/length*—Configure the locator prefix value.
- **segment-routing srv6 locators locator** *locator* **micro-segment behavior unode psp-usd**—Specifies the locator as a micro-segment (uSID) locator as well as specifies that IGP underlay uSID (uN/uA) variant is PSP-USD for this locator.

(Optional) Configure Algorithm Associated with Locator

- **segment-routing srv6 locators locator** *locator* **algorithm** *algo*—(Optional) Configure Algorithm associated with the locator. Valid values for *algo* are from 128 to 255.

For additional information about SRv6 Flexible Algorithm, see [Configuring SRv6 Flexible Algorithm under IS-IS, on page 26](#).

For detailed information about Flexible Algorithm, see [Enabling Segment Routing Flexible Algorithm](#).

(Optional) Configure Anycast Locator

An SRv6 Anycast locator is a type of locator that identifies a set of nodes (uN SIDs). SRv6 Anycast Locators and their associated uN SIDs may be provisioned at multiple places in a topology.

The set of nodes (Anycast group) is configured to advertise a shared Anycast locator and uN SID. Anycast routing enables the steering of traffic toward multiple advertising nodes. Packets addressed to an Anycast address are forwarded to the topologically nearest nodes.

One use case is to advertise Anycast uN SIDs at exit points from an SRv6 network. Any of the nodes that advertise the common uN SID could be used to forward traffic out of the SRv6 portion of the network to the topologically nearest node.

The following behaviors apply to Anycast Locator:

- Unlike a normal locator, IS-IS does not program or advertise uA SIDs associated with an Anycast locator.
- uN SIDs allocated from Anycast locators will not be used in constructing TI-LFA backup paths or Microloop Avoidance primary paths. TI-LFA backup and Microloop Avoidance paths for an Anycast locator prefix may terminate on any node advertising that locator, which may be different from the node terminating the original primary path.
- SRv6 anycast locators may have non-zero algorithm (Flexible Algorithm) values.

Use the following commands to configure the Anycast locator and advertise Anycast prefixes associated with an interface.

- **segment-routing srv6 locators locator locator anycast**—Configure the Anycast locator
- **router isis instance-id interface Loopback instance prefix-attributes anycast level level**—Advertise the Anycast prefixes associated with an interface.

Example 1:

The following example shows how to globally enable SRv6 and configure a locator.

```
Router(config)# segment-routing srv6
Router(config-srv6)# locators
Router(config-srv6-locators)# locator myLoc1
Router(config-srv6-locator)# micro-segment behavior unode psp-usd
Router(config-srv6-locator)# prefix 2001:0:8::/48
```

Example 2:

The following example shows how to configure Flexible Algorithm associated with locator.

```
Router(config)# segment-routing srv6
Router(config-srv6)# locators
Router(config-srv6-locators)# locator myLocAlgo128
Router(config-srv6-locator)# algorithm 128
Router(config-srv6-locator)# micro-segment behavior unode psp-usd
Router(config-srv6-locator)# prefix 2001:0:88::/48
```

Example 3:

The following example shows how to configure Anycast locator.

```
Router(config)# segment-routing srv6
Router(config-srv6)# locators
Router(config-srv6-locators)# locator myLocAnycast
Router(config-srv6-locator)# anycast
Router(config-srv6-locator)# micro-segment behavior unode psp-usd
Router(config-srv6-locator)# prefix 2001:0:100::/48
```

The following example shows how to advertise the Anycast prefixes associated with an interface.

```
Router(config)# router isis core
Router(config-isis)# interface Loopback100
```

```
Router(config-isis-if) # prefix-attributes anycast level 1
```

(Optional) Customize SRv6 Encapsulation Parameters

This section describes the configurable SRv6 encapsulation parameters. These optional parameters include:

- **segment-routing srv6 encapsulation source-address** *ipv6-addr*—Source Address of outer encapsulating IPv6 header. The default source address for encapsulation is one of the loopback addresses.
- **segment-routing srv6 encapsulation hop-limit** {*count* | **propagate**}—The hop limit of outer-encapsulating IPv6 header. The range for *count* is from 1 to 254 for NCS 5500 and from 1 to 255 for NCS 5700; the default value for hop-limit is 254. Use **propagate** to set the hop-limit value by propagation (from incoming packet/frame).



Note On NCS 5700 hardware, hop-limit propagation is not applied for packets going to P2P services.

- **segment-routing srv6 encapsulation evpn next-header** *protocol-number*—The protocol number to use in the Next-header field of the IPv6 or SRH header. The range for *protocol-number* is from 59 to 252.

(Optional) Customize SRv6 Logging for Locator Status Changes

- **segment-routing srv6 logging locator status**—Enable the logging of locator status.

(Optional) Customize SRv6 SID Parameters

- **segment-routing srv6 sid holdtime** *minutes*—The holdtime for a stale or freed SID. The range of *minutes* is from 0 (disabled) to 60 minutes.

Example 4:

The following example shows how to configure optional SRv6 parameters:

```
RP/0/RSP0/CPU0:Node1(config)# segment-routing srv6 encapsulation
RP/0/RSP0/CPU0:Node1(config-srv6-encap)# source-address 1::1
RP/0/RSP0/CPU0:Node1(config-srv6-encap)# hop-limit 60
RP/0/RSP0/CPU0:Node1(config-srv6-encap)# evpn next-header 65
RP/0/RSP0/CPU0:Node1(config-srv6-encap)# exit
RP/0/RSP0/CPU0:Node1(config-srv6)# logging locator status
RP/0/RSP0/CPU0:Node1(config-srv6)# sid holdtime 10
RP/0/RSP0/CPU0:Node1(config-srv6)# micro-segment merge-overlay-underlay-sids
```

This config applies to only new SRv6 micro-segment overlay routes and does not update already programmed routes.

Please flap any existing SRv6 micro-segment overlay routes after making this configuration change.

```
RP/0/RSP0/CPU0:Node1(config-srv6)#
```

Verifying SRv6 Manager

This example shows how to verify the overall SRv6 state from SRv6 Manager point of view. The output displays parameters in use, summary information, and platform specific capabilities.

```
Router# show segment-routing srv6 manager
Parameters:
  SRv6 Enabled: Yes
  SRv6 Operational Mode:
    Micro-segment:
      SID Base Block: 2001::/24
  Encapsulation:
    Source Address:
      Configured: ::
      Default: ::
    Hop-Limit: Default
    Traffic-class: Default
Summary:
  Number of Locators: 3 (3 operational)
  Number of SIDs: 3 (0 stale)
  Max SIDs: 64000
  OOR:
    Thresholds: Green 3200, Warning 1920
    Status: Resource Available
      History: (0 cleared, 0 warnings, 0 full)
  Block 2001::/32:
    Number of SIDs free: 7680
    Max SIDs: 7680
    Thresholds: Green 384, Warning 231
    Status: Resource Available
      History: (0 cleared, 0 warnings, 0 full)
Platform Capabilities:
  SRv6: Yes
  TILFA: Yes
  Microloop-Avoidance: Yes
  Endpoint behaviors:
    End (PSP)
    End.X (PSP)
    End.DX6
    End.DX4
    End.DT6
    End.DT4
    End.OP
    uN (PSP/USD)
    uA (PSP/USD)
    uDT6
    uDT4
    uDX2
    uB6 (Insert.Red)
  Headend behaviors:
    T
    H.Insert.Red
    H.Encaps.Red
  Security rules:
    SEC-1
    SEC-2
    SEC-3
  Counters:
    CNT-1
    CNT-3
  Signaled parameters:
    Max-SL : 3
    Max-End-Pop-SRH : 3
    Max-H-Insert : 3 sids
```

```

Max-H-Encap      : 3 sids
Max-End-D        : 4
Configurable parameters (under srv6):
Encapsulation:
  Source Address: Yes
  Hop-Limit      : value=Yes, propagate=No
  Traffic-class  : value=Yes, propagate=Yes
Max SIDs: 64000
SID Holdtime: 3 mins

```

Verifying SRv6 Locator

This example shows how to verify the locator configuration and its operational status.

```
Router# show segment-routing srv6 locator myLoc1 detail
```

```

Name                ID      Algo  Prefix                Status  Flags
-----
myLoc1              3      0     2001:0:8::/48        Up      U
(U): Micro-segment (behavior: uN (PSP/USD))
Interface:
  Name: srv6-myLoc1
  IFH : 0x02000120
  IPv6 address: 2001:0:8::/48
  Number of SIDs: 1
  Created: Dec 10 21:26:54.407 (02:52:26 ago)

```

Verifying SRv6 SIDs

This example shows how to verify the allocation of SRv6 local SIDs off locator(s).

```
Router# show segment-routing srv6 locator myLoc1 sid
```

```

SID                Behavior  Context                Owner
State RW
-----
2001:0:8::        uN (PSP/USD)  'default':1           sidmgr
  InUse Y

```

The following example shows how to display detail information regarding an allocated SRv6 local SID.

```
Router# show segment-routing srv6 locator myLoc1 sid 2001:0:8:: detail
```

```

SID                Behavior  Context                Owner
State RW
-----
2001:0:8::        uN (PSP/USD)  'default':8           sidmgr
  InUse Y
  SID Function: 0x8
  SID context: { table-id=0xe0800000 ('default':IPv6/Unicast), opaque-id=8 }
  Locator: 'myLoc1'
  Allocation type: Dynamic
  Created: Dec 10 22:10:51.596 (02:10:05 ago)

```

Similarly, you can display SID information across locators by using the **show segment-routing srv6 sid** command.

Configuring SRv6 under IS-IS

Table 3: Feature History Table

Feature Name	Release Information	Feature Description
SRv6 under IS-IS	Release 7.5.1	This feature is now supported on Cisco NCS 5700 series fixed port routers and the Cisco NCS 5500 series routers that have the Cisco NC57 line cards installed and operating in the native mode.

Intermediate System-to-Intermediate System (IS-IS) protocol already supports segment routing with MPLS dataplane (SR-MPLS). This feature enables extensions in IS-IS to support Segment Routing with IPv6 data plane (SRv6). The extensions include advertising the SRv6 capabilities of nodes and node and adjacency segments as SRv6 SIDs.

SRv6 IS-IS performs the following functionalities:

1. Interacts with SID Manager to learn local locator prefixes and announces the locator prefixes in the IGP domain.
2. Learns remote locator prefixes from other IS-IS neighbor routers and installs the learned remote locator IPv6 prefix in RIB or FIB.
3. Allocate or learn prefix SID and adjacency SIDs, create local SID entries, and advertise them in the IGP domain.

Usage Guidelines and Restrictions

The following usage guidelines and restrictions apply for SRv6 IS-IS:

- An IS-IS address-family can support either SR-MPLS or SRv6, but both at the same time is not supported.

Configuring SRv6 under IS-IS

To configure SRv6 IS-IS, use the following command:

- **router isis *instance* address-family ipv6 unicast segment-routing srv6 locator *locator* [level {1 | 2}]**—Enable SRv6 under the IS-IS IPv6 address-family and assign SRv6 locator(s) to it. Use the **level {1 | 2}** keywords to advertise the locator only in the specified IS-IS level.

The following example shows how to configure SRv6 under IS-IS.

```
Router(config)# router isis core
Router(config-isis)# address-family ipv6 unicast
Router(config-isis-af)# segment-routing srv6
Router(config-isis-srv6)# locator myLoc1 level 1
Router(config-isis-srv6-loc)# exit
```

For more information about configuring IS-IS, refer to the "[Implementing IS-IS](#)" chapter in the *Routing Configuration Guide for Cisco NCS 5500*.

Configuring SRv6 Flexible Algorithm under IS-IS

This feature introduces support for implementing Flexible Algorithm using IS-IS SRv6.

SRv6 Flexible Algorithm allows operators to customize IGP shortest path computation according to their own needs. An operator can assign custom SR prefix-SIDs to realize forwarding beyond link-cost-based SPF. As a result, Flexible Algorithm provides a traffic-engineered path automatically computed by the IGP to any destination reachable by the IGP.

For detailed information about Flexible Algorithm, see [Enabling Segment Routing Flexible Algorithm](#).

Usage Guidelines and Restrictions

Observe the following usage guidelines and restrictions:

- You can configure up to 8 locators to support SRv6 Flexible Algorithm.
- The Flexible Algorithm locator prefix follows the same usage guidelines and restrictions of algo-0 locator prefixes. See [Usage Guidelines and Limitations, on page 15](#).
- The Locator Algorithm value range is 128 to 255.

Configuring SRv6 Flexible Algorithm under IS-IS

The following sections show you the steps to enable SRv6 Flexible Algorithm. The example highlights a delay-based Flexible Algorithm instance.

1. Configure SRv6 locators
2. Assign SRv6 locators under IS-IS
3. Configure Flexible Algorithm definition and associated metric (for example, delay)
4. Configure the delay probe under the interface. For more information on SR performance measurement, see [Configure performance measurement](#).

The following section shows how to configure two SRv6 locators: one associated with Algo 0, and the other associated with Algo 128.

```
Router(config)# segment-routing srv6
Router(config-srv6)# locators
Router(config-srv6-locators)# locator myLocBestEffort // best-effort locator
Router(config-srv6-locator)# micro-segment behavior unode psp-usd
Router(config-srv6-locator)# prefix 2001:0:1::/48
Router(config-srv6-locator)# exit

Router(config-srv6-locators)# locator myLocLowLat // low-latency (flex algo 128) locator
Router(config-srv6-locator)# micro-segment behavior unode psp-usd
Router(config-srv6-locator)# prefix 2001:0:2::/48
Router(config-srv6-locator)# algorithm 128
Router(config-srv6-locator)# exit
Router(config-srv6)# exit
```

The following section shows how to assign multiple SRv6 locators under IS-IS.

```
Router(config)# router isis core
Router(config-isis)# address-family ipv6 unicast
Router(config-isis-af)# segment-routing srv6
Router(config-isis-srv6)# locator myLocBestEffort
Router(config-isis-srv6-loc)# exit
Router(config-isis-srv6)# locator myLocLowLat
Router(config-isis-srv6-loc)# exit
```

The following section shows how to configure the Flexible Algorithm definition.

```
Router(config)# router isis core
Router(config-isis)# flex-algo 128
Router(config-isis-flex-algo)# metric-type delay
Router(config-isis-flex-algo)# exit
Router(config-isis)# interface GigabitEthernet0/0/0/0
Router(config-isis-if)# address-family ipv6 unicast
```

The following section shows how to configure the delay probe under the interface.

```
Router(config)# performance-measurement
Router(config-perf-meas)# interface GigabitEthernet0/0/0/0
Router(config-pm-intf)# delay-measurement
Router(config-pm-intf-dm)# commit
```

Verification

```
Router# show segment-routing srv6 locator
```

Name	ID	Algo	Prefix	Status	Flags
myLoc1	3	0	2001:0:8::/48	Up	U
myLocBestEffort	5	0	2001:0:1::/48	Up	U
myLocLowLat	4	128	2001:0:2::/48	Up	U

```
Router# show isis flex-algo 128
```

```
IS-IS core Flex-Algo Database
```

```
Flex-Algo 128:
```

```
Level-2:
```

```
Definition Priority: 128
Definition Source: Router.00, (Local)
Definition Equal to Local: Yes
Disabled: No
```

```
Level-1:
```

```
Definition Priority: 128
Definition Source: Router.00, (Local)
Definition Equal to Local: Yes
Disabled: No
```

```
Local Priority: 128
```

```
FRR Disabled: No
Microloop Avoidance Disabled: No
```

Configuring SRv6 Locator Prefix Summarization

SRv6 leverages longest-prefix-match IP forwarding. Massive-scale reachability can be achieved by summarizing locators at ABRs and ASBRs.

Use the **summary-prefix locator** [**algorithm algo**] [**explicit**] command in IS-IS address-family configuration mode to specify that only locators from the specified algorithm contribute to the summary. The **explicit** keyword limits the contributing prefixes to only those belonging to the same algorithm.

The following example shows how to configure SRv6 IS-IS Algorithm Summarization for regular algorithm and Flexible Algorithm (128).

```
Router(config)# router isis core
Router(config-isis)# address-family ipv6 unicast
Router(config-isis-af)# summary-prefix 2001:0:1::/48
Router(config-isis-af)# summary-prefix 2001:0:2::/48 algorithm 128 explicit
```

Configuring TI-LFA with SRv6 IS-IS

This feature introduces support for implementing Topology-Independent Loop-Free Alternate (TI-LFA) using SRv6 IS-IS.

TI-LFA provides link protection in topologies where other fast reroute techniques cannot provide protection. The goal of TI-LFA is to reduce the packet loss that results while routers converge after a topology change due to a link failure. TI-LFA leverages the post-convergence path which is planned to carry the traffic and ensures link and node protection within 50 milliseconds. TI-LFA with IS-IS SR-MPLS is already supported.

TI-LFA provides link, node, and Shared Risk Link Groups (SRLG) protection in any topology.

For more information, see [Configure Topology-Independent Loop-Free Alternate \(TI-LFA\)](#).

Usage Guidelines and Limitations

The following usage guidelines and limitations apply:

- TI-LFA provides link protection by default. Additional tiebreaker configuration is required to enable node or SRLG protection.
- Usage guidelines for node and SRLG protection:
 - TI-LFA node protection functionality provides protection from node failures. The neighbor node is excluded during the post convergence backup path calculation.
 - Shared Risk Link Groups (SRLG) refer to situations in which links in a network share a common fiber (or a common physical attribute). These links have a shared risk: when one link fails, other links in the group might also fail. TI-LFA SRLG protection attempts to find the post-convergence backup path that excludes the SRLG of the protected link. All local links that share any SRLG with the protecting link are excluded.

- When you enable link protection, you can also enable node protection, SRLG protection, or both, and specify a tiebreaker priority in case there are multiple LFAs.
- Valid priority values are from 1 to 255. The lower the priority value, the higher the priority of the rule. Link protection always has a lower priority than node or SRLG protection.

Configuring SRv6 IS-IS TI-LFA

The following example shows how to configure different types of TI-LFA protection for SRv6 IS-IS.

```
Router(config)# router isis core
Router(config-isis)# interface bundle-ether 1201
Router(config-isis-if)# address-family ipv6 unicast
Router(config-isis-if-af)# fast-reroute per-prefix
Router(config-isis-if-af)# fast-reroute per-prefix ti-lfa
Router(config-isis-if-af)# exit
Router(config-isis-if)# exit
Router(config-isis)# interface bundle-ether 1301
Router(config-isis-if)# address-family ipv6 unicast
Router(config-isis-if-af)# fast-reroute per-prefix
Router(config-isis-if-af)# fast-reroute per-prefix ti-lfa
Router(config-isis-if-af)# fast-reroute per-prefix tiebreaker node-protecting index 100
Router(config-isis-if-af)# fast-reroute per-prefix tiebreaker srlg-disjoint index 200
Router(config-isis-if-af)# exit
```

Configuring SRv6 IS-IS TI-LFA with Flexible Algorithm

TI-LFA backup paths for particular Flexible Algorithm are computed using the same constraints as the calculation of the primary paths for such Flexible Algorithm. These paths use the locator prefix advertised specifically for such Flexible Algorithm in order to enforce a backup path.

By default, LFA/TI-LFA for SRv6 Flexible Algorithm uses the LFA/TI-LFA configuration of Algo 0.

Use the **fast-reroute disable** command to disable the LFA/TI-LFA calculation on a per-algorithm basis:

```
Router(config)# router isis core
Router(config-isis)# flex-algo 128
Router(config-isis-flex-algo)# fast-reroute disable
```

Verification

This example shows how to verify the SRv6 IS-IS TI-LFA configuration using the **show isis ipv6 fast-reroute ipv6-prefix detail** command.

```
Router# show isis ipv6 fast-reroute cafe:0:2::2/128 detail

L2 cafe:0:2::2/128 [20/115] Label: None, medium priority
  via fe80::e00:ff:fe3a:c700, HundredGigE0/0/0/0, Node2, Weight: 0
  Backup path: TI-LFA (link), via fe80::1600:ff:feec:fe00, HundredGigE0/0/0/1 Node3,
Weight: 0, Metric: 40
    P node: Node4.00 [cafe:0:4::4], SRv6 SID: cafe:0:4:: uN (PSP/USD)
    Backup-src: Node2.00
    P: No, TM: 40, LC: No, NP: No, D: No, SRLG: Yes
    src Node2.00-00, cafe:0:2::2
```

This example shows how to verify the SRv6 IS-IS TI-LFA configuration using the **show route ipv6 ipv6-prefix detail** command.

```

Router# show route ipv6 cafe:0:2::2/128 detail
Tue Feb 23 23:08:48.151 UTC

Routing entry for cafe:0:2::2/128
  Known via "isis 1", distance 115, metric 20, type level-2
  Installed Feb 23 22:57:38.900 for 00:11:09
  Routing Descriptor Blocks
    fe80::1600:ff:feec:fe00, from cafe:0:2::2, via HundredGigE0/0/0/1, Backup (TI-LFA)
      Repair Node(s): cafe:0:4::4
      Route metric is 40
      Label: None
      Tunnel ID: None
      Binding Label: None
      Extended communities count: 0
      Path id:65          Path ref count:1
      NHID:0x20002(Ref:19)
    SRv6 Headend: H.Insert.Red [f3216], SID-list {cafe:0:4::}
    fe80::e00:ff:fe3a:c700, from cafe:0:2::2, via HundredGigE0/0/0/0, Protected
      Route metric is 20
      Label: None
      Tunnel ID: None
      Binding Label: None
      Extended communities count: 0
      Path id:1          Path ref count:0
      NHID:0x20001(Ref:19)
      Backup path id:65
  Route version is 0x4 (4)
  No local label
  IP Precedence: Not Set
  QoS Group ID: Not Set
  Flow-tag: Not Set
  Fwd-class: Not Set
  Route Priority: RIB_PRIORITY_NON_RECURSIVE_MEDIUM (7) SVD Type RIB_SVD_TYPE_LOCAL
  Download Priority 1, Download Version 66
  No advertising protos.

```

This example shows how to verify the SRv6 IS-IS TI-LFA configuration using the **show cef ipv6 ipv6-prefix detail location location** command.

```

Router# show cef ipv6 cafe:0:2::2/128 detail location 0/0/cpu0
Tue Feb 23 23:09:07.719 UTC
cafe:0:2::2/128, version 66, SRv6 Headend, internal 0x1000001 0x210 (ptr 0x8e96fd2c) [1],
0x0 (0x8e93fae0), 0x0 (0x8f7510a8)
Updated Feb 23 22:57:38.904
local adjacency to HundredGigE0/0/0/0

Prefix Len 128, traffic index 0, precedence n/a, priority 1
gateway array (0x8e7b5c78) reference count 1, flags 0x500000, source rib (7), 0 backups
[2 type 3 flags 0x8401 (0x8e86ea40) ext 0x0 (0x0)]
LW-LDI[type=3, refc=1, ptr=0x8e93fae0, sh-ldi=0x8e86ea40]
gateway array update type-time 1 Feb 23 22:57:38.904
LDI Update time Feb 23 22:57:38.913
LW-LDI-TS Feb 23 22:57:38.913
  via fe80::1600:ff:feec:fe00/128, HundredGigE0/0/0/1, 9 dependencies, weight 0, class 0,
  backup (TI-LFA) [flags 0xb00]
    path-idx 0 NHID 0x20002 [0x8f5850b0 0x0]
    next hop fe80::1600:ff:feec:fe00/128, Repair Node(s): cafe:0:4::4
    local adjacency
    SRv6 H.Insert.Red SID-list {cafe:0:4::}
    via fe80::e00:ff:fe3a:c700/128, HundredGigE0/0/0/0, 6 dependencies, weight 0, class 0,
  protected [flags 0x400]
    path-idx 1 bkup-idx 0 NHID 0x20001 [0x8f8420b0 0x0]
    next hop fe80::e00:ff:fe3a:c700/128

```

```

Load distribution: 0 (refcount 2)

Hash OK Interface Address
0 Y HundredGigE0/0/0/0 fe80::e00:ff:fe3a:c700

```

Configuring SRv6 IS-IS Microloop Avoidance

This feature introduces support for implementing microloop avoidance using IS-IS SRv6.

Microloops are brief packet loops that occur in the network following a topology change (link down, link up, or metric change events). Microloops are caused by the non-simultaneous convergence of different nodes in the network. If nodes converge and send traffic to a neighbor node that has not converged yet, traffic may be looped between these two nodes, resulting in packet loss, jitter, and out-of-order packets.

The SRv6 Microloop Avoidance feature detects if microloops are possible following a topology change. If a node computes that a microloop could occur on the new topology, the node creates a loop-free SR-TE policy path to the destination using a list of segments. After the RIB update delay timer expires, the SR-TE policy is replaced with regular forwarding paths.

Usage Guidelines and Limitations

The following usage guidelines and limitations apply:

- The Routing Information Base (RIB) update delay value specifies the amount of time the node uses the microloop avoidance policy before updating its forwarding table. The *delay-time* range is from 1 to 60000 milliseconds; the default value is 5000.

Configuring SRv6 IS-IS Microloop Avoidance

The following example shows how to configure SRv6 IS-IS Microloop Avoidance and set the Routing Information Base (RIB) update delay value.



Note Complete the [Configuring SRv6, on page 17](#) before performing these steps.

```

Router(config)# router isis test-igp
Router(config-isis)# address-family ipv6 unicast
Router(config-isis-af)# microloop avoidance segment-routing
Router(config-isis-af)# microloop avoidance rib-update-delay 2000
Router(config-isis-af)# commit

```

Configuring SRv6 IS-IS Microloop Avoidance with Flexible Algorithm

Microloop Avoidance paths for particular Flexible Algorithm are computed using the same constraints as the calculation of the primary paths for such Flexible Algorithm. These paths use the Locator prefix advertised specifically for such Flexible Algorithm in order to enforce a microloop avoidance path.

By default, Microloop Avoidance for SRv6 Flexible Algorithm uses the Microloop Avoidance configuration of Algo 0.

Use the **microloop avoidance disable** command to disable the microloop calculation on a per-algorithm basis:

```
Router(config)# router isis test-tilfa
Router(config-isis)# flex-algo 128
Router(config-isis-flex-algo)# microloop avoidance disable
```

Configuring Static SIDs

Manually allocated (static) SIDs are persistent over reloads and restarts, making them a reliable option to be used in explicit paths.

Configuring Static Adjacency SIDs

An adjacency SID (Adj-SID) is associated with an adjacency to a neighboring node. The adjacency SID steers the traffic to a specific adjacency. Adjacency SIDs have local significance and are only valid on the node that allocates them.

Adjacency SIDs that are dynamically allocated do not require any special configuration, however there are some limitations:

- A dynamically allocated Adj-SID value is not known until it has been allocated, and a controller will not know the Adj-SID value until the information is flooded by the IGP.
- Dynamically allocated Adj-SIDs are not persistent and can be reallocated after a reload or a process restart.
- Each link is allocated a unique Adj-SID, so the same Adj-SID cannot be shared by multiple links.

Manually allocated (static) Adj-SIDs are persistent over reloads and restarts, making them a reliable option to be used in explicit paths. They can be provisioned for multiple adjacencies to the same neighbor or to different neighbors.

You can specify that the Adj-SID is protected. If the Adj-SID is protected on the primary interface and a backup path is available, a backup path is installed. By default, static Adj-SIDs are not protected.

Usage Guidelines and Limitations

- Static Adj-SIDs are allocated from the explicit Local ID block (LIB). The default range for explicit SID allocation is 0xFE00 to 0xFEFF (256 IDs).
- Static Adj-SIDs are allocated independent of IS-IS. If a static Adj-SID is successfully allocated, then the SID Manager notifies IS-IS. IS-IS then claims the allocated static Adj-SID and installs the Adj-SID in RIB or FIB.
- If you remove the static Adj-SID configuration, the SID Manager does not clear the allocated static Adj-SID; IS-IS will continue to use the allocated static Adj-SID. This is expected behavior. If you configure a different static Adj-SID, SID manager resolves the conflict and installs the new Adj-SID and notifies IS-IS.
- Static Adj-SID allocation does not follow the interface manager (IM) interface state. The static Adj-SID will be allocated even if the interface is down or doesn't exist in the system. However, the static Adj-SID is not installed in forwarding, since IS-IS didn't claim this Adj-SID.

- Static Adj-SID follows the locator state. Static Adj-SID allocation will fail if the locator is down or invalid.
- Static Adj-SID can be allocated as a protected Adj-SID.
- Static Adj-SID can be allocated to a specific algorithm.

Configuration

Use the **segment-routing srv6 static endpoint** command to configure static adjacency SID and SID allocation context.

Use the **sid <srv6-sid> behavior end-ua-**psp-usd**** command in srv6-static-endpoint config mode to configure the static Adj SID and endpoint behavior.

Use the **allocation-context nexthop <nhop-int> [**algo-id** <algo> | **protected**]** command in srv6-static-sid config mode to configure the next-hop interface. You can also configure the following options:

- **algo-id** *algo* — Specify a Flex Algo value for the static Adj-SID. Valid values for *algo* are 128 to 255; the default is 0 (SPF).
- **protected** — Specify if the static Adj-SID is protected

Example

```
Router(config)# segment-routing
Router(config-sr)# srv6
Router(config-srv6)# static
Router(config-srv6-static)# endpoint
Router(config-srv6-static-endpoint)# sid fccc:0:200:fe01:: behavior end-ua-psp-usd
Router(config-srv6-static-sid)# allocation-context nexthop TenGigE0/1/0/30/1
Router(config-srv6-static-sid)# exit
Router(config-srv6-static-endpoint)# sid fccc:0:200:fe88:: behavior end-ua-psp-usd
Router(config-srv6-static-sid)# allocation-context nexthop TenGigE0/1/0/0/3 protected
Router(config-srv6-static-sid)# exit
Router(config-srv6-static-endpoint)# sid fccc:3a:200:fe01:: behavior end-ua-psp-usd
Router(config-srv6-static-sid)# allocation-context nexthop TenGigE0/1/0/0/3 algo-id 132
protected
Router(config-srv6-static-sid)#
```

Running Configuration

```
segment-routing
srv6
static
endpoint
sid fccc:0:200:fe01:: behavior end-ua-psp-usd
allocation-context nexthop TenGigE0/1/0/30/1
!
sid fccc:0:200:fe88:: behavior end-ua-psp-usd
allocation-context nexthop TenGigE0/1/0/0/3 protected
!
sid fccc:3a:200:fe01:: behavior end-ua-psp-usd
allocation-context nexthop TenGigE0/1/0/0/3 algo-id 132 protected
!
```

Configuring SRv6 BGP-Based Services

Building on the messages and procedures defined in IETF draft "[BGP/MPLS IP Virtual Private Networks \(VPNs\)](#)", BGP has been extended to provide services over an SRv6 network, such as:

- IPv4 Layer-3 VPNs
- IPv6 Layer-3 VPNs
- IPv4 BGP global
- IPv6 BGP global
- Layer-2 VPNs - Ethernet VPNs (EVPN)

For more information about BGP, refer to the *BGP Configuration Guide for Cisco NCS 5500 Series Routers* BGP Configuration Guide.

In SRv6-based services, the egress PE signals an SRv6 Service SID with the BGP service route. The ingress PE encapsulates the payload in an outer IPv6 header where the destination address is the SRv6 Service SID advertised by the egress PE. BGP messages between PEs carry SRv6 Service SIDs as a means to interconnect PEs and form VPNs. SRv6 Service SID refers to a segment identifier associated with one of the SRv6 service-specific behaviors advertised by the egress PE router, such as:

- uDT4 (Endpoint with decapsulation and IPv4 table lookup)
- uDT6 (Endpoint with decapsulation and IPv6 table lookup)
- uDX4 (Endpoint with decapsulation and IPv4 cross-connect)
- uDX6 (Endpoint with decapsulation and IPv6 cross-connect)

Based on the messages and procedures defined in IETF draft "[SRv6 BGP based Overlay services](#)", BGP encodes the SRv6 Service SID in the prefix-SID attribute of the corresponding BGP Network Layer Reachability Information (NLRI) and advertises it to its IPv6 BGP peers.

Usage Guidelines and Restrictions

- The following SRv6 BGP-based services are supported:
 - [SRv6 Services: IPv4 L3VPN](#)
 - [SRv6 Services: IPv6 L3VPN](#)
 - [SRv6 Services: IPv4 BGP Global](#)
 - [SRv6 Services: IPv6 BGP Global](#)
- uDT4 and uDT6 for L3VPN and BGP global are supported.
- Dual-Stack L3 Services (IPv4 L3VPN, IPv6 L3VPN, IPv4 BGP global, IPv6 BGP global) are supported.

SRv6 Locator Inheritance Rules

SRv6 locators can be assigned at different levels inside the BGP routing process. BGP allocates SRv6 Service SIDs from configured locator spaces according to the following inheritance rules:

1. Use the locator as defined under the service.
If not defined under the specific service, then:
2. Use the locator as defined under the corresponding address-family.
If not defined under the corresponding address-family, then:
3. Use the locator as defined globally under BGP.

Enabling SRv6 Globally under BGP

Use the **router bgp *as-number* segment-routing srv6** command to enable SRv6 globally under the BGP routing process. The *as-number* is from 1-65535.

```
RP/0/0/CPU0:Node1 (config) # router bgp 100 segment-routing srv6
```

Assigning SRv6 Locator Globally under BGP

Use the **router bgp *as-number* segment-routing srv6 locator *WORD*** command to assign an SRv6 locator globally under the BGP routing process. The *as-number* is from 1-65535.

This example shows how to assign a locator:

```
RP/0/0/CPU0:Node1 (config) # router bgp 100 segment-routing srv6 locator Node1-locator
```

For more information on how to configure an SRv6 locator, see [Configuring SRv6, on page 17](#).

For more information on how to assign an SRv6 locator under the BGP service or BGP address-family, see the following SRv6 Services sections.

SRv6 Services: IPv4 L3VPN

Table 4: Feature History Table

Feature Name	Release	Description
Per-Prefix SRv6 Locator Assignment	Release 7.5.1	This feature provides the ability to assign a specific SRv6 locator for a given prefix or a set of prefixes (IPv4/IPv6 GRT, IPv4/IPv6 VPN). The egress PE advertises the prefix with the specified locator. This allows for per-prefix steering into desired transport behaviors, such as Flex Algo.
Support for iBGP as PE-CE protocol	Release 7.5.1	This feature introduces support for iBGP as PE-CE protocol.
BGP Route Leaking	Release 7.5.1	This feature adds support for importing routes from default-VRF to non-default VRF and routes from non-default VRF to default VRF.

Table 5: Feature History Table

Feature Name	Release	Description
Dual-Stack L3VPN Services (IPv4, IPv6) (SRv6 Micro-SID)	Release 7.3.2	This feature introduces support for Dual-stack (VPNv4/VPNv6) VRFs. VPNv4/VPNv6 Dual-stack supports both IPv4 (uDT4) and IPv6 (uDT6) based SRv6 L3VPN service on the same interface, sub-interface, or VRF.

This feature provides IPv4 L3VPNs (VPNv4) over an SRv6 network.

Usage Guidelines and Limitations

- SRv6 locator can be assigned globally, for all VRFs, for an individual VRF, or per-prefix.
- Per-VRF allocation mode is supported (uDT4 behavior)
- Dual-Stack L3VPN Services (IPv4, IPv6) are supported
- Equal-Cost Multi-path (ECMP) and Unequal Cost Multipath (UCMP) are supported.
- BGP (iBGP, eBGP), OSPF, Static are supported as PE-CE protocol.
- BGP route leaking between BGP Global and L3VPN is supported. Refer to the [Implementing BGP](#) chapter in the *BGP Configuration Guide for Cisco NCS 5500 Series Routers*.
- MPLS L3VPN and SRv6 L3VPN interworking gateway is supported.
- Per-CE allocation mode is not supported (uDX4 behavior)

Configuring SRv6 based IPv4 L3VPN

To enable SRv6-based L3VPN, you need to enable SRv6 under BGP, specify the locator, and configure the SID allocation mode. The assignment of the locator can be done in different places under the **router bgp** configuration. See [SRv6 Locator Inheritance Rules, on page 34](#).

Use Case 1: Assigning SRv6 Locator Globally

This example shows how to enable SRv6 and configure the SRv6 locator name under BGP Global:

```

Node1 (config) # router bgp 100
Node1 (config-bgp) # segment-routing srv6
Node1 (config-bgp-gbl-srv6) # locator Node1-locator
Node1 (config-bgp-gbl-srv6) # exit
Node1 (config-bgp) # address-family vpnv4 unicast
Node1 (config-bgp-af) # exit
Node1 (config-bgp) # neighbor 3001::1:1:1:4
Node1 (config-bgp-nbr) # remote-as 100
Node1 (config-bgp-nbr) # address-family vpnv4 unicast
Node1 (config-bgp-nbr-af) # exit
Node1 (config-bgp-nbr) # exit
Node1 (config-bgp) # vrf vrf_cust1
Node1 (config-bgp-vrf) # rd 100:1
Node1 (config-bgp-vrf) # address-family ipv4 unicast

```

```
Node1(config-bgp-vrf-af)# commit
```

Running Config

```
router bgp 100
  segment-routing srv6
  locator Node1-locator
  !
  address-family vpnv4 unicast
  !
  neighbor 3001::1:1:1:4
  remote-as 100
  address-family vpnv4 unicast
  !
  !
  vrf vrf_cust1
  rd 100:1
  address-family ipv4 unicast
  !
  !
  !
end
```

Use Case 2: Assigning SRv6 Locator for All VRFs

To configure the SRv6 locator for all VRFs under VPNv4 Address Family and specify the allocation mode, use the following commands:

- **router bgp *as-number* address-family vpnv4 unicast vrf all segment-routing srv6:** Enable SRv6
- **router bgp *as-number* address-family vpnv4 unicast vrf all segment-routing srv6 alloc mode {*per-vrf*}:** Specify the SID behavior (allocation mode)
 - Use the **per-vrf** keyword to specify that the same service SID (uDT4 behavior) be used for all the routes advertised from a unique VRF.
- **router bgp *as-number* address-family vpnv4 unicast vrf all segment-routing srv6 locator *WORD*:** Specify the locator

This example shows how to enable SRv6 and configure the SRv6 locator for all VRFs under VPNv4 Address Family, with per-VRF label allocation mode:

```
Node1(config)# router bgp 100
Node1(config-bgp)# address-family vpnv4 unicast
Node1(config-bgp-af)# vrf all
Node1(config-bgp-af-vrfall)# segment-routing srv6
Node1(config-bgp-af-vrfall-srv6)# locator Node1-locator
Node1(config-bgp-af-vrfall-srv6)# alloc mode per-vrf
Node1(config-bgp-af-vrfall-srv6)# exit
Node1(config-bgp-af-vrfall)# exit
Node1(config-bgp-af)# exit
Node1(config-bgp)# neighbor 3001::1:1:1:4
Node1(config-bgp-nbr)# remote-as 100
Node1(config-bgp-nbr)# address-family vpnv4 unicast
Node1(config-bgp-nbr-af)# exit
Node1(config-bgp-nbr)# exit
Node1(config-bgp)# vrf vrf_cust1
Node1(config-bgp-vrf)# rd 100:1
Node1(config-bgp-vrf)# address-family ipv4 unicast
Node1(config-bgp-vrf-af)# commit
```

Running Config

```
router bgp 100
  address-family vpnv4 unicast
  vrf all
    segment-routing srv6
    locator Node1-locator
    alloc mode per-vrf
  !
!
neighbor 3001::1:1:1:4
  remote-as 100
  address-family vpnv4 unicast
!
!
vrf vrf_cust1
  rd 100:1
  address-family ipv4 unicast
!
!
end
```

Use Case 3: Assigning SRv6 Locator for a specific VRF

To configure the SRv6 locator for a specific VRF under IPv4 Address Family and specify the allocation mode, use the following commands:

- **router bgp *as-number* vrf *WORD* address-family ipv4 unicast segment-routing srv6**: Enable SRv6
- **router bgp *as-number* vrf *WORD* address-family ipv4 unicast segment-routing srv6 alloc mode { *per-vrf* }**: Specify the SID behavior (allocation mode)
 - Use the **per-vrf** keyword to specify that the same service SID (uDT4 behavior) be used for all the routes advertised from a unique VRF.
- **router bgp *as-number* vrf *WORD* address-family ipv4 unicast segment-routing srv6 locator *WORD***: Specify the locator

This example shows how to configure the SRv6 locator for an individual VRF, with per-VRF label allocation mode:

```
Node1 (config)# router bgp 100
Node1 (config-bgp)# address-family vpnv4 unicast
Node1 (config-bgp-af)# exit
Node1 (config-bgp)# neighbor 3001::1:1:1:4
Node1 (config-bgp-nbr)# remote-as 100
Node1 (config-bgp-nbr)# address-family vpnv4 unicast
Node1 (config-bgp-nbr-af)# exit
Node1 (config-bgp-nbr)# exit
Node1 (config-bgp)# vrf vrf_cust1
Node1 (config-bgp-vrf)# rd 100:1
Node1 (config-bgp-vrf)# address-family ipv4 unicast
Node1 (config-bgp-vrf-af)# segment-routing srv6
Node1 (config-bgp-vrf-af-srv6)# locator Node1-locator
Node1 (config-bgp-vrf-af-srv6)# alloc mode per-vrf
Node1 (config-bgp-vrf-af-srv6)# commit
```

Running Config

```

router bgp 100
  address-family vpnv4 unicast
  !
  neighbor 3001::1:1:1:4
    remote-as 100
    address-family vpnv4 unicast
  !
  !
  vrf vrf_cust1
    rd 100:1
    address-family ipv4 unicast
      segment-routing srv6
        locator Nodel-locator
        alloc mode per-vrf
    !
  !
  !
  !
end

```

Use Case 4: Assigning SRv6 Locator for a Specific Prefix

This use case provides the ability to assign a specific SRv6 locator for a given prefix or a set of prefixes. The egress PE advertises the prefix with the specified locator. This allows for per-prefix steering into desired transport behaviors, such as Flex Algo.

To assign an SRv6 locator for a specific prefix, configure a route policy to specify the SID allocation mode based on match criteria. Examples of match criteria are destination-based match or community-based match.

- Supported SID allocation mode is per-VRF.
- For per-VRF allocation mode, you can also specify the SRv6 locator.
 - If an SRv6 locator is specified in the route policy, BGP will use that to allocate per-VRF SID. If the specified locator is invalid, the SID will not be allocated.
 - If an SRv6 locator is not specified in the route policy, the default locator configured under BGP is used to allocate the SID. If the default locator is not configured, then the SID will not be allocated.

For more information on configuring routing policies, refer to the "Implementing Routing Policy" chapter in the *Routing Configuration Guide*.

The following example shows a route policy specifying the SID allocation mode with destination-based match:

```

Node1(config)# route-policy set_per_prefix_locator_rpl
Node1(config-rpl)# if destination in (10.1.1.0/24) then
Node1(config-rpl-if)# set srv6-alloc-mode per-vrf locator locator1
Node1(config-rpl-if)# elseif destination in (2.2.2.0/24) then
Node1(config-rpl-elseif)# set srv6-alloc-mode per-vrf locator locator2
Node1(config-rpl-elseif)# elseif destination in (3.3.3.0/24) then
Node1(config-rpl-elseif)# set srv6-alloc-mode per-vrf
Node1(config-rpl-elseif)# else
Node1(config-rpl-else)# drop
Node1(config-rpl-else)# endif
Node1(config-rpl)# end-policy
Node1(config)#

```

To specify per-prefix allocation mode for a specific VRF under IPv4 address family, use the following command:

- **router bgp** *as-number* **vrf** *WORD* **address-family ipv4 unicast segment-routing srv6 alloc mode route-policy** *policy_name*

This example shows how to configure per-prefix allocation mode for a specific VRF (vrf_cust1) under IPv4 address family

```
Node1(config)# router bgp 100
Node1(config-bgp)# vrf vrf_cust1
Node1(config-bgp-vrf)# address-family ipv4 unicast
Node1(config-bgp-vrf-af)# segment-routing srv6
Node1(config-bgp-vrf-af-srv6)# alloc mode route-policy set_per_prefix_locator_rpl
```

Running Configuration

```
route-policy set_per_prefix_locator_rpl
  if destination in (10.1.1.0/24) then
    set srv6-alloc-mode per-vrf locator locator1
  elseif destination in (2.2.2.0/24) then
    set srv6-alloc-mode per-vrf locator locator2
  elseif destination in (3.3.3.0/24) then
    set srv6-alloc-mode per-vrf
  else
    drop
  endif
end-policy
!
router bgp 100
vrf vrf_cust1
  address-family ipv6 unicast
  segment-routing srv6
  alloc mode route-policy set_per_prefix_locator_rpl
!
!
!
```

Verify that the local and received SIDs have been correctly allocated under VPNv4 and specific VRF (vrf_cust1):

```
Node1# show bgp vpnv4 unicast local-sids
BGP router identifier 10.1.1.1, local AS number 100
BGP generic scan interval 60 secs
Non-stop routing is enabled
BGP table state: Active
Table ID: 0x0 RD version: 0
BGP main routing table version 50
BGP NSR Initial initsync version 18 (Reached)
BGP NSR/ISSU Sync-Group versions 0/0
BGP scan interval 60 secs

Status codes: s suppressed, d damped, h history, * valid, > best
               i - internal, r RIB-failure, S stale, N Nexthop-discard
Origin codes: i - IGP, e - EGP, ? - incomplete
   Network          Local Sid                               Alloc mode   Locator
Route Distinguisher: 8:8
*>i8.8.8.8/32        NO SRv6 Sid                                   -            -
* i                 NO SRv6 Sid                                   -            -
Route Distinguisher: 10.1.1.1:0 (default for vrf vrf_cust1)
*> 10.1.1.0/24      fc00:0:1:40::                                per-vrf      locator1
*> 2.2.2.0/24       fc00:8:1:40::                                per-vrf      locator2
*> 3.3.3.0/24       fc00:9:1:40::                                per-vrf      locator4
*> 10.1.1.5/32     NO SRv6 Sid                                   -            -
*> 3.3.3.3/32     NO SRv6 Sid                                   -            -
```



```
*>i8.8.8.8/32          NO SRv6 Sid          -          -
```

```
Node1# show bgp vpnv4 unicast received-sids
BGP router identifier 10.1.1.1, local AS number 100
BGP generic scan interval 60 secs
Non-stop routing is enabled
BGP table state: Active
Table ID: 0x0   RD version: 0
BGP main routing table version 50
BGP NSR Initial initsync version 18 (Reached)
BGP NSR/ISSU Sync-Group versions 0/0
BGP scan interval 60 secs
```

```
Status codes: s suppressed, d damped, h history, * valid, > best
               i - internal, r RIB-failure, S stale, N Nexthop-discard
Origin codes: i - IGP, e - EGP, ? - incomplete
```

Network	Next Hop	Received Sid
Route Distinguisher: 8:8		
*>i8.8.8.8/32	10.1.1.2	fc00:0:2:42::
* i	2400:2020:42:2fff::1	
Route Distinguisher: 10.1.1.1:0 (default for vrf vrf_cust1)		
*> 10.1.1.0/24	11.1.1.2	NO SRv6 Sid
*> 2.2.2.0/24	11.1.1.2	NO SRv6 Sid
*> 3.3.3.0/24	11.1.1.2	NO SRv6 Sid
*> 10.1.1.5/32	11.1.1.2	NO SRv6 Sid
*> 3.3.3.3/32	13.2.2.2	NO SRv6 Sid
*>i8.8.8.8/32	10.1.1.2	fc00:0:2:42::

```
Node1# show bgp vrf vrf_cust1 local-sids
BGP VRF vrf_cust1, state: Active
BGP Route Distinguisher: 10.1.1.1:0
VRF ID: 0x60000004
BGP router identifier 10.1.1.1, local AS number 1
Non-stop routing is enabled
BGP table state: Active
Table ID: 0xe0000013   RD version: 37
BGP main routing table version 37
BGP NSR Initial initsync version 18 (Reached)
BGP NSR/ISSU Sync-Group versions 0/0
```

```
Status codes: s suppressed, d damped, h history, * valid, > best
               i - internal, r RIB-failure, S stale, N Nexthop-discard
Origin codes: i - IGP, e - EGP, ? - incomplete
```

Network	Local Sid	Alloc mode	Locator
Route Distinguisher: 10.1.1.1:0 (default for vrf vrf_cust1)			
*> 10.1.1.0/24	fc00:0:1:40::	per-vrf	locator1
*> 2.2.2.0/24	fc00:8:1:40::	per-vrf	locator2
*> 3.3.3.0/24	fc00:9:1:40::	per-vrf	locator4
*> 10.1.1.5/32	NO SRv6 Sid	-	-
*> 3.3.3.3/32	NO SRv6 Sid	-	-
*>i8.8.8.8/32	NO SRv6 Sid	-	-

```
Node1# show bgp vrf vrf_cust1 received-sids
BGP VRF vrf_cust1, state: Active
BGP Route Distinguisher: 10.1.1.1:0
VRF ID: 0x60000004
BGP router identifier 10.1.1.1, local AS number 1
Non-stop routing is enabled
BGP table state: Active
Table ID: 0xe0000013   RD version: 37
BGP main routing table version 37
```

```

BGP NSR Initial initsync version 18 (Reached)
BGP NSR/ISSU Sync-Group versions 0/0

Status codes: s suppressed, d damped, h history, * valid, > best
               i - internal, r RIB-failure, S stale, N Nexthop-discard
Origin codes: i - IGP, e - EGP, ? - incomplete
Network        Next Hop        Received Sid
Route Distinguisher: 10.1.1.1:0 (default for vrf vrf_cust1)
*> 10.1.1.0/24  11.1.1.2        NO SRv6 Sid
*> 2.2.2.0/24   11.1.1.2        NO SRv6 Sid
*> 3.3.3.0/24   11.1.1.2        NO SRv6 Sid
*> 10.1.1.5/32  11.1.1.2        NO SRv6 Sid
*> 3.3.3.3/32   13.2.2.2        NO SRv6 Sid
*>i8.8.8.8/32   10.1.1.2        fc00:0:2:42::
    
```

Verification

The following figure shows a VPNv4 scenario. The sequence of commands included correspond to router Node1 acting as Ingress PE, and routers Node4 and Node5 acting as Egress PEs.

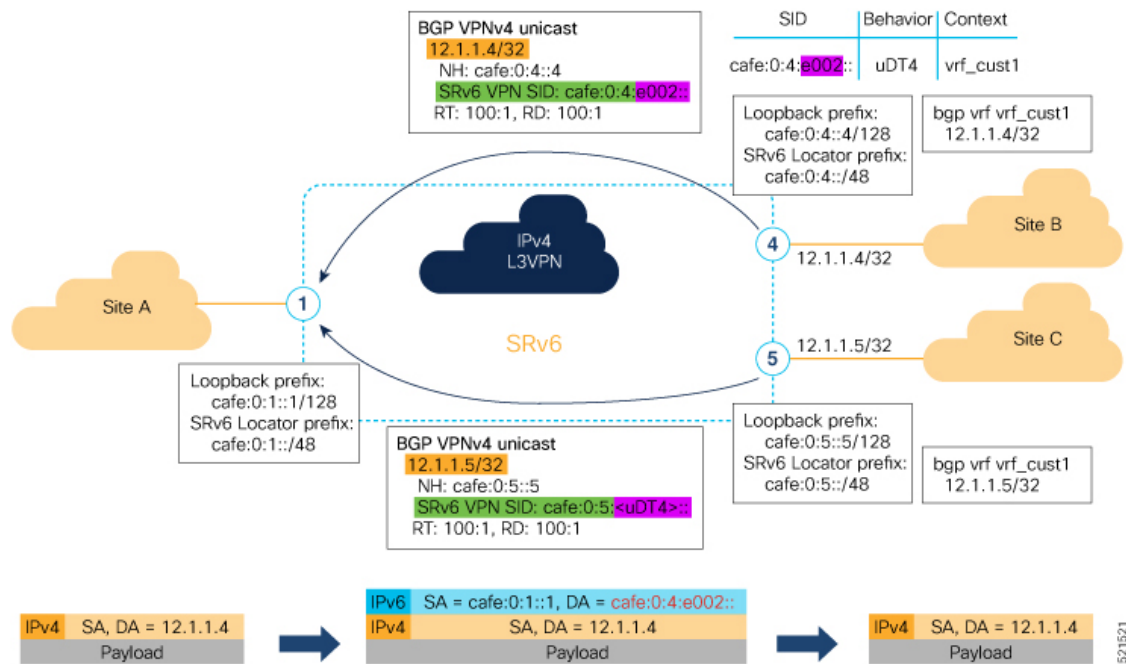

The following example shows how to verify the SRv6 based L3VPN configuration using the **show segment-routing srv6 sid** command.

In this example, we can observe the uDT4 SIDs associated with the IPv4 L3VPN; where uDT4 behavior represents Endpoint with decapsulation and IPv4 table lookup.

```
Node1# show segment-routing srv6 sid
```

```
*** Locator: 'Node1-locator' ***
```

SID	State	RW	Behavior	Context	Owner
cafe:0:1::	InUse	Y	uN (PSP/USD)	'default':1	sidmgr

```

cafe:0:1:e000::          uA (PSP/USD)    [Hu0/0/0/0, Link-Local]:0    isis-1
    InUse Y
cafe:0:1:e001::          uA (PSP/USD)    [Hu0/0/0/1, Link-Local]:0    isis-1
    InUse Y
cafe:0:1:e002::          uDT4            'vrf_cust1'                  bgp-100
    InUse Y
cafe:0:1:e003::          uDT4            'vrf_cust2'                  bgp-100
    InUse Y
cafe:0:1:e004::          uDT4            'vrf_cust3'                  bgp-100
    InUse Y
cafe:0:1:e005::          uDT4            'vrf_cust4'                  bgp-100
    InUse Y
cafe:0:1:e006::          uDT4            'vrf_cust5'                  bgp-100
    InUse Y
    
```

The following example shows how to verify the SRv6 based L3VPN configuration using the **show segment-routing srv6SID-prefixdetail** command.

```

Nodel# show segment-routing srv6 sid cafe:0:1:e002:: detail
Tue Feb  9 17:50:40.621 UTC

*** Locator: 'Nodel-locator' ***

SID                               Behavior           Context           Owner
      State  RW
-----
cafe:0:1:e002::                    uDT4              'vrf_cust1'      bgp-100
      InUse  Y
  SID Function: 0xe002
  SID context: { table-id=0xe0000011 ('vrf_cust1':IPv4/Unicast) }
  Locator: 'Nodel-locator'
  Allocation type: Dynamic
  Created: Feb  9 17:41:07.475 (00:09:33 ago)
    
```

The following example shows how to verify the SRv6 based L3VPN configuration using the **show bgp vpnv4 unicast** commands on Egress PE.

```

Nodel# show bgp vpnv4 unicast summary

BGP router identifier 10.1.1.1, local AS number 100
BGP generic scan interval 60 secs
Non-stop routing is enabled
BGP table state: Active
Table ID: 0x0   RD version: 0
BGP main routing table version 36
BGP NSR Initial initsync version 16 (Reached)
BGP NSR/ISSU Sync-Group versions 0/0
BGP scan interval 60 secs

BGP is operating in STANDALONE mode.

Process      RcvTblVer  bRIB/RIB  LabelVer  ImportVer  SendTblVer  StandbyVer
Speaker      36         36        36        36         36         0

Neighbor     Spk      AS  MsgRcvd  MsgSent   TblVer  InQ  OutQ  Up/Down  St/PfxRcd
cafe:0:4::4   0      100    47     48       36     0    0 00:40:05  5
cafe:0:5::5   0      100    47     47       36     0    0 00:39:56  5

Nodel# show bgp vpnv4 unicast rd 100:1
    
```

```

BGP router identifier 10.1.1.1, local AS number 100
BGP generic scan interval 60 secs
Non-stop routing is enabled
BGP table state: Active
Table ID: 0x0   RD version: 0
BGP main routing table version 36
BGP NSR Initial initsync version 16 (Reached)
BGP NSR/ISSU Sync-Group versions 0/0
BGP scan interval 60 secs

Status codes: s suppressed, d damped, h history, * valid, > best
                i - internal, r RIB-failure, S stale, N Nexthop-discard
Origin codes: i - IGP, e - EGP, ? - incomplete

```

Network	Next Hop	Metric	LocPrf	Weight	Path
Route Distinguisher: 100:1 (default for vrf vrf_cust1)					
*> 12.1.1.1/32	0.0.0.0	0		32768	?
*>i12.4.4.4/32	cafe:0:4::4	0	100		0 ?
*>i12.5.5.5/32	cafe:0:5::5	0	100		0 ?

Processed 3 prefixes, 3 paths

Nodel# **show bgp vpnv4 unicast rd 100:1 12.4.4.4/32**

```

BGP routing table entry for 12.4.4.4/32, Route Distinguisher: 100:1
Versions:
  Process          bRIB/RIB  SendTblVer
  Speaker          22        22
Last Modified: Feb 23 22:57:56.756 for 00:40:08
Paths: (1 available, best #1)
  Not advertised to any peer
  Path #1: Received by speaker 0
  Not advertised to any peer
  Local, (received & used)
    cafe:0:4::4 (metric 30) from cafe:0:4::4 (10.1.1.4)
    Received Label 0xe00400
    Origin incomplete, metric 0, localpref 100, valid, internal, best, group-best,
import-candidate, imported
    Received Path ID 0, Local Path ID 1, version 22
    Extended community: RT:1:1 RT:100:1
    PSID-Type:L3, SubTLV Count:1
    SubTLV:
      T:1(Sid information), Sid:cafe:0:4::, Behavior:63, SS-TLV Count:1
      SubSubTLV:
        T:1(Sid structure):
          Source AFI: VPNv4 Unicast, Source VRF: vrf_cust1, Source Route Distinguisher: 100:1

```

The following examples show how to verify the BGP prefix information for VRF instances using the **show bgp vrf** commands:

Nodel# **show bgp vrf vrf_cust1 ipv4 unicast**

```

BGP VRF vrf_cust1, state: Active
BGP Route Distinguisher: 100:1
VRF ID: 0x60000002
BGP router identifier 10.1.1.1, local AS number 100
Non-stop routing is enabled
BGP table state: Active
Table ID: 0xe0000011   RD version: 32
BGP main routing table version 36
BGP NSR Initial initsync version 16 (Reached)
BGP NSR/ISSU Sync-Group versions 0/0

```

```

Status codes: s suppressed, d damped, h history, * valid, > best
                i - internal, r RIB-failure, S stale, N Nexthop-discard
Origin codes: i - IGP, e - EGP, ? - incomplete
      Network          Next Hop              Metric LocPrf Weight Path
Route Distinguisher: 100:1 (default for vrf vrf_cust1)
*> 12.1.1.1/32        0.0.0.0                0          32768 ?
*>i12.4.4.4/32        cafe:0:4::4            0    100    0 ?
*>i12.5.5.5/32        cafe:0:5::5            0    100    0 ?

```

Processed 3 prefixes, 3 paths

```
Nodel# show bgp vrf vrf_cust1 ipv4 unicast 12.4.4.4/32
```

Tue Feb 23 23:39:57.499 UTC

BGP routing table entry for 12.4.4.4/32, Route Distinguisher: 100:1

Versions:

```

Process          bRIB/RIB  SendTblVer
Speaker          22        22

```

Last Modified: Feb 23 22:57:56.756 for 00:42:01

Paths: (1 available, best #1)

Not advertised to any peer

Path #1: Received by speaker 0

Not advertised to any peer

Local, (received & used)

cafe:0:4::4 (metric 30) from cafe:0:4::4 (10.1.1.4)

Received Label 0xe00400

Origin incomplete, metric 0, localpref 100, valid, internal, best, group-best,

import-candidate, imported

Received Path ID 0, Local Path ID 1, version 22

Extended community: RT:1:1 RT:100:1

PSID-Type:L3, SubTLV Count:1

SubTLV:

T:1(Sid information), Sid:cafe:0:4::, Behavior:63, SS-TLV Count:1

SubSubTLV:

T:1(Sid structure):

Source AFI: VPNv4 Unicast, Source VRF: vrf_cust1, Source Route Distinguisher: 100:1

The following example shows how to verify the SRv6 based L3VPN configuration using the **show route vrf** commands.

```
Nodel# show route vrf vrf_cust1
```

Codes: C - connected, S - static, R - RIP, B - BGP, (>) - Diversion path

D - EIGRP, EX - EIGRP external, O - OSPF, IA - OSPF inter area

N1 - OSPF NSSA external type 1, N2 - OSPF NSSA external type 2

E1 - OSPF external type 1, E2 - OSPF external type 2, E - EGP

i - ISIS, L1 - IS-IS level-1, L2 - IS-IS level-2

ia - IS-IS inter area, su - IS-IS summary null, * - candidate default

U - per-user static route, o - ODR, L - local, G - DAGR, l - LISP

A - access/subscriber, a - Application route

M - mobile route, r - RPL, t - Traffic Engineering, (!) - FRR Backup path

Gateway of last resort is not set

L 12.1.1.1/32 is directly connected, 00:44:43, Loopback100

B 12.4.4.4/32 [200/0] via cafe:0:4::4 (nexthop in vrf default), 00:42:45

B 12.5.5.5/32 [200/0] via cafe:0:5::5 (nexthop in vrf default), 00:42:45

```
Nodel# show route vrf vrf_cust1 12.4.4.4/32
```

Routing entry for 12.4.4.4/32

Known via "bgp 100", distance 200, metric 0, type internal

```

Installed Feb 23 22:57:56.746 for 00:43:12
Routing Descriptor Blocks
  cafe:0:4::4, from cafe:0:4::4
    Nexthop in Vrf: "default", Table: "default", IPv6 Unicast, Table Id: 0xe0800000
    Route metric is 0
No advertising protos.

```

```
Node1# show route vrf vrf_cust1 12.4.4.4/32 detail
```

```

Routing entry for 12.4.4.4/32
Known via "bgp 100", distance 200, metric 0, type internal
Installed Feb 23 22:57:56.746 for 00:43:37
Routing Descriptor Blocks
  cafe:0:4::4, from cafe:0:4::4
    Nexthop in Vrf: "default", Table: "default", IPv6 Unicast, Table Id: 0xe0800000
    Route metric is 0
    Label: None
    Tunnel ID: None
    Binding Label: None
    Extended communities count: 0
    Source RD attributes: 0x0000:100:1
    NHID:0x0(Ref:0)
SRv6 Headend: H.Encaps.Red [f3216], SID-list {cafe:0:4:e004::}
Route version is 0x1 (1)
No local label
IP Precedence: Not Set
QoS Group ID: Not Set
Flow-tag: Not Set
Fwd-class: Not Set
Route Priority: RIB_PRIORITY_RECURSIVE (12) SVD Type RIB_SVD_TYPE_REMOTE
Download Priority 3, Download Version 3
No advertising protos.

```

The following example shows how to verify the SRv6 based L3VPN configuration using the **show cef vrf** commands.

```
Node1# show cef vrf vrf_cust1
```

Prefix	Next Hop	Interface
0.0.0.0/0	drop	default handler
0.0.0.0/32	broadcast	
12.1.1.1/32	receive	Loopback100
12.4.4.4/32	cafe:0:4::/128	<recursive>
12.5.5.5/32	cafe:0:5::/128	<recursive>
224.0.0.0/4	0.0.0.0/32	
224.0.0.0/24	receive	
255.255.255.255/32	broadcast	

```
Node1# show cef vrf vrf_cust1 12.4.4.4/32
```

```

12.4.4.4/32, version 3, SRv6 Headend, internal 0x5000001 0x30 (ptr 0x78b9a61c) [1], 0x0
(0x0), 0x0 (0x88873720)
Updated Feb 23 22:57:56.749
Prefix Len 32, traffic index 0, precedence n/a, priority 3
via cafe:0:4::/128, 3 dependencies, recursive [flags 0x6000]
  path-idx 0 NHID 0x0 [0x78e2da14 0x0]
  next hop VRF - 'default', table - 0xe0800000
  next hop cafe:0:4::/128 via cafe:0:4::/48
SRv6 H.Encaps.Red SID-list {cafe:0:4:e004::}

```

```

Node1# show cef vrf vrf_cust1 12.4.4.4/32 detail

12.4.4.4/32, version 3, SRv6 Headend, internal 0x5000001 0x30 (ptr 0x78b9a61c) [1], 0x0
(0x0), 0x0 (0x88873720)
Updated Feb 23 22:57:56.749
Prefix Len 32, traffic index 0, precedence n/a, priority 3
gateway array (0x88a740a8) reference count 5, flags 0x2010, source rib (7), 0 backups
[1 type 3 flags 0x48441 (0x789cbcc8) ext 0x0 (0x0)]
LW-LDI[type=0, refc=0, ptr=0x0, sh-ldi=0x0]
gateway array update type-time 1 Feb 23 22:57:56.749
LDI Update time Feb 23 22:57:56.754

Level 1 - Load distribution: 0
[0] via cafe:0:4::/128, recursive

via cafe:0:4::/128, 3 dependencies, recursive [flags 0x6000]
path-idx 0 NHID 0x0 [0x78e2da14 0x0]
next hop VRF - 'default', table - 0xe0800000
next hop cafe:0:4::/128 via cafe:0:4::/48
SRv6 H.Encaps.Red SID-list {cafe:0:4:e004::}

Load distribution: 0 1 (refcount 1)

Hash OK Interface Address
0 Y HundredGigE0/0/0/1 remote
1 Y HundredGigE0/0/0/0 remote

```

SRv6 Services: IPv6 L3VPN

Table 6: Feature History Table

Feature Name	Release Information	Feature Description
SRv6 Services: IPv6 L3VPN	Release 7.3.1	With this feature, the egress PE can signal an SRv6 Service SID with the BGP overlay service route. The ingress PE encapsulates the IPv4/IPv6 payload in an outer IPv6 header where the destination address is the SRv6 Service SID provided by the egress PE. BGP messages between PEs carry SRv6 Service SIDs as a means to interconnect PEs and form VPNs.

This feature provides IPv6 L3VPNs (VPNv6) over an SRv6 network.

Usage Guidelines and Limitations

- SRv6 locator can be assigned globally, for all VRFs, for an individual VRF, or per-prefix.
- Per-VRF allocation mode is supported (uDT6 behavior)
- Dual-Stack L3VPN Services (IPv4, IPv6) are supported
- Equal-Cost Multi-path (ECMP) and Unequal Cost Multipath (UCMP) are supported.

- BGP (iBGP, eBGP), OSPF, Static are supported as PE-CE protocol.
- BGP route leaking between BGP Global and L3VPN is supported. Refer to the [Implementing BGP](#) chapter in the *BGP Configuration Guide for Cisco NCS 5500 Series Routers*.
- MPLS L3VPN and SRv6 L3VPN interworking gateway is supported.
- Per-CE allocation mode is not supported (uDX6 behavior)

Configuring SRv6-based IPv6 L3VPN

To enable SRv6-based L3VPN, you need to enable SRv6 under BGP, specify the locator, and configure the SID allocation mode. The assignment of the locator can be done in different places under the **router bgp** configuration. See [SRv6 Locator Inheritance Rules, on page 34](#).

Use Case 1: Assigning SRv6 Locator Globally

This example shows how to configure the SRv6 locator name under BGP Global:

```

Node1(config)# router bgp 100
Node1(config-bgp)# segment-routing srv6
Node1(config-bgp-gbl-srv6)# locator Node1-locator
Node1(config-bgp-gbl-srv6)# exit
Node1(config-bgp)# address-family vpnv6 unicast
Node1(config-bgp-af)# exit
Node1(config-bgp)# neighbor 3001::12:1:1:4
Node1(config-bgp-nbr)# remote-as 100
Node1(config-bgp-nbr)# address-family vpnv6 unicast
Node1(config-bgp-nbr-af)# exit
Node1(config-bgp-nbr)# exit
Node1(config-bgp)# vrf vrf_cust6
Node1(config-bgp-vrf)# rd 100:6
Node1(config-bgp-vrf)# address-family ipv6 unicast
Node1(config-bgp-vrf-af)# commit

```

Running Configuration

```

router bgp 100
  segment-routing srv6
  locator Node1-locator
  !
  address-family vpnv6 unicast
  !
  neighbor 3001::12:1:1:4
  remote-as 100
  address-family vpnv6 unicast
  !
  !
  vrf vrf_cust6
  rd 100:6
  address-family ipv6 unicast
  !
  !
  !
end

```

Use Case 2: Assigning SRv6 Locator for All VRFs

To configure the SRv6 locator for all VRFs under VPNv6 Address Family and specify the allocation mode, use the following commands:

- **router bgp *as-number* address-family vpnv6 unicast vrf all segment-routing srv6**: Enable SRv6
- **router bgp *as-number* address-family vpnv6 unicast vrf all segment-routing srv6 alloc mode {per-vrf}**: Specify the SID behavior (allocation mode)
 - Use the **per-vrf** keyword to specify that the same service SID (uDT6 behavior) be used for all the routes advertised from a unique VRF.
- **router bgp *as-number* address-family vpnv6 unicast vrf all segment-routing srv6 locator *WORD***: Specify the locator

This example shows how to configure the SRv6 locator for all VRFs under VPNv6 Address Family, with per-VRF label allocation mode:

```

Node1(config)# router bgp 100
Node1(config-bgp)# address-family vpnv6 unicast
Node1(config-bgp-af)# vrf all
Node1(config-bgp-af-vrfall)# segment-routing srv6
Node1(config-bgp-af-vrfall-srv6)# locator Nodel-locator
Node1(config-bgp-af-vrfall-srv6)# alloc mode per-vrf
Node1(config-bgp-af-vrfall-srv6)# exit
Node1(config-bgp-af-vrfall)# exit
Node1(config-bgp-af)# exit
Node1(config-bgp)# neighbor 3001::12:1:1:4
Node1(config-bgp-nbr)# remote-as 100
Node1(config-bgp-nbr)# address-family vpnv6 unicast
Node1(config-bgp-nbr-af)# exit
Node1(config-bgp-nbr)# exit
Node1(config-bgp)# vrf vrf_cust6
Node1(config-bgp-vrf)# rd 100:6
Node1(config-bgp-vrf)# address-family ipv6 unicast
Node1(config-bgp-vrf-af)# commit

```

Running Configuration

```

router bgp 100
  address-family vpnv6 unicast
    vrf all
      segment-routing srv6
        locator Nodel-locator
        alloc mode per-vrf
    !
  !
  neighbor 3001::12:1:1:4
    remote-as 100
    address-family vpnv6 unicast
  !
  vrf vrf_cust6
    rd 100:6
    address-family ipv6 unicast
  !
!
end

```

Use Case 3: Assigning SRv6 Locator for a specific VRF

To configure the SRv6 locator for a specific VRF under IPv6 Address Family and specify the allocation mode, use the following commands:

- **router bgp** *as-number* **vrf** *WORD* **address-family ipv6 unicast segment-routing srv6**: Enable SRv6
- **router bgp** *as-number* **vrf** *WORD* **address-family ipv6 unicast segment-routing srv6 alloc mode { per-vrf }**: Specify the SID behavior (allocation mode)
 - Use the **per-vrf** keyword to specify that the same service SID (uDT6 behavior) be used for all the routes advertised from a unique VRF.
- **router bgp** *as-number* **vrf** *WORD* **address-family ipv6 unicast segment-routing srv6 locator** *WORD*: Specify the locator

This example shows how to configure the SRv6 locator for an individual VRF, with per-VRF label allocation mode:

```

Node1(config)# router bgp 100
Node1(config-bgp)# address-family vpv6 unicast
Node1(config-bgp-af)# exit
Node1(config-bgp)# neighbor 3001::12:1:1:4
Node1(config-bgp-nbr)# remote-as 100
Node1(config-bgp-nbr)# address-family vpv6 unicast
Node1(config-bgp-nbr-af)# exit
Node1(config-bgp-nbr)# exit
Node1(config-bgp)# vrf vrf_cust6
Node1(config-bgp-vrf)# rd 100:6
Node1(config-bgp-vrf)# address-family ipv6 unicast
Node1(config-bgp-vrf-af)# segment-routing srv6
Node1(config-bgp-vrf-af-srv6)# locator Node1-locator
Node1(config-bgp-vrf-af-srv6)# alloc mode per-vrf
Node1(config-bgp-vrf-af-srv6)# commit

```

Running Configuration

```

router bgp 100
  address-family vpv6 unicast
  !
  neighbor 3001::12:1:1:4
    remote-as 100
  address-family vpv6 unicast
  !
  !
  vrf vrf_cust6
    rd 100:6
    address-family ipv6 unicast
      segment-routing srv6
        locator Node1-locator
        alloc mode per-vrf
    !
  !
  !
end

```

Use Case 4: Assigning SRv6 Locator for a Specific Prefix

This use case provides the ability to assign a specific SRv6 locator for a given prefix or a set of prefixes. The egress PE advertises the prefix with the specified locator. This allows for per-prefix steering into desired transport behaviors, such as Flex Algo.

To assign an SRv6 locator for a specific prefix, configure a route policy to specify the SID allocation mode based on match criteria. Examples of match criteria are destination-based match or community-based match.

- Supported SID allocation mode is per-VRF.
- For per-VRF allocation mode, you can also specify the SRv6 locator.
 - If an SRv6 locator is specified in the route policy, BGP will use that to allocate per-VRF SID. If the specified locator is invalid, the SID will not be allocated.
 - If an SRv6 locator is not specified in the route policy, the default locator is used to allocate the SID. If the default locator is not configured in BGP, then the SID will not be allocated.

For more information on configuring routing policies, refer to the "Implementing Routing Policy" chapter in the *Routing Configuration Guide*.

The following example shows a route policy specifying the SID allocation mode with destination-based match:

```

Node1(config)# route-policy set_per_prefix_locator_rpl
Node1(config-rpl)# if destination in (3001::1:1:1:1/128) then
Node1(config-rpl-if)# set srv6-alloc-mode per-vrf locator locator1
Node1(config-rpl-if)# elseif destination in (3001::2:2:2:2/128) then
Node1(config-rpl-elseif)# set srv6-alloc-mode per-vrf locator locator2
Node1(config-rpl-elseif)# elseif destination in (3001::3:3:3:3/128) then
Node1(config-rpl-elseif)# set srv6-alloc-mode per-vrf
Node1(config-rpl-elseif)# else
Node1(config-rpl-else)# drop
Node1(config-rpl-else)# endif
Node1(config-rpl)# end-policy

```

To specify per-prefix allocation mode for a specific VRF under IPv6 Address Family, use the following command:

- **router bgp** *as-number* **vrf** *WORD* **address-family ipv6 unicast segment-routing srv6 alloc mode** **route-policy** *policy_name*

This example shows how to specify per-prefix allocation mode for a specific VRF (vrf_cust6) under the IPv6 address family:

```

Node1(config)# router bgp 100
Node1(config-bgp)# vrf vrf_cust6
Node1(config-bgp-vrf)# address-family ipv6 unicast
Node1(config-bgp-vrf-af)# segment-routing srv6
Node1(config-bgp-vrf-af-srv6)# alloc mode route-policy set_per_prefix_locator_rpl

```

Running Configuration

```

route-policy set_per_prefix_locator_rpl
  if destination in (3001::1:1:1:1/128) then
    set srv6-alloc-mode per-vrf locator locator1
  elseif destination in (3001::2:2:2:2/128) then
    set srv6-alloc-mode per-vrf locator locator2
  elseif destination in (3001::3:3:3:3/128) then
    set srv6-alloc-mode per-vrf
  else
    drop
  endif
end-policy
!
router bgp 100
  vrf vrf_cust6
    address-family ipv6 unicast
      segment-routing srv6

```

```

    alloc mode route-policy set_per_prefix_locator_rpl
  !
  !
  !
  !

```

Verify that the local and received SIDs have been correctly allocated under VPNv6 and specific VRF (vrf_cust6):

```
Node1# show bgp vpnv6 unicast local-sids
```

```

BGP router identifier 10.1.1.1, local AS number 1
BGP generic scan interval 60 secs
Non-stop routing is enabled
BGP table state: Active
Table ID: 0x0  RD version: 0
BGP main routing table version 50
BGP NSR Initial initsync version 18 (Reached)
BGP NSR/ISSU Sync-Group versions 0/0
BGP scan interval 60 secs

Status codes: s suppressed, d damped, h history, * valid, > best
                i - internal, r RIB-failure, S stale, N Nexthop-discard
Origin codes: i - IGP, e - EGP, ? - incomplete
   Network          Local Sid                               Alloc mode   Locator
Route Distinguisher: 8:8
*>i3008::8:8:8:8/128 NO SRv6 Sid                       -             -
* i                 NO SRv6 Sid                       -             -
Route Distinguisher: 100:6 (default for vrf vrf_cust6)
*> 3001::1:1:1:1/128 fc00:0:1:40::                per-vrf       locator1
*> 3001::2:2:2:2/128 fc00:8:1:40::                per-vrf       locator2
*> 3001::3:3:3:3/128 fc00:9:1:40::                per-vrf       locator4
*> 3001::5:5:5:5/128 NO SRv6 Sid                       -             -
*> 3001::12:1:1:5/128 NO SRv6 Sid                       -             -
*>i3008::8:8:8:8/128 NO SRv6 Sid                       -             -

```

```
Node1# show bgp vpnv6 unicast received-sids
```

```

BGP router identifier 10.1.1.1, local AS number 1
BGP generic scan interval 60 secs
Non-stop routing is enabled
BGP table state: Active
Table ID: 0x0  RD version: 0
BGP main routing table version 50
BGP NSR Initial initsync version 18 (Reached)
BGP NSR/ISSU Sync-Group versions 0/0
BGP scan interval 60 secs

Status codes: s suppressed, d damped, h history, * valid, > best
                i - internal, r RIB-failure, S stale, N Nexthop-discard
Origin codes: i - IGP, e - EGP, ? - incomplete
   Network          Next Hop                               Received Sid
Route Distinguisher: 8:8
*>i3008::8:8:8:8/128 10.1.1.2                          fc00:0:2:42::
* i                 2400:2020:42:2fff::1                    fc00:0:2:42::
Route Distinguisher: 100:6 (default for vrf vrf_cust6)
*> 3001::1:1:1:1/128 11.1.1.2                          NO SRv6 Sid
*> 3001::2:2:2:2/128 11.1.1.2                          NO SRv6 Sid
*> 3001::3:3:3:3/128 11.1.1.2                          NO SRv6 Sid
*> 3001::5:5:5:5/128 11.1.1.2                          NO SRv6 Sid
*> 3001::12:1:1:5/128 13.2.2.2                          NO SRv6 Sid
*>i3008::8:8:8:8/128 10.1.1.2                          fc00:0:2:42::

```

```

Node1# show bgp vrf vrf_cust6 local-sids
BGP VRF vrf_cust6, state: Active
BGP Route Distinguisher: 10.1.1.1:0
VRF ID: 0x60000004
BGP router identifier 10.1.1.1, local AS number 1
Non-stop routing is enabled
BGP table state: Active
Table ID: 0xe0000013  RD version: 37
BGP main routing table version 37
BGP NSR Initial initsync version 18 (Reached)
BGP NSR/ISSU Sync-Group versions 0/0

Status codes: s suppressed, d damped, h history, * valid, > best
                i - internal, r RIB-failure, S stale, N Nexthop-discard
Origin codes: i - IGP, e - EGP, ? - incomplete
   Network                Local Sid                                Alloc mode  Locator
Route Distinguisher: 8:8
*>i3008::8:8:8:8/128      NO SRv6 Sid                                -           -
* i                       NO SRv6 Sid                                -           -
Route Distinguisher: 100:6 (default for vrf vrf_cust6)
*> 3001::1:1:1:1/128     fc00:0:1:40::                             per-vrf     locator1
*> 3001::2:2:2:2/128     fc00:8:1:40::                             per-vrf     locator2
*> 3001::3:3:3:3/128     fc00:9:1:40::                             per-vrf     locator4
*> 3001::5:5:5:5/128     NO SRv6 Sid                                -           -
*> 3001::12:1:1:5/128   NO SRv6 Sid                                -           -
*>i3008::8:8:8:8/128    NO SRv6 Sid                                -           -

```

```

Node1# show bgp vrf vrf_cust6 received-sids
BGP VRF vrf_cust6, state: Active
BGP Route Distinguisher: 100:6
VRF ID: 0x60000004
BGP router identifier 10.1.1.1, local AS number 1
Non-stop routing is enabled
BGP table state: Active
Table ID: 0xe0000013  RD version: 37
BGP main routing table version 37
BGP NSR Initial initsync version 18 (Reached)
BGP NSR/ISSU Sync-Group versions 0/0

Status codes: s suppressed, d damped, h history, * valid, > best
                i - internal, r RIB-failure, S stale, N Nexthop-discard
Origin codes: i - IGP, e - EGP, ? - incomplete
   Network                Next Hop                                Received Sid
Route Distinguisher: 100:6 (default for vrf vrf_cust6)
*> 3001::1:1:1:1/128     11.1.1.2                                NO SRv6 Sid
*> 3001::2:2:2:2/128     11.1.1.2                                NO SRv6 Sid
*> 3001::3:3:3:3/128     11.1.1.2                                NO SRv6 Sid
*> 3001::5:5:5:5/128     11.1.1.2                                NO SRv6 Sid
*> 3001::12:1:1:5/128    13.2.2.2                                NO SRv6 Sid
*>i3008::8:8:8:8/128    10.1.1.2                                fc00:0:2:42::

```

Verification

The following figure shows a VPNv6 scenario. The sequence of commands included correspond to router Node1 acting as Ingress PE, and routers Node4 and Node5 acting as Egress PEs.

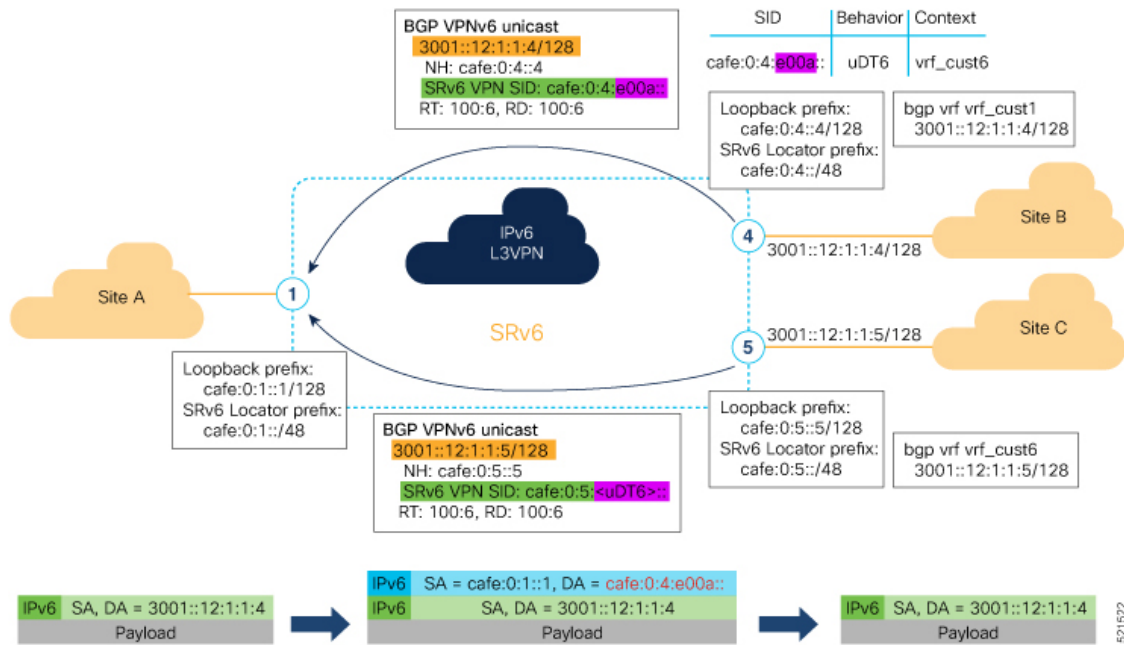

The following examples shows how to verify the SRv6 based L3VPN configurations for an Individual VRF with per VRF label allocation mode.

In this example, we can observe the uDT6 SID associated with the IPv6 L3VPN, where uDT6 behavior represents Endpoint with decapsulation and IPv6 table lookup.

```
Nodel# show segment-routing srv6 sid
Fri Jan 29 19:31:53.293 UTC
```

```
*** Locator: 'Nodel-locator' ***
```

SID	State	RW	Behavior	Context	Owner
cafe:0:1::	InUse	Y	uN (PSP/USD)	'default':1	sidmgr
cafe:0:1:e000::	InUse	Y	uA (PSP/USD)	[Hu0/0/0/0, Link-Local]:0	isis-1
cafe:0:1:e001::	InUse	Y	uA (PSP/USD)	[Hu0/0/0/1, Link-Local]:0	isis-1
cafe:0:1:e002::	InUse	Y	uDT4	'vrf_cust1'	bgp-100
cafe:0:1:e003::	InUse	Y	uDT4	'vrf_cust2'	bgp-100
cafe:0:1:e004::	InUse	Y	uDT4	'vrf_cust3'	bgp-100
cafe:0:1:e005::	InUse	Y	uDT4	'vrf_cust4'	bgp-100
cafe:0:1:e006::	InUse	Y	uDT4	'vrf_cust5'	bgp-100
cafe:0:1:e007::	InUse	Y	uA (PSP/USD)	[Hu0/0/0/0, Link-Local]:0:P	isis-1
cafe:0:1:e008::	InUse	Y	uA (PSP/USD)	[Hu0/0/0/1, Link-Local]:0:P	isis-1
cafe:0:1:e009::	InUse	Y	uDT6	'default'	bgp-100
cafe:0:1:e00a::	InUse	Y	uDT6	'vrf_cust6'	bgp-100

```
InUse Y
```

The following examples show how to verify the SRv6 based L3VPN configuration using the **show bgp vpnv6 unicast** commands on the Ingress PE.

```
Nodel# show bgp vpnv6 unicast summary
```

```
Fri Jan 29 19:33:01.177 UTC
BGP router identifier 10.1.1.1, local AS number 100
BGP generic scan interval 60 secs
Non-stop routing is enabled
BGP table state: Active
Table ID: 0x0 RD version: 0
BGP main routing table version 6
BGP NSR Initial initsync version 4 (Reached)
BGP NSR/ISSU Sync-Group versions 0/0
BGP scan interval 60 secs
```

```
BGP is operating in STANDALONE mode.
```

Process	RcvTblVer	bRIB/RIB	LabelVer	ImportVer	SendTblVer	StandbyVer
Speaker	6	6	6	6	6	0

Neighbor	Spk	AS	MsgRcvd	MsgSent	TblVer	InQ	OutQ	Up/Down	St/PfxRcd
cafe:0:4::4	0	100	122	123	6	0	0	00:20:05	1
cafe:0:5::5	0	100	111	111	0	0	0	00:49:46	1

```
Nodel# show bgp vpnv6 unicast rd 100:6
```

```
Fri Jan 29 19:41:01.334 UTC
BGP router identifier 10.1.1.1, local AS number 100
BGP generic scan interval 60 secs
Non-stop routing is enabled
BGP table state: Active
Table ID: 0x0 RD version: 0
BGP main routing table version 8
BGP NSR Initial initsync version 4 (Reached)
BGP NSR/ISSU Sync-Group versions 0/0
BGP scan interval 60 secs
```

```
Status codes: s suppressed, d damped, h history, * valid, > best
                i - internal, r RIB-failure, S stale, N Nexthop-discard
Origin codes: i - IGP, e - EGP, ? - incomplete
Network        Next Hop          Metric LocPrf Weight Path
Route Distinguisher: 100:6 (default for vrf vrf_cust6)
*> 3001::12:1:1:1/128 :: 0 32768 ?
*>i3001::12:1:1:4/128 cafe:0:4::4 0 100 0 ?
*>i3001::12:1:1:5/128 cafe:0:5::5 0 100 0 ?
```

```
Processed 3 prefixes, 3 paths
```

```
Nodel# show bgp vpnv6 unicast rd 100:6 3001::12:1:1:4/128
```

```
Fri Jan 29 19:41:42.008 UTC
BGP routing table entry for 3001::12:1:1:4/128, Route Distinguisher: 100:6
Versions:
  Process          bRIB/RIB  SendTblVer
  Speaker          6         6
Last Modified: Jan 29 19:29:35.858 for 00:12:06
Paths: (1 available, best #1)
  Not advertised to any peer
  Path #1: Received by speaker 0
  Not advertised to any peer
  Local, (received & used)
    cafe:0:4::4 (metric 30) from cafe:0:4::4 (10.1.1.4)
```

```

Received Label 0xe00a00
Origin incomplete, metric 0, localpref 100, valid, internal, best, group-best,
import-candidate, imported
Received Path ID 0, Local Path ID 1, version 6
Extended community: RT:100:6
PSID-Type:L3, SubTLV Count:1
SubTLV:
  T:1(Sid information), Sid:cafe:0:4::, Behavior:62, SS-TLV Count:1
SubSubTLV:
  T:1(Sid structure):
    Source AFI: VPNv6 Unicast, Source VRF: vrf_cust6, Source Route Distinguisher: 100:6

```

The following examples show how to verify the BGP prefix information for VRF instances:

```

Node1# show bgp vrf vrf_cust6 ipv6 unicast
Fri Jan 29 19:42:05.675 UTC
BGP VRF vrf_cust6, state: Active
BGP Route Distinguisher: 100:6
VRF ID: 0x60000007
BGP router identifier 10.1.1.1, local AS number 100
Non-stop routing is enabled
BGP table state: Active
Table ID: 0xe0800016 RD version: 8
BGP main routing table version 8
BGP NSR Initial initsync version 4 (Reached)
BGP NSR/ISSU Sync-Group versions 0/0

Status codes: s suppressed, d damped, h history, * valid, > best
               i - internal, r RIB-failure, S stale, N Nexthop-discard
Origin codes: i - IGP, e - EGP, ? - incomplete
   Network          Next Hop          Metric LocPrf Weight Path
Route Distinguisher: 100:6 (default for vrf vrf_cust6)
*> 3001::12:1:1:1/128 ::                0           32768 ?
*>i3001::12:1:1:4/128 cafe:0:4::4        0          100      0 ?
*>i3001::12:1:1:5/128 cafe:0:5::5        0          100      0 ?

Processed 3 prefixes, 3 paths

Node1# show bgp vrf vrf_cust6 ipv6 unicast 3001::12:1:1:4/128

BGP routing table entry for 3001::12:1:1:4/128, Route Distinguisher: 100:6
Versions:
  Process          bRIB/RIB  SendTblVer
  Speaker          17        17
Last Modified: Jan 15 16:50:44.032 for 01:48:21
Paths: (1 available, best #1)
  Not advertised to any peer
  Path #1: Received by speaker 0
  Not advertised to any peer
  Local, (received & used)
    cafe:0:4::4 (metric 30) from cafe:0:4::4 (10.1.1.4)
    Received Label 0xe00a00
    Origin incomplete, metric 0, localpref 100, valid, internal, best, group-best,
import-candidate, imported
    Received Path ID 0, Local Path ID 1, version 17
    Extended community: RT:100:6
    PSID-Type:L3, SubTLV Count:1
    SubTLV:
      T:1(Sid information), Sid:cafe:0:4::, Behavior:62, SS-TLV Count:1
    SubSubTLV:
      T:1(Sid structure):
        Source AFI: VPNv6 Unicast, Source VRF: vrf_cust6, Source Route Distinguisher: 100:6

```

The following examples show how to verify the current routes in the Routing Information Base (RIB):

```
Nodel# show route vrf vrf_cust6 ipv6 unicast
Fri Jan 29 19:43:28.067 UTC
```

```
Codes: C - connected, S - static, R - RIP, B - BGP, (>) - Diversion path
D - EIGRP, EX - EIGRP external, O - OSPF, IA - OSPF inter area
N1 - OSPF NSSA external type 1, N2 - OSPF NSSA external type 2
E1 - OSPF external type 1, E2 - OSPF external type 2, E - EGP
i - ISIS, L1 - IS-IS level-1, L2 - IS-IS level-2
ia - IS-IS inter area, su - IS-IS summary null, * - candidate default
U - per-user static route, o - ODR, L - local, G - DAGR, l - LISp
A - access/subscriber, a - Application route
M - mobile route, r - RPL, t - Traffic Engineering, (!) - FRR Backup path
```

Gateway of last resort is not set

```
L   3001::12:1:1:1/128 is directly connected,
    01:01:23, Loopback105
B   3001::12:1:1:4/128
    [200/0] via cafe:0:4::4 (nexthop in vrf default), 00:13:52
B   3001::12:1:1:5/128
    [200/0] via cafe:0:5::5 (nexthop in vrf default), 00:05:53
```

```
Nodel# show route vrf vrf_cust6 ipv6 unicast 3001::12:1:1:4/128
Fri Jan 29 19:43:55.645 UTC
```

```
Routing entry for 3001::12:1:1:4/128
  Known via "bgp 100", distance 200, metric 0, type internal
  Installed Jan 29 19:29:35.696 for 00:14:20
  Routing Descriptor Blocks
    cafe:0:4::4, from cafe:0:4::4
      Nexthop in Vrf: "default", Table: "default", IPv6 Unicast, Table Id: 0xe0800000
      Route metric is 0
  No advertising protos.
```

```
Nodel# show route vrf vrf_cust6 ipv6 unicast 3001::12:1:1:4/128 detail
Fri Jan 29 19:44:17.914 UTC
```

```
Routing entry for 3001::12:1:1:4/128
  Known via "bgp 100", distance 200, metric 0, type internal
  Installed Jan 29 19:29:35.696 for 00:14:42
  Routing Descriptor Blocks
    cafe:0:4::4, from cafe:0:4::4
      Nexthop in Vrf: "default", Table: "default", IPv6 Unicast, Table Id: 0xe0800000
      Route metric is 0
      Label: None
      Tunnel ID: None
      Binding Label: None
      Extended communities count: 0
      Source RD attributes: 0x0000:100:6
      NHID:0x0(Ref:0)
      SRv6 Headend: H.Encaps.Red [f3216], SID-list {cafe:0:4:e00a::}
  Route version is 0x1 (1)
  No local label
  IP Precedence: Not Set
  QoS Group ID: Not Set
  Flow-tag: Not Set
  Fwd-class: Not Set
  Route Priority: RIB_PRIORITY_RECURSIVE (12) SVD Type RIB_SVD_TYPE_REMOTE
  Download Priority 3, Download Version 3
  No advertising protos.
```

The following examples show how to verify the current IPv6 Cisco Express Forwarding (CEF) table:

```
Node1# show cef vrf vrf_cust6 ipv6
```

```
Fri Jan 29 19:44:56.888 UTC
```

```
::/0
  drop      default handler
3001::12:1:1:1/128
  receive   Loopback105
3001::12:1:1:4/128
  recursive cafe:0:4::/128
3001::12:1:1:5/128
  recursive cafe:0:5::/128
fe80::/10
  receive
ff02::/16
  receive
ff02::2/128
  receive
ff02::1:ff00:0/104
  receive
ff05::/16
  receive
ff12::/16
  receive
```

```
Node1# show cef vrf vrf_cust6 ipv6 3001::12:1:1:4/128
```

```
Fri Jan 29 19:45:23.607 UTC
```

```
3001::12:1:1:4/128, version 3, SRv6 Headend, internal 0x5000001 0x30 (ptr 0x78f2e0e0) [1],
  0x0 (0x0), 0x0 (0x888a3ac8)
```

```
Updated Jan 29 19:29:35.700
```

```
Prefix Len 128, traffic index 0, precedence n/a, priority 3
```

```
  via cafe:0:4::/128, 7 dependencies, recursive [flags 0x6000]
```

```
  path-idx 0 NHID 0x0 [0x78cd2a14 0x0]
```

```
  next hop VRF - 'default', table - 0xe0800000
```

```
  next hop cafe:0:4::/128 via cafe:0:4::/48
```

```
  SRv6 H.Encaps.Red SID-list {cafe:0:4:e00a::}
```

```
Node1# show cef vrf vrf_cust6 ipv6 3001::12:1:1:4/128 detail
```

```
Fri Jan 29 19:45:55.847 UTC
```

```
3001::12:1:1:4/128, version 3, SRv6 Headend, internal 0x5000001 0x30 (ptr 0x78f2e0e0) [1],
  0x0 (0x0), 0x0 (0x888a3ac8)
```

```
Updated Jan 29 19:29:35.700
```

```
Prefix Len 128, traffic index 0, precedence n/a, priority 3
```

```
  gateway array (0x78afe238) reference count 1, flags 0x2010, source rib (7), 0 backups
    [1 type 3 flags 0x48441 (0x78ba9a60) ext 0x0 (0x0)]
```

```
  LW-LDI[type=0, refc=0, ptr=0x0, sh-ldi=0x0]
```

```
  gateway array update type-time 1 Jan 29 19:29:35.699
```

```
  LDI Update time Jan 29 19:29:35.701
```

```
Level 1 - Load distribution: 0
```

```
[0] via cafe:0:4::/128, recursive
```

```
  via cafe:0:4::/128, 7 dependencies, recursive [flags 0x6000]
```

```
  path-idx 0 NHID 0x0 [0x78cd2a14 0x0]
```

```
  next hop VRF - 'default', table - 0xe0800000
```

```
  next hop cafe:0:4::/128 via cafe:0:4::/48
```

```
  SRv6 H.Encaps.Red SID-list {cafe:0:4:e00a::}
```

```
Load distribution: 0 1 (refcount 1)
```

Hash	OK	Interface	Address
0	Y	HundredGigE0/0/0/0	remote

```
1      Y      HundredGigE0/0/0/1      remote
```

SRv6 Services: IPv4 BGP Global

This feature extends support of SRv6-based BGP services to include IPv4 global BGP by implementing uDT4 SRv6 functions at the PE node ([draft-ietf-bess-srv6-services](#)).

Usage Guidelines and Limitations

- SRv6 locator can be assigned globally or under IPv4 unicast address family
- Equal-Cost Multi-path (ECMP) and Unequal Cost Multipath (UCMP) are supported.
- BGP, OSPF, Static are supported as PE-CE protocol.
- BGP route leaking between BGP Global and L3VPN is supported. Refer to the [Implementing BGP](#) chapter in the *BGP Configuration Guide for Cisco NCS 5500 Series Routers*.
- Dual-Stack L3 Services (IPv4 BGP global, IPv6 BGP global) are supported.

BGP Global IPv4 Over SRv6 with Per-AFI SID Allocation Mode (uDT4)

To configure BGP global IPv4 over SRv6, use the following commands:

- **router bgp *as-number* address-family ipv4 unicast segment-routing srv6**: Enable SRv6
- **router bgp *as-number* address-family ipv4 unicast segment-routing srv6 alloc mode {per-vrf | route-policy *policy_name*}**: Specify the SID behavior (allocation mode).
 - **per-vrf**: Specifies that the same label is be used for all the routes advertised from a unique VRF.
 - **route-policy *policy_name***: Uses a route policy to determine the SID allocation mode and locator (if provided) for given prefix.
- **router bgp *as-number* address-family ipv4 unicast segment-routing srv6 locator *WORD***: Specify the locator
- **router bgp *as-number* {af-group *WORD*| neighbor-group *WORD* | neighbor *ipv6-addr*} address-family ipv4 unicast encapsulation-type srv6**: Specify the encapsulation type for SRv6.
 - Use **af-group *WORD*** to apply the SRv6 encapsulation type to the address family group for BGP neighbors.
 - Use **neighbor-group *WORD*** to apply the SRv6 encapsulation type to the neighbor group for BGP neighbors.
 - Use **neighbor *ipv6-addr*** to apply the SRv6 encapsulation type to the specific BGP neighbor.

Use Case 1: BGP Global IPv4 over SRv6 with Per-AFI SID Allocation

The following example shows how to configure BGP global IPv4 over SRv6 with per-AFI SID allocation.

```
Node1(config)# router bgp 1
Node1(config-bgp)# bgp router-id 10.1.0.1
Node1(config-bgp)# address-family ipv4 unicast
Node1(config-bgp-af)# segment-routing srv6
```

```

Node1(config-bgp-af-srv6)# locator Node1
Node1(config-bgp-af-srv6)# alloc mode per-vrf
Node1(config-bgp-af-srv6)# exit
Node1(config-bgp-af)# exit
Node1(config-bgp)# neighbor 60::2
Node1(config-bgp-nbr)# remote-as 1
Node1(config-bgp-nbr)# update-source Loopback1
Node1(config-bgp-nbr)# address-family ipv4 unicast
Node1(config-bgp-nbr-af)# encapsulation-type srv6
Node1(config-bgp-nbr-af)# exit
Node1(config-bgp-nbr)# exit
Node1(config-bgp)# neighbor 52.52.52.1
Node1(config-bgp-nbr)# remote-as 3
Node1(config-bgp-nbr)# address-family ipv4 unicast
Node1(config-bgp-nbr-af)# route-policy passall in
Node1(config-bgp-nbr-af)# route-policy passall out
Node1(config-bgp-nbr-af)# commit

```

Running Configuration

```

router bgp 1
  bgp router-id 10.1.0.1
  address-family ipv4 unicast
    segment-routing srv6
      locator Node1
      alloc mode per-vrf
  !
!
neighbor 60::2
  remote-as 1
  update-source Loopback1
  address-family ipv4 unicast
    encapsulation-type srv6
  !
!
neighbor 52.52.52.1
  remote-as 3
  address-family ipv4 unicast
    route-policy passall in
    route-policy passall out
  !
!
!

```

Use Case 2: BGP Global IPv4 over SRv6 with Per-Prefix SID Allocation

This use case provides the ability to assign a specific SRv6 locator for a given prefix or a set of prefixes. The egress PE advertises the prefix with the specified locator. This allows for per-prefix steering into desired transport behaviors, such as Flex Algo.

To assign an SRv6 locator for a specific prefix, configure a route policy to specify the SID allocation mode based on match criteria. Examples of match criteria are destination-based match or community-based match.

- Supported SID allocation mode is per-VRF.
- For per-VRF allocation mode, you can also specify the SRv6 locator.
 - If an SRv6 locator is specified in the route policy, BGP will use that to allocate per-VRF SID. If the specified locator is invalid, the SID will not be allocated.

- If an SRv6 locator is not specified in the route policy, the default locator is used to allocate the SID. If the default locator is not configured in BGP, then the SID will not be allocated.

For more information on configuring routing policies, refer to the "Implementing Routing Policy" chapter in the *Routing Configuration Guide*.

The following example shows a route policy specifying the SID allocation mode with destination-based match:

```

Node1(config)# route-policy set_per_prefix_locator_rpl
Node1(config-rpl)# if destination in (10.1.1.0/24) then
Node1(config-rpl-if)# set srv6-alloc-mode per-vrf locator locator1
Node1(config-rpl-if)# elseif destination in (2.2.2.0/24) then
Node1(config-rpl-elseif)# set srv6-alloc-mode per-vrf locator locator2
Node1(config-rpl-elseif)# elseif destination in (3.3.3.0/24) then
Node1(config-rpl-elseif)# set srv6-alloc-mode per-vrf
Node1(config-rpl-elseif)# else
Node1(config-rpl-else)# drop
Node1(config-rpl-else)# endif
Node1(config-rpl)# end-policy
Node1(config)#

```

The following example shows how to configure BGP global IPv4 over SRv6 with a route policy to determine the SID allocation mode for given prefix.

```

Node1(config)# router bgp 100
Node1(config-bgp)# address-family ipv4 unicast
Node1(config-bgp-af)# segment-routing srv6
Node1(config-bgp-af-srv6)# alloc mode route-policy set_per_prefix_locator_rpl

```

Running Configuration

```

route-policy set_per_prefix_locator_rpl
  if destination in (10.1.1.0/24) then
    set srv6-alloc-mode per-vrf locator locator1
  elseif destination in (2.2.2.0/24) then
    set srv6-alloc-mode per-vrf locator locator2
  elseif destination in (3.3.3.0/24) then
    set srv6-alloc-mode per-vrf
  else
    drop
  endif
end-policy
!
router bgp 100
  address-family ipv4 unicast
    segment-routing srv6
      alloc mode route-policy set_per_prefix_locator_rpl
    !
  !
!

```

Verify that the local and received SIDs have been correctly allocated under BGP IPv4 address family:

```

Node1# show bgp ipv4 unicast local-sids
...
Status codes: s suppressed, d damped, h history, * valid, > best
               i - internal, r RIB-failure, S stale, N Nexthop-discard
Origin codes: i - IGP, e - EGP, ? - incomplete

```

Network	Local Sid	Alloc mode	Locator
*> 10.1.1.0/24	fc00:8:1:41::	per-vrf	locator2
*> 2.2.2.0/24	fc00:0:1:41::	per-vrf	locator1

```
*> 3.3.3.0/24          fc00:9:1:42::          per-vrf    locator4
*> 10.1.1.5/32         NO SRv6 Sid           -          -
* i8.8.8.8/32         NO SRv6 Sid           -          -
```

```
Node1# show bgp ipv4 unicast received-sids
```

```
...
Status codes: s suppressed, d damped, h history, * valid, > best
               i - internal, r RIB-failure, S stale, N Nexthop-discard
Origin codes: i - IGP, e - EGP, ? - incomplete
   Network      Next Hop          Received Sid
*> 10.1.1.0/24   66.2.2.2         NO SRv6 Sid
*> 2.2.2.0/24   66.2.2.2         NO SRv6 Sid
*> 3.3.3.0/24   66.2.2.2         NO SRv6 Sid
*> 10.1.1.5/32  66.2.2.2         NO SRv6 Sid
* i8.8.8.8/32   77.1.1.2         fc00:0:2:41::
```

SRv6 Services: IPv6 BGP Global

Table 7: Feature History Table

Feature Name	Release Information	Feature Description
SRv6 Services: BGP Global IPv6	Release 7.3.1	With this feature, the egress PE can signal an SRv6 Service SID with the BGP global route. The ingress PE encapsulates the IPv4/IPv6 payload in an outer IPv6 header where the destination address is the SRv6 Service SID provided by the egress PE. BGP messages between PEs carry SRv6 Service SIDs as a means to interconnect PEs.

This feature extends support of SRv6-based BGP services to include IPv6 global BGP by implementing uDT6 SRv6 functions at the PE node ([draft-ietf-bess-srv6-services](#)).

Usage Guidelines and Limitations

- SRv6 locator can be assigned globally or under IPv6 unicast address family
- Equal-Cost Multi-path (ECMP) and Unequal Cost Multipath (UCMP) are supported.
- BGP, OSPF, Static are supported as PE-CE protocol.
- BGP route leaking between BGP Global and L3VPN is supported. Refer to the [Implementing BGP](#) chapter in the *BGP Configuration Guide for Cisco NCS 5500 Series Routers*.
- Dual-Stack L3 Services (IPv4 BGP global, IPv6 BGP global) are supported.

BGP Global IPv6 Over SRv6 with Per-AFI SID Allocation Mode (uDT6)

To configure BGP global IPv6 over SRv6, use the following commands:

- **router bgp *as-number* address-family ipv6 unicast segment-routing srv6:** Enable SRv6

- **router bgp *as-number* address-family ipv6 unicast segment-routing srv6 alloc mode {per-vrf | route-policy *policy_name*}**: Specify the SID behavior (allocation mode).
 - **per-vrf**: Specifies that the same label is be used for all the routes advertised from a unique VRF.
 - **route-policy *policy_name***: Uses a route policy to determine the SID allocation mode and locator (if provided) for given prefix.
- **router bgp *as-number* address-family ipv6 unicast segment-routing srv6 locator *WORD***: Specify the locator
- **router bgp *as-number* {af-group *WORD*| neighbor-group *WORD*| neighbor *ipv6-addr*} address-family ipv6 unicast encapsulation-type srv6**: Specify the encapsulation type for SRv6.
 - Use **af-group *WORD*** to apply the SRv6 encapsulation type to the address family group for BGP neighbors.
 - Use **neighbor-group *WORD*** to apply the SRv6 encapsulation type to the neighbor group for Border Gateway Protocol (BGP) neighbors.
 - Use **neighbor *ipv6-addr*** to apply the SRv6 encapsulation type to the specific BGP neighbor.

Use Case 1: BGP Global IPv6 over SRv6 with Per-AFI SID Allocation

The following example shows how to configure BGP global IPv6 over SRv6 with per-AFI SID allocation.

```

Node1(config)# router bgp 100
Node1(config-bgp)# bgp router-id 10.1.1.1
Node1(config-bgp)# segment-routing srv6
Node1(config-bgp-gbl-srv6)# locator Node1
Node1(config-bgp-gbl-srv6)# exit
Node1(config-bgp)# address-family ipv6 unicast
Node1(config-bgp-af)# segment-routing srv6
Node1(config-bgp-af-srv6)# locator Node1
Node1(config-bgp-af-srv6)# alloc mode per-vrf
Node1(config-bgp-af-srv6)# exit
Node1(config-bgp-af)# exit
Node1(config-bgp)# neighbor cafe:0:4::4
Node1(config-bgp-nbr)# address-family ipv6 unicast
Node1(config-bgp-nbr-af)# encapsulation-type srv6
Node1(config-bgp-nbr-af)# exit
Node1(config-bgp-nbr)# exit
Node1(config-bgp)# neighbor cafe:0:5::5
Node1(config-bgp-nbr)# address-family ipv6 unicast
Node1(config-bgp-nbr-af)# encapsulation-type srv6
Node1(config-bgp-nbr-af)# commit

```

Running Configuration

```

router bgp 100
  bgp router-id 10.1.1.1
  segment-routing srv6
    locator Node1
  !
  address-family ipv6 unicast
    segment-routing srv6
      locator Node1
      alloc mode per-vrf
    !
  !

```

```

neighbor cafe:0:4::4
  address-family ipv6 unicast
  encapsulation-type srv6
!
neighbor cafe:0:5::5
  address-family ipv6 unicast
  encapsulation-type srv6

```

Use Case 2: BGP Global IPv6 over SRv6 with Per-Prefix SID Allocation

This use case provides the ability to assign a specific SRv6 locator for a given prefix or a set of prefixes. The egress PE advertises the prefix with the specified locator. This allows for per-prefix steering into desired transport behaviors, such as Flex Algo.

To assign an SRv6 locator for a specific prefix, configure a route policy to specify the SID allocation mode based on match criteria. Examples of match criteria are destination-based match or community-based match.

- Supported SID allocation modes are per-VRF and per-CE.
- For per-VRF allocation mode, you can also specify the SRv6 locator.
 - If an SRv6 locator is specified in the route policy, BGP will use that to allocate per-VRF SID. If the specified locator is invalid, the SID will not be allocated.
 - If an SRv6 locator is not specified in the route policy, the default locator is used to allocate the SID. If the default locator is not configured in BGP, then the SID will not be allocated.
- Per-CE allocation mode always uses the default locator to allocate the SID.

For more information on configuring routing policies, refer to the "Implementing Routing Policy" chapter in the *Routing Configuration Guide*.

The following example shows a route policy specifying the SID allocation mode with destination-based match:

```

Node1(config)# route-policy set_per_prefix_locator_rpl
Node1(config-rpl)# if destination in (3001::1:1:1:1/128) then
Node1(config-rpl-if)# set srv6-alloc-mode per-vrf locator locator1
Node1(config-rpl-elseif)# elseif destination in (3001::2:2:2:2/128) then
Node1(config-rpl-elseif)# set srv6-alloc-mode per-vrf locator locator2
Node1(config-rpl-elseif)# elseif destination in (3001::3:3:3:3/128) then
Node1(config-rpl-elseif)# set srv6-alloc-mode per-vrf
Node1(config-rpl-elseif)# elseif destination in (3001::4:4:4:4/128) then
Node1(config-rpl-elseif)# set srv6-alloc-mode per-ce
Node1(config-rpl-elseif)# else
Node1(config-rpl-else)# drop
Node1(config-rpl-else)# endif
Node1(config-rpl)# end-policy

```

The following example shows how to configure BGP global IPv6 over SRv6 with a route policy to determine the SID allocation mode for given prefix.

```

Node1(config)# router bgp 100
Node1(config-bgp)# address-family ipv6 unicast
Node1(config-bgp-af)# segment-routing srv6
Node1(config-bgp-af-srv6)# alloc mode route-policy set_per_prefix_locator_rpl

```

Running Configuration

```

route-policy set_per_prefix_locator_rpl
  if destination in (3001::1:1:1:1/128) then
    set srv6-alloc-mode per-vrf locator locator1
  elseif destination in (3001::2:2:2:2/128) then
    set srv6-alloc-mode per-vrf locator locator2
  elseif destination in (3001::3:3:3:3/128) then
    set srv6-alloc-mode per-vrf
  else
    drop
  endif
end-policy
!
router bgp 100
  address-family ipv6 unicast
    segment-routing srv6
      alloc mode route-policy set_per_prefix_locator_rpl
    !
  !

```

Verify that the local and received SIDs have been correctly allocated under BGP IPv6 address family:

```

Node1# show bgp ipv6 unicast local-sids
...
Status codes: s suppressed, d damped, h history, * valid, > best
               i - internal, r RIB-failure, S stale, N Nexthop-discard
Origin codes: i - IGP, e - EGP, ? - incomplete
   Network          Local Sid                               Alloc mode  Locator
*> 3001::1:1:1:1/128 fc00:8:1:41::                per-vrf     locator2
*> 3001::2:2:2:2/128 fc00:0:1:41::                per-vrf     locator1
*> 3001::3:3:3:3/128 fc00:9:1:42::                per-vrf     locator4
*> 3001::5:5:5:5/128 NO SRv6 Sid                    -           -
* i3008::8:8:8:8/128 NO SRv6 Sid                    -           -

Node1# show bgp ipv6 unicast received-sids
...
Status codes: s suppressed, d damped, h history, * valid, > best
               i - internal, r RIB-failure, S stale, N Nexthop-discard
Origin codes: i - IGP, e - EGP, ? - incomplete
   Network          Next Hop          Received Sid
*> 3001::1:1:1:1/128 66.2.2.2         NO SRv6 Sid
*> 3001::2:2:2:2/128 66.2.2.2         NO SRv6 Sid
*> 3001::3:3:3:3/128 66.2.2.2         NO SRv6 Sid
*> 3001::5:5:5:5/128 66.2.2.2         NO SRv6 Sid
* i3008::8:8:8:8/128 77.1.1.2         fc00:0:2:41::

```

Verification

The following figure shows a IPv6 BGP global scenario. The sequence of commands included correspond to router Node1 acting as Ingress PE, and routers Node4 and Node5 acting as Egress PEs.

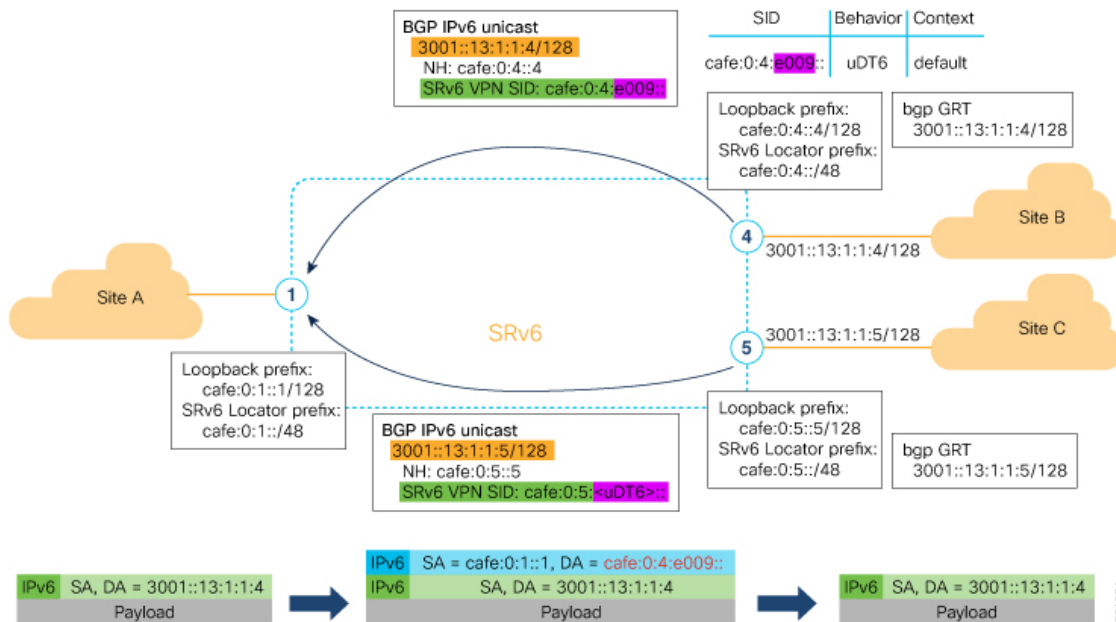

The following examples show how to verify the BGP global IPv6 configuration using the `show bgp ipv6 unicast` commands.

```

Node1# show bgp ipv6 unicast summary
Fri Jan 29 19:48:23.255 UTC
BGP router identifier 10.1.1.1, local AS number 100
BGP generic scan interval 60 secs
Non-stop routing is enabled
BGP table state: Active
Table ID: 0xe0800000 RD version: 4
BGP main routing table version 4
BGP NSR Initial initsync version 2 (Reached)
BGP NSR/ISSU Sync-Group versions 0/0
BGP scan interval 60 secs

BGP is operating in STANDALONE mode.
    
```

Process	RcvTblVer	bRIB/RIB	LabelVer	ImportVer	SendTblVer	StandbyVer
Speaker	4	4	4	4	4	0

Neighbor	Spk	AS	MsgRcvd	MsgSent	TblVer	InQ	OutQ	Up/Down	St/PfxRcd
cafe:0:4::4	0	100	137	138	4	0	0	00:35:27	1
cafe:0:5::5	0	100	138	137	4	0	0	00:10:54	1

```

Node1# show bgp ipv6 unicast
Fri Jan 29 19:49:05.688 UTC
BGP router identifier 10.1.1.1, local AS number 100
BGP generic scan interval 60 secs
Non-stop routing is enabled
BGP table state: Active
Table ID: 0xe0800000 RD version: 4
BGP main routing table version 4
BGP NSR Initial initsync version 2 (Reached)
BGP NSR/ISSU Sync-Group versions 0/0
BGP scan interval 60 secs

Status codes: s suppressed, d damped, h history, * valid, > best
i - internal, r RIB-failure, S stale, N Nexthop-discard
    
```

```

Origin codes: i - IGP, e - EGP, ? - incomplete
  Network          Next Hop          Metric LocPrf Weight Path
*> 3001::13:1:1:1/128 ::
*>i3001::13:1:1:4/128 cafe:0:4::4
                                0      100      0 i
*>i3001::13:1:1:5/128 cafe:0:5::5
                                0      100      0 i

Processed 3 prefixes, 3 paths

Node1# show bgp ipv6 unicast 3001::13:1:1:4/128
Fri Jan 29 19:49:22.067 UTC
BGP routing table entry for 3001::13:1:1:4/128
Versions:
  Process          bRIB/RIB  SendTblVer
  Speaker          3         3
Last Modified: Jan 29 19:14:13.858 for 00:35:08
Paths: (1 available, best #1)
  Not advertised to any peer
  Path #1: Received by speaker 0
  Not advertised to any peer
Local
cafe:0:4::4 (metric 30) from cafe:0:4::4 (10.1.1.4)
  Origin IGP, metric 0, localpref 100, valid, internal, best, group-best
  Received Path ID 0, Local Path ID 1, version 3
PSID-Type:L3, SubTLV Count:1
  SubTLV:
    T:1(Sid information), Sid:cafe:0:4:e009::, Behavior:62, SS-TLV Count:1
  SubSubTLV:
    T:1(Sid structure):

```

The following examples show how to verify the current routes in the Routing Information Base (RIB):

```

Node1# show route ipv6 3001::13:1:1:4/128
Fri Jan 29 19:53:26.839 UTC

Routing entry for 3001::13:1:1:4/128
  Known via "bgp 100", distance 200, metric 0, type internal
  Installed Jan 29 19:14:13.397 for 00:35:28
  Routing Descriptor Blocks
    cafe:0:4::4, from cafe:0:4::4
    Route metric is 0
  No advertising protos.

Node1# show route ipv6 3001::13:1:1:4/128 detail
Fri Jan 29 19:50:08.601 UTC

Routing entry for 3001::13:1:1:4/128
  Known via "bgp 100", distance 200, metric 0, type internal
  Installed Jan 29 19:14:13.397 for 00:35:55
  Routing Descriptor Blocks
    cafe:0:4::4, from cafe:0:4::4
    Route metric is 0
    Label: None
    Tunnel ID: None
    Binding Label: None
    Extended communities count: 0
    NHID:0x0(Ref:0)
SRv6 Headend: H.Encaps.Red [f3216], SID-list {cafe:0:4:e009::}
  Route version is 0x1 (1)
  No local label
  IP Precedence: Not Set
  QoS Group ID: Not Set
  Flow-tag: Not Set
  Fwd-class: Not Set

```

```

Route Priority: RIB_PRIORITY_RECURSIVE (12) SVD Type RIB_SVD_TYPE_LOCAL
Download Priority 4, Download Version 106
No advertising protos.

```

The following examples show how to verify the current IPv6 Cisco Express Forwarding (CEF) table:

```

Node1# show cef ipv6 3001::13:1:1:4/128
Fri Jan 29 19:50:29.149 UTC
3001::13:1:1:4/128, version 106, SRv6 Headend, internal 0x5000001 0x40 (ptr 0x78 cd3944)
[1], 0x0 (0x0), 0x0 (0x888a3a80)
Updated Jan 29 19:14:13.401
Prefix Len 128, traffic index 0, precedence n/a, priority 4
  via cafe:0:4::/128, 7 dependencies, recursive [flags 0x6000]
    path-idx 0 NHID 0x0 [0x78cd2a14 0x0]
    next hop cafe:0:4::/128 via cafe:0:4::/48
  SRv6 H.Encaps.Red SID-list {cafe:0:4:e009::}

```

```

Node1# show cef ipv6 3001::13:1:1:4/128 detail
Fri Jan 29 19:51:00.920 UTC
3001::13:1:1:4/128, version 106, SRv6 Headend, internal 0x5000001 0x40 (ptr 0x78cd3944)
[1], 0x0 (0x0), 0x0 (0x888a3a80)
Updated Jan 29 19:14:13.401
Prefix Len 128, traffic index 0, precedence n/a, priority 4
  gateway array (0x78afel50) reference count 1, flags 0x2010, source rib (7), 0 backups
    [1 type 3 flags 0x48441 (0x78ba99e8) ext 0x0 (0x0)]
  LW-LDI[type=0, refc=0, ptr=0x0, sh-ldi=0x0]
  gateway array update type-time 1 Jan 29 19:14:13.401
  LDI Update time Jan 29 19:14:13.401

```

```

Level 1 - Load distribution: 0
[0] via cafe:0:4::/128, recursive

```

```

  via cafe:0:4::/128, 7 dependencies, recursive [flags 0x6000]
    path-idx 0 NHID 0x0 [0x78cd2a14 0x0]
    next hop cafe:0:4::/128 via cafe:0:4::/48
  SRv6 H.Encaps.Red SID-list {cafe:0:4:e009::}

```

```

  Load distribution: 0 1 (refcount 1)

```

Hash	OK	Interface	Address
0	Y	HundredGigE0/0/0/0	remote
1	Y	HundredGigE0/0/0/1	remote

BGP Signaling for co-existence of IP routes with or without SRv6 SID

Table 8: Feature History Table

Feature Name	Release Information	Feature Description
BGP Signaling for co-existence of IP routes	Release 24.3.1	<p>Introduced in this release on: NCS 5500 fixed port routers; NCS 5700 fixed port routers; NCS 5500 modular routers (NCS 5500 line cards; NCS 5700 line cards [Mode: Compatibility; Native])</p> <p>SRv6 with BGP supports the coexistence of IP routes with or without SRv6 SID over an SRv6-enabled core network. This support enables integrating SRv6 capabilities into existing network infrastructures without replacing IP routing completely.</p> <p>This feature enables flexibility and scalability, transition to new technologies, and enhanced network efficiency, making it easier to migrate from MPLS to SRv6.</p> <p>The feature introduces these changes:</p> <p>CLI:</p> <ul style="list-style-type: none"> • encapsulation-type srv6 relax-sid

Need for BGP Signaling Over SRv6 core

BGP now supports sending internet service over an SRv6 core, assuming that all Global Routing Table (GRT) routes are advertised with an SRv6-SID.

To differentiate between the SRv6 core and non-SRv6 core sides, an **encapsulation-type SRv6** was introduced under the IPv6 BGP peer for the IPv4 unicast address-family. When the "encapsulation-type srv6" is enabled, routes without an SRv6-SID are not sent to the neighbor sessions during update generation. For more information, see [Configuring SRv6 BGP-Based Services, on page 34](#) and <https://datatracker.ietf.org/doc/rfc9252/>.

However, in some networks, there may be a mix of GRT routes with SRv6 SID encapsulation and without SRv6 encapsulation. Hence, there is a need for BGP to allow SRv6-enabled GRT to support the co-existence and signaling of IP routes with or without an SRv6-SID on the same IPv6 neighbor session.

Co-existence of IP routes with or without SRv6 SID

This feature adds a new BGP encapsulation type called **SRv6 relax-SID**, which allows the advertisement of prefixes with or without SRv6 SID over the same BGP session. This is in contrast to the existing encapsulation type "srv6", which did not advertise prefixes without an SRv6 SID. The configuration allows for the specification of route policies that set the SRv6 allocation mode based on the destination prefix, enabling the coexistence of IP routes with or without SRv6 SID.

Benefits

The benefits of the co-existence of IP routes with or without SRv6 SID over an SRv6 core are numerous and significant for network operations as listed.

- **Enhanced Network Efficiency:** Allows seamless integration of SRv6 capabilities into existing network infrastructures, which can lead to more efficient routing and resource utilization.
- **Simplified Operations:** By supporting the coexistence of IP routes with or without SRv6 SID, network operators can manage their networks better without maintaining separate BGP peer sessions to support advertising both type of routes.
- **Future-Proofing the Network:** As networks evolve, the ability to support IP routes with or without SRv6 SID ensures that the network is prepared to enable customer to support use cases such as overlay and underlay route separation in a GRT table.
- **Cost Savings:** Reduce operations cost by streamlining network efficiency by optimizing BGP session management.
- **Flexibility and Scalability:** The feature provides the flexibility to apply SRv6 where it is needed while maintaining IP routing, allowing the network to scale efficiently.
- **Transition to New Technologies:** It facilitates a smoother transition to newer routing technologies like SRv6, which is designed to meet the demands of modern network applications and services.

These benefits contribute to a more robust, agile, and cost-effective network that can adapt to the changing needs of service providers and their customers.

Configure BGP Signaling over SRv6 Core

The purpose of this task is to enable SRv6 with BGP to support the co-existence of IP routes with or without SRv6 SID.

Follow these steps to configure BGP signaling over SRv6 Core.

Step 1 Execute the `encapsulation-type srv6 relax-sid` command on neighbor to configure the neighbor.

Summary of this configuration: Set up BGP to use SRv6 for IPv4 unicast routes, with specific rules for SID allocation based on the destination prefixes. It also configures a BGP neighbor and specifies how SRv6 encapsulation should be handled for that neighbor.

Example:

```
Router(config)# route-policy alloc-sid-policy
Router(config-rpl)# if destination in prefix-set-1 then
Router(config-rpl-if)# set srv6-alloc-mode per-vrf locator LOC2
Router(config-rpl-if)# else if destination is prefix-set-2 then
Router(config-rpl-else)# drop
Router(config-rpl-if)# else
Router(config-rpl-else)# set srv6-alloc-mode per-vrf
Router(config-rpl-else)# endif
Router(config-rpl)# end-policy
```

```
Router(config)# router bgp 2
Router(config-bgp)# address-family ipv4 unicast
Router(config-bgp-af)# segment-routing srv6
Router(config-bgp-af-srv6)# locator LOC1
```

```

Router(config-bgp-af-srv6)# alloc mode route-policy alloc-sid-policy
Router(config-bgp-af-srv6)# exit
Router(config-bgp-af)# exit
Router(config-bgp)# neighbor 12:100::1
Router(config-bgp-nbr)# address-family ipv4 unicast
Router(config-bgp-nbr-af)# encapsulation-type srv6 relax-sid
Router(config-bgp-nbr-af)# exit
Router(config-bgp-nbr)# exit

```

Step 2 Execute the **encapsulation-type srv6 relax-sid** command on the neighbor group to configure the neighbor-group.

Example:

```

Router(config-bgp)# neighbor-group srv6-core-relax
Router(config-bgp-nbr)# address-family ipv4 unicast
Router(config-bgp-nbr-af)# encapsulation-type srv6 relax-sid
Router(config-bgp-nbr-af)# exit
Router(config-bgp-nbr)# exit
Router(config-bgp)# neighbor 12:100::1
Router(config-bgp-nbr)# remote-as 1
Router(config-bgp-nbr)# use neighbor-group srv6-core-relax
Router(config-bgp-nbr)# exit

```

Step 3 Execute the **encapsulation-type srv6 relax-sid** command, on the address family group to configure the Address- Family Group .

Example:

```

Router(config-bgp)# af-group srv6-core-af address-family ipv4 unicast
Router(config-bgp-nbr-af)# encapsulation-type srv6 relax-sid
Router(config-bgp-nbr)# exit
Router(config-bgp-nbr)# address-family ipv4 unicast
Router(config-bgp-nbr-af)# neighbor 12:100::1
Router(config-bgp-nbr-af)# remote-as 1
Router(config-bgp-nbr-af)# address-family ipv4 unicast
Router(config-bgp-nbr-af)# use af-group srv6-core-af
Router(config-bgp-nbr)# exit

```

Step 4 Run the show commands to verify the encapsulation type is updated to SRv6 Relax-SID in all neighbor sessions. You can see that 192::4 has **encapsulation-type srv6 relax-sid** configured.

Example:

```

Router#show bgp neighbor 192::4
For Address Family: IPv4 Unicast
  BGP neighbor version 155
  Update group: 0.1 Filter-group: 0.3 No Refresh request being processed
Encapsulation type SRv6 Relax-SID
  NEXT_HOP is always this router
  Default information originate: default sent
  AF-dependent capabilities:
    Graceful Restart capability advertised
      Local restart time is 120, RIB purge time is 600 seconds
      Maximum stalepath time is 360 seconds
    Graceful Restart capability received
      Remote Restart time is 120 seconds
      Neighbor preserved the forwarding state during latest restart
  Extended Nexthop Encoding: advertised and received
  Route refresh request: received 0, sent 0
  3 accepted prefixes, 3 are bestpaths

```

```

...
Router#show bgp update-group neighbor 192::4
Update group for IPv4 Unicast, index 0.1:
Attributes:
  Neighbor sessions are IPv6
  Internal
  Common admin
  First neighbor AS: 100
  Send communities
  Send GSHUT community if originated
  Send extended communities
  Next-hop-self enabled
  4-byte AS capable
  Advertise routes with local-label via Unicast SAFI
  Send AIGP
  Encapsulation type SRv6 Relax-SID
  Send multicast attributes
  Extended Nexthop Encoding
  Minimum advertisement interval: 0 secs
Update group desynchronized: 0
Sub-groups merged: 0
Number of refresh subgroups: 0
Messages formatted: 7, replicated: 7
All neighbor are assigned to sub-group(s)
  Neighbors in sub-group: 0.3, Filter-Groups num:1
  Neighbors in filter-group: 0.3(RT num: 0)
  192::4

```

In the following example, 158.158.58.1/32 is without SRv6 SID but advertised to 192::4 and 157.157.57.1/32 with SRv6 SID, which is also advertised to 192::4. To allow IP route without SRv6 SID, you must include it in **prefix-set-2**.

Example:

```

Router#show bgp 158.158.58.1/32
BGP routing table entry for 158.158.58.1/32
Versions:
  Process          bRIB/RIB    SendTblVer
  Speaker          175        175
Last Modified: Dec 13 11:38:31.000 for 00:00:04
Paths: (2 available, best #1)
  Advertised IPv4 Unicast paths to update-groups (with more than one peer):
    0.2
  Advertised IPv4 Unicast paths to peers (in unique update groups):
    192::4
  Path #1: Received by speaker 0
  Advertised IPv4 Unicast paths to update-groups (with more than one peer):
    0.2
  Advertised IPv4 Unicast paths to peers (in unique update groups):
    192::4
60
  16.16.16.3 from 16.16.16.3 (16.16.16.3)
    Origin IGP, localpref 100, valid, external, best, group-best, multipath
    Received Path ID 0, Local Path ID 1, version 175
    Origin-AS validity: (disabled)
  Path #2: Received by speaker 0
  Not advertised to any peer
70
  17.17.17.3 from 17.17.17.3 (17.17.17.3)
    Origin IGP, localpref 100, valid, external, multipath
    Received Path ID 0, Local Path ID 0, version 0
    Origin-AS validity: (disabled)

```

Note that both Prefix 157 with SID and Prefix 158 without SID are advertised to neighbor 192::4.

```

Router#show bgp 157.157.57.1/32
BGP routing table entry for 157.157.57.1/32
Versions:
  Process          bRIB/RIB   SendTblVer
  Speaker          172       172
    SRv6-VPN SID: cafe:1:1:2:42::/128
    Format: base
Last Modified: Dec 13 11:38:31.000 for 00:02:09
Paths: (2 available, best #1)
  Advertised IPv4 Unicast paths to update-groups (with more than one peer):
    0.2
  Advertised IPv4 Unicast paths to peers (in unique update groups):
    192::4
  Path #1: Received by speaker 0
  Advertised IPv4 Unicast paths to update-groups (with more than one peer):
    0.2
  Advertised IPv4 Unicast paths to peers (in unique update groups):
    192::4
50
  15.15.15.3 from 15.15.15.3 (15.15.15.3)
    Origin IGP, localpref 100, valid, external, best, group-best, multipath
    Received Path ID 0, Local Path ID 1, version 172
    Origin-AS validity: (disabled)
  Path #2: Received by speaker 0
  Not advertised to any peer
60
  16.16.16.3 from 16.16.16.3 (16.16.16.3)
    Origin IGP, localpref 100, valid, external, multipath
    Received Path ID 0, Local Path ID 0, version 0
    Origin-AS validity: (disabled)

```

Step 5 Run these commands to view the flag details and path-elements, if needed.

Example:

```

Router#show bgp 157.157.57.1/32 detail
BGP routing table entry for 157.157.57.1/32
Versions:
  Process          bRIB/RIB   SendTblVer
  Speaker          172       172
    SRv6-VPN SID: cafe:1:1:2:42::/128
    Format: base
    Alloc Mode/Locator ID: per-vrf/2
    Flags: 0x00123201+0x61010000+0x00000000; multipath;
Last Modified: Dec 13 11:38:31.000 for 00:04:22
Paths: (2 available, best #1)
  Advertised IPv4 Unicast paths to update-groups (with more than one peer):
    0.2
  Advertised IPv4 Unicast paths to peers (in unique update groups):
    192::4
  Path #1: Received by speaker 0
  Flags: 0x3000000001050003+0x00, import: 0x020
  Advertised IPv4 Unicast paths to update-groups (with more than one peer):
    0.2
  Advertised IPv4 Unicast paths to peers (in unique update groups):
    192::4
50
  15.15.15.3 from 15.15.15.3 (15.15.15.3), if-handle 0x00000000
    Origin IGP, localpref 100, valid, external, best, group-best, multipath
    Received Path ID 0, Local Path ID 1, version 172
    Origin-AS validity: (disabled)
  Path #2: Received by speaker 0

```

```

Flags: 0x3000000000010003+0x00, import: 0x020
Not advertised to any peer
60
16.16.16.3 from 16.16.16.3 (16.16.16.3), if-handle 0x00000000
Origin IGP, localpref 100, valid, external, multipath
Received Path ID 0, Local Path ID 0, version 0
Origin-AS validity: (disabled)

Router#show bgp 158.158.58.1/32 path-elements
BGP routing table entry for 158.158.58.1/32
Versions:
Process          bRIB/RIB    SendTblVer
Speaker          175        175
Flags: 0x00123201+0x20010000+0x00000002; multipath;
Last Modified: Dec 13 11:38:31.000 for 00:05:50
Paths: (2 available, best #1)
Path count: 2
Path-elements: 1
Path ID: 1
Gateway metric 0, Version 175
Path: Nexthop 16.16.16.3, flags 0x3000000001050003
Neighbor 16.16.16.3, Received Path ID 0
Flags: 0x00000001
status: valid
path type: bestpath
add-path action:
Opaque: pelem=0x7f7948026d88
net=0x7f794d2fd968,          tblattr=0x22cc208 (ver 177)
path=0x7f794d2dd0c8, path-tblattr=0x22cc208 (ver 177)
nobestpath-tblattr=0x22cd6c0 (ver 0)
noaddpath-tblattr=0x22cd638 (ver 0)
bitfields=0x7f79481ce538 (val=0xc, size=1)
pe-bitfields=0x0 (val=0x0, size=0)
orr-bitfields=0x0 (val=0x0, size=0)
orr-ap-bitfields=0x0 (val=0x0, size=0)
net-next=0x0, tblattr-prev=0x7f7948026d18, tblattr-next=0x0
Radix: rn_parent=0x7f794d2fdd88, rn_left=0x7f794d2fdf98, rn_right=0x7f794d2fd758,
rn_version=180, rn_bit=6, rn_flags=0x0
Active Paths: (0 available)
Active Path-elements: 0

```

SRv6 Services: IPv4 L3VPN Active-Standby Redundancy using Port-Active Mode

The Segment Routing IPv6 (SRv6) Services: IPv4 L3VPN Active-Standby Redundancy using Port-Active Mode feature provides all-active per-port load balancing for multihoming. The forwarding of traffic is determined based on a specific interface rather than per-flow across multiple Provider Edge routers. This feature enables efficient load-balancing and provides faster convergence. In an active-standby scenario, the active PE router is detected using designated forwarder (DF) election by modulo calculation and the interface of the standby PE router brought down. For Modulo calculation, byte 10 of the Ethernet Segment Identifier (ESI) is used.

Usage Guidelines and Restrictions

- This feature can only be configured for bundle interfaces.

- When an EVPN Ethernet Segment (ES) is configured with port-active load-balancing mode, you cannot configure ACs of that bundle on bridge-domains with a configured EVPN instance (EVI). EVPN Layer 2 bridging service is not compatible with port-active load-balancing.

SRv6 Services for L3VPN Active-Standby Redundancy using Port-Active Mode: Operation

Under port-active operational mode, EVPN Ethernet Segment (ES) routes are exchanged across BGP for the routers servicing the multihomed ES. Each PE router then builds an ordered list of the IP addresses of all PEs connected to the ES, including itself, and assigns itself an ordinal for its position in the list. The ordinals are used with the modulo calculation to determine which PE will be the Designated Forwarder (DF) for a given ES. All non-DF PEs will take the respective bundles out of service.

In the case of link or port failure, the active DF PE withdraws its ES route. This re-triggers DF election for all PEs that service the ES and a new PE is elected as DF.

Configure SRv6 Services L3VPN Active-Standby Redundancy using Port-Active Mode

This section describes how you can configure SRv6 services L3VPN active-standby redundancy using port-active mode under an Ethernet Segment (ES).

Configuration Example

```

/* Configure Ethernet Link Bundles */
Router# configure
Router(config)# interface Bundle-Ether10
Router(config-if)# ipv4 address 10.0.0.2 255.255.255.0
Router(config-if)# ipv6 address 2001:DB8::1
Router(config-if)# lACP period short
Router(config-if)# mac-address 1.2.3
Router(config-if)# bundle wait-while 0
Router(config-if)# exit
Router(config)# interface GigabitEthernet 0/2/0/5
Router(config-if)# bundle id 14 mode active
Router(config-if)# commit

/* Configure load balancing. */
Router# configure
Router(config)# evpn
Router(config-evpn)# interface Bundle-Ether10
Router(config-evpn-ac)# ethernet-segment
Router(config-evpn-ac-es)# identifier type 0 11.11.11.11.11.11.11.14
Router(config-evpn-ac-es)# load-balancing-mode port-active
Router(config-evpn-ac-es)# commit
!
/* Configure address family session in BGP. */
Router# configure
Router(config)# router bgp 100
Router(config-bgp)# bgp router-id 192.168.0.2
Router(config-bgp)# address-family l2vpn evpn
Router(config-bgp)# neighbor 192.168.0.3
Router(config-bgp-nbr)# remote-as 200
Router(config-bgp-nbr)# update-source Loopback 0
Router(config-bgp-nbr)# address-family l2vpn evpn
Router(config-bgp-nbr)# commit

```

Running Configuration

```

interface Bundle-Ether14
  ipv4 address 14.0.0.2 255.255.255.0
  ipv6 address 14::2/64
  lacp period short
  mac-address 1.2.3
  bundle wait-while 0
!
interface GigabitEthernet0/2/0/5
  bundle id 14 mode active
!
evpn
  interface Bundle-Ether14
    ethernet-segment
      identifier type 0 11.11.11.11.11.11.11.14
      load-balancing-mode port-active
    !
  !
!
router bgp 100
  bgp router-id 192.168.0.2
  address-family l2vpn evpn
  !
  neighbor 192.168.0.3
    remote-as 100
    update-source Loopback0
    address-family l2vpn evpn
  !
!
!

```

Verification

Verify the SRv6 services L3VPN active-standby redundancy using port-active mode configuration.

```

/* Verify ethernet-segment details on active DF router */
Router# show evpn ethernet-segment interface Bundle-Ether14 detail
Ethernet Segment Id      Interface      Nexthops
-----
0011.1111.1111.1111.1114 BE14          192.168.0.2
                                192.168.0.3

    ES to BGP Gates      : Ready
    ES to L2FIB Gates    : Ready
    Main port            :
      Interface name     : Bundle-Ether14
      Interface MAC      : 0001.0002.0003
      IfHandle           : 0x000041d0
      State              : Up
      Redundancy         : Not Defined
    ESI type             : 0
      Value              : 11.1111.1111.1111.1114
    ES Import RT        : 1111.1111.1111 (from ESI)
    Source MAC          : 0000.0000.0000 (N/A)
    Topology            :
      Operational       : MH
      Configured        : Port-Active
    Service Carving     : Auto-selection
      Multicast         : Disabled
    Peering Details     :
      192.168.0.2 [MOD:P:00]
      192.168.0.3 [MOD:P:00]

```

```
Service Carving Results:
  Forwarders      : 0
  Permanent       : 0
  Elected        : 0
  Not Elected    : 0
MAC Flushing mode : STP-TCN
Peering timer    : 3 sec [not running]
Recovery timer   : 30 sec [not running]
Carving timer    : 0 sec [not running]
Local SHG label  : None
Remote SHG labels : 0
```

/* Verify bundle Ethernet configuration on active DF router */

Router# **show bundle bundle-ether 14**

```
Bundle-Ether14
  Status: Up
  Local links <active/standby/configured>: 1 / 0 / 1
  Local bandwidth <effective/available>: 1000000 (1000000) kbps
  MAC address (source): 0001.0002.0003 (Configured)
  Inter-chassis link: No
  Minimum active links / bandwidth: 1 / 1 kbps
  Maximum active links: 64
  Wait while timer: Off
  Load balancing:
    Link order signaling: Not configured
    Hash type: Default
    Locality threshold: None
  LACP: Operational
    Flap suppression timer: Off
    Cisco extensions: Disabled
    Non-revertive: Disabled
  mLACP: Not configured
  IPv4 BFD: Not configured
  IPv6 BFD: Not configured
```

Port	Device	State	Port ID	B/W, kbps
Gi0/2/0/5	Local	Active	0x8000, 0x0003	1000000
Link is Active				

/* Verify ethernet-segment details on standby DF router */

Router# **show evpn ethernet-segment interface bundle-ether 10 detail**

```
Router# show evpn ethernet-segment interface Bundle-Ether24 detail
Ethernet Segment Id      Interface      Nexthops
-----
0011.1111.1111.1111.1114 BE24          192.168.0.2
                               192.168.0.3

ES to BGP Gates      : Ready
ES to L2FIB Gates   : Ready
Main port            :
  Interface name     : Bundle-Ether24
  Interface MAC      : 0001.0002.0003
  IfHandle           : 0x000041b0
  State              : Standby
  Redundancy         : Not Defined
ESI type             : 0
  Value              : 11.1111.1111.1111.1114
ES Import RT        : 1111.1111.1111 (from ESI)
Source MAC          : 0000.0000.0000 (N/A)
```

```

Topology          :
  Operational     : MH
  Configured      : Port-Active
Service Carving   : Auto-selection
  Multicast       : Disabled
Peering Details   :
  192.168.0.2 [MOD:P:00]
  192.168.0.3 [MOD:P:00]

Service Carving Results:
  Forwarders      : 0
  Permanent       : 0
  Elected        : 0
  Not Elected    : 0
MAC Flushing mode : STP-TCN
Peering timer     : 3 sec [not running]
Recovery timer    : 30 sec [not running]
Carving timer     : 0 sec [not running]
Local SHG label   : None
Remote SHG labels : 0

/* Verify bundle configuration on standby DF router */
Router# show bundle bundle-ether 24

Bundle-Ether24
Status: LACP OOS (out of service)
Local links <active/standby/configured>: 0 / 1 / 1
Local bandwidth <effective/available>: 0 (0) kbps
MAC address (source): 0001.0002.0003 (Configured)
Inter-chassis link: No
Minimum active links / bandwidth: 1 / 1 kbps
Maximum active links: 64
Wait while timer: Off
Load balancing:
  Link order signaling: Not configured
  Hash type: Default
  Locality threshold: None
LACP: Operational
  Flap suppression timer: Off
  Cisco extensions: Disabled
  Non-revertive: Disabled
mLACP: Not configured
IPv4 BFD: Not configured
IPv6 BFD: Not configured

Port          Device          State          Port ID          B/W, kbps
-----
Gi0/0/0/4    Local          Standby       0x8000, 0x0002  1000000
Link is in standby due to bundle out of service state

```

SRv6 Services: IPv4 L3VPN Active-Active Redundancy

This feature provides active-active connectivity to a CE device in a L3VPN deployment. The CE device can be Layer-2 or Layer-3 device connecting to the redundant PEs over a single LACP LAG port.

Depending on the bundle hashing, an ARP or IPv6 Network Discovery (ND) packet can be sent to any of the redundant routers. As a result, not all entries will exist on a given PE. In order to provide complete awareness, Layer-3 local route learning is augmented with remote route-synchronization programming.

Route synchronization between service PEs is required in order to provide minimum interruption to unicast and multicast services after failure on a redundant service PE. The following EVPN route-types are used for Layer-3 route synchronization:

- EVPN route-type 2 for synchronizing ARP tables
- EVPN route-type 7/8 for synchronizing IGMP JOINS/LEAVES

In a Layer-3 CE scenario, the router that connects to the redundant PEs may establish an IGP adjacency on the bundle port. In this case, the adjacency will be formed to one of the redundant PEs, and IGP customer routes will only be present on that PE. To synchronize Layer-3 customer subnet routes (IP Prefixes), the EVPN route-type 5 is used to carry the ESI and ETAG as well as the gateway address (prefix next-hop address).



Note Gratuitous ARP (GARP) or IPv6 Network Advertisement (NA) replay is not needed for CEs connected to the redundant PEs over a single LAG port.

The below configuration enables Layer-3 route synchronization for routes learned on the Ethernet-segment sub-interfaces.

```
evpn
 route-sync vrf default
 !
vrf RED
 evi route-sync 10
 !
vrf BLUE
 evi route-sync 20
 !
```



Note EVPN does not support untagged interfaces.

SRv6 Services: EVPN VPWS — All-Active Multi-Homing

Table 9: Feature History Table

Feature Name	Release	Description
SRv6 Services: EVPN VPWS — All-Active Multi-Homing (SRv6 Micro SID)	Release 7.3.2	<p>This feature provides an ELINE (P2P) service with all-active multihoming capability over an SRv6 network.</p> <p>All-Active Multi-Homing enables an operator to connect a customer edge (CE) device to two or more provider edge (PE) devices to provide load balancing and redundant connectivity. With All-Active Multi-Homing, all the PEs can forward traffic to and from the multi-homed device.</p>

EVPN VPWS All-Active Multi-Homing over SRv6 provides an ELINE (P2P) service with all-active multihoming capability over an SRv6 network.

All-Active Multi-Homing enables an operator to connect a customer edge (CE) device to two or more provider edge (PE) devices to provide load balancing and redundant connectivity. With All-Active Multi-Homing, all the PEs can forward traffic to and from the multi-homed device.



Note For information about EVPN VPWS, refer to the "EVPN Virtual Private Wire Service (VPWS)" chapter in the *L2VPN and Ethernet Services Configuration Guide for Cisco NCS 5500 Series Routers*.

Configuring EVPN VPWS over SRv6



Note Complete the steps in [Configuring SRv6, on page 17](#) before performing these steps.

An SRv6 Locator for an EVPN VPWS service can be configured at 3 different levels independently:

- `global_locator` is the default locator for all EVPN-VPWS services
- `evi_locator` is applied to all EVPN-VPWS services for the specific EVI
- `evi_service_locator` is applied to an individual EVI service

When locators are configured at different levels at the same time, the following priority is implemented:

1. `evi_service_locator`
2. `evi_locator`
3. `global_locator`

This example shows how to configure an EVPN VPWS over SRv6 using a global locator for EVPN:

```
evpn
  segment-routing srv6
    locator sample_global_loc

l2vpn
  xconnect group sample_xcg
  p2p sample-vpws-12001-2002
    interface Bundle-Ether12001.2002
    neighbor evpn evi 12001 service 2002 segment-routing srv6
```

This example shows how to configure EVPN VPWS over SRv6 using specific EVI locator:

```
evpn
  evi 11001 segment-routing srv6
    locator sample_evi_loc

l2vpn
  xconnect group sample_xcg
  p2p sample-vpws-11001-2002
    interface Bundle-Ether11001.2002
    neighbor evpn evi 11001 service 2002 segment-routing srv6
```

This example shows how to configure an EVPN VPWS over SRv6 using a locator for an individual EVI service:

```
l2vpn
  xconnect group sample_xcg
  p2p sample-vpws-11001-2001
    interface Bundle-Ether11001.2001
    neighbor evpn evi 11001 service 2001 segment-routing srv6
    locator sample_evi_service_loc
```

Verification

Router# **show segment-routing srv6 locator**

Name	ID	Algo	Prefix	Status	Flags
sample_evi_loc	1	128	2001:0:8::/48	Up	U
sample_global_loc	2	0	2001:0:1::/48	Up	U

Router# **show segment-routing srv6 sid**

*** Locator: 'sample_evi_loc' ***

SID	State	RW	Behavior	Context	Owner
2001:0:8::	InUse	Y	uN (PSP/USD)	'default':8	sidmgr
2001:0:8:e000::	InUse	Y	uDX2	11001:2002	l2vpn_srv6
2001:0:8:e002::	InUse	Y	uA (PSP/USD)	[BE11, Link-Local]:128	isis-20
2001:0:8:e004::	InUse	Y	uA (PSP/USD)	[BE60, Link-Local]:128	isis-20
2001:0:8:e006::	InUse	Y	uA (PSP/USD)	[BE30, Link-Local]:128	isis-20

```

*** Locator: 'sample_global_loc' ***

2001:0:1::          uN (PSP/USD)      'default':1          sidmgr
    InUse Y
2001:0:1:e001::    uDX2              12001:2002          12vpn_srv6
    InUse Y
2001:0:1:e003::    uA (PSP/USD)      [BE11, Link-Local]:0  isis-20
    InUse Y
2001:0:1:e005::    uA (PSP/USD)      [BE60, Link-Local]:0  isis-20
    InUse Y
2001:0:1:e007::    uA (PSP/USD)      [BE30, Link-Local]:0  isis-20
    InUse Y

```

```
Router# show evpn segment-routing srv6 detail
```

```

Configured default locator: sample_global_loc
EVIIs with unknown locator config: 0
VPWS with unknown locator config: 0

```

Locator name	Prefix	OOR	Service count	SID count
sample_evi_loc	2001:0:8::/48	False	1	1
Configured on EVIs <evi>: 11001				
sample_global_loc	2001:0:1::/48	False	1	1
Default locator				

```
Router# show l2vpn xconnect group sample_xcg detail
```

```
Thu Sep 2 14:39:22.575 UTC
```

```
Group sample_xcg, XC sample-vpws-11001-2002, state is up; Interworking none
```

```

AC: Bundle-Ether11001.2002, state is up
Type VLAN; Num Ranges: 1
Rewrite Tags: []
VLAN ranges: [2002, 2002]
MTU 1504; XC ID 0xc0002ee8; interworking none
Statistics:
  packets: received 0, sent 0
  bytes: received 0, sent 0
  drops: illegal VLAN 0, illegal length 0

```

```
EVPN: neighbor ::ffff:10.0.0.1, PW ID: evi 11001, ac-id 2002, state is up ( established )
```

```

XC ID 0xa0001f47
Encapsulation SRv6
Encap type Ethernet
Ignore MTU mismatch: Enabled
Transmit MTU zero: Disabled
Reachability: Up

```

SRv6	Local	Remote
uDX2	2001:0:8:e000::	2001:0:3:e000::
AC ID	2002	2002
MTU	1518	1518
Locator	sample_evi_loc	N/A
Locator Resolved	Yes	N/A
SRv6 Headend	H.Encaps.L2.Red	N/A

```

Statistics:
  packets: received 0, sent 0
  bytes: received 0, sent 0

```

```

Group sample_xcg, XC sample-vpws-12001-2002, state is up; Interworking none
AC: Bundle-Ether12001.2002, state is up
  Type VLAN; Num Ranges: 1
  Rewrite Tags: []
  VLAN ranges: [2002, 2002]
  MTU 1504; XC ID 0xc0002eea; interworking none
  Statistics:
    packets: received 0, sent 0
    bytes: received 0, sent 0
    drops: illegal VLAN 0, illegal length 0
EVPN: neighbor ::ffff:10.0.0.2, PW ID: evi 12001, ac-id 2002, state is up ( established
)
  XC ID 0xa0001f49
  Encapsulation SRv6
  Encap type Ethernet
  Ignore MTU mismatch: Enabled
  Transmit MTU zero: Disabled
  Reachability: Up

      SRv6                Local                Remote
      -----
uDX2          2001:0:1:e001::          2001:0:2:e001::
AC ID         2002                    2002
MTU           1518                    1518
Locator       sample_global_loc       N/A
Locator Resolved Yes                    N/A
SRv6 Headend H.Encaps.L2.Red        N/A
Statistics:
  packets: received 0, sent 0
  bytes: received 0, sent 0
    
```

SRv6-Services: EVPN ELAN Layer 2 Gateway With Automated Steering To Flexible Algorithm Paths

Table 10: Feature History Table

Feature Name	Release Information	Feature Description
SRv6-Services: EVPN ELAN Layer 2 Gateway With Automated Steering To Flexible Algorithm Paths	Release 7.5.2	<p>This feature builds upon EVPN BGP signaling to provide Emulated Local Area Network (ELAN) multipoint-to-multipoint Ethernet services over an SRv6-based network.</p> <p>You can enable automated steering of EVPN ELAN traffic into the path associated with a best-effort or Flex- Algorithm locator.</p> <p>This feature combines the benefits of EVPN ELAN service and SRv6 Micro-SIDs.</p> <p>For this feature, the segment-routing srv6 option was added to the evi command:</p> <p>evi (bridge-domain)</p>

You can transport EVPN ELAN bridged unicast and broadcast, unknown unicast, and multicast (BUM) traffic over an SRv6 network in the Micro-SID format. Relevant SRv6 headend and endpoint definitions are noted below:

- **H.Encaps.L2.Red**: This headend router operation involves reduced encapsulation of Layer 2 or Ether frames using an SRv6 Policy.
- **uDT2U**: This endpoint router operation involves traffic decapsulation and unicast MAC L2 table lookup. This is used for the EVPN bridging unicast traffic use case.
- **uDT2M**: This endpoint router operation involves traffic decapsulation and L2 table flooding. This is used for the EVPN bridging BUM traffic with ESI filtering use case.



Note For more information on SRv6 headend and endpoint behaviors, refer to Segment Routing over IPv6 Overview.

The following topology is used to explain this feature.

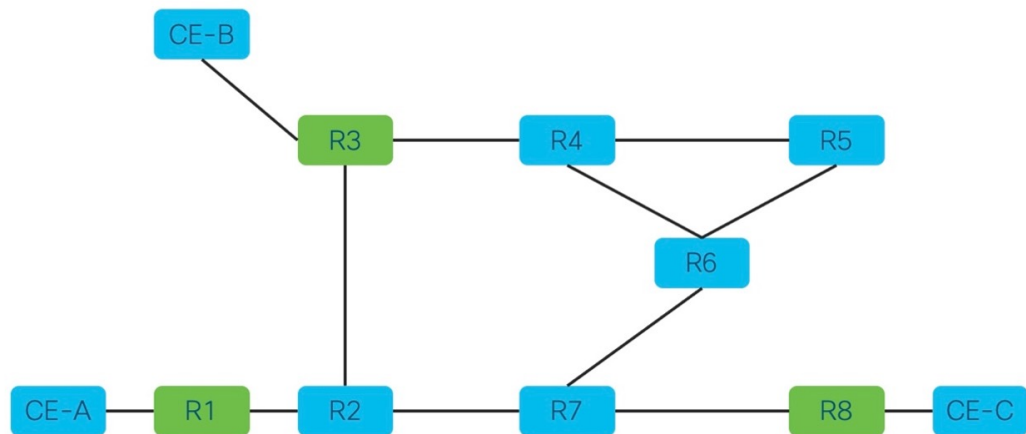

Topology pointers:

- Customer edge (CE) devices send traffic between each other over the SRv6 network. The CE devices are CE-A, CE-B, and CE-C.
- The SRv6 network devices transport customer traffic, and they are R1, R2 .. till R8.
- The provider edge (PE) devices, R1, R3 and R8, are displayed in green. The SRv6 EVPN configurations must be enabled on the PE devices since they participate in the EVPN EVI.

This is a high-level overview of the traffic flow from CE-A to CE-C:

1. CE-A sets the source and destination addresses of the L2 frame and sends it to the connected PE device, R1.
2. R1 looks up the destination MAC address in the frame. Based on its forwarding table, R1 performs an H.Encaps.L2.Red operation and adds the destination DT2U SRv6 SID (say, fccc:ccc1:a1:e000::) to the packet.
3. From R1, traffic is sent over the SRv6 network to destination PE device R8.
4. When R8 receives the traffic, it performs the uDT2U function - It decapsulates the packet, performs a destination MAC address lookup in its forwarding table, and sends the frame through the local interface to CE-C.

Guidelines and Limitations

- For transporting BUM traffic, the BGP Route Reflector device should have an IOS XR release version 7.5.2 or later.

Configure SRv6 EVPN Bridging

Enable the following configurations on the PE routers R1, R3 and R8 since they participate in the EVPN EVI.



Note Complete the steps in Segment Routing over IPv6 Overview before performing these steps.

Associate SRv6 with EVPN

```
Router# configure terminal
Router(config)# evpn
```

Enable SRv6 under the EVPN mode and associate a global locator (**sample**, in this case) with EVPN.

```
Router(config-evpn)# segment-routing srv6
Router(config-evpn-srv6)# locator sample
Router(config-evpn-srv6)# exit
```

Associate an EVI-specific locator (**sample_evi_loc**) with EVI 1.

```
Router(config-evpn)# evi 1 segment-routing srv6
Router(config-evpn-instance)# locator sample_evi_loc
Router(config-evpn-instance)# commit
```

Associate SRv6 with L2VPN

Associate the sub-interface to the bridge domain:

```
Router(config)# l2vpn
Router(config-l2vpn)# bridge group bg1
Router(config-l2vpn-bg)# bridge-domain bd1
Router(config-l2vpn-bg-bd)# interface Hu0/0/0/0.1
Router(config-l2vpn-bg-bd-ac)# exit
```

Enable the **evi 1 segment-routing srv6** command under L2VPN bridge domain **bd1**.

```
Router(config-l2vpn-bg-bd)# evi 1 segment-routing srv6
Router(config-l2vpn-bg-bd-evi-srv6)# commit
```

Verification

In this sample output, SRv6 EVPN ELAN traffic unicast and multicast SID information is displayed.

```
Router# show evpn evi vpn-id 1 detail
```

VPN-ID	Encap	Bridge Domain	Type
1	SRv6	bd1	EVPN
..			
Stitching: Regular			
Unicast SID: fccc:ccc1:a1:e000::			
Multicast SID: fccc:ccc1:a1:e001::			
..			

In this sample output, EVI 1 details, including the corresponding SID and EVPN MAC address details are displayed.

```
Router# show evpn evi vpn-id 1 mac
```

VPN-ID	Encap	MAC address	IP address	Nexthop	Label	SID
1	SRv6	0010.3000.01d0	::	Hu0/0/0/0.1	0	fccc:ccc1:a1:e000::

In this sample output, for the specified EVI and EVPN MAC address, SRv6 EVPN ELAN traffic details are displayed.

```
Router# show evpn evi vpn-id 1 mac 0010.3000.01d0 detail
```

VPN-ID	Encap	MAC	IP	Nexthop	Label	SID
--------	-------	-----	----	---------	-------	-----

```

-----
address          address
-----
1   SRv6  ee03.0500.0130  ::  192.168.0.3  IMP-NULL fccc:ccc1:a3:e000::

Ethernet Tag      : 0
Multi-paths Resolved : True
Multi-paths Internal label : None
Local Static      : No
Remote Static     : Yes
Local Ethernet Segment : N/A
Remote Ethernet Segment : 0100.0205.acce.5500.0500
Local Sequence Number : N/A
Remote Sequence Number : 0
Local Encapsulation : N/A
Remote Encapsulation : SRv6
Local E-Tree      : Root
Remote E-Tree     : Root
Remote matching E-Tree RT : No
Local AC-ID       : 0x0
Remote AC-ID      : 0x13
    
```

In this sample output, for the specified EVI, multicast SID details are displayed.

Router# **show evpn evi vpn-id 1 inclusive-multicast detail**

```

VPN-ID      Encap      EtherTag      Originating IP
----      -
1           SRv6      0             192.168.0.1
..
      TEPid: 0xffffffff
      PMSI Type: 6
      Nexthop: ::
      SR-TE Info: N/A
      SID: fccc:ccc1:a1:e001::
      Source: Local
      E-Tree: Root
..
    
```

In this sample output, for the specified MAC address, bridge domain information is displayed.

Router# **show l2route evpn mac all | i ee03.0500.0130**

```

Topo ID      Mac Address      Producer      Next Hop(s)
-----      -
1           ee03.0500.0130  L2VPN        ::ffff:10.0.0.10/IID/V6, N/A
    
```

In this sample output, SRv6 network locator and corresponding SID information are displayed.

uDT2U and **uDT2M** refer to SRv6 network endpoint operations. **uDT2U** indicates SRv6 traffic decapsulation, wherein EVPN bridged unicast traffic is forwarded out of the SR network. **uDT2M** indicates SRv6 traffic decapsulation, wherein EVPN bridged multicast traffic is forwarded out of the SR network.

Router# **show segment-routing srv6 sid**

```

*** Locator: 'sample_evi_loc' ***

SID          Behavior      Context      Owner      State      RW
---          -
fccc:ccc1:a1::  uN(PSP/USD)  'default':161  sidmgr      InUse      Y
fccc:ccc1:a1:e000::  uDT2U      7:0          l2vpn_srv6  InUse      Y
fccc:ccc1:a1:e001::  uDT2M      7:0          l2vpn_srv6  InUse      Y
    
```

In this sample output, CEF information is displayed, including SRv6 network endpoint details. **uDT2U** is an SRv6 network endpoint operation wherein SRv6 traffic is decapsulated and EVPN bridged unicast traffic is forwarded out of the SR network.

```

Router# show cef ipv6 fccc:cccl:a1:e000:: detail

fccc:cccl:a1:e000::, version 14, SRv6 Endpoint uDT2U, internal 0x1000001
0x0 (ptr 0x8ba26050) [1], 0x400 (0x8bbf7b58), 0x0 (0x92396138)

Prefix Len 64, traffic index 0, precedence n/a, priority 0
gateway array (0x8ba33e90) reference count 4, flags 0x0, source rib (7), 0 backups
[5 type 3 flags 0x8401 (0x8baf8ca8) ext 0x0 (0x0)]

LW-LDI[type=3, refc=1, ptr=0x8bbf7b58, sh-ldi=0x8baf8ca8]
gateway array update type-time 1 Sep 8 11:46:51.242

LDI Update time Sep 8 11:46:51.303
LW-LDI-TS Sep 8 11:46:51.380
via ::/128, 0 dependencies, weight 0, class 0 [flags 0x0]
path-idx 0 NHID 0x0 [0x8afdf120 0x0]
next hop ::/128
XConnect ID: 0x80000003
Bridge ID: 0x1
Shg ID: 0x1

Load distribution: 0 (refcount 5)

Hash OK Interface Address
0 Y recursive Lookup in table

```

In the following examples, SRv6 EVPN ELAN traffic-related IID information is displayed.

```

Router# show evpn internal-id vpn-id 3001 detail

VPN-ID Encap Ethernet Segment Id EtherTag Internal ID
-----
1 SRv6 0001.0001.0001.1501.0015 0 ::ffff:10.0.0.4

Summary pathlist:

0x05000002 (P) 192.168.0.3 fccc:cccl:a3:e000::
0x05000002 (P) 192.168.0.3 fccc:cccl:a4:e000::

Router# show cef vrf **iid ipv6 ::ffff:10.0.0.4

::ffff:10.0.0.4/128, version 39, SRv6 Headend, IID (EVPN-MH), internal 0x1000001 0x0 (ptr
0x8ba21798) [3], 0x0 (0x0), 0x0 (0x923967b0)
Updated Sep 8 18:01:06.495
Prefix Len 128, traffic index 0, precedence n/a, priority 0
gateway array (0x8ba36018) reference count 1, flags 0x2010, source rib (7), 0 backups
[1 type 3 flags 0x48441 (0x8baf9a28) ext 0x0 (0x0)]
LW-LDI[type=0, refc=0, ptr=0x0, sh-ldi=0x0]
gateway array update type-time 1 Sep 8 18:01:06.495
LDI Update time Sep 8 18:01:06.495

Level 1 - Load distribution: 0
[0] via fccc:cccl:a3::/128, recursive

via fccc:cccl:a3:e000::/128, 10 dependencies, recursive [flags 0x0]
path-idx 0 NHID 0x0 [0x8ba24e78 0x0]
next hop VRF - 'default', table - 0xe0800000
next hop fccc:cccl:a3::/128 via fccc:cccl:a3::/48
SRv6 H.Encaps.L2.Red SID-list { fccc:cccl:a3:e000::}

Load distribution: 0 (refcount 1)

Hash OK Interface Address
0 Y Hu0/0/0/0 remote

```



```

via fccc:cccl:a4::/128, 10 dependencies, recursive [flags 0x100]
path-idx 0 NHID 0x0 [0x8ba24e78 0x0]
next hop VRF - 'default', table - 0xe0800000
next hop fccc:cccl:a4::/128 via fccc:cccl:a4::/48
SRv6 H.Encaps.L2.Red SID-list {fccc:cccl:a4:e000::}
    
```

In this sample output, SRv6 EVPN ELAN traffic-related IID information is displayed.

Router# **show rib ipv6 iid**

IID	Prefix	Context	Owner	State	RW
-----	-----	-----	-----	-----	--
0xa000001	::ffff:10.0.0.1	[EVPN-ELAN:evi=7:esi=8300.fccc.cccl.00a4.0000:nh=fccc:cccl:a4::eth_tag=0:type=0:encap=255:opaque=0]	l2vpn_iid	InUse	Y
0xa000002	::ffff:10.0.0.2	[EVPN-ELAN:evi=8:esi=8300.fccc.cccl.00a4.0000:nh=fccc:cccl:a4::eth_tag=0:type=0:encap=255:opaque=0]	l2vpn_iid	InUse	Y
0xa000003	::ffff:10.0.0.3	[EVPN-ELAN:evi=9:esi=8300.fccc.cccl.00a4.0000:nh=fccc:cccl:a4::eth_tag=0:type=0:encap=255:opaque=0]	l2vpn_iid	InUse	Y

SRv6 ESI Filtering

Table 11: Feature History Table

Feature Name	Release Information	Feature Description
SRv6 ESI Filtering	Release 7.11.1	<p>Introduced in this release on: NCS 5500 fixed port routers; NCS 5500 modular routers (NCS 5500 line cards)</p> <p>Split Horizon Group (SHG) labels and Ethernet Segment Identifier (ESI) filtering functionalities exist on MPLS underlay networks.</p> <p>This feature introduces ESI filtering functionality to SRv6 underlay networks, using the End.DT2M SRv6 endpoint behavior. This behavior uses the "Arg.FE2" argument for SRv6, which is similar to the SHG label for MPLS.</p> <p>This feature allows nodes to identify BUM traffic based on the advertised ESI and prevent a loop by avoiding re-broadcasting the same traffic back towards the access node.</p> <p>This functionality is enabled by default.</p>

Consider the below network topology where CE1 is attached to PE1 and PE2.

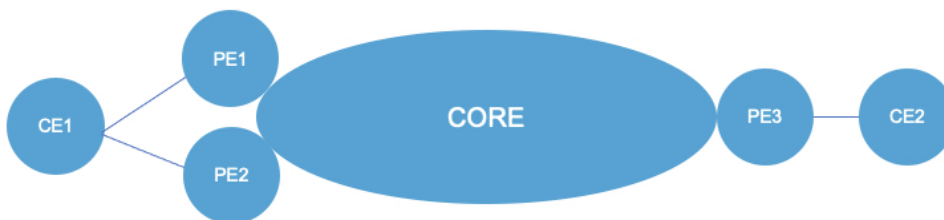

When broadcast, unknown unicast, and multicast (BUM) traffic is received by PE1 from CE1, PE1 floods this traffic on the core network. This results in a copy of the BUM traffic being sent to PE2. PE2 in turn floods it to the core and access network, and the BUM traffic would be received at CE1. This is undesirable as we are flooding the same traffic to the source from which it originated, thus causing a loop.

SRv6 ESI Filtering

A unique 16-bit ID is generated by all nodes in an Ethernet Segment and is transmitted to all nodes in the same EVPN instance via ES/EAD Route Type 1 NLRI (see "[EVPN Route Types](#)" for description of Route Type 1: Ethernet Auto-Discovery (AD) Route). This unique label functions in a similar way as the Split

Horizon group label (SHG label). Ethernet Segment Identifier (ESI) filtering is the mechanism that controls which nodes to re-broadcast BUM traffic.



Note For more information, see “[Split Horizon Groups](#)” in the *L2VPN and Ethernet Services Configuration Guide*.

When PE1 receives BUM traffic from an attachment circuit (AC), it floods the traffic to all nodes in its core network, where PE2 is also member node. The traffic flooded to PE2 is sent with its previously advertised ID. When PE2 decodes the packet and examines the label, it recognizes this to be the label that it had generated. In this mechanism, PE2 will not flood the BUM traffic back towards the access. PE2 has successfully prevented a loop by avoiding re-broadcasting the same traffic back towards the source (CE1).

This feature introduces ESI filtering to SRv6 underlay networks, using the End.DT2M SRv6 endpoint behavior. This behavior uses the "Arg.FE2" argument, as defined in [IETF RFC 8986 SRv6 Network Programming](#) and [IETF draft SRv6 Argument Signaling for BGP Services](#). This argument provides a local mapping to ESI for split-horizon filtering of the received traffic to exclude a specific outgoing L2 interface (OIF), or a set of OIFs, from L2 table T flooding. The allocation of the argument values is local to the SR Segment Endpoint Node instantiating this behavior, and the signaling of the argument to other nodes for the EVPN functionality occurs via the control plane.

Usage Guidelines and Limitations

This feature is supported on NCS 5500 Series routers.

This feature is not supported on NCS 5700 Series routers or NC57 line cards.

Verification

The output of the **show evpn ethernet-segment interface** *interface-name* now displays both the SHG label information for MPLS EVPN instances (EVIs) and the Arg.FE2 information for SRv6 EVIs:

```
Router# show evpn ethernet-segment interface Bundle-Ether 1

Ethernet Segment Id      Interface      Nexthops
-----
0011.1111.1111.1111.1114 BE1            192.168.0.2
. . .                . . .                192.168.0.3

Peering timer : 3 sec [not running]
Recovery timer : 30 sec [not running]
Local SHG label : 34251
Remote SHG labels : 2
  38216 : nexthop 192.168.0.1
  Arg.FE2 1:16 : nexthop 192.168.0.2
```

SRv6 Services: L3 EVPN

EVPN Route Type 5 (RT5) is used for the advertisement of EVPN routes using IP prefixes (refer to [IETF RFC 9136 - IP Prefix Advertisement in Ethernet VPN \(EVPN\)](#)) to provide end-to-end L3 connectivity

This feature adds support for carrying L3VPN routes in L2VPN EVPN EVPN RT5 address family instead of VPNv4 unicast and/or VPNv6 unicast address-family across SRv6 core (EVPN over SRv6 underlay).

Usage Guidelines and Limitations

BGP does not support dual VPNv4/v6 address family and EVPN RT5 address family on the same BGP session. For the route reflector (RR) to receive both Type-5 EVPN route and VPNv4/v6 address family, we recommend that you configure two pairs of loopback interfaces and configure two BGP loopback sessions between the RR and the PE: one session for VPNv4/v6 address family and one session for EVPN address family.

BGP sends all VRF routes via either VPNv4/v6 or EVPN address family. We recommend that you mark the VRF route via export route-policy and use neighbor out policy to either drop or pass the route for an address family to achieve the same net effect.

The following behaviors are supported:

- IPv4, IPv6, and IPv4/IPv6 (dual stack) L3 EVPN over SRv6
- uDT4
- uDT6
- uDT46
- Automated Steering to Flex-Algo (BGP per-VRF locator Flex-Algo (per-prefix))
- Automated Steering to SRv6 Policy (ODN/AS)

Configuring SRv6-based L3 EVPN

To enable SRv6-based L3 EVPN, you must enable SRv6 under BGP, specify the locator, and configure the SID allocation mode. The assignment of the locator can be done in multiple ways under the **router bgp** configuration. See [SRv6 Locator Inheritance Rules](#).

Figure 9: Configuration Example: Dual Stack L3 EVPN over SRv6

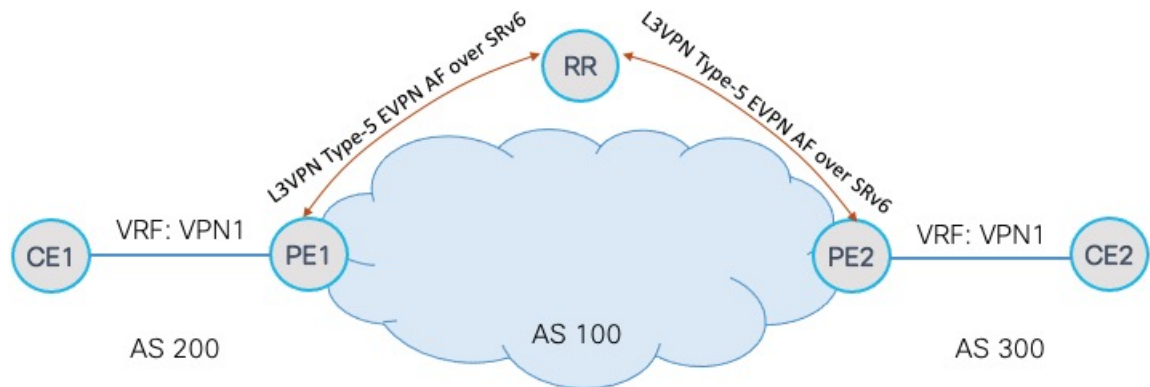

Configure the VRF (Dual-Stack IPv4/IPv6)

```
Router(config)# vrf VPN1
Router(config-vrf)# address-family ipv4 unicast
Router(config-vrf-af)# import route-target
Router(config-vrf-import-rt)# 1:1
Router(config-vrf-import-rt)# exit
Router(config-vrf-af)# export route-target
Router(config-vrf-export-rt)# 1:1
Router(config-vrf-export-rt)# exit
Router(config-vrf)# address-family ipv6 unicast
```

```

Router(config-vrf-af)# import route-target
Router(config-vrf-import-rt)# 1:1
Router(config-vrf-import-rt)# exit
Router(config-vrf-af)# export route-target
Router(config-vrf-export-rt)# 1:1
Router(config-vrf-export-rt)# exit
Router(config-vrf-af)#

```

Configure the SRv6 Locator for an Individual VRF, with Per-VRF Label Allocation Mode

```

Router(config)# router bgp 100
Router(config-bgp)# address-family vpnv4 unicast
Router(config-bgp-af)# additional-paths receive
Router(config-bgp-af)# additional-paths send
Router(config-bgp-af)# additional-paths selection route-policy add-path
Router(config-bgp-af)# exit
Router(config-bgp)# address-family vpnv6 unicast
Router(config-bgp-af)# additional-paths receive
Router(config-bgp-af)# additional-paths send
Router(config-bgp-af)# additional-paths selection route-policy add-path
Router(config-bgp-af)# exit
Router(config-bgp)# address-family l2vpn evpn
Router(config-bgp-af)# additional-paths receive
Router(config-bgp-af)# additional-paths send
Router(config-bgp-af)# additional-paths selection route-policy add-path
Router(config-bgp-af)# exit

```

```

Router(config-bgp)# neighbor 1111::1
Router(config-bgp-nbr)# remote-as 100
Router(config-bgp-nbr)# address-family l2vpn evpn
Router(config-bgp-nbr-af)# advertise vpnv4 unicast
Router(config-bgp-nbr-af)# advertise vpnv6 unicast
Router(config-bgp-nbr-af)# exit
Router(config-bgp-nbr)# exit

```

```

Router(config-bgp)# vrf VPN1
Router(config-bgp-vrf)# rd 100:1
Router(config-bgp-vrf)# address-family ipv4 unicast
Router(config-bgp-vrf-af)# segment-routing srv6
Router(config-bgp-vrf-af-srv6)# locator LOC1
Router(config-bgp-vrf-af-srv6)# alloc mode per-vrf
Router(config-bgp-vrf-af-srv6)# exit
Router(config-bgp-vrf-af)# exit
Router(config-bgp-vrf)# address-family ipv6 unicast
Router(config-bgp-vrf-af)# segment-routing srv6
Router(config-bgp-vrf-af-srv6)# locator LOC1
Router(config-bgp-vrf-af-srv6)# alloc mode per-vrf
Router(config-bgp-vrf-af-srv6)# exit
Router(config-bgp-vrf-af)# exit

```

```

Router(config-bgp-vrf)# neighbor 1.1.1.1
Router(config-bgp-vrf-nbr)# remote-as 200
Router(config-bgp-vrf-nbr)# address-family ipv4 unicast
Router(config-bgp-vrf-nbr-af)# exit
Router(config-bgp-vrf-nbr)# exit
Router(config-bgp-vrf)# neighbor 3333::3
Router(config-bgp-vrf-nbr)# remote-as 200
Router(config-bgp-vrf-nbr)# address-family ipv6 unicast

```

Running Configuration

```

vrf VPN1
  address-family ipv4 unicast
    import route-target
      1:1
    !
  export route-target
    1:1
  !
!
address-family ipv6 unicast
  import route-target
    1:1
  !
  export route-target
    1:1
  !
!
router bgp 100
  address-family vpn4 unicast
    additional-paths receive
    additional-paths send
    additional-paths selection route-policy add-path
  !
  address-family vpn6 unicast
    additional-paths receive
    additional-paths send
    additional-paths selection route-policy add-path
  !
  address-family l2vpn evpn
    additional-paths receive
    additional-paths send
    additional-paths selection route-policy add-path
  !
  neighbor 1111::1
    remote-as 100
    address-family l2vpn evpn
      advertise vpn4 unicast
      advertise vpn6 unicast
    !
  !
vrf VPN1
  rd 100:1
  address-family ipv4 unicast
    segment-routing srv6
    locator LOC1
    alloc mode per-vrf
  !
  !
  address-family ipv6 unicast
    segment-routing srv6
    locator LOC1
    alloc mode per-vrf
  !
  !
  neighbor 1.1.1.1
    remote-as 200
    address-family ipv4 unicast
  !
  !
  neighbor 3333::3
    remote-as 200

```

```

address-family ipv6 unicast
!
!
!
!

```

SRv6 Services: L2 and L3 Services with Remote SIDs from W-LIB

Table 12: Feature History Table

Feature Name	Release Information	Feature Description
SRv6 Services: L2 and L3 Services with Remote SIDs from Wide Local ID Block	Release 7.9.1	<p>This feature enables an SRv6 headend node to receive and install remote SIDs with Wide (32-bit) functions (Remote W-LIB).</p> <p>The Remote W-LIB is supported for Layer 3 (VPN/BGP global) and Layer 2 EVPN services (ELINE/ELAN).</p> <p>This capability is enabled by default.</p>

This capability is enabled by default; there is no CLI to configure this capability at the ingress PE.

An SRv6 Service SID is used to identify a specific service function. This Service SID inserted into the packet header by the source node is used to steer the packet along a specific path that includes the service function.

The Service SID signaled by transposing a variable part of the SRv6 SID value (function, argument, or both) and carrying them in the existing label fields to achieve more efficient compression of those service prefix NLRIs in BGP update messages. The SRv6 SID Structure Sub-Sub-TLV (SSTLV) contains appropriate length fields when the SRv6 Service SID is signaled in split parts to enable the receiver to put together the SID accurately.

The Transposition Offset indicates the bit position. The Transposition Length indicates the number of bits that are being taken out of the SRv6 SID value and put into high order bits of label field.

For example, a remote W-LIB uSID **fcbb:bb00:0200:fff0:0001::** with a SRv6 SID SSTLV of **BL=32; NL=16; FL=32; AL=0, TPOS len/offset=16/64** is defined as follows:

- Block length (BL) of 32 bits = fcbb:bb00
- Node length (NL) of 16 bits = 0200
- Function length (FL) of 32 bits = fff0:0001
- Argument length (AL) of 0
- Transposition length (TPOS len) of 16 bits = 0001
- Transposition offset (TPOS offset) of 64 bits = fcbb:bb00:0200:fff0:

This results in a SID value of **fcbb:bb00:0200:fff0::** and Label value of **0x0001**.

Example

The following example shows output of a BGP route table for a VPNv4 prefix learned from three egress PEs:

- BGP Path 1 from next-hop 7::1 and a 32-bit uDT4 function (0xfff0 4002) allocated from W-LIB

- BGP Path 2 from next-hop 9::1 and a 16-bit uDT4 function (0x4002) allocated from LIB
- BGP Path 3 from next-hop 8::1 and a 16-bit uDT4 function (0x4002) allocated from LIB

Note the following fields in the output:

- Function length of 16 bits for LIB and 32 bits for W-LIB
- Transposition offset value of 48 bits for LIB and 64 bits for W-LIB
- Transposition length value of 16 bits for LIB/W-LIB

```
Router# show bgp vpnv4 un rd 100:2 2.2.0.1/32 detail
```

```
BGP routing table entry for 2.2.0.1/32, Route Distinguisher: 100:2
Versions:
  Process          bRIB/RIB  SendTblVer
  Speaker          5314      5314
  Flags: 0x20061292+0x00060000; multipath; backup available;
Last Modified: Jan 20 14:37:59.189 for 00:00:19
Paths: (3 available, best #1)
  Not advertised to any peer
  Path #1: Received by speaker 0
  Flags: 0x2000000085070005+0x00, import: 0x39f
  Not advertised to any peer
  Local
    7::1 (metric 20) from 2::1 (192.0.0.1), if-handle 0x00000000
    Received Label 0x40020
    Origin IGP, localpref 150, valid, internal, best, group-best, multipath,
import-candidate, imported
    Received Path ID 1, Local Path ID 1, version 5314
    Extended community: RT:100:2
    Originator: 192.0.0.1, Cluster list: 2.0.0.1
    PSID-Type:L3, SubTLV Count:1, R:0x00,
    SubTLV:
      T:1(Sid information), Sid:fcc:cc00:7001:fff0::, F:0x00, R2:0x00, Behavior:63,
R3:0x00, SS-TLV Count:1
    SubSubTLV:
      T:1(Sid structure):
        Length [Loc-blk,Loc-node,Func,Arg]:[32,16,32,0], Tpose-len:16, Tpose-offset:64
        Source AFI: VPNv4 Unicast, Source VRF: VRF_2, Source Route Distinguisher: 100:2
  Path #2: Received by speaker 0
  Flags: 0x2000000084060005+0x00, import: 0x096
  Not advertised to any peer
  Local
    9::1 (metric 20) from 2::1 (192.0.0.3), if-handle 0x00000000
    Received Label 0x40020
    Origin IGP, localpref 100, valid, internal, backup(protect multipath), add-path,
import-candidate, imported
    Received Path ID 2, Local Path ID 5, version 5314
    Extended community: RT:100:2
    Originator: 192.0.0.3, Cluster list: 2.0.0.1
    PSID-Type:L3, SubTLV Count:1, R:0x00,
    SubTLV:
      T:1(Sid information), Sid:fcc:cc00:9001::, F:0x00, R2:0x00, Behavior:63, R3:0x00,
SS-TLV Count:1
    SubSubTLV:
      T:1(Sid structure):
        Length [Loc-blk,Loc-node,Func,Arg]:[32,16,16,0], Tpose-len:16, Tpose-offset:48
        Source AFI: VPNv4 Unicast, Source VRF: VRF_2, Source Route Distinguisher: 100:2
  Path #3: Received by speaker 0
  Flags: 0x2000000084070005+0x00, import: 0x296
  Not advertised to any peer
```



```

Local
  8::1 (metric 20) from 2::1 (192.0.0.2), if-handle 0x00000000
    Received Label 0x40020
    Origin IGP, localpref 150, valid, internal, multipath, backup, add-path,
import-candidate, imported
    Received Path ID 3, Local Path ID 4, version 5314
    Extended community: RT:100:2
    Originator: 192.0.0.2, Cluster list: 2.0.0.1
    PSID-Type:L3, SubTLV Count:1, R:0x00,
    SubTLV:
      T:1(Sid information), Sid:fccc:cc00:8001::, F:0x00, R2:0x00, Behavior:63, R3:0x00,
SS-TLV Count:1
    SubSubTLV:
      T:1(Sid structure):
        Length [Loc-blk,Loc-node,Func,Arg]:[32,16,16,0], Tpose-len:16, Tpose-offset:48
    Source AFI: VPNv4 Unicast, Source VRF: VRF_2, Source Route Distinguisher: 100:2

```

SRv6-Services: L3 Services with Local SIDs from W-LIB

Table 13: Feature History Table

Feature Name	Release	Description
SRv6-Services: L3 Services with Local SIDs from W-LIB	Release 7.11.1	<p>Introduced in this release on: NCS 5700 fixed port routers; NCS 5500 modular routers (NCS 5700 line cards [Mode: Native])</p> <p>This feature enables an SRv6 headend node to allocate and advertise local SIDs with Wide (32-bit) functions (Local W-LIB).</p> <p>The headend router utilizes the local W-LIB functionality to define and implement SR policies using SRv6 SIDs.</p> <p>The Local W-LIB is supported for Layer 3 (VPNv4/VPNv6/BGPv4/BGPv6 global) services.</p> <p>This feature introduces the usid allocation wide-local-id-block command.</p>

An SRv6 Service SID is used to identify a specific service function. This Service SID inserted into the packet header by the source node is used to steer the packet along a specific path that includes the service function. This capability enhances flexibility and control over how packets are processed and enables efficient delivery of services within the network.



Note See [SRv6 uSID Allocation Within a uSID Block](#) for more information about W-LIB.

By default, BGP specifies to SID-Manager that allocation of uSIDs is from LIB space only. With this feature enabled, BGP can indicate to the SID-Manager that uSID allocation is to be enforced from W-LIB.

BGP performs transposition when encoding the service SID for VPN services to the label part of the NLRI, as described in IETF [RFC 9252](#). In the current LIB implementation, BGP transposes the 16-bit function to the label field in the NLRI.

For W-LIB, BGP transposes the last 16-bits of the W-LIB 32-bit function to the label part of the NLRI for VPNv4 and VPNv6 routes. For more information on transposition, see the [SRv6 Services: L2 and L3 Services with Remote SIDs from W-LIB](#) section.



Note There is no transposition for BGPv4/BGPv6 global routing table.

Usage Guidelines and Limitations

This feature is supported on NCS 5700 Series routers or NC57 line cards.

This feature is not supported on NCS 5500 Series routers.

Configuration

Use the **usid allocation wide-local-id-block** command to enable the allocation and advertisement of an SRv6 Service SID with wide function (W-LIB) for L3 services.

The precedence rules for the W-LIB allocation mode are applied at different levels:

- W-LIB uSID Allocation Applied Globally under BGP:

```
router bgp 1
  segment-routing srv6
    usid allocation wide-local-id-block
  !
```

- W-LIB uSID Allocation Applied at the IPv4/v6 Address Family under BGP:

```
router bgp 1
  address-family ipv4 unicast
    segment-routing srv6
      usid allocation wide-local-id-block
  !
  address-family ipv6 unicast
    segment-routing srv6
      usid allocation wide-local-id-block
```

- W-LIB uSID Allocation Applied for all VPNv4/v6 Address Family:

```
router bgp 1
  address-family vpnv4 unicast
    vrf all
      segment-routing srv6
        usid allocation wide-local-id-block
  !
  address-family vpnv6 unicast
    vrf all
      segment-routing srv6
        usid allocation wide-local-id-block
```

- W-LIB uSID Allocation Applied at the VRF IPv4/v6 Address Family:

```
router bgp 1
  vrf foo
    address-family ipv4 unicast
      segment-routing srv6
        usid allocation wide-local-id-block
```

```

!
address-family ipv6 unicast
segment-routing srv6
  usid allocation wide-local-id-block

```

Verification

The following output shows the W-LIB uSID allocation:

```
RP/0/0/CPU0:PE1# show bgp ipv4 unicast process
```

```

BGP Process Information:
BGP is operating in STANDALONE mode
Autonomous System number format: ASPLAIN
Autonomous System: 100
Router ID: 192.168.0.1
Default Cluster ID: 192.168.0.1
Active Cluster IDs: 192.168.0.1
Fast external fallover enabled
Platform Loadbalance paths max: 16
Platform RLIMIT max: 2147483648 bytes
Maximum limit for BMP buffer size: 409 MB
Default value for BMP buffer size: 307 MB
Current limit for BMP buffer size: 307 MB
Current utilization of BMP buffer limit: 0 B
Neighbor logging is enabled
Enforce first AS enabled
AS Path multipath-relax is enabled
Use SR-Policy admin/metric of color-extcomm Nexthop during path comparison: disabled
Default local preference: 100
Default keepalive: 60
Graceful restart enabled
Restart time: 120
Stale path timeout time: 360
RIB purge timeout time: 600
Non-stop routing is enabled
ExtComm Color Nexthop validation: RIB

Update delay: 120
Generic scan interval: 15
Configured Segment-routing Local Block: [0, 0]
In use Segment-routing Local Block: [15000, 15999]
Platform support mix of sr-policy and native nexthop: No
Segment Routing SRv6 Locator Name: LOC2
Segment Routing SRv6 uSID WLIB allocation: Enforced

Address family: IPv4 Unicast
Dampening is enabled
Client reflection is enabled in global config
Dynamic MED is Disabled
Dynamic MED interval : 10 minutes
Dynamic MED Timer : Running, will expire in 342 seconds
Dynamic MED Periodic Timer : Running, will expire in 42 seconds
Scan interval: 60
Total prefixes scanned: 42
Prefixes scanned per segment: 100000
Number of scan segments: 1
Nexthop resolution minimum prefix-length: 0 (not configured)
IPv6 Nexthop resolution minimum prefix-length: 0 (not configured)
Main Table Version: 44
Table version synced to RIB: 44
Table version acked by RIB: 44

```

```

IGP notification: IGP notified
RIB has converged: version 0
RIB table prefix-limit reached ? [No], version 0
Permanent Network Unconfigured
Segment Routing SRv6 Alloc Mode: 0
Segment Routing SRv6 uSID WLIB allocation: Enforced

```

```
RP/0/0/CPU0:PE1# show bgp vrf all ipv4 unicast process
```

```
VRF: foo
-----
```

```
BGP Process Information: VRF foo
BGP Route Distinguisher: 23:1
```

```

BGP is operating in STANDALONE mode
Autonomous System number format: ASPLAIN
Autonomous System: 100
Router ID: 192.168.0.1
Default Cluster ID: 192.168.0.1
Active Cluster IDs: 192.168.0.1
Fast external fallover enabled
Platform Loadbalance paths max: 16
Platform RLIMIT max: 2147483648 bytes
Maximum limit for BMP buffer size: 409 MB
Default value for BMP buffer size: 307 MB
Current limit for BMP buffer size: 307 MB
Current utilization of BMP buffer limit: 0 B
Neighbor logging is enabled
Enforce first AS enabled
iBGP to IGP redistribution enabled
AS Path multipath-relax is enabled
Use SR-Policy admin/metric of color-extcomm Nexthop during path comparison: disabled
Default local preference: 100
Default keepalive: 60
Graceful restart enabled
Restart time: 120
Stale path timeout time: 360
RIB purge timeout time: 600
Non-stop routing is enabled
ExtComm Color Nexthop validation: RIB

```

```

Update delay: 120
Generic scan interval: 15
Configured Segment-routing Local Block: [0, 0]
In use Segment-routing Local Block: [15000, 15999]
Platform support mix of sr-policy and native nexthop: No
Segment Routing SRv6 Locator Name: LOC2 (WLIB allocation enforced)
Segment Routing SRv6 uSID WLIB allocation: Enforced

```

```

VRF foo Address family: IPv4 Unicast
Dampening is enabled
Client reflection is not enabled in global config
Dynamic MED is Disabled
Dynamic MED interval : 10 minutes
Dynamic MED Timer : Not Running
Dynamic MED Periodic Timer : Not Running
Scan interval: 60
Total prefixes scanned: 85
Prefixes scanned per segment: 100000
Number of scan segments: 1
Nexthop resolution minimum prefix-length: 0 (not configured)
IPv6 Nexthop resolution minimum prefix-length: 0 (not configured)

```

```

Main Table Version: 152
Table version synced to RIB: 152
Table version acked by RIB: 152
IGP notification: IGP notified
RIB has converged: version 1
RIB table prefix-limit reached ? [No], version 0
Permanent Network Unconfigured
Segment Routing SRv6 uSID WLIB allocation: Enforced

```

The following output shows the advertized SRv6 W-LIB uSID for the default VRF:

```

RP/0/0/CPU0:PE1# show bgp ipv4 unicast 192.168.4.1/32

BGP routing table entry for 192.168.4.1/32
Versions:
  Process                bRIB/RIB  SendTblVer
  Speaker                 419      419
    SRv6-VPN SID: fccc:cccc:a:fff0:4::/80
Last Modified: Apr  3 10:35:41.000 for 136y10w
Paths: (1 available, best #1)
  Advertised IPv4 Unicast paths to peers (in unique update groups):
    192::4
  Path #1: Received by speaker 0
  Advertised IPv4 Unicast paths to peers (in unique update groups):
    192::4
  Local
    0.0.0.0 from 0.0.0.0 (192.168.0.1)
      Origin incomplete, metric 0, localpref 100, weight 32768, valid, redistributed, best,
      group-best
      Received Path ID 0, Local Path ID 1, version 419

```

The following output shows the advertized SRv6 W-LIB uSID for a specific VRF (foo):

```

RP/0/0/CPU0:PE1# show bgp vrf foo 192.168.7.1/32

BGP routing table entry for 192.168.7.1/32, Route Distinguisher: 23:1
Versions:
  Process                bRIB/RIB  SendTblVer
  Speaker                 439      439
    SRv6-VPN SID: fccc:cccc:a:fff0:4::/80
Last Modified: Apr  3 10:31:00.000 for 00:00:44
Paths: (1 available, best #1)
  Advertised to PE peers (in unique update groups):
    192::4
  Advertised to CE peers (in unique update groups):
    10.10.10.2
  Path #1: Received by speaker 0
  Advertised to PE peers (in unique update groups):
    192::4
  Advertised to CE peers (in unique update groups):
    10.10.10.2
  Local
    0.0.0.0 from 0.0.0.0 (192.168.0.1)
      Origin incomplete, metric 0, localpref 100, weight 32768, valid, redistributed, best,
      group-best, import-candidate
      Received Path ID 0, Local Path ID 1, version 439
      Extended community: RT:23:23

```

SRv6/MPLS L3 Service Interworking Gateway

Table 14: Feature History Table

Feature Name	Release	Description
Identical Route Distinguisher (RD) for Interworking Gateways between MPLS and SRv6 Domains	Release 24.1.1	<p>Introduced in the release on: NCS 5500 fixed port routers; NCS 5700 fixed port routers; NCS 5500 modular routers (NCS 5500 line cards; NCS 5700 line cards [Mode: Compatibility; Native]).</p> <p>You can now configure the same Route Distinguisher (RD) for interworking gateways catering to both MPLS and SRv6 domains that help conserve hardware resources, reduce the BGP table scale and minimize the processing load on routers. At the same time, it ensures seamless connectivity across SRv6 and MPLS L3 EVPN domains, thus promoting interoperability and efficiency in modern network environments.</p> <p>Previously, a unique RD was required to extend L3 services between MPLS and SRv6 domains resulting in higher router load and resource consumption, which could have affected performance.</p>
SRv6/MPLS L3 Service Interworking Gateway (SRv6 Micro-SID)	Release 7.3.2	<p>This feature enables you to extend L3 services between MPLS and SRv6 domains by providing service continuity on the control plane and data plane.</p> <p>This feature allows for SRv6 L3VPN domains to interwork with existing MPLS L3VPN domains. The feature also allows a way to migrate from MPLS L3VPN to SRv6 L3VPN.</p>

SRv6/MPLS L3 Service Interworking Gateway enables you to extend L3 services between MPLS and SRv6 domains by providing service continuity on the control plane and data plane.

This feature allows for SRv6 L3VPN domains to interwork with existing MPLS L3VPN domains. The feature also allows a way to migrate from MPLS L3VPN to SRv6 L3VPN.

The SRv6/MPLS L3 Service Interworking Gateway provides both transport and service termination at the gateway node. The gateway generates both SRv6 VPN SIDs and MPLS VPN labels for all prefixes under the VRF configured for re-origination. The gateway supports traffic forwarding from MPLS domain to SRv6 domain by popping the MPLS VPN label, looking up the destination prefix, and pushing the appropriate SRv6 encapsulation. From SRv6 domain to MPLS domain, the gateway removes the outer IPv6 header, looks up the destination prefix, and pushes the VPN and next-hop MPLS labels.

VRFs on the gateway node are configured with 2 sets of route targets (RTs):

- MPLS L3VPN RTs
- SRv6 L3VPN RTs (called *stitching RTs*)

The gateway performs the following actions:

- Imports service routes received from one domain (MPLS or SRv6)
- Re-advertises exported service routes to the other domain (next-hop-self)
- Stitches the service on the data plane (uDT4/H.Encaps.Red ↔ service label)

SRv6/MPLS L3 Service Interworking Gateway Scenarios

The following scenario is used to describe the gateway functionality:

- Node 1 is an L3VPN PE in the MPLS domain with an SR prefix SID label of 16001 for its Loopback interface 10.1.1.1/32.
- Node 2 is the SRv6/MPLS L3 Service Interworking Gateway. In the MPLS domain, it has an SR prefix SID label of 16002 for its Loopback interface 10.1.1.2/32. In the SRv6 domain, it has an SRv6 locator of B:0:2::/48 and Loopback interface B:0:2::2/128.
- Node 3 is an L3VPN PE in the SRv6 domain with SRv6 locator of B:0:3::/48 and Loopback interface B:0:3::3/128.

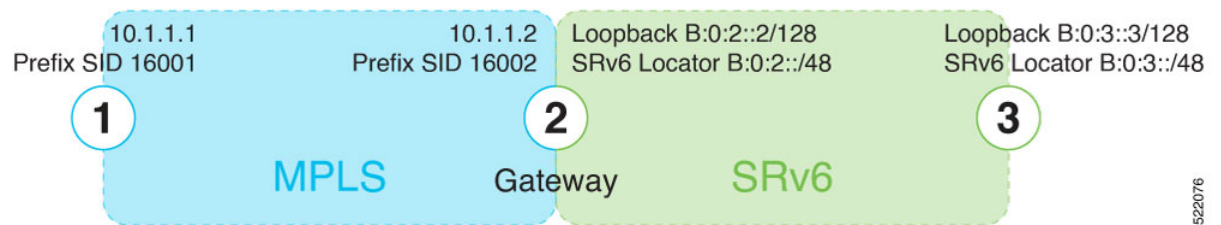

Scenario 1: SRv6-to-MPLS Control-Plane Direction/MPLS-to-SRv6 Data-Plane Direction

The figure below describes the associated control-plane behaviors in the SRv6-to-MPLS direction for traffic in the MPLS-to-SRv6 data-plane direction.

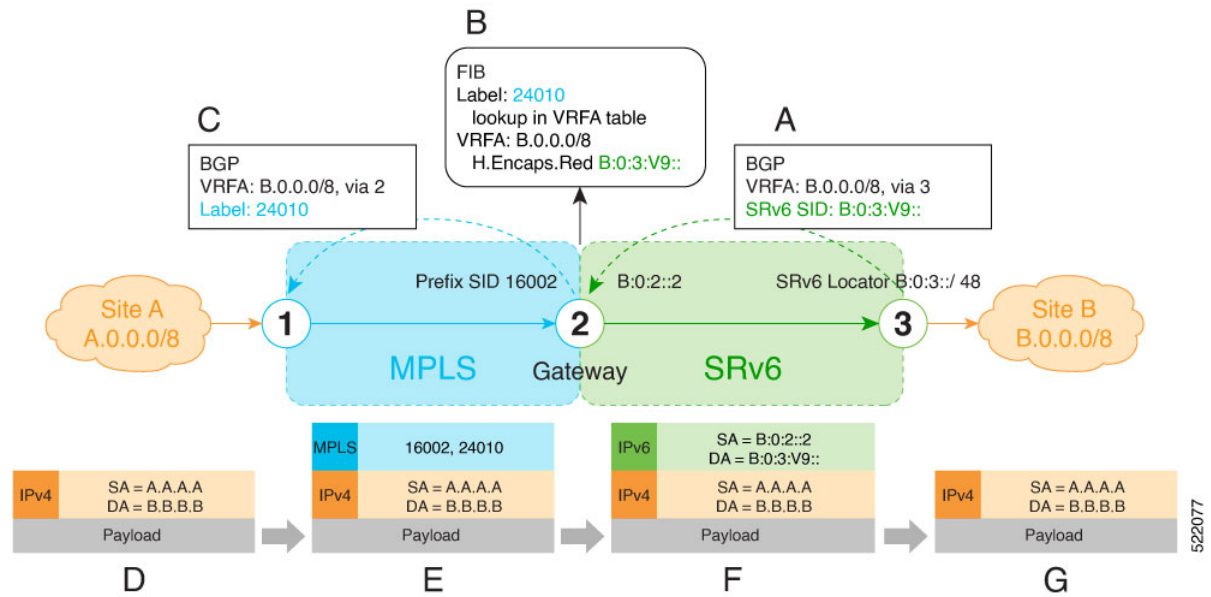

A. Node 3 advertises a BGP L3VPN update for prefix B.0.0.0/8 with RD corresponding to VRFA, including the SRv6 VPN SID (B:0:3:V9::) assigned to this VRF, in the SRv6 domain.



Note SRv6 uDT4 function value "V9" is not a valid hex number, however it is used for illustration purposes to remind you of its connection to a VRF.

B. Node 2 (gateway) imports the BGP L3VPN update and programs its FIB:

- MPLS label 24010 is allocated for VRFA
- Prefix B.0.0.0/8 is programmed with an "SR Headend Behavior with Reduced Encapsulation in an SR Policy" function (H.Encaps.Red) of B:0:3:V9::



Note The gateway follows per-VRF label and per-VRF SID allocation methods.

C. Node 2 re-originates a BGP L3VPN update for the same prefix, including the MPLS VPN label (24010) allocated for the VRF, in the MPLS domain.

D. Site A sends traffic to an IPv4 prefix (B.B.B.B) of Site B

E. Node 1 encapsulates incoming traffic with the MPLS VPN label (24010) and the prefix SID MPLS label (16002) of the BGP next-hop (Node 2).

F. Node 2 performs the following actions:

- Pops the MPLS VPN label and looks up the destination prefix
- Encapsulates the payload in an outer IPv6 header with destination address (DA) equal to the H.Encaps.Red function (B:0:3:V9::)

G. Node 3 removes the outer IPv6 header, looks up the payload destination address (B.B.B.B), and forwards to Site B.

Scenario 2: MPLS-to-SRv6 Control-Plane Direction/SRv6-to-MPLS Data-Plane Direction

The figure below describes the associated control-plane behaviors in the MPLS-to-SRv6 direction for traffic in the SRv6-to-MPLS data-plane direction.

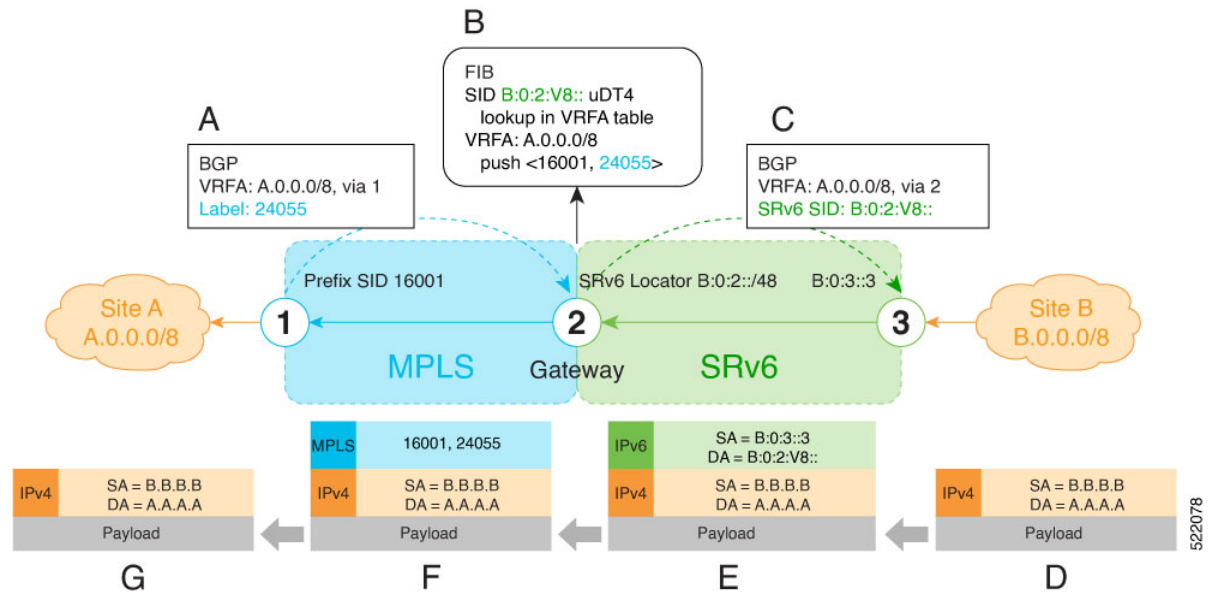

A. Node 1 advertises a BGP L3VPN update for prefix A.0.0.0/8 with RD corresponding to VRFA, including the MPLS VPN label (24055) assigned to this VRF, in the MPLS domain.

B. Node 2 (gateway) imports the BGP L3VPN update and programs its FIB:

- Prefix A.0.0.0/8 is programmed to impose an MPLS VPN label (24055) and the prefix SID MPLS label (16001) of the BGP next-hop (Node 1)
- "Endpoint with decapsulation and IPv4 table lookup" function (uDT4) of B:0:2:V8:: is allocated to VRFA



Note SRv6 uDT4 function value "V8" is not a valid hex number, however it is used for illustration purposes to remind you of its connection to a VRF.



Note The gateway follows per-VRF label and per-VRF SID allocation methods.

C. Node 2 re-originates a BGP L3VPN update for the same prefix, including the uDT4 function (B:0:2:V8::) allocated for the VRF, in the SRv6 domain.

D. Site B sends traffic to an IPv4 prefix (A.A.A.A) of Site A.

E. Node 3 Encapsulates the payload in an outer IPv6 header with destination address (DA) equal to the uDT4 function (B:0:2:V8::).

F. Node 2 performs the following actions:

- Removes the outer IPv6 header and looks up the destination prefix
- Pushes the MPLS VPN label (24055) and the prefix SID MPLS label (16001) of the BGP next-hop (Node 1)

G. Node 1 pops the MPLS VPN label, looks up the payload destination address (A.A.A.A), and forwards to Site A.

Example

Leveraging the topology described in the above use-case, this example shows the SRv6/MPLS L3 Service Interworking Gateway configuration required at Node 2.

The following configuration shows how to enable SRv6 with locator and configure encapsulation parameters:

```
segment-routing
  srv6
    encapsulation
      source-address B:0:2::2
    !
  locators
    locator LOC1
      prefix B:0:2::/48
    !
  !
  !
  !
```

The following configuration shows how to configure a VPNv4 VRF with the following route targets (RTs):

- 1111:1, RT used for MPLS L3VPN
- 2222:1, RT used for SRv6 L3VPN (stitching RT)

```
vrf ACME
  address-family ipv4 unicast
    import route-target
      1111:1
      2222:1 stitching
    !
  export route-target
    1111:1
    2222:1 stitching
  !
  !
  !
```

The following configuration shows how to configure SRv6/SRv6 VPNs under BGP:

```
router bgp 100
  segment-routing srv6
    locator LOC1
  !
  neighbor 10.1.1.1
    address-family vpnv4 unicast
      import re-originate stitching-rt
      route-reflector-client
      advertise vpnv4 unicast re-originated
    !
  neighbor B:0:3::1
    address-family vpnv4 unicast
```

```

import stitching-rt re-originate
route-reflector-client
encapsulation-type srv6
advertise vpnv4 unicast re-originated stitching-rt
!
vrf ACME
address-family ipv4 unicast
enable label-mode
segment-routing srv6

```

You can configure same route distinguisher (RD) on the Node 1, Node 2 and GW. This example shows how to configure same route distinguisher (RD) on the Node 1, Node 2 and GW. In this example, **rd 5000:2** is used on Node 1, Node 2 and GW.

```

/* Configuration on Node 1*/
vrf ACMErd 5000:2
address-family ipv4 unicast
import route-target
1111:1
!
export route-target
1111:1
!
!
!

/* Configuration on Node 2*/
vrf ACMErd 5000:2
address-family ipv4 unicast
import route-target
2222:1
!
export route-target
2222:1
!
!
!

/* Configuration on GW*/
vrf ACMErd 5000:2
address-family ipv4 unicast
import route-target
1111:1
2222:1 stitching
!
export route-target
1111:1
2222:1 stitching
!
!
!

```

L3 EVPN/SRv6 and L3 EVPN/MPLS Interworking Gateway

This feature adds support for L3 EVPN interworking between SRv6 and MPLS.

L3 EVPN/SRv6 and L3 EVPN/MPLS Interworking Gateway enables you to extend L3 EVPN services between MPLS and SRv6 domains by providing service continuity on the control plane and data plane.

This feature allows for SRv6 L3 EVPN domains to interwork with existing MPLS L3 EVPN domains. The feature also allows a way to migrate from MPLS L3 EVPN to SRv6 L3 EVPN.

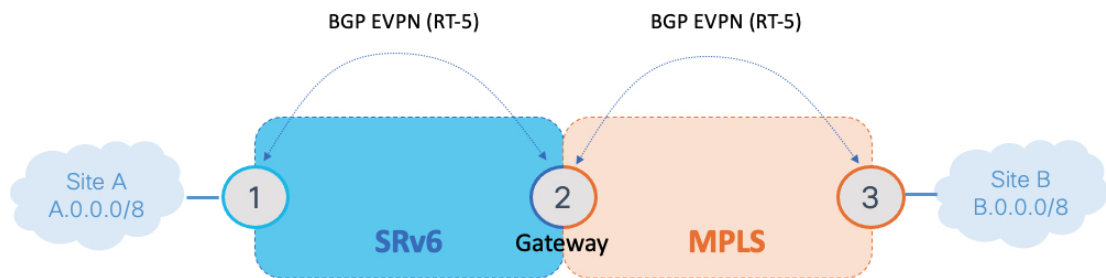

The L3 EVPN/SRv6 and L3 EVPN/MPLS Interworking Gateway provides both transport and service termination at the gateway node.

VRFs on the gateway node are configured with 2 sets of route targets (RTs):

- L3 EVPN/MPLS RTs
- L3 EVPN/SRv6 RTs (called *stitching RTs*)

The gateway performs the following actions:

- Imports service routes received from one domain (L3 EVPN/MPLS or L3 EVPN/SRv6)
- Re-originates exported service routes to the other domain and setting next-hop-self
- Stitches the service routes in the data plane (uDT4/H.Encaps.Red ↔ MPLS service label)

The gateway generates both L3 EVPN/SRv6 SIDs and L3 EVPN/MPLS labels for all prefixes under the VRF configured for re-origination:

- MPLS-to-SRv6 Control Plane Direction

The gateway imports routes received from the MPLS side (via EVPN RT5) and re-originates them in L3VPN VRF with a per-VRF SRv6 SID.

- SRv6-to-MPLS Control Plane Direction

The gateway imports routes received from the SRv6 side (via EVPN RT5) and re-originates them in L3VPN VRF with a per-VRF label.

In the data plane, the gateway forwards traffic from the MPLS domain to the SRv6 domain by popping the MPLS L3 EVPN label, looking up the destination prefix, and pushing the appropriate SRv6 encapsulation. In the opposite direction, the gateway removes the outer IPv6 header, looks up the destination prefix, and pushes the L3 EVPN and next-hop MPLS labels.

Usage Guidelines and Limitations

L3 EVPN/SRv6 and L3 EVPN/MPLS Interworking Gateway is supported for IPv4 and IPv6.

Configuration Example

Leveraging the topology described above, this example shows the SRv6/MPLS L3 EVPN Service Interworking Gateway configuration required at Node 2.

The following configuration shows how to enable SRv6 with locator and configure encapsulation parameters.

```
segment-routing
  srv6
    encapsulation
      source-address b:0:2::2
    !
    locators
      locator LOC1
        prefix b:0:2::/48
    !
  !
!
!
```

The following configuration shows how to configure a VPNv4/VPNv6 VRF with the following route targets (RTs):

- 1111:1, RT used for MPLS L3 EVPN
- 2222:1, RT used for SRv6 L3 EVPN (stitching RT)

```
vrf VPN1
  address-family ipv4 unicast
    import route-target
      1111:1
      2222:1 stitching
    !
    export route-target
      1111:1
      2222:1 stitching
    !
  !
  address-family ipv6 unicast
    import route-target
      1111:1
      2222:1 stitching
    !
    export route-target
      1111:1
      2222:1 stitching
    !
  !
!
```

The following configuration shows how to configure SRv6/SRv6 VPNs under BGP:

```
router bgp 100
  segment-routing srv6
    locator LOC1
  !
  address-family vpnv4 unicast
  !
  address-family vpnv6 unicast
  !
  address-family l2vpn evpn
  !
  neighbor 2222::2
    remote-as 100
    description SRv6 side peering
    address-family l2vpn evpn
      import reoriginate stitching-rt (Imports NLRIs that match normal route target
        identifier and exports re-originated NLRIs assigned with the stitching
```

- L3VPN/MPLS RTs
- L3 EVPN/SRv6 RTs (called *stitching RTs*)

The gateway performs the following actions:

- Imports service routes received from one domain (L3VPN/MPLS or L3 EVPN/SRv6)
- Re-originate exported service routes to the other domain and setting next-hop-self
- Stitches the service routes in the data plane (uDT4/H.Encaps.Red ↔ MPLS service label)

The gateway generates both L3 EVPN/SRv6 SIDs and L3VPN/MPLS labels for all prefixes under the VRF configured for re-origination:

- MPLS to SRv6 Control Plane Direction

The gateway imports routes received from the MPLS side (via EVPN RT5) and re-originate them in L3 EVPN VRF with a per-VRF SRv6 SID.

- SRv6 to MPLS Control Plane Direction

The gateway imports routes received from the SRv6 side (via EVPN RT5) and re-originate them in L3VPN VRF with a per-VRF label.

In the data plane, the gateway forwards traffic from the MPLS domain to the SRv6 domain by popping the MPLS L3VPN label, looking up the destination prefix, and pushing the appropriate SRv6 encapsulation. In the opposite direction, the gateway removes the outer IPv6 header, looks up the destination prefix, and pushes the L3VPN and next-hop MPLS labels.

Usage Guidelines and Limitations

L3 EVPN/SRv6 and L3 EVPN/MPLS Interworking Gateway is supported for IPv4 and IPv6.

Configuration Example

The following configuration shows how to enable SRv6 with locator and configure encapsulation parameters:

```
segment-routing
  srv6
    encapsulation
      source-address b:0:2::2
    !
  locators
    locator LOC1
      prefix b:0:2::/48
    !
  !
  !
  !
  !
```

The following configuration shows how to configure a VPNv4/VPNv6 VRF with the following route targets (RTs):

- **1111:1**, RT used for MPLS L3 EVPN
- **2222:1**, RT used for SRv6 L3 EVPN (stitching RT)

```

vrf VPN1
 address-family ipv4 unicast
  import route-target
  1111:1
  2222:1 stitching
  !
 export route-target
  1111:1
  2222:1 stitching
  !
 !
 address-family ipv6 unicast
  import route-target
  1111:1
  2222:1 stitching
  !
 export route-target
  1111:1
  2222:1 stitching
  !
 !
 !
 !

```

The following configuration shows how to configure SRv6/SRv6 VPNs under BGP:

```

router bgp 100
 segment-routing srv6
  locator LOC1
  !
 address-family vpnv4 unicast
  !
 address-family vpnv6 unicast
  !
 address-family l2vpn evpn
  !
 neighbor 2222::2
  remote-as 100
  description SRv6 side peering
  address-family l2vpn evpn
  import reoriginate stitching-rt (Imports NLRI that match normal route target
    identifier and exports re-originated NLRI assigned with the stitching
    route target identifier)
  route-reflector-client
  encapsulation-type srv6
  advertise vpnv4 unicast re-originated (Specifies advertisement of re-originated
    VPNv4 unicast routes)
  advertise vpnv6 unicast re-originated (Specifies advertisement of re-originated
    VPNv6 unicast routes)
  !
 !
 neighbor 3.3.3.3
  remote-as 100
  description MPLS side peering stitching side
  address-family vpnv4 unicast
  import stitching-rt reoriginate (Imports NLRI that match stitching route target
    identifier and exports re-originated NLRI assigned with the normal route
    target identifier)
  route-reflector-client
  advertise vpnv4 unicast re-originated stitching-rt (Advertise local VPNv4 unicast
    routes assigned with stitching route target identifier)
  !
 address-family vpnv6 unicast
  import stitching-rt reoriginate (Imports NLRI that match stitching route target

```

Configure BGP to Support Dual-Mode

Enable MPLS Label Allocation

Use the **router bgp as-number vrf WORD address-family ipv4 unicast mpls alloc enable** command under the VRF address-family to enable per-prefix mode for MPLS labels. Additionally, use the **router bgp as-number vrf WORD address-family ipv4 unicast label mode {per-ce | per-vrf}** command to choose the type of label allocation.

```
Router(config)# router bgp 100
Router(config-bgp)# vrf blue
Router(config-bgp-vrf)# rd 1:10
Router(config-bgp-vrf)# address-family ipv4 unicast
Router(config-bgp-vrf-af)# mpls alloc enable
Router(config-bgp-vrf-af)# label mode per-ce
Router(config-bgp-vrf-af)# segment-routing srv6
Router(config-bgp-vrf-af-srv6)# alloc mode per-ce
Router(config-bgp-vrf-af-srv6)# exit
Router(config-bgp-vrf-af)# exit
Router(config-bgp-vrf)# exit
Router(config-bgp)#
```

Configure Encaps on Neighbor to Send the SRv6 SID Toward the SRv6 Dataplane

By default, if a VRF prefix has both an MPLS label and an SRv6 SID, the MPLS label is sent when advertising the prefix to the PE. To advertise a VRF prefix with an SRv6 SID to an SRv6 session, use the **encapsulation-type srv6** command under the neighbor VPN address-family.

```
Router(config-bgp)# neighbor 192::6
Router(config-bgp-nbr)# remote-as 1
Router(config-bgp-nbr)# address-family ipv4 unicast
Router(config-bgp-nbr-af)# encapsulation-type srv6
Router(config-bgp-nbr-af)# exit
```

Running Config

```
router bgp 100
neighbor 192::6
  remote-as 1
  address-family ipv4 unicast
    encapsulation-type srv6
  !
!
vrf blue
rd 1:10
address-family ipv4 unicast
  mpls alloc enable
  label mode per-ce
  segment-routing srv6
  alloc mode per-ce
!
!
!
```

SRv6 SID Information in BGP-LS Reporting

BGP Link-State (BGP-LS) is used to report the topology of the domain using nodes, links, and prefixes. This feature adds the capability to report SRv6 Segment Identifier (SID) Network Layer Reachability Information (NLRI).

The following NLRI has been added to the BGP-LS protocol to support SRv6:

- Node NLRI: SRv6 Capabilities, SRv6 MSD types
- Link NLRI: End.X, LAN End.X, and SRv6 MSD types
- Prefix NLRI: SRv6 Locator
- SRv6 SID NLRI (for SIDs associated with the node): Endpoint Function, BGP-EPE Peer Node/Set

This example shows how to distribute IS-IS SRv6 link-state data using BGP-LS:

```
Router(config)# router isis 200
Router(config-isis)# distribute link-state instance-id 200
```



Note It is still possible to ping or trace a SID:

- **ping** B:k:F::
- **traceroute** B:k:F::

It is possible to use a list of packed carriers to ping or trace a SID, to ping or trace route, use **<destination SID> via srv6-carriers <list of packed carriers>**

DHCPv4 Relay Agent and Proxy Support over SRv6

This feature introduces support for DHCPv4 Relay Agent and Proxy over SRv6.

An IOS XR router can act as a DHCPv4 relay agent/proxy with a DHCPv4 server connected over an SRv6 network.

The following functionality is supported:

- DHCPv4 relay agent/proxy over SRv6 with DHCPv4 server (helper-address) located in default VRF (global)
- DHCPv4 relay agent/proxy over SRv6 with DHCPv4 server (helper-address) located in non-default VRF
- DHCPv4 relay agent/proxy on interfaces associated with a default VRF (global)
- DHCPv4 relay agent/proxy on interfaces associated with a non-default VRF
- DHCPv4 relay agent/proxy on Ethernet physical interfaces
- DHCPv4 relay agent/proxy on Ethernet bundle interfaces

For information on configuring DHCPv4 relay agent and proxy, refer to the “Implementing the Dynamic Host Configuration Protocol” chapter in the *IP Addresses and Services Configuration Guide for Cisco NCS 5500 Series Routers*.

DHCPv6 Relay Agent Support over SRv6

Table 16: Feature History Table

Feature Name	Release Information	Feature Description
DHCPv6 Relay Agent Support on SRv6	Release 7.2.2	<p>An IOS XR router can act as a DHCPv6 relay agent with a DHCPv6 server connected over an SRv6 network.</p> <p>A DHCP relay agent is a host that forwards DHCP packets between clients and servers that do not reside on a shared physical subnet.</p>

This feature introduces support for DHCPv6 Relay Agent over SRv6.

An IOS XR router can act as a DHCPv6 relay agent with a DHCPv6 server connected over an SRv6 network.

The following functionality is supported:

- DHCPv6 relay agent over SRv6 with DHCPv6 server (helper-address) located in default VRF (global)
- DHCPv6 relay agent over SRv6 with DHCPv6 server (helper-address) located in non-default VRF
- DHCPv6 relay agent on interfaces associated with a default VRF (global)
- DHCPv6 relay agent on interfaces associated with a non-default VRF
- DHCPv6 relay agent on Ethernet physical interfaces
- DHCPv6 relay agent on Ethernet bundle interfaces

For information on configuring DHCPv6 relay agent, refer to the “Implementing the Dynamic Host Configuration Protocol” chapter in the *IP Addresses and Services Configuration Guide for Cisco NCS 5500 Series Routers*.

Full-Replace Migration to SRv6 Micro-SID

Table 17: Feature History Table

Feature Name	Release	Description
Full-Replace Migration to SRv6 Micro-SID	Release 7.8.1	<p>This feature enables migration of existing SRv6 SID format1 to SRv6 Micro-SIDs (f3216) formats.</p> <p>Earlier, only one format was supported at a time, and you had to choose either format1 or Micro-SID format for the deployment of services. Migration from Full-length SIDs to SRv6 Micro-SIDs was not possible.</p> <p>The hw-module profile segment-routing srv6 mode base-and-micro-segment-f3216 subcommand is introduced under hw-module profile segment-routing srv6 mode.</p>

During the Full-Replace migration, both underlay and services are migrated from format1 to f3216. The underlay migration is done using the *Ship in the night* strategy, where updates into your environment are incremental, thereby phasing out your existing transport protocols when ready. This method minimizes the service disruption, and is recommended for seamless migration. The services migration is done using *swap* procedures, where the incoming transport label is swapped with an outgoing transport label.

The format1 to f3216 migration is seamless, requires minimal configurations, and no IETF signaling extensions. The migration enables preference of Micro-SID f3216 over format1, and minimizes traffic drop with faster convergence.

EVPN supports migration of the following services from format1 to f3216:

- IS-IS underlay (TILFA, uLoop, FlexAlgo)
- L2 overlay (EVPN VPWS - All-Active Multi-Homing)
- SRv6-MPLS IW Gateway, dual-connected PE

The following modes are supported in the context of migration:

- **Base:** SRv6 classic with format1 only.
- **Dual:** SRv6 classic with format1 and SRv6 Micro-SID with f3216 will both coexist.
- **f3216:** Micro-segment format. f3216 represents the format 3216, which is 32-bit block and 16-bit IDs.

The migration process involves the following steps:

1. **Prepare for migration:** Upgrade the network nodes to an image that is Micro-SID f3216 capable, and allows the coexistence of format1 and f3216.

Use the **hw-module profile segment-routing srv6 mode base-and-micro-segment-f3216** command to change the hardware module profile to SRv6 dual-mode.

2. **Migrate the underlay to f3216:** Enable IS-IS as an underlay protocol on PE nodes. The IS-IS configuration adds f3216 locators to format1 locators. Both format1 and f3216 endpoint SIDs are allocated, installed, and announced during this stage. f3216 is the preferred option over format1 for underlay paths.

The IS-IS SR headends provide faster convergence to f3216. Faster convergence to f3216 is done on the per-prefix per-path level, does not need any new CLI, and avoids packet drops. The format1 locators are removed after underlay traffic convergence to f3216 on all nodes. The format1 locators are unconfigured from IS-IS, and deleted from SRv6.

Change the hardware profile to SRv6 *f3216* mode.

At the end of this step, the migration status of the following P Nodes are:

- Locator reachability: f3216 only
- Underlay endpoint/headends: f3216 only
- The mode is f3216

At the end of this step, the migration status of the following PE Nodes are:

- Locator reachability: format1 and f3216
- Underlay endpoint/headends: f3216 only
- Overlay endpoint/headends: format1
- The mode is base-and-f3216

3. **Migrate the overlay to f3216:** Enables overlay f3216 under BGP and EVPN on all PE nodes. The BGP and EVPN configuration replaces format1 by f3216 locators. During this stage, the f3216 Micro-SIDs are allocated, installed, and announced, while the format1 SIDs are deallocated, uninstalled, and withdrawn.

The format1 locators are removed after overlay traffic convergence to f3216 on all nodes. The format1 locators are unconfigured from BGP and EVPN, and deleted from SRv6. For a transient period, BGP and EVPN might have some paths with format1 and some with f3216.

At the end of this step, the migration status of the following is:

- For P/PE Nodes:
 - Locator reachability: f3216 only
 - Underlay endpoint/headends: f3216 only
 - Overlay endpoint/headends: f3216 only
 - The mode is f3216

The migration starts with SRv6 base format1, and ends with SRv6 Micro-SID f3216. The migration states are:

1. **Initial state:** This is the early migration state of a deployment, for the supported features. This state comprises SRv6 base with format1.

You must use the **hw-module profile srv6 mode base** command for the initial state.

This example shows the initial state of migration with SRv6 and configure locator:

```
Router(config)# segment-routing srv6
Router(config-srv6)# locators
Router(config-srv6-locators)# locator myLoc0
Router(config-srv6-locators)# prefix f1bb:bbbb:bb00:0001::/64
```

This example shows the initial state of migration with SRv6 and IS-IS:

```
Router(config)# router isis 100
Router(config-isis)# address-family ipv6 unicast
Router(config-isis-af)# segment-routing srv6
Router(config-isis-srv6)# locator myLoc0
```

This example shows the initial state of migration with SRv6 and BGP/EVPN:

```
Router(config)# router bgp 100
Router(config-bgp)# bgp router-id 10
Router(config-bgp)# segment-routing srv6
Router(config-bgp-srv6)# locator myLoc0
```

```
Router(config)# evpn
Router(config-evpn)# segment-routing srv6
Router(config-evpn-srv6)# locator myLoc0
```

- In-migration state:** The migration procedures are initiated, and are in progress. This state comprises SRv6 in dual mode (base with format1, and Micro-SID with f3216).

You must use the **hw-module profile segment-routing srv6 mode base-and-micro-segment-f3216** command for the in-migration state.

This example shows the in-migration state with SRv6 and configure locator:

```
Router(config)# segment-routing srv6
Router(config-srv6)# locators
Router(config-srv6-locators)# locator myLoc0
Router(config-srv6-locators)# prefix f1bb:bbbb:bb00:0001::/64
Router(config-srv6-locators)# delayed-delete
Router(config-srv6-locators)# locator myuLoc0
Router(config-srv6-locators)# micro-segment behavior unode psp-usd
Router(config-srv6-locators)# prefix fcbb:bb00:0001::/48
```

This example shows the in-migration state with SRv6 and IS-IS:

```
Router(config)# router isis 100
Router(config-isis)# address-family ipv6 unicast
Router(config-isis-af)# segment-routing srv6
Router(config-isis-srv6)# locator myLoc0
Router(config-isis-srv6)# locator myuLoc0
```

This example shows the in-migration state with SRv6 and BGP/EVPN:

```
Router(config)# router bgp 100
Router(config-bgp)# bgp router-id 10
Router(config-bgp)# segment-routing srv6
Router(config-bgp-srv6)# locator myuLoc0
```

```
Router(config)# evpn
```

```
Router(config-evpn)# segment-routing srv6
Router(config-evpn-srv6)# locator myuLoc0
```

3. **End state:** This is the state of deployment at the end of the migration. At the end state, you can update the network and add new features. The Full-Replace migration end state can be of two modes:

- **Full-Replace:** Both underlay and overlay are migrated to Micro-SID f3216. Full-Replace is the Cisco recommended migration type.
- **uF1:** Underlay migrated to Micro-SID f3216, overlay remains format1. The uF1 migration is a transient state of the Full-Replace migration type.

You need to use the **hw-module profile srv6 mode f3216** command for the end migration state.

This example shows the end state with SRv6 and configure locator:

```
Router(config)# segment-routing srv6
Router(config-srv6)# locators
Router(config-srv6-locators)# locator myuLoc0
Router(config-srv6-locators)# micro-segment behavior unode psp-usd
Router(config-srv6-locators)# prefix fcbb:bb00:0001::/48
```

This example shows the end state with SRv6 and IS-IS:

```
Router(config)# router isis 100
Router(config-isis)# address-family ipv6 unicast
Router(config-isis-af)# segment-routing srv6
Router(config-isis-srv6)# locator myuLoc0
```

This example shows the end state with SRv6 and BGP/EVPN:

```
Router(config)# router bgp 100
Router(config-bgp)# bgp router-id 10
Router(config-bgp)# segment-routing srv6
Router(config-bgp-srv6)# locator myuLoc0
```

```
Router(config)# evpn
Router(config-evpn)# segment-routing srv6
Router(config-evpn-srv6)# locator myuLoc0
```

Run the following command to check the result of migration, as shown in the example:

```
RP/0/RSP0/CPU0:Router# sh route ipv6 fc00:cc30:600:e004:: detail
Wed Nov 10 18:57:56.645 UTC

Routing entry for fc00:cc30:600::/48
  Known via "isis 2", distance 115, metric 141, SRv6-locator, type level-2
  Installed Nov 2 18:56:55.718 for 00:01:01
  Routing Descriptor Blocks
    fe80::232:17ff:fec3:58c0, from 7511::1, via TenGigE0/0/0/16.1, Protected
      Route metric is 141
      Label: None
      Tunnel ID: None
      Binding Label: None
      Extended communities count: 0
      Path id:1 Path ref count:0
      NHID:0x20006(Ref:193)
      Backup path id:65
    fe80::226:80ff:fe36:7c01, from 7511::1, via TenGigE1/0/9/1.1, Backup (TI-LFA)
```



```

Repair Node(s): 3888::1
Route metric is 251
Label: None
Tunnel ID: None
Binding Label: None
Extended communities count: 0
Path id:65 Path ref count:1
NHID:0x20007(Ref:163)
SRv6 Headend:H.Insert.Red [f3216], SID-list {fc00:cc30:700::}
Route version is 0x0 (8)
No local label
IP Precedence: Not Set
QoS Group ID: Not Set
Flow-tag: Not Set
Fwd-Class: Not Set
Route Priority:RIB_PRIORITY_NON_RECURSIVE_LOW (8) SVD Type RIB_SVD_TYPE_LOCAL
Download Priority 2, Download Version 261731
No advertising protos.

```

Full-Replace Migration to SRv6 Micro-SID Restrictions

You need to reload the the line cards as the hardware profiles go through multiple transitions during the Full-Replace migration to SRv6 Micro-SID.

You can overcome the traffic drop duration at time of swap of format1 by f3216 on a PE node depending on the BGP/EVPN convergence using the **delayed_delete** command. When the **delayed_delete** command is configured against the format1 SID locator, RIB notifies EVPN about this change. The EVPN in turn stores the delayed flag in its RIB locator database.

SRv6 Traffic Accounting

Table 18: Feature History Table

Feature Name	Release Information	Feature Description
SRv6 Traffic Accounting for NCS 5700	Release 24.3.1	Introduced in this release on: NCS 5700 fixed port routers (NCS 5700 line cards [Mode: Native]). SRv6 Traffic Accounting is now supported on the Cisco NCS 5700 series routers and line cards in Native mode.

Feature Name	Release Information	Feature Description
SRv6 Traffic Accounting	Release 7.11.1	<p>Introduced in this release on: NCS 5500 fixed port routers, NCS 5500 modular routers (NCS 5500 line cards).</p> <p>You can now enable the router to record the number of packets and bytes transmitted on a specific egress interface for IPv6 traffic using the SRv6 locator counter.</p> <p>You can use this data to create deterministic data tools to anticipate and plan for future capacity planning solutions.</p> <p>This feature introduces or modifies the following changes:</p> <p>CLI:</p> <ul style="list-style-type: none"> • accounting prefixes ipv6 mode per-prefix per-nexthop srv6-locators <p>YANG Data Models:</p> <ul style="list-style-type: none"> • Cisco-IOS-XR-accounting-cfg • Cisco-IOS-XR-fib-common-oper.yang <p>(see GitHub, YANG Data Models Navigator)</p>

SRv6 traffic accounting is an integral part of today's network for planning and forecasting traffic. Traffic accounting is the volume of aggregated traffic flows that enter, traverse, and leave the network in a given time. Traffic accounting is a solution to monitor the traffic that helps to measure traffic flows and record how much customer traffic is passing through the SR network.

To design a network topology and meet the defined Service-Level Agreement (SLA), capacity planning becomes essential for forecasting traffic load and failures. A complete view of the traffic in your network enables you to anticipate common failures, and provision for network expansion.

You can now monitor traffic on an ingress node of a domain that is SRv6 encapsulated towards an egress node of the domain. The traffic is recorded at the source using the per-locator, per-egress-interface (LOC.INT.E) counter, which is the locator per interface at egress to account the traffic. For a given locator (L) and interface (I), the router counts the number of packets and bytes for the traffic transmitted on the interface (I) with a destination address (DA) matching the locator L.

When this feature is enabled on routers, all traffic passing through the routers are accounted. These counters are periodically streamed through telemetry and you can retrieve the counters at any point.

To enable traffic accounting on PE and P routers, use the **accounting prefixes ipv6 mode per-prefix** command. You can retrieve the number of packets transmitted and received on the specific interface of a PE or P routers by using the following telemetry:

```
Cisco-IOS-XR-fib-common-oper:cef-accounting/vrfs/vrf[vrf-name='default']/afis/afi[afi-type=ipv6]/pfx/srv6locs/srv6loc
```

Benefits

Monitoring the traffic provides numerous benefits, and here are a few:

- To optimize network utilization and achieve a balance between underutilized and overutilized paths.
- To plan and optimize network capacity and avoid congestion.
- To plan the service provisioning and choose the right path and create an optimized backup path (for using SRLG's affinity, and so on).

Understanding SRv6 Locator Counters

Let's understand this feature with the following topology:

Consider the topology where traffic is passing from CE1 to CE2 through PE1. The traffic sent and received from CE1 is considered as the external traffic. The traffic from PE4 destined to PE2 is considered as the internal traffic.

Figure 10: Sample Topology for SRv6 Traffic Accounting

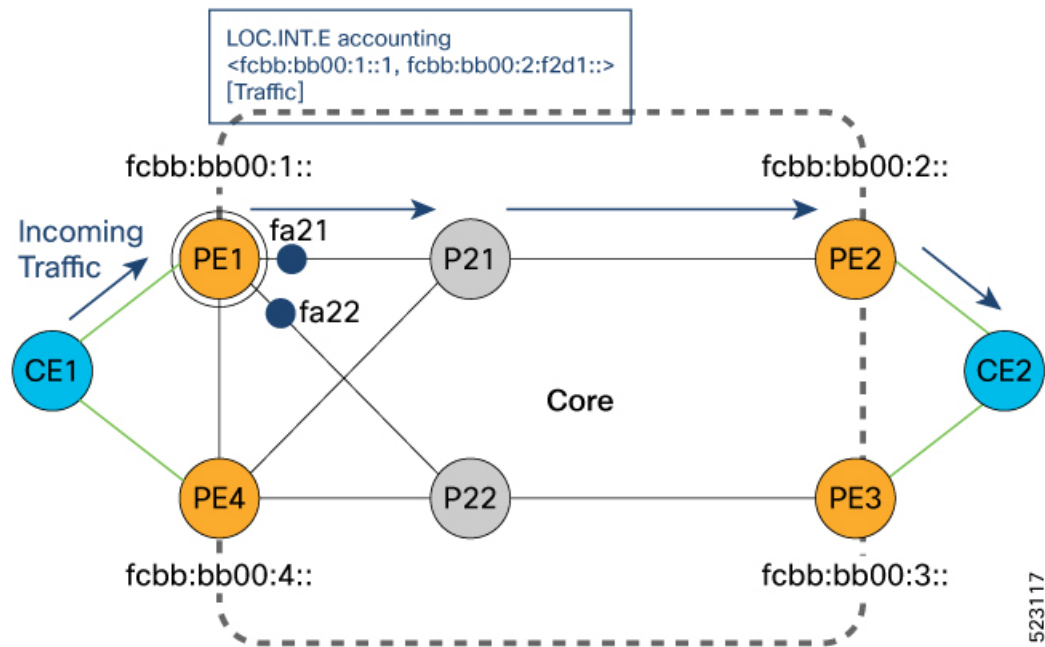

PE1 learns CE2 reachability through PE2. Consider PE1 has ECMP paths via P21 and P22 to reach PE2.

- When traffic reaches PE1, PE1 imposes traffic with the PE2 locator fcb:bb00:2::.
- SRv6 traffic accounting LOC.INT.E is per prefix per egress interface accounting.

When traffic exits the PE1 interface (fa21) through P21, PE1 keeps the count of this traffic that is sent. Also, when traffic exits the PE1 interface (fa22) through P22, PE1 keeps the count of this traffic that is sent. The traffic is accounted irrespective of the path PE1 takes to send traffic.

Here is the SRv6 label of the outgoing traffic for PE2:

- PE1 transmits a total of 39 gigabits per second towards PE2.
- PE1 receives 21 gigabits per second of internal traffic from PE4.
- PE1 receives 0 gigabits per second from P21 and P22.

You can calculate the external traffic to PE2 as follows:

```
External traffic to PE2
= (sum of all Loc.int.E counters on PE1) - ( sum of the Loc.int.E counters of all neighbors
of PE1)
= 39 gigabits per second - (21 + 0 + 0) gigabits per second
= 18 gigabits per second external traffic
```

So, PE2 receives 18 gigabits per second external traffic from PE1.

The calculation for external traffic for routers follows a similar approach. Let's see few examples in the following demand matrix.

Table 19: Demand Matrix showing traffic transmitted from PE1 and PE4 to PE2

From/To	PE1	PE2
PE1	NA	39 - (21 + 0 + 0) = 18 gigabits per second
PE4	21 - (18 + 0 + 0) = 3 gigabits per second	39 - (18 + 0 + 0) = 21 gigabits per second

Usage Guidelines and Limitations

Supported Traffic Types

- IPv6 packets.
- SRv6 packets with the local SID as the top SID.
 - If the top SID is a local uN, traffic is counted against the remote locator prefix of the next SID.
 - Traffic is not counted if the top SID is a local uA.
- SRv6 VPNv4
- SRv6 VPNv6
- SRv6 INETv4
- SRv6 INETv6

Limitations

- Supports a minimum telemetry pull interval of 30 seconds.
- Supports only per path statistics and does not support summary of statistics of all the outgoing paths.
- SRv6 traffic accounting does not count locally generated control plane packets such as ping to the remote locator.

- Packets are not counted if the local uA is the top SID.
- SRv6 traffic accounting is not supported with SRv6 TE policy.
- No additional MIBs are supported to retrieve SRv6 traffic statistics. We recommend to use telemetry through the newly added sensor-path in `Cisco-IOS-XR-fib-common-oper` to retrieve these statistics.
- ELINE or VPWS services over SRv6 undergo an extra recycle pass when SRv6 traffic accounting is enabled even when there is no additional IGP SID being added that reduces the overall throughput and increases switching latency accordingly.
- When SRv6 traffic accounting is enabled, ECMP FEC sharing is automatically disabled. This increases the usage of ECMP with FEC where the FEC resource was shared without accounting.
- Enabling SRv6 traffic accounting results in the allocation of two additional encapsulation resources per SRv6 locator prefix per path. As a result, the overall available scale of encapsulation resources is reduced accordingly.
- SRv6 traffic accounting shares the statistics resources with other features such as MPLS label accounting. Therefore, even if accounting is enabled, when the statistics resources are fully utilized in a multi-dimensional scaled configuration, the statistics count displays as 0s for SRv6 locator prefixes that do not get dedicated statistics allocated in the hardware.
- The convergence of the network is affected by enabling SRv6 traffic accounting because the same software thread handles the operations of reading statistics. The impact on convergence can vary depending on factors such as the frequency of statistics queries and the scale of locator prefixes with accounting enabled.
- There is no support for clearing the counters used in SRv6 traffic accounting.
- Prior to advertising the relevant SRv6 locator prefixes to the router, you must enable SRv6 traffic accounting. However, accounting will not be enabled for locator prefixes that are already programmed in the hardware.

Similarly, when accounting is disabled, the associated hardware resources are freed when the SRv6 locator prefixes are withdrawn.

- SRv6 traffic accounting is only supported with micro-sids and we recommend you not to enable SRv6 traffic accounting on a router that has full-length SIDs.

Configure SRv6 Traffic Accounting

Before you begin ensure that you enable SRv6 and its services.

Configuration Example

To enable SRv6 traffic accounting:

```
Router#configure
Router(config)#accounting
Router(config-acct)#prefixes ipv6 mode per-prefix per-nexthop srv6-locators
Router(config-acct)#commit
```

Running Configuration

```
Router#show run
```

```

accounting
  prefixes
    ipv6
      mode per-prefix per-nextthop srv6-locators
    !
  !
!

```

Verification

Verify the Stats ID allocated for remote locator. The following example shows the SRv6 locator ID and the stats ID allocated for the prefixes with the locator ID.

```

Router#show route ipv6 fccc:cc00:1:: detail

Routing entry for fccc:cc00:1::/48
  Known via "isis 100", distance 115, metric 101, SRv6-locator, type level-1 <=====
locator flag
  Installed Jun  1 11:59:10.941 for 00:00:04
  Routing Descriptor Blocks
    fe80::1, from 1::1, via Bundle-Ether1201, Protected, ECMP-Backup (Local-LFA)
      Route metric is 101
      Label: None
      Tunnel ID: None
      Binding Label: None
      Extended communities count: 0
      Path id:2          Path ref count:1
      NHID: 0x2001b (Ref: 79)
      Stats-NHID: 0x2001c (Ref: 6)
      Backup path id:1
    fe80::1, from 1::1, via TenGigE0/1/0/5/2, Protected, ECMP-Backup (Local-LFA)
      Route metric is 101
      Label: None
      Tunnel ID: None
      Binding Label: None
      Extended communities count: 0
      Path id:1          Path ref count:1
      NHID: 0x2001a (Ref: 79)
      Stats-NHID: 0x2001d (Ref: 6) <===== Stats-NHID is allocated for prefixes with
locator flag
      Backup path id:2
      Route version is 0x68 (104)
      No local label
      IP Precedence: Not Set
      QoS Group ID: Not Set
      Flow-tag: Not Set
      Fwd-class: Not Set
      Route Priority: RIB_PRIORITY_NON_RECURSIVE_LOW (8) SVD Type RIB_SVD_TYPE_LOCAL
      Download Priority 2, Download Version 39779
      No advertising protos.

```

Configuring Telemetry Data

Configure the sensory path to retrieve the accounting data using telemetry:

```

Router#configure
Router(config)#grpc
Router(config-grpc)#port 57400
Router(config-grpc)#no-tls
Router(config-grpc)#commit
Router(config-grpc)#exit
Router(config)#telemetry model-driven
Router(config-model-driven)#sensor-group s1

```

```

Router(config-model-driven-snsr-grp)#sensor-path
Cisco-IOS-XR-fib-common-oper:cef-accounting/vrfs/vrf[vrf-name='default']/af$
Router(config-model-driven-snsr-grp)#exit
Router(config-model-driven)#subscription sub1
Router(config-model-driven-subs)#sensor-group-id s1 sample-interval 30000
Router(config-model-driven-subs)#commit
Router(config-model-driven-subs)#root
Router(config)#exit
Router#

```

Running Configuration for Configuring Telemetry Data

The following shows the show running configuration:

```

Router#show run
grpc
  port 57400
  no-tls
!
telemetry model-driven
  sensor-group s1
  sensor-path
Cisco-IOS-XR-fib-common-oper:cef-accounting/vrfs/vrf[vrf-name='default']/afis/afi[afi-type=ipv6]/pfx/srv6locs/srv6loc

!
subscription sub1
  sensor-group-id s1 sample-interval 30000
!
!

```

Verification for Configuring Telemetry Data

Verify the counters using the telemetry data. The following example shows the accounting data with the number of packets and the bytes transmitted through the interface.

```

{
"Cisco-IOS-XR-fib-common-oper:cef-accounting": {
  "vrfs": {
    "vrf": [
      {
        "vrf-name": "default",
        "afis": {
          "afi": [
            {
              "afi-type": "ipv6",
              "pfx": {
                "srv6locs": {
                  "srv6loc": [
                    {
                      "ipv6-address": " fccc:cc00:1::",
                      "prefix-length": 48,
                      "ipv6-prefix": " fccc:cc00:1::",
                      "ipv6-prefix-length": 48,
                      "accounting-information": [
                        {
                          "number-of-tx-packets": "1500000",           <===== Accounting data
                          "number-of-tx-bytes": "378000000",         <===== Accounting data
                          "path-index": 0,
                          "outgoing-interface": "Bundle-Ether1201",
                          "nexthop-addr": "fe80::2/128"
                        }
                      ]
                    }
                  ]
                }
              }
            }
          ]
        }
      }
    ]
  }
}

```

Path Maximum Transmission Unit (MTU) Discovery for SRv6 Encapsulated Packets

Table 20: Feature History Table

Feature Name	Release Information	Feature Description
Path MTU Discovery for SRv6 Packets on Ingress Provider Edge (PE) Routers, Egress (PE) Router, and Provider Core Router Transit Nodes	Release 24.1.1	<p>Introduced in this release on: NCS 5700 fixed port routers (NCS 5700 line cards [Mode: Native]).</p> <p>You can measure and monitor the packet loss information when one SRv6-enabled router sends an oversized packet to another. This functionality enables a router to send an ICMP error message to the source in such cases, prompting the sender to resend a packet whose size is within the MTU value, thus ensuring the packet moves ahead. The feature is critical for SRv6-enabled routers as these routers do not support packet fragmentation.</p> <p>This feature is enabled by default.</p>

Feature Name	Release Information	Feature Description
Path MTU Discovery for SRv6 Packets on Ingress Provider Edge (PE) Routers	Release 7.11.1	<p>Introduced in this release on: NCS 5500 fixed port routers; NCS 5500 modular routers (NCS 5500 line cards).</p> <p>You can measure and monitor the packet loss information when one SRv6-enabled router sends an oversized packet to another. This functionality enables a router to send an ICMP error message to the source in such cases, prompting the sender to resend a packet whose size is within the MTU value, thus ensuring the packet moves ahead. The feature is critical for SRv6-enabled routers as these routers don't support packet fragmentation.</p> <p>Previously, a router dropped oversized packets without notifying the source, resulting in packet loss.</p> <p>The feature introduces these changes:</p> <p>CLI:</p> <ul style="list-style-type: none"> The path-mtu keyword is introduced in the hw-module profile segment-routing srv6 mode command.

Earlier, routers did not account for the SRv6 encapsulated packets while checking the MTU of a link along a given data path in the egress core interface. When the path MTU of a link along a given data path was not large enough to accommodate the size of the encapsulated packets from a source, the router silently dropped the packets without notifying the source.

With this configuration, the ingress PE router supports Path MTU discovery for SRv6 encapsulated packets. The router does not drop the packets along a given data path without notifying the source. The router sends an ICMP type 3 or type 2 error message for IPv4 or IPv6 links respectively. The configuration enables the source to learn to use a smaller MTU for packets sent to a destination.

For example, the maximum allowed MTU for an IPv4 link is 1500 bytes. Consider a source that sends an IPv4 packet of size 1480 bytes with an SRv6 encapsulation of 40 bytes. The overall IPv4 packet size is increased to 1520 bytes, which is greater than the maximum MTU allowed on the IPv4 link. In this case, the router sends an ICMP Type 3 error message to the source to request the packet originator to adjust the size of the packet.

We calculate the maximum allowed MTU on IPv4 and IPv6 links using the following formula:

Maximum MTU = Egress Interface MTU + SRv6 Encapsulation Size (maximum 64 bytes) + size of L2 Header

Usage Guidelines and Limitations

The following usage guidelines and limitations apply:

- Ingress
 - The SRv6 uSID (F3216) format supports the feature.
 - The SRv6 Full-length SID format does not support Path MTU discovery.
 - For Cisco IOS XR Release 7.11.1, you must configure this feature on the Ingress PE router for NCS 5500 Series Routers.



Note Starting from Cisco IOS XR Release 24.1.1, Ingress, Egress, and Provider Core Router or Transit nodes with IPv6 are supported by Cisco NCS 5700 Series Routers and Cisco NC 57 line cards in native mode.

- SRv6 encapsulation supports the following scenarios:
 - IPv4/IPv6 over SRv6
 - SRv6-TE
 - H insert
 - TI-LFA for Single Carrier and Multi Carrier
- L2 services over SRv6 (L2VPN) do not support the feature.
- Egress
 - Starting from Cisco IOS XR Release 24.1.1, you can configure this feature on the Egress PE router for Cisco NCS 5700 Series Routers and Cisco NC 57 line cards in native mode.
 - Only supported for the following functions:
 - Decapsulation and specific IPv4 table lookup (DT4), Decapsulation and specific IPv6 table lookup (DT6), and Decapsulation and specific IP table lookup (DT46)
 - Decapsulation and IPv4 cross-connect (DX4) and Decapsulation and IPv6 cross-connect (DX6)
 - The decapsulated packet is punted to PI (after removing the SR6 headers).
 - Does not support Decapsulation and L2 table lookup (DT2) and Decapsulation and L2 cross-connect (DX2) functions (because L2 payload is not a use-case).
- Provider Core Router or Transit Node
 - Starting from Cisco IOS XR Release 24.1.1, path MTU discovery supports P node that is in IPv6-only for Cisco NCS 5700 Series Routers and Cisco NC 57 line cards in native mode.
 - Path MTU discovery now supports SRv6 enabled endpoint is a Provider Core Router or a Transit node. This is possible when the destination address of the packet is a SID.

Enabling Path MTU discovery for SRv6 encapsulated packets

Perform this task in global configuration mode to enable Path MTU discovery for SRv6 encapsulated packets:



Note To enable this feature on NCS 5500 Series line cards, run the **hw-module profile segment-routing srv6 mode micro-segment format f3216 path-mtu** command. It is enabled by default in the other platforms.

```
Router#configure
Router(config)#hw-module profile segment-routing srv6 mode micro-segment format f3216
path-mtu
In order to activate/deactivate this srv6 profile, you must manually reload the chassis/all
line cards
Router(config-srv6)#commit
```



Note After committing the configuration, you must reload the chassis or all line cards using the command **reload location all**.

Running Configuration

```
hw-module profile segment-routing srv6 mode micro-segment format f3216 path-mtu
!
```

