



Cisco Nexus 9000 Series NX-OS Unicast Routing Configuration Guide, Release 10.5(x)

First Published: 2024-07-26

Americas Headquarters

Cisco Systems, Inc.
170 West Tasman Drive
San Jose, CA 95134-1706
USA
<http://www.cisco.com>
Tel: 408 526-4000
800 553-NETS (6387)
Fax: 408 527-0883

THE SPECIFICATIONS AND INFORMATION REGARDING THE PRODUCTS REFERENCED IN THIS DOCUMENTATION ARE SUBJECT TO CHANGE WITHOUT NOTICE. EXCEPT AS MAY OTHERWISE BE AGREED BY CISCO IN WRITING, ALL STATEMENTS, INFORMATION, AND RECOMMENDATIONS IN THIS DOCUMENTATION ARE PRESENTED WITHOUT WARRANTY OF ANY KIND, EXPRESS OR IMPLIED.

The Cisco End User License Agreement and any supplemental license terms govern your use of any Cisco software, including this product documentation, and are located at <https://www.cisco.com/c/en/us/about/legal/cloud-and-software/software-terms.html>. Cisco product warranty information is available at <https://www.cisco.com/c/en/us/products/warranty-listing.html>. US Federal Communications Commission Notices are found here <https://www.cisco.com/c/en/us/products/us-fcc-notice.html>.

IN NO EVENT SHALL CISCO OR ITS SUPPLIERS BE LIABLE FOR ANY INDIRECT, SPECIAL, CONSEQUENTIAL, OR INCIDENTAL DAMAGES, INCLUDING, WITHOUT LIMITATION, LOST PROFITS OR LOSS OR DAMAGE TO DATA ARISING OUT OF THE USE OR INABILITY TO USE THIS MANUAL, EVEN IF CISCO OR ITS SUPPLIERS HAVE BEEN ADVISED OF THE POSSIBILITY OF SUCH DAMAGES.

Any products and features described herein as in development or available at a future date remain in varying stages of development and will be offered on a when-and if-available basis. Any such product or feature roadmaps are subject to change at the sole discretion of Cisco and Cisco will have no liability for delay in the delivery or failure to deliver any products or feature roadmap items that may be set forth in this document.

Any Internet Protocol (IP) addresses and phone numbers used in this document are not intended to be actual addresses and phone numbers. Any examples, command display output, network topology diagrams, and other figures included in the document are shown for illustrative purposes only. Any use of actual IP addresses or phone numbers in illustrative content is unintentional and coincidental.

The documentation set for this product strives to use bias-free language. For the purposes of this documentation set, bias-free is defined as language that does not imply discrimination based on age, disability, gender, racial identity, ethnic identity, sexual orientation, socioeconomic status, and intersectionality. Exceptions may be present in the documentation due to language that is hardcoded in the user interfaces of the product software, language used based on RFP documentation, or language that is used by a referenced third-party product.

Cisco and the Cisco logo are trademarks or registered trademarks of Cisco and/or its affiliates in the U.S. and other countries. To view a list of Cisco trademarks, go to this URL: <https://www.cisco.com/c/en/us/about/legal/trademarks.html>. Third-party trademarks mentioned are the property of their respective owners. The use of the word partner does not imply a partnership relationship between Cisco and any other company. (1721R)

© 2024 Cisco Systems, Inc. All rights reserved.



CONTENTS

Trademarks ?

PREFACE

Preface xxix

Audience xxix

Document Conventions xxix

Related Documentation for Cisco Nexus 9000 Series Switches xxx

Documentation Feedback xxx

Communications, Services, and Additional Information xxx

Cisco Bug Search Tool xxxi

Documentation Feedback xxxi

CHAPTER 1

New and Changed Information 1

New and Changed Information 1

CHAPTER 2

Overview 3

Licensing Requirements 3

Supported Platforms 3

Information About Layer 3 Unicast Routing 3

Routing Fundamentals 3

Packet Switching 4

Routing Metrics 5

Path Length 5

Reliability 6

Routing Delay 6

Bandwidth 6

Load 6

Communication Cost	6
Router IDs	6
Autonomous Systems	7
Convergence	7
Load Balancing and Equal Cost Multipath	8
Route Redistribution Overview	8
Administrative Distance	8
Stub Routing	8
Routing Algorithms	9
Static Routes and Dynamic Routing Protocols	10
Interior and Exterior Gateway Protocols	10
Distance Vector Protocols	10
Link-State Protocols	10
Layer 3 Virtualization	11
Cisco NX-OS Forwarding Architecture	12
Unicast RIB	12
Adjacency Manager	12
Unicast Forwarding Distribution Module	12
FIB	13
Hardware Forwarding	13
Software Forwarding	13
Summary of Layer 3 Unicast Routing Features	13
IPv4 and IPv6	14
IP Services	14
OSPF	14
EIGRP	14
IS-IS	14
BGP	14
RIP	15
Static Routing	15
Layer 3 Virtualization	15
Route Policy Manager	15
Policy-Based Routing	15
First Hop Redundancy Protocols	15

Object Tracking	16
Related Topics	16

CHAPTER 3

Configuring IPv4	17
About IPv4	17
Multiple IPv4 Addresses	18
LPM Routing Modes	18
Host to LPM Spillover	20
Address Resolution Protocol	20
ARP Caching	21
Static and Dynamic Entries in the ARP Cache	21
Devices That Do Not Use ARP	21
Reverse ARP	22
Proxy ARP	22
Local Proxy ARP	23
Gratuitous ARP	23
Periodic ARP Refresh on MAC Delete	23
Glean Throttling	23
Path MTU Discovery	23
ICMP	24
Virtualization Support for IPv4	24
Prerequisites for IPv4	24
Guidelines and Limitations for IPv4	24
Default Settings	26
Configuring IPv4	27
Configuring IPv4 Addressing	27
Configuring Multiple IP Addresses	28
Configuring Max-Host Routing Mode	29
Configuring Nonhierarchical Routing Mode (Cisco Nexus 9500 Platform Switches Only)	30
Configuring 64-Bit ALPM Routing Mode (Cisco Nexus 9500 Platform Switches Only)	31
Configuring ALPM Routing Mode (Cisco Nexus 9300 Platform Switches Only)	32
Configuring LPM Heavy Routing Mode (Cisco Nexus 9200 and 9300-EX Platform Switches and 9732C-EX Line Card Only)	33
Configuring LPM Internet-Peering Routing Mode	34

Configuring LPM Dual-Host Routing Mode	35
Configuring a Static ARP Entry	37
Configuring Proxy ARP	37
Configuring Local Proxy ARP on Ethernet Interfaces	38
Configuring Local Proxy ARP on SVIs	39
Configuring Periodic ARP Refresh on MAC Delete for SVIs	40
Configuring Gratuitous ARP	41
Configuring Out of Subnet ARP Resolution	42
Configuring ARP Cache Limit Per SVI Interface	43
Configuring Path MTU Discovery	43
Configuring IP Directed Broadcasts	44
Configuring IP Glean Throttling	45
Configuring the Hardware IP Glean Throttle Maximum	45
Configuring the Hardware IP Glean Throttle Timeout	46
Configuring the Interface IP Address for the ICMP Source IP Field	47
Configuring IPv4 Redirect Syslog	47
Verifying the IPv4 Configuration	48
Additional References	49
Related Documents for IPv4	49

CHAPTER 4**Configuring IPv6 51**

About IPv6	51
IPv6 Address Formats	51
IPv6 Unicast Addresses	52
Aggregatable Global Addresses	53
Link-Local Addresses	54
IPv4-Compatible IPv6 Addresses	54
Unique Local Addresses	55
Site Local Addresses	55
IPv4 Packet Header	56
Simplified IPv6 Packet Header	56
DNS for IPv6	59
Path MTU Discovery for IPv6	59
CDP IPv6 Address Support	60

ICMP for IPv6	60
IPv6 Neighbor Discovery	61
IPv6 Neighbor Solicitation Message	61
IPv6 Stateless Autoconfiguration	63
IPv6 Compute Node IP Auto-Configuration	63
IPv6 Router Advertisement Message	63
IPv6 Neighbor Redirect Message	65
IPv6 Anycast Addresses	66
IPv6 Multicast Addresses	66
LPM Routing Modes	67
Host to LPM Spillover	69
Virtualization Support	69
IPv6 Routes with ECMP	70
Prerequisites for IPv6	70
Guidelines and Limitations for IPv6	70
Configuring IPv6	71
Configuring IPv6 Addressing	71
Configuring Max-Host Routing Mode (Cisco Nexus 9500 Platform Switches Only)	73
Configuring Nonhierarchical Routing Mode (Cisco Nexus 9500 Series Switches Only)	74
Configuring 64-Bit ALPM Routing Mode (Cisco Nexus 9500 Platform Switches Only)	75
Configuring ALPM Routing Mode (Cisco Nexus 9300 Platform Switches Only)	77
Configuring IPv6 Neighbor Discovery	78
Optional IPv6 Neighbor Discovery	80
Configuring IPv6 Packet Verification	81
Configuring IPv6 Stateless Autoconfiguration	82
Configuring LPM Heavy Routing Mode (Cisco Nexus 9200 and 9300-EX Platform Switches and 9732C-EX Line Card Only)	84
Configuring LPM Internet-Peering Routing Mode (Cisco Nexus 9500-R Platform Switches, Cisco Nexus 9300-EX Platform Switches and Cisco Nexus 9000 Series Switches with 9700-EX Line Cards Only)	85
Additional Configuration for LPM Internet-Peering Routing Mode	86
Configuring LPM Dual-Host Routing Mode (Cisco Nexus 9200 and 9300-EX Platform Switches)	87
Configuring IPv6 Redirect Syslog	88
Verifying the IPv6 Configuration	89
Configuration Examples for IPv6	90

CHAPTER 5	Configuring DNS	91
	About DNS Clients	91
	DNS Client Overview	91
	Name Servers	91
	DNS Operation	92
	High Availability	92
	Virtualization Support	92
	Prerequisites for DNS Clients	92
	Guidelines and Limitations for DNS Clients	92
	Default Settings for DNS Clients	93
	Configuring DNS Clients	93
	Configuring the DNS Client	93
	Configuring Virtualization	95
	Verifying the DNS Client Configuration	97
	Configuration Examples for the DNS Client	97

CHAPTER 6	Configuring OSPFv2	99
	About OSPFv2	99
	OSPFv2 and the Unicast RIB	100
	Authentication	100
	Simple Password Authentication	100
	Cryptographic Authentication	101
	MD5 Authentication	101
	HMAC-SHA Authentication	101
	Advanced Features	101
	Stub Area	101
	Not So Stubby Area	102
	Virtual Links	102
	Route Redistribution	103
	Route Summarization	103
	High Availability and Graceful Restart	104
	OSPFv2 Stub Router Advertisements	104
	Multiple OSPFv2 Instances	105

SPF Optimization	105
BFD	105
Virtualization Support for OSPFv2	105
Prerequisites for OSPFv2	105
Guidelines and Limitations for OSPFv2	106
Default Settings for OSPFv2	107
Configuring Basic OSPFv2	108
Enabling OSPFv2	108
Creating an OSPFv2 Instance	109
Configuring Optional Parameters on an OSPFv2 Instance	110
Configuring Networks in OSPFv2	112
Configuring Authentication for an Area	114
Configuring Authentication for an Interface	116
Configuring Advanced OSPFv2	119
Configuring Filter Lists for Border Routers	119
Configuring Stub Areas	120
Configuring a Totally Stubby Area	122
Configuring NSSA	122
Configuring Multi-Area Adjacency	124
Configuring Virtual Links	126
Configuring Redistribution	128
Limiting the Number of Redistributed Routes	130
Configuring Route Summarization	132
Configuring Stub Route Advertisements	133
Configuring the Administrative Distance of Routes	135
Modifying the Default Timers	137
Configuring Graceful Restart	140
Restarting an OSPFv2 Instance	142
Configuring OSPFv2 with Virtualization	142
Verifying the OSPFv2 Configuration	144
Monitoring OSPFv2	145
Configuration Examples for OSPFv2	146
OSPF RFC Compatibility Mode Example	146
Additional References	146

Related Documents for OSPFv2 146

MIBs 147

CHAPTER 7**Configuring OSPFv3 149**

About OSPFv3 149

Comparison of OSPFv3 and OSPFv2 150

Hello Packet 150

Neighbors 151

Adjacency 151

Designated Routers 152

Areas 152

Link-State Advertisement 153

Link-State Advertisement Types 153

Link Cost 154

Flooding and LSA Group Pacing 154

Link-State Database 155

Multi-Area Adjacency 155

OSPFv3 and the IPv6 Unicast RIB 155

Address Family Support 156

Authentication and Encryption 156

Advanced Features 156

Stub Area 156

Not-So-Stubby Area 157

Virtual Links 158

Route Redistribution 158

Route Summarization 159

High Availability and Graceful Restart 159

Multiple OSPFv3 Instances 160

SPF Optimization 160

BFD 160

Virtualization Support 160

Prerequisites for OSPFv3 161

Guidelines and Limitations for OSPFv3 161

Default Settings 163

Configuring Basic OSPFv3	163
Enabling OSPFv3	163
Creating an OSPFv3 Instance	164
Configuring Networks in OSPFv3	166
Configuring Advanced OSPFv3	169
Configuring Filter Lists for Border Routers	169
Configuring Stub Areas	171
Configuring a Totally Stubby Area	172
Configuring NSSA	172
Configuring Multi-Area Adjacency	175
Configuring Virtual Links	176
Configuring Redistribution	178
Limiting the Number of Redistributed Routes	180
Configuring Route Summarization	182
Configuring the Administrative Distance of Routes	184
Modifying the Default Timers	186
Configuring Graceful Restart	189
Restarting an OSPFv3 Instance	190
Configuring OSPFv3 with Virtualization	191
Configuring Encryption and Authentication	193
Configuring OSPFv3 Encryption at Router Level	194
Configuring OSPFv3 Encryption at Area Level	195
Configuring OSPFv3 Encryption at Interface Level	196
Configuring OSPFv3 Encryption for Virtual Links	197
Configuring OSPFv3 Authentication at Router Level	199
Configuring OSPFv3 Authentication at Area Level	200
Configuring OSPFv3 Authentication at Interface Level	202
Configuring OSPFv3 Authentication at Virtual Links Level	203
Verifying the OSPFv3 Configuration	205
Monitoring OSPFv3	206
Configuration Examples for OSPFv3	206
Related Topics	207
Additional References	207
MIBs	207

CHAPTER 8	Configuring EIGRP	209
	About EIGRP	209
	EIGRP Components	209
	Reliable Transport Protocol	210
	Neighbor Discovery and Recovery	210
	Diffusing Update Algorithm	210
	EIGRP Route Updates	211
	Internal Route Metrics	211
	Wide Metrics	211
	External Route Metrics	212
	EIGRP and the Unicast RIB	212
	Advanced EIGRP	213
	Address Families	213
	Authentication	213
	Stub Routers	214
	Route Summarization	214
	Route Redistribution	214
	Load Balancing	214
	Split Horizon	215
	BFD	215
	Virtualization Support	215
	Graceful Restart and High Availability	215
	Multiple EIGRP Instances	216
	Prerequisites for EIGRP	216
	Guidelines and Limitations for EIGRP	216
	Default Settings	218
	Configuring Basic EIGRP	219
	Enabling the EIGRP Feature	219
	Creating an EIGRP Instance	219
	Restarting an EIGRP Instance	222
	Shutting Down an EIGRP Instance	222
	Configuring a Passive Interface for EIGRP	223
	Shutting Down EIGRP on an Interface	223

Configuring Advanced EIGRP	224
Configuring Authentication in EIGRP	224
Configuring EIGRP Stub Routing	226
Configuring a Summary Address for EIGRP	227
Redistributing Routes into EIGRP	228
Limiting the Number of Redistributed Routes	229
Configuring Load Balancing in EIGRP	231
Configuring Graceful Restart for EIGRP	233
Adjusting the Interval Between Hello Packets and the Hold Time	234
Disabling Split Horizon	235
Enabling Wide Metrics	235
Tuning EIGRP	236
Configuring Virtualization for EIGRP	239
Verifying the EIGRP Configuration	240
Monitoring EIGRP	241
Configuration Examples for EIGRP	241
Related Topics	242
Additional References	242
Related Documents	242
MIBs	243

CHAPTER 9

Configuring IS-IS	245
About IS-IS	245
IS-IS Overview	246
IS-IS Areas	246
NET and System ID	247
Designated Intermediate System	247
IS-IS Authentication	247
Mesh Groups	248
Overload Bit	248
Route Summarization	248
Route Redistribution	249
Link Prefix Suppression	249
Load Balancing	249

BFD	249
Virtualization Support	250
High Availability and Graceful Restart	250
Multiple IS-IS Instances	250
Prerequisites for IS-IS	250
Guidelines and Limitations for IS-IS	251
Default Settings	251
Configuring IS-IS	252
IS-IS Configuration Modes	252
Enabling the IS-IS Feature	252
Creating an IS-IS Instance	253
Restarting an IS-IS Instance	255
Shutting Down IS-IS	255
Configuring IS-IS on an Interface	256
Shutting Down IS-IS on an Interface	257
Configuring IS-IS Authentication in an Area	258
Configuring IS-IS Authentication on an Interface	259
Configuring a Mesh Group	260
Configuring a Designated Intermediate System	261
Configuring Dynamic Host Exchange	261
Setting the Overload Bit	262
Configuring the Attached Bit	262
Configuring the Transient Mode for Hello Padding	263
Configuring a Summary Address	263
Configuring Redistribution	265
Limiting the Number of Redistributed Routes	266
Advertising Only Passive Interface Prefixes	268
Suppressing Prefixes on an Interface	269
Disabling Strict Adjacency Mode	270
Configuring a Graceful Restart	271
Configuring Virtualization	272
Tuning IS-IS	275
Verifying the IS-IS Configuration	277
Monitoring IS-IS	278

Configuration Examples for IS-IS 279

Related Topics 279

CHAPTER 10

Configuring Basic BGP 281

About Basic BGP 281

BGP Autonomous Systems 282

4-Byte AS Number Support 282

Administrative Distance 282

BGP Peers 282

BGP Sessions 282

Dynamic AS Numbers for Prefix Peers and Interface Peers 283

BGP Router Identifier 283

BGP Path Selection 284

BGP Path Selection - Comparing Pairs of Paths 284

BGP Path Selection - Determining the Order of Comparisons 286

BGP Path Selection - Determining the Best-Path Change Suppression 287

BGP and the Unicast RIB 287

BGP Prefix Independent Convergence 287

BGP PIC Edge Unipath 288

BGP PIC Edge with Multipath 290

BGP PIC Core 292

BGP PIC Feature Support Matrix 293

BGP Virtualization 293

Prerequisites for BGP 293

Guidelines and Limitations for Basic BGP 293

Default Settings 295

CLI Configuration Modes 295

Global Configuration Mode 296

Address Family Configuration Mode 296

Neighbor Configuration Mode 296

Neighbor Address Family Configuration Mode 297

Configuring Basic BGP 297

Enabling BGP 298

Creating a BGP Instance 298

Restarting a BGP Instance	300
Shutting Down BGP	300
Configuring BGP Peers	301
Configuring Dynamic AS Numbers for Prefix Peers	303
Configuring BGP PIC Edge	305
Configuring BGP PIC Core	307
Clearing BGP Information	308
Verifying the Basic BGP Configuration	311
Monitoring BGP Statistics	313
Configuration Examples for Basic BGP	314
Related Topics	314
Where to Go Next	314
Additional References	314
MIBs for Basic BGP	314

CHAPTER 11

Configuring Advanced BGP	315
About Advanced BGP	316
Peer Templates	316
Authentication	316
Route Policies and Resetting BGP Sessions	317
eBGP	317
iBGP	317
AS Confederations	318
Route Reflector	319
Capabilities Negotiation	319
Route Dampening	319
Load Sharing and Multipath	320
BGP Additional Paths	321
Route Aggregation	321
BGP Conditional Advertisement	322
BGP Next-Hop Address Tracking	322
Route Redistribution	323
Labeled and Unlabeled Unicast Routes	323
BFD	323

Tuning BGP	324
BGP Timers	324
Tuning the Best-Path Algorithm	324
Multiprotocol BGP	324
RFC 5549	325
RFC 6368	325
BGP Monitoring Protocol	326
Graceful Restart and High Availability	327
Low Memory Handling	327
Virtualization Support	328
Prerequisites for Advanced BGP	328
Guidelines and Limitations for Advanced BGP	328
Default Settings	333
Configuring Advanced BGP	333
Enabling IP Forward on an Interface	333
Configuring BGP Session Templates	334
Configuring BGP Peer-Policy Templates	336
Configuring BGP Peer Templates	339
Configuring Prefix Peering	341
Configuring BGP Interface Peering via IPv6 Link-Local for IPv4 and IPv6 Address Families	343
Configuring BGP Authentication	346
Resetting a BGP Session	348
Modifying the Next-Hop Address	348
Configuring BGP Next-Hop Address Tracking	349
Configuring Next-Hop Filtering	349
Configuring Next-Hop Resolution via Default Route	350
Controlling Reflected Routes Through Next-Hop-Self	350
Shrinking Next-Hop Groups When A Session Goes Down	351
Disabling Capabilities Negotiation	351
Disabling Policy Batching	352
Configuring BGP Additional Paths	352
Advertising the Capability of Sending and Receiving Additional Paths	352
Configuring the Sending and Receiving of Additional Paths	353
Configuring Advertised Paths	354

Configuring Additional Path Selection	355
Configuring eBGP	356
Disabling eBGP Single-Hop Checking	356
Configuring TTL Security Hops	357
Configuring eBGP Multihop	359
Disabling a Fast External Fallover	359
Limiting the AS-path Attribute	360
Configuring Local AS Support	360
Configuring AS Confederations	361
Configuring Route Reflector	362
Configuring Next-Hops on Reflected Routes Using an Outbound Route-Map	364
Configuring Route Dampening	366
Configuring Load Sharing and ECMP	367
Unequal Cost Multipath (UCMP) over BGP	367
Enabling UCMP over BGP	368
Guidelines and Limitations for UCMP over BGP	368
Configuring Maximum Prefixes	368
Configuring DSCP	369
Configuring Dynamic Capability	369
Configuring Aggregate Addresses	370
Suppressing BGP Routes	371
Configuring BGP Conditional Advertisement	371
Configuring Route Redistribution	373
DMZ Link Bandwidth	375
Guidelines and Limitations	375
Configuring BGP DMZ Link Bandwidth	376
Configuration Examples for BGP DMZ Link Bandwidth	378
Configuring Unequal Cost Multipath (UCMP) Using Link Bandwidth Extended Community	379
Configuration Example	381
Verifying Configuration	385
Advertising the Default Route	386
Configuring BGP Attribute Filtering and Error Handling	387
Treating as Withdraw Path Attributes from a BGP Update Message	387
Discarding Path Attributes from a BGP Update Message	388

Enabling or Disabling Enhanced Attribute Error Handling	388
Displaying Discarded or Unknown Path Attributes	389
Tuning BGP	390
Configuring Policy-Based Administrative Distance	394
Configuring Multiprotocol BGP	396
Configuring BMP	397
BGP Local Route Leaking	400
About BGP Local Route Leaking	400
Guidelines and Limitations for BGP Local Route Leaking	400
Configuring Routes Imported from a VPN to Leak into the Default VRF	400
Configuring Routes Leaked from the Default-VRF to Export to a VPN	401
Configuring Routes Imported from a VPN to Export to a VRF	402
Configuring Routes Imported from a VRF to Export to a VPN	403
Configuration Examples	404
Displaying BGP Local Route Leaking Information	407
BGP Graceful Shutdown	407
About BGP Graceful Shutdown	407
Graceful Shutdown Aware and Activate	408
Graceful Shutdown Contexts	408
Graceful Shutdown with Route Maps	409
Guidelines and Limitations	410
Graceful Shutdown Task Overview	411
Configuring Graceful Shutdown on a Link	411
Filtering BGP Routes and Setting Local Preference Based On GRACEFUL_SHUTDOWN Communities	412
Configuring Graceful Shutdown for All BGP Neighbors	414
Controlling the Preference for All Routes with the GRACEFUL_SHUTDOWN Community	415
Preventing Sending the GRACEFUL_SHUTDOWN Community to a Peer	416
Displaying Graceful Shutdown Information	416
Graceful Shutdown Configuration Examples	417
Configuring a Graceful Restart	419
Configuring Virtualization	422
Verifying the Advanced BGP Configuration	423
Monitoring BGP Statistics	425

Configuration Examples	426
Related Topics	426
Additional References	427
MIBs	427

CHAPTER 12

Configuring RIP	429
About RIP	429
RIP Overview	429
RIPv2 Authentication	430
Split Horizon	430
Route Filtering	430
Route Summarization	430
Route Redistribution	431
Load Balancing	431
High Availability for RIP	431
Virtualization Support for RIP	431
Prerequisites for RIP	431
Guidelines and Limitations for RIP	432
Default Settings for RIP Parameters	432
Configuring RIP	432
Enabling RIP	432
Creating a RIP Instance	433
Restarting a RIP Instance	435
Configuring RIP on an Interface	435
Configuring RIP Authentication	436
Configuring a Passive Interface	437
Configuring Split Horizon with Poison Reverse	438
Configuring Route Summarization	438
Configuring Route Redistribution	439
Configuring Cisco NX-OS RIP for Compatibility with Cisco IOS RIP	440
Configuring Virtualization	442
Tuning RIP	444
Verifying the RIP Configuration	445
Displaying RIP Statistics	446

Configuration Examples for RIP 446

Related Topics 447

CHAPTER 13**Configuring RIPng 449**

About RIPng 449

RIPng Overview 449

Split Horizon 450

Route Filtering 450

Load Balancing 450

Default Information Origination and Generation 450

High Availability for RIPng 451

Virtualization Support for RIPng 451

Prerequisites for RIPng 451

Guidelines and Limitations for RIPng 451

Default Settings for RIPng Parameters 452

Configuring RIPng 452

Enabling RIPng 452

Creating an RIPng Instance 453

Restarting an RIPng Instance 454

Configuring RIPng on an Interface 455

Configuring Split Horizon with Poison Reverse 456

Configuring Cisco NX-OS RIPng for Compatibility with Cisco IOS RIPng 456

Configuring Virtualization 457

Tuning RIPng 460

Verifying the RIPng Configuration 461

Displaying RIPng Statistics 461

Configuration Examples for RIPng 461

Related Topics 462

CHAPTER 14**Configuring Static Routing 463**

About Static Routing 463

Administrative Distance 463

Directly Connected Static Routes 464

Fully Specified Static Routes 464

Floating Static Routes	464
Remote Next Hops for Static Routes	464
BFD	464
Virtualization Support	465
Prerequisites for Static Routing	465
Default Settings	465
Configuring Static Routing	465
Configuring a Static Route	465
Configuring a Static Route Over a VLAN	466
Configuring Virtualization	468
Verifying the Static Routing Configuration	469
Configuration Example for Static Routing	470

CHAPTER 15
Configuring Layer 3 Virtualization 471

About Layer 3 Virtualization	471
VRF and Routing	472
Route Leaking and Importing Routes from the Default VRF	473
BGP VRF Router-ID for IPv6 Only Environments	473
VRF-Aware Services	473
Reachability	474
Filtering	475
Combining Reachability and Filtering	475
Prerequisites for VRF	475
Guidelines and Limitations for VRFs	475
Guidelines and Limitations for VRF Route Leaking	476
Default Settings	477
Configuring VRFs	477
Creating a VRF	477
Assigning VRF Membership to an Interface	478
Configuring VRF Parameters for a Routing Protocol	480
Configuring a VRF-Aware Service	482
Setting the VRF Scope	483
Verifying the VRF Configuration	484
Configuration Examples for VRFs	484

Additional References	491
Related Documents for VRFs	491
Standards	491

CHAPTER 16

Managing the Unicast RIB and FIB	493
About the Unicast RIB and FIB	493
Layer 3 Consistency Checker	494
Guidelines and Limitations for the Unicast RIB	494
Managing the Unicast RIB and FIB	495
Displaying Module FIB Information	495
Configuring Load Sharing in the Unicast FIB	495
Dynamic Load Balancing	498
About Dynamic Load Balancing	498
Key Concepts of Dynamic Load Balancing	500
Guidelines and Limitations for Dynamic Load Balancing	501
Configure Dynamic Load Balancing	503
Configuration Example for Dynamic Load Balancing	507
Verify Dynamic Load Balancing	507
Troubleshoot Dynamic Load Balancing	508
Displaying Routing and Adjacency Information	509
Triggering the Layer 3 Consistency Checker	510
Clearing Forwarding Information in the FIB	511
Configuring Maximum Routes for the Unicast RIB	511
Estimating Memory Requirements for Routes	512
Clearing Routes in the Unicast RIB	513
Verifying the Unicast RIB and FIB Configuration	514
Additional References	514
Related Documents	514

CHAPTER 17

Configuring Route Policy Manager	515
About Route Policy Manager	515
Prefix Lists	515
MAC Lists	516
Route Maps	516

Default Action for Sequences in a Route Map	516
Default Sequence Number for a Route Map	517
Match Criteria	517
Set Changes	517
Access Lists	517
AS Numbers for BGP	518
AS-Path Lists for BGP	518
Community Lists for BGP	518
Extended Community Lists for BGP	518
Configuring NX-OS BGP Large Communities	519
Route Redistribution and Route Maps	524
Guidelines and Limitations for Route Policy Manager	524
Default Settings for Route Policy Manager Parameters	525
Configuring Route Policy Manager	526
Configuring IP Prefix Lists	526
Configuring MAC Lists	528
Configuring AS-path Lists	529
Replacing BGP AS-path Attribute	530
Replacing the Complete AS-path	531
Replacing Selected AS Numbers in the AS-path	532
Configuring Community Lists	533
Configuring Extended Community Lists	535
Configuring Route Maps	537
Global Commands to Block the Deletion of Route-Map	544
Verifying the Route Policy Manager Configuration	545
Configuration Examples for Route Policy Manager	545
Related Topics	545

CHAPTER 18

Configuring Policy-Based Routing	547
About Policy-Based Routing	547
Policy Route Maps	547
Set Criteria for Policy-Based Routing	548
Route Map Support Matrix for Policy-Based Routing	548
Route-Map Processing Logic	549

Prerequisites for Policy-Based Routing	550
Guidelines and Limitations for Policy-Based Routing	550
Default Settings for Policy-Based Routing	553
Configuring Policy-Based Routing	553
Enabling the Policy-Based Routing Feature	553
Enabling the Policy-Based Routing over ECMP	554
Configuring PBR Fast Convergence	555
Configuring a Route Policy	556
Redirecting Default Route Match to Next-Hop	560
Verifying the Policy-Based Routing Configuration	562
Configuration Examples for Policy-Based Routing	562
Related Documents for Policy-Based Routing	566

CHAPTER 19

Configuring HSRP	567
About HSRP	567
HSRP Overview	568
HSRP Versions	569
HSRP for IPv4	569
HSRP for IPv6	570
HSRP for IPv6 Addresses	570
HSRP Subnet VIP	571
HSRP Authentication	571
HSRP Messages	571
HSRP Load Sharing	572
Object Tracking and HSRP	572
vPCs and HSRP	573
vPC Peer Gateway and HSRP	573
BFD	573
High Availability and Extended Nonstop Forwarding	573
Virtualization Support	574
Prerequisites for HSRP	574
Guidelines and Limitations for HSRP	574
Default Settings for HSRP Parameters	576
Configuring HSRP	576

Enabling HSRP	576
Configuring the HSRP Version	576
Configuring an HSRP Group for IPv4	577
Configuring an HSRP Group for IPv6	579
Configuring the HSRP Virtual MAC Address	581
Authenticating HSRP	581
Configuring HSRP Object Tracking	583
Configuring the HSRP Priority	585
Customizing HSRP in HSRP Configuration Mode	586
Customizing HSRP in Interface Configuration Mode	587
Configuring Extended Hold Timers for HSRP	588
Verifying the HSRP Configuration	589
Configuration Examples for HSRP	590
Additional References	591
Related Documents	591
MIBs	591

CHAPTER 20

Configuring VRRP	593
About VRRP	593
VRRP Operation	593
VRRP Benefits	595
Multiple VRRP Groups	595
VRRP Router Priority and Preemption	596
vPCs and VRRP	597
VRRP Advertisements	597
VRRP Authentication	597
VRRP Tracking	597
BFD for VRRP	598
Information About VRRPv3 and VRRS	598
VRRPv3 Benefits	599
VRRPv3 Object Tracking	599
High Availability	599
Virtualization Support	599
Guidelines and Limitations for VRRP	599

Guidelines and Limitations for VRRPv3	600
Default Settings for VRRP Parameters	601
Default Settings for VRRPv3 Parameters	601
Configuring VRRP	601
Enabling VRRP	601
Configuring VRRP Groups	602
Configuring VRRP Priority	603
Configuring VRRP Authentication	605
Configuring Time Intervals for Advertisement Packets	606
Disabling Preemption	608
Configuring VRRP Interface State Tracking	609
Configuring VRRP Object Tracking	610
Configuring VRRPv3	612
Enabling VRRPv3 and VRRS	612
Creating VRRPv3 Groups	612
Configuring VRRPv3 Control Groups	615
Configuring VRRPv3 Object Tracking	616
Configuring VRRS Pathways	617
Verifying the VRRP Configuration	619
Verifying the VRRPv3 Configuration	619
Monitoring and Clearing VRRP Statistics	619
Monitoring and Clearing VRRPv3 Statistics	620
Configuration Examples for VRRP	620
Configuration Examples for VRRPv3	621
Additional References	623
Related Documents for VRRP	623

CHAPTER 21

Configuring Object Tracking	625
Information About Object Tracking	625
Object Tracking Overview	625
Object Track List	626
High Availability	626
Virtualization Support	627
Configuration Examples for Object Tracking	627

Guidelines and Limitations for Object Tracking 627

Default Settings 627

Configuring Object Tracking 627

 Configuring Object Tracking for an Interface 627

 Deleting a Tracking Object 629

 Configuring Object Tracking for Route Reachability 629

 Configuring an Object Track List with a Boolean Expression 630

 Configuring an Object Track List with a Percentage Threshold 632

 Configuring an Object Track List with a Weight Threshold 633

 Configuring an Object Tracking Delay 634

 Configuring Object Tracking for a Nondefault VRF 636

Verifying the Object Tracking Configuration 638

Configuration Examples for Object Tracking 638

Related Topics 638

Additional References 638

 Related Documents 638

APPENDIX A IETF RFCs Supported by Cisco NX-OS Unicast Features 641

 BGP RFCs 641

 First-Hop Redundancy Protocols RFCs 642

 IP Services RFCs 643

 IPv6 RFCs 643

 IS-IS RFCs 644

 OSPF RFCs 644

 RIP RFCs 645

APPENDIX B Configuration Limits for Cisco NX-OS Layer 3 Unicast Features 647

 Configuration Limits for Cisco NX-OS Layer 3 Unicast Features 647



Preface

This preface includes the following sections:

- [Audience, on page xxix](#)
- [Document Conventions, on page xxix](#)
- [Related Documentation for Cisco Nexus 9000 Series Switches, on page xxx](#)
- [Documentation Feedback, on page xxx](#)
- [Communications, Services, and Additional Information, on page xxx](#)

Audience

This publication is for network administrators who install, configure, and maintain Cisco Nexus switches.

Document Conventions

Command descriptions use the following conventions:

Convention	Description
bold	Bold text indicates the commands and keywords that you enter literally as shown.
<i>Italic</i>	Italic text indicates arguments for which you supply the values.
[x]	Square brackets enclose an optional element (keyword or argument).
[x y]	Square brackets enclosing keywords or arguments that are separated by a vertical bar indicate an optional choice.
{x y}	Braces enclosing keywords or arguments that are separated by a vertical bar indicate a required choice.
[x {y z}]	Nested set of square brackets or braces indicate optional or required choices within optional or required elements. Braces and a vertical bar within square brackets indicate a required choice within an optional element.

Convention	Description
<i>variable</i>	Indicates a variable for which you supply values, in context where italics cannot be used.
string	A nonquoted set of characters. Do not use quotation marks around the string or the string includes the quotation marks.

Examples use the following conventions:

Convention	Description
<code>screen font</code>	Terminal sessions and information the switch displays are in screen font.
boldface screen font	Information that you must enter is in boldface screen font.
<i>italic screen font</i>	Arguments for which you supply values are in italic screen font.
<>	Nonprinting characters, such as passwords, are in angle brackets.
[]	Default responses to system prompts are in square brackets.
!, #	An exclamation point (!) or a pound sign (#) at the beginning of a line of code indicates a comment line.

Related Documentation for Cisco Nexus 9000 Series Switches

The entire Cisco Nexus 9000 Series switch documentation set is available at the following URL:

https://www.cisco.com/en/US/products/ps13386/tsd_products_support_series_home.html

Documentation Feedback

To provide technical feedback on this document, or to report an error or omission, please send your comments to nexus9k-docfeedback@cisco.com. We appreciate your feedback.

Communications, Services, and Additional Information

- To receive timely, relevant information from Cisco, sign up at [Cisco Profile Manager](#).
- To get the business impact you're looking for with the technologies that matter, visit [Cisco Services](#).
- To submit a service request, visit [Cisco Support](#).
- To discover and browse secure, validated enterprise-class apps, products, solutions, and services, visit [Cisco DevNet](#).
- To obtain general networking, training, and certification titles, visit [Cisco Press](#).
- To find warranty information for a specific product or product family, access [Cisco Warranty Finder](#).

Cisco Bug Search Tool

[Cisco Bug Search Tool](#) (BST) is a gateway to the Cisco bug-tracking system, which maintains a comprehensive list of defects and vulnerabilities in Cisco products and software. The BST provides you with detailed defect information about your products and software.

Documentation Feedback

To provide feedback about Cisco technical documentation, use the feedback form available in the right pane of every online document.



CHAPTER 1

New and Changed Information

- [New and Changed Information](#), on page 1

New and Changed Information

Table 1: New and Changed Features

Feature	Description	Changed in Release	Where Documented
ECMP Dynamic Load Balancing (DLB)	Provides for Layer 3 ECMP dynamic load balancing based on current load on the link	10.5(1)F	Dynamic Load Balancing , on page 498
ECMP Dynamic Load Balancing Static Pinning	Support static-pinning where a source port can be pinned to a destination port which is part of a DLB Enabled ECMP Group. All the traffic from this source port will be sent to the pinned destination port.	10.5(1)F	Dynamic Load Balancing , on page 498
Exclude-L3-Proto in ECMP hashing	Added the exclude-l3-proto option to the ip load-sharing address command to allow the exclusion of the IP protocol from ECMP hashing during next-hop selection on Cisco Nexus 9300-GX2 Series switches.	10.5(1)F	Configuring Load Sharing in the Unicast FIB , on page 495

Feature	Description	Changed in Release	Where Documented
Detailed information added in show commands for routes advertised to or received from a specific neighbor.	Added the detail to the show bgp {ipv4 ipv6} neighbors {<ip-address> <ipv6-prefix>} routes {advertised received} [vrf <vrf-name>] detailed information of all routes advertised to or received from a specific neighbor.	10.5(1)F	Configuring Basic BGP, on page 281
Unequal Cost Multi Path Load balancing with BGP Link bandwidth Extended Community attribute	Added new features to support Unequal Cost Multi Path Load balancing with BGP Link bandwidth Extended Community attribute.	10.5(1)F	DMZ Link Bandwidth, on page 375



CHAPTER 2

Overview

This chapter contains the following sections:

- [Licensing Requirements, on page 3](#)
- [Supported Platforms, on page 3](#)
- [Information About Layer 3 Unicast Routing, on page 3](#)
- [Routing Algorithms, on page 9](#)
- [Layer 3 Virtualization, on page 11](#)
- [Cisco NX-OS Forwarding Architecture, on page 12](#)
- [Summary of Layer 3 Unicast Routing Features, on page 13](#)
- [Related Topics, on page 16](#)

Licensing Requirements

For a complete explanation of Cisco NX-OS licensing recommendations and how to obtain and apply licenses, see the [Cisco NX-OS Licensing Guide](#) and the [Cisco NX-OS Licensing Options Guide](#).

Supported Platforms

Starting with Cisco NX-OS release 7.0(3)I7(1), use the [Nexus Switch Platform Support Matrix](#) to know from which Cisco NX-OS releases various Cisco Nexus 9000 and 3000 switches support a selected feature.

Information About Layer 3 Unicast Routing

Layer 3 unicast routing involves two basic activities: determining optimal routing paths and packet switching. You can use routing algorithms to calculate the optimal path from the router to a destination. This calculation depends on the algorithm selected, route metrics, and other considerations such as load balancing and alternate path discovery.

Routing Fundamentals

Routing protocols use a metric to evaluate the best path to the destination. A metric is a standard of measurement, such as a path bandwidth, that routing algorithms use to determine the optimal path to a

destination. To aid path determination, routing algorithms initialize and maintain routing tables that contain route information such as the IP destination address, the address of the next router, or the next hop. Destination and next-hop associations tell a router that an IP destination can be reached optimally by sending the packet to a particular router that represents the next hop on the way to the final destination. When a router receives an incoming packet, it checks the destination address and attempts to associate this address with the next hop. See the [Unicast RIB](#) section for more information about the route table.

Routing tables can contain other information, such as the data about the desirability of a path. Routers compare metrics to determine optimal routes, and these metrics differ depending on the design of the routing algorithm used. See the [Routing Metrics](#) section.

Routers communicate with one another and maintain their routing tables by transmitting a variety of messages. The routing update message is one such message that consists of all or a portion of a routing table. By analyzing routing updates from all other routers, a router can build a detailed picture of the network topology. A link-state advertisement, which is another example of a message sent between routers, informs other routers of the link state of the sending router. You can also use link information to enable routers to determine optimal routes to network destinations. For more information, see the [Routing Algorithms](#) section.

Packet Switching

In packet switching, a host determines that it must send a packet to another host. Having acquired a router address by some means, the source host sends a packet that is addressed specifically to the router physical (Media Access Control [MAC]-layer) address but with the IP (network layer) address of the destination host.

The router examines the destination IP address and tries to find the IP address in the routing table. If the router does not know how to forward the packet, it typically drops the packet. If the router knows how to forward the packet, it changes the destination MAC address to the MAC address of the next-hop router and transmits the packet.

The next hop might be the ultimate destination host or another router that executes the same switching decision process. As the packet moves through the internetwork, its physical address changes, but its protocol address remains constant (see the following figure).

Figure 1: Packet Header Updates Through a Network

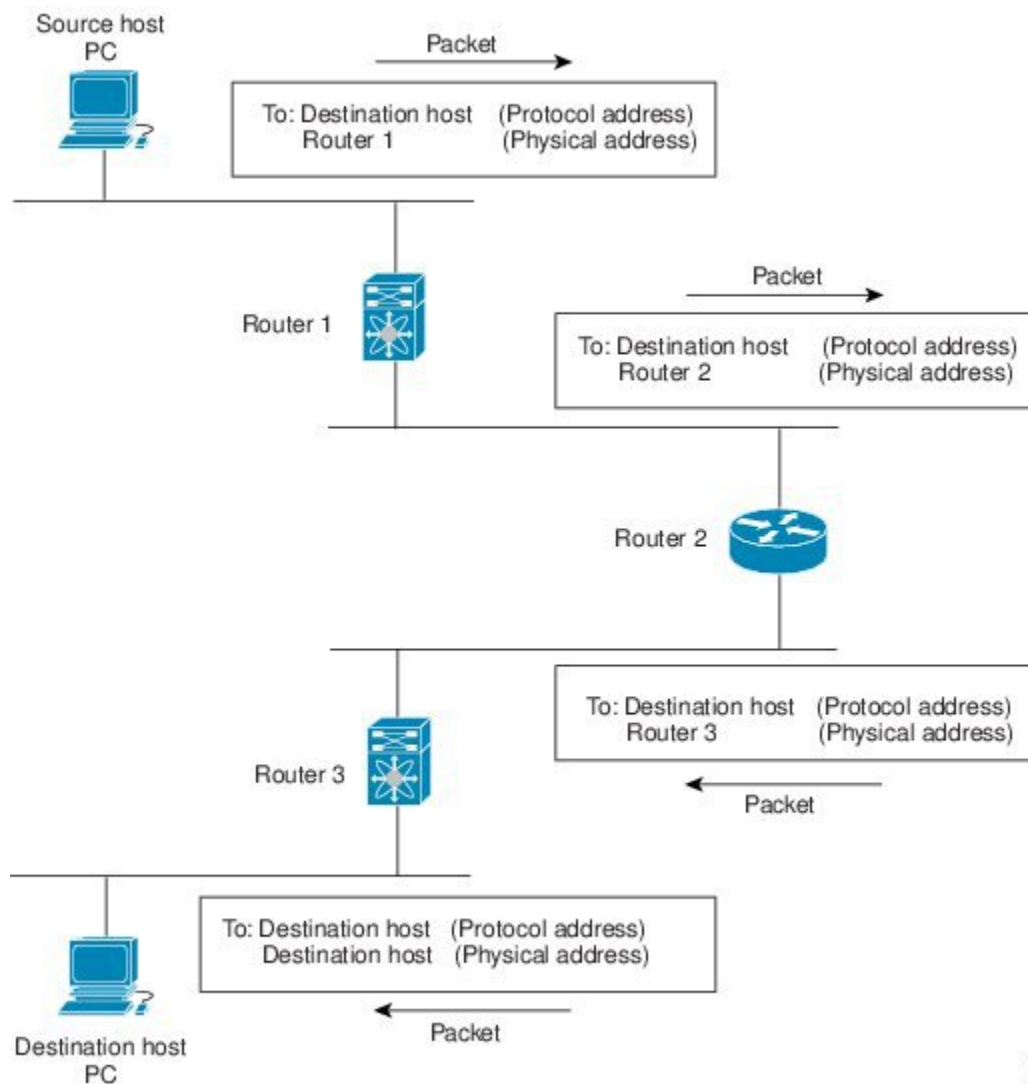

18-2978

Routing Metrics

Routing algorithms use many different metrics to determine the best route. Sophisticated routing algorithms can base route selection on multiple metrics.

Path Length

The path length is the most common routing metric. Some routing protocols allow you to assign arbitrary costs to each network link. In this case, the path length is the sum of the costs associated with each link traversed. Other routing protocols define the hop count, which is a metric that specifies the number of passes through internetworking products, such as routers, that a packet must take from a source to a destination.

Reliability

The reliability, in the context of routing algorithms, is the dependability (in terms of the bit-error rate) of each network link. Some network links might go down more often than others. After a network fails, certain network links might be repaired more easily or more quickly than other links. The reliability factors that you can take into account when assigning the reliability rating are arbitrary numeric values that you usually assign to network links.

Routing Delay

The routing delay is the length of time required to move a packet from a source to a destination through the internetwork. The delay depends on many factors, including the bandwidth of intermediate network links, the port queues at each router along the way, the network congestion on all intermediate network links, and the physical distance that the packet must travel. Because the routing delay is a combination of several important variables, it is a common and useful metric.

Bandwidth

The bandwidth is the available traffic capacity of a link. For example, a 10-Gigabit Ethernet link is preferable to a 1-Gigabit Ethernet link. Although the bandwidth is the maximum attainable throughput on a link, routes through links with greater bandwidth do not necessarily provide better routes than routes through slower links. For example, if a faster link is busier, the actual time required to send a packet to the destination could be greater.

Load

The load is the degree to which a network resource, such as a router, is busy. You can calculate the load in a variety of ways, including CPU usage and packets processed per second. Monitoring these parameters on a continual basis can be resource intensive.

Communication Cost

The communication cost is a measure of the operating cost to route over a link. The communication cost is another important metric, especially if you do not care about performance as much as operating expenditures. For example, the line delay for a private line might be longer than a public line, but you can send packets over your private line rather than through the public lines that cost money for usage time.

Router IDs

Each routing process has an associated router ID. You can configure the router ID to any interface in the system. If you do not configure the router ID, Cisco NX-OS selects the router ID based on the following criteria:

- Cisco NX-OS prefers loopback0 over any other interface. If loopback0 does not exist, then Cisco NX-OS prefers the first loopback interface over any other interface type.
- If you have not configured a loopback interface, Cisco NX-OS uses the first interface in the configuration file as the router ID. If you configure any loopback interface after Cisco NX-OS selects the router ID, the loopback interface becomes the router ID. If the loopback interface is not loopback0 and you configure loopback0 with an IP address, the router ID changes to the IP address of loopback0.
- If the interface that the router ID is based on changes, that new IP address becomes the router ID. If any other interface changes its IP address, there is no router ID change.

Autonomous Systems

An autonomous system (AS) is a network controlled by a single technical administration entity. Autonomous systems divide global external networks into individual routing domains, where local routing policies are applied. This organization simplifies routing domain administration and simplifies consistent policy configuration.

Each autonomous system can support multiple interior routing protocols that dynamically exchange routing information through route redistribution. The Regional Internet Registries (RIR) assign a unique number to each public autonomous system that directly connects to the Internet. This autonomous system number (AS number) identifies both the routing process and the autonomous system.

The Border Gateway Protocol (BGP) supports 4-byte AS numbers that can be represented in asplain and asdot notations:

- asplain—A decimal value notation where both 2-byte and 4-byte AS numbers are represented by their decimal value. For example, 65526 is a 2-byte AS number, and 234567 is a 4-byte AS number.
- asdot—An AS dot notation where 2-byte AS numbers are represented by their decimal value and 4-byte AS numbers are represented by a dot notation. For example, 2-byte AS number 65526 is represented as 65526, and 4-byte AS number 65546 is represented as 1.10.

The BGP 4-byte AS number capability is used to propagate 4-byte-based AS path information across BGP speakers that do not support 4-byte AS numbers.



Note RFC 5396 is partially supported. The asplain and asdot notations are supported, but the asdot+ notation is not.

Private autonomous system numbers are used for internal routing domains but must be translated by the router for traffic that is routed out to the Internet. You should not configure routing protocols to advertise private autonomous system numbers to external networks. By default, Cisco NX-OS does not remove private autonomous system numbers from routing updates.



Note The autonomous system number assignment for public and private networks is governed by the Internet Assigned Number Authority (IANA). For information about autonomous system numbers, including the reserved number assignment, or to apply to register an autonomous system number, see this URL: <http://www.iana.org/>

Convergence

A key aspect to measure for any routing algorithm is how much time a router takes to react to network topology changes. When a part of the network changes for any reason, such as a link failure, the routing information in different routers might not match. Some routers will have updated information about the changed topology, while other routers will still have the old information. The convergence is the amount of time before all routers in the network have updated, matching routing information. The convergence time varies depending on the routing algorithm. Fast convergence minimizes the chance of lost packets caused by inaccurate routing information.

Load Balancing and Equal Cost Multipath

Routing protocols can use load balancing or equal cost multipath (ECMP) to share traffic across multiple paths. When a router learns multiple routes to a specific network, it installs the route with the lowest administrative distance in the routing table. If the router receives and installs multiple paths with the same administrative distance and cost to a destination, load balancing can occur. Load balancing distributes the traffic across all the paths, sharing the load. The number of paths used is limited by the number of entries that the routing protocol puts in the routing table. For the number of ECMP paths supported by each routing protocol, see the Cisco Nexus 9000 Series NX-OS Verified Scalability Guide.



Note ECMP does not guarantee equal load-balancing across all links. It guarantees only that a particular flow will choose one particular next hop at any point in time.

Route Redistribution Overview

If you have multiple routing protocols configured in your network, you can configure these protocols to share routing information by configuring route redistribution in each protocol. For example, you can configure the Open Shortest Path First (OSPF) protocol to advertise routes learned from the Border Gateway Protocol (BGP). You can also redistribute static routes into any dynamic routing protocol. The router that is redistributing routes from another protocol sets a fixed route metric for those redistributed routes, which prevents incompatible route metrics between the different routing protocols. For example, routes redistributed from EIGRP into OSPF are assigned a fixed link cost metric that OSPF understands.



Note You are required to use route maps when you configure the redistribution of routing information.

Route redistribution also uses an administrative distance (see the [Administrative Distance](#) section) to distinguish between routes learned from two different routing protocols. The preferred routing protocol is given a lower administrative distance so that its routes are picked over routes from another protocol with a higher administrative distance assigned.

Administrative Distance

An administrative distance is a rating of the trustworthiness of a routing information source. A higher value indicates a lower trust rating. Typically, a route can be learned through more than one protocol. Administrative distance is used to discriminate between routes learned from more than one protocol. The route with the lowest administrative distance is installed in the IP routing table.

Stub Routing

You can use stub routing in a hub-and-spoke network topology, where one or more end (stub) networks are connected to a remote router (the spoke) that is connected to one or more distribution routers (the hub). The remote router is adjacent only to one or more distribution routers. The only route for IP traffic to follow into the remote router is through a distribution router. This type of configuration is commonly used in WAN topologies in which the distribution router is directly connected to a WAN. The distribution router can be connected to many more remote routers. Often, the distribution router is connected to 100 or more remote

routers. In a hub-and-spoke topology, the remote router must forward all nonlocal traffic to a distribution router, so it becomes unnecessary for the remote router to hold a complete routing table. Generally, the distribution router sends only a default route to the remote router.

Only specified routes are propagated from the remote (stub) router. The stub router responds to all queries for summaries, connected routes, redistributed static routes, external routes, and internal routes with the message “inaccessible.” A router that is configured as a stub sends a special peer information packet to all neighboring routers to report its status as a stub router.

Any neighbor that receives a packet that informs it of the stub status does not query the stub router for any routes, and a router that has a stub peer does not query that peer. The stub router depends on the distribution router to send the proper updates to all peers.

The following figure shows a simple hub-and-spoke configuration.

Figure 2: Simple Hub-and-Spoke Network

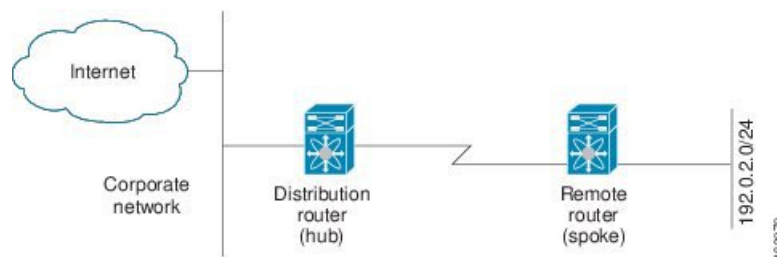

Stub routing does not prevent routes from being advertised to the remote router. The figure **Simple Hub-and-Spoke Network** shows that the remote router can access the corporate network and the Internet through the distribution router only. A full route table on the remote router, in this example, serves no functional purpose because the path to the corporate network and the Internet is always through the distribution router. A larger route table reduces only the amount of memory required by the remote router. The bandwidth and memory used can be lessened by summarizing and filtering routes in the distribution router. In this network topology, the remote router does not need to receive routes that have been learned from other networks because the remote router must send all nonlocal traffic, regardless of its destination, to the distribution router. To configure a true stub network, you should configure the distribution router to send only a default route to the remote router.

OSPF supports stub areas, and the Enhanced Interior Gateway Routing Protocol (EIGRP) supports stub routers.



Note The EIGRP stub routing feature should be used only on stub devices. A stub device is defined as a device connected to the network core or distribution layer through which core transit traffic should not flow. The only route for IP traffic to follow into the remote router is through a distribution router. A stub device should not have any EIGRP neighbors other than distribution devices. Ignoring this restriction will cause undesirable behavior.

Routing Algorithms

Routing algorithms determine how a router gathers and reports reachability information, how it deals with topology changes, and how it determines the optimal route to a destination. Various types of routing algorithms exist, and each algorithm has a different impact on network and router resources. Routing algorithms use a

variety of metrics that affect calculation of optimal routes. You can classify routing algorithms by type, such as static or dynamic, and interior or exterior.

Static Routes and Dynamic Routing Protocols

Static routes are route table entries that you manually configure. These static routes do not change unless you reconfigure them. Static routes are simple to design and work well in environments where network traffic is relatively predictable and where network design is relatively simple.

Because static routing systems cannot react to network changes, you should not use them for large, constantly changing networks. Most routing protocols today use dynamic routing algorithms that adjust to changing network circumstances by analyzing incoming routing update messages. If the message indicates that a network change has occurred, the routing software recalculates routes and sends out new routing update messages. These messages permeate the network, triggering routers to rerun their algorithms and change their routing tables accordingly.

You can supplement dynamic routing algorithms with static routes where appropriate. For example, you should configure each subnetwork with a static route to the IP default gateway or router of last resort (a router to which all unroutable packets are sent).

Interior and Exterior Gateway Protocols

You can separate networks into unique routing domains or autonomous systems. An autonomous system is a portion of an internetwork under common administrative authority that is regulated by a particular set of administrative guidelines. Routing protocols that route between autonomous systems are called exterior gateway protocols or interdomain protocols. The Border Gateway Protocol (BGP) is an example of an exterior gateway protocol. Routing protocols used within an autonomous system are called interior gateway protocols or intradomain protocols. EIGRP and OSPF are examples of interior gateway protocols.

Distance Vector Protocols

Distance vector protocols use distance vector algorithms (also known as Bellman-Ford algorithms) that call for each router to send all or some portion of its routing table to its neighbors. Distance vector algorithms define routes by distance (for example, the number of hops to the destination) and direction (for example, the next-hop router). These routes are then broadcast to the directly connected neighbor routers. Each router uses these updates to verify and update the routing tables.

To prevent routing loops, most distance vector algorithms use split horizon with poison reverse which means that the routes learned from an interface are set as unreachable and advertised back along the interface that they were learned on during the next periodic update. This process prevents the router from seeing its own route updates coming back.

Distance vector algorithms send updates at fixed intervals but can also send updates in response to changes in route metric values. These triggered updates can speed up the route convergence time. The Routing Information Protocol (RIP) is a distance vector protocol.

Link-State Protocols

The link-state protocols, also known as shortest path first (SPF), share information with neighboring routers. Each router builds a link-state advertisement (LSA) that contains information about each link and directly connected neighbor router.

Each LSA has a sequence number. When a router receives an LSA and updates its link-state database, the LSA is flooded to all adjacent neighbors. If a router receives two LSAs with the same sequence number (from the same router), the router does not flood the last LSA that it received to its neighbors because it wants to prevent an LSA update loop. Because the router floods the LSAs immediately after it receives them, the convergence time for link-state protocols is minimized.

Discovering neighbors and establishing adjacency is an important part of a link state protocol. Neighbors are discovered using special Hello packets that also serve as keepalive notifications to each neighbor router. Adjacency is the establishment of a common set of operating parameters for the link-state protocol between neighbor routers.

The LSAs received by a router are added to the router's link-state database. Each entry consists of the following parameters:

- Router ID (for the router that originated the LSA)
- Neighbor ID
- Link cost
- Sequence number of the LSA
- Age of the LSA entry

The router runs the SPF algorithm on the link-state database, building the shortest path tree for that router. This SPF tree is used to populate the routing table.

In link-state algorithms, each router builds a picture of the entire network in its routing tables. The link-state algorithms send small updates everywhere, while distance vector algorithms send larger updates only to neighboring routers.

Because they converge more quickly, link-state algorithms are less likely to cause routing loops than distance vector algorithms. However, link-state algorithms require more CPU power and memory than distance vector algorithms and they can be more expensive to implement and support. Link-state protocols are generally more scalable than distance vector protocols.

OSPF is an example of a link-state protocol.

Layer 3 Virtualization

Cisco NX-OS supports multiple virtual routing and forwarding (VRF) instances and multiple Routing Information Bases (RIBs) to support multiple address domains. Each VRF is associated with a RIB, and this information is collected by the Forwarding Information Base (FIB). A VRF represents a Layer 3 addressing domain. Each Layer 3 interface (logical or physical) belongs to one VRF. For more information, see [Configuring Layer 3 Virtualization](#).

Cisco NX-OS can segment operating system and hardware resources into virtual device contexts (VDCs) that emulate virtual devices. The Cisco Nexus 9000 Series switches currently do not support multiple VDCs. All switch resources are managed in the default VDC.

Cisco NX-OS Forwarding Architecture

The Cisco NX-OS forwarding architecture is responsible for processing all routing updates and populating the forwarding information to all modules in the chassis.

Unicast RIB

The Cisco NX-OS forwarding architecture consists of multiple components, as shown in the following figure.

Figure 3: Cisco NX-OS Forwarding Architecture

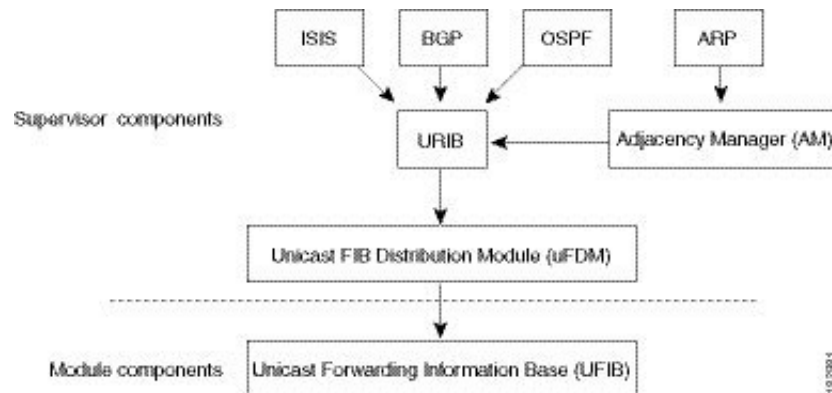

The unicast RIB exists on the active supervisor. It maintains the routing table with directly connected routes, static routes, and routes learned from dynamic unicast routing protocols. The unicast RIB also collects adjacency information from sources such as the Address Resolution Protocol (ARP). The unicast RIB determines the best next hop for a given route and populates the FIB by using the services of the unicast FIB Distribution Module (FDM).

Each dynamic routing protocol must update the unicast RIB for any route that has timed out. The unicast RIB then deletes that route and recalculates the best next hop for that route (if an alternate path is available).

Adjacency Manager

The adjacency manager exists on the active supervisor and maintains adjacency information for different protocols including ARP, Neighbor Discovery Protocol (NDP), and static configuration. The most basic adjacency information is the Layer 3 to Layer 2 address mapping discovered by these protocols. Outgoing Layer 2 packets use the adjacency information to complete the Layer 2 header.

The adjacency manager can trigger ARP requests to find a particular Layer 3 to Layer 2 mapping. The new mapping becomes available when the corresponding ARP reply is received and processed. For IPv6, the adjacency manager finds the Layer 3 to Layer 2 mapping information from NDP. For more information, see [Configuring IPv6, on page 51](#).

Unicast Forwarding Distribution Module

The unicast Forwarding Distribution Module (FDM) exists on the active supervisor and distributes the forwarding path information from the unicast RIB and other sources. The unicast RIB generates forwarding

information that the unicast FIB programs into the hardware forwarding tables on the standby supervisor and the modules. The unicast FDM also downloads the FIB information to newly inserted modules.

The unicast FDM gathers adjacency information, rewrite information, and other platform-dependent information when updating routes in the unicast FIB. The adjacency and rewrite information consists of interface, next hop, and Layer 3 to Layer 2 mapping information. The interface and next-hop information is received in route updates from the unicast RIB. The Layer 3 to Layer 2 mapping is received from the adjacency manager.

FIB

The unicast FIB exists on supervisors and switching modules and builds the information used for the hardware forwarding engine. The unicast FIB receives route updates from the unicast FDM and sends the information to be programmed in the hardware forwarding engine. The unicast FIB controls the addition, deletion, and modification of routes, paths, and adjacencies.

The unicast FIBs are maintained on a per-VRF and per-address-family basis, that is, one for IPv4 and one for IPv6 for each configured VRF. Based on route update messages, the unicast FIB maintains a per-VRF prefix and next-hop adjacency information database. The next-hop adjacency data structure contains the next-hop IP address and the Layer 2 rewrite information. Multiple prefixes could share a next-hop adjacency information structure.

Hardware Forwarding

Cisco NX-OS supports distributed packet forwarding. The ingress port takes relevant information from the packet header and passes the information to the local switching engine. The local switching engine does the Layer 3 lookup and uses this information to rewrite the packet header. The ingress module forwards the packet to the egress port. If the egress port is on a different module, the packet is forwarded using the switch fabric to the egress module. The egress module does not participate in the Layer 3 forwarding decision.

You also use the **show platform fib** or **show platform forwarding** commands to display details on hardware forwarding.

Software Forwarding

The software forwarding path in Cisco NX-OS is used mainly to handle features that are not supported in the hardware or to handle errors encountered during the hardware processing. Typically, packets with IP options or packets that need fragmentation are passed to the CPU on the active supervisor. All packets that should be switched in the software or terminated go to the supervisor. The supervisor uses the information provided by the unicast RIB and the adjacency manager to make the forwarding decisions. The module is not involved in the software forwarding path.

Software forwarding is controlled by control plane policies and rate limiters. For more information, see the [Cisco NX-OS 9000 Series NX-OS Security Configuration Guide](#).

Summary of Layer 3 Unicast Routing Features

This section provides a brief introduction to the Layer 3 unicast features and protocols supported in Cisco NX-OS.

IPv4 and IPv6

Layer 3 uses either the IPv4 or IPv6 protocol. IPv6 increases the number of network address bits from 32 bits (in IPv4) to 128 bits. For more information, see [Configuring IPv4, on page 17](#) or [Configuring IPv6, on page 51](#).

IP Services

IP Services includes Dynamic Host Configuration Protocol (DHCP) and Domain Name System (DNS Client) clients. For more information, see [Configuring DNS](#).

OSPF

The Open Shortest Path First (OSPF) protocol is a link-state routing protocol used to exchange network reachability information within an autonomous system. Each OSPF router advertises information about its active links to its neighbor routers. Link information consists of the link type, the link metric, and the neighbor router that is connected to the link. The advertisements that contain this link information are called link-state advertisements. For more information, see [Configuring OSPFv2, on page 99](#).

EIGRP

The Enhanced Interior Gateway Routing Protocol (EIGRP) is a unicast routing protocol that has the characteristics of both distance vector and link-state routing protocols. It is an improved version of IGRP, which is a Cisco proprietary routing protocol. EIGRP relies on its neighbors to provide the routes. It constructs the network topology from the routes advertised by its neighbors, similar to a link-state protocol, and uses this information to select loop-free paths to destinations. For more information, see [Configuring EIGRP, on page 209](#).

IS-IS

The Intermediate System-to-Intermediate System (IS-IS) protocol is an intradomain Open System Interconnection (OSI) dynamic routing protocol specified in the International Organization for Standardization (ISO) 10589. The IS-IS routing protocol is a link-state protocol. IS-IS features are as follows:

- Hierarchical routing
- Classless behavior
- Rapid flooding of new information
- Fast Convergence
- Very scalable

For more information, see [Configuring IS-IS, on page 245](#).

BGP

The Border Gateway Protocol (BGP) is an inter-autonomous system routing protocol. A BGP router advertises network reachability information to other BGP routers using Transmission Control Protocol (TCP) as its

reliable transport mechanism. The network reachability information includes the destination network prefix, a list of autonomous systems that needs to be traversed to reach the destination, and the next-hop router. Reachability information contains additional path attributes such as preference to a route, origin of the route, community and others. For more information, see [Configuring Basic BGP, on page 281](#) and [Configuring Advanced BGP, on page 315](#).

RIP

The Routing Information Protocol (RIP) is a distance-vector protocol that uses a hop count as its metric. RIP is widely used for routing traffic in the global Internet and is an Interior Gateway Protocol (IGP), which means that it performs routing within a single autonomous system. For more information, see [Configuring RIP, on page 429](#).

Static Routing

Static routing allows you to enter a fixed route to a destination. This feature is useful for small networks where the topology is simple. Static routing is also used with other routing protocols to control default routes and route distribution. For more information, see [Configuring Static Routing](#).

Layer 3 Virtualization

Virtualization allows you to share physical resources across separate management domains. Cisco NX-OS supports Layer 3 virtualization with virtual routing and forwarding (VRF). VRF provides a separate address domain for configuring Layer 3 routing protocols. For more information, see [Configuring Layer 3 Virtualization](#).

Route Policy Manager

The Route Policy Manager provides a route filtering capability in Cisco NX-OS. It uses route maps to filter routes distributed across various routing protocols and between different entities within a given routing protocol. Filtering is based on specific match criteria, which is similar to packet filtering by access control lists. For more information, see [Configuring Route Policy Manager, on page 515](#).

Policy-Based Routing

Policy-based routing uses the Route Policy Manager to create policy route filters. These policy route filters can forward a packet to a specified next hop based on the source of the packet or other fields in the packet header. Policy routes can be linked to extended IP access lists so that routing might be based on protocol types and port numbers. For more information, see [Configuring Policy-Based Routing](#).

First Hop Redundancy Protocols

First hop redundancy protocols (FHRP), such as the Hot Standby Router Protocol (HSRP) and the Virtual Router Redundancy Protocol (VRRP), allow you to provide redundant connections to your hosts. If an active first-hop router fails, the FHRP automatically selects a standby router to take over. You do not need to update the hosts with new IP addresses because the address is virtual and shared between each router in the FHRP group. For more information on HSRP, see [Configuring HSRP](#). For more information on VRRP, see [Configuring VRRP, on page 593](#).

Object Tracking

Object tracking allows you to track specific objects on the network, such as the interface line protocol state, IP routing, and route reachability, and take action when the tracked object's state changes. This feature allows you to increase the availability of the network and shorten the recovery time if an object state goes down. For more information, see [Configuring Object Tracking](#).

Related Topics

Feature Name	Feature Information
Layer 3 features	<i>Cisco NX-OS 9000 Series NX-OS Multicast Routing Configuration Guide</i> <i>Cisco Cisco NX-OS 9000 Series NX-OS High Availability and Redundancy Guide</i> Exploring Autonomous System Numbers: https://www.iana.org/numbers



CHAPTER 3

Configuring IPv4

This chapter describes how to configure Internet Protocol version 4 (IPv4), which includes addressing, Address Resolution Protocol (ARP), and Internet Control Message Protocol (ICMP), on the Cisco NX-OS device.

This chapter includes the following sections:

- [About IPv4, on page 17](#)
- [Virtualization Support for IPv4, on page 24](#)
- [Prerequisites for IPv4, on page 24](#)
- [Guidelines and Limitations for IPv4, on page 24](#)
- [Default Settings, on page 26](#)
- [Configuring IPv4, on page 27](#)
- [Verifying the IPv4 Configuration, on page 48](#)
- [Additional References, on page 49](#)

About IPv4

You can configure IP on the device to assign IP addresses to network interfaces. When you assign IP addresses, you enable the interfaces and allow communication with the hosts on those interfaces.

You can configure an IP address as primary or secondary on a device. An interface can have one primary IP address and multiple secondary addresses. All networking devices on an interface should share the same primary IP address because the packets that are generated by the device always use the primary IPv4 address. Each IPv4 packet is based on the information from a source or destination IP address. For more information, see the [Multiple IPv4 Addresses](#) section.

You can use a subnet to mask the IP addresses. A mask is used to determine what subnet an IP address belongs to. An IP address contains the network address and the host address. A mask identifies the bits that denote the network number in an IP address. When you use the mask to subnet a network, the mask is then referred to as a subnet mask. Subnet masks are 32-bit values that allow the recipient of IP packets to distinguish the network ID portion of the IP address from the host ID portion of the IP address.

The IP feature is responsible for handling IPv4 packets that terminate in the supervisor module, as well as forwarding of IPv4 packets, which includes IPv4 unicast/multicast route lookup and software access control list (ACL) forwarding. The IP feature also manages the network interface IP address configuration, duplicate address checks, static routes, and packet send/receive interface for IP clients.



Note As Nexus behavior is to drop packets destined to null0 interface, if an IPv4 or IPv6 packet is sent to a null0 interface, Cisco Nexus 3000 switches will not respond with an ICMP or ICMPv6 packet.

Multiple IPv4 Addresses

Cisco NX-OS supports multiple IP addresses per interface. You can specify an unlimited number of secondary addresses for a variety of situations. The most common are as follows:

- When there are not enough host IP addresses for a particular network interface. For example, if your subnetting allows up to 254 hosts per logical subnet, but on one physical subnet you must have 300 host addresses, then you can use secondary IP addresses on the routers or access servers to allow you to have two logical subnets that use one physical subnet.
- Two subnets of a single network might otherwise be separated by another network. You can create a single network from subnets that are physically separated by another network by using a secondary address. In these instances, the first network is extended, or layered on top of the second network. A subnet cannot appear on more than one active interface of the router at a time.



Note If any device on a network segment uses a secondary IPv4 address, all other devices on that same network interface must also use a secondary address from the same network or subnet. The inconsistent use of secondary addresses on a network segment can quickly cause routing loops.

LPM Routing Modes

By default, Cisco NX-OS programs routes in a hierarchical fashion to allow for the longest prefix match (LPM) on the device. However, you can configure the device for different routing modes to support more LPM route entries.

The following tables list the LPM routing modes that are supported on Cisco Nexus 9000 Series switches.

Table 2: LPM Routing Modes for Cisco Nexus 9200 Platform Switches

LPM Routing Mode	CLI Command
Default system routing mode	
LPM dual-host routing mode	system routing template-dual-stack-host-scale
LPM heavy routing mode	system routing template-lpm-heavy



Note Cisco Nexus 9200 platform switches do not support the **system routing template-lpm-heavy** mode for IPv4 Multicast routes. Make sure to reset LPM's maximum limit to 0.

Table 3: LPM Routing Modes for Cisco Nexus 9300 Platform Switches

LPM Routing Mode	Broadcom T2 Mode	CLI Command
Default system routing mode	3	
ALPM routing mode	4	system routing max-mode I3

Table 4: LPM Routing Modes for Cisco Nexus 9300-EX/FX/FX2/FX3/GX Platform Switches

LPM Routing Mode	CLI Command
LPM dual-host routing mode	system routing template-dual-stack-host-scale
LPM heavy routing mode	system routing template-lpm-heavy
LPM Internet-peering mode	system routing template-internet-peering

Table 5: LPM Routing Modes for Cisco Nexus 9500 Platform Switches with 9700-EX and 9700-FX Line Cards

LPM Routing Mode	Broadcom T2 Mode	CLI Command
Default system routing mode	3 (for line cards); 4 (for fabric modules)	
Max-host routing mode	2 (for line cards); 3 (for fabric modules)	system routing max-mode host
Nonhierarchical routing mode	3 (for line cards); 4 with max-I3-mode option (for line cards)	system routing non-hierarchical-routing [max-I3-mode]
64-bit ALPM routing mode	Submode of mode 4 (for fabric modules)	system routing mode hierarchical 64b-alpm
LPM heavy routing mode		system routing template-lpm-heavy Note This mode is supported only for Cisco Nexus 9508 switches with the 9732C-EX line card.

LPM Routing Mode	Broadcom T2 Mode	CLI Command
LPM Internet-peering mode		system routing template-internet-peering Note This mode is supported only for the following Cisco Nexus 9500 Platform Switches: <ul style="list-style-type: none"> • Cisco Nexus 9500 platform switches with 9700-EX line cards. • Cisco Nexus 9500-FX platform switches (Cisco NX-OS release 7.0(3)I7(4) and later) • Cisco 9500-R platform switches (Cisco NX-OS release 9.3(1) and later)
LPM dual-host routing mode		

Table 6: LPM Routing Modes for Cisco Nexus 9500-R Platform Switches with 9600-R Line Cards

LPM Routing Mode	CLI Command
LPM Internet-peering mode	system routing template-internet-peering (Cisco NX-OS release 9.3(1) and later)

Host to LPM Spillover

Beginning with Cisco NX-OS Release 7.0(3)I5(1), host routes can be stored in the LPM table in order to achieve a larger host scale. In ALPM mode, the switch allows fewer host routes. If you add more host routes than the supported scale, the routes that are spilled over from the host table take the space of the LPM routes in the LPM table. The total number of LPM routes allowed in that mode is reduced by the number of host routes stored. This feature is supported on Cisco Nexus 9300 and 9500 platform switches.

In the default system routing mode, Cisco Nexus 9300 platform switches are configured for higher host scale and fewer LPM routes, and the LPM space can be used to store more host routes. For Cisco Nexus 9500 platform switches, only the default system routing and nonhierarchical routing modes support this feature on line cards. Fabric modules do not support this feature.

Address Resolution Protocol

Networking devices and Layer 3 switches use Address Resolution Protocol (ARP) to map IP (network layer) addresses to (Media Access Control [MAC]-layer) addresses to enable IP packets to be sent across networks. Before a device sends a packet to another device, it looks in its own ARP cache to see if there is a MAC address and corresponding IP address for the destination device. If there is no entry, the source device sends a broadcast message to every device on the network.

Each device compares the IP address to its own. Only the device with the matching IP address replies to the device that sends the data with a packet that contains the MAC address for the device. The source device adds

the destination device MAC address to its ARP table for future reference, creates a data-link header and trailer that encapsulates the packet, and proceeds to transfer the data. The following figure shows the ARP broadcast and response process.

Figure 4: ARP Process



When the destination device lies on a remote network that is beyond another device, the process is the same except that the device that sends the data sends an ARP request for the MAC address of the default gateway. After the address is resolved and the default gateway receives the packet, the default gateway broadcasts the destination IP address over the networks connected to it. The device on the destination device network uses ARP to obtain the MAC address of the destination device and delivers the packet. ARP is enabled by default.

The default system-defined CoPP policy rate limits ARP broadcast packets bound for the supervisor module. The default system-defined CoPP policy prevents an ARP broadcast storm from affecting the control plane traffic but does not affect bridged packets.

ARP Caching

ARP caching minimizes broadcasts and limits wasteful use of network resources. The mapping of IP addresses to MAC addresses occurs at each hop (device) on the network for every packet sent over an internetwork, which may affect network performance.

ARP caching stores network addresses and the associated data-link addresses in the memory for a period of time, which minimizes the use of valuable network resources to broadcast for the same address each time that a packet is sent. You must maintain the cache entries that are set to expire periodically because the information might become outdated. Every device on a network updates its tables as addresses are broadcast.

Static and Dynamic Entries in the ARP Cache

Static routing requires that you manually configure the IP addresses, subnet masks, gateways, and corresponding MAC addresses for each interface of each device. Static routing requires more work to maintain the route table. You must update the table each time you add or change routes.

Dynamic routing uses protocols that enable the devices in a network to exchange routing table information with each other. Dynamic routing is more efficient than static routing because the route table is automatically updated unless you add a time limit to the cache. The default time limit is 25 minutes but you can modify the time limit if the network has many routes that are added and deleted from the cache.

Devices That Do Not Use ARP

When a network is divided into two segments, a bridge joins the segments and filters traffic to each segment based on MAC addresses. The bridge builds its own address table, which uses MAC addresses only. A device has an ARP cache that contains both IP addresses and the corresponding MAC addresses.

Passive hubs are central-connection devices that physically connect other devices in a network. They send messages out on all their ports to the devices and operate at Layer 1 but do not maintain an address table.

Layer 2 switches determine which port of a device receives a message that is sent only to that port. However, Layer 3 switches are devices that build an ARP cache (table).

Reverse ARP

Reverse ARP (RARP) as defined by RFC 903 works the same way as ARP, except that the RARP request packet requests an IP address instead of a MAC address. RARP often is used by diskless workstations because this type of device has no way to store IP addresses to use when they boot. The only address that is known is the MAC address because it is burned into the hardware.

Use of RARP requires an RARP server on the same network segment as the router interface. The following figure shows how RARP works.

Figure 5: Reverse ARP

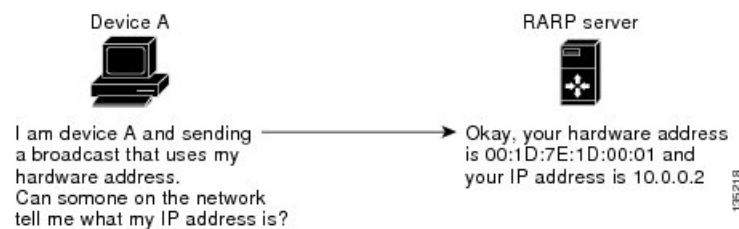

RARP has several limitations. Because of these limitations, most businesses use Dynamic Host Control Protocol (DHCP) to assign IP addresses dynamically. DHCP is cost effective and requires less maintenance than RARP. The following are the most important limitations:

- Because RARP uses hardware addresses, if the internetwork is large with many physical networks, a RARP server must be on every segment with an additional server for redundancy. maintaining two servers for every segment is costly.
- Each server must be configured with a table of static mappings between the hardware addresses and IP addresses. Maintenance of the IP addresses is difficult.
- RARP only provides IP addresses of the hosts and not subnet masks or default gateways.

Proxy ARP

Proxy ARP enables a device that is physically located on one network appear to be logically part of a different physical network connected to the same device or firewall. Proxy ARP allows you to hide a device with a public IP address on a private network behind a router and still have the device appear to be on the public network in front of the router. By hiding its identity, the router accepts responsibility for routing packets to the real destination. Proxy ARP can help devices on a subnet reach remote subnets without configuring routing or a default gateway.

When devices are not in the same data link layer network but in the same IP network, they try to transmit data to each other as if they are on the local network. However, the router that separates the devices does not send a broadcast message because routers do not pass hardware-layer broadcasts and the addresses cannot be resolved.

When you enable proxy ARP on the device and it receives an ARP request, it identifies the request as a request for a system that is not on the local LAN. The device responds as if it is the remote destination for which the broadcast is addressed, with an ARP response that associates the device's MAC address with the remote

destination's IP address. The local device believes that it is directly connected to the destination, while in reality its packets are being forwarded from the local subnetwork toward the destination subnetwork by their local device. By default, proxy ARP is disabled.

Local Proxy ARP

You can use local proxy ARP to enable a device to respond to ARP requests for IP addresses within a subnet where normally no routing is required. When you enable local proxy ARP, ARP responds to all ARP requests for IP addresses within the subnet and forwards all traffic between hosts in the subnet. Use this feature only on subnets where hosts are intentionally prevented from communicating directly by the configuration on the device to which they are connected.

Gratuitous ARP

Gratuitous ARP sends a request with an identical source IP address and a destination IP address to detect duplicate IP addresses. Cisco NX-OS supports enabling or disabling gratuitous ARP requests or ARP cache updates.

Periodic ARP Refresh on MAC Delete

The ARP process tracks the MAC deletes and sends the periodic ARP Refresh on the L3 VLAN interface in a configured interval of time for the configured count. If the MAC is learned, ARP process stops sending the periodic ARP Refreshes.

For more information, see [Configuring Periodic ARP Refresh on MAC Delete for SVIs, on page 40](#).

Glean Throttling

If the Address Resolution Protocol (ARP) request for the next hop is not resolved when incoming IP packets are forwarded in a line card, the line card forwards the packets to the supervisor (glean throttling). The supervisor resolves the MAC address for the next hop and programs the hardware.

When an ARP request is sent, the software adds a /32 drop adjacency in the hardware to prevent the packets to the same next-hop IP address to be forwarded to the supervisor. When the ARP is resolved, the hardware entry is updated with the correct MAC address. If the ARP entry is not resolved before a timeout period, the entry is removed from the hardware.



Note Glean throttling is supported for IPv4 and IPv6, but IPv6 link-local addresses are not supported.

Path MTU Discovery

Path maximum transmission unit (MTU) discovery is a method for maximizing the use of available bandwidth in the network between the endpoints of a TCP connection. It is described in RFC 1191. Existing connections are not affected when this feature is turned on or off.

ICMP

You can use the Internet Control Message Protocol (ICMP) to provide message packets that report errors and other information that is relevant to IP processing. ICMP generates error messages, such as ICMP destination unreachable messages, ICMP Echo Requests (which send a packet on a round trip between two hosts) and Echo Reply messages. ICMP also provides many diagnostic functions and can send and redirect error packets to the host. By default, ICMP is enabled.

Some of the ICMP message types are as follows:

- Network error messages
- Network congestion messages
- Troubleshooting information
- Timeout announcements



Note ICMP redirects are disabled on interfaces where the local proxy ARP feature is enabled.

Virtualization Support for IPv4

IPv4 supports virtual routing and forwarding (VRF) instances.

Prerequisites for IPv4

IPv4 has the following prerequisites:

- IPv4 can only be configured on Layer 3 interfaces.

Guidelines and Limitations for IPv4

IPv4 has the following configuration guidelines and limitations:

- Cisco Nexus 9300-EX and Cisco Nexus 9300-FX2 platform switches configured for internet-peering mode might not have sufficient hardware capacity to install full IPv4 and IPv6 Internet routes simultaneously.
- You can configure a secondary IP address only after you configure the primary IP address.
- Local proxy ARP is not supported for an interface with more than one HSRP group that belongs to multiple subnets.
- The **ip proxy-arp** command is not supported in a VXLAN EVPN Fabric specifically on an SVI which is enabled with **fabric forwarding mode anycast-gateway**.
- For Cisco Nexus 9500 platform switches with -R line cards, internet-peering mode is only intended to be used with the prefix pattern as distributed in the global internet routing table. In this mode, other prefix

distributions/patterns can operate, but not predictably. As a result, maximum achievable LPM/LEM scale is reliable only when the prefix patterns are actual internet prefix patterns. In Internet-peering mode, if route prefix patterns other than those in the global internet routing table are used, the switch might not successfully achieve documented scalability numbers.

- LPM heavy routing mode is supported on Cisco Nexus **9500** series switches with **9700-EX**, **-FX**, and **-GX** series modules.
- Beginning with Cisco NX-OS Release 10.2(3)F, syslog will be printed when IPv4 redirect message is triggered based on the configured interval.
- Beginning with Cisco NX-OS Release 10.3(1)F, static routing is supported on the Cisco Nexus 9808 switches.
- Beginning with Cisco NX-OS Release 10.4(1)F, static routing is supported on the following switches and line cards:
 - Cisco Nexus 9804 switches.
 - Cisco Nexus X98900CD-A, and X9836DM-A line cards with 9804, and 9808 platform switches.
- Beginning with Cisco NX-OS Release 10.3(1)F, dynamic routing is supported on the Cisco Nexus 9808 platform switches.
- Beginning with Cisco NX-OS Release 10.4(1)F, dynamic routing is supported on Cisco Nexus X98900CD-A and X9836DM-A line cards with 9808 and 9804 switches.
- Beginning with Cisco NX-OS Release 10.2(4)M, periodic ARP Refresh on MAC delete support is provided on Cisco Nexus 9000 Series platform switches with the following limitations:
 - During configuration of the **ip arp refresh-adj-on-mac-delete retry** command, ARP process does not trigger Refresh although ARP is learned and MAC is not learned. It tries to send periodic ARP Refreshes on MAC delete/flush.
 - The periodic ARP Refresh behavior is triggered for the MAC's deletion after configuring the **ip arp refresh-adj-on-mac-delete retry** command.
 - The trigger for this periodic ARP Refresh is MAC delete. This feature does not address the MAC learn miss on receiving burst packets.
 - During configuring, you must choose the right count and interval based on the scale/network requirements.
- Beginning with Cisco NX-OS Release 10.4(1)F, out of subnet ARP resolution support is provided on Cisco Nexus 9000 Series platform switches for the following L3 interfaces:
 - Ethernet
 - Sub-interfaces
 - Port-channel
 - FEX
 - IP unnumbered interface

**Note**

- The out of subnet ARP resolution feature is not supported on SVI L3 interfaces and on VPC or HSRP or VXLAN deployments.
-
- Beginning with Cisco NX-OS Release 10.4(2)F, the **ip arp cache intf-limit** configuration is supported to limit the ARP cache entries per interface on Cisco NX-OS devices with the following capabilities:
 - Supported on global and interface modes. However, interface mode configuration takes the precedence over global mode.
 - Supported only on the following L3 interfaces:
 - SVI
 - SVI Unnumbered Interfaces
 - Not supported on the following L3 interfaces:
 - Ethernet
 - Subinterfaces
 - Port-channel
 - Unnumbered interfaces
 - If the configuration is applied to non-supporting interfaces, this configuration will be applied to the global mode.
 - Beginning with Cisco NX-OS Release 10.4(2)F, you can configure all NX-OS features using Class E IP address. If the IPv4 address space is exhausted, you can configure the features using the Class E IP address. The following switches and line cards are supported for Class E IP address:
 - Cisco Nexus 92348GC-X
 - Cisco Nexus 9300-EX/FX/FX2/FX3/H2R/H1/GX/GX2
 - Cisco Nexus 9300C
 - Cisco Nexus 9700-EX/FX/GX line cards

Default Settings

The table below lists the default settings for IP parameters.

Parameters	Default
ARP timeout	1500 seconds
Proxy ARP	Disabled

Configuring IPv4



Note If you are familiar with the Cisco IOS CLI, be aware that the Cisco NX-OS commands for this feature might differ from the Cisco IOS commands that you would use.

Configuring IPv4 Addressing

You can assign a primary IP address for a network interface.

SUMMARY STEPS

1. **configure terminal**
2. **interface ethernet** *number*
3. **ip address** *ip-address/length* [*secondary*]
4. (Optional) **show ip interface**
5. (Optional) **copy running-config startup-config**

DETAILED STEPS

	Command or Action	Purpose
Step 1	configure terminal Example: <pre>switch# configure terminal switch(config)#</pre>	Enters global configuration mode.
Step 2	interface ethernet <i>number</i> Example: <pre>switch(config)# interface ethernet 2/3 switch(config-if)#</pre>	Enters interface configuration mode.
Step 3	ip address <i>ip-address/length</i> [<i>secondary</i>] Example: <pre>switch(config-if)# ip address 192.2.1.1 255.0.0.0</pre>	Specifies a primary or secondary IPv4 address for an interface. <ul style="list-style-type: none"> • The network mask can be a four-part dotted decimal address. For example, 255.0.0.0 indicates that each bit equal to 1 means the corresponding address bit belongs to the network address. • The network mask can be indicated as a slash (/) and a number, which is the prefix length. The prefix length is a decimal value that indicates how many of the high-order contiguous bits of the address comprise the prefix (the network portion of the address). A slash must precede the decimal value and there must be no space between the IP address and the slash.

	Command or Action	Purpose
Step 4	(Optional) show ip interface Example: switch(config-if)# show ip interface	Displays interfaces configured for IPv4.
Step 5	(Optional) copy running-config startup-config Example: switch(config-if)# copy running-config startup-config	Copies the running configuration to the startup configuration.

Configuring Multiple IP Addresses

You can only add secondary IP addresses after you configure primary IP addresses.

SUMMARY STEPS

1. **configure terminal**
2. **interface ethernet** *number*
3. **ip address** *ip-address/length* [*secondary*]
4. (Optional) **show ip interface**
5. (Optional) **copy running-config startup-config**

DETAILED STEPS

	Command or Action	Purpose
Step 1	configure terminal Example: switch# configure terminal switch(config)#	Enters global configuration mode.
Step 2	interface ethernet <i>number</i> Example: switch(config)# interface ethernet 2/3 switch(config-if)#	Enters interface configuration mode.
Step 3	ip address <i>ip-address/length</i> [<i>secondary</i>] Example: switch(config-if)# ip address 192.168.1.1 255.0.0.0 secondary	Specifies a the configured address as a secondary IPv4 address.
Step 4	(Optional) show ip interface Example: switch(config-if)# show ip interface	Displays interfaces configured for IPv4.
Step 5	(Optional) copy running-config startup-config Example:	Saves this configuration change.

	Command or Action	Purpose
	<code>switch(config-if)# copy running-config startup-config</code>	

Configuring Max-Host Routing Mode

By default, Cisco NX-OS programs routes in a hierarchical fashion (with fabric modules that are configured to be in mode 4 and line card modules that are configured to be in mode 3), which allows for longest prefix match (LPM) and host scale on the device.

You can modify the default LPM and host scale to program more hosts in the system, as might be required when the node is positioned as a Layer-2 to Layer-3 boundary node.



Note If you want to further scale the entries in the LPM table, see the [Configuring Nonhierarchical Routing Mode \(Cisco Nexus 9500 Platform Switches Only\)](#) section to configure the device to program all the Layer 3 IPv4 and IPv6 routes on the line cards and none of the routes on the fabric modules.



Note This configuration impacts both the IPv4 and IPv6 address families.



Note For the max-host routing mode scale numbers, refer to the [Cisco Nexus 9000 Series NX-OS Verified Scalability Guide](#).

SUMMARY STEPS

1. **configure terminal**
2. **[no] system routing max-mode host**
3. (Optional) **show forwarding route summary**
4. **copy running-config startup-config**
5. **reload**

DETAILED STEPS

	Command or Action	Purpose
Step 1	configure terminal Example: <code>switch# configure terminal</code> <code>switch(config)#</code>	Enters global configuration mode.
Step 2	[no] system routing max-mode host Example: <code>switch(config)# system routing max-mode host</code>	Puts the line cards in Broadcom T2 mode 2 and the fabric modules in Broadcom T2 mode 3 to increase the number of supported hosts.

	Command or Action	Purpose
Step 3	(Optional) show forwarding route summary Example: switch(config)# show forwarding route summary	Displays the LPM routing mode.
Step 4	copy running-config startup-config Example: switch(config)# copy running-config startup-config	Saves this configuration change.
Step 5	reload Example: switch(config)# reload	Reboots the entire device.

Configuring Nonhierarchical Routing Mode (Cisco Nexus 9500 Platform Switches Only)

If the host scale is small (as in a pure Layer 3 deployment), we recommend programming the longest prefix match (LPM) routes in the line cards to improve convergence performance. Doing so programs routes and hosts in the line cards and does not program any routes in the fabric modules.



Note This configuration impacts both the IPv4 and IPv6 address families.

SUMMARY STEPS

1. **configure terminal**
2. **[no] system routing non-hierarchical-routing [max-l3-mode]**
3. (Optional) **show forwarding route summary**
4. **copy running-config startup-config**
5. **reload**

DETAILED STEPS

	Command or Action	Purpose
Step 1	configure terminal Example: switch# configure terminal switch(config)#	Enters global configuration mode.
Step 2	[no] system routing non-hierarchical-routing [max-l3-mode] Example: switch(config)# system routing non-hierarchical-routing max-l3-mode	Puts the line cards in Broadcom T2 mode 3 (or Broadcom T2 mode 4 if you use the max-l3-mode option) to support a larger LPM scale. As a result, all of the IPv4 and IPv6 routes will be programmed on the line cards rather than on the fabric modules.

	Command or Action	Purpose
Step 3	(Optional) show forwarding route summary Example: <pre>switch(config)# show forwarding route summary Mode 3: 120K IPv4 Host table 16k LPM table (> 65 < 127 1k entry reserved) Mode 4: 16k V4 host/4k V6 host 128k v4 LPM/20K V6 LPM</pre>	Displays the LPM mode.
Step 4	copy running-config startup-config Example: <pre>switch(config)# copy running-config startup-config</pre>	Saves this configuration change.
Step 5	reload Example: <pre>switch(config)# reload</pre>	Reboots the entire device.

Configuring 64-Bit ALPM Routing Mode (Cisco Nexus 9500 Platform Switches Only)

You can use the 64-bit algorithmic longest prefix match (ALPM) feature to manage IPv4 and IPv6 route table entries. In 64-bit ALPM routing mode, the device can store more route entries. In this mode, you can program one of the following:

- 80,000 IPv6 entries and no IPv4 entries
- No IPv6 entries and 128,000 IPv4 entries
- x IPv6 entries and y IPv4 entries, where $2x + y \leq 128,000$



Note This configuration impacts both the IPv4 and IPv6 address families.



Note For the 64-bit ALPM routing mode scale numbers, see the [Cisco Nexus 9000 Series NX-OS Verified Scalability Guide](#).

SUMMARY STEPS

1. **configure terminal**
2. **[no] system routing mode hierarchical 64b-alpm**
3. (Optional) **show forwarding route summary**

4. `copy running-config startup-config`
5. `reload`

DETAILED STEPS

	Command or Action	Purpose
Step 1	configure terminal Example: <pre>switch# configure terminal switch(config)#</pre>	Enters global configuration mode.
Step 2	[no] system routing mode hierarchical 64b-alm Example: <pre>switch(config)# system routing mode hierarchical 64b-alm</pre>	Causes all IPv4 and IPv6 LPM routes with a mask length that is less than or equal to 64 to be programmed in the fabric module. All host routes for IPv4 and IPv6 and all LPM routes with a mask length of 65–127 are programmed in the line card.
Step 3	(Optional) show forwarding route summary Example: <pre>switch(config)# show forwarding route summary</pre>	Displays the LPM mode.
Step 4	copy running-config startup-config Example: <pre>switch(config)# copy running-config startup-config</pre>	Saves this configuration change.
Step 5	reload Example: <pre>switch(config)# reload</pre>	Reboots the entire device.

Configuring ALPM Routing Mode (Cisco Nexus 9300 Platform Switches Only)

You can configure Cisco Nexus 9300 platform switches to support more LPM route entries.



Note This configuration impacts both the IPv4 and IPv6 address families.



Note For ALPM routing mode scale numbers, see the [Cisco Nexus 9000 Series NX-OS Verified Scalability Guide](#).

SUMMARY STEPS

1. `configure terminal`
2. `[no] system routing max-mode l3`
3. (Optional) `show forwarding route summary`

4. `copy running-config startup-config`
5. `reload`

DETAILED STEPS

	Command or Action	Purpose
Step 1	configure terminal Example: <pre>switch# configure terminal switch(config)#</pre>	Enters global configuration mode.
Step 2	[no] system routing max-mode l3 Example: <pre>switch(config)# system routing max-mode l3</pre>	Puts the device in Broadcom T2 mode 4 to support a larger LPM scale.
Step 3	(Optional) show forwarding route summary Example: <pre>switch(config)# show forwarding route summary</pre>	Displays the LPM mode.
Step 4	copy running-config startup-config Example: <pre>switch(config)# copy running-config startup-config</pre>	Saves this configuration change.
Step 5	reload Example: <pre>switch(config)# reload</pre>	Reboots the entire device.

Configuring LPM Heavy Routing Mode (Cisco Nexus 9200 and 9300-EX Platform Switches and 9732C-EX Line Card Only)

Beginning with Cisco NX-OS Release 7.0(3)I4(4), you can configure LPM heavy routing mode in order to support more LPM route entries. Only the Cisco Nexus 9200 and 9300-EX platform switches and the Cisco Nexus 9508 switch with an 9732C-EX line card support this routing mode.



Note This configuration impacts both the IPv4 and IPv6 address families.



Note For LPM heavy routing mode scale numbers, see the [Cisco Nexus 9000 Series NX-OS Verified Scalability Guide](#).

SUMMARY STEPS

1. **configure terminal**
2. **[no] system routing template-lpm-heavy**
3. (Optional) **show system routing mode**
4. **copy running-config startup-config**
5. **reload**

DETAILED STEPS

	Command or Action	Purpose
Step 1	configure terminal Example: <pre>switch# configure terminal switch(config)#</pre>	Enters global configuration mode.
Step 2	[no] system routing template-lpm-heavy Example: <pre>switch(config)# system routing template-lpm-heavy</pre>	Puts the device in LPM heavy routing mode to support a larger LPM scale.
Step 3	(Optional) show system routing mode Example: <pre>switch(config)# show system routing mode Configured System Routing Mode: LPM Heavy Applied System Routing Mode: LPM Heavy</pre>	Displays the LPM routing mode.
Step 4	copy running-config startup-config Example: <pre>switch(config)# copy running-config startup-config</pre>	Saves this configuration change.
Step 5	reload Example: <pre>switch(config)# reload</pre>	Reboots the entire device.

Configuring LPM Internet-Peering Routing Mode

Beginning with Cisco NX-OS Release 7.0(3)I6(1), you can configure LPM Internet-peering routing mode in order to support IPv4 and IPv6 LPM Internet route entries. This mode supports dynamic Trie (tree bit lookup) for IPv4 prefixes (with a prefix length up to /32) and IPv6 prefixes (with a prefix length up to /83).

Beginning with Cisco NX-OS Release 9.3(1), Cisco Nexus 9500-R platform switches support this routing mode.



Note This configuration impacts both the IPv4 and IPv6 address families.



Note For LPM Internet-peering routing mode scale numbers, see the [Cisco Nexus 9000 Series NX-OS Verified Scalability Guide](#). Cisco Nexus 9500-R platform switches in LPM Internet-peering mode scale out predictably only if they use internet-peering prefixes. If Cisco Nexus 9500-R platform switches use other prefix patterns, it might not achieve documented scalability numbers.

SUMMARY STEPS

1. **configure terminal**
2. **[no] system routing template-internet-peering**
3. (Optional) **show system routing mode**
4. **copy running-config startup-config**
5. **reload**

DETAILED STEPS

	Command or Action	Purpose
Step 1	configure terminal Example: switch# configure terminal switch(config)#	Enters global configuration mode.
Step 2	[no] system routing template-internet-peering Example: switch(config)# system routing template-internet-peering	Puts the device in LPM Internet-peering routing mode to support IPv4 and IPv6 LPM Internet route entries.
Step 3	(Optional) show system routing mode Example: switch(config)# show system routing mode Configured System Routing Mode: Internet Peering Applied System Routing Mode: Internet Peering	Displays the LPM routing mode.
Step 4	copy running-config startup-config Example: switch(config)# copy running-config startup-config	Saves this configuration change.
Step 5	reload Example: switch(config)# reload	Reboots the entire device.

Configuring LPM Dual-Host Routing Mode

Beginning with Cisco NX-OS Release 7.0(3)I5(1), you can configure LPM dual-host routing mode in order to increase the ARP/ND scale to double the default mode value. Only the Cisco Nexus 9200 and 9300-EX platform switches support this routing mode.

Beginning with Cisco NX-OS Release 10.3(1)F, the **system routing template-dual-stack-host-scale** profile supports Multicast and VXLAN on Cisco Nexus 9300-FX3/GX/GX2B ToR switches, and Nexus 9408 switches.



Note Ensure that the **system routing template-dual-stack-host-scale** profile is not used with BGW.



Note This configuration impacts both the IPv4 and IPv6 address families.



Note For LPM dual-host routing mode scale numbers, see the **Cisco Nexus 9000 Series NX-OS Verified Scalability Guide**.

SUMMARY STEPS

1. **configure terminal**
2. **[no] system routing template-dual-stack-host-scale**
3. (Optional) **show system routing mode**
4. **copy running-config startup-config**
5. **reload**

DETAILED STEPS

	Command or Action	Purpose
Step 1	configure terminal Example: <pre>switch# configure terminal switch(config)#</pre>	Enters global configuration mode.
Step 2	[no] system routing template-dual-stack-host-scale Example: <pre>switch(config)# system routing template-dual-stack-host-scale Warning: The command will take effect after next reload. Note: This requires copy running-config to startup-config before switch reload.</pre>	Puts the device in LPM dual-host routing mode to support a larger ARP/ND scale.
Step 3	(Optional) show system routing mode Example: <pre>switch(config)# show system routing mode</pre>	Displays the LPM routing mode.
Step 4	copy running-config startup-config Example:	Saves this configuration change.

	Command or Action	Purpose
	<code>switch(config)# copy running-config startup-config</code>	
Step 5	reload Example: <code>switch(config)# reload</code>	Reboots the entire device.

Configuring a Static ARP Entry

You can configure a static ARP entry on the device to map IP addresses to MAC hardware addresses, including static multicast MAC addresses.

SUMMARY STEPS

1. **configure terminal**
2. **interface ethernet** *number*
3. **ip arp address** *ip-address mac-address*
4. (Optional) **copy running-config startup-config**

DETAILED STEPS

	Command or Action	Purpose
Step 1	configure terminal Example: <code>switch# configure terminal</code> <code>switch(config)#</code>	Enters global configuration mode.
Step 2	interface ethernet <i>number</i> Example: <code>switch(config)# interface ethernet 2/3</code> <code>switch(config-if)#</code>	Enters interface configuration mode.
Step 3	ip arp address <i>ip-address mac-address</i> Example: <code>switch(config-if)# ip arp 192.168.1.1</code> <code>0019.076c.1a78</code>	Associates an IP address with a MAC address as a static entry.
Step 4	(Optional) copy running-config startup-config Example: <code>switch(config-if)# copy running-config</code> <code>startup-config</code>	Saves this configuration change.

Configuring Proxy ARP

Configure proxy ARP on the device to determine the media addresses of hosts on other networks or subnets.

SUMMARY STEPS

1. **configure terminal**
2. **interface ethernet *number***
3. **ip proxy arp**
4. (Optional) **copy running-config startup-config**

DETAILED STEPS

	Command or Action	Purpose
Step 1	configure terminal Example: <pre>switch# configure terminal switch(config)#</pre>	Enters global configuration mode.
Step 2	interface ethernet <i>number</i> Example: <pre>switch(config)# interface ethernet 2/3 switch(config-if)#</pre>	Enters interface configuration mode.
Step 3	ip proxy arp Example: <pre>switch(config-if)# ip proxy arp</pre>	Enables proxy ARP on the interface.
Step 4	(Optional) copy running-config startup-config Example: <pre>switch(config-if)# copy running-config startup-config</pre>	Saves this configuration change.

Configuring Local Proxy ARP on Ethernet Interfaces

You can configure local proxy ARP on Ethernet interfaces.

SUMMARY STEPS

1. **configure terminal**
2. **interface ethernet *number***
3. **[no]ip local-proxy-arp**
4. (Optional) **copy running-config startup-config**

DETAILED STEPS

	Command or Action	Purpose
Step 1	configure terminal Example: <pre>switch# configure terminal switch(config)#</pre>	Enters global configuration mode.

	Command or Action	Purpose
Step 2	interface ethernet <i>number</i> Example: switch(config)# interface ethernet 2/3 switch(config-if)#	Enters interface configuration mode.
Step 3	[no]ip local-proxy-arp Example: switch(config-if)# ip local-proxy-arp	Enables Local Proxy ARP on the interface.
Step 4	(Optional) copy running-config startup-config Example: switch(config-if)# copy running-config startup-config	Saves this configuration change.

Configuring Local Proxy ARP on SVIs

You can configure local proxy ARP on SVIs, and beginning with Cisco NX-OS Release 7.0(3)I7(1), you can suppress ARP broadcasts on corresponding VLANs.

Before you begin

If you are planning to suppress ARP broadcasts, configure the double-wide ACL TCAM region size for ARP/Layer 2 Ethertype using the hardware access-list team region arp-ether 256 double-wide command, save the configuration, and reload the switch. (For more information, see the [Configuring ACL TCAM Region Sizes](#) section in the [Cisco Nexus 9000 Series NX-OS Security Configuration Guide](#).)

SUMMARY STEPS

1. **configure terminal**
2. **interface vlan *vlan-id***
3. **[no] ip local-proxy-arp [no-hw-flooding]**
4. (Optional) **copy running-config startup-config**

DETAILED STEPS

	Command or Action	Purpose
Step 1	configure terminal Example: switch# configure terminal switch(config)#	Enters global configuration mode.
Step 2	interface vlan <i>vlan-id</i> Example: switch(config)# interface vlan 5 switch(config-if)#	Creates a VLAN interface and enters the configuration mode for the SVI.

	Command or Action	Purpose
Step 3	<p>[no] ip local-proxy-arp [no-hw-flooding]</p> <p>Example:</p> <pre>switch(config-if)# ip local-proxy-arp no-hw-flooding</pre>	<p>Enables local proxy ARP on SVIs. The no-hw-flooding option suppresses ARP broadcasts on corresponding VLANs.</p> <p>Note If you configure the no-hw-flooding option and then want to change the configuration to allow ARP broadcasts on SVIs, you must first disable this feature using the no ip local-proxy-arp no-hw-flooding command and then enter the ip local-proxy-arp command.</p>
Step 4	<p>(Optional) copy running-config startup-config</p> <p>Example:</p> <pre>switch(config-if)# copy running-config startup-config</pre>	<p>Copies the running configuration to the startup configuration.</p>

Configuring Periodic ARP Refresh on MAC Delete for SVIs

Beginning with Cisco NX-OS Release 10.2(4)M, you can configure periodic ARP Refresh on MAC delete for SVIs.

By default this command is disabled. This command must be configured under the SVI for the periodic ARP Refreshes to learn the MACs from the ARP response packet for the silent hosts on MAC delete/flush.

SUMMARY STEPS

1. **configure terminal**
2. **interface vlan vlan-id**
3. **[no] ip arp refresh-adj-on-mac-delete retry [count <frequency count>] [interval <interval in sec>]**
4. (Optional) **copy running-config startup-config**

DETAILED STEPS

	Command or Action	Purpose
Step 1	<p>configure terminal</p> <p>Example:</p> <pre>switch# configure terminal switch(config)#</pre>	<p>Enters global configuration mode.</p>
Step 2	<p>interface vlan vlan-id</p> <p>Example:</p> <pre>switch(config)# interface vlan 5 switch(config-if)#</pre>	<p>Creates a VLAN interface and enters the configuration mode for the SVI.</p>
Step 3	<p>[no] ip arp refresh-adj-on-mac-delete retry [count <frequency count>] [interval <interval in sec>]</p> <p>Example:</p>	<p>Configures the ARP Refreshes to learn the MACs from the ARP response packet for the silent hosts on MAC delete/flush.</p>

	Command or Action	Purpose
	<pre>switch(config-if)# ip arp refresh-adj-on-mac-delete retry count 3 interval 15 switch(config-if)#</pre>	<ul style="list-style-type: none"> • <i><frequency count></i>: The range is 1–3. The default is 3. • <i><interval in sec></i>: The range is 1–60 seconds. The default is 15 seconds. <p>Note If the interval is greater than 3/4th of ARP Refresh time, this command is rejected with the below message:</p> <p>ARP refresh will be sent earlier to the interval due to ARP timeout configuration. This configuration is not useful.</p>
Step 4	<p>(Optional) copy running-config startup-config</p> <p>Example:</p> <pre>switch(config-if)# copy running-config startup-config switch(config-if)#</pre>	Copies the running configuration to the startup configuration.

Configuring Gratuitous ARP

You can configure gratuitous ARP on an interface.

SUMMARY STEPS

1. **configure terminal**
2. **interface ethernet *number***
3. **ip arp gratuitous {request | update}**
4. (Optional) **copy running-config startup-config**

DETAILED STEPS

	Command or Action	Purpose
Step 1	<p>configure terminal</p> <p>Example:</p> <pre>switch# configure terminal switch(config)#</pre>	Enters global configuration mode.
Step 2	<p>interface ethernet <i>number</i></p> <p>Example:</p> <pre>switch(config)# interface ethernet 2/3 switch(config-if)#</pre>	Enters interface configuration mode.
Step 3	<p>ip arp gratuitous {request update}</p> <p>Example:</p>	Enables gratuitous ARP on the interface. Gratuitous ARP is enabled by default.

	Command or Action	Purpose
	<code>switch(config-if)# ip arp gratuitous request</code>	
Step 4	(Optional) copy running-config startup-config Example: <code>switch(config-if)# copy running-config startup-config</code>	Saves this configuration change.

Configuring Out of Subnet ARP Resolution

Beginning with Cisco NX-OS Release 10.4(1)F, you can enable or disable out of subnet ARP resolution using the **ip arp outside-subnet** command.

This command is available on both global and interface mode. There is no impact on config-replace and dual stage commit when this command is enabled.



Note When this command is enabled, downgrade from Cisco NX-OS Release 10.4(1)F is restricted, and user will be prompted with an error message to remove the out of subnet ARP resolution configuration before proceeding for downgrade.

SUMMARY STEPS

1. **configure terminal**
2. **[no] ip arp outside-subnet**
3. (Optional) **copy running-config startup-config**

DETAILED STEPS

	Command or Action	Purpose
Step 1	configure terminal Example: <code>switch# configure terminal</code> <code>switch(config)#</code>	Enters global configuration mode.
Step 2	[no] ip arp outside-subnet Example: <code>switch(config)# ip arp outside-subnet</code>	Enables or disables the ARP out of subnet packet transaction on connected host.
Step 3	(Optional) copy running-config startup-config Example: <code>switch(config)# copy running-config startup-config</code>	Saves this configuration change.

Configuring ARP Cache Limit Per SVI Interface

Beginning from Cisco NX-OS Release 10.4(2)F, you can set the number of maximum ARP cache entries to be allowed per SVI interface on the Cisco NX-OS devices. This configuration is supported on both global and interface modes.

SUMMARY STEPS

1. **configure terminal**
2. **interface vlan *vlan-id***
3. **[no] ip arp cache intf-limit *value***
4. (Optional) **copy running-config startup-config**

DETAILED STEPS

	Command or Action	Purpose
Step 1	configure terminal Example: switch# configure terminal switch(config)#	Enters global configuration mode.
Step 2	interface vlan <i>vlan-id</i> Example: switch(config)# interface vlan 5 switch(config-if)#	Creates a VLAN interface and enters the configuration mode for the SVI.
Step 3	[no] ip arp cache intf-limit <i>value</i> Example: switch(config-if)# ip arp cache intf-limit 50000 switch(config-if)#	Configures the set limit of ARP cache entries for the SVI interface. Range of valid ARP entries is 1-128000. intf-limit: Specifies the number of valid dynamic ARP entries per interface. The no form of this command removes the configuration.
Step 4	(Optional) copy running-config startup-config Example: switch(config)# copy running-config startup-config	Saves this configuration change.

Configuring Path MTU Discovery

You can configure path MTU discovery.

SUMMARY STEPS

1. **configure terminal**
2. **ip tcp path-mtu-discovery**
3. (Optional) **copy running-config startup-config**

DETAILED STEPS

	Command or Action	Purpose
Step 1	configure terminal Example: switch# configure terminal switch(config)#	Enters global configuration mode.
Step 2	ip tcp path-mtu-discovery Example: switch(config)# ip tcp path-mtu-discovery	Enables path MTU discovery.
Step 3	(Optional) copy running-config startup-config Example: switch(config)# copy running-config startup-config	Saves this configuration change.

Configuring IP Directed Broadcasts

An IP directed broadcast is an IP packet whose destination address is a valid broadcast address for some IP subnet, but which originates from a node that is not itself part of that destination subnet.

A device that is not directly connected to its destination subnet forwards an IP directed broadcast in the same way it forwards unicast IP packets destined to a host on that subnet. When a directed broadcast packet reaches a device that is directly connected to its destination subnet, that packet is broadcast on the destination subnet. The destination address in the IP header of the packet is rewritten to the configured IP broadcast address for the subnet, and the packet is sent as a link-layer broadcast.

If directed broadcast is enabled for an interface, incoming IP packets whose addresses identify them as directed broadcasts intended for the subnet to which that interface is attached are broadcasted on that subnet. You can optionally filter those broadcasts through an IP access list such that only those packets that pass through the access list are broadcasted on the subnet.

To enable IP directed broadcasts, use the following command in the interface configuration mode:

SUMMARY STEPS

1. **ip directed-broadcast** [*acl*]

DETAILED STEPS

	Command or Action	Purpose
Step 1	ip directed-broadcast [<i>acl</i>] Example: switch(config-if) # ip directed-broadcast	Enables the translation of a directed broadcast to physical broadcasts. You can optionally filter those broadcasts through an IP access list.

Configuring IP Glean Throttling

We recommend that you configure IP glean throttling to filter the unnecessary glean packets that are sent to the supervisor for ARP resolution for the next hops that are not reachable or do not exist. IP glean throttling boosts software performance and helps to manage traffic more efficiently.



Note Glean throttling is supported for IPv4 and IPv6, but IPv6 link-local addresses are not supported.

SUMMARY STEPS

1. **configure terminal**
2. **[no] hardware ip glean throttle**
3. (Optional) **copy running-config startup-config**

DETAILED STEPS

	Command or Action	Purpose
Step 1	configure terminal Example: <pre>switch# configure terminal switch(config)#</pre>	Enters global configuration mode.
Step 2	[no] hardware ip glean throttle Example: <pre>switch(config) # hardware ip glean throttle</pre>	Enables IP glean throttling.
Step 3	(Optional) copy running-config startup-config Example: <pre>switch(config)# copy running-config startup-config</pre>	Saves this configuration change.

Configuring the Hardware IP Glean Throttle Maximum

You can limit the maximum number of drop adjacencies that are installed in the Forwarding Information Base (FIB).

SUMMARY STEPS

1. **configure terminal**
2. **[no] hardware ip glean throttle maximum *count***
3. (Optional) **copy running-config startup-config**

DETAILED STEPS

	Command or Action	Purpose
Step 1	configure terminal Example: <pre>switch# configure terminal switch(config)#</pre>	Enters global configuration mode.
Step 2	[no] hardware ip glean throttle maximum count Example: <pre>switch(config) # hardware ip glean throttle maximum 2134</pre>	Configures the number of drop adjacencies that are installed in the FIB.
Step 3	(Optional) copy running-config startup-config Example: <pre>switch(config)# copy running-config startup-config</pre>	Saves this configuration change.

Configuring the Hardware IP Glean Throttle Timeout

You can configure a timeout for the installed drop adjacencies to remain in the FIB.

SUMMARY STEPS

1. **configure terminal**
2. **[no] hardware ip glean throttle maximum timeout timeout-in-seconds**
3. (Optional) **copy running-config startup-config**

DETAILED STEPS

	Command or Action	Purpose
Step 1	configure terminal Example: <pre>switch# configure terminal switch(config)#</pre>	Enters global configuration mode.
Step 2	[no] hardware ip glean throttle maximum timeout timeout-in-seconds Example: <pre>switch(config)# hardware ip glean throttle maximum timeout 300</pre>	Configures the timeout for the installed drop adjacencies to remain in the FIB. The range is from 300 seconds (5 minutes) to 1800 seconds (30 minutes). Note After the timeout period is exceeded, the drop adjacencies are removed from the FIB.
Step 3	(Optional) copy running-config startup-config Example:	Saves this configuration change.

	Command or Action	Purpose
	<code>switch(config)# copy running-config startup-config</code>	

Configuring the Interface IP Address for the ICMP Source IP Field

You can configure an interface IP address for the ICMP source IP field to handle ICMP error messages.

SUMMARY STEPS

1. **configure terminal**
2. **[no] ip source {ethernet *slot/port* | loopback *number* | port-channel *number*} icmp-errors**
3. (Optional) **copy running-config startup-config**

DETAILED STEPS

	Command or Action	Purpose
Step 1	configure terminal Example: <code>switch# configure terminal</code> <code>switch(config)#</code>	Enters global configuration mode.
Step 2	[no] ip source {ethernet <i>slot/port</i> loopback <i>number</i> port-channel <i>number</i>} icmp-errors Example: <code>switch(config)# ip source loopback 0</code> <code>icmp-errors</code>	Configures an interface IP address for the ICMP source IP field to route ICMP error messages.
Step 3	(Optional) copy running-config startup-config Example: <code>switch(config)# copy running-config</code> <code>startup-config</code>	Saves this configuration change.

Configuring IPv4 Redirect Syslog

To enable/disable the IPv4 redirect syslog or change the logging interval, use the below CLIs:



Note By default, redirecting syslog will be enabled.

SUMMARY STEPS

1. **configure terminal**
2. **ip redirect syslog [<value>]**
3. (Optional) **no ip redirect syslog**

DETAILED STEPS

	Command or Action	Purpose
Step 1	configure terminal Example: <pre>switch# configure terminal switch(config)#</pre>	Enters global configuration mode.
Step 2	ip redirect syslog [<value>] Example: <pre>switch(config)# ip redirect syslog 60 switch(config)#</pre>	Configures the syslog for excessive IP redirect messages. <ul style="list-style-type: none"> • ip redirect syslog: Enables the syslog for IPv4 redirect messages. • value: Configures the logging interval. The range is minimum 30 seconds to maximum 1800 seconds. The default interval is 60 seconds.
Step 3	(Optional) no ip redirect syslog Example: <pre>switch(config)# no ip redirect syslog</pre>	Disables the syslog for excessive IPv4 redirect messages.

Verifying the IPv4 Configuration

To display the IPv4 configuration information, perform one of the following tasks:

Command	Purpose
show ip adjacency	Displays the adjacency table.
show ip adjacency summary	Displays the summary of number of throttle adjacencies.
show ip arp	Displays the ARP table.
show ip arp summary	Displays the summary of the number of throttle adjacencies.
show ip interface	Displays IP-related interface information.
show ip arp statistics [vrf vrf-name]	Displays the ARP statistics.
show ip arp internal info interface <interface-name>	Displays the configured count and interval

Additional References

Related Documents for IPv4

Related Topic	Document Title
TCAM regions	See the Configuring ACL TCAM Region Sizes section in the Cisco Nexus 9000 Series NX-OS Security Configuration Guide .



CHAPTER 4

Configuring IPv6

This chapter contains the following topics:

- [About IPv6, on page 51](#)
- [Virtualization Support, on page 69](#)
- [IPv6 Routes with ECMP, on page 70](#)
- [Prerequisites for IPv6, on page 70](#)
- [Guidelines and Limitations for IPv6, on page 70](#)
- [Configuring IPv6, on page 71](#)
- [Verifying the IPv6 Configuration, on page 89](#)
- [Configuration Examples for IPv6, on page 90](#)

About IPv6

IPv6, which is designed to replace IPv4, increases the number of network address bits from 32 bits (in IPv4) to 128 bits. IPv6 is based on IPv4, but it includes a much larger address space and other improvements such as a simplified main header and extension headers.

The larger IPv6 address space allows networks to scale and provide global reachability. The simplified IPv6 packet header format handles packets more efficiently. The flexibility of the IPv6 address space reduces the need for private addresses and the use of Network Address Translation (NAT), which translates private (not globally unique) addresses into a limited number of public addresses. IPv6 enables new application protocols that do not require special processing by border routers at the edge of networks.

IPv6 functionality, such as prefix aggregation, simplified network renumbering, and IPv6 site multihoming capabilities, enables more efficient routing. IPv6 supports Routing Information Protocol (RIP), Integrated Intermediate System-to-Intermediate System (IS-IS), Open Shortest Path First (OSPF) for IPv6, and multiprotocol Border Gateway Protocol (BGP).

IPv6 Address Formats

An IPv6 address has 128 bits or 16 bytes. The address is divided into eight, 16-bit hexadecimal blocks separated by colons (:) in the format x:x:x:x:x:x:x.

Two examples of IPv6 addresses are as follows:

```
2001:0DB8:7654:3210:FEDC:BA98:7654:3210
```

```
2001:0DB8:0:0:8:800:200C:417A
```

IPv6 addresses contain consecutive zeros within the address. You can use two colons (::) at the beginning, middle, or end of an IPv6 address to replace the consecutive zeros. The following table shows a list of compressed IPv6 address formats.



Note You can use two colons (::) only once in an IPv6 address to replace the longest string of consecutive zeros within the address.

You can use a double colon as part of the IPv6 address when consecutive 16-bit values are denoted as zero. You can configure multiple IPv6 addresses per interface but only one link-local address.

The hexadecimal letters in IPv6 addresses are not case sensitive.

Table 7: Compressed IPv6 Address Formats

IPv6 Address Type	Preferred Format	Compressed Format
Unicast	2001:0:0:0:DB8:800:200C:417A	2001::0DB8:800:200C:417A
Multicast	FF01:0:0:0:0:0:0:101	FF01::101
Loopback	0:0:0:0:0:0:0:1	::1
Unspecified	0:0:0:0:0:0:0:0	::

A node may use the loopback address listed in the table to send an IPv6 packet to itself. The loopback address in IPv6 is the same as the loopback address in IPv4. For more information, see [Overview, on page 3](#).



Note You cannot assign the IPv6 loopback address to a physical interface. A packet that contains the IPv6 loopback address as its source or destination address must remain within the node that created the packet. IPv6 routers do not forward packets that have the IPv6 loopback address as their source or destination address.



Note You cannot assign an IPv6 unspecified address to an interface. You should not use the unspecified IPv6 addresses as destination addresses in IPv6 packets or the IPv6 routing header.

The IPv6 prefix is in the form documented in RFC 2373 where the IPv6 address is specified in hexadecimal using 16-bit values between colons. The prefix length is a decimal value that indicates how many of the high-order contiguous bits of the address comprise the prefix (the network portion of the address). For example, 2001:0DB8:8086:6502::/32 is a valid IPv6 prefix.

IPv6 Unicast Addresses

An IPv6 unicast address is an identifier for a single interface on a single node. A packet that is sent to a unicast address is delivered to the interface identified by that address.

Aggregatable Global Addresses

An aggregatable global address is an IPv6 address from the aggregatable global unicast prefix. The structure of aggregatable global unicast addresses enables strict aggregation of routing prefixes that limits the number of routing table entries in the global routing table. Aggregatable global addresses are used on links that are aggregated upward through organizations and eventually to the Internet service providers (ISPs).

Aggregatable global IPv6 addresses are defined by a global routing prefix, a subnet ID, and an interface ID. Except for addresses that start with binary 000, all global unicast addresses have a 64-bit interface ID. The IPv6 global unicast address allocation uses the range of addresses that start with binary value 001 (2000::/3). The following figure shows the structure of an aggregatable global address.

Figure 6: Aggregatable Global Address Format

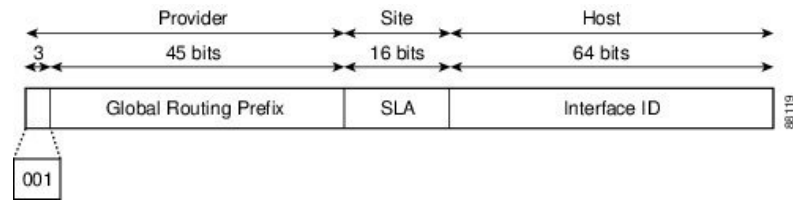

Addresses with a prefix of 2000::/3 (001) through E000::/3 (111) are required to have 64-bit interface identifiers in the extended universal identifier (EUI)-64 format. The Internet Assigned Numbers Authority (IANA) allocates the IPv6 address space in the range of 2000::/16 to regional registries.

The aggregatable global address consists of a 48-bit global routing prefix and a 16-bit subnet ID or Site-Level Aggregator (SLA). In the IPv6 aggregatable global unicast address format document (RFC 2374), the global routing prefix included two other hierarchically structured fields called Top-Level Aggregator (TLA) and Next-Level Aggregator (NLA). The IETF decided to remove the TLA and NLA fields from the RFCs because these fields are policy based. Some existing IPv6 networks deployed before the change might still use networks that are on the older architecture.

A subnet ID, which is a 16-bit subnet field, can be used by individual organizations to create a local addressing hierarchy and to identify subnets. A subnet ID is similar to a subnet in IPv4, except that an organization with an IPv6 subnet ID can support up to 65,535 individual subnets.

An interface ID identifies interfaces on a link. The interface ID is unique to the link. In many cases, an interface ID is the same as or based on the link-layer address of an interface. Interface IDs used in aggregatable global unicast and other IPv6 address types have 64 bits and are in the modified EUI-64 format.

Interface IDs are in the modified EUI-64 format in one of the following ways:

- For all IEEE 802 interface types (for example, Ethernet and Fiber Distributed Data interfaces), the first three octets (24 bits) are the Organizationally Unique Identifier (OUI) of the 48-bit link-layer address (MAC address) of the interface, the fourth and fifth octets (16 bits) are a fixed hexadecimal value of FFFE, and the last three octets (24 bits) are the last three octets of the MAC address. The Universal/Local (U/L) bit, which is the seventh bit of the first octet, has a value of 0 or 1. Zero indicates a locally administered identifier; 1 indicates a globally unique IPv6 interface identifier.
- For all other interface types (for example, serial, loopback, ATM, and Frame Relay types), the interface ID is similar to the interface ID for IEEE 802 interface types; however, the first MAC address from the pool of MAC addresses in the router is used as the identifier (because the interface does not have a MAC address).



Note For interfaces that use the Point-to-Point Protocol (PPP), where the interfaces at both ends of the connection might have the same MAC address, the interface identifiers at both ends of the connection are negotiated (picked randomly and, if necessary, reconstructed) until both identifiers are unique. The first MAC address in the router is used as the identifier for interfaces using PPP.

If no IEEE 802 interface types are in the router, link-local IPv6 addresses are generated on the interfaces in the router in the following sequence:

1. The router is queried for MAC addresses (from the pool of MAC addresses in the router).
2. If no MAC addresses are available in the router, the serial number of the router is used to form the link-local addresses.
3. If the serial number of the router cannot be used to form the link-local addresses, the router uses a Message Digest 5 (MD5) hash to determine the MAC address of the router from the hostname of the router.

Link-Local Addresses

A link-local address is an IPv6 unicast address that can be automatically configured on any interface using the link-local prefix FE80::/10 (1111 1110 10) and the interface identifier in the modified EUI-64 format. Link-local addresses are used in the Neighbor Discovery Protocol (NDP) and the stateless autoconfiguration process. Nodes on a local link can use link-local addresses to communicate; the nodes do not need globally unique addresses to communicate. The figure shows the structure of a link-local address.

IPv6 routers cannot forward packets that have link-local source or destination addresses to other links.

Figure 7: Link-Local Address Format

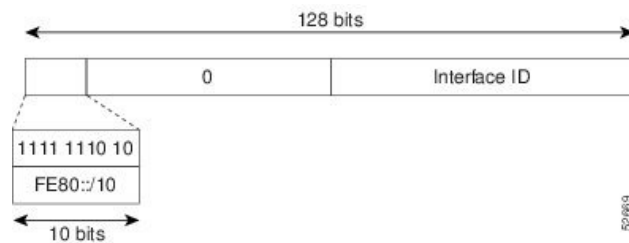

IPv4-Compatible IPv6 Addresses

An IPv4-compatible IPv6 address is an IPv6 unicast address that has zeros in the high-order 96 bits of the address and an IPv4 address in the low-order 32 bits of the address. The format of an IPv4-compatible IPv6 address is 0:0:0:0:0:A.B.C.D or ::A.B.C.D. The entire 128-bit IPv4-compatible IPv6 address is used as the IPv6 address of a node, and the IPv4 address embedded in the low-order 32 bits is used as the IPv4 address of the node. IPv4-compatible IPv6 addresses are assigned to nodes that support both the IPv4 and IPv6 protocol stacks and are used in automatic tunnels. The figure shows the structure of a n IPv4-compatible IPv6 address and a few acceptable formats for the address.

Figure 8: IPv4-Compatible IPv6 Address Format

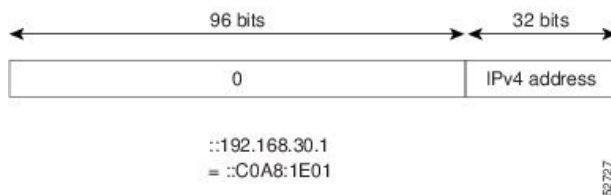

Unique Local Addresses

A unique local address is an IPv6 unicast address that is globally unique and is intended for local communications. It is not expected to be routable on the global Internet and is routable inside of a limited area, such as a site, and it may be routed between a limited set of sites. Applications might treat unique local addresses like global scoped addresses.

A unique local address has the following characteristics:

- It has a globally unique prefix (it has a high probability of uniqueness).
- It has a well-known prefix to allow for easy filtering at site boundaries.
- It allows sites to be combined or privately interconnected without creating any address conflicts or requiring renumbering of interfaces that use these prefixes.
- It is ISP-independent and can be used for communications inside of a site without having any permanent or intermittent Internet connectivity.
- If it is accidentally leaked outside of a site through routing or the Domain Name Server (DNS), there is no conflict with any other addresses.

The figure shows the structure of a unique local address.

Figure 9: Unique Local Address Structure

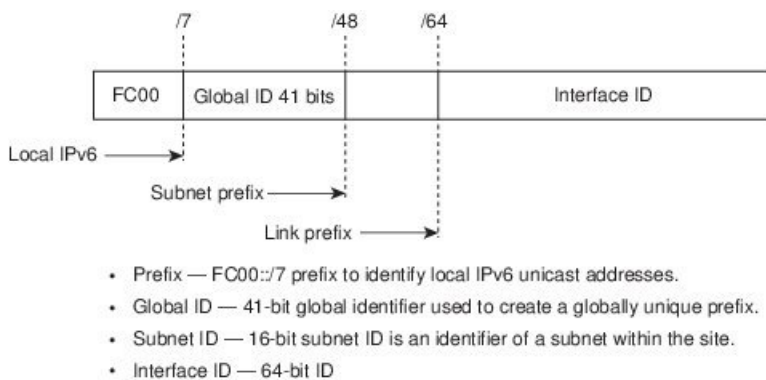

Site Local Addresses

Because RFC 3879 deprecates the use of site-local addresses, you should follow the recommendations of unique local addressing (ULA) in RFC 4193 when you configure private IPv6 addresses.

IPv4 Packet Header

The base IPv4 packet header has 12 fields with a total size of 20 octets (160 bits). The 12 fields may be followed by an Options field, which is followed by a data portion that is usually the transport-layer packet. The variable length of the Options field adds to the total size of the IPv4 packet header. The shaded fields of the IPv4 packet header are not included in the IPv6 packet header.

Figure 10: IPv4 Packet Header Format

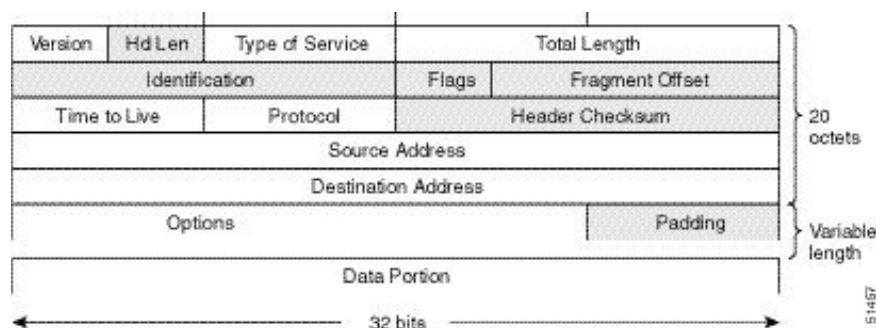

Simplified IPv6 Packet Header

The base IPv6 packet header has 8 fields with a total size of 40 octets (320 bits). Fragmentation is handled by the source of a packet, and checksums at the data link layer and transport layer are used. The User Datagram Protocol (UDP) checksum checks the integrity of the inner packet, and the base IPv6 packet header and Options field are aligned to 64 bits, which can facilitate the processing of IPv6 packets.

The table lists the fields in the base IPv6 packet header.

Table 8: Base IPv6 Packet Header Fields

Field	Description
Version	Similar to the Version field in the IPv4 packet header, except that the field lists number 6 for IPv6 instead of number 4 for IPv4.
Traffic Class	Similar to the Type of Service field in the IPv4 packet header. The Traffic Class field tags packets with a traffic class that is used in differentiated services.
Flow Label	New field in the IPv6 packet header. The Flow Label field tags packets with a specific flow that differentiates the packets at the network layer.
Payload Length	Similar to the Total Length field in the IPv4 packet header. The Payload Length field indicates the total length of the data portion of the packet.

Field	Description
Next Header	Similar to the Protocol field in the IPv4 packet header. The value of the Next Header field determines the type of information that follows the base IPv6 header. The type of information that follows the base IPv6 header can be a transport-layer packet (for example, a TCP or UDP packet) or an Extension Header, as shown in the figure below.
Hop Limit	Similar to the Time to Live field in the IPv4 packet header. The value of the Hop Limit field specifies the maximum number of routers that an IPv6 packet can pass through before the packet is considered invalid. Each router decrements the value by one. Because no checksum is in the IPv6 header, the router can decrement the value without needing to recalculate the checksum, which saves processing resources.
Source Address	Similar to the Source Address field in the IPv4 packet header, except that the field contains a 128-bit source address for IPv6 instead of a 32-bit source address for IPv4.
Destination Address	Similar to the Destination Address field in the IPv4 packet header, except that the field contains a 128-bit destination address for IPv6 instead of a 32-bit destination address for IPv4.

Figure 11: IPv6 Packet Header Format

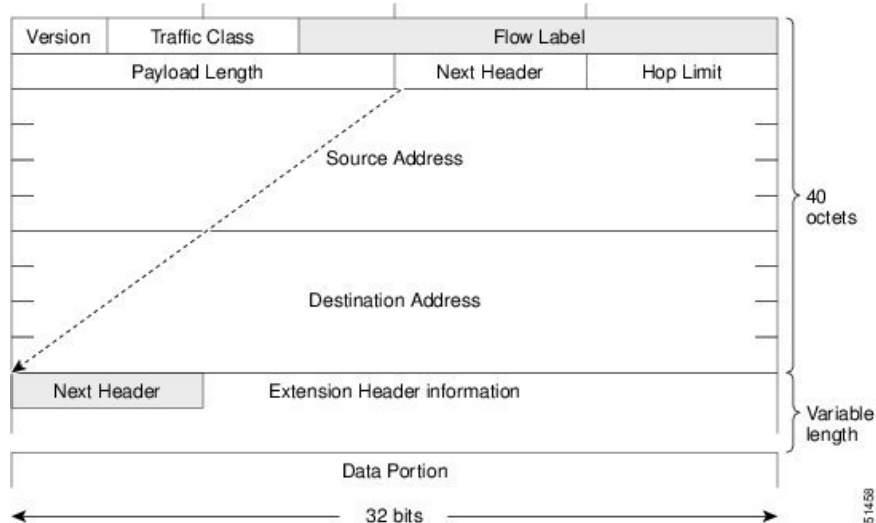

IPv6 Extension Headers

Optional extension headers and the data portion of the packet are after the eight fields of the base IPv6 packet header. If present, each extension header is aligned to 64 bits. There is no fixed number of extension headers in an IPv6 packet. Each extension header is identified by the Next Header field of the previous header. Typically, the final extension header has a Next Header field of a transport-layer protocol, such as TCP or UDP. The following figure shows the IPv6 extension header format.

Figure 12: IPv6 Extension Header Format

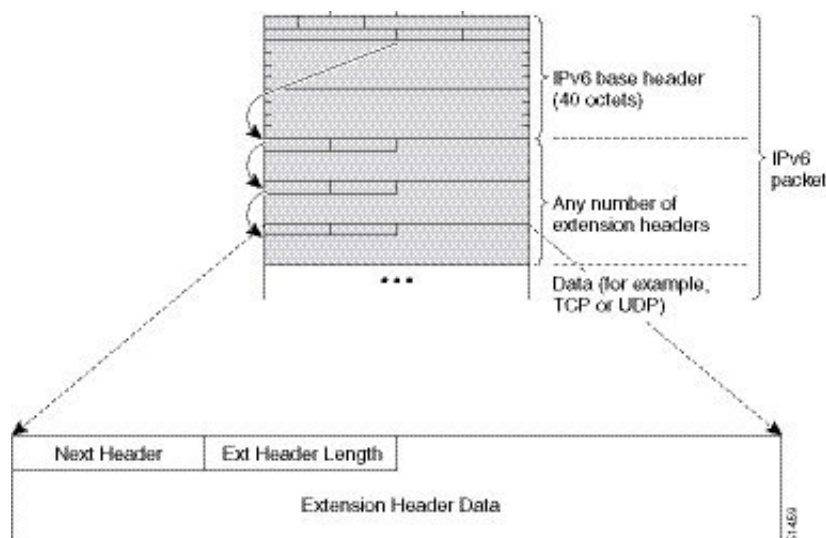

The table below lists the extension header types and their Next Header field values.

Table 9: IPv6 Extension Header Types

Header Type	Next Header Value	Description
Hop-by-hop options	0	Header that is processed by all hops in the path of a packet. When present, the hop-by-hop options header always follows immediately after the base IPv6 packet header.
Destination options	60	Header that can follow any hop-by-hop options header. The header is processed at the final destination and at each visited address specified by a routing header.
Routing	43	Header that is used for source routing.
Fragment	44	Header that is used when a source fragments a packet that is larger than the maximum transmission unit (MTU) for the path between itself and a destination. The Fragment header is used in each fragmented packet.
Authentication	51	Header that is used to provide connectionless integrity and data origin authentication for packets.
Encapsulation Security Payload	50	All information following this header is encrypted.
Mobility	135	Header that is used in support of Mobile IPv6 service.
Host Identity Protocol	139	Header that is used for Host Identity Protocol version 2 (HIPv2), which provides secure methods for IP multihoming and mobile computing.

accommodate the size of the packets. Having IPv6 hosts handle packet fragmentation saves IPv6 router processing resources and helps IPv6 networks run more efficiently. Once the path MTU is reduced by the arrival of an ICMP Too Big message, Cisco NX-OS retains the lower value. The connection does not increase the segment size to gauge the throughput.



Note In IPv6, the minimum link MTU is 1280 octets. We recommend that you use an MTU value of 1500 octets for IPv6 links.

CDP IPv6 Address Support

You can use the Cisco Discovery Protocol (CDP) IPv6 address support for the neighbor information feature to transfer IPv6 addressing information between two Cisco devices. Cisco Discovery Protocol support for IPv6 addresses provides IPv6 information to network management products and troubleshooting tools.

ICMP for IPv6

You can use ICMP in IPv6 to provide information about the health of the network. ICMPv6, the version that works with IPv6, reports errors if packets cannot be processed correctly and sends informational messages about the status of the network. For example, if a router cannot forward a packet because it is too large to be sent out on another network, the router sends out an ICMPv6 message to the originating host. Additionally, ICMP packets in IPv6 are used in IPv6 neighbor discovery and path MTU discovery. The path MTU discovery process ensures that a packet is sent using the largest possible size that is supported on a specific route.

A value of 58 in the Next Header field of the base IPv6 packet header identifies an IPv6 ICMP packet. The ICMP packet follows all the extension headers and is the last piece of information in the IPv6 packet. Within the IPv6 ICMP packets, the ICMPv6 Type and ICMPv6 Code fields identify IPv6 ICMP packet specifics, such as the ICMP message type. The value in the Checksum field is computed by the sender and checked by the receiver from the fields in the IPv6 ICMP packet and the IPv6 pseudo header.



Note The IPv6 header does not have a checksum. But a checksum on the transport layer can determine if packets have not been delivered correctly. All checksum calculations that include the IP address in the calculation must be modified for IPv6 to accommodate the new 128-bit address. A checksum is generated using a pseudo header.

The ICMPv6 Payload field contains error or diagnostic information that relates to IP packet processing. The following figure shows the IPv6 ICMP packet header format.

Figure 13: IPv6 ICMP Packet Header Format

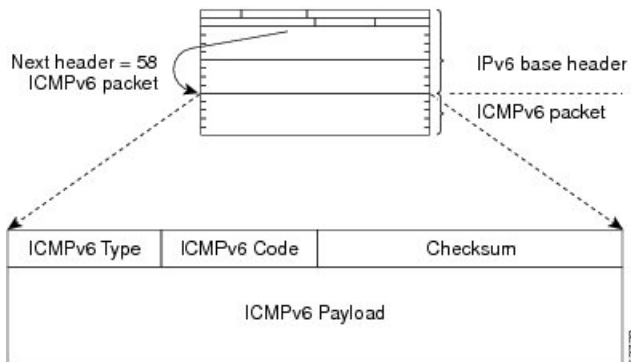

IPv6 Neighbor Discovery

You can use the IPv6 Neighbor Discovery Protocol (NDP) to determine whether a neighboring router is reachable. IPv6 nodes use neighbor discovery to determine the addresses of nodes on the same network (local link), to find neighboring routers that can forward their packets, to verify whether neighboring routers are reachable or not, and to detect changes to link-layer addresses. NDP uses ICMP messages to detect whether packets are sent to neighboring routers that are unreachable.

IPv6 Neighbor Solicitation Message

A node sends a neighbor solicitation message, which has a value of 135 in the Type field of the ICMP packet header, on the local link when it wants to determine the link-layer address of another node on the same local link (see figure below). The source address is the IPv6 address of the node that sends the neighbor solicitation message. The destination address is the solicited-node multicast address that corresponds to the IPv6 address of the destination node. The neighbor solicitation message also includes the link-layer address of the source node.

Figure 14: IPv6 Neighbor Discovery-Neighbor Solicitation Message

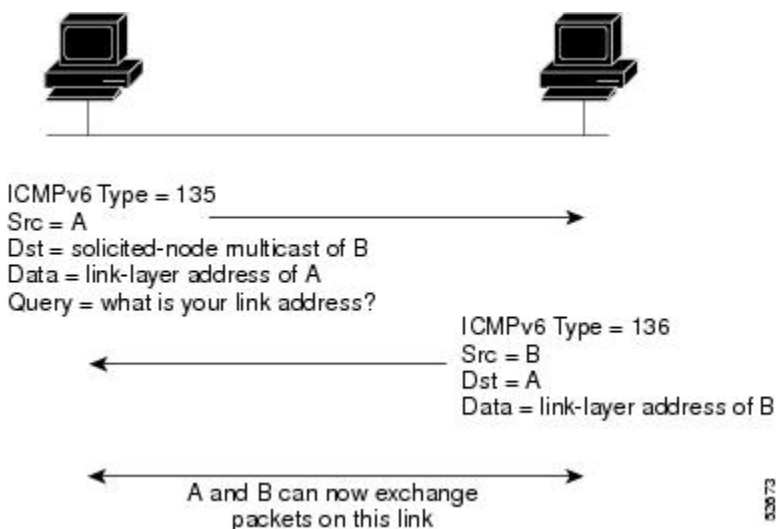

After receiving the neighbor solicitation message, the destination node replies by sending a neighbor advertisement message, which has a value of 136 in the Type field of the ICMP packet header, on the local link. The source address is the IPv6 address of the node (the IPv6 address of the node interface that sends the neighbor advertisement message). The destination address is the IPv6 address of the node that sends the neighbor solicitation message. The data portion includes the link-layer address of the node that sends the neighbor advertisement message.

After the source node receives the neighbor advertisement, the source node and destination node can communicate.

Neighbor solicitation messages can verify the reachability of a neighbor after a node identifies the link-layer address of a neighbor. When a node wants to verify the reachability of a neighbor, it uses the destination address in a neighbor solicitation message as the unicast address of the neighbor.

Neighbor advertisement messages are also sent when there is a change in the link-layer address of a node on a local link. When there is a change, the destination address for the neighbor advertisement is the all-nodes multicast address.

Neighbor unreachability detection identifies the failure of a neighbor or the failure of the forward path to the neighbor and is used for all paths between hosts and neighboring nodes (hosts or routers). Neighbor unreachability detection is performed for neighbors to which only unicast packets are being sent and is not performed for neighbors to which multicast packets are being sent.

A neighbor is considered reachable when a positive acknowledgment is returned from the neighbor (indicating that packets previously sent to the neighbor have been received and processed). A positive acknowledgment—from an upper-layer protocol (such as TCP)—indicates that a connection is making forward progress (reaching its destination). If packets are reaching the peer, they are also reaching the next-hop neighbor of the source. Forward progress is also a confirmation that the next-hop neighbor is reachable.

For destinations that are not on the local link, forward progress implies that the first-hop router is reachable. When acknowledgments from an upper-layer protocol are not available, a node probes the neighbor using unicast neighbor solicitation messages to verify that the forward path is still working. The return of a solicited neighbor advertisement message from the neighbor is a positive acknowledgment that the forward path is still working (neighbor advertisement messages that have the solicited flag set to a value of 1 are sent only in response to a neighbor solicitation message). Unsolicited messages confirm only the one-way path from the source to the destination node; solicited neighbor advertisement messages indicate that a path is working in both directions.



Note A neighbor advertisement message that has the solicited flag set to a value of 0 is not considered as a positive acknowledgment that the forward path is still working.

Neighbor solicitation messages are also used in the stateless autoconfiguration process to verify the uniqueness of unicast IPv6 addresses before the addresses are assigned to an interface. Duplicate address detection is performed first on a new, link-local IPv6 address before the address is assigned to an interface (the new address remains in a tentative state while duplicate address detection is performed). A node sends a neighbor solicitation message with an unspecified source address and a tentative link-local address in the body of the message. If another node is already using that address, the node returns a neighbor advertisement message that contains the tentative link-local address. If another node is simultaneously verifying the uniqueness of the same address, that node also returns a neighbor solicitation message. If no neighbor advertisement messages are received in response to the neighbor solicitation message and no neighbor solicitation messages are received from other nodes that are attempting to verify the same tentative address, the node that sent the original neighbor solicitation message considers the tentative link-local address to be unique and assigns the address to the interface.

IPv6 Stateless Autoconfiguration

All interfaces on IPv6 nodes must have a link-local address, which is usually automatically configured from the identifier for an interface and the link-local prefix FE80::/10. A link-local address enables a node to communicate with other nodes on the link and can be used to further configure the node.

IPv6 Stateless Address Autoconfiguration (SLAAC) is performed only on a management interface. For example, when SLAAC is enabled on a management interface, it generates a Link Local Address (LLA) and performs a Duplicate Address Detection (DAD) on link local address. After the successful duplicate address detection process, the interface transmits ICMPv6 Router Solicitation (RS) packets. The upstream router that receives the RS packets responds back with an ICMPv6 Router Advertisement (RA). The RA packet will have a prefix TLV option that carries the subnet in which the downstream NX-OS Switch auto-generates the address, using the MAC information of the interface and the advertised prefix in RA packet. The Cisco NX-OS Switch auto-generates address in EUI-64 format and performs DAD on the new auto-generated addresses.

IPv6 addresses are assigned to an interface for a specific length of time. Each address has a lifetime that indicates how long the address is attached to an interface. The TLV prefix in the RA packet sent from the upstream router contain information about valid lifetime and preferred lifetime. The addresses that are assigned to an interface goes through two distinct phases. Initially, an address goes to a preferred state which means the address is not restricted for using in arbitrary communication. The address becomes deprecated state when the current interface binding becomes invalid. In a deprecated state, the use of the address is discouraged, not necessarily forbidden. Only applications that would have difficulty in switching to another address without a service disruption must use a deprecated address.

IPv6 Compute Node IP Auto-Configuration

A node IP must be assigned to connected compute nodes before they can be on-boarded into a K8s cluster and eBGP peering can be established between the switch and a compute node.

Beginning with Cisco NX-OS Release 10.3(3)F, the IPv6 Compute Node IP Auto-Configuration support is provided on Cisco NX-OS 9000 series platform switches to assign and distribute the node IP addresses to multi-homed compute nodes and establish reachability to K8s cluster using the assigned node IP.



Note The node address assignment is however different from SLAAC. It is a method to assign an unique IPv6 address on the loopback interface that is orthogonal to interface address provisioning in a layer-3 interface subnet that is done through SLAAC.

This feature complies with the standard as defined in RFC [8505/6775](#).

IPv6 Router Advertisement Message

Router advertisement (RA) messages, which have a value of 134 in the Type field of the ICMP packet header, are periodically sent out to each configured interface of an IPv6 router. For stateless autoconfiguration to work properly, the advertised prefix length in RA messages must always be 64 bits.

The RA messages are sent to the all-nodes multicast address (see the following figure).

Figure 15: IPv6 Neighbor Discovery-RA Message

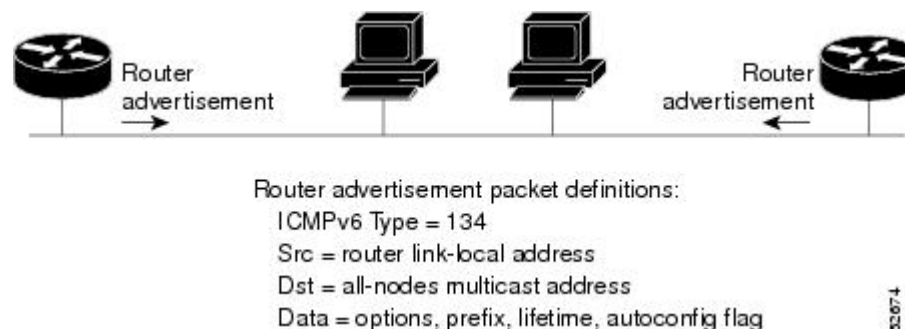

The RA messages are sent to the all-nodes multicast address.

RA messages typically include the following information:

- One or more onlink IPv6 prefixes that nodes on the local link can use to automatically configure their IPv6 addresses
- Life-time information for each prefix included in the advertisement
- Sets of flags that indicate the type of autoconfiguration (stateless or stateful) that can be completed
- Default router information (whether the router sending the advertisement should be used as a default router and, if so, the amount of time in seconds that the router should be used as a default router)
- Additional information for hosts, such as the hop limit and MTU that a host should use in packets that it originates

RAs are also sent in response to router solicitation messages. Router solicitation messages, which have a value of 133 in the Type field of the ICMP packet header, are sent by hosts at system startup so that the host can immediately autoconfigure without needing to wait for the next scheduled RA message. The source address is usually the unspecified IPv6 address (0:0:0:0:0:0:0:0). If the host has a configured unicast address, the unicast address of the interface that sends the router solicitation message is used as the source address in the message. The destination address is the all-routers multicast address with a scope of the link. When an RA is sent in response to a router solicitation, the destination address in the RA message is the unicast address of the source of the router solicitation message.

You can configure the following RA message parameters:

- The time interval between periodic RA messages
- The router life-time value, which indicates the usefulness of a router as the default router (for use by all nodes on a given link)
- The network prefixes in use on a given link
- The time interval between neighbor solicitation message retransmissions (on a given link)
- The amount of time that a node considers a neighbor reachable (for use by all nodes on a given link)

The configured parameters are specific to an interface. The sending of RA messages (with default values) is automatically enabled on Ethernet interfaces. For other interface types, you must enter the **no ipv6 nd suppress-ra** command to send RA messages. You can disable the RA message feature on individual interfaces by entering the **ipv6 nd suppress-ra** command.

IPv6 Neighbor Redirect Message

Routers send neighbor redirect messages to inform hosts of better first-hop nodes on the path to a destination. A value of 137 in the Type field of the ICMP packet header identifies an IPv6 neighbor redirect message.

Figure 16: IPv6 Neighbor Discovery-Neighbor Redirect Message

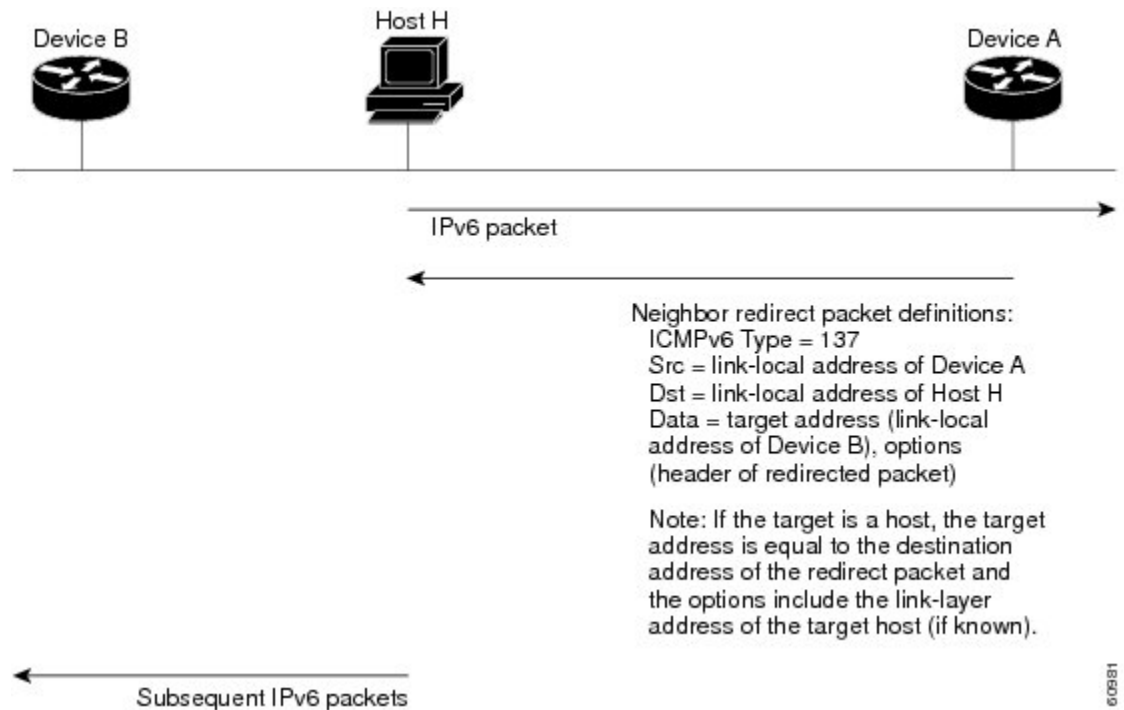

Note A router must be able to determine the link-local address for each of its neighboring routers in order to ensure that the target address (the final destination) in a redirect message identifies the neighbor router by its link-local address. For static routing, you should specify the address of the next-hop router using the link-local address of the router. For dynamic routing, you must configure all IPv6 routing protocols to exchange the link-local addresses of neighboring routers.

After forwarding a packet, a router sends a redirect message to the source of the packet under the following circumstances:

- The destination address of the packet is not a multicast address.
- The packet was not addressed to the router.
- The packet is about to be sent out the interface on which it was received.
- The router determines that a better first-hop node for the packet resides on the same link as the source of the packet.
- The source address of the packet is a global IPv6 address of a neighbor on the same link or a link-local address.

IPv6 Anycast Addresses

An anycast address is an address that is assigned to a set of interfaces that belong to different nodes. A packet sent to an anycast address is delivered to the closest interface—as defined by the routing protocols in use—identified by the anycast address. Anycast addresses are syntactically indistinguishable from unicast addresses because anycast addresses are allocated from the unicast address space. Assigning a unicast address to more than one interface turns a unicast address into an anycast address. You must configure the nodes to which the anycast address belongs to recognize that the address is an anycast address.



Note Anycast addresses can be used only by a router, not a host. Anycast addresses cannot be used as the source address of an IPv6 packet.

The following figure shows the format of the subnet router anycast address; the address has a prefix concatenated by a series of zeros (the interface ID). The subnet router anycast address can be used to reach a router on the link that is identified by the prefix in the subnet router anycast address.

Figure 17: Subnet Router Anycast Address Format

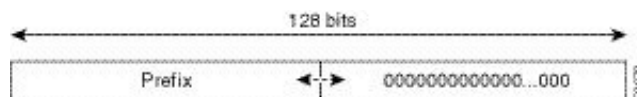

IPv6 Multicast Addresses

An IPv6 multicast address is an IPv6 address that has a prefix of FF00::/8 (1111 1111). An IPv6 multicast address is an identifier for a set of interfaces that belong to different nodes. A packet sent to a multicast address is delivered to all interfaces identified by the multicast address. The second octet following the prefix defines the lifetime and scope of the multicast address. A permanent multicast address has a lifetime parameter equal to 0; a temporary multicast address has a lifetime parameter equal to 1. A multicast address that has the scope of a node, link, site, or organization, or a global scope, has a scope parameter of 1, 2, 5, 8, or E, respectively. For example, a multicast address with the prefix FF02::/16 is a permanent multicast address with a link scope. The following figure shows the format of the IPv6 multicast address.

Figure 18: IPv6 Multicast Address Format

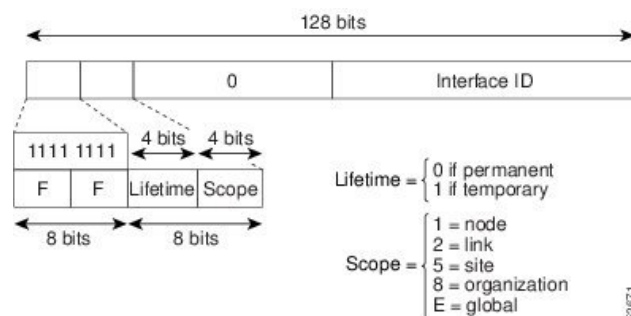

IPv6 nodes (hosts and routers) are required to join (where received packets are destined for) the following multicast groups:

- All-nodes multicast group FF02:0:0:0:0:0:1 (the scope is link-local)

- Solicited-node multicast group FF02:0:0:0:1:FF00:0000/104 for each of its assigned unicast and anycast addresses

IPv6 routers must also join the all-routers multicast group FF02:0:0:0:0:0:2 (the scope is link-local).

The solicited-node multicast address is a multicast group that corresponds to an IPv6 unicast or anycast address. IPv6 nodes must join the associated solicited-node multicast group for every unicast and anycast address to which they are assigned. The IPv6 solicited-node multicast address has the prefix FF02:0:0:0:1:FF00:0000/104 concatenated with the 24 low-order bits of a corresponding IPv6 unicast or anycast address (see the figure below). For example, the solicited-node multicast address that corresponds to the IPv6 address 2037::01:800:200E:8C6C is FF02::1:FF0E:8C6C. Solicited-node addresses are used in neighbor solicitation messages.

Figure 19: IPv6 Solicited-Node Multicast Address Format

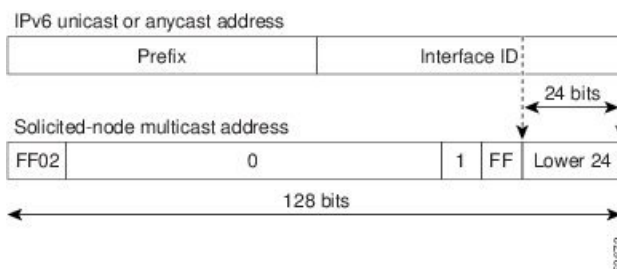

Note IPv6 has no broadcast addresses. IPv6 multicast addresses are used instead of broadcast addresses.

LPM Routing Modes

By default, Cisco NX-OS programs routes in a hierarchical fashion to allow for the longest prefix match (LPM) on the device. However, you can configure the device for different routing modes to support more LPM route entries.

The following tables list the LPM routing modes that are supported on Cisco Nexus 9000 Series switches.

Table 11: LPM Routing Modes for Cisco Nexus 9200 Platform Switches

LPM Routing Mode	CLI Command
Default system routing mode	
LPM dual-host routing mode	system routing template-dual-stack-host-scale
LPM heavy routing mode	system routing template-lpm-heavy



Note Cisco Nexus 9200 platform switches do not support the **system routing template-lpm-heavy** mode for IPv4 Multicast routes. Make sure to reset LPM's maximum limit to 0.

Table 12: LPM Routing Modes for Cisco Nexus 9300 Platform Switches

LPM Routing Mode	Broadcom T2 Mode	CLI Command
Default system routing mode	3	
ALPM routing mode	4	system routing max-mode 13

Table 13: LPM Routing Modes for Cisco Nexus 9300-EX/FX/FX2/FX3/GX Platform Switches

LPM Routing Mode	CLI Command
LPM dual-host routing mode	system routing template-dual-stack-host-scale
LPM heavy routing mode	system routing template-lpm-heavy
LPM Internet-peering mode	system routing template-internet-peering

Table 14: LPM Routing Modes for Cisco Nexus 9500 Platform Switches with 9700-EX and 9700-FX Line Cards

LPM Routing Mode	Broadcom T2 Mode	CLI Command
Default system routing mode	3 (for line cards); 4 (for fabric modules)	
Max-host routing mode	2 (for line cards); 3 (for fabric modules)	system routing max-mode host
Nonhierarchical routing mode	3 (for line cards); 4 with max-13-mode option (for line cards)	system routing non-hierarchical-routing [max-13-mode]
64-bit ALPM routing mode	Submode of mode 4 (for fabric modules)	system routing mode hierarchical 64b-alpm
LPM heavy routing mode		system routing template-lpm-heavy Note This mode is supported only for Cisco Nexus 9508 switches with the 9732C-EX line card.

LPM Routing Mode	Broadcom T2 Mode	CLI Command
LPM Internet-peering mode		system routing template-internet-peering Note This mode is supported only for the following Cisco Nexus 9500 Platform Switches: <ul style="list-style-type: none"> • Cisco Nexus 9500 platform switches with 9700-EX line cards. • Cisco Nexus 9500-FX platform switches (Cisco NX-OS release 7.0(3)I7(4) and later) • Cisco 9500-R platform switches (Cisco NX-OS release 9.3(1) and later)
LPM dual-host routing mode		

Table 15: LPM Routing Modes for Cisco Nexus 9500-R Platform Switches with 9600-R Line Cards

LPM Routing Mode	CLI Command
LPM Internet-peering mode	system routing template-internet-peering (Cisco NX-OS release 9.3(1) and later)

Host to LPM Spillover

Beginning with Cisco NX-OS Release 7.0(3)I5(1), host routes can be stored in the LPM table in order to achieve a larger host scale. In ALPM mode, the switch allows fewer host routes. If you add more host routes than the supported scale, the routes that are spilled over from the host table take the space of the LPM routes in the LPM table. The total number of LPM routes allowed in that mode is reduced by the number of host routes stored. This feature is supported on Cisco Nexus 9300 and 9500 platform switches.

In the default system routing mode, Cisco Nexus 9300 platform switches are configured for higher host scale and fewer LPM routes, and the LPM space can be used to store more host routes. For Cisco Nexus 9500 platform switches, only the default system routing and nonhierarchical routing modes support this feature on line cards. Fabric modules do not support this feature.

Virtualization Support

IPv6 supports virtual routing and forwarding (VRF) instances.

IPv6 Routes with ECMP

If all next-hops for a route are glean, drop, or punt, all next-hops are programmed as-is in the Multipath hardware table.

If some next-hops for a route are glean, drop, or punt, and the remaining next-hops are not, then only non glean, drop, or punt next-hops are programmed in the Multipath hardware table.

When a specific next-hop for ECMP route is resolved (ARP/IPV6 ND resolved), then the Multipath hardware table is updated accordingly.

Prerequisites for IPv6

IPv6 has the following prerequisites:

- You must be familiar with IPv6 basics such as IPv6 addressing and IPv6 header information.
- Ensure that you follow the memory/processing guidelines when you make a device a dual-stack device (IPv4/IPv6).

Guidelines and Limitations for IPv6

IPv6 has the following configuration guidelines and limitations:

- Cisco Nexus 9300-EX and Cisco Nexus 9300-FX2 platform switches configured for internet-peering mode might not have sufficient hardware capacity to install full IPv4 and IPv6 Internet routes simultaneously.
- IPv6 packets are transparent to Layer 2 LAN switches because the switches do not examine Layer 3 packet information before forwarding IPv6 frames. IPv6 hosts can be directly attached to Layer 2 LAN switches.
- You can configure multiple IPv6 global addresses within the same prefix on an interface. However, multiple IPv6 link-local addresses on an interface are not supported.
- Usage of IPv6 LLA requires the TCAM Region for **ing-sup** to be re-carved from the default value of 512 to 768. This step requires a copy run start and reload
- IPv6 static route next-hop link-local addresses cannot be configured at any local interface.
- You must define the BGP update source when using a link-local IPv6 address.
- Because RFC 3879 deprecates the use of site-local addresses, you should configure private IPv6 addresses according to the recommendations of unique local addressing (ULA) in RFC 4193.
- For Cisco Nexus 9500-R platform switches, internet-peering mode is only intended to be used with the prefix pattern as distributed in the global internet routing table. In this mode, other prefix distributions/patterns can operate, but not predictably. As a result, maximum achievable LPM/LEM scale is reliable only when the prefix patterns are actual internet prefix patterns. In Internet-peering mode, if route prefix patterns other than those in the global internet routing table are used, the switch might not successfully achieve documented scalability numbers.

- LPM heavy routing mode is supported on Cisco Nexus **9500** series switches with **9700-EX**, **-FX**, and **-GX** series modules.
- Beginning with Cisco NX-OS Release 10.2(3)F, syslog will be printed when IPv6 redirect message is triggered based on the configured interval.
- Beginning with Cisco NX-OS Release 10.3(1)F, static routing is supported on the Cisco Nexus 9808 switches.
- Beginning with Cisco NX-OS Release 10.4(1)F, static routing is supported on the Cisco Nexus 9804 switches.
- Beginning with Cisco NX-OS Release 10.3(1)F, dynamic routing is supported on the Cisco Nexus 9808 switches.
- Beginning with Cisco NX-OS Release 10.4(1)F, dynamic routing is supported on the Cisco Nexus 9804 switches.
- Beginning with Cisco NX-OS Release 10.3(3)F, IPv6 Compute Node IP Auto-Configuration feature is supported on Cisco NX-OS 9000 series platform switches with the following limitations:
 - The RA prefix must be configured as offlink, with the prefix length of 64.
 - If there is a multi-homed compute node, same RA prefix must be configured on both L1 and L2 switches.
- Beginning with Cisco NX-OS Release 10.4(1)F, dynamic routing is supported on Cisco Nexus X98900CD-A and X9836DM-A line cards with 9808 and 9804 switches.
- Beginning with Cisco NX-OS Release 10.4(1)F, static routing is supported on Cisco Nexus X98900CD-A and X9836DM-A line cards with 9808 and 9804 switches.

Configuring IPv6

Configuring IPv6 Addressing

You must configure an IPv6 address on an interface so that the interface can forward IPv6 traffic. When you configure a global IPv6 address on an interface, it automatically configures a link-local address and activates IPv6 for that interface.

SUMMARY STEPS

1. **configure terminal**
2. **interface ethernet *number***
3. **ipv6 address {*address* [*eui64*] [*route-preference preference*] [*secondary*] [*tag tag-id*] or *ipv6 address ipv6-address use-link-local-only***
4. (Optional) **show ipv6 interface**
5. (Optional) **copy running-config startup-config**

DETAILED STEPS

	Command or Action	Purpose
Step 1	configure terminal Example: switch# configure terminal switch(config)#	Enters global configuration mode.
Step 2	interface ethernet <i>number</i> Example: switch(config)# interface ethernet 2/3 switch(config-if)#	Enters interface configuration mode.
Step 3	ipv6 address {<i>address</i> [eui64] [route-preference preference] [secondary] [tag tag-id] or ipv6 address <i>ipv6-address</i> use-link-local-only} Example: switch(config-if)# ipv6 address 2001:0DB8::1/10 or switch(config-if)# ipv6 address use-link-local-only	Specifies an IPv6 address assigned to the interface and enables IPv6 processing on the interface. Entering the ipv6 address command configures global IPv6 addresses with an interface identifier (ID) in the low-order 64 bits of the IPv6 address. Only the 64-bit network prefix for the address needs to be specified; the last 64 bits are automatically computed from the interface ID. Entering the ipv6 address use-link-local-only command configures a link-local address on the interface that is used instead of the link-local address that is automatically configured when IPv6 is enabled on the interface. This command enables IPv6 processing on an interface without configuring an IPv6 address.
Step 4	(Optional) show ipv6 interface Example: switch(config-if)# show ipv6 interface	Displays interfaces configured for IPv6.
Step 5	(Optional) copy running-config startup-config Example: switch(config-if)# copy running-config startup-config	Saves this configuration change.

Example

This example shows how to configure an IPv6 address:

```
switch# configure terminal
switch(config)# interface ethernet 3/1
switch(config-if)# ipv6 address ?
A::B::C:D/LEN IPv6 prefix format: xxxx:xxxx/ml, xxxx:xxxx::/ml,
xxxx::xx/128
use-link-local-only Enable IPv6 on interface using only a single link-local
address
switch(config-if)# ipv6 address 2001:db8::/64 eui64
```

This example shows how to display an IPv6 interface:

```

switch(config-if)# show ipv6 interface ethernet 3/1
Ethernet3/1, Interface status: protocol-down/link-down/admin-down, iod: 36
  IPv6 address: 2001:db8:0000:0000:0218:baff:fed8:239d
  IPv6 subnet: 2001:db8::/64
  IPv6 link-local address: fe80::0218:baff:fed8:239d (default)
  IPv6 multicast routing: disabled
  IPv6 multicast groups locally joined:
    ff02::0001:ffd8:239d ff02::0002 ff02::0001 ff02::0001:ffd8:239d
  IPv6 multicast (S,G) entries joined: none
  IPv6 MTU: 1500 (using link MTU)
  IPv6 RP inbound packet-filtering policy: none
  IPv6 RP outbound packet-filtering policy: none
  IPv6 inbound packet-filtering policy: none
  IPv6 outbound packet-filtering policy: none
  IPv6 interface statistics last reset: never
  IPv6 interface RP-traffic statistics: (forwarded/originated/consumed)
    Unicast packets: 0/0/0
    Unicast bytes: 0/0/0
    Multicast packets: 0/0/0
    Multicast bytes: 0/0/0

```

Configuring Max-Host Routing Mode (Cisco Nexus 9500 Platform Switches Only)

By default, the device programs routes in a hierarchical fashion (with fabric modules that are configured to be in mode 4 and line card modules that are configured to be in mode 3), which allows for longest prefix match (LPM) and host scale on the device.

You can modify the default LPM and host scale to program more hosts in the system, as might be required when the node is positioned as a Layer-2 to Layer-3 boundary node.



Note If you want to further scale the entries in the LPM table, see the [Configuring Nonhierarchical Routing Mode \(Cisco Nexus 9500 Series Switches Only\)](#) section to configure the device to program all the Layer 3 IPv4 and IPv6 routes on the line cards and none of the routes on the fabric modules.



Note This configuration impacts both the IPv4 and IPv6 address families.



Note For the max-host routing mode scale numbers, see the [Cisco Nexus 9000 Series NX-OS Verified Scalability Guide](#).

SUMMARY STEPS

1. **configure terminal**
2. **[no] system routing max-mode host**
3. (Optional) **show forwarding route summary**
4. **copy running-config startup-config**

5. reload

DETAILED STEPS

	Command or Action	Purpose
Step 1	configure terminal Example: switch# configure terminal switch(config)#	Enters global configuration mode.
Step 2	[no] system routing max-mode host Example: switch(config)# system routing max-mode host	Puts the line cards in Broadcom T2 mode 2 and the fabric modules in Broadcom T2 mode 3 to increase the number of supported hosts.
Step 3	(Optional) show forwarding route summary Example: switch(config)# show forwarding route summary	Displays the LPM routing mode.
Step 4	copy running-config startup-config Example: switch(config)# copy running-config startup-config	Saves this configuration change.
Step 5	reload Example: switch(config)# reload	Reboots the entire device.

Configuring Nonhierarchical Routing Mode (Cisco Nexus 9500 Series Switches Only)

If the host scale is small (as in a pure Layer 3 deployment), we recommend programming the longest prefix match (LPM) routes in the line cards to improve convergence performance. Doing so programs routes and hosts in the line cards and does not program any routes in the fabric modules.



Note This configuration impacts both the IPv4 and IPv6 address families.

SUMMARY STEPS

1. **configure terminal**
2. **[no] system routing non-hierarchical-routing [max-l3-mode]**
3. (Optional) **show forwarding route summary**
4. **copy running-config startup-config**
5. **reload**

DETAILED STEPS

	Command or Action	Purpose
Step 1	configure terminal Example: <pre>switch# configure terminal switch(config)#</pre>	Enters global configuration mode.
Step 2	[no] system routing non-hierarchical-routing [max-l3-mode] Example: <pre>switch(config)# system routing non-hierarchical-routing max-l3-mode</pre>	Puts the line cards in Broadcom T2 mode 3 (or Broadcom T2 mode 4 if you use the max-l3-mode option) to support a larger LPM scale. As a result, all of the IPv4 and IPv6 routes will be programmed on the line cards rather than on the fabric modules.
Step 3	(Optional) show forwarding route summary Example: <pre>switch(config)# show forwarding route summary Mode 3: 120K IPv4 Host table 16k LPM table (> 65 < 127 1k entry reserved) Mode 4: 16k V4 host/4k V6 host 128k v4 LPM/20K V6 LPM</pre>	Displays the LPM mode.
Step 4	copy running-config startup-config Example: <pre>switch(config)# copy running-config startup-config</pre>	Saves this configuration change.
Step 5	reload Example: <pre>switch(config)# reload</pre>	Reboots the entire device.

Configuring 64-Bit ALPM Routing Mode (Cisco Nexus 9500 Platform Switches Only)

You can use the 64-bit algorithmic longest prefix match (ALPM) feature to manage IPv4 and IPv6 route table entries. In 64-bit ALPM routing mode, the device can store more route entries. In this mode, you can program one of the following:

- 80,000 IPv6 entries and no IPv4 entries
- No IPv6 entries and 128,000 IPv4 entries
- x IPv6 entries and y IPv4 entries, where $2x + y \leq 128,000$



Note This configuration impacts both the IPv4 and IPv6 address families.



Note For the 64-bit ALPM routing mode scale numbers, see the [Cisco Nexus 9000 Series NX-OS Verified Scalability Guide](#).

SUMMARY STEPS

1. **configure terminal**
2. **[no] system routing mode hierarchical 64b-alpm**
3. (Optional) **show forwarding route summary**
4. **copy running-config startup-config**
5. **reload**

DETAILED STEPS

	Command or Action	Purpose
Step 1	configure terminal Example: <pre>switch# configure terminal switch(config)#</pre>	Enters global configuration mode.
Step 2	[no] system routing mode hierarchical 64b-alpm Example: <pre>switch(config)# system routing mode hierarchical 64b-alpm</pre>	Causes all IPv4 and IPv6 LPM routes with a mask length that is less than or equal to 64 to be programmed in the fabric module. All host routes for IPv4 and IPv6 and all LPM routes with a mask length of 65–127 are programmed in the line card.
Step 3	(Optional) show forwarding route summary Example: <pre>switch(config)# show forwarding route summary</pre>	Displays the LPM mode.
Step 4	copy running-config startup-config Example: <pre>switch(config)# copy running-config startup-config</pre>	Saves this configuration change.
Step 5	reload Example: <pre>switch(config)# reload</pre>	Reboots the entire device.

Configuring ALPM Routing Mode (Cisco Nexus 9300 Platform Switches Only)

You can configure Cisco Nexus 9300 platform switches to support more LPM route entries.



Note This configuration impacts both the IPv4 and IPv6 address families.



Note For ALPM routing mode scale numbers, see the [Cisco Nexus 9000 Series NX-OS Verified Scalability Guide](#).

SUMMARY STEPS

1. **configure terminal**
2. **[no] system routing max-mode l3**
3. (Optional) **show forwarding route summary**
4. **copy running-config startup-config**
5. **reload**

DETAILED STEPS

	Command or Action	Purpose
Step 1	configure terminal Example: <pre>switch# configure terminal switch(config)#</pre>	Enters global configuration mode.
Step 2	[no] system routing max-mode l3 Example: <pre>switch(config)# system routing max-mode l3</pre>	Puts the device in Broadcom T2 mode 4 to support a larger LPM scale.
Step 3	(Optional) show forwarding route summary Example: <pre>switch(config)# show forwarding route summary</pre>	Displays the LPM mode.
Step 4	copy running-config startup-config Example: <pre>switch(config)# copy running-config startup-config</pre>	Saves this configuration change.
Step 5	reload Example: <pre>switch(config)# reload</pre>	Reboots the entire device.

Configuring IPv6 Neighbor Discovery

You can configure IPv6 neighbor discovery on the router. NDP enables IPv6 nodes and routers to determine the link-layer address of a neighbor on the same link, find neighboring routers, and keep track of neighbors.

Before you begin

You must first enable IPv6 on the interface.

SUMMARY STEPS

1. **configure terminal**
2. **interface ethernet *number***
3. **ipv6 nd [hop-limit *hop-limit* | managed-config-flag | mtu *mtu* | ns-interval *interval* | other-config-flag | prefix | ra-interval *interval* | ra-lifetime *lifetime* | reachable-time *time* | redirects | retrans-timer *time* | suppress-ra]**
4. (Optional) **show ip nd interface**
5. (Optional) **copy running-config startup-config**

DETAILED STEPS

	Command or Action	Purpose
Step 1	configure terminal Example: <pre>switch# configure terminal switch(config)#</pre>	Enters global configuration mode.
Step 2	interface ethernet <i>number</i> Example: <pre>switch(config)# interface ethernet 2/3 switch(config-if)#</pre>	Enters interface configuration mode.
Step 3	ipv6 nd [hop-limit <i>hop-limit</i> managed-config-flag mtu <i>mtu</i> ns-interval <i>interval</i> other-config-flag prefix ra-interval <i>interval</i> ra-lifetime <i>lifetime</i> reachable-time <i>time</i> redirects retrans-timer <i>time</i> suppress-ra] Example: <pre>switch(config-if)# ipv6 nd prefix</pre>	Specifies an IPv6 address assigned to the interface and enables IPv6 processing on the interface. <ul style="list-style-type: none"> • hop-limit— Advertises the hop limit in IPv6 neighbor discovery packets. The range is from 0 to 255. • managed-config-flag— Advertises in ICMPv6 router-advertisement messages to use stateful address auto-configuration to obtain address information. • mtu— Advertises the maximum transmission unit (MTU) in ICMPv6 router-advertisement messages on this link. The range is from 1280 to 65535 bytes. • ns-interval— Configures the retransmission interval between IPv6 neighbor solicitation messages. The range is from 1000 to 3600000 milliseconds. • other-config-flag— Indicates in ICMPv6 router-advertisement messages that hosts use stateful

	Command or Action	Purpose
		<p>auto configuration to obtain nonaddress related information.</p> <ul style="list-style-type: none"> • prefix— Advertises the IPv6 prefix in the router-advertisement messages. • ra-interval— Configures the interval between sending ICMPv6 router-advertisement messages. The range is from 4 to 1800 seconds. • ra-lifetime— Advertises the lifetime of a default router in ICMPv6 router-advertisement messages. The range is from 0 to 9000 seconds. • reachable-time— Advertises the time when a node considers a neighbor up after receiving a reachability confirmation in ICMPv6 router-advertisement messages. The range is from 0 to 9000 seconds. • redirects— Enables sending ICMPv6 redirect messages. <p>Note When disabling IPv6 redirects, IPv4 redirects should also be disabled as some IPv6 packets may still be leaked to the CPU.</p> <ul style="list-style-type: none"> • retrans-timer— time-Advertises the time between neighbor-solicitation messages in ICMPv6 router-advertisement messages. The range is from 0 to 9000 seconds. • suppress-ra— Disables sending ICMPv6 router-advertisement messages.
Step 4	(Optional) show ip nd interface Example: <pre>switch(config-if)# show ip interface</pre>	Displays interfaces configured for IPv6 neighbor discovery.
Step 5	(Optional) copy running-config startup-config Example: <pre>switch(config-if)# copy running-config startup-config</pre>	Saves this configuration change.

Example

This example shows how to configure IPv6 neighbor discovery reachable time:

```
switch# configure terminal
switch(config)# interface ethernet 3/1
switch(config-if)# ipv6 nd reachable-time 10
```

This example shows how to display an IPv6 interface:

```
switch# configure terminal
switch(config)# show ipv6 nd interface ethernet 3/1
ICMPv6 ND Interfaces for VRF "default"
Ethernet3/1, Interface status: protocol-down/link-down/admin-down
IPv6 address: 0dc3:0dc3:0000:0000:0218:baff:fed8:239d
ICMPv6 active timers:
Last Neighbor-Solicitation sent: never
Last Neighbor-Advertisement sent: never
Last Router-Advertisement sent: never
Next Router-Advertisement sent in: 0.000000
Router-Advertisement parameters:
Periodic interval: 200 to 600 seconds
Send "Managed Address Configuration" flag: false
Send "Other Stateful Configuration" flag: false
Send "Current Hop Limit" field: 64
Send "MTU" option value: 1500
Send "Router Lifetime" field: 1800 secs
Send "Reachable Time" field: 10 ms
Send "Retrans Timer" field: 0 ms
Neighbor-Solicitation parameters:
NS retransmit interval: 1000 ms
ICMPv6 error message parameters:
Send redirects: false
Send unreachable: false
```

Optional IPv6 Neighbor Discovery

You can use the following optional IPv6 Neighbor Discovery commands:

Table 16:

Command	Purpose
ipv6 nd hop-limit	Configures the maximum number of hops used in router advertisements and all IPv6 packets that are originated by the router.
ipv6 nd managed-config-flag	Sets the managed address configuration flag in IPv6 router advertisements.
ipv6 nd mtu	Sets the maximum transmission unit (MTU) size of IPv6 packets sent on an interface.
ipv6 nd ns-interval	Configures the interval between IPv6 neighbor solicitation retransmissions on an interface.
ipv6 nd other-config-flag	Configures the other stateful configuration flag in IPv6 router advertisements.
ipv6 nd ra-interval	Configures the interval between IPv6 router advertisement (RA) transmissions on an interface.
ipv6 nd ra-lifetime	Configures the router lifetime value in IPv6 router advertisements on an interface.

Command	Purpose
ipv6 nd reachable-time	Configures the amount of time that a remote IPv6 node is considered reachable after some reachability confirmation event has occurred.
ipv6 nd redirects	Enables ICMPv6 redirect messages to be sent.
ipv6 nd retrans-timer	Configures the advertised time between neighbor solicitation messages in router advertisements.
ipv6 nd suppress-ra	Suppresses IPv6 router advertisement transmissions on a LAN interface.

Configuring IPv6 Packet Verification

Cisco NX-OS supports an Intrusion Detection System (IDS) that checks for IPv6 packet verification. You can enable or disable these IDS checks.

To enable IDS checks, use the following commands in global configuration mode:

Table 17:

hardware ip verify address {destination zero identical reserved source multicast }	<p>Performs the following IDS checks on the IPv6 address:</p> <ul style="list-style-type: none"> • destination zero —Drops IPv6 packets if the destination IP address is ::. • identical —Drops IPv6 packets if the source IPv6 address is identical to the destination IPv6 address. • reserved —Drops IPv6 packets if the IPv6 address is ::1. • source multicast —Drops IPv6 packets if the IPv6 source address is in the FF00::/8 range (multicast).
---	--

hardware ipv6 verify length { consistent maximum { max-frag max-tcp udp } }	Performs the following IDS checks on the IPv6 address: <ul style="list-style-type: none"> • consistent —Drops IPv6 packets where the Ethernet frame size is greater than or equal to the IPv6 packet length plus the Ethernet header. • maximum max-frag —Drops IPv6 packets if the formula (IPv6 Payload Length – IPv6 Extension Header Bytes) + (Fragment Offset * 8) is greater than 65536. • maximum max-tcp —Drops IPv6 packets if the TCP length is greater than the IP payload length. • maximum udp —Drops IPv6 packets if the IPv6 payload length is less than the UDP packet length.
hardware ipv6 verify tcp tiny-frag	Drops TCP packets if the IPv6 fragment offset is 1, or if the IPv6 fragment offset is 0 and the IP payload length is less than 16.
hardware ipv6 verify version	Drops IPv6 packets if the EtherType is not set to 6 (IPv6).

Use the show hardware forwarding ip verify command to display the IPv6 packet verification configuration.

Configuring IPv6 Stateless Autoconfiguration

SUMMARY STEPS

1. **configure terminal**
2. **interface management** *number*
3. **ipv6 address autoconfig**
4. **ipv6 address autoconfig default**

DETAILED STEPS

	Command or Action	Purpose
Step 1	configure terminal Example: Device# configure terminal	Enters global configuration mode.
Step 2	interface management <i>number</i> Example: switch(config)# interface mgmt0	Specifies an interface type and number, and places the device in interface configuration mode.

	Command or Action	Purpose
Step 3	ipv6 address autoconfig Example: switch(config-if)# ipv6 address autoconfig	Enables automatic configuration of IPv6 addresses using stateless autoconfiguration on the management interface.
Step 4	ipv6 address autoconfig default Example: switch(config-if)# ipv6 address autoconfig default	Enables automatic configuration of IPv6 addresses using stateless autoconfiguration on the management interface and adds a default route with next-hop as that of the link-local address received in the router advertisement.

Example

This example shows how to use the `show ipv6 interface` command to display and verify that IPv6 addresses are configured on the management interface. Information displays the all the IPV6 addresses configured on the interface including the SLAAC generated addresses. It also indicates whether or not the stateless address autoconfig is enabled on the interface:

```
Device# show ipv6 interface mgmt 0

IPv6 Interface Status for VRF "management"(2)
mgmt0, Interface status: protocol-up/link-up/admin-up, iod: 2
IPv6 address:
1955::2f6:63ff:fe8b:c9f8/64 [VALID]
IPv6 subnet: 1955::/64
IPv6 link-local address: fe80::2f6:63ff:fe8b:c9f8 (default) [VALID]
....
Stateless autoconfig configured on the interface
```

This example shows how to use the `show ipv6 route vrf management` command to display the IPv6 routing table for VRF management:

```
Device# show ipv6 route vrf management

IPv6 Routing Table for VRF "management"
'*' denotes best ucast next-hop
 '**' denotes best mcast next-hop
 '[x/y]' denotes [preference/metric]
 0::/0, ubest/mbest: 1/0
 *via fe80::2f6:63ff:fe8b:c9ff, mgmt0, [2/0], 00:02:00, icmpv6
 1955::/64, ubest/mbest: 1/0, attached
 *via 1955::2f6:63ff:fe8b:c9f8, mgmt0, [0/0], 15:59:22, direct,
 1955::2f6:63ff:fe8b:c9f8/128, ubest/mbest: 1/0, attached
 *via 1955::2f6:63ff:fe8b:c9f8, mgmt0, [0/0], 15:59:22, local
```

This example shows how to use the `show ipv6 nd int mgmt` command to display the ICMPv6 ND interfaces for VRF management:

```
Device# show ipv6 nd int mgmt 0

ICMPv6 ND Interfaces for VRF "management"
mgmt0, Interface status: protocol-up/link-up/admin-up
IPv6 address:
1955::2f6:63ff:fe8b:c9f8/64 [VALID]
IPv6 link-local address: fe80::2f6:63ff:fe8b:c9f8 [VALID]
.....
Subnets configured via SLAAC and their states:
```

```
Prefix 1955::/64[PREFERRED] Preferred lifetime left: 6d23h Valid lifetime left: 4w1d
```

Configuring LPM Heavy Routing Mode (Cisco Nexus 9200 and 9300-EX Platform Switches and 9732C-EX Line Card Only)

Beginning with Cisco NX-OS Release 7.0(3)I4(4), you can configure LPM heavy routing mode in order to support significantly more LPM route entries. Only the Cisco Nexus 9200 and 9300-EX Series switches and the Cisco Nexus 9508 switch with an 9732C-EX line card support this routing mode.



Note This configuration impacts both the IPv4 and IPv6 address families.



Note For LPM heavy routing mode scale numbers, see the [Cisco Nexus 9000 Series NX-OS Verified Scalability Guide](#).

SUMMARY STEPS

1. **configure terminal**
2. **[no] system routing template-lpm-heavy**
3. (Optional) **show system routing mode**
4. **copy running-config startup-config**
5. **reload**

DETAILED STEPS

	Command or Action	Purpose
Step 1	configure terminal Example: <pre>switch# configure terminal switch(config)#</pre>	Enters global configuration mode.
Step 2	[no] system routing template-lpm-heavy Example: <pre>switch(config)# system routing template-lpm-heavy</pre>	Puts the device in LPM heavy routing mode to support a larger LPM scale.
Step 3	(Optional) show system routing mode Example: <pre>switch(config)# show system routing mode Configured System Routing Mode: LPM Heavy Applied System Routing Mode: LPM Heavy</pre>	Displays the LPM routing mode.
Step 4	copy running-config startup-config Example:	Saves this configuration change.

	Command or Action	Purpose
	<code>switch(config)# copy running-config startup-config</code>	
Step 5	reload Example: <code>switch(config)# reload</code>	Reboots the entire device.

Configuring LPM Internet-Peering Routing Mode (Cisco Nexus 9500-R Platform Switches, Cisco Nexus 9300-EX Platform Switches and Cisco Nexus 9000 Series Switches with 9700-EX Line Cards Only)

Beginning with Cisco NX-OS Release 7.0(3)I6(1), you can configure LPM Internet-peering routing mode in order to support IPv4 and IPv6 LPM Internet route entries. This mode supports dynamic Trie (tree bit lookup) for IPv4 prefixes (with a prefix length up to /32) and IPv6 prefixes (with a prefix length up to /83). Only the Cisco Nexus 9300-EX platform switches and Cisco Nexus 9500 platform switches with 9700-EX line cards support this routing mode.

Beginning with Cisco NX-OS Release 9.3(1), Cisco Nexus 9500-R platform switches support this routing mode.



Note This configuration impacts both the IPv4 and IPv6 address families.



Note For LPM Internet-peering routing mode scale numbers, see the [Cisco Nexus 9000 Series NX-OS Verified Scalability Guide](#). Cisco Nexus 9500-R platform switches in LPM Internet-peering mode scale out prectably only if they use internet-peering prefixes. If a Cisco Nexus 9500-R platform switch uses other prefix patterns, it might not achieve documented scalability numbers.

SUMMARY STEPS

1. **configure terminal**
2. **[no] system routing template-internet-peering**
3. (Optional) **show system routing mode**
4. **copy running-config startup-config**
5. **reload**

DETAILED STEPS

	Command or Action	Purpose
Step 1	configure terminal Example: <code>switch# configure terminal</code> <code>switch(config)#</code>	Enters global configuration mode.

	Command or Action	Purpose
Step 2	[no] system routing template-internet-peering Example: switch(config)# system routing template-internet-peering	Puts the device in LPM Internet-peering routing mode to support IPv4 and IPv6 LPM Internet route entries.
Step 3	(Optional) show system routing mode Example: switch(config)# show system routing mode Configured System Routing Mode: Internet Peering Applied System Routing Mode: Internet Peering	Displays the LPM routing mode.
Step 4	copy running-config startup-config Example: switch(config)# copy running-config startup-config	Saves this configuration change.
Step 5	reload Example: switch(config)# reload	Reboots the entire device.

Additional Configuration for LPM Internet-Peering Routing Mode

When you deploy a Cisco Nexus switch in LPM Internet-peering routing mode in a large-scale routing environment or for routes with an increased number of next hops, you need to increase the memory limits for IPv4 under the VDC resource template.

SUMMARY STEPS

1. **configure terminal**
2. (Optional) **show routing ipv4 memory estimate routes routes next-hops hops**
3. **vdc switch id id**
4. **limit-resource u4route-mem minimum min-limit maximum max-limit**
5. **exit**
6. **copy running-config startup-config**
7. **reload**

DETAILED STEPS

	Command or Action	Purpose
Step 1	configure terminal Example: switch# configure terminal switch(config)#	Enters global configuration mode.
Step 2	(Optional) show routing ipv4 memory estimate routes routes next-hops hops Example:	Displays shared memory estimates to help you determine the memory requirements for routes.

	Command or Action	Purpose
	<pre>switch(config)# show routing ipv4 memory estimate routes 262144 next-hops 32 Shared memory estimates: Current max 512 MB; 78438 routes with 64 nhs in-use 2 MB; 2642 routes with 1 nhs (average) Configured max 512 MB; 78438 routes with 64 nhs Estimate memory with fixed overhead: 1007 MB; 262144 routes with 32 nhs Estimate with variable overhead included: - With MVPN enabled VRF: 1136 MB - With OSPF route (PE-CE protocol): 1375 MB - With EIGRP route (PE-CE protocol): 1651 M</pre>	
Step 3	<p>vdc switch id id</p> <p>Example:</p> <pre>switch(config)# vdc switch id 1 switch(config-vdc)#</pre>	Specifies the VDC switch ID.
Step 4	<p>limit-resource u4route-mem minimum min-limit maximum max-limit</p> <p>Example:</p> <pre>switch(config-vdc)# limit-resource u4route-mem minimum 1024 maximum 1024</pre>	<p>Configures the limits for IPv4 memory in megabytes.</p> <p>Note Beginning with Cisco Nexus Release 10.2(2)F, this command is only applicable to the 32-bit version of the software.</p>
Step 5	<p>exit</p> <p>Example:</p> <pre>switch(config-vdc)# exit switch(config)#</pre>	Exits the VDC configuration mode.
Step 6	<p>copy running-config startup-config</p> <p>Example:</p> <pre>switch(config)# copy running-config startup-config</pre>	Saves this configuration change.
Step 7	<p>reload</p> <p>Example:</p> <pre>switch(config)# reload</pre>	Reboots the entire device.

Configuring LPM Dual-Host Routing Mode (Cisco Nexus 9200 and 9300-EX Platform Switches)

You can configure LPM heavy routing mode in order to support more LPM route entries. Only the Cisco Nexus 9200 and 9300-EX platform switches and the Cisco Nexus 9508 switch with a 9732C-EX line card support this routing mode.



Note This configuration impacts both the IPv4 and IPv6 address families.



Note For LPM heavy routing mode scale numbers, see the [Cisco Nexus 9000 Series NX-OS Verified Scalability Guide](#).

SUMMARY STEPS

1. **configure terminal**
2. **[no] system routing template-lpm-heavy**
3. (Optional) **show system routing mode**
4. **copy running-config startup-config**
5. **reload**

DETAILED STEPS

	Command or Action	Purpose
Step 1	configure terminal Example: switch# configure terminal switch(config)#	Enters global configuration mode.
Step 2	[no] system routing template-lpm-heavy Example: switch(config)# system routing template-lpm-heavy	Puts the device in LPM heavy routing mode to support a larger LPM scale.
Step 3	(Optional) show system routing mode Example: switch(config)# show system routing mode Configured System Routing Mode: LPM Heavy Applied System Routing Mode: LPM Heavy	Displays the LPM routing mode.
Step 4	copy running-config startup-config Example: switch(config)# copy running-config startup-config	Saves this configuration change.
Step 5	reload Example: switch(config)# reload	Reboots the entire device.

Configuring IPv6 Redirect Syslog

To enable/disable the IPv6 redirect syslog or change the logging interval, use the below CLIs:



Note By default, redirecting syslog will be enabled.

SUMMARY STEPS

1. **configure terminal**
2. **ipv6 redirect syslog** [*<value>*]
3. (Optional) **no ipv6 redirect syslog**

DETAILED STEPS

	Command or Action	Purpose
Step 1	configure terminal Example: <pre>switch# configure terminal switch(config)#</pre>	Enters global configuration mode.
Step 2	ipv6 redirect syslog [<i><value></i>] Example: <pre>switch(config)# ip redirect syslog 60 switch(config)#</pre>	Configures the syslog for excessive IPv6 redirect messages. <ul style="list-style-type: none"> • ipv6 redirect syslog: Enables the syslog for IPv6 redirect messages. • <i>value</i>: Configures the logging interval. The range is minimum 30 seconds to maximum 1800 seconds. The default interval is 60 seconds.
Step 3	(Optional) no ipv6 redirect syslog Example: <pre>switch(config)# no ipv6 redirect syslog</pre>	Disables the syslog for excessive IPv6 redirect messages.

Verifying the IPv6 Configuration

To display the IPv6 configuration, perform one of the following tasks:

Command	Purpose
show hardware forwarding ip verify	Displays the IPv4 and IPv6 packet verification configuration.
show ipv6 interface	Displays IPv6-related interface information.
show ipv6 adjacency	Displays the adjacency table.
show system routing mode	Displays the LPM routing mode.
show ipv6 icmp	Displays ICMPv6 information.

Command	Purpose
<code>show ipv6 nd</code>	Displays IPv6 neighbor discovery interface information.
<code>show ipv6 neighbor</code>	Displays IPv6 neighbor entry.
<code>show ipv6 nd addr-registry</code>	Displays the IPv6 address registry entries of the compute node.

Configuration Examples for IPv6

The following example shows how to configure IPv6:

```
switch# configure terminal
switch(config)# interface ethernet 3/1
switch(config-if)# ipv6 address 2001:db8::/64 eui64
switch(config-if)# ipv6 nd reachable-time 10
```



CHAPTER 5

Configuring DNS

This chapter describes how to configure the Domain Name Server (DNS) client on the Cisco NX-OS device.

This chapter includes the following sections:

- [About DNS Clients, on page 91](#)
- [High Availability, on page 92](#)
- [Virtualization Support, on page 92](#)
- [Prerequisites for DNS Clients, on page 92](#)
- [Guidelines and Limitations for DNS Clients, on page 92](#)
- [Default Settings for DNS Clients, on page 93](#)
- [Configuring DNS Clients, on page 93](#)

About DNS Clients

DNS Client Overview

If your network devices require connectivity with devices in networks for which you do not control the name assignment, you can assign device names that uniquely identify your devices within the entire internetwork using the domain name server (DNS). DNS uses a hierarchical scheme for establishing host names for network nodes, which allows local control of the segments of the network through a client-server scheme. The DNS system can locate a network device by translating the hostname of the device into its associated IP address.

On the Internet, a domain is a portion of the naming hierarchy tree that refers to general groupings of networks based on the organization type or geography. Domain names are pieced together with periods (.) as the delimiting characters. For example, Cisco is a commercial organization that the Internet identifies by a *com* domain, so its domain name is *cisco.com*. A specific hostname in this domain, the File Transfer Protocol (FTP) system, for example, is identified as *ftp.cisco.com*.

Name Servers

Name servers keep track of domain names and know the parts of the domain tree for which they have complete information. A name server may also store information about other parts of the domain tree. To map domain names to IP addresses in Cisco NX-OS, you must identify the hostnames, specify a name server, and enable the DNS service.

Cisco NX-OS allows you to statically map IP addresses to domain names. You can also configure Cisco NX-OS to use one or more domain name servers to find an IP address for a host name.

DNS Operation

A name server handles client-issued queries to the DNS server for locally defined hosts within a particular zone as follows:

- An authoritative name server responds to DNS user queries for a domain name that is under its zone of authority by using the permanent and cached entries in its own host table. If the query is for a domain name that is under its zone of authority but for which it does not have any configuration information, the authoritative name server replies that no such information exists.
- A name server that is not configured as the authoritative name server responds to DNS user queries by using information that it has cached from previously received query responses. If no router is configured as the authoritative name server for a zone, queries to the DNS server for locally defined hosts receive nonauthoritative responses.

Name servers answer DNS queries (forward incoming DNS queries or resolve internally generated DNS queries) according to the forwarding and lookup parameters configured for the specific domain.

High Availability

Cisco NX-OS supports stateless restarts for the DNS client. After a reboot or supervisor switchover, Cisco NX-OS applies the running configuration.

Virtualization Support

Cisco NX-OS supports multiple instances of the DNS clients that run on the same system. You can configure a DNS client. You can optionally have a different DNS client configuration in each virtual routing and forwarding (VRF) instance.

Prerequisites for DNS Clients

The DNS client has the following prerequisites:

- You must have a DNS name server on your network.

Guidelines and Limitations for DNS Clients

The DNS client has the following configuration guidelines and limitations:

- You configure the DNS client in a specific VRF. If you do not specify a VRF, Cisco NX-OS uses the default VRF.
- Beginning with Cisco NX-OS Release 7.0(3)I5(1), DNS supports IPv6 addresses.

Default Settings for DNS Clients

The table lists the default settings for DNS client parameters.

Default DNS Client Parameters

Parameters	Default
DNS client	Enabled

Configuring DNS Clients

Configuring the DNS Client

You can configure the DNS client to use a DNS server on your network.

Before you begin

Ensure that you have a domain name server on your network.

SUMMARY STEPS

1. **configure terminal**
2. **ip host** *name address1* [*address2... address6*]
3. (Optional) **ip domain-name** *name* [**use-vrf** *vrf-name*]
4. (Optional) **ip domain-list** *name* [**use-vrf** *vrf-name*]
5. (Optional) **ip name-server** *address1* [*address2... address6*] [**use-vrf** *vrf-name*]
6. (Optional) **ip domain-lookup**
7. (Optional) **show hosts**
8. (Optional) **copy running-config startup-config**

DETAILED STEPS

	Command or Action	Purpose
Step 1	configure terminal Example: <pre>switch# configure terminal switch(config)#</pre>	Enters global configuration mode.
Step 2	ip host <i>name address1</i> [<i>address2... address6</i>] Example: <pre>switch(config)# ip host cisco-rtp 192.0.2.1</pre>	Defines up to six static hostname-to-address mappings in the hostname cache. The address can be either an IPv4 address or an IPv6 address.

	Command or Action	Purpose
Step 3	(Optional) ip domain-name <i>name</i> [use-vrf <i>vrf-name</i>] Example: <pre>switch(config)# ip domain-name myserver.com</pre>	Defines the default domain name that Cisco NX-OS uses to complete unqualified hostnames. You can optionally define a VRF that Cisco NX-OS uses to resolve this domain name if it cannot be resolved in the VRF that you configured this domain name under. Cisco NX-OS appends the default domain name to any hostname that does not contain a complete domain name before starting a domain-name lookup.
Step 4	(Optional) ip domain-list <i>name</i> [use-vrf <i>vrf-name</i>] Example: <pre>switch(config)# ip domain-list mycompany.com</pre>	Defines additional domain names that Cisco NX-OS can use to complete unqualified hostnames. You can optionally define a VRF that Cisco NX-OS uses to resolve these domain names if they cannot be resolved in the VRF that you configured this domain name under. Cisco NX-OS uses each entry in the domain list to append that domain name to any hostname that does not contain a complete domain name before starting a domain-name lookup. Cisco NX-OS continues this process for each entry in the domain list until it finds a match.
Step 5	(Optional) ip name-server <i>address1</i> [<i>address2... address6</i>] [use-vrf <i>vrf-name</i>] Example: <pre>switch(config)# ip name-server 192.0.2.22</pre>	Defines up to six name servers. The address can be either an IPv4 address or an IPv6 address. You can optionally define a VRF that Cisco NX-OS uses to reach this name server if it cannot be reached in the VRF that you configured this name server under. Note Multiple DNS servers are for the case of unresponsive servers. If the first DNS server in the list replies to the DNS query with a reject, the remaining DNS servers are not queried. If the first one doesn't respond, the next DNS server in list is queried.
Step 6	(Optional) ip domain-lookup Example: <pre>switch(config)# ip domain-lookup</pre>	Enables DNS-based address translation. This feature is enabled by default.
Step 7	(Optional) show hosts Example: <pre>switch(config)# show hosts</pre>	Displays information about DNS.
Step 8	(Optional) copy running-config startup-config Example: <pre>switch(config)# copy running-config startup-config</pre>	Saves this configuration change.

Example

This example shows how to configure a default domain name and enable DNS lookup:

```
switch# configure terminal
switch(config)# ip domain-name cisco.com
switch(config)# ip name-server 192.0.2.1 use-vrf management
switch(config)# ip domain-lookup
switch(config)# copy running-config startup-config
```

Configuring Virtualization

You can configure a DNS client within a VRF. If you do not enter VRF configuration mode, your DNS client configuration applies to the default VRF.

You can optionally configure a DNS client to use a specified VRF other than the VRF under which you configured the DNS client as a backup VRF. For example, you can configure a DNS client in the Red VRF but use the Blue VRF to communicate with the DNS server if the server cannot be reached through the Red VRF.

Before you begin

Ensure that you have a domain name server on your network.

SUMMARY STEPS

1. **configure terminal**
2. **vrf context** *vrf-name*
3. (Optional) **ip domain-name** *name* [**use-vrf** *vrf-name*]
4. (Optional) **ip domain-list** *name* [**use-vrf** *vrf-name*]
5. (Optional) **ip name-server** *address1* [*address2... address6*] [**use-vrf** *vrf-name*]
6. (Optional) **show hosts**
7. (Optional) **copy running-config startup-config**

DETAILED STEPS

	Command or Action	Purpose
Step 1	configure terminal Example: <pre>switch# configure terminal switch(config)#</pre>	Enters global configuration mode.
Step 2	vrf context <i>vrf-name</i> Example: <pre>switch(config)# vrf context Red switch(config-vrf)#</pre>	Creates a VRF and enters VRF configuration mode.
Step 3	(Optional) ip domain-name <i>name</i> [use-vrf <i>vrf-name</i>] Example:	Defines the default domain name server that Cisco NX-OS uses to complete unqualified hostnames. You can optionally define a VRF that Cisco NX-OS uses to resolve this domain

	Command or Action	Purpose
	<pre>switch(config-vrf)# ip domain-name myserver.com</pre>	<p>name server if it cannot be resolved in the VRF under which you configured this domain name.</p> <p>Cisco NX-OS appends the default domain name to any hostname that does not contain a complete domain name before starting a domain-name lookup.</p>
Step 4	<p>(Optional) ip domain-list <i>name</i> [use-vrf <i>vrf-name</i>]</p> <p>Example:</p> <pre>switch(config-vrf)# ip domain-list mycompany.com</pre>	<p>Defines additional domain name servers that Cisco NX-OS can use to complete unqualified hostnames. You can optionally define a VRF that Cisco NX-OS uses to resolve this domain name server if it cannot be resolved in the VRF under which you configured this domain name.</p> <p>Cisco NX-OS uses each entry in the domain list to append that domain name to any hostname that does not contain a complete domain name before starting a domain-name lookup. Cisco NX-OS continues this process for each entry in the domain list until it finds a match.</p>
Step 5	<p>(Optional) ip name-server <i>address1</i> [<i>address2... address6</i>] [use-vrf <i>vrf-name</i>]</p> <p>Example:</p> <pre>switch(config-vrf)# ip name-server 192.0.2.22</pre>	<p>Defines up to six name servers. The address can be either an IPv4 address or an IPv6 address.</p> <p>You can optionally define a VRF that Cisco NX-OS uses to reach this name server if it cannot be reached in the VRF that you configured this name server under.</p> <p>Note Multiple DNS servers are for the case of unresponsive servers.</p> <p>If the first DNS server in the list replies to the DNS query with a reject, the remaining DNS servers are not queried. If the first one doesn't respond, the next DNS server in list is queried.</p>
Step 6	<p>(Optional) show hosts</p> <p>Example:</p> <pre>switch(config-vrf)# show hosts</pre>	Displays information about DNS.
Step 7	<p>(Optional) copy running-config startup-config</p> <p>Example:</p> <pre>switch(config)# copy running-config startup-config</pre>	Saves this configuration change.

Example

This example shows how to configure a default domain and enable DNS lookup within a VRF:

```
switch# configure terminal
switch(config)# vrf context Red
switch(config-vrf)# ip domain-name cisco.com
switch(config-vrf)# ip name-server 192.0.2.1 use-vrf management
switch(config-vrf)# copy running-config startup-config
```

Verifying the DNS Client Configuration

To display the DNS client configuration, perform one of the following tasks:

Command	Purpose
<code>show hosts</code>	Displays information about DNS.

Configuration Examples for the DNS Client

The following example shows how to establish a domain list with several alternate domain names:

```
ip domain-list csi.com
ip domain-list telecomprog.edu
ip domain-list merit.edu
```

The following example shows how to configure the hostname-to-address mapping process and specify IP DNS-based translation. The example also shows how to configure the addresses of the name servers and the default domain name.

```
ip domain-lookup
ip name-server 192.168.1.111 192.168.1.2
ip domain-name cisco.com
```



CHAPTER 6

Configuring OSPFv2

This chapter describes how to configure Open Shortest Path First version 2 (OSPFv2) for IPv4 networks on the Cisco NX-OS device.

This chapter includes the following sections:

- [About OSPFv2, on page 99](#)
- [OSPFv2 and the Unicast RIB, on page 100](#)
- [Authentication, on page 100](#)
- [Advanced Features, on page 101](#)
- [Prerequisites for OSPFv2, on page 105](#)
- [Guidelines and Limitations for OSPFv2, on page 106](#)
- [Default Settings for OSPFv2, on page 107](#)
- [Configuring Basic OSPFv2, on page 108](#)
- [Configuring Advanced OSPFv2, on page 119](#)
- [Verifying the OSPFv2 Configuration, on page 144](#)
- [Monitoring OSPFv2, on page 145](#)
- [Configuration Examples for OSPFv2, on page 146](#)
- [Additional References, on page 146](#)

About OSPFv2

OSPFv2 is an IETF link-state protocol (see the [Link-State Protocols](#) section) for IPv4 networks. An OSPFv2 router sends a special message, called a hello packet, out each OSPF-enabled interface to discover other OSPFv2 neighbor routers. Once a neighbor is discovered, the two routers compare information in the Hello packet to determine if the routers have compatible configurations. The neighbor routers try to establish adjacency, which means that the routers synchronize their link-state databases to ensure that they have identical OSPFv2 routing information. Adjacent routers share link-state advertisements (LSAs) that include information about the operational state of each link, the cost of the link, and any other neighbor information. The routers then flood these received LSAs out every OSPF-enabled interface so that all OSPFv2 routers eventually have identical link-state databases. When all OSPFv2 routers have identical link-state databases, the network is converged (see the [Convergence](#) section). Each router then uses Dijkstra's Shortest Path First (SPF) algorithm to build its route table.

You can divide OSPFv2 networks into areas. Routers send most LSAs only within one area, which reduces the CPU and memory requirements for an OSPF-enabled router.

OSPFv2 supports IPv4, while OSPFv3 supports IPv6. For more information, see [Configuring OSPFv3, on page 149](#).



Note OSPFv2 on Cisco NX-OS supports RFC 2328. This RFC introduced a different method to calculate route summary costs which is not compatible with the calculation used by RFC1583. RFC 2328 also introduced different selection criteria for AS-external paths. It is important to ensure that all routers support the same RFC. Use the **rfc1583compatibility** command if your network includes routers that are only compliant with RFC1583. The default supported RFC standard for OSPFv2 may be different for Cisco NX-OS and Cisco IOS. You must make adjustments to set the values identically. See the [OSPF RFC Compatibility Mode Example](#) section for more information.

OSPFv2 and the Unicast RIB

OSPFv2 runs the Dijkstra shortest path first algorithm on the link-state database. This algorithm selects the best path to each destination based on the sum of all the link costs for each link in the path. The resultant shortest path for each destination is then put in the OSPFv2 route table. When the OSPFv2 network is converged, this route table feeds into the unicast RIB. OSPFv2 communicates with the unicast RIB to do the following:

- Add or remove routes
- Handle route redistribution from other protocols
- Provide convergence updates to remove stale OSPFv2 routes and for stub router advertisements (see the [OSPFv2 Stub Router Advertisements](#) section)

OSPFv2 also runs a modified Dijkstra algorithm for fast recalculation for summary and external (type 3, 4, 5, and 7) LSA changes.

Authentication

You can configure authentication on OSPFv2 messages to prevent unauthorized or invalid routing updates in your network. Cisco NX-OS supports two authentication methods:

- Simple password authentication
- MD5 authentication digest

You can configure the OSPFv2 authentication for an OSPFv2 area or per interface.

Simple Password Authentication

Simple password authentication uses a simple clear-text password that is sent as part of the OSPFv2 message. The receiving OSPFv2 router must be configured with the same clear-text password to accept the OSPFv2 message as a valid route update. Because the password is in clear text, anyone who can watch traffic on the network can learn the password.

Cryptographic Authentication

Cryptographic authentication uses an encrypted password for OSPFv2 authentication. The transmitter computes a code using the packet to be transmitted and the key string, inserts the code and the key ID in the packet, and transmits the packet. The receiver validates the code in the packet by computing the code locally using the received packet and the key string (corresponding to the key ID in the packet) configured locally.

Both message digest 5 (MD5) and hash-based message authentication code secure hash algorithm (HMAC-SHA) cryptographic authentication are supported.

MD5 Authentication

You should use MD5 authentication to authenticate OSPFv2 messages. You configure a password that is shared at the local router and all remote OSPFv2 neighbors. For each OSPFv2 message, Cisco NX-OS creates an MD5 one-way message digest based on the message itself and the encrypted password. The interface sends this digest with the OSPFv2 message. The receiving OSPFv2 neighbor validates the digest using the same encrypted password. If the message has not changed, the digest calculation is identical and the OSPFv2 message is considered valid.

MD5 authentication includes a sequence number with each OSPFv2 message to ensure that no message is replayed in the network.

HMAC-SHA Authentication

Starting with Cisco NX-OS Release 7.0(3)I3(1), OSPFv2 supports RFC 5709 to allow the use of HMAC-SHA algorithms, which offer more security than MD5. The HMAC-SHA-1, HMAC-SHA-256, HMAC-SHA-384, and HMAC-SHA-512 algorithms are supported for OSPFv2 authentication.

Advanced Features

Cisco NX-OS supports advanced OSPFv3 features that enhance the usability and scalability of OSPFv2 in the network.

Stub Area

You can limit the amount of external routing information that floods an area by making it a stub area. A stub area is an area that does not allow AS External (type 5) LSAs (see the [Link-State Advertisement, on page 153](#) section). These LSAs are usually flooded throughout the local autonomous system to propagate external route information. Stub areas have the following requirements:

- All routers in the stub area are stub routers. See the [Stub Routing](#) section.
- No ASBR routers exist in the stub area.
- You cannot configure virtual links in the stub area.

The following figure shows an example of an OSPFv2 autonomous system where all routers in area 0.0.0.10 have to go through the ABR to reach external autonomous systems. Area 0.0.0.10 can be configured as a stub area.

Figure 20: Stub Area

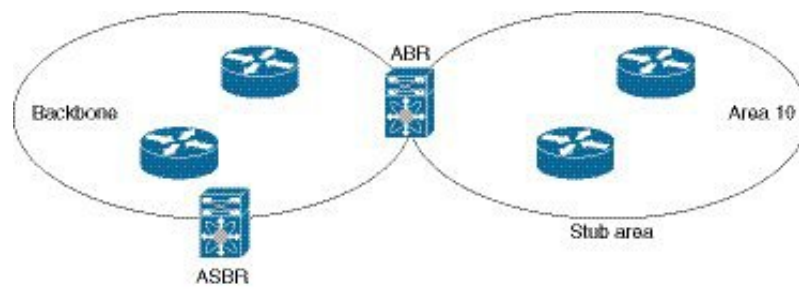

Stub areas use a default route for all traffic that needs to go through the backbone area to the external autonomous system. The default route is 0.0.0.0 for IPv4.

Not So Stubby Area

A Not-so-Stubby Area (NSSA) is similar to a stub area, except that an NSSA allows you to import autonomous system external routes within an NSSA using redistribution. The NSSA ASBR redistributes these routes and generates NSSA External (type 7) LSAs that it floods throughout the NSSA. You can optionally configure the ABR that connects the NSSA to other areas to translate this NSSA External LSA to AS External (type 5) LSAs. The ABR then floods these AS External LSAs throughout the OSPFv2 autonomous system. Summarization and filtering are supported during the translation. See the [Link-State Advertisement, on page 153](#) section for information about NSSA External LSAs.

You can, for example, use NSSA to simplify administration if you are connecting a central site using OSPFv2 to a remote site that is using a different routing protocol. Before NSSA, the connection between the corporate site border router and a remote router could not be run as an OSPFv2 stub area because routes for the remote site could not be redistributed into a stub area. With NSSA, you can extend OSPFv2 to cover the remote connection by defining the area between the corporate router and remote router as an NSSA (see the [Configuring NSSA](#) section).

The backbone Area 0 cannot be an NSSA.



Note Beginning with Cisco NX-OS Release 9.2(4), OSPF became compliant with RFC 3101 section 2.5(3). When an Area Border Router attached to a Not-so-Stubby Area receives a default route LSA with P-bit clear, it should be ignored. OSPF had been previously adding the default route under these conditions.

If you have already designed your networks with RFC non-compliant behavior and expect a default route to be added on NSSA ABR, you will see a change in behavior when you upgrade to Cisco NX-OS Release 9.2(4) and later.

Virtual Links

Virtual links allow you to connect an OSPFv2 area ABR to a backbone area ABR when a direct physical connection is not available. The figure shows a virtual link that connects Area 3 to the backbone area through Area 5.

Figure 21: Virtual Links

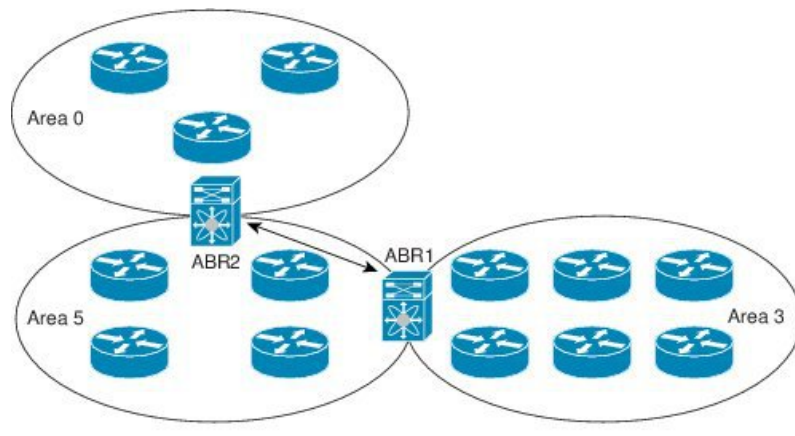

You can also use virtual links to temporarily recover from a partitioned area, which occurs when a link within the area fails, isolating part of the area from reaching the designated ABR to the backbone area.

Route Redistribution

OSPFv2 can learn routes from other routing protocols by using route redistribution. See the [Route Redistribution Overview, on page 8](#) section. You configure OSPFv2 to assign a link cost for these redistributed routes or a default link cost for all redistributed routes.

Route redistribution uses route maps to control which external routes are redistributed. You must configure a route map with the redistribution to control which routes are passed into OSPFv2. A route map allows you to filter routes based on attributes such as the destination, origination protocol, route type, route tag, and so on. You can use route maps to modify parameters in the AS External (type 5) and NSSA External (type 7) LSAs before these external routes are advertised in the local OSPFv2 autonomous system. See [Configuring Route Policy Manager](#), for information about configuring route maps.

Route Summarization

Because OSPFv2 shares all learned routes with every OSPF-enabled router, you might want to use route summarization to reduce the number of unique routes that are flooded to every OSPF-enabled router. Route summarization simplifies route tables by replacing more-specific addresses with an address that represents all the specific addresses. For example, you can replace 10.1.1.0/24, 10.1.2.0/24, and 10.1.3.0/24 with one summary address, 10.1.0.0/16.

Typically, you would summarize at the boundaries of area border routers (ABRs). Although you could configure summarization between any two areas, it is better to summarize in the direction of the backbone so that the backbone receives all the aggregate addresses and injects them, already summarized, into other areas. The two types of summarization are as follows

- Inter-area route summarization
- External route summarization

You configure inter-area route summarization on ABRs, summarizing routes between areas in the autonomous system. To take advantage of summarization, you should assign network numbers in areas in a contiguous way to be able to lump these addresses into one range.

External route summarization is specific to external routes that are injected into OSPFv2 using route redistribution. You should make sure that external ranges that are being summarized are contiguous. Summarizing overlapping ranges from two different routers could cause packets to be sent to the wrong destination. Configure external route summarization on ASBRs that are redistributing routes into OSPF.

When you configure a summary address, Cisco NX-OS automatically configures a discard route for the summary address to prevent routing black holes and route loops.

High Availability and Graceful Restart

Cisco NX-OS provides a multilevel high-availability architecture. OSPFv2 supports stateful restart, which is also referred to as non-stop routing (NSR). If OSPFv2 experiences problems, it attempts to restart from its previous run-time state. The neighbors do not register any neighbor event in this case. If the first restart is not successful and another problem occurs, OSPFv2 attempts a graceful restart.

A graceful restart, or nonstop forwarding (NSF), allows OSPFv2 to remain in the data forwarding path through a process restart. When OSPFv2 needs to perform a graceful restart, it sends a link-local opaque (type 9) LSA, called a grace LSA. This restarting OSPFv2 platform is called NSF capable.

The grace LSA includes a grace period, which is a specified time that the neighbor OSPFv2 interfaces hold onto the LSAs from the restarting OSPFv2 interface. (Typically, OSPFv2 tears down the adjacency and discards all LSAs from a down or restarting OSPFv2 interface.) The participating neighbors, which are called NSF helpers, keep all LSAs that originate from the restarting OSPFv2 interface as if the interface was still adjacent.

When the restarting OSPFv2 interface is operational again, it rediscovers its neighbors, establishes adjacency, and starts sending its LSA updates again. At this point, the NSF helpers recognize that the graceful restart has finished.

Stateful restart is used in the following scenarios:

- First recovery attempt after the process experiences problems
- User-initiated switchover using the **system switchover** command

Graceful restart is used in the following scenarios:

- Second recovery attempt after the process experiences problems within a 4-minute interval
- Manual restart of the process using the **restart ospf** command
- Active supervisor removal
- Active supervisor reload using the **reload module active-sup** command

OSPFv2 Stub Router Advertisements

You can configure an OSPFv2 interface to act as a stub router using the OSPFv2 Stub Router Advertisements feature. Use this feature when you want to limit the OSPFv2 traffic through this router, such as when you want to introduce a new router to the network in a controlled manner or limit the load on a router that is already overloaded. You might also want to use this feature for various administrative or traffic engineering reasons.

OSPFv2 stub router advertisements do not remove the OSPFv2 router from the network topology, but they do prevent other OSPFv2 routers from using this router to route traffic to other parts of the network. Only the traffic that is destined for this router or directly connected to this router is sent.

OSPFv2 stub router advertisements mark all stub links (directly connected to the local router) to the cost of the local OSPFv2 interface. All remote links are marked with the maximum cost (0xFFFF).

Multiple OSPFv2 Instances

Cisco NX-OS supports multiple instances of the OSPFv2 protocol that run on the same node. You cannot configure multiple instances over the same interface. By default, every instance uses the same system router ID. You must manually configure the router ID for each instance if the instances are in the same OSPFv2 autonomous system. For the number of supported OSPFv2 instances, see the [Cisco Nexus 9000 Series NX-OS Verified Scalability Guide](#).

SPF Optimization

Cisco NX-OS optimizes the SPF algorithm in the following ways:

- Partial SPF for Network (type 2) LSAs, Network Summary (type 3) LSAs, and AS External (type 5) LSAs—When there is a change on any of these LSAs, Cisco NX-OS performs a faster partial calculation rather than running the whole SPF calculation.
- SPF timers—You can configure different timers for controlling SPF calculations. These timers include exponential backoff for subsequent SPF calculations. The exponential backoff limits the CPU load of multiple SPF calculations.

BFD

This feature supports bidirectional forwarding detection (BFD). BFD is a detection protocol that provides fast forwarding-path failure detection times. BFD provides subsecond failure detection between two adjacent devices and can be less CPU-intensive than protocol hello messages, because some of the BFD load can be distributed onto the data plane on supported modules. See the [Cisco Nexus 9000 Series NX-OS Interfaces Configuration Guide](#) for more information.

Virtualization Support for OSPFv2

Cisco NX-OS supports multiple process instances for OSPFv3. Each OSPF instance can support multiple virtual routing and forwarding (VRF) instances, up to the system limit. For the number of supported OSPFv2 instances, see the [Cisco Nexus 9000 Series NX-OS Verified Scalability Guide](#).

Prerequisites for OSPFv2

OSPFv2 has the following prerequisites:

- You must be familiar with routing fundamentals to configure OSPF.
- You are logged on to the switch.
- You have configured at least one interface for IPv4 that can communicate with a remote OSPFv2 neighbor.
- You have completed the OSPFv2 network strategy and planning for your network. For example, you must decide whether multiple areas are required.

- You have enabled the OSPF feature (see the [Enabling OSPFv2](#) section).

Guidelines and Limitations for OSPFv2

OSPFv2 has the following configuration guidelines and limitations:

- The **graceful-restart planned-only** command under OSPFv2 on **reload** converts to the **graceful-restart** command.

This is not causing any impact on the functionality. If the **graceful-restart planned-only** is not in the configuration, this problem is not applicable for that device.

This occurs when the Cisco NX-OS release is 9.3(2) and CSCvs57583 is not included in the release. A workaround is to unconfigure the **graceful-restart** command and reconfigure the old command.

- Names in the prefix-list are case-insensitive. We recommend using unique names. Do not use the same name by modifying uppercase and lowercase characters. For example, CTCPrimaryNetworks and CtcPrimaryNetworks are not two different entries.
- If you enter the **no graceful-restart planned only** command, graceful restart is disabled.
- Cisco NX-OS displays areas in dotted decimal notation regardless of whether you enter the area in decimal or dotted decimal notation.
- All OSPFv2 routers must operate in the same RFC compatibility mode. OSPFv2 for Cisco NX-OS complies with RFC 2328. Use the **rfc1583compatibility** command in router configuration mode if your network includes routers that support only RFC 1583.
- In scaled scenarios, when the number of interfaces and link-state advertisements in an OSPF process is large, the snmp-walk on OSPF MIB objects is expected to time out with a small-values timeout at the SNMP agent. If you observe a timeout on the querying SNMP agent while polling OSPF MIB objects, increase the timeout value on the polling SNMP agent.
- The following guidelines and limitations apply to the administrative distance feature:
 - When an OSPF route has two or more equal cost paths, configuring the administrative distance is non-deterministic for the **match ip route-source** command.
 - Configuring the administrative distance is supported only for the **match route-type**, **match ip address prefix-list**, and **match ip route-source prefix-list** commands. The other match statements are ignored.
 - There is no preference among the **match route-type**, **match ip address**, and **match ip route-source** commands for setting the administrative distance of OSPF routes. In this way, the behavior of the table map for setting the administrative distance in Cisco NX-OS OSPF is different from that in Cisco IOS OSPF.
 - The discard route is always assigned an administrative distance of 220. No configuration in the table map applies to OSPF discard routes.
- If you configure the **delay restore seconds** command in vPC configuration mode and if the VLANs on the multichassis EtherChannel trunk (MCT) are announced by OSPFv2 or OSPFv3 using switch virtual interfaces (SVIs), those SVIs are announced with MAX_LINK_COST on the vPC secondary node during the configured time. As a result, all route or host programming completes after the vPC synchronization

operation (on a peer reload of the secondary vPC node) before attracting traffic. This behavior allows for minimal packet loss for any north-to-south traffic.

- For N9K-X9636C-R and N9K-X9636Q-R line cards and the N9K-C9508-FM-R fabric module, the output of the **show run ospf** command might show the default values for some OSPF commands.



Note If you are familiar with the Cisco IOS CLI, be aware that the Cisco NX-OS commands for this feature might differ from the Cisco IOS commands that you would use.

- If you use the **network ip address mask** command under OSPF, an error message will be displayed, and you will be prompted to enable OSPF under an interface with **area area id** command.
- It is recommended that you use the OSPF default timers (hello-interval:10 and dead-interval:40). For better convergence time, you can use the BFD along with OSPF. This combination will give sub-second link/adjacency flaps detection and very low convergence time.
- While OSPF support are aggressive timers, these are not commended as aggressive timers will bring the adjacency down quickly as well as cause CPU churn. We recommend you to use the default timers and use BFD (Bidirectional Forwarding Detection) to get sub-second failure detection.
- Beginning with Cisco NX-OS Release 10.3(1)F, OSPFv2 is supported on the Cisco Nexus 9808 switches.
- Beginning with Cisco NX-OS Release 10.4(1)F, OSPFv2 is supported on the Cisco Nexus 9804 switches.
- Beginning with Cisco NX-OS Release 10.3(3)F, OSPFv2 supports Type-6 keychain encryption for OSPFv2 user password on the Cisco NX-OS switches.
- Beginning with Cisco NX-OS Release 10.4(1)F, OSPFv2 is supported on Cisco Nexus X98900CD-A and X9836DM-A line cards with Cisco Nexus 9808 and 9804 switches.

Default Settings for OSPFv2

The table lists the default settings for OSPFv2 parameters.

Table 18: Default OSPFv2 Parameters

Parameters	Default
Administrative distance	110
Hello interval	10 seconds
Dead interval	40 seconds
Discard routes	Enabled
Graceful restart grace period	60 seconds
OSPFv2 feature	Disabled
Stub router advertisement announce time	600 seconds

Parameters	Default
Reference bandwidth for link cost calculation	40 Gb/s
LSA minimal arrival time	1000 milliseconds
LSA group pacing	10 seconds
SPF calculation initial delay time	200 milliseconds
SPF minimum hold time	5000 milliseconds
SPF calculation initial delay time	1000 milliseconds

Configuring Basic OSPFv2

Configure OSPFv2 after you have designed your OSPFv2 network.

Enabling OSPFv2

You must enable the OSPFv2 feature before you can configure OSPFv2.

SUMMARY STEPS

1. **configure terminal**
2. **feature ospf**
3. (Optional) **show feature**
4. (Optional) **copy running-config startup-config**

DETAILED STEPS

	Command or Action	Purpose
Step 1	configure terminal Example: <pre>switch# configure terminal switch(config)#</pre>	Enters global configuration mode.
Step 2	feature ospf Example: <pre>switch(config)# feature ospf</pre> Example:	Enables the OSPFv2 feature.
Step 3	(Optional) show feature Example: <pre>switch(config)# show feature</pre>	Displays enabled and disabled features.

	Command or Action	Purpose
Step 4	(Optional) copy running-config startup-config Example: <code>switch(config)# copy running-config startup-config</code>	Copies the running configuration to the startup configuration.

Example

To disable the OSPFv2 feature and remove all associated configuration, use the `no feature ospf` command in global configuration mode:

Command	Purpose
no feature ospf Example: <code>switch(config)# no feature ospf</code>	Disables the OSPFv2 feature and removes all associated configuration.

Creating an OSPFv2 Instance

The first step in configuring OSPFv2 is to create an OSPFv2 instance. You assign a unique instance tag for this OSPFv2 instance. The instance tag can be any string.

For more information about OSPFv2 instance parameters, see the [Configuring Advanced OSPFv2, on page 119](#) section.

Before you begin

Ensure that you have enabled the OSPF feature (see the [Enabling OSPFv2](#) section).

Use the `show ip ospf instance-tag` command to verify that the instance tag is not in use.

OSPFv2 must be able to obtain a router identifier (for example, a configured loopback address) or you must configure the router ID option.

SUMMARY STEPS

1. **configure terminal**
2. **[no]router ospf instance-tag**
3. (Optional) **router-id ip-address**
4. (Optional) **show ip ospf instance-tag**
5. (Optional) **copy running-config startup-config**

DETAILED STEPS

	Command or Action	Purpose
Step 1	configure terminal Example:	Enters global configuration mode.

	Command or Action	Purpose
	switch# configure terminal switch(config)#	
Step 2	[no]router ospf instance-tag Example: switch(config)# router ospf 201 switch(config-router)	Creates a new OSPFv2 instance with the configured instance tag.
Step 3	(Optional) router-id ip-address Example: switch(config-router)# router-id 192.0.2.1	Configures the OSPFv2 router ID. This IP address identifies this OSPFv2 instance and must exist on a configured interface in the system.
Step 4	(Optional) show ip ospf instance-tag Example: switch(config-router)# show ip ospf 201	Displays OSPF information.
Step 5	(Optional) copy running-config startup-config Example: switch(config)# copy running-config startup-config	Copies the running configuration to the startup configuration.

Example

To remove the OSPFv2 instance and all associated configuration, use the `no router ospf` command in global configuration mode.

Command	Purpose
no router ospf instance-tag Example: switch(config)# no router ospf 201	Deletes the OSPF instance and the associated configuration.



Note This command does not remove the OSPF configuration in interface mode. You must manually remove any OSPFv2 commands configured in interface mode.

Configuring Optional Parameters on an OSPFv2 Instance

You can configure optional parameters for OSPF, see the [Configuring Advanced OSPFv2, on page 119](#) section.

You can configure the following optional parameters for OSPFv2 in router configuration mode:

Before you begin

Ensure that you have enabled the OSPF feature, (see the [Enabling OSPFv2](#) section).

OSPFv2 must be able to obtain a router identifier (for example, a configured loopback address) or you must configure the router ID option.

SUMMARY STEPS

1. **distance** *number*
2. **log-adjacency-changes** [detail]
3. **maximum-paths** *path-number*
4. **distance** *number*
5. **log-adjacency-changes** [detail]
6. **maximum-paths** *path-number*
7. **passive-interface** default
8. (Optional) **copy running-config startup-config**

DETAILED STEPS

	Command or Action	Purpose
Step 1	distance <i>number</i> Example: switch(config-router)# distance 25	Configures the administrative distance for this OSPFv2 instance. The range is from 1 to 255. The default is 110.
Step 2	log-adjacency-changes [detail] Example: switch(config-router)# log-adjacency-changes	Generates a system message whenever a neighbor changes state.
Step 3	maximum-paths <i>path-number</i> Example: switch(config-router)# maximum-paths 4	Configures the maximum number of equal OSPFv2 paths to a destination in the route table. This command is used for load balancing. The range is from 1 to 16. The default is 8.
Step 4	distance <i>number</i> Example: switch(config-router)# distance 25	Configures the administrative distance for this OSPFv2 instance. The range is from 1 to 255. The default is 110.
Step 5	log-adjacency-changes [detail] Example: switch(config-router)# log-adjacency-changes	Generates a system message whenever a neighbor changes state.
Step 6	maximum-paths <i>path-number</i> Example: switch(config-router)# maximum-paths 4	Configures the maximum number of equal OSPFv2 paths to a destination in the route table. This command is used for load balancing. The range is from 1 to 16. The default is 8.

	Command or Action	Purpose
Step 7	passive-interface default Example: <pre>switch(config-router)# passive-interface default</pre>	Suppresses routing updates on all interfaces. This command is overridden by the VRF or interface command mode configuration.
Step 8	(Optional) copy running-config startup-config Example: <pre>switch(config-router)# copy running-config startup-config</pre>	Saves this configuration change.

Example

This example shows how to create an OSPFv2 instance:

```
switch# configure terminal
switch(config)# router ospf 201
switch(config-router)# copy running-config startup-config
```

Configuring Networks in OSPFv2

You can configure a network to OSPFv2 by associating it through the interface that the router uses to connect to that network (see the Neighbors section). You can add all networks to the default backbone area (Area 0), or you can create new areas using any decimal number or an IP address.



Note All areas must connect to the backbone area either directly or through a virtual link.



Note OSPF is not enabled on an interface until you configure a valid IP address for that interface.

Before you begin

Ensure that you have enabled the OSPF feature (see the [Enabling OSPFv2](#) section).

SUMMARY STEPS

1. **configure terminal**
2. **interface** *interface-type slot/port*
3. **ip address** *ip-prefix/length*
4. **ip router ospf** *instance-tag area area-id* [**secondaries none**]
5. (Optional) **show ip ospf** *instance-tag interface interface-type slot/port*
6. **copy running-config startup-config**
7. (Optional) **ip ospf cost** *number*
8. (Optional) **ip ospf dead-interval** *seconds*

9. (Optional) **ip ospf hello-interval** *seconds*
10. (Optional) **ip ospf mtu-ignore**
11. (Optional) **[default | no] ip ospf passive-interface**
12. (Optional) **ip ospf priority** *number*
13. (Optional) **ip ospf shutdown**

DETAILED STEPS

	Command or Action	Purpose
Step 1	configure terminal Example: <pre>switch# configure terminal switch(config)#</pre>	Enters global configuration mode.
Step 2	interface <i>interface-type slot/port</i> Example: <pre>switch(config)# interface ethernet 1/2 switch(config-if)#</pre>	Enters interface configuration mode.
Step 3	ip address <i>ip-prefix/length</i> Example: <pre>switch(config-if)# ip address 192.0.2.1/16</pre>	Assigns an IP address and subnet mask to this interface.
Step 4	ip router ospf <i>instance-tag area area-id</i> [secondaries none] Example: <pre>switch(config-if)# ip router ospf 201 area 0.0.0.15</pre>	Adds the interface to the OSPFv2 instance and area.
Step 5	(Optional) show ip ospf <i>instance-tag interface interface-type slot/port</i> Example: <pre>switch(config-if)# show ip ospf 201 interface ethernet 1/2</pre>	Displays OSPF information.
Step 6	copy running-config startup-config Example: <pre>switch(config-if)# copy running-config startup-config</pre>	Saves this configuration change.
Step 7	(Optional) ip ospf cost <i>number</i> Example: <pre>switch(config-if)# ip ospf cost 25</pre>	Configures the OSPFv2 cost metric for this interface. The default is to calculate cost metric, based on reference bandwidth and interface bandwidth. The range is from 1 to 65535.

	Command or Action	Purpose
Step 8	(Optional) ip ospf dead-interval <i>seconds</i> Example: switch(config-if)# ip ospf dead-interval 50	Configures the OSPFv2 dead interval, in seconds. The range is from 1 to 65535. The default is four times the hello interval, in seconds.
Step 9	(Optional) ip ospf hello-interval <i>seconds</i> Example: switch(config-if)# ip ospf hello-interval 25	Configures the OSPFv2 hello interval, in seconds. The range is from 1 to 65535. The default is 10 seconds.
Step 10	(Optional) ip ospf mtu-ignore Example: switch(config-if)# ip ospf mtu-ignore	Configures OSPFv2 to ignore any IP MTU mismatch with a neighbor. The default is to not establish adjacency if the neighbor MTU does not match the local interface MTU.
Step 11	(Optional) [default no] ip ospf passive-interface Example: switch(config-if)# ip ospf passive-interface	Suppresses routing updates on the interface. This command overrides the router or VRF command mode configuration. The default option removes this interface mode command and reverts to the router or VRF configuration, if present.
Step 12	(Optional) ip ospf priority <i>number</i> Example: switch(config-if)# ip ospf priority 25	Configures the OSPFv2 priority, used to determine the DR for an area. The range is from 0 to 255. The default is 1. See the Designated Routers, on page 152 section.
Step 13	(Optional) ip ospf shutdown Example: switch(config-if)# ip ospf shutdown	Shuts down the OSPFv2 instance on this interface.

Example

This example shows how to add a network area 0.0.0.10 in OSPFv2 instance 201:

```
switch# configure terminal
switch(config)# interface ethernet 1/2
switch(config-if)# ip address 192.0.2.1/16
switch(config-if)# ip router ospf 201 area 0.0.0.10
switch(config-if)# copy running-config startup-config
```

Use the **show ip ospf interface** command to verify the interface configuration. Use the **show ip ospf neighbor** command to see the neighbors for this interface.

Configuring Authentication for an Area

You can configure authentication for all networks in an area or for individual interfaces in the area. Interface authentication configuration overrides area authentication.

Before you begin

Ensure that you have enabled the OSPF feature, see the [Enabling OSPFv2](#) section.

Ensure that all neighbors on an interface share the same authentication configuration, including the shared authentication key.

Create the key chain for this authentication configuration. See the [Cisco Nexus 9000 Series NX-OS Security Configuration Guide](#).



Note For OSPFv2, the key identifier in the **key** *key-id* command supports values from 0 to 255 only.

SUMMARY STEPS

1. **configure terminal**
2. **router ospf** *instance-tag*
3. **area** *area-id* **authentication** [**message-digest**]
4. **interface** *interface-type slot/port*
5. (Optional) **ip ospf authentication-key** [**0** | **3**] *key*
6. (Optional) **ip ospf message-digest-key** *key-id* **md5** [**0** | **3**] *key*
7. (Optional) **show ip ospf** *instance-tag* **interface** *interface-type slot/port*
8. (Optional) **copy running-config startup-config**

DETAILED STEPS

	Command or Action	Purpose
Step 1	configure terminal Example: switch# configure terminal switch(config)#	Enters global configuration mode.
Step 2	router ospf <i>instance-tag</i> Example: switch(config)# router ospf 201 switch(config-router)#	Creates a new OSPFv2 instance with the configured instance tag.
Step 3	area <i>area-id</i> authentication [message-digest] Example: switch(config-router)# area 0.0.0.10 authentication	Configures the authentication mode for an area.
Step 4	interface <i>interface-type slot/port</i> Example: switch(config-router)# interface ethernet 1/2 switch(config-if)#	Enters interface configuration mode.
Step 5	(Optional) ip ospf authentication-key [0 3] <i>key</i> Example:	Configures simple password authentication for this interface. Use this command if the authentication is not set to

	Command or Action	Purpose
	<pre>switch(config-if)# ip ospf authentication-key 0 mypass</pre>	key-chain or message-digest. 0 configures the password in clear text. 3 configures the password as 3DES encrypted.
Step 6	(Optional) ip ospf message-digest-key <i>key-id</i> md5 [0 3] <i>key</i> Example: <pre>switch(config-if)# ip ospf message-digest-key 21 md5 0 mypass</pre>	Configures message digest authentication for this interface. Use this command if the authentication is set to message-digest. The key-id range is from 1 to 255. The MD5 option 0 configures the password in clear text and 3 configures the pass key as 3DES encrypted.
Step 7	(Optional) show ip ospf instance-tag interface <i>interface-type slot/port</i> Example: <pre>switch(config-if)# show ip ospf 201 interface ethernet 1/2</pre>	Displays OSPF information.
Step 8	(Optional) copy running-config startup-config Example: <pre>switch(config)# copy running-config startup-config</pre>	Copies the running configuration to the startup configuration.

Configuring Authentication for an Interface

You can configure authentication for all networks in an area or for individual interfaces in the area. Interface authentication configuration overrides area authentication.

Before you begin

Ensure that you have enabled the OSPF feature (see the [Enabling OSPFv2](#) section).

Ensure that all neighbors on an interface share the same authentication configuration, including the shared authentication key.

Create the key chain for this authentication configuration. See the [Cisco Nexus 9000 Series NX-OS Security Configuration Guide](#).



Note For OSPFv2, the key identifier in the **key** *key-id* command supports values from 0 to 255 only. In Keychain, only key 0-255 will be supported by OSPFv2.

SUMMARY STEPS

1. **configure terminal**
2. **interface** *interface-type slot/port*
3. **ip ospf authentication** [message-digest]
4. (Optional) **ip ospf authentication key-chain** *key-id*
5. (Optional) **ip ospf authentication-key** [0 | 3 | 7] *key*
6. (Optional) **ip ospf message-digest-key** *key-id* **md5** [0 | 3 | 7] *key*

7. (Optional) **show ip ospf instance-tag interface interface-type slot/port**
8. (Optional) **copy running-config startup-config**

DETAILED STEPS

	Command or Action	Purpose
Step 1	configure terminal Example: <pre>switch# configure terminal switch(config)#</pre>	Enters global configuration mode.
Step 2	interface interface-type slot/port Example: <pre>switch(config)# interface ethernet 1/2 switch(config-if)#</pre>	Enters interface configuration mode.
Step 3	ip ospf authentication [message-digest] Example: <pre>switch(config-if)# ip ospf authentication</pre>	Enables interface authentication mode for OSPFv2 for either cleartext or message-digest type. Overrides area-based authentication for this interface. All neighbors must share this authentication type.
Step 4	(Optional) ip ospf authentication key-chain key-id Example: <pre>switch(config-if)# ip ospf authentication key-chain Test1</pre>	Configures interface authentication to use key chains for OSPFv2. See the <i>Cisco NX-OS Series NX-OS Security Configuration Guide</i> , for details on key chains.
Step 5	(Optional) ip ospf authentication-key [0 3 7] key Example: <pre>switch(config-if)# ip ospf authentication-key 0 mypass</pre>	Configures simple password authentication for this interface. Use this command if the authentication is not set to key-chain or message-digest. The options are as follows: <ul style="list-style-type: none"> • 0—Configures the password in clear text. • 3—Configures the pass key as 3DES encrypted. • 7—Configures the key as Cisco type 7 encrypted.
Step 6	(Optional) ip ospf message-digest-key key-id md5 [0 3 7] key Example: <pre>switch(config-if)# ip ospf message-digest-key 21 md5 0 mypass</pre>	Configures message digest authentication for this interface. Use this command if the authentication is set to message-digest. The key-id range is from 1 to 255. The MD5 options are as follows: <ul style="list-style-type: none"> • 0—Configures the password in clear text. • 3—Configures the pass key as 3DES encrypted. • 7—Configures the key as Cisco type 7 encrypted.
Step 7	(Optional) show ip ospf instance-tag interface interface-type slot/port Example:	Displays OSPF information.

	Command or Action	Purpose
	switch(config-if)# show ip ospf 201 interface ethernet 1/2	
Step 8	(Optional) copy running-config startup-config Example: switch(config)# copy running-config startup-config	Copies the running configuration to the startup configuration.

Example

This example shows how to set an interface for simple, unencrypted passwords and set the password for Ethernet interface 1/2:

```
switch# configure terminal
switch(config)# router ospf 201
switch(config-router)# exit
switch(config)# interface ethernet 1/2
switch(config-if)# ip router ospf 201 area 0.0.0.10
switch(config-if)# ip ospf authentication
switch(config-if)# ip ospf authentication-key 0 mypass
switch(config-if)# copy running-config startup-config
```

This example shows how to configure OSPFv2 HMAC-SHA-1 and MD5 cryptographic authentication:

```
switch# configure terminal
switch(config)# key chain chain1
switch(config-keychain)# key 1
switch(config-keychain-key)# key-string 7 070724404206
switch(config-keychain-key)# accept-lifetime 01:01:01 Jan 01 2015 infinite
switch(config-keychain-key)# send-lifetime 01:01:01 Jan 01 2015 infinite
switch(config-keychain-key)# cryptographic-algorithm HMAC-SHA-1
switch(config-keychain-key)# exit
switch(config-keychain)# key 2
switch(config-keychain-key)# key-string 7 070e234f1f5b4a
switch(config-keychain-key)# accept-lifetime 10:51:01 Jul 24 2015 infinite
switch(config-keychain-key)# send-lifetime 10:51:01 Jul 24 2015 infinite
switch(config-keychain-key)# cryptographic-algorithm MD5
switch(config-keychain-key)# exit
switch(config-keychain)# exit

switch(config)# interface ethernet 1/1
switch(config-if)# ip router ospf 1 area 0.0.0.0
switch(config-if)# ip ospf authentication message-digest
switch(config-if)# ip ospf authentication key-chain chain1

switch(config-if)# show key chain chain1
Key-Chain chain1
Key 1 -- text 7 "070724404206"
cryptographic-algorithm HMAC-SHA-1
accept lifetime UTC (01:01:01 Jan 01 2015)-(always valid) [active]
send lifetime UTC (01:01:01 Jan 01 2015)-(always valid) [active]
Key 2 -- text 7 "070e234f1f5b4a"
cryptographic-algorithm MD
accept lifetime UTC (10:51:00 Jul 24 2015)-(always valid) [active]
send lifetime UTC (10:51:00 Jul 24 2015)-(always valid) [active]

switch(config-if)# show ip ospf interface ethernet 1/1
Ethernet1/1 is up, line protocol is up
```

```
IP address 11.11.11.1/24
Process ID 1 VRF default, area 0.0.0.3
Enabled by interface configuration
State BDR, Network type BROADCAST, cost 40
Index 6, Transmit delay 1 sec, Router Priority 1
Designated Router ID: 33.33.33.33, address: 11.11.11.3
Backup Designated Router ID: 1.1.1.1, address: 11.11.11.1
2 Neighbors, flooding to 2, adjacent with 2
Timer intervals: Hello 10, Dead 40, Wait 40, Retransmit 5
Hello timer due in 00:00:08
Message-digest authentication, using keychain key1 (ready)
Sending SA: Key id 2, Algorithm MD5
Number of opaque link LSAs: 0, checksum sum 0
```

Configuring Advanced OSPFv2

Configure OSPFv2 after you have designed your OSPFv2 network.

Configuring Filter Lists for Border Routers

You can separate your OSPFv2 domain into a series of areas that contain related networks. All areas must connect to the backbone area through an area border router (ABR). OSPFv2 domains can connect to external domains as well, through an autonomous system border router (ASBR). See the [Areas, on page 152](#) section.

ABRs have the following optional configuration parameters:

- Area range—Configures route summarization between areas. See the [Configuring Route Summarization](#) section.
- Filter list—Filters the Network Summary (type 3) LSAs that are allowed in from an external area.

ASBRs also support filter lists.

Before you begin

Ensure that you have enabled the OSPF feature. See the [Enabling OSPFv2](#) section).

Create the route map that the filter list uses to filter IP prefixes in incoming or outgoing Network Summary (type 3) LSAs. See [Configuring Route Policy Manager](#). See the [Areas, on page 152](#) section.

SUMMARY STEPS

1. **configure terminal**
2. **router ospf** *instance-tag*
3. **area** *area-id* **filter-list route-map** *map-name* {in | out}
4. (Optional) **show ip ospf policy statistics area** *id* **filter-list** {in | out}
5. (Optional) **copy running-config startup-config**

DETAILED STEPS

	Command or Action	Purpose
Step 1	configure terminal Example: switch# configure terminal switch(config)#	Enters global configuration mode.
Step 2	router ospf instance-tag Example: switch(config)# router ospf 201 switch(config-router)#	Creates a new OSPFv2 instance with the configured instance tag.
Step 3	area area-id filter-list route-map map-name {in out} Example: switch(config-router)# area 0.0.0.10 filter-list route-map FilterLSAs in	Filters incoming or outgoing Network Summary (type 3) LSAs on an ABR.
Step 4	(Optional) show ip ospf policy statistics area id filter-list {in out} Example: switch(config-router)# show ip ospf policy statistics area 0.0.0.10 filter-list in	Displays OSPF policy information.
Step 5	(Optional) copy running-config startup-config Example: switch(config)# copy running-config startup-config	Copies the running configuration to the startup configuration.

Example

This example shows how to configure a filter list in area 0.0.0.10:

```
switch# configure terminal
switch(config)# router ospf 201
switch(config-router)# area 0.0.0.10 filter-list route-map FilterLSAs in
switch(config-router)# copy running-config startup-config
```

Configuring Stub Areas

You can configure a stub area for part of an OSPFv2 domain where external traffic is not necessary. Stub areas block AS External (type 5) LSAs and limit unnecessary routing to and from selected networks. See the [Stub Area](#) section. You can optionally block all summary routes from going into the stub area.

Before you begin

Ensure that you have enabled the OSPF feature. (see the [Enabling OSPFv2](#) section).

Ensure that there are no virtual links or ASBRs in the proposed stub area.

SUMMARY STEPS

1. **configure terminal**
2. **router ospf instance-tag**
3. **area area-id stub**
4. (Optional) **area area-id default-cost cost**
5. (Optional) **show ip ospf instance-tag**
6. (Optional) **copy running-config startup-config**

DETAILED STEPS

	Command or Action	Purpose
Step 1	configure terminal Example: switch# configure terminal switch(config)#	Enters global configuration mode.
Step 2	router ospf instance-tag Example: switch(config)# router ospf 201 switch(config-router)#	Creates a new OSPFv2 instance with the configured instance tag.
Step 3	area area-id stub Example: switch(config-router)# area 0.0.0.10 stub	Creates this area as a stub area.
Step 4	(Optional) area area-id default-cost cost Example: switch(config-router)# area 0.0.0.10 default-cost 25	Sets the cost metric for the default summary route sent into this stub area. The range is from 0 to 16777215. The default is 1.
Step 5	(Optional) show ip ospf instance-tag Example: switch(config-router)# show ip ospf 201	Displays OSPF information.
Step 6	(Optional) copy running-config startup-config Example: switch(config)# copy running-config startup-config	Copies the running configuration to the startup configuration.

Example

This example shows how to create a stub area:

```
switch# configure terminal
switch(config)# router ospf 201
switch(config-router)# area 0.0.0.10 stub
switch(config-router)# copy running-config startup-config
```

Configuring a Totally Stubby Area

You can create a totally stubby area and prevent all summary route updates from going into the stub area.

To create a totally stubby area, use the following command in router configuration mode:

SUMMARY STEPS

1. **area *area-id* stub no-summary**

DETAILED STEPS

	Command or Action	Purpose
Step 1	area <i>area-id</i> stub no-summary Example: <pre>switch(config-router)# area 20 stub no-summary</pre>	Creates this area as a totally stubby area.

Configuring NSSA

You can configure an NSSA for part of an OSPFv2 domain where limited external traffic is required. You can optionally translate this external traffic to an AS External (type 5) LSA and flood the OSPFv2 domain with this routing information. An NSSA can be configured with the following optional parameters:

- No redistribution—Redistributed routes bypass the NSSA and are redistributed to other areas in the OSPFv2 autonomous system. Use this option when the NSSA ASBR is also an ABR.
- Default information originate—Generates an NSSA External (type 7) LSA for a default route to the external autonomous system. Use this option on an NSSA ASBR if the ASBR contains the default route in the routing table. This option can be used on an NSSA ABR whether or not the ABR contains the default route in the routing table.
- Route map—Filters the external routes so that only those routes that you want are flooded throughout the NSSA and other areas.
- No summary—Blocks all summary routes from flooding the NSSA. Use this option on the NSSA ABR.
- Translate—Translates NSSA External LSAs to AS External LSAs for areas outside the NSSA. Use this command on an NSSA ABR to flood the redistributed routes throughout the OSPFv2 autonomous system. You can optionally suppress the forwarding address in these AS External LSAs. If you choose this option, the forwarding address is set to 0.0.0.0.



Note The translate option requires a separate **area *area-id* nssa** command, preceded by the **area *area-id* nssa** command that creates the NSSA and configures the other options.



Note You can use command `area 0.0.0.2 nssa translate type7` to enable translate. Ensure that you configure command `area 0.0.0.2 nssa` to designate Area 2 as NSSA.

Before you begin

Ensure that you have enabled the OSPF feature (see the [Enabling OSPFv2](#) section).

Ensure that there are no virtual links in the proposed NSSA and that it is not the backbone area.

SUMMARY STEPS

1. **configure terminal**
2. **router ospf** *instance-tag*
3. **area** *area-id* **nssa** [**no-redistribution**] [**default-information-originate**]**originate** [**route-map** *map-name*] [**no-summary**]
4. (Optional) **area** *area-id* **nssa translate type7** {**always** | **never**} [**suppress-fa**]
5. (Optional) **area** *area-id* **default-cost** *cost*
6. (Optional) **show ip ospf** *instance-tag*
7. (Optional) **copy running-config startup-config**

DETAILED STEPS

	Command or Action	Purpose
Step 1	configure terminal Example: <pre>switch# configure terminal switch(config)#</pre>	Enters global configuration mode.
Step 2	router ospf <i>instance-tag</i> Example: <pre>switch(config)# router ospf 201 switch(config-router)#</pre>	Creates a new OSPFv2 instance with the configured instance tag.
Step 3	area <i>area-id</i> nssa [no-redistribution] [default-information-originate]originate [route-map <i>map-name</i>] [no-summary] Example: <pre>switch(config-router)# area 0.0.0.10 nssa no-redistribution</pre>	Creates this area as an NSSA.
Step 4	(Optional) area <i>area-id</i> nssa translate type7 { always never } [suppress-fa] Example: <pre>switch(config-router)# area 0.0.0.10 nssa translate type7 always</pre>	Configures the NSSA to translate AS External (type 7) LSAs to NSSA External (type 5) LSAs.

	Command or Action	Purpose
Step 5	(Optional) area <i>area-id</i> default-cost <i>cost</i> Example: switch(config-router)# area 0.0.0.10 default-cost 25	Sets the cost metric for the default summary route sent into this NSSA.
Step 6	(Optional) show ip ospf <i>instance-tag</i> Example: switch(config-router)# show ip ospf 201	Displays OSPF information.
Step 7	(Optional) copy running-config startup-config Example: switch(config)# copy running-config startup-config	Copies the running configuration to the startup configuration.

Example

This example shows how to create an NSSA that blocks all summary route updates:

```
switch# configure terminal
switch(config)# router ospf 201
switch(config-router)# area 0.0.0.10 nssa no-summary
switch(config-router)# copy running-config startup-config
```

This example shows how to create an NSSA that generates a default route:

```
switch# configure terminal
switch(config)# router ospf 201
switch(config-router)# area 0.0.0.10 nssa default-info-originate
switch(config-router)# copy running-config startup-config
```

This example shows how to create an NSSA that filters external routes and blocks all summary route updates:

```
switch# configure terminal
switch(config)# router ospf 201
switch(config-router)# area 0.0.0.10 nssa route-map ExternalFilter no-summary
switch(config-router)# copy running-config startup-config
```

This example shows how to create an NSSA and then configure the NSSA to always translate AS External (type 7) LSAs to NSSA External (type 5) LSAs:

```
switch# configure terminal
switch(config)# router ospf 201
switch(config-router)# area 0.0.0.10 nssa
switch(config-router)# area 0.0.0.10 nssa translate type 7 always
switch(config-router)# copy running-config startup-config
```

Configuring Multi-Area Adjacency

You can add more than one area to an existing OSPFv2 interface. The additional logical interfaces support multi-area adjacency.

Before you begin

You must enable OSPFv2 (see the [Enabling OSPFv2](#) section).

Ensure that you have configured a primary area for the interface (see the [Configuring Networks in OSPFv2](#) section).

SUMMARY STEPS

1. **configure terminal**
2. **interface** *interface-type slot/port*
3. **ip router ospf** [*instance-tag*] **multi-area** *area-id*
4. (Optional) **show ip ospf** *instance-tag* **interface** *interface-type slot/port*
5. (Optional) **copy running-config startup-config**

DETAILED STEPS

	Command or Action	Purpose
Step 1	configure terminal Example: switch# configure terminal switch(config)#	Enters global configuration mode.
Step 2	interface <i>interface-type slot/port</i> Example: switch(config)# interface ethernet 1/2 switch(config-if)#	Enters interface configuration mode.
Step 3	ip router ospf [<i>instance-tag</i>] multi-area <i>area-id</i> Example: switch(config-if)# ip router ospf 201 multi-area 3	Adds the interface to another area. Note Beginning with Cisco NX-OS Release 7.0(3)I5(1), the <i>instance-tag</i> argument is optional. If you do not specify an instance, the multi-area configuration is applied to the same instance that is configured for the primary area on that interface.
Step 4	(Optional) show ip ospf <i>instance-tag</i> interface <i>interface-type slot/port</i> Example: switch(config-if)# show ip ospf 201 interface ethernet 1/2	Displays OSPFv2 information.
Step 5	(Optional) copy running-config startup-config Example: switch(config)# copy running-config startup-config	Saves this configuration change.

Example

This example shows how to add a second area to an OSPFv2 interface:

```
switch# configure terminal
switch(config)# interface ethernet 1/2
switch(config-if)# ip address 192.0.2.1/16
switch(config-if)# ip router ospf 201 area 0.0.0.10
switch(config-if)# ip router ospf 201 multi-area 20
switch(config-if)# copy running-config startup-config
```

Configuring Virtual Links

A virtual link connects an isolated area to the backbone area through an intermediate area. See the [Virtual Links](#) section. You can configure the following optional parameters for a virtual link:

- **Authentication**—Sets a simple password or MD5 message digest authentication and associated keys.
- **Dead interval**—Sets the time that a neighbor waits for a Hello packet before declaring the local router as dead and tearing down adjacencies.
- **Hello interval**—Sets the time between successive Hello packets.
- **Retransmit interval**—Sets the estimated time between successive LSAs.
- **Transmit delay**—Sets the estimated time to transmit an LSA to a neighbor.



Note You must configure the virtual link on both routers involved before the link becomes active.

You cannot add a virtual link to a stub area.

Before you begin

Ensure that you have enabled the OSPF feature (see the [Enabling OSPFv2](#) section).

SUMMARY STEPS

1. **configure terminal**
2. **router ospf** *instance-tag*
3. **area** *area-id* **virtual link** *router-id*
4. (Optional) **show ip ospf virtual-link** [**brief**]
5. (Optional) **copy running-config startup-config**
6. (Optional) **authentication** [**key-chain** *key-id* **message-digest** | **null**]
7. (Optional) **authentication-key** [**0** | **3**] *key*
8. (Optional) **dead-interval** *seconds*
9. (Optional) **hello-interval** *seconds*
10. (Optional) **message-digest-key** *key-id* **md5** [**0** | **3**] *key*
11. (Optional) **retransmit-interval** *seconds*
12. (Optional) **transmit-delay** *seconds*

DETAILED STEPS

	Command or Action	Purpose
Step 1	configure terminal Example: switch# configure terminal switch(config)#	Enters global configuration mode.
Step 2	router ospf instance-tag Example: switch(config)# router ospf 201 switch(config-router)#	Creates a new OSPFv2 instance with the configured instance tag.
Step 3	area area-id virtual link router-id Example: switch(config-router)# area 0.0.0.10 virtual-link 10.1.2.3 switch(config-router-vlink)#	Creates one end of a virtual link to a remote router. You must create the virtual link on that remote router to complete the link.
Step 4	(Optional) show ip ospf virtual-link [brief] Example: switch(config-router-vlink)# show ip ospf virtual-link	Displays OSPF virtual link information.
Step 5	(Optional) copy running-config startup-config Example: switch(config)# copy running-config startup-config	Copies the running configuration to the startup configuration.
Step 6	(Optional) authentication [key-chain key-id message-digest null] Example: switch(config-router-vlink)# authentication message-digest	Overrides area-based authentication for this virtual link.
Step 7	(Optional) authentication-key [0 3] key Example: switch(config-router-vlink)# authentication-key 0 mypass	Configures a simple password for this virtual link. Use this command if the authentication is not set to key-chain or message-digest. 0 configures the password in clear text. 3 configures the password as 3DES encrypted.
Step 8	(Optional) dead-interval seconds Example: switch(config-router-vlink)# dead-interval 50	Configures the OSPFv2 dead interval, in seconds. The range is from 1 to 65535. The default is four times the hello interval, in seconds.
Step 9	(Optional) hello-interval seconds Example: switch(config-router-vlink)# hello-interval 25	Configures the OSPFv2 hello interval, in seconds. The range is from 1 to 65535. The default is 10 seconds.

	Command or Action	Purpose
Step 10	(Optional) message-digest-key <i>key-id md5 [0 3] key</i> Example: switch(config-router-vlink) # message-digest-key 21 md5 0 mypass	Configures message digest authentication for this virtual link. Use this command if the authentication is set to message-digest. 0 configures the password in clear text. 3 configures the pass key as 3DES encrypted.
Step 11	(Optional) retransmit-interval <i>seconds</i> Example: switch(config-router-vlink) # retransmit-interval 50	Configures the OSPFv2 retransmit interval, in seconds. The range is from 1 to 65535. The default is 5.
Step 12	(Optional) transmit-delay <i>seconds</i> Example: switch(config-router-vlink) # transmit-delay 2	Configures the OSPFv2 transmit-delay, in seconds. The range is from 1 to 450. The default is 1.

Example



Note For OSPFv2, the key identifier in the key key-id command supports values from 0 to 255 only. In Keychain only key 0-255 will be supported by OSPFv2.

This example shows how to create a simple virtual link between two ABRs.

The configuration for ABR 1 (router ID 27.0.0.55) is as follows:

```
switch# configure terminal
switch(config)# router ospf 201
switch(config-router)# area 0.0.0.10 virtual-link 10.1.2.3
switch(config-router)# copy running-config startup-config
```

The configuration for ABR 2 (Router ID 10.1.2.3) is as follows:

```
switch# configure terminal
switch(config)# router ospf 101
switch(config-router)# area 0.0.0.10 virtual-link 27.0.0.55
switch(config-router)# copy running-config startup-config
```

Configuring Redistribution

You can redistribute routes that are learned from other routing protocols into an OSPFv2 autonomous system through the ASBR.

For redistributing the default route, you must specify the following parameter:

- **default-information originate** - Creates a default route into this OSPF domain if the default route exists in the RIB.



Note Beginning with Cisco NX-OS Release 7.0(3)I7(6), if you redistribute default routes into OSPF, Cisco NX-OS requires the **default-information originate** command to successfully advertise the default route.

For non-default routes, you can configure the following optional parameters for route redistribution in OSPF:

- **default-metric** - Sets all redistributed routes to the same cost metric.

Before you begin

Enable the OSPF feature. See [Enabling OSPFv2](#).

Create the necessary route maps used for redistribution.

SUMMARY STEPS

1. **configure terminal**
2. **router ospf** *instance-tag*
3. **redistribute** {**bgp id** | **direct** | **eigrp id** | **isis id** | **ospf id** | **rip id** | **static**} **route-map** *map-name*
4. **default-information originate** [**always**] [**route-map** *map-name*]
5. **default-metric** [*cost*]
6. (Optional) **copy running-config startup-config**

DETAILED STEPS

	Command or Action	Purpose
Step 1	configure terminal Example: <pre>switch# configure terminal switch(config)#</pre>	Enters global configuration mode.
Step 2	router ospf <i>instance-tag</i> Example: <pre>switch(config)# router ospf 201 switch(config-router)#</pre>	Creates a new OSPFv2 instance with the configured instance tag.
Step 3	redistribute { bgp id direct eigrp id isis id ospf id rip id static } route-map <i>map-name</i> Example: <pre>switch(config-router)# redistribute bgp route-map FilterExternalBGP</pre>	Redistributes the selected protocol into OSPF through the configured route map. Note Beginning with Cisco NX-OS Release 7.0(3)I7(6), if you redistribute default routes into OSPF, Cisco NX-OS requires the default-information originate command to successfully advertise the default route.

	Command or Action	Purpose
Step 4	default-information originate [always] [route-map map-name] Example: <pre>switch(config-router)# default-information-originate route-map DefaultRouteFilter</pre>	Creates a default route into this OSPF domain if the default route exists in the RIB. Use the following optional keywords: <ul style="list-style-type: none"> • always—Always generate the default route of 0.0.0. even if the route does not exist in the RIB. • route-map—Generate the default route if the route map returns true. Note This command ignores match statements in the route map.
Step 5	default-metric [cost] Example: <pre>switch(config-router)# default-metric 25</pre>	Sets the cost metric for the redistributed routes. This command does not apply to directly connected routes. Use a route map to set the default metric for directly connected routes.
Step 6	(Optional) copy running-config startup-config Example: <pre>switch(config)# copy running-config startup-config</pre>	Copies the running configuration to the startup configuration.

Example

This example shows how to redistribute the Border Gateway Protocol (BGP) into OSPF:

```
switch# configure terminal
switch(config)# router ospf 201
switch(config-router)# redistribute bgp route-map FilterExternalBGP
switch(config-router)# copy running-config startup-config
```

Limiting the Number of Redistributed Routes

Route redistribution can add many routes to the OSPFv2 route table. You can configure a maximum limit to the number of routes accepted from external protocols. OSPFv2 provides the following options to configure redistributed route limits:

- **Fixed limit**—Logs a message when OSPFv2 reaches the configured maximum. OSPFv2 does not accept any more redistributed routes. You can optionally configure a threshold percentage of the maximum where OSPFv2 logs a warning when that threshold is passed.
- **Warning only**—Logs a warning only when OSPFv2 reaches the maximum. OSPFv2 continues to accept redistributed routes.
- **Withdraw**—Starts the timeout period when OSPFv2 reaches the maximum. After the timeout period, OSPFv2 requests all redistributed routes if the current number of redistributed routes is less than the maximum limit. If the current number of redistributed routes is at the maximum limit, OSPFv2 withdraws all redistributed routes. You must clear this condition before OSPFv2 accepts more redistributed routes.

- You can optionally configure the timeout period.

Before you begin

Ensure that you have enabled the OSPF feature (see the [Enabling OSPFv2](#) section).

SUMMARY STEPS

1. **configure terminal**
2. **router ospf *instance-tag***
3. **redistribute {*bgp id* | *direct* | *eigrp id* | *isis id* | *ospf id* | *rip id* | *static*} route-map *map-name***
4. **redistribute maximum-prefix *max* [*threshold*] [*warning-only* | *withdraw* [*num-retries* *timeout*]]**
5. (Optional) **show running-config ospf**
6. (Optional) **copy running-config startup-config**

DETAILED STEPS

	Command or Action	Purpose
Step 1	configure terminal Example: <pre>switch# configure terminal switch(config)#</pre>	Enters global configuration mode.
Step 2	router ospf <i>instance-tag</i> Example: <pre>switch(config)# router ospf 201 switch(config-router)#</pre>	Creates a new OSPFv2 instance with the configured instance tag.
Step 3	redistribute {<i>bgp id</i> <i>direct</i> <i>eigrp id</i> <i>isis id</i> <i>ospf id</i> <i>rip id</i> <i>static</i>} route-map <i>map-name</i> Example: <pre>switch(config-router)# redistribute bgp route-map FilterExternalBGP</pre>	Redistributes the selected protocol into OSPF through the configured route map.
Step 4	redistribute maximum-prefix <i>max</i> [<i>threshold</i>] [<i>warning-only</i> <i>withdraw</i> [<i>num-retries</i> <i>timeout</i>]] Example: <pre>switch(config-router)# redistribute maximum-prefix 1000 75 warning-only</pre>	<p>Specifies a maximum number of prefixes that OSPFv2 distributes. The range is from 0 to 65536. Optionally specifies the following:</p> <ul style="list-style-type: none"> • <i>threshold</i>—Percentage of maximum prefixes that trigger a warning message. • <i>warning-only</i>—Logs a warning message when the maximum number of prefixes is exceeded. • <i>withdraw</i>—Withdraws all redistributed routes. Optionally tries to retrieve the redistributed routes. The <i>num-retries</i> range is from 1 to 12. The <i>timeout</i> range is 60 to 600 seconds. The default is 300 seconds. Use the clear ip ospf redistribution command if all routes are withdrawn.

	Command or Action	Purpose
Step 5	(Optional) show running-config ospf Example: switch(config-router)# show running-config ospf	Displays the OSPFv2 configuration.
Step 6	(Optional) copy running-config startup-config Example: switch(config)# copy running-config startup-config	Copies the running configuration to the startup configuration.

Example

This example shows how to limit the number of redistributed routes into OSPF:

```
switch# configure terminal
switch(config)# router ospf 201
switch(config-router)# redistribute bgp route-map FilterExternalBGP
switch(config-router)# redistribute maximum-prefix 1000 75
```

Configuring Route Summarization

You can configure route summarization for inter-area routes by configuring an address range that is summarized. You can also configure route summarization for external, redistributed routes by configuring a summary address for those routes on an ASBR. For more information, see the [Route Summarization](#) section.

Before you begin

Ensure that you have enabled the OSPF feature (see the [Enabling OSPFv2](#) section).

SUMMARY STEPS

1. **configure terminal**
2. **router ospf** *instance-tag*
3. **area** *area-id* **range** *ip-prefix/length* [**no-advertise**] [**cost** *cost*]
4. **summary-address** *ip-prefix/length* [**no-advertise** | **tag** *tag*]
5. (Optional) **show ip ospf summary-address**
6. (Optional) **copy running-config startup-config**

DETAILED STEPS

	Command or Action	Purpose
Step 1	configure terminal Example: switch# configure terminal switch(config)#	Enters global configuration mode.

	Command or Action	Purpose
Step 2	router ospf <i>instance-tag</i> Example: <pre>switch(config)# router ospf 201 switch(config-router)#</pre>	Creates a new OSPFv2 instance with the configured instance tag.
Step 3	area <i>area-id range ip-prefix/length [no-advertise] [cost cost]</i> Example: <pre>switch(config-router)# area 0.0.0.10 range 10.3.0.0/16</pre>	Creates a summary address on an ABR for a range of addresses and optionally does not advertise this summary address in a Network Summary (type 3) LSA. The <i>cost</i> range is from 0 to 16777215.
Step 4	summary-address <i>ip-prefix/length [no-advertise tag tag]</i> Example: <pre>switch(config-router)# summary-address 10.5.0.0/16 tag 2</pre>	Creates a summary address on an ASBR for a range of addresses and optionally assigns a tag for this summary address that can be used for redistribution with route maps.
Step 5	(Optional) show ip ospf summary-address Example: <pre>switch(config-router)# show ip ospf summary-address</pre>	Displays information about OSPF summary addresses.
Step 6	(Optional) copy running-config startup-config Example: <pre>switch(config)# copy running-config startup-config</pre>	Copies the running configuration to the startup configuration.

Example

This example shows how to create summary addresses between areas on an ABR:

```
switch# configure terminal
switch(config)# router ospf 201
switch(config-router)# area 0.0.0.10 range 10.3.0.0/16
switch(config-router)# copy running-config startup-config
```

This example shows how to create summary addresses on an ASBR:

```
switch# configure terminal
switch(config)# router ospf 201
switch(config-router)# summary-address 10.5.0.0/16
switch(config-router)# copy running-config startup-config
```

Configuring Stub Route Advertisements

Use stub route advertisements when you want to limit the OSPFv2 traffic through this router for a short time. For more information, see the [OSPFv2 Stub Router Advertisements](#) section.

Stub route advertisements can be configured with the following optional parameters:

- On startup—Sends stub route advertisements for the specified announce time.

- Wait for BGP—Sends stub router advertisements until BGP converges.



Note You should not save the running configuration of a router when it is configured for a graceful shutdown because the router continues to advertise a maximum metric after it is reloaded.

Before you begin

Ensure that you have enabled the OSPF feature (see the [Enabling OSPFv2](#) section).

SUMMARY STEPS

1. **configure terminal**
2. **router ospf** *instance-tag*
3. **max-metric router-lsa** [**external-lsa** [*max-metric-value*]] [**include-stub**] [**on-startup** {*seconds* | **wait-for bgp tag**}] [**summary-lsa** [*max-metric-value*]]
4. (Optional) **copy running-config startup-config**

DETAILED STEPS

	Command or Action	Purpose
Step 1	configure terminal Example: switch# configure terminal switch(config)#	Enters global configuration mode.
Step 2	router ospf <i>instance-tag</i> Example: switch(config)# router ospf 201 switch(config-router)#	Creates a new OSPFv2 instance with the configured instance tag.
Step 3	max-metric router-lsa [external-lsa [<i>max-metric-value</i>]] [include-stub] [on-startup { <i>seconds</i> wait-for bgp tag }] [summary-lsa [<i>max-metric-value</i>]] Example: switch(config-router)# max-metric router-lsa	Configures OSPFv2 stub route advertisements.
Step 4	(Optional) copy running-config startup-config Example: switch(config)# copy running-config startup-config	Copies the running configuration to the startup configuration.

Example

This example shows how to enable the stub router advertisements on startup for the default 600 seconds:

```
switch# configure terminal
switch(config)# router ospf 201
switch(config-router)# max-metric router-lsa on-startup
switch(config-router)# copy running-config startup-config
```

Configuring the Administrative Distance of Routes

You can set the administrative distance of routes added by OSPFv2 into the RIB.

The administrative distance is a rating of the trustworthiness of a routing information source. A higher value indicates a lower trust rating. Typically, a route can be learned through more than one routing protocol. The administrative distance is used to discriminate between routes learned from more than one routing protocol. The route with the lowest administrative distance is installed in the IP routing table.

OSPF supports a table map to filter and change the distances of IPv4 and IPv6 prefixes.

Before you begin

Ensure that you have enabled OSPF (see the [Enabling OSPFv2](#) section).

See the guidelines and limitations for this feature in the [Guidelines and Limitations for OSPFv2](#) section.

SUMMARY STEPS

1. **configure terminal**
2. **router ospf** *instance-tag*
3. **[no] table-map** *map-name*
4. **exit**
5. **route-map** *map-name* [**permit** | **deny**] [*seq*]
6. **match route-type** *route-type*
7. **match ip route-source prefix-list** *name*
8. **match ip address prefix-list** *name*
9. **set distance** *value*
10. (Optional) **copy running-config startup-config**

DETAILED STEPS

	Command or Action	Purpose
Step 1	configure terminal Example: <pre>switch# configure terminal switch(config)#</pre>	Enters global configuration mode.
Step 2	router ospf <i>instance-tag</i> Example: <pre>switch(config)# router ospf 201 switch(config-router)#</pre>	Creates a new OSPFv2 instance with the configured instance tag.

	Command or Action	Purpose
Step 3	[no] table-map <i>map-name</i> Example: switch(config-router)# table-map foo	Configures the policy for filtering or modifying OSPFv2 routes before sending them to the RIB. You can enter up to 63 alphanumeric characters for the map name.
Step 4	exit Example: switch(config-router)# exit switch(config)#	Exits router configuration mode.
Step 5	route-map <i>map-name</i> [permit deny] [<i>seq</i>] Example: switch(config)# route-map foo permit 10 switch(config-route-map)#	Creates a route map or enters route-map configuration mode for an existing route map. Use <i>seq</i> to order the entries in a route map. Note The permit option enables you to set the distance. If you use the deny option, the default distance is applied.
Step 6	match route-type <i>route-type</i> Example: switch(config-route-map)# match route-type external	Matches against one of the following route types: <ul style="list-style-type: none"> • external—The external route (BGP, EIGRP, and OSPF type 1 or 2) • inter-area—OSPF inter-area route • internal—The internal route (including the OSPF intra- or inter-area) • intra-area—OSPF intra-area route • nssa-external—The NSSA external route (OSPF type 1 or 2) • type-1—The OSPF external type 1 route • type-2—The OSPF external type 2 route
Step 7	match ip route-source prefix-list <i>name</i> Example: switch(config-route-map)# match ip route-source prefix-list p1	Matches the IPv4 route source address or router ID of a route to one or more IP prefix lists. Use the ip prefix-list command to create the prefix list.
Step 8	match ip address prefix-list <i>name</i> Example: switch(config-route-map)# match ip address prefix-list p1	Matches against one or more IPv4 prefix lists. Use the ip prefix-list command to create the prefix list.
Step 9	set distance <i>value</i> Example: switch(config-route-map)# set distance 150	Sets the administrative distance of routes for OSPFv2. The range is from 1 to 255.

	Command or Action	Purpose
Step 10	(Optional) copy running-config startup-config Example: switch(config-route-map)# copy running-config startup-config	Saves this configuration change.

Example

This example shows how to configure the OSPFv2 administrative distance for inter-area routes to 150, for external routes to 200, and for all prefixes in prefix list p1 to 190:

```
switch# configure terminal
switch(config)# router ospf 201
switch(config-router)# table-map foo
switch(config-router)# exit
switch(config)# route-map foo permit 10
switch(config-route-map)# match route-type inter-area
switch(config-route-map)# set distance 150
switch(config-route-map)# exit
switch(config)# route-map foo permit 20
switch(config-route-map)# match route-type external
switch(config-route-map)# set distance 200
switch(config-route-map)# exit
switch(config)# route-map foo permit 30
switch(config-route-map)# match ip route-source prefix-list p1
switch(config-route-map)# match ip address prefix-list p1
switch(config-route-map)# set distance 190
```

Modifying the Default Timers

OSPFv2 includes a number of timers that control the behavior of protocol messages and shortest path first (SPF) calculations. OSPFv2 includes the following optional timer parameters:

- LSA arrival time—Sets the minimum interval allowed between LSAs that arrive from a neighbor. LSAs that arrive faster than this time are dropped.
- Pacing LSAs—Sets the interval at which LSAs are collected into a group and refreshed, checksummed, or aged. This timer controls how frequently LSA updates occur and optimizes how many are sent in an LSA update message (see the [Flooding and LSA Group Pacing, on page 154](#) section).
- Throttle LSAs—Sets the rate limits for generating LSAs. This timer controls how frequently LSAs are generated after a topology change occurs.
- Throttle SPF calculation—Controls how frequently the SPF calculation is run.

At the interface level, you can also control the following timers:

- Retransmit interval—Sets the estimated time between successive LSAs
- Transmit delay—Sets the estimated time to transmit an LSA to a neighbor.

See the [Configuring Networks in OSPFv2](#) section for information about the hello interval and dead timer.

Before you begin

Ensure that you have enabled the OSPF feature (see the [Enabling OSPFv2](#) section).

SUMMARY STEPS

1. **configure terminal**
2. **router ospf** *instance-tag*
3. **timers lsa-arrival** *msec*
4. **timers lsa-group-pacing** *seconds*
5. **timers throttle lsa** *start-time hold-interval max-time*
6. **timers throttle spf** *delay-time hold-time max-wait*
7. **interface** *type slot/port*
8. **ip ospf hello-interval** *seconds*
9. **ip ospf dead-interval** *seconds*
10. **ip ospf retransmit-interval** *seconds*
11. **ip ospf transmit-delay** *seconds*
12. (Optional) **show ip ospf**
13. (Optional) **copy running-config startup-config**

DETAILED STEPS

	Command or Action	Purpose
Step 1	configure terminal Example: <pre>switch# configure terminal switch(config)#</pre>	Enters global configuration mode.
Step 2	router ospf <i>instance-tag</i> Example: <pre>switch(config)# router ospf 201 switch(config-router)#</pre>	Creates a new OSPFv2 instance with the configured instance tag.
Step 3	timers lsa-arrival <i>msec</i> Example: <pre>switch(config-router)# timers lsa-arrival 2000</pre>	Sets the LSA arrival time in milliseconds. The range is from 10 to 600000. The default is 1000 milliseconds.
Step 4	timers lsa-group-pacing <i>seconds</i> Example: <pre>switch(config-router)# timers lsa-group-pacing 1800</pre>	Sets the interval in seconds for grouping LSAs. The range is from 1 to 1800. The default is 240 seconds.
Step 5	timers throttle lsa <i>start-time hold-interval max-time</i> Example: <pre>switch(config-router)# timers throttle lsa 3000 6000 6000</pre>	Sets the rate limit in milliseconds for generating LSAs with the following timers: <ul style="list-style-type: none"> • <i>start-time</i>—The range is from 0 to 5000 milliseconds. The default value is 0 milliseconds.

	Command or Action	Purpose
		<ul style="list-style-type: none"> • <i>hold-interval</i>—The range is from 50 to 30,000 milliseconds. The default value is 5000 milliseconds. • <i>max-time</i>—The range is from 50 to 30,000 milliseconds. The default value is 5000 milliseconds.
Step 6	timers throttle spf <i>delay-time hold-time max-wait</i> Example: <pre>switch(config-router)# timers throttle spf 3000 2000 4000</pre>	Sets the SPF best path schedule in seconds between SPF best path calculations with the following timers: <ul style="list-style-type: none"> • <i>delay-time</i>—The range is from 1 to 600,000 milliseconds. The default value is 200 milliseconds. • <i>hold-time</i>—The range is from 1 to 600,000 milliseconds. The default value is 1000 milliseconds. • <i>max-wait</i> —The range is from 1 to 600,000 milliseconds. The default value is 5000 milliseconds.
Step 7	interface <i>type slot/port</i> Example: <pre>switch(config)# interface ethernet 1/2 switch(config-if)</pre>	Enters interface configuration mode.
Step 8	ip ospf hello-interval <i>seconds</i> Example: <pre>switch(config-if)# ip ospf hello-interval 30</pre>	Sets the hello interval for this interface. The range is from 1 to 65535. The default is 10.
Step 9	ip ospf dead-interval <i>seconds</i> Example: <pre>switch(config-if)# ip ospf dead-interval 30</pre>	Sets the dead interval for this interface. The range is from 1 to 65535.
Step 10	ip ospf retransmit-interval <i>seconds</i> Example: <pre>switch(config-if)# ip ospf retransmit-interval 30</pre>	Sets the estimated time in seconds between LSAs transmitted from this interface. The range is from 1 to 65535. The default is 5.
Step 11	ip ospf transmit-delay <i>seconds</i> Example: <pre>switch(config-if)# ip ospf transmit-delay 450 switch(config-if)#</pre>	Sets the estimated time in seconds to transmit an LSA to a neighbor. The range is from 1 to 450. The default is 1.
Step 12	(Optional) show ip ospf Example: <pre>switch(config-if)# show ip ospf</pre>	Displays information about OSPF.
Step 13	(Optional) copy running-config startup-config Example:	Copies the running configuration to the startup configuration.

	Command or Action	Purpose
	switch(config)# copy running-config startup-config	

Example

This example shows how to control LSA flooding with the lsa-group-pacing option:

```
switch# configure terminal
switch(config)# router ospf 201
switch(config-router)# timers lsa-group-pacing 300
switch(config-router)# copy running-config startup-config
```

Configuring Graceful Restart

Graceful restart is enabled by default. You can configure the following optional parameters for graceful restart in an OSPFv2 instance:

- Grace period—Configures how long neighbors should wait after a graceful restart has started before tearing down adjacencies.
- Helper mode disabled—Disables helper mode on the local OSPFv2 instance. OSPFv2 does not participate in the graceful restart of a neighbor.
- Planned graceful restart only—Configures OSPFv2 to support graceful restart only in the event of a planned restart.

Before you begin

Ensure that you have enabled OSPF (see the [Enabling OSPFv2](#) section).

Ensure that all neighbors are configured for graceful restart with matching optional parameters set.

SUMMARY STEPS

1. **configure terminal**
2. **router ospf *instance-tag***
3. **graceful-restart**
4. (Optional) **graceful-restart grace-period *seconds***
5. (Optional) **graceful-restart helper-disable**
6. (Optional) **graceful-restart planned-only**
7. (Optional) **show ip ospf *instance-tag***
8. (Optional) **copy running-config startup-config**

DETAILED STEPS

	Command or Action	Purpose
Step 1	configure terminal Example:	Enters global configuration mode.

	Command or Action	Purpose
	switch# configure terminal switch(config)#	
Step 2	router ospf <i>instance-tag</i> Example: switch(config)# router ospf 201 switch(config-router)#	Creates a new OSPFv2 instance with the configured instance tag.
Step 3	graceful-restart Example: switch(config-router)# graceful-restart	Enables a graceful restart. A graceful restart is enabled by default.
Step 4	(Optional) graceful-restart grace-period <i>seconds</i> Example: switch(config-router)# graceful-restart grace-period 120	Sets the grace period, in seconds. The range is from 5 to 1800. The default is 60 seconds.
Step 5	(Optional) graceful-restart helper-disable Example: switch(config-router)# graceful-restart helper-disable	Disables helper mode. This feature is enabled by default.
Step 6	(Optional) graceful-restart planned-only Example: switch(config-router)# graceful-restart planned-only	Configures a graceful restart for planned restarts only.
Step 7	(Optional) show ip ospf <i>instance-tag</i> Example: switch(config-router)# show ip ospf 201	Displays OSPF information.
Step 8	(Optional) copy running-config startup-config Example: switch(config)# copy running-config startup-config	Copies the running configuration to the startup configuration.

Example

This example shows how to enable a graceful restart if it has been disabled and set the grace period to 120 seconds:

```
switch# configure terminal
switch(config)# router ospf 201
switch(config-router)# graceful-restart
switch(config-router)# graceful-restart grace-period 120
switch(config-router)# copy running-config startup-config
```

Restarting an OSPFv2 Instance

You can restart an OSPFv2 instance. This action clears all neighbors for the instance.

To restart an OSPFv2 instance and remove all associated neighbors, use the following command:

SUMMARY STEPS

1. **restart ospf** *instance-tag*

DETAILED STEPS

	Command or Action	Purpose
Step 1	restart ospf <i>instance-tag</i> Example: switch(config)# restart ospf 201	Restarts the OSPFv2 instance and removes all neighbors.

Configuring OSPFv2 with Virtualization

You can create multiple OSPFv2 instances. You can also create multiple VRFs and use the same or multiple OSPFv2 instances in each VRF. You can assign an OSPFv2 interface to a VRF.



Note Configure all other parameters for an interface after you configure the VRF for an interface. Configuring a VRF for an interface deletes all the configuration for that interface.

Before you begin

Ensure that you have enabled the OSPF feature (see the [Enabling OSPFv2](#) section).

SUMMARY STEPS

1. **configure terminal**
2. **vrf context** *vrf-name*
3. **router ospf** *instance-tag*
4. **vrf** *vrf-name*
5. (Optional) **maximum-paths** *path*
6. **interface** *interface-type slot/port*
7. **vrf member** *vrf-name*
8. **ip address** *ip-prefix/length*
9. **ip router ospf** *instance-tag area area-id*
10. (Optional) **copy running-config startup-config**

DETAILED STEPS

	Command or Action	Purpose
Step 1	configure terminal Example: switch# configure terminal switch(config)#	Enters global configuration mode.
Step 2	vrf context vrf-name Example: switch(config)# vrf context RemoteOfficeVRF switch(config-vrf)#	Creates a new VRF and enters VRF configuration mode.
Step 3	router ospf instance-tag Example: switch(config-vrf)# router ospf 201 switch(config-router)#	Creates a new OSPFv2 instance with the configured instance tag.
Step 4	vrf vrf-name Example: switch(config-router)# vrf RemoteOfficeVRF switch(config-router-vrf)#	Enters VRF configuration mode.
Step 5	(Optional) maximum-paths path Example: switch(config-router-vrf)# maximum-paths 4	Configures the maximum number of equal OSPFv2 paths to a destination in the route table for this VRF. This feature is used for load balancing.
Step 6	interface interface-type slot/port Example: switch(config-router-vrf)# interface ethernet 1/2 switch(config-if)#	Enters interface configuration mode.
Step 7	vrf member vrf-name Example: switch(config-if)# vrf member RemoteOfficeVRF	Adds this interface to a VRF.
Step 8	ip address ip-prefix/length Example: switch(config-if)# ip address 192.0.2.1/16	Configures an IP address for this interface. You must do this step after you assign this interface to a VRF.
Step 9	ip router ospf instance-tag area area-id Example: switch(config-if)# ip router ospf 201 area 0	Assigns this interface to the OSPFv2 instance and area configured.

	Command or Action	Purpose
Step 10	(Optional) copy running-config startup-config Example: switch(config)# copy running-config startup-config	Copies the running configuration to the startup configuration.

Example

This example shows how to create a VRF and add an interface to the VRF:

```
switch# configure terminal
switch(config)# vrf context NewVRF
switch(config)# router ospf 201
switch(config)# interface ethernet 1/2
switch(config-if)# vrf member NewVRF
switch(config-if)# ip address 192.0.2.1/16
switch(config-if)# ip router ospf 201 area 0
switch(config-if)# copy running-config startup-config
```

Verifying the OSPFv2 Configuration

To display the OSPFv2 configuration, perform one of the following tasks:

Command	Purpose
show ip ospf [<i>instance-tag</i>] [vrf <i>vrf-name</i>]	Displays information about one or more OSPF routing instances. The output includes the following area-level counts: <ul style="list-style-type: none"> • Interfaces in this area—A count of all interfaces added to this area (configured interfaces). • Active interfaces—A count of all interfaces considered to be in router link states and SPF (UP interfaces). • Passive interfaces—A count of all interfaces considered to be OSPF passive (no adjacencies will be formed). • Loopback interfaces—A count of all local loopback interfaces.
show ip ospf border-routers [vrf { <i>vrf-name</i> all default management }]	Displays the OSPFv2 border router configuration.
show ip ospf database [vrf { <i>vrf-name</i> all default management }]	Displays the OSPFv2 link-state database summary.
show ip ospf interface <i>number</i> [vrf { <i>vrf-name</i> all default management }]	Displays OSPFv2-related interface information.

Command	Purpose
show ip ospf lsa-content-changed-list <i>neighbor-id interface - type number</i> [vrf { <i>vrf-name</i> all default management }]	Displays the OSPFv2 LSAs that have changed.
show ip ospf neighbors [<i>neighbor-id</i>] [detail] [<i>interface - type number</i>] [vrf { <i>vrf-name</i> all default management }] [summary]	Displays the list of OSPFv2 neighbors.
show ip ospf request-list <i>neighbor-id interface - type number</i> [vrf { <i>vrf-name</i> all default management }]	Displays the list of OSPFv2 link-state requests.
show ip ospf retransmission-list <i>neighbor-id interface - type number</i> [vrf { <i>vrf-name</i> all default management }]	Displays the list of OSPFv2 link-state retransmissions.
show ip ospf route [<i>ospf-route</i>] [summary] [vrf { <i>vrf-name</i> all default management }]	Displays the internal OSPFv2 routes.
show ip ospf summary-address [vrf { <i>vrf-name</i> all default management }]	Displays information about the OSPFv2 summary addresses.
show ip ospf virtual-links [brief] [vrf { <i>vrf-name</i> all default management }]	Displays information about OSPFv2 virtual links.
show ip ospf vrf { <i>vrf-name</i> all default management }	Displays information about the VRF-based OSPFv2 configuration.
show running-configuration ospf	Displays the current running OSPFv2 configuration.

Monitoring OSPFv2

To display OSPFv2 statistics, use the following commands:

Command	Purpose
show ip ospf policy statistics area <i>area-id filter list</i> { in out } [vrf { <i>vrf-name</i> all default management }]	Displays the OSPFv2 route policy statistics for an area.
show ip policy statistics redistribute { bgp id direct eigrp id isis id ospf id rip id static } [vrf { <i>vrf-name</i> all default management }]	Displays the OSPFv2 route policy statistics.
show ip ospf statistics [vrf { <i>vrf-name</i> all default management }]	Displays the OSPFv2 event counters.
show ip ospf traffic [<i>interface-type number</i>] [vrf { <i>vrf-name</i> all default management }]	Displays the OSPFv2 packet counters.

Configuration Examples for OSPFv2

The following example shows how to configure OSPFv2:

```
feature ospf
router ospf 201
  router-id 290.0.2.1
interface ethernet 1/2
  ip router ospf 201 area 0.0.0.10
  ip ospf authentication
  ip ospf authentication-key 0 mypass
```

OSPF RFC Compatibility Mode Example

The following example shows how to configure OSPF to be compatible with routers that comply with RFC 1583:



Note You must configure RFC 1583 compatibility on any VRF that connects to routers running only RFC 1583 compatible OSPF.

```
switch# configure terminal
switch(config)# feature ospf
switch(config)# router ospf Test1
switch(config-router)# rfc1583compatibility
switch(config-router)# vrf A
switch(config-router-vrf)# rfc1583compatibility
```

Additional References

For additional information related to implementing OSPF, see the following sections:

Related Documents for OSPFv2

Related Topic	Document Title
Keychains	Cisco Nexus 9000 Series NX-OS Security Configuration Guide
OSPFv3 for IPv6 networks	Configuring OSPFv3, on page 149
Route maps	Configuring Route Policy Manager

MIBs

MIBs	MIBs Link
MIBs related to OSPFv2	To locate and download supported MIBs, go to the following URL: ftp://ftp.cisco.com/pub/mibs/supportlists/nexus9000/Nexus9000MIBSupportList.html



CHAPTER 7

Configuring OSPFv3

This chapter describes how to configure Open Shortest Path First version 3 (OSPFv3) for IPv6 networks on the Cisco NX-OS device.

This chapter includes the following sections:

- [About OSPFv3, on page 149](#)
- [Multi-Area Adjacency, on page 155](#)
- [OSPFv3 and the IPv6 Unicast RIB, on page 155](#)
- [Address Family Support, on page 156](#)
- [Authentication and Encryption, on page 156](#)
- [Advanced Features, on page 156](#)
- [Prerequisites for OSPFv3, on page 161](#)
- [Guidelines and Limitations for OSPFv3, on page 161](#)
- [Default Settings, on page 163](#)
- [Configuring Basic OSPFv3, on page 163](#)
- [Configuring Advanced OSPFv3, on page 169](#)
- [Configuring Encryption and Authentication, on page 193](#)
- [Verifying the OSPFv3 Configuration, on page 205](#)
- [Monitoring OSPFv3, on page 206](#)
- [Configuration Examples for OSPFv3, on page 206](#)
- [Related Topics, on page 207](#)
- [Additional References, on page 207](#)

About OSPFv3

OSPFv3 is an IETF link-state protocol (see [Overview, on page 3](#) section). An OSPFv3 router sends a special message, called a hello packet, out each OSPF-enabled interface to discover other OSPFv3 neighbor routers. Once a neighbor is discovered, the two routers compare information in the Hello packet to determine if the routers have compatible configurations. The neighbor routers attempt to establish adjacency, which means that the routers synchronize their link-state databases to ensure that they have identical OSPFv3 routing information. Adjacent routers share link-state advertisements (LSAs) that include information about the operational state of each link, the cost of the link, and any other neighbor information. The routers then flood these received LSAs out every OSPF-enabled interface so that all OSPFv3 routers eventually have identical link-state databases. When all OSPFv3 routers have identical link-state databases, the network is converged.

(see the [Convergence](#) section). Each router then uses Dijkstra's Shortest Path First (SPF) algorithm to build its route table.

You can divide OSPFv3 networks into areas. Routers send most LSAs only within one area, which reduces the CPU and memory requirements for an OSPF-enabled router.

OSPFv3 supports IPv6. For information about OSPF for IPv4, see [Configuring OSPFv2, on page 99](#).

Comparison of OSPFv3 and OSPFv2

Much of the OSPFv3 protocol is the same as in OSPFv2. OSPFv3 is described in RFC 2740.

The key differences between the OSPFv3 and OSPFv2 protocols are as follows:

- OSPFv3 expands on OSPFv2 to provide support for IPv6 routing prefixes and the larger size of IPv6 addresses.
- LSAs in OSPFv3 are expressed as prefix and prefix length instead of address and mask.
- The router ID and area ID are 32-bit numbers with no relationship to IPv6 addresses.
- OSPFv3 uses link-local IPv6 addresses for neighbor discovery and other features.
- OSPFv3 can use the IPv6 authentication trailer (RFC 6506) or IPsec (RFC 4552) for authentication. However, Cisco NX-OS does not support RFC 6506.
- OSPFv3 redefines LSA types.

Hello Packet

OSPFv3 routers periodically send Hello packets on every OSPF-enabled interface. The hello interval determines how frequently the router sends these Hello packets and is configured per interface. OSPFv3 uses Hello packets for the following tasks:

- Neighbor discovery
- Keepalives
- Bidirectional communications
- Designated router election (see the [Designated Routers](#) section)

The Hello packet contains information about the originating OSPFv3 interface and router, including the assigned OSPFv3 cost of the link, the hello interval, and optional capabilities of the originating router. An OSPFv3 interface that receives these Hello packets determines if the settings are compatible with the receiving interface settings. Compatible interfaces are considered neighbors and are added to the neighbor table (see the [Neighbors](#) section).

Hello packets also include a list of router IDs for the routers that the originating interface has communicated with. If the receiving interface sees its own router ID in this list, then bidirectional communication has been established between the two interfaces.

OSPFv3 uses Hello packets as a keepalive message to determine if a neighbor is still communicating. If a router does not receive a Hello packet by the configured dead interval (usually a multiple of the hello interval), then the neighbor is removed from the local neighbor table.

Neighbors

An OSPFv3 interface must have a compatible configuration with a remote interface before the two can be considered neighbors. The two OSPFv3 interfaces must match the following criteria:

- Hello interval
- Dead interval
- Area ID (see the [Areas](#) section)
- Optional capabilities

If there is a match, the information is entered into the neighbor table:

- Neighbor ID—The router ID of the neighbor router.
- Priority—Priority of the neighbor router. The priority is used for designated router election (see the [Designated Routers](#) section).
- State—Indication of whether the neighbor has just been heard from, is in the process of setting up bidirectional communications, is sharing the link-state information, or has achieved full adjacency.
- Dead time—Indication of how long since the last Hello packet was received from this neighbor.
- Link-local IPv6 Address—The link-local IPv6 address of the neighbor.
- Designated Router—Indication of whether the neighbor has been declared the designated router or backup designated router (see the [Designated Routers](#) section).
- Local interface—The local interface that received the Hello packet for this neighbor.

When the first Hello packet is received from a new neighbor, the neighbor is entered into the neighbor table in the initialization state. Once bidirectional communication is established, the neighbor state becomes two-way. ExStart and exchange states come next, as the two interfaces exchange their link-state database. Once this is all complete, the neighbor moves into the full state, which signifies full adjacency. If the neighbor fails to send any Hello packets in the dead interval, then the neighbor is moved to the down state and is no longer considered adjacent.

Adjacency

Not all neighbors establish adjacency. Depending on the network type and designated router establishment, some neighbors become fully adjacent and share LSAs with all their neighbors, while other neighbors do not. For more information, see the [Designated Routers](#) section.

Adjacency is established using Database Description (DD) packets, Link State Request (LSR) packets, and Link State Update (LSU) packets in OSPFv3. The Database Description packet includes the LSA headers from the link-state database of the neighbor (see the [Link-State Database](#) section). The local router compares these headers with its own link-state database and determines which LSAs are new or updated. The local router sends an LSR packet for each LSA that it needs new or updated information on. The neighbor responds with an LSU packet. This exchange continues until both routers have the same link-state information.

Designated Routers

Networks with multiple routers present a unique situation for OSPFv3. If every router floods the network with LSAs, the same link-state information is sent from multiple sources. Depending on the type of network, OSPFv3 might use a single router, the designated router (DR), to control the LSA floods and represent the network to the rest of the OSPFv3 area (see the [Areas](#) section). If the DR fails, OSPFv3 selects a backup designated router (BDR). If the DR fails, OSPFv3 uses the BDR.

Network types are as follows:

- Point-to-point—A network that exists only between two routers. All neighbors on a point-to-point network establish adjacency and there is no DR.
- Broadcast—A network with multiple routers that can communicate over a shared medium that allows broadcast traffic, such as Ethernet. OSPFv3 routers establish a DR and BDR that controls LSA flooding on the network. OSPFv3 uses the well-known IPv6 multicast addresses, FF02::5, and a MAC address of 0100.5300.0005 to communicate with neighbors.

The DR and BDR are selected based on the information in the Hello packet. When an interface sends a Hello packet, it sets the priority field and the DR and BDR field if it knows who the DR and BDR are. The routers follow an election procedure based on which routers declare themselves in the DR and BDR fields and the priority field in the Hello packet. As a final determinant, OSPFv3 chooses the highest router IDs as the DR and BDR.

All other routers establish adjacency with the DR and the BDR and use the IPv6 multicast address FF02::6 to send LSA updates to the DR and BDR. The following figure shows this adjacency relationship between all routers and the DR.

DRs are based on a router interface. A router might be the DR for one network and not for another network on a different interface.

Figure 22: DR in Multi-Access Network

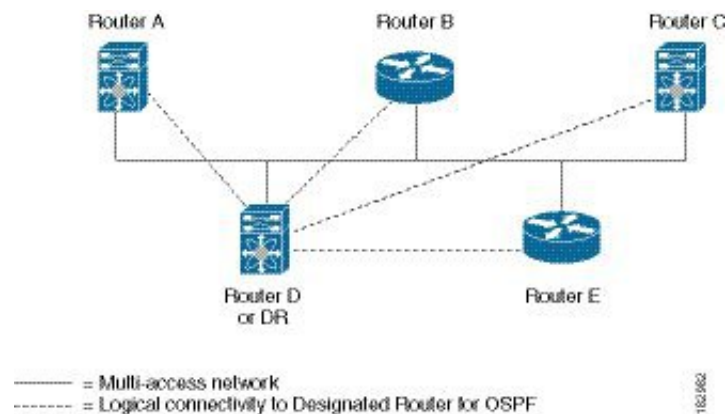

Areas

You can limit the CPU and memory requirements that OSPFv3 puts on the routers by dividing an OSPFv3 network into areas. An area is a logical division of routers and links within an OSPFv3 domain that creates separate subdomains. LSA flooding is contained within an area, and the link-state database is limited to links within the area. You can assign an area ID to the interfaces within the defined area. The Area ID is a 32-bit value that can be expressed as a number or in dotted decimal notation, such as 10.2.3.1.

Cisco NX-OS always displays the area in dotted decimal notation.

If you define more than one area in an OSPFv3 network, you must also define the backbone area, which has the reserved area ID of 0. If you have more than one area, then one or more routers become area border routers (ABRs). An ABR connects to both the backbone area and at least one other defined area.

Figure 23: OSPFv3 Areas

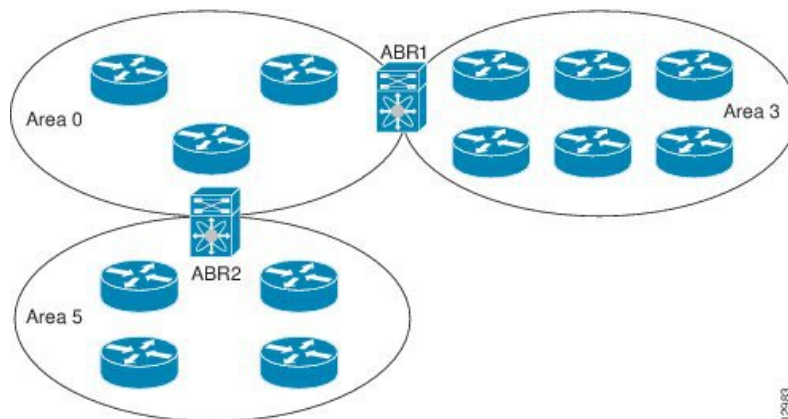

The ABR has a separate link-state database for each area which it connects to. The ABR sends Inter-Area Prefix (type 3) LSAs (see the [Route Summarization](#) section) from one connected area to the backbone area. The backbone area sends summarized information about one area to another area. In the figure, Area 0 sends summarized information about Area 5 to Area 3.

OSPFv3 defines one other router type: the autonomous system boundary router (ASBR). This router connects an OSPFv3 area to another autonomous system. An autonomous system is a network controlled by a single technical administration entity. OSPFv3 can redistribute its routing information into another autonomous system or receive redistributed routes from another autonomous system. For more information, see the [Advanced Features](#) section.

Link-State Advertisement

OSPFv3 uses link-state advertisements (LSAs) to build its routing table.

Link-State Advertisement Types

OSPFv3 uses link-state advertisements (LSAs) to build its routing table.

The table shows the LSA types that are supported by Cisco NX-OS.

Type	Names	Description
1	Router LSA	LSA sent by every router. This LSA includes the state and cost of all links but does not include prefix information. Router LSAs trigger an SPF recalculation. Router LSAs are flooded to the local OSPFv3 area.
2	Network LSA	LSA sent by the DR. This LSA lists all routers in the multi-access network but does not include prefix information. Network LSAs trigger an SPF recalculation. See the Designated Routers section.

Type	Names	Description
3	Inter-Area Prefix LSA	LSA sent by the area border router to an external area for each destination in local area. This LSA includes the link cost from the border router to the local destination. See the Areas section.
4	Inter-Area Router LSA	LSA sent by the area border router to an external area. This LSA advertises the link cost to the ASBR only. See the Areas section.
5	AS External LSA	LSA generated by the ASBR. This LSA includes the link cost to an external autonomous system destination. AS External LSAs are flooded throughout the autonomous system. See the Areas section.
7	Type-7 LSA	LSA generated by the ASBR within an NSSA. This LSA includes the link cost to an external autonomous system destination. Type-7 LSAs are flooded only within the local NSSA. See the Areas section.
8	Link LSA	LSA sent by every router, using a link-local flooding scope. (see the Flooding and LSA Group Pacing section). This LSA includes the link-local address and IPv6 prefixes for this link.
9	Intra-Area Prefix LSA	LSA sent by every router. This LSA includes any prefix or link state changes. Intra-Area Prefix LSAs are flooded to the local OSPFv3 area. This LSA does not trigger an SPF recalculation.
11	Grace LSA	LSA sent by a restarting router, using a link-local flooding scope. This LSA is used for a graceful restart of OSPFv3. See the High Availability and Graceful Restart section.

Link Cost

Each OSPFv3 interface is assigned a link cost. The cost is an arbitrary number. By default, Cisco NX-OS assigns a cost that is the configured reference bandwidth divided by the interface bandwidth. By default, the reference bandwidth is 40 Gbps. The link cost is carried in the LSA updates for each link.

Flooding and LSA Group Pacing

OSPFv3 floods LSA updates to different sections of the network, depending on the LSA type. OSPFv3 uses the following flooding scopes:

- Link-local—LSA is flooded only on the local link. Used for Link LSAs and Grace LSAs.
- Area-local—LSA is flooded throughout a single OSPF area only. Used for Router LSAs, Network LSAs, Inter-Area-Prefix LSAs, Inter-Area-Router LSAs, and Intra-Area-Prefix LSAs.
- AS scope—LSA is flooded throughout the routing domain. An AS scope is used for AS External LSAs.

LSA flooding guarantees that all routers in the network have identical routing information. LSA flooding depends on the OSPFv3 area configuration (see the [Areas](#) section). The LSAs are flooded based on the link-state refresh time (every 30 minutes by default). Each LSA has its own link-state refresh time.

You can control the flooding rate of LSA updates in your network by using the LSA group pacing feature. LSA group pacing can reduce high CPU or buffer utilization. This feature groups LSAs with similar link-state refresh times to allow OSPFv3 to pack multiple LSAs into an OSPFv3 Update message.

By default, LSAs with link-state refresh times within 10 seconds of each other are grouped together. You should lower this value for large link-state databases or raise it for smaller databases to optimize the OSPFv3 load on your network.

Link-State Database

Each router maintains a link-state database for the OSPFv3 network. This database contains all the collected LSAs and includes information on all the routes through the network. OSPFv3 uses this information to calculate the best path to each destination and populates the routing table with these best paths.

LSAs are removed from the link-state database if no LSA update has been received within a set interval, called the MaxAge. Routers flood a repeat of the LSA every 30 minutes to prevent accurate link-state information from being aged out. Cisco NX-OS supports the LSA grouping feature to prevent all LSAs from refreshing at the same time. For more information, see the [Flooding and LSA Group Pacing](#) section.

Multi-Area Adjacency

OSPFv3 multi-area adjacency allows you to configure a link on the primary interface that is in more than one area. This link becomes the preferred intra-area link in those areas. Multi-area adjacency establishes a point-to-point unnumbered link in an OSPFv3 area that provides a topological path for that area. The primary adjacency uses the link to advertise an unnumbered point-to-point link in the Router LSA for the corresponding area when the neighbor state is full.

The multi-area interface exists as a logical construct over an existing primary interface for OSPF; however, the neighbor state on the primary interface is independent of the multi-area interface. The multi-area interface establishes a neighbor relationship with the corresponding multi-area interface on the neighboring router. See the [Configuring Multi-Area Adjacency](#) section for more information.

OSPFv3 and the IPv6 Unicast RIB

OSPFv3 runs the Dijkstra shortest path first algorithm on the link-state database. This algorithm selects the best path to each destination based on the sum of all the link costs for each link in the path. The shortest path for each destination is then put in the OSPFv3 route table. When the OSPFv3 network is converged, this route table feeds into the IPv6 unicast Routing Information Base (RIB). OSPFv3 communicates with the IPv6 unicast RIB to do the following:

- Add or remove routes
- Handle route redistribution from other protocols
- Provide convergence updates to remove stale OSPFv3 routes and for stub router advertisements (see the [Multiple OSPFv3 Instances](#) section).

OSPFv3 also runs a modified Dijkstra algorithm for fast recalculation for Inter-Area Prefix, Inter-Area Router, AS-External, type-7, and Intra-Area Prefix (type 3, 4, 5, 7, 8) LSA changes.

Address Family Support

Cisco NX-OS supports multiple address families, such as unicast IPv6 and multicast IPv6. OSPFv3 features that are specific to an address family are as follows:

- Default routes
- Route summarization
- Route redistribution
- Filter lists for border routers
- SPF optimization

Use the **address-family ipv6 unicast** command to enter the IPv6 unicast address family configuration mode when configuring these features.

Authentication and Encryption

You can configure authentication on OSPFv3 messages to prevent unauthorized or invalid routing updates in your network.

RFC 4552 provides authentication to OSPFv3 using an IPv6 Authentication Header (AH) or Encapsulating Security Payload (ESP) extension header. Cisco NX-OS supports RFC 4552 by using the IPv6 AH header to authenticate OSPFv3 packets.

Cisco NX-OS supports the IP Security (IPSec) authentication method and the Message Digest 5 (MD5) or Secure Hash Algorithm 1 (SHA-1) algorithm to authenticate OSPFv3 packets. OSPFv3 IPSec authentication supports static keys using commands.

Cisco NX-OS also supports the IPSec ESP method for both encryption and authentication of OSPFv3 messages. Encryption supports AES or 3DES algorithm for ESP encryption and SHA-1 or NULL for ESP authentication.

Beginning with Cisco NX-OS Release 10.4(1)F, Cisco NX-OS supports configuring encryption or authentication algorithms and keys using the keychain option.

You can configure IPSec encryption or authentication for an OSPFv3 process, an area, and/or an interface. The authentication configuration is inherited from process to area to interface level. If authentication is configured at all three levels, the interface configuration takes precedence over an area configurations, and an area configuration takes precedence over the process level.

Advanced Features

Cisco NX-OS supports advanced OSPFv3 features that enhance the usability and scalability of OSPFv3 in the network.

Stub Area

You can limit the amount of external routing information that floods an area by making it a stub area. A stub area is an area that does not allow AS External (type 5) LSAs (see the [Link-State Advertisement, on page 153](#)

section). These LSAs are usually flooded throughout the local autonomous system to propagate external route information. Stub areas have the following requirements:

- All routers in the stub area are stub routers. See the [Stub Routing](#) section.
- No ASBR routers exist in the stub area.
- You cannot configure virtual links in the stub area.

The figure shows an example an OSPFv3 autonomous system where all routers in area 0.0.0.10 have to go through the ABR to reach external autonomous systems. Area 0.0.0.10 can be configured as a stub area.

Figure 24: Stub Area

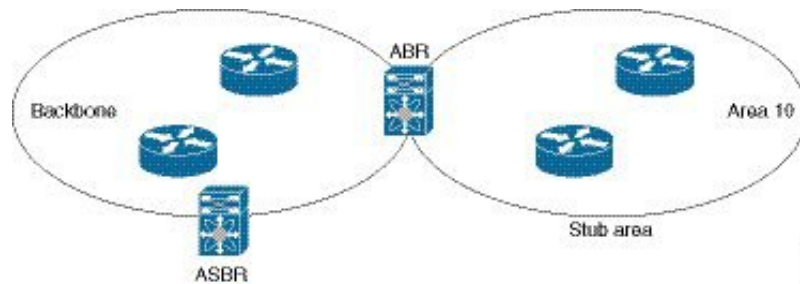

Stub areas use a default route for all traffic that needs to go through the backbone area to the external autonomous system. The default route is an Inter-Area-Prefix LSA with the prefix length set to 0 for IPv6.

Not-So-Stubby Area

A Not-So-Stubby Area (NSSA) is similar to the stub area, except that an NSSA allows you to import autonomous system external routes within an NSSA using redistribution. The NSSA ASBR redistributes these routes and generates type-7 LSAs that it floods throughout the NSSA. You can optionally configure the ABR that connects the NSSA to other areas to translate this type-7 LSA to AS External (type 5) LSAs. The ABR then floods these AS External LSAs throughout the OSPFv3 autonomous system. Summarization and filtering are supported during the translation. See the [Link-State Advertisement, on page 153](#) section for details on type-7 LSAs.

You can, for example, use NSSA to simplify administration if you are connecting a central site using OSPFv3 to a remote site that is using a different routing protocol. Before NSSA, the connection between the corporate site border router and a remote router could not be run as an OSPFv3 stub area because routes for the remote site could not be redistributed into a stub area. With NSSA, you can extend OSPFv3 to cover the remote connection by defining the area between the corporate router and remote router as an NSSA. (see the [Configuring NSSA](#) section).

The backbone Area 0 cannot be an NSSA



Note Beginning with Cisco NX-OS Release 9.3(1), OSPF became compliant with RFC 3101 section 2.5(3). When an Area Border Router attached to a Not-so-Stubby Area receives a default route LSA with P-bit clear, it should be ignored. OSPF had been previously adding the default route under these conditions.

If you have already designed your networks with RFC non-compliant behavior and expect a default route to be added on NSSA ABR, you will see a change in behavior when you upgrade to Cisco NX-OS Release 9.3(1) and later.

If you decide to continue with the old behavior, you have the option to enable it with the **default-route nssa-abr pbit-clear** command. This command was implemented in Cisco NX-OS Release 9.3(1).

Virtual Links

Virtual links allow you to connect an OSPFv3 area ABR to a backbone area ABR when a direct physical connection is not available. The figure shows a virtual link that connects Area 3 to the backbone area through Area 5.

Figure 25: Virtual Links

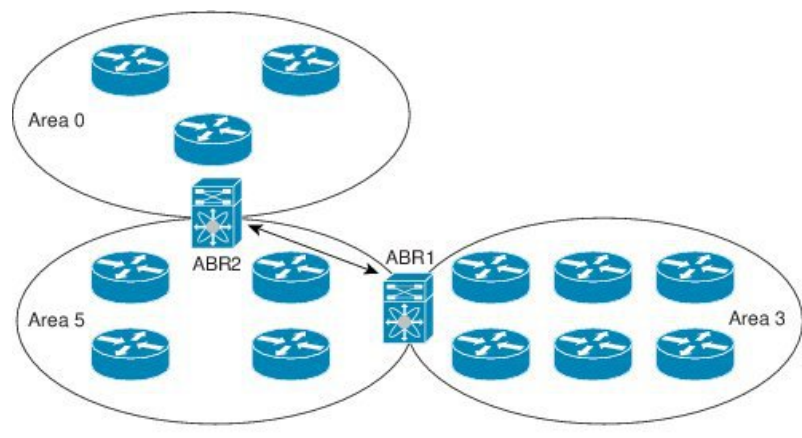

You can also use virtual links to temporarily recover from a partitioned area, which occurs when a link within the area fails, isolating part of the area from reaching the designated ABR to the backbone area.

Route Redistribution

OSPFv3 can learn routes from other routing protocols by using route redistribution. See the [Route Redistribution Overview, on page 8](#) section. You configure OSPFv3 to assign a link cost for these redistributed routes or a default link cost for all redistributed routes.

Route redistribution uses route maps to control which external routes are redistributed. You must configure a route map with the redistribution to control which routes are passed into OSPFv3. A route map allows you to filter routes based on attributes such as the destination, origination protocol, route type, route tag, and so on. You can use route maps to modify parameters in the AS External (type 5) and NSSA External (type 7) LSAs before these external routes are advertised in the local OSPFv3 autonomous system. For more information, see [Configuring Route Policy Manager, on page 515](#).

Route Summarization

Because OSPFv3 shares all learned routes with every OSPF-enabled router, you might want to use route summarization to reduce the number of unique routes that are flooded to every OSPF-enabled router. Route summarization simplifies route tables by replacing more-specific addresses with an address that represents all the specific addresses. For example, you can replace 2010:11:22:0:1000::1 and 2010:11:22:0:2000:679:1 with one summary address, 2010:11:22::/32.

Typically, you would summarize at the boundaries of area border routers (ABRs). Although you could configure summarization between any two areas, it is better to summarize in the direction of the backbone so that the backbone receives all the aggregate addresses and injects them, already summarized, into other areas. The two types of summarization are as follows:

- Inter-area route summarization
- External route summarization

You configure inter-area route summarization on ABRs, summarizing routes between areas in the autonomous system. To take advantage of summarization, assign network numbers in areas in a contiguous way to be able to lump these addresses into one range.

External route summarization is specific to external routes that are injected into OSPFv3 using route redistribution. You should make sure that external ranges that are being summarized are contiguous. Summarizing overlapping ranges from two different routers could cause packets to be sent to the wrong destination. Configure external route summarization on ASBRs that are redistributing routes into OSPF.

When you configure a summary address, Cisco NX-OS automatically configures a discard route for the summary address to prevent routing black holes and route loops.

High Availability and Graceful Restart

Cisco NX-OS provides a multilevel high-availability architecture. OSPFv3 supports stateful restart, which is also referred to as non-stop routing (NSR). If OSPFv3 experiences problems, it attempts to restart from its previous run-time state. The neighbors do not register any neighbor event in this case. If the first restart is not successful and another problem occurs, OSPFv3 attempts a graceful restart.

A graceful restart, or non-stop forwarding (NSF), allows OSPFv3 to remain in the data forwarding path through a process restart. When OSPFv3 needs to perform a graceful restart, it sends a link-local Grace (type 11) LSA. This restarting OSPFv3 platform is called NSF capable.

The Grace LSA includes a grace period, which is a specified time that the neighbor OSPFv3 interfaces hold onto the LSAs from the restarting OSPFv3 interface. (Typically, OSPFv3 tears down the adjacency and discards all LSAs from a down or restarting OSPFv3 interface.) The participating neighbors, which are called NSF helpers, keep all LSAs that originate from the restarting OSPFv3 interface as if the interface was still adjacent.

When the restarting OSPFv3 interface is operational again, it rediscovers its neighbors, establishes adjacency, and starts sending its LSA updates again. At this point, the NSF helpers recognize that the graceful restart has finished.

Stateful restart is used in the following scenarios:

- First recovery attempt after the process experiences problems
- User-initiated switchover using the **system switchover** command

Graceful restart is used in the following scenarios:

- Second recovery attempt after the process experiences problems within a 4-minute interval
- Manual restart of the process using the **restart ospfv3** command
- Active supervisor removal
- Active supervisor reload using the **reload module active-sup** command

Multiple OSPFv3 Instances

Cisco NX-OS supports multiple instances of the OSPFv3 protocol. By default, every instance uses the same system router ID. You must manually configure the router ID for each instance if the instances are in the same OSPFv3 autonomous system. For the number of supported OSPFv3 instances, see the [Cisco Nexus 9000 Series NX-OS Verified Scalability Guide](#).

The OSPFv3 header includes an instance ID field to identify that OSPFv3 packet for a particular OSPFv3 instance. You can assign the OSPFv3 instance. The interface drops all OSPFv3 packets that do not have a matching OSPFv3 instance ID in the packet header.

Cisco NX-OS allows only one OSPFv3 instance on an interface.

SPF Optimization

Cisco NX-OS optimizes the SPF algorithm in the following ways:

- Partial SPF for Network (type 2) LSAs, Inter-Area Prefix (type 3) LSAs, and AS External (type 5) LSAs—When there is a change on any of these LSAs, Cisco NX-OS performs a faster partial calculation rather than running the whole SPF calculation.
- SPF timers—You can configure different timers for controlling SPF calculations. These timers include exponential backoff for subsequent SPF calculations. The exponential backoff limits the CPU load of multiple SPF calculations.

BFD

This feature supports bidirectional forwarding detection (BFD) for IPv6. BFD is a detection protocol that provides fast forwarding-path failure detection times. BFD provides subsecond failure detection between two adjacent devices and can be less CPU-intensive than protocol hello messages, because some of the BFD load can be distributed onto the data plane on supported modules. See the [Cisco Nexus 9000 Series NX-OS Interfaces Configuration Guide](#) for more information.

Virtualization Support

Cisco NX-OS supports multiple process instances of OSPFv3. Each OSPFv3 instance can support multiple virtual routing and forwarding (VRF) instances, up to the system limit. For the number of supported OSPFv3 instances, see the [Cisco Nexus 9000 Series NX-OS Verified Scalability Guide](#).

Prerequisites for OSPFv3

OSPFv3 has the following prerequisites:

- You must be familiar with routing fundamentals to configure OSPFv3.
- You must be logged on to the switch.
- You have configured at least one interface for IPv6 that is capable of communicating with a remote OSPFv3 neighbor.
- You have installed the Enterprise Services license.
- You have completed the OSPFv3 network strategy and planning for your network. For example, you must decide whether multiple areas are required.
- You have enabled OSPF (see the [Enabling OSPFv3](#) section).
- You are familiar with IPv6 addressing and basic configuration. See [Configuring IPv6, on page 51](#) for information on IPv6 routing and addressing.

Guidelines and Limitations for OSPFv3

OSPFv3 has the following configuration guidelines and limitations:

- The **graceful-restart planned-only** command under OSPFv2 on reload converts to the **graceful-restart** command.

This is not causing any impact on the functionality. If the **graceful-restart planned-only** is not in the configuration, this problem is not applicable for that device.

This occurs when the Cisco NX-OS release is 9.3(2) and CSCvs57583 is not included in the release. A workaround is to unconfigure the **graceful-restart** command and reconfigure the old command.

- Names in the prefix-list are case-insensitive. We recommend using unique names. Do not use the same name by modifying uppercase and lowercase characters. For example, CTCPrimaryNetworks and CtcPrimaryNetworks are not two different entries.
- If you enter the **no graceful-restart planned only** command, graceful restart is disabled.
- Cisco NX-OS displays areas in dotted decimal notation regardless of whether you enter the area in decimal or dotted decimal notation.
- If you configure OSPFv3 in a virtual port channel (vPC) environment, use the following timer commands in router configuration mode on the core switch to ensure fast OSPF convergence when a vPC peer link is shut down:

```
switch(config-router)# timers throttle spf 1 50 50
switch(config-router)# timers lsa-arrival 10
```
- In scaled scenarios, when the number of interfaces and link-state advertisements in an OSPF process is large, the snmp-walk on OSPF MIB objects is expected to time out with a small-values timeout at the SNMP agent. If you observe a timeout on the querying SNMP agent while polling OSPF MIB objects, increase the timeout value on the polling SNMP agent.

- The following guidelines and limitations apply to the administrative distance feature:
 - When an OSPF route has two or more equal cost paths, configuring the administrative distance is non-deterministic for the **match ip route-source** command.
 - For matching route sources in OSPFv3 routes, you must configure **match ip route-source** instead of **match ipv6 route-source** because the route sources and router IDs for OSPFv3 are IPv4 addresses.
 - Configuring the administrative distance is supported only for the **match route-type**, **match ipv6 address prefix-list**, and **match ip route-source prefix-list** commands. The other match statements are ignored.
 - The discard route is always assigned an administrative distance of 220. No configuration in the table map applies to OSPF discard routes.
 - There is no preference among the **match route-type**, **match ipv6 address**, and **match ip route-source** commands for setting the administrative distance of OSPF routes. In this way, the behavior of the table map for setting the administrative distance in Cisco NX-OS OSPF is different from the behavior in Cisco IOS OSPF.
- If you configure the **delay restore seconds** command in vPC configuration mode and if the VLANs on the multichassis EtherChannel trunk (MCT) are announced by OSPFv2 or OSPFv3 using switch virtual interfaces (SVIs), those SVIs are announced with MAX_LINK_COST on the vPC secondary node during the configured time. As a result, all route or host programming completes after the vPC synchronization operation (on a peer reload of the secondary vPC node) before attracting traffic. This behavior allows for minimal packet loss for any north-to-south traffic.
- If you configure the same *area-id* for the primary area and any multiarea, the configuration is accepted without displaying an error. When you configure the primary area and any multiareas, do not use the same *area-id*.



Note If you are familiar with the Cisco IOS CLI, be aware that the Cisco NX-OS commands for this feature might differ from the Cisco IOS commands that you would use.

- If you use the **network ip address mask** command under OSPF, an error message will be displayed, and you will be prompted to enable OSPF under an interface with **area area id** command.
- It is recommended that you use the OSPF default timers (hello-interval:10 and dead-interval:40). For better convergence time, you can use the BFD along with OSPF. This combination will give sub-second link/adjacency flaps detection and very low convergence time.
- While OSPF support are aggressive timers, these are not commended as aggressive timers will bring the adjacency down quickly as well as cause CPU churn. We recommend you to use the default timers and use BFD (Bidirectional Forwarding Detection) to get sub-second failure detection.
- Beginning with Cisco NX-OS Release 10.3(1)F, OSPFv3 is supported on the Cisco Nexus 9808 switches.
- Beginning with Cisco NX-OS Release 10.4(1)F, OSPFv3 is supported on the Cisco Nexus 9804 switches.
- Beginning with Cisco NX-OS Release 10.4(1)F, the keychain support is provided for OSPFv3 encryption and authentication commands on the Cisco NX-OS switches.

- Beginning with Cisco NX-OS Release 10.4(1)F, OSPFv3 is supported on Cisco Nexus X98900CD-A and X9836DM-A line cards with 9808 and 9804 switches.

Default Settings

The table lists the default settings for OSPFv3 parameters.

Table 19: Default OSPFv3 Parameters

Parameters	Default
Administrative distance	110
Hello interval	10 seconds
Dead interval	40 seconds
Discard routes	Enabled
Graceful restart grace period	60 seconds
Graceful restart notify period	15 seconds
OSPFv3 feature	Disabled
Stub router advertisement announce time	600 seconds
Reference bandwidth for link cost calculation	40 Gb/s
LSA minimal arrival time	1000 milliseconds
LSA group pacing	10 seconds
SPF calculation initial delay time	200 milliseconds
SPF calculation minimum hold time	1000 milliseconds
SPF calculation maximum wait time	5000 milliseconds

Configuring Basic OSPFv3

Configure OSPFv3 after you have designed your OSPFv3 network.

Enabling OSPFv3

SUMMARY STEPS

1. `configure terminal`
2. `[no] feature ospfv3`

3. (Optional) **show feature**
4. (Optional) **copy running-config startup-config**

DETAILED STEPS

	Command or Action	Purpose
Step 1	configure terminal Example: <pre>switch# configure terminal switch(config)#</pre>	Enters global configuration mode.
Step 2	[no] feature ospfv3 Example: <pre>switch(config)# feature ospfv3</pre>	Enables OSPFv3. Using the no keyword with this command disables the OSPFv3 feature and removes all associated configuration.
Step 3	(Option) show feature Example: <pre>switch(config)# show feature</pre>	Displays enabled and disabled features.
Step 4	(Option) copy running-config startup-config Example: <pre>switch(config)# copy running-config startup-config</pre>	Saves this configuration change.

Creating an OSPFv3 Instance

The first step in configuring OSPFv3 is to create an instance or OSPFv3 instance. You assign a unique instance tag for this OSPFv3 instance. The instance tag can be any string. For each OSPFv3 instance, you can also configure the following optional parameters:

- Router ID—Configures the router ID for this OSPFv3 instance. If you do not use this parameter, the router ID selection algorithm is used. , see the [Router IDs](#) section.
- Administrative distance—Rates the trustworthiness of a routing information source. For more information, see the [Administrative Distance](#) section.
- Log adjacency changes—Creates a system message whenever an OSPFv3 neighbor changes its state.
- Name lookup—Translates OSPF router IDs to hostnames, either by looking up the local hosts database or querying DNS names in IPv6.
- Maximum paths—Sets the maximum number of equal paths that OSPFv3 installs in the route table for a particular destination. Use this parameter for load balancing between multiple paths.
- Reference bandwidth—Controls the calculated OSPFv3 cost metric for a network. The calculated cost is the reference bandwidth divided by the interface bandwidth. You can override the calculated cost by assigning a link cost when a network is added to the OSPFv3 instance. For more information, see the [Configuring Networks in OSPFv3](#) section.

For more information about OSPFv3 instance parameters, see the [Configuring Networks in OSPFv3](#) section.

Before you begin

You must enable OSPFv3 (see the [Enabling OSPFv3](#) section).

Ensure that the OSPFv3 instance tag that you plan on using is not already in use on this router.

Use the **show ospfv3 instance-tag** command to verify that the instance tag is not in use.

OSPFv3 must be able to obtain a router identifier (for example, a configured loopback address) or you must configure the router ID option.

SUMMARY STEPS

1. **configure terminal**
2. **[no] router ospfv3 instance-tag**
3. (Optional) **router-id ip-address**
4. (Optional) **show ipv6 ospfv3 instance-tag**
5. (Optional) **log-adjacency-changes [detail]**
6. (Optional) **passive-interface default**
7. (Optional) **distance number**
8. (Optional) **maximum-paths paths**
9. (Optional) **copy running-config startup-config**

DETAILED STEPS

	Command or Action	Purpose
Step 1	configure terminal Example: <pre>switch# configure terminal switch(config)#</pre>	Enters global configuration mode.
Step 2	[no] router ospfv3 instance-tag Example: <pre>switch(config)# router ospfv3 201 switch(config-router)#</pre>	Creates a new OSPFv3 instance with the configured instance tag. Note The no router ospfv3 instance tag command does not remove OSPF configuration in interface mode. You must manually remove any OSPFv3 commands configured in interface mode.
Step 3	(Optional) router-id ip-address Example: <pre>switch(config-router)# router-id 192.0.2.1</pre>	Configures the OSPFv3 router ID. This ID uses the dotted decimal notation and identifies this OSPFv3 instance and must exist on a configured interface in the system.
Step 4	(Optional) show ipv6 ospfv3 instance-tag Example: <pre>switch(config-router)# show ipv6 ospfv3 201</pre>	Displays OSPFv3 information.

	Command or Action	Purpose
Step 5	(Optional) log-adjacency-changes [detail] Example: switch(config-router)# log-adjacency-changes	Generates a system message whenever a neighbor changes state.
Step 6	(Optional) passive-interface default Example: switch(config-router)# passive-interface default	Suppresses routing updates on all interfaces. This command is overridden by the VRF or interface command mode configuration.
Step 7	(Optional) distance <i>number</i> Example: switch(config-router-af)# distance 25	Configures the administrative distance for this OSPFv3 instance. The range is from 1 to 255. The default is 110.
Step 8	(Optional) maximum-paths <i>paths</i> Example: switch(config-router-af)# maximum-paths 4	Configures the maximum number of equal OSPFv3 paths to a destination in the route table. The range is from 1 to 16. The default is 8. This command is used for load balancing.
Step 9	(Optional) copy running-config startup-config Example: switch(config)# copy running-config startup-config	Copies the running configuration to the startup configuration.

Example

This example shows how to create an OSPFv3 instance:

```
switch# configure terminal
switch(config)# router ospfv3 201
switch(config-router)# copy running-config startup-config
```

Configuring Networks in OSPFv3

You can configure a network to OSPFv3 by associating it through the interface that the router uses to connect to that network (see the [Neighbors](#) section). You can add all networks to the default backbone area (Area 0), or you can create new areas using any decimal number or an IP address.



Note All areas must connect to the backbone area either directly or through a virtual link.



Note OSPFv3 is not enabled on an interface until you configure a valid IPv6 address for that interface.

Before you begin

You must enable OSPFv3 (see the [Enabling OSPFv3](#) section).

SUMMARY STEPS

1. **configure terminal**
2. **interface** *interface-type slot/port*
3. **ipv6 address** *ipv6-prefix/length*
4. **ipv6 router ospfv3** *instance-tag area area-id* [secondaries none]
5. (Optional) **show ipv6 ospfv3** *instance-tag interface interface-type slot/port*
6. (Optional) **ospfv3 cost** *number*
7. (Optional) **ospfv3 dead-interval** *seconds*
8. (Optional) **ospfv3 hello-interval** *seconds*
9. (Optional) **ospfv3 instance** *instance*
10. (Optional) **ospfv3 mtu-ignore**
11. (Optional) **ospfv3 network** {broadcast | point-point}
12. (Optional) [default | no] **ospfv3 passive-interface**
13. (Optional) **ospfv3 priority** *number*
14. (Optional) **ospfv3 shutdown**
15. (Optional) **copy running-config startup-config**

DETAILED STEPS

	Command or Action	Purpose
Step 1	configure terminal Example: switch# configure terminal switch(config)#	Enters global configuration mode.
Step 2	interface <i>interface-type slot/port</i> Example: switch(config)# interface ethernet 1/2 switch(config-if)#	Enters interface configuration mode.
Step 3	ipv6 address <i>ipv6-prefix/length</i> Example: switch(config-if)# ipv6 address 2001:0DB8::1/48	Assigns an IPv6 address to this interface.
Step 4	ipv6 router ospfv3 <i>instance-tag area area-id</i> [secondaries none] Example: switch(config-if)# ipv6 router ospfv3 201 area 0	Adds the interface to the OSPFv3 instance and area.
Step 5	(Optional) show ipv6 ospfv3 <i>instance-tag interface interface-type slot/port</i>	Displays OSPFv3 information.

	Command or Action	Purpose
	Example: <pre>switch(config-if)# show ipv6 ospfv3 201 interface ethernet 1/2</pre>	
Step 6	(Optional) ospfv3 cost number Example: <pre>switch(config-if)# ospfv3 cost 25</pre>	Configures the OSPFv3 cost metric for this interface. The default is to calculate a cost metric, based on the reference bandwidth and interface bandwidth. The range is from 1 to 65535.
Step 7	(Optional) ospfv3 dead-interval seconds Example: <pre>switch(config-if)# ospfv3 dead-interval 50</pre>	Configures the OSPFv3 dead interval, in seconds. The range is from 1 to 65535. The default is four times the hello interval, in seconds.
Step 8	(Optional) ospfv3 hello-interval seconds Example: <pre>switch(config-if)# ospfv3 hello-interval 25</pre>	Configures the OSPFv3 hello interval, in seconds. The range is from 1 to 65535. The default is 10 seconds.
Step 9	(Optional) ospfv3 instance instance Example: <pre>switch(config-if)# ospfv3 instance 25</pre>	Configures the OSPFv3 instance ID. The range is from 0 to 255. The default is 0. The instance ID is link-local in scope.
Step 10	(Optional) ospfv3 mtu-ignore Example: <pre>switch(config-if)# ospfv3 mtu-ignore</pre>	Configures OSPFv3 to ignore any IP maximum transmission unit (MTU) mismatch with a neighbor. The default is to not establish adjacency if the neighbor MTU does not match the local interface MTU.
Step 11	(Optional) ospfv3 network {broadcast point-point} Example: <pre>switch(config-if)# ospfv3 network broadcast</pre>	Sets the OSPFv3 network type.
Step 12	(Optional) [default no] ospfv3 passive-interface Example: <pre>switch(config-if)# ospfv3 passive-interface</pre>	Suppresses routing updates on the interface. This command overrides the router or VRF command mode configuration. The default option removes this interface mode command and reverts to the router or VRF configuration, if present.
Step 13	(Optional) ospfv3 priority number Example: <pre>switch(config-if)# ospfv3 priority 25</pre>	Configures the OSPFv3 priority, used to determine the DR for an area. The range is from 0 to 255. The default is 1. See the Designated Routers section.
Step 14	(Optional) ospfv3 shutdown Example: <pre>switch(config-if)# ospfv3 shutdown</pre>	Shuts down the OSPFv3 instance on this interface.
Step 15	(Optional) copy running-config startup-config Example:	Copies the running configuration to the startup configuration.

	Command or Action	Purpose
	switch(config)# copy running-config startup-config	

Example

This example shows how to add a network area 0.0.0.10 in OSPFv3 instance 201:

```
switch# configure terminal
switch(config)# interface ethernet 1/2
switch(config-if)# ipv6 address 2001:0DB8::1/48
switch(config-if)# ipv6 router ospfv3 201 area 0.0.0.10
switch(config-if)# copy running-config startup-config
```

Configuring Advanced OSPFv3

Configure OSPFv3 after you have designed your OSPFv3 network.

Configuring Filter Lists for Border Routers

You can separate your OSPFv3 domain into a series of areas that contain related networks. All areas must connect to the backbone area through an area border router (ABR). OSPFv3 domains can connect to external domains as well through an autonomous system border router (ASBR). See the [Areas](#) section.

ABRs have the following optional configuration parameters:

- **Area range**—Configures route summarization between areas. For more information, see the [Configuring Route Summarization](#) section.
- **Filter list**—Filters the Inter-Area Prefix (type 3) LSAs on an ABR that are allowed in from an external area.

ASBRs also support filter lists.

Before you begin

Create the route map that the filter list uses to filter IP prefixes in incoming or outgoing Inter-Area Prefix (type 3) LSAs. See [Configuring Route Policy Manager, on page 515](#).

SUMMARY STEPS

1. **configure terminal**
2. **router ospfv3 *instance-tag***
3. **address-family ipv6 unicast**
4. **area *area-id* filter-list route-map *map-name* {in | out}**
5. (Optional) **show ipv6 ospfv3 policy statistics area *id* filter-list {in | out}**
6. (Optional) **copy running-config startup-config**

DETAILED STEPS

	Command or Action	Purpose
Step 1	configure terminal Example: switch# configure terminal switch(config)#	Enters global configuration mode.
Step 2	router ospfv3 instance-tag Example: switch(config)# router ospfv3 201 switch(config-router)#	Creates a new OSPFv3 instance with the configured instance tag
Step 3	address-family ipv6 unicast Example: switch(config-router)# address-family ipv6 unicast switch(config-router-af)#	Enters IPv6 unicast address family mode.
Step 4	area area-id filter-list route-map map-name {in out} Example: switch(config-router-af)# area 0.0.0.10 filter-list route-map FilterLSAs in	Filters incoming or outgoing Inter-Area Prefix (type 3) LSAs on an ABR.
Step 5	(Optional) show ipv6 ospfv3 policy statistics area id filter-list {in out} Example: switch(config-router-af)# show ipv6 ospfv3 policy statistics area 0.0.0.10 filter-list in	Displays OSPFv3 policy information.
Step 6	(Optional) copy running-config startup-config Example: switch(config)# copy running-config startup-config	Copies the running configuration to the startup configuration.

Example

This example shows how to configure a filter list for a route map:

```
switch# configure terminal
switch(config)# router ospfv3 201
switch(config-router)# address-family ipv6 unicast
switch(config-router-af)# area 0.0.0.10 filter-list route-map FilterLSAs in
switch(config-router-af)# copy running-config startup-config
```

Configuring Stub Areas

You can configure a stub area for part of an OSPFv3 domain where external traffic is not necessary. Stub areas block AS External (type 5) LSAs, limiting unnecessary routing to and from selected networks. See the [Stub Area](#) section. You can optionally block all summary routes from going into the stub area.

Before you begin

You must enable OSPF (see the [Enabling OSPFv3](#) section).

Ensure that there are no virtual links or ASBRs in the proposed stub area.

SUMMARY STEPS

1. **configure terminal**
2. **router ospfv3 *instance-tag***
3. **area *area-id* stub**
4. (Optional) **address-family ipv6 unicast**
5. (Optional) **area *area-id* default cost *cost***
6. (Optional) **copy running-config startup-config**

DETAILED STEPS

	Command or Action	Purpose
Step 1	configure terminal Example: <pre>switch# configure terminal switch(config)#</pre>	Enters global configuration mode.
Step 2	router ospfv3 <i>instance-tag</i> Example: <pre>switch(config)# router ospfv3 201 switch(config-router)#</pre>	Creates a new OSPFv3 instance with the configured instance tag.
Step 3	area <i>area-id</i> stub Example: <pre>switch(config-router)# area 0.0.0.10 stub</pre>	Creates this area as a stub area.
Step 4	(Optional) address-family ipv6 unicast Example: <pre>switch(config-router)# address-family ipv6 unicast switch(config-router-af)#</pre>	Enters IPv6 unicast address family mode.
Step 5	(Optional) area <i>area-id</i> default cost <i>cost</i> Example: <pre>switch(config-router-af)# area 0.0.0.10 default-cost 25</pre>	Sets the cost metric for the default summary route sent into this stub area. The range is from 0 to 16777215.

	Command or Action	Purpose
Step 6	(Optional) copy running-config startup-config Example: switch(config)# copy running-config startup-config	Copies the running configuration to the startup configuration.

Example

This shows how to create a stub area that blocks all summary route updates:

```
switch# configure terminal
switch(config)# router ospfv3 201
switch(config-router)# area 0.0.0.10 stub no-summary
switch(config-router)# copy running-config startup-config
```

Configuring a Totally Stubby Area

You can create a totally stubby area and prevent all summary route updates from going into the stub area.

To create a totally stubby area, use the following command in router configuration mode:

SUMMARY STEPS

1. **area *area-id* stub no-summary**

DETAILED STEPS

	Command or Action	Purpose
Step 1	area <i>area-id</i> stub no-summary Example: switch(config-router)# area 20 stub no-summary	Creates this area as a totally stubby area.

Configuring NSSA

You can configure an NSSA for part of an OSPFv3 domain where limited external traffic is required. You can optionally translate this external traffic to an AS External (type 5) LSA and flood the OSPFv3 domain with this routing information. An NSSA can be configured with the following optional parameters:

- No redistribution—Redistributes routes that bypass the NSSA to other areas in the OSPFv3 autonomous system. Use this option when the NSSA ASBR is also an ABR.
- Default information originate—Generates a Type-7 LSA for a default route to the external autonomous system. Use this option on an NSSA ASBR if the ASBR contains the default route in the routing table. This option can be used on an NSSA ABR whether or not the ABR contains the default route in the routing table.
- Route map—Filters the external routes so that only those routes you want are flooded throughout the NSSA and other areas.

- No summary—Blocks all summary routes from flooding the NSSA. Use this option on the NSSA ABR.
- Translate—Translates Type-7 LSAs to AS External (type 5) LSAs for areas outside the NSSA. Use this command on an NSSA ABR to flood the redistributed routes throughout the OSPFv3 autonomous system. You can optionally suppress the forwarding address in these AS External LSAs.



Note The translate option requires a separate **area area-id nssa** command, preceded by the **area area-id nssa** command that creates the NSSA and configures the other options.

Before you begin

You must enable OSPF (see the [Enabling OSPFv3](#) section).

Ensure that there are no virtual links in the proposed NSSA and that it is not the backbone area.

SUMMARY STEPS

1. **configure terminal**
2. **router ospfv3 instance-tag**
3. **area area-id nssa [no-redistribution] [default-information-originate] [route-map map-name] [no-summary]**
4. (Optional) **area area-id nssa translate type7 {always | never} [suppress-fa]**
5. (Optional) **address-family ipv6 unicast**
6. (Optional) **area area-id default cost cost**
7. (Optional) **copy running-config startup-config**

DETAILED STEPS

	Command or Action	Purpose
Step 1	configure terminal Example: <pre>switch# configure terminal switch(config)#</pre>	Enters global configuration mode.
Step 2	router ospfv3 instance-tag Example: <pre>switch(config)# router ospfv3 201 switch(config-router)#</pre>	Creates a new OSPFv3 instance with the configured instance tag.
Step 3	area area-id nssa [no-redistribution] [default-information-originate] [route-map map-name] [no-summary] Example: <pre>switch(config-router)# area 0.0.0.10 nssa</pre>	Creates this area as an NSSA.

	Command or Action	Purpose
Step 4	(Optional) area <i>area-id</i> nssa translate type7 { always never } [suppress-fa] Example: switch(config-router)# area 0.0.0.10 nssa translate type7 always	Configures the NSSA to translate AS External (type 7) LSAs to NSSA External (type 5) LSAs.
Step 5	(Optional) address-family ipv6 unicast Example: switch(config-router)# address-family ipv6 unicast switch(config-router-af)#	Enters IPv6 unicast address family mode.
Step 6	(Optional) area <i>area-id</i> default cost <i>cost</i> Example: switch(config-router-af)# area 0.0.0.10 default-cost 25	Sets the cost metric for the default summary route sent into this NSSA. The range is from 0 to 16777215.
Step 7	(Optional) copy running-config startup-config Example: switch(config)# copy running-config startup-config	Copies the running configuration to the startup configuration.

Example

This example shows how to create an NSSA that blocks all summary route updates:

```
switch# configure terminal
switch(config)# router ospfv3 201
switch(config-router)# area 0.0.0.10 nssa no-summary
switch(config-router)# copy running-config startup-config
```

This example shows how to create an NSSA that generates a default route:

```
switch# configure terminal
switch(config)# router ospfv3 201
switch(config-router)# area 0.0.0.10 nssa default-info-originate
switch(config-router)# copy running-config startup-config
```

This example shows how to create an NSSA that filters external routes and blocks all summary route updates:

```
switch# configure terminal
switch(config)# router ospfv3 201
switch(config-router)# area 0.0.0.10 nssa route-map ExternalFilter no-summary
switch(config-router)# copy running-config startup-config
```

This example shows how to create an NSSA and then configure the NSSA to always translate AS External (type 7) LSAs to NSSA External (type 5) LSAs:

```
switch# configure terminal
switch(config)# router ospfv3 201
switch(config-router)# area 0.0.0.10 nssa
switch(config-router)# area 0.0.0.10 nssa translate type 7 always
switch(config-router)# copy running-config startup-config
```

This example shows how to create an NSSA that blocks all summary route updates:

```
switch# configure terminal
switch(config)# router ospfv3 201
switch(config-router)# area 0.0.0.10 nssa no-summary
switch(config-router)# copy running-config startup-config
```

Configuring Multi-Area Adjacency

You can add more than one area to an existing OSPFv3 interface. The additional logical interfaces support multi-area adjacency.

Before you begin

You must enable OSPF (see the [Enabling OSPFv3](#) section).

Ensure that you have configured a primary area for the interface (see the [Configuring Networks in OSPFv3](#) section).

SUMMARY STEPS

1. **configure terminal**
2. **interface** *interface-type slot/port*
3. **ipv6 router ospfv3 instance-tag multi-area area-id**
4. (Optional) **show ipv6 ospfv3 instance-tag interface** *interface-type slot/port*
5. (Optional) **copy running-config startup-config**

DETAILED STEPS

	Command or Action	Purpose
Step 1	configure terminal Example: switch# configure terminal switch(config)#	Enters global configuration mode.
Step 2	interface <i>interface-type slot/port</i> Example: switch(config)# interface ethernet 1/2 switch(config-if)#	Enters interface configuration mode.
Step 3	ipv6 router ospfv3 instance-tag multi-area area-id Example: switch(config-if)# ipv6 router ospfv3 201 multi-area 3	Adds the interface to another area.
Step 4	(Optional) show ipv6 ospfv3 instance-tag interface <i>interface-type slot/port</i> Example: switch(config-if)# show ipv6 ospfv3 201 interface ethernet 1/2	Displays OSPFv3 information.

	Command or Action	Purpose
Step 5	(Optional) copy running-config startup-config Example: switch(config)# copy running-config startup-config	Copies the running configuration to the startup configuration.

Example

This example shows how to add a second area to an OSPFv3 interface:

```
switch# configure terminal
switch(config)# interface ethernet 1/2
switch(config-if)# ipv6 address 2001:0DB8::1/48
switch(config-if)# ipv6 ospfv3 201 area 0.0.0.10
switch(config-if)# ipv6 ospfv3 201 multi-area 20
switch(config-if)# copy running-config startup-config
```

Configuring Virtual Links

A virtual link connects an isolated area to the backbone area through an intermediate area. See the [Virtual Links](#) section. You can configure the following optional parameters for a virtual link:

- Dead interval—Sets the time that a neighbor waits for a Hello packet before declaring the local router as dead and tearing down adjacencies.
- Hello interval—Sets the time between successive Hello packets.
- Retransmit interval—Sets the estimated time between successive LSAs.
- Transmit delay—Sets the estimated time to transmit an LSA to a neighbor.



Note You must configure the virtual link on both routers involved before the link becomes active.

Before you begin

You must enable OSPF (see the [Enabling OSPFv3](#) section).

SUMMARY STEPS

1. **configure terminal**
2. **router ospfv3** *instance-tag*
3. **area** *area-id* **virtual-link** *router-id*
4. (Optional) **show ipv6 ospfv3 virtual-link** [brief]
5. (Optional) **dead-interval** *seconds*
6. (Optional) **hello-interval** *seconds*
7. (Optional) **retransmit-interval** *seconds*
8. (Optional) **transmit-delay** *seconds*

9. (Optional) **copy running-config startup-config**

DETAILED STEPS

	Command or Action	Purpose
Step 1	configure terminal Example: switch# configure terminal switch(config)#	Enters global configuration mode.
Step 2	router ospfv3 instance-tag Example: switch(config)# router ospfv3 201 switch(config-router)#	Creates a new OSPFv3 instance with the configured instance tag.
Step 3	area area-id virtual-link router-id Example: switch(config-router)# area 0.0.0.10 virtual-link 2001:0DB8::1 switch(config-router-vlink)#	Creates one end of a virtual link to a remote router. You must create the virtual link on that remote router to complete the link.
Step 4	(Optional) show ipv6 ospfv3 virtual-link [brief] Example: switch(config-router-vlink)# show ipv6 ospfv3 virtual-link	Displays OSPFv3 virtual link information.
Step 5	(Optional) dead-interval seconds Example: switch(config-router-vlink)# dead-interval 50	Configures the OSPFv3 dead interval, in seconds. The range is from 1 to 65535. The default is four times the hello interval, in seconds.
Step 6	(Optional) hello-interval seconds Example: switch(config-router-vlink)# hello-interval 25	Configures the OSPFv3 hello interval, in seconds. The range is from 1 to 65535. The default is 10 seconds.
Step 7	(Optional) retransmit-interval seconds Example: switch(config-router-vlink)# retransmit-interval 50	Configures the OSPFv3 retransmit interval, in seconds. The range is from 1 to 65535. The default is 5.
Step 8	(Optional) transmit-delay seconds Example: switch(config-router-vlink)# transmit-delay 2	Configures the OSPFv3 transmit-delay, in seconds. The range is from 1 to 450. The default is 1.
Step 9	(Optional) copy running-config startup-config Example:	Copies the running configuration to the startup configuration.

Command or Action	Purpose
switch(config)# copy running-config startup-config	

Example

These examples show how to create a simple virtual link between two ABRs:

Configuration for ABR 1 (router ID 2001:0DB8::1) is as follows:

```
switch# configure terminal
switch(config)# router ospfv3 201
switch(config-router)# area 0.0.0.10 virtual-link 2001:0DB8::10
switch(config-router-vlink)# copy running-config startup-config
```

Configuration for ABR 2 (router ID 2001:0DB8::10) is as follows:

```
switch# configure terminal
switch(config)# router ospfv3 201
switch(config-router)# area 0.0.0.10 virtual-link 2001:0DB8::1
switch(config-router-vlink)# copy running-config startup-config
```

Configuring Redistribution

You can redistribute routes learned from other routing protocols into an OSPFv3 autonomous system through the ASBR.

You can configure the following optional parameters for route redistribution in OSPF:

- **Default information originate**—Generates an AS External (type 5) LSA for a default route to the external autonomous system.



Note Default information originate ignores **match** statements in the optional route map.

- **Default metric**—Sets all redistributed routes to the same cost metric.



Note If you redistribute static routes, Cisco NX-OS requires the **default-information originate** command to successfully redistribute the default static route starting in 7.0(3)I7(6).

Before you begin

You must enable OSPF (see the [Enabling OSPFv3](#) section).

Create the necessary route maps used for redistribution.

SUMMARY STEPS

1. **configure terminal**
2. **router ospfv3** *instance-tag*
3. **address-family ipv6 unicast**
4. **redistribute** {*bgpid* | *direct* | *isis id* | *rip id* | *static* | *dhcpv6*} **route-map** *map-name*
5. **default-information originate** [*always*] [*route-map map-name*]
6. **default-metric** *cost*
7. (Optional) **copy running-config startup-config**

DETAILED STEPS

	Command or Action	Purpose
Step 1	configure terminal Example: <pre>switch# configure terminal switch(config)#</pre>	Enters global configuration mode.
Step 2	router ospfv3 <i>instance-tag</i> Example: <pre>switch(config)# router ospfv3 201 switch(config-router)#</pre>	Creates a new OSPFv3 instance with the configured instance tag.
Step 3	address-family ipv6 unicast Example: <pre>switch(config-router)# address-family ipv6 unicast switch(config-router-af)#</pre>	Enters IPv6 unicast address family mode.
Step 4	redistribute { <i>bgpid</i> <i>direct</i> <i>isis id</i> <i>rip id</i> <i>static</i> <i>dhcpv6</i> } route-map <i>map-name</i> Example: <pre>switch(config-router-af)# redistribute bgp route-map FilterExternalBGP</pre>	Redistributes the selected protocol into OSPFv3 through the configured route map. Note If you redistribute static routes, Cisco NX-OS requires the default-information originate command to successfully redistribute the default static route starting in 7.0(3)I7(6).
Step 5	default-information originate [<i>always</i>] [<i>route-map map-name</i>] Example: <pre>switch(config-router-af)# default-information-originate route-map DefaultRouteFilter</pre>	Creates a default route into this OSPFv3 domain if the default route exists in the RIB. Use the following optional keywords: <ul style="list-style-type: none"> • always—Always generates the default route of 0.0.0.0 even if the route does not exist in the RIB. • route-map—Generates the default route if the route map returns true. Note This command ignores match statements in the route map.

	Command or Action	Purpose
Step 6	default-metric <i>cost</i> Example: <pre>switch(config-router-af) # default-metric 25</pre>	Sets the cost metric for the redistributed routes. The range is from 1 to 16777214. This command does not apply to directly connected routes. Use a route map to set the default metric for directly connected routes.
Step 7	(Optional) copy running-config startup-config Example: <pre>switch(config-router-af) # copy running-config startup-config</pre>	Saves this configuration change.

Example

This example shows how to redistribute the Border Gateway Protocol (BGP) into OSPFv3:

```
switch# configure terminal
switch(config)# router ospfv3 201
switch(config-router)# address-family ipv6 unicast
switch(config-router-af)# redistribute bgp route-map FilterExternalBGP
switch(config-router-af)# copy running-config startup-config
```

Limiting the Number of Redistributed Routes

Route redistribution can add many routes to the OSPFv3 route table. You can configure a maximum limit to the number of routes accepted from external protocols. OSPFv3 provides the following options to configure redistributed route limits:

- **Fixed limit**—Logs a message when OSPFv3 reaches the configured maximum. OSPFv3 does not accept any more redistributed routes. You can optionally configure a threshold percentage of the maximum where OSPFv3 logs a warning when that threshold is passed.
- **Warning only**—Logs a warning only when OSPFv3 reaches the maximum. OSPFv3 continues to accept redistributed routes.
- **Withdraw**—Starts the configured timeout period when OSPFv3 reaches the maximum. After the timeout period, OSPFv3 requests all redistributed routes if the current number of redistributed routes is less than the maximum limit. If the current number of redistributed routes is at the maximum limit, OSPFv3 withdraws all redistributed routes. You must clear this condition before OSPFv3 accepts more redistributed routes. You can optionally configure the timeout period.

Before you begin

You must enable OSPF (see the [Enabling OSPFv3](#) section).

SUMMARY STEPS

1. **configure terminal**
2. **router ospfv3** *instance-tag*
3. **address-family ipv6 unicast**
4. **redistribute** {*bgpid* | *direct* | *isis id* | *rip id* | *static*} **route-map** *map-name*

5. **redistribute maximum-prefix***max* [*threshold*] [**warning-only** | **withdraw** [*num-retries* *timemout*]]
6. (Optional) **show running-config ospfv3**
7. (Optional) **copy running-config startup-config**

DETAILED STEPS

	Command or Action	Purpose
Step 1	configure terminal Example: <pre>switch# configure terminal switch(config)#</pre>	Enters global configuration mode.
Step 2	router ospfv3 instance-tag Example: <pre>switch(config)# router ospfv3 201 switch(config-router)#</pre>	Creates a new OSPFv3 instance with the configured instance tag.
Step 3	address-family ipv6 unicast Example: <pre>switch(config-router)# address-family ipv6 unicast switch(config-router-af)#</pre>	Enters IPv6 unicast address family mode.
Step 4	redistribute {bgpid direct isis id rip id static} route-map map-name Example: <pre>switch(config-router-af)# redistribute bgp route-map FilterExternalBGP</pre>	Redistributes the selected protocol into OSPFv3 through the configured route map.
Step 5	redistribute maximum-prefix <i>max</i> [<i>threshold</i>] [warning-only withdraw [<i>num-retries</i> <i>timemout</i>]] Example: <pre>switch(config-router-af)# redistribute maximum-prefix 1000 75 warning-only</pre>	<p>Specifies a maximum number of prefixes that OSPFv2 distributes. The range is from 0 to 65536. Optionally, specifies the following:</p> <ul style="list-style-type: none"> • threshold—Percent of maximum prefixes that triggers a warning message. • warning-only—Logs a warning message when the maximum number of prefixes is exceeded. • withdraw—Withdraws all redistributed routes and optionally tries to retrieve the redistributed routes. The <i>num-retries</i> range is from 1 to 12. The <i>timeout</i> range is from 60 to 600 seconds. The default is 300 seconds.
Step 6	(Optional) show running-config ospfv3 Example: <pre>switch(config-router-af)# show running-config ospf</pre>	Displays the OSPFv3 configuration.

	Command or Action	Purpose
Step 7	(Optional) copy running-config startup-config Example: switch(config)# copy running-config startup-config	Copies the running configuration to the startup configuration.

Example

This example shows how to limit the number of redistributed routes into OSPF:

```
switch# configure terminal
switch(config)# router ospfv3 201
switch(config-router)# address-family ipv6 unicast
switch(config-router-af)# redistribute bgp route-map FilterExternalBGP
switch(config-router-af)# redistribute maximum-prefix 1000 75
```

Configuring Route Summarization

You can configure route summarization for inter-area networks by configuring an address range that is summarized. You can also configure route summarization for external, redistributed routes by configuring a summary address for those routes on an ASBR. For more information, see the [Route Summarization](#) section.

Before you begin

You must enable OSPF (see the [Enabling OSPFv3](#) section).

SUMMARY STEPS

1. **configure terminal**
2. **router ospfv3** *instance-tag*
3. **address-family ipv6 unicast**
4. **area** *area-id range ipv6-prefix/length* [**no-advertise**] [**cost** *cost*]
5. **summary-address** *ipv6-prefix/length* [**no-advertise**] [**tag** *tag*]
6. (Optional) **show ipv6 ospfv3 summary-address**
7. (Optional) **copy running-config startup-config**

DETAILED STEPS

	Command or Action	Purpose
Step 1	configure terminal Example: switch# configure terminal switch(config)#	Enters global configuration mode.
Step 2	router ospfv3 <i>instance-tag</i> Example:	Creates a new OSPFv3 instance with the configured instance tag.

	Command or Action	Purpose
	<pre>switch(config)# router ospfv3 201 switch(config-router)#</pre>	
Step 3	<p>address-family ipv6 unicast</p> <p>Example:</p> <pre>switch(config-router)# address-family ipv6 unicast switch(config-router-af)#</pre>	Enters IPv6 unicast address family mode.
Step 4	<p>area area-id range ipv6-prefix/length [no-advertise] [cost cost]</p> <p>Example:</p> <pre>switch(config-router-af)# area 0.0.0.10 range 2001:0DB8::/48 advertise</pre>	Creates a summary address on an ABR for a range of addresses and optionally advertises this summary address in a Inter-Area Prefix (type 3) LSA. The cost range is from 0 to 16777215.
Step 5	<p>summary-address ipv6-prefix/length [no-advertise] [tag tag]</p> <p>Example:</p> <pre>switch(config-router-af)# summary-address 2001:0DB8::/48 tag 2</pre>	Creates a summary address on an ASBR for a range of addresses and optionally assigns a tag for this summary address that can be used for redistribution with route maps.
Step 6	<p>(Optional) show ipv6 ospfv3 summary-address</p> <p>Example:</p> <pre>switch(config-router-af)# show ipv6 ospfv3 summary-address</pre>	Displays information about OSPFv3 summary addresses.
Step 7	<p>(Optional) copy running-config startup-config</p> <p>Example:</p> <pre>switch(config)# copy running-config startup-config</pre>	Copies the running configuration to the startup configuration.

Example

This example shows how to create summary addresses between areas on an ABR:

```
switch# configure terminal
switch(config)# router ospfv3 201
switch(config-router)# address-family ipv6 unicast
switch(config-router-af)# area 0.0.0.10 range 2001:0DB8::/48
switch(config-router-af)# copy running-config startup-config
```

This example shows how to create summary addresses on an ASBR:

```
switch# configure terminal
switch(config)# router ospfv3 201
switch(config-router)# address-family ipv6 unicast
switch(config-router-af)# summary-address 2001:0DB8::/48
switch(config-router-af)# no discard route internal
switch(config-router-af)# copy running-config startup-config
```

Configuring the Administrative Distance of Routes

You can set the administrative distance of routes added by OSPFv3 into the RIB.

The administrative distance is a rating of the trustworthiness of a routing information source. A higher value indicates a lower trust rating. Typically, a route can be learned through more than one routing protocol. The administrative distance is used to discriminate between routes learned from more than one routing protocol. The route with the lowest administrative distance is installed in the IP routing table.

Before you begin

Ensure that you have enabled OSPF (see the [Configuring OSPFv3, on page 149](#) section).

See the guidelines and limitations for this feature in the [Guidelines and Limitations for OSPFv3, on page 161](#) section.

SUMMARY STEPS

1. **configure terminal**
2. **router ospfv3** *instance-tag*
3. **address-family ipv6 unicast**
4. **[no] table-map** *map-name*
5. **exit**
6. **exit**
7. **route-map** *map-name* [**permit** | **deny**] [*seq*]
8. **match route-type** *route-type*
9. **match ip route-source prefix-list** *name*
10. **match ipv6 address prefix-list** *name*
11. **set distance** *value*
12. (Optional) **copy running-config startup-config**

DETAILED STEPS

	Command or Action	Purpose
Step 1	configure terminal Example: <pre>switch# configure terminal switch(config)#</pre>	Enters global configuration mode.
Step 2	router ospfv3 <i>instance-tag</i> Example: <pre>switch(config)# router ospfv3 201 switch(config-router)#</pre>	Creates a new OSPFv3 instance with the configured instance tag.
Step 3	address-family ipv6 unicast Example: <pre>switch(config-router)# address-family ipv6 unicast switch(config-router-af)#</pre>	Enters IPv6 unicast address family mode.

	Command or Action	Purpose
Step 4	<p>[no] table-map <i>map-name</i></p> <p>Example:</p> <pre>switch(config-router-af)# table-map foo</pre>	Configures the policy for filtering or modifying OSPFv3 routes before sending them to the RIB. You can enter up to 63 alphanumeric characters for the map name.
Step 5	<p>exit</p> <p>Example:</p> <pre>switch(config-router-af)# exit switch(config-router)#</pre>	Exits router address-family configuration mode.
Step 6	<p>exit</p> <p>Example:</p> <pre>switch(config-router)# exit switch(config)#</pre>	Exits router configuration mode.
Step 7	<p>route-map <i>map-name</i> [permit deny] [<i>seq</i>]</p> <p>Example:</p> <pre>switch(config)# route-map foo permit 10 switch(config-route-map)#</pre>	<p>Creates a route map or enters route-map configuration mode for an existing route map. Use <i>seq</i> to order the entries in a route map.</p> <p>Note The permit option enables you to set the distance. If you use the deny option, the default distance is applied.</p>
Step 8	<p>match route-type <i>route-type</i></p> <p>Example:</p> <pre>switch(config-route-map)# match route-type external</pre>	<p>Matches against one of the following route types:</p> <ul style="list-style-type: none"> • external—The external route (BGP, EIGRP, and OSPF type 1 or 2) • inter-area—The OSPF inter-area route • internal—The internal route (including the OSPF intra- or inter-area) • intra-area—The OSPF intra-area route • nssa-external—The NSSA external route (OSPF type 1 or 2) • type-1—The OSPF external type 1 route • type-2—The OSPF external type 2 route
Step 9	<p>match ip route-source prefix-list <i>name</i></p> <p>Example:</p> <pre>switch(config-route-map)# match ip route-source prefix-list p1</pre>	<p>Matches the IPv6 route source address or router ID of a route to one or more IP prefix lists. Use the ip prefix-list command to create the prefix list.</p> <p>Note For OSPFv3, the router ID is 4 bytes.</p>
Step 10	<p>match ipv6 address prefix-list <i>name</i></p> <p>Example:</p> <pre>switch(config-route-map)# match ipv6 address prefix-list p1</pre>	Matches against one or more IPv6 prefix lists. Use the ip prefix-list command to create the prefix list.

	Command or Action	Purpose
Step 11	set distance <i>value</i> Example: <pre>switch(config-route-map)# set distance 150</pre>	Sets the administrative distance of routes for OSPFv3. The range is from 1 to 255.
Step 12	(Optional) copy running-config startup-config Example: <pre>switch(config-route-map)# copy running-config startup-config</pre>	Saves this configuration change.

Example

This example shows how to configure the OSPFv3 administrative distance for inter-area routes to 150, for external routes to 200, and for all prefixes in prefix list p1 to 190:

```
switch# configure terminal
switch(config)# router ospfv3 201
switch(config-router)# address-family ipv6 unicast
switch(config-router-af)# table-map foo
switch(config-router)# exit
switch(config)# exit
switch(config)# route-map foo permit 10
switch(config-route-map)# match route-type inter-area
switch(config-route-map)# set distance 150
switch(config)# route-map foo permit 20
switch(config-route-map)# match route-type external
switch(config-route-map)# set distance 200
switch(config)# route-map foo permit 30
switch(config-route-map)# match ip route-source prefix-list p1
switch(config-route-map)# match ipv6 address prefix-list p1
switch(config-route-map)# set distance 190
switch(config-route-map)# copy running-config startup-config
```

Modifying the Default Timers

OSPFv3 includes a number of timers that control the behavior of protocol messages and shortest path first (SPF) calculations. OSPFv3 includes the following optional timer parameters:

- LSA arrival time—Sets the minimum interval allowed between LSAs arriving from a neighbor. LSAs that arrive faster than this time are dropped.
- Pacing LSAs—Sets the interval at which LSAs are collected into a group and refreshed, checksummed, or aged. This timer controls how frequently LSA updates occur and optimizes how many are sent in an LSA update message (see the [Flooding and LSA Group Pacing](#) section).
- Throttle LSAs—Sets rate limits for generating LSAs. This timer controls how frequently LSAs are generated after a topology change occurs.
- Throttle SPF calculation—Controls how frequently the SPF calculation is run.

At the interface level, you can also control the following timers:

- Retransmit interval—Sets the estimated time between successive LSAs.
- Transmit delay—Sets the estimated time to transmit an LSA to a neighbor.

See the [Configuring Networks in OSPFv3](#) section for information on the hello interval and dead timer.

SUMMARY STEPS

1. **configure terminal**
2. **router ospfv3 *instance-tag***
3. **timers lsa-arrival *msec***
4. **timers lsa-group-pacing *seconds***
5. **timers throttle lsa *start-time hold-interval max-time***
6. **address-family ipv6 unicast**
7. **timers throttle spf *delay-time hold-time max-time***
8. **interface *type slot/port***
9. **ospfv3 retransmit-interval *seconds***
10. **ospfv3 transmit-delay *seconds***
11. (Optional) **copy running-config startup-config**

DETAILED STEPS

	Command or Action	Purpose
Step 1	configure terminal Example: <pre>switch# configure terminal switch(config)#</pre>	Enters global configuration mode.
Step 2	router ospfv3 <i>instance-tag</i> Example: <pre>switch(config)# router ospfv3 201 switch(config-router)#</pre>	Creates a new OSPFv3 instance with the configured instance tag.
Step 3	timers lsa-arrival <i>msec</i> Example: <pre>switch(config-router)# timers lsa-arrival 2000</pre>	Sets the LSA arrival time in milliseconds. The range is from 10 to 600000. The default is 1000 milliseconds.
Step 4	timers lsa-group-pacing <i>seconds</i> Example: <pre>switch(config-router)# timers lsa-group-pacing 200</pre>	Sets the interval in seconds for grouping LSAs. The range is from 1 to 1800. The default is 10 seconds.
Step 5	timers throttle lsa <i>start-time hold-interval max-time</i> Example: <pre>switch(config-router)# timers throttle lsa network 350 5000 6000</pre>	Sets the rate limit in milliseconds for generating LSAs. You can configure the following timers: <ul style="list-style-type: none"> • <i>start-time</i>—The range is from 0 to 5000 milliseconds. The default value is 0 milliseconds.

	Command or Action	Purpose
		<ul style="list-style-type: none"> • <i>hold-interval</i>—The range is from 50 to 30,000 milliseconds. The default value is 5000 milliseconds. • <i>max-time</i>—The range is from 50 to 30,000 milliseconds. The default value is 5000 milliseconds.
Step 6	address-family ipv6 unicast Example: <pre>switch(config-router)# address-family ipv6 unicast switch(config-router-af)#</pre>	Enters IPv6 unicast address family mode.
Step 7	timers throttle spf delay-time hold-time max-time Example: <pre>switch(config-router-af)# timers throttle spf 3000 2000</pre>	Sets the SPF best path schedule in seconds between SPF best path calculations with the following timers: <ul style="list-style-type: none"> • <i>delay-time</i>—The range is from 1 to 600,000 milliseconds. The default value is 200 milliseconds. • <i>hold-time</i>—The range is from 1 to 600,000 milliseconds. The default value is 1000 milliseconds. • <i>max-wait</i>—The range is from 1 to 600,000 milliseconds. The default value is 5000 milliseconds.
Step 8	interface type slot/port Example: <pre>switch(config)# interface ethernet 1/2 switch(config-if)#</pre>	Enters interface configuration mode.
Step 9	ospfv3 retransmit-interval seconds Example: <pre>switch(config-if)# ospfv3 retransmit-interval 30</pre>	Sets the estimated time in seconds between LSAs transmitted from this interface. The range is from 1 to 65535. The default is 5.
Step 10	ospfv3 transmit-delay seconds Example: <pre>switch(config-if)# ospfv3 transmit-delay 600</pre>	Sets the estimated time in seconds to transmit an LSA to a neighbor. The range is from 1 to 450. The default is 1.
Step 11	(Optional) copy running-config startup-config Example: <pre>switch(config)# copy running-config startup-config</pre>	Copies the running configuration to the startup configuration.

Example

This example shows how to control LSA flooding with the `lsa-group-pacing` option:

```
switch# configure terminal
switch(config)# router ospfv3 201
switch(config-router)# timers lsa-group-pacing 300
switch(config-router)# copy running-config startup-config
```

Configuring Graceful Restart

Graceful restart is enabled by default. You can configure the following optional parameters for graceful restart in an OSPFv3 instance:

- Grace period—Configures how long neighbors should wait after a graceful restart has started before tearing down adjacencies.
- Helper mode disabled—Disables helper mode on the local OSPFv3 instance. OSPFv3 does not participate in the graceful restart of a neighbor.
- Planned graceful restart only—Configures OSPFv3 to support graceful restart only in the event of a planned restart.

Before you begin

You must enable OSPFv3 (see the [Enabling OSPFv3](#) section).

Ensure that all neighbors are configured for graceful restart with matching optional parameters set.

SUMMARY STEPS

1. **configure terminal**
2. **router ospfv3 *instance-tag***
3. **graceful-restart**
4. **graceful-restart grace-period *seconds***
5. **graceful-restart helper-disable**
6. **graceful-restart planned-only**
7. (Optional) **show ipv6 ospfv3 *instance-tag***
8. (Optional) **copy running-config startup-config**

DETAILED STEPS

	Command or Action	Purpose
Step 1	configure terminal Example: <pre>switch# configure terminal switch(config)#</pre>	Enters global configuration mode.
Step 2	router ospfv3 <i>instance-tag</i> Example: <pre>switch(config)# router ospfv3 201 switch(config-router)#</pre>	Creates a new OSPFv3 instance with the configured instance tag.

	Command or Action	Purpose
Step 3	graceful-restart Example: switch(config-router)# graceful-restart	Enables a graceful restart. A graceful restart is enabled by default.
Step 4	graceful-restart grace-period seconds Example: switch(config-router)# graceful-restart grace-period 120	Sets the grace period, in seconds. The range is from 5 to 1800 seconds. The default is 60 seconds.
Step 5	graceful-restart helper-disable Example: switch(config-router)# graceful-restart helper-disable	Disables helper mode. Enabled by default.
Step 6	graceful-restart planned-only Example: switch(config-router)# graceful-restart planned-only	Configures graceful restart for planned restarts only.
Step 7	(Optional) show ipv6 ospfv3 instance-tag Example: switch(config-router)# show ipv6 ospfv3 201	Displays OPSFv3 information.
Step 8	(Optional) copy running-config startup-config Example: switch(config)# copy running-config startup-config	Copies the running configuration to the startup configuration.

Example

This example shows how to enable a graceful restart if it has been disabled and set the grace period to 120 seconds:

```
switch# configure terminal
switch(config)# router ospfv3 201
switch(config-router)# graceful restart
switch(config-router)# graceful-restart grace-period 120
switch(config-router)# copy running-config startup-config
```

Restarting an OSPFv3 Instance

You can restart an OSPv3 instance. This action clears all neighbors for the instance.

To restart an OSPFv3 instance and remove all associated neighbors, use the following command:

SUMMARY STEPS

1. **restart ospfv3** *instance-tag*

DETAILED STEPS

	Command or Action	Purpose
Step 1	restart ospfv3 <i>instance-tag</i> Example: <pre>switch(config)# restart ospfv3 201</pre>	Restarts the OSPFv3 instance and removes all neighbors.

Configuring OSPFv3 with Virtualization

You can configure multiple OSPFv3 instances. You can also create multiple VRFs within the virtual device context (VDC) and use the same or multiple OSPFv3 instances in each VRF. You assign an OSPFv3 interface to a VRF.



Note Configure all other parameters for an interface after you configure the VRF for an interface. Configuring a VRF for an interface deletes all the configuration for that interface.

Before you begin

You must enable OSPFv3 (see the [Enabling OSPFv3](#) section).

SUMMARY STEPS

1. **configure terminal**
2. **vrf context** *vrf-name*
3. **router ospfv3** *instance-tag*
4. **vrf** *vrf-name*
5. (Optional) **maximum-paths** *paths*
6. **interface** *type slot/port*
7. **vrf member** *vrf-name*
8. **ipv6 address** *ipv6-prefix/length*
9. **ipv6 ospfv3** *instance-tag area area-id*
10. (Optional) **copy running-config startup-config**

DETAILED STEPS

	Command or Action	Purpose
Step 1	configure terminal Example: <pre>switch# configure terminal switch(config)#</pre>	Enters global configuration mode.

	Command or Action	Purpose
Step 2	vrf context <i>vrf-name</i> Example: <pre>switch(config)# vrf context RemoteOfficeVRF switch(config-vrf)#</pre>	Creates a new VRF and enters VRF configuration mode.
Step 3	router ospfv3 <i>instance-tag</i> Example: <pre>switch(config)# router ospfv3 201 switch(config-router)#</pre>	Creates a new OSPFv3 instance with the configured instance tag.
Step 4	vrf <i>vrf-name</i> Example: <pre>switch(config-router)# vrf RemoteOfficeVRF switch(config-router-vrf)#</pre>	Enters router VRF configuration mode.
Step 5	(Optional) maximum-paths <i>paths</i> Example: <pre>switch(config-router-vrf)# maximum-paths 4</pre>	Configures the maximum number of equal OSPFv3 paths to a destination in the route table for this VRF. Use this command for load balancing.
Step 6	interface <i>type slot/port</i> Example: <pre>switch(config)# interface ethernet 1/2 switch(config-if)#</pre>	Enters interface configuration mode.
Step 7	vrf member <i>vrf-name</i> Example: <pre>switch(config-if)# vrf member RemoteOfficeVRF</pre>	Adds this interface to a VRF.
Step 8	ipv6 address <i>ipv6-prefix/length</i> Example: <pre>switch(config-if)# ipv6 address 2001:0DB8::1/48</pre>	Configures an IP address for this interface. You must do this step after you assign this interface to a VRF.
Step 9	ipv6 ospfv3 <i>instance-tag area area-id</i> Example: <pre>switch(config-if)# ipv6 ospfv3 201 area 0</pre>	Assigns this interface to the OSPFv3 instance and area configured.
Step 10	(Optional) copy running-config startup-config Example: <pre>switch(config)# copy running-config startup-config</pre>	Copies the running configuration to the startup configuration.

Example

This example shows how to create a VRF and add an interface to the VRF:

```
switch# configure terminal
switch(config)# vrf context NewVRF
switch(config-vrf)# exit
switch(config)# router ospfv3 201
switch(config-router)# exit
switch(config)# interface ethernet 1/2
switch(config-if)# vrf member NewVRF
switch(config-if)# ipv6 address 2001:0DB8::1/48
switch(config-if)# ipv6 ospfv3 201 area 0
switch(config-if)# copy running-config startup-config
```

Configuring Encryption and Authentication

Beginning with Cisco Nexus Release 10.2(1), you can encrypt and authenticate OSPFv3 messages using ESP encapsulation. OSPFv3 depends on IPsec for secure connection. IPsec supports two encapsulation types:

- Authentication Header (AH)
- Encapsulating Security Payload (ESP)
- RFC4552 ‘Authentication/Confidentiality for OSPFv3’ covers both the above aspects

ESP configuration provides both encryption and authentication for OSPFv3 messages.

Beginning with Cisco Nexus Release 10.4(1)F, the encryption and authentication algorithms and keys can be configured using the keychain option.

The following are the limitations:

1. Only IPsec transport mode is supported and tunnel mode is not supported.
2. AH and ESP configurations together are not allowed on an interface. Though two different interfaces can have AH and ESP.
3. Non-disruptive rekeying as defined in section 10 of RFC 4552 is not supported.
4. The following Encryption Algorithms will be supported under ESP:
 - AES-CBC (128 bit)
 - AES 192 bit and AES 256 bit will not be supported in this release.
 - 3DES-CBC
 - NULL
5. The following Authentications will be supported under ESP:
 - SHA-1
 - NULL
6. Both Encryption and Authentication algorithms cannot be configured NULL in one ESP CLI.

7. An interface which is part of multiple areas use the same ESP parameters as the parent.
8. On SPI conflict during configuration, error will be thrown to user and configuration will not be saved. So, while changing the ESP configuration the user must use different SPI for a new configuration.
9. Max 128 SA/SPI values can be configured per OSPFv3 process.

You can configure ESP at the following levels:

- Router
- Area
- Interface
- Virtual Links

Configuring OSPFv3 Encryption at Router Level

You can configure OSPFv3 ESP to encrypt and authenticate OSPFv3 packets at the router level using the following commands.

For information on how to configure a keychain, see **Configuring Keychain Management** of *Cisco Nexus 9000 Series NX-OS Security Configuration Guide*.

Before you begin

Enable OSPFv3 feature.

Enable authentication package.

Step 1 Enter the global configuration mode:

```
switch# configure terminal
```

Step 2 Enable OSPFv3:

```
switch(config)# feature ospfv3
```

Step 3 Enable authentication package:

```
switch(config)# feature imp
```

Step 4 Create a new OSPFv3 instance with the configured instance tag:

```
switch(config)# router ospfv3 instance-tag
```

Step 5 Enable IPsec ESP encryption:

```
switch(config-router)# encryption ipsec spi spi_id esp [encrypt_algorithm [ 0 | 3 | 7 ] key | key-chain enc_keychain_name | null] authentication [auth_algorithm [ 0 | 3 | 7 ] key | key-chain auth_keychain_name | null]
```

You can specify the security policy index through *spi_id* and define the encryption algorithm through *encrypt_algorithm* which can be 3DES, AES 128 or null. Numbers 0, 3, and 7 specify the format of the *key*. You can define the authentication algorithm through *auth_algorithm* which can be SHA-1 or NULL.

You can also configure keys and algorithms using the **key-chain** option.

- Step 6** (Optional) Display OSPFv3 information:
switch(config)# **show running-config ospfv3**
-

Configuring OSPFv3 Encryption at Area Level

You can configure OSPFv3 ESP to encrypt and authenticate OSPFv3 packets at the area level using the following commands.

For information on how to configure a keychain, see **Configuring Keychain Management** of *Cisco Nexus 9000 Series NX-OS Security Configuration Guide*.

Before you begin

- Enable OSPFv3 feature.
 - Enable authentication package.
-

- Step 1** Enter the global configuration mode:
switch# **configure terminal**
- Step 2** Enable OSPFv3:
switch(config)# **feature ospfv3**
- Step 3** Enable the authentication package:
switch(config)# **feature imp**
- Step 4** Create a new OSPFv3 instance with the configured instance tag:
switch(config)# **router ospfv3 instance-tag**
- Step 5** Enable IPsec ESP Encryption:
switch(config-router)#**area area-num encryption ipsec spi spi_val esp encrypt_algorithm [0 | 3 | 7key | key-chain enc_keychain_name | null] authentication auth_algorithm [0 | 3 | 7] key | key-chain auth_keychain_name | null]**
- You can specify the security policy index through *spi_id* and define the encryption algorithm through *encrypt_algorithm* which can be 3DES, AES 128 or null. Numbers 0, 3, 6 and 7 specify the format of the *key*. You can define the authentication algorithm through *auth_algorithm* which can be SHA-1 or NULL or key-chain.
- You can also configure keys and algorithms using the **key-chain** option.
- Step 6** (Optional) Display OSPFv3 information:
switch(config)# **show running-config ospfv3**
-

Configuring OSPFv3 Encryption at Interface Level

You can configure OSPFv3 ESP to encrypt and authenticate OSPFv3 packets at the interface level using the following commands.

For information on how to configure a keychain, see **Configuring Keychain Management** of *Cisco Nexus 9000 Series NX-OS Security Configuration Guide*.

Before you begin

You must enable OSPFv3.

Enable authentication package.

Step 1 Enter the global configuration mode:

```
switch# configure terminal
```

Step 2 Enable OSPFv3:

```
switch(config)# feature ospfv3
```

Step 3 Enables the authentication mode:

```
switch(config)# feature imp
```

Step 4 Enters the interface configuration mode:

```
switch(config)# interface ethernet interface
```

Step 5 Specify the OSPFv3 instance and area for the interface:

```
switch(config-if)# ipv6 router ospfv3 instance-tag area area-id
```

Step 6 Enable IPsec ESP Encryption:

```
switch(config-if)# ospfv3 encryption ipsec spi spi_id esp encrypt_algorithm [ 0 | 3 | 7 ] key | key-chain enc_keychain_name | null ] authentication auth_algorithm [ 0 | 3 | 7 ] key | key-chain auth_keychain_name | null ]
```

You can specify the security policy index through *spi_id* and define the encryption algorithm through *encrypt_algorithm* which can be 3DES, AES 128 or null. Numbers 0, 3 and 7 specify the format of the *key*. You can define the authentication algorithm through *auth_algorithm* which can be SHA-1 or NULL.

You can also configure keys and algorithms using the key-chain option.

Step 7 (Optional) Display the running configuration on the interface:

```
switch(config-if)#show run interface interface
```

Configuration Example

The following example shows how to enable security for Ethernet interface 3/2:

```
switch# configure terminal
switch(config)# feature ospfv3
switch(config)# feature imp
```



```

switch(config)# interface ethernet 3/2
switch(config-if)# ipv6 router ospfv3 1 area 0.0.0.0
switch(config-if)# ospfv3 encryption ipsec spi 444
  esp Specify encryption parameters
switch(config-if)# ospfv3 encryption ipsec spi 444 esp
  3des Use the triple DES algorithm
  aes Use the AES algorithm
  key-chain Encryption password key-chain
  null Use NULL authentication
switch(config-if)# ospfv3 encryption ipsec spi 444 esp aes
  128 Use the 128-bit AES algorithm
switch(config-if)# ospfv3 encryption ipsec spi 444 esp aes 128
  0 Specifies an UNENCRYPTED encryption key will follow
  3 Specifies an 3DES ENCRYPTED encryption key will follow
  7 Specifies a Cisco type 7 ENCRYPTED encryption key will follow
  WORD The UNENCRYPTED (cleartext) encryption key
switch(config-if)# ospfv3 encryption ipsec spi 444 esp aes 128
12345678123456781234567812345678 authentication null
switch(config-if)# sh ospfv3 interface
Ethernet3/2 is up, line protocol is up
  IPv6 address 1:1:1:1::2/64
  Process ID 1 VRF default, Instance ID 0, area 0.0.0.0
  Enabled by interface configuration
  State DOWN, Network type BROADCAST, cost 40
  ESP Encryption AES, Authentication NULL, SPI 444, ConnId 444
switch(config-if)#

```

Configuring OSPFv3 Encryption for Virtual Links

You can configure OSPFv3 ESP to encrypt and authenticate OSPFv3 packets for virtual links using the following commands.

For information on how to configure a keychain, see **Configuring Keychain Management** of *Cisco Nexus 9000 Series NX-OS Security Configuration Guide*.

Before you begin

Enable OSPFv3 feature.

Enable authentication package.

-
- Step 1** Enter the global configuration mode:
- ```
switch# configure terminal
```
- Step 2** Enable OSPFv3:
- ```
switch(config)# feature ospfv3
```
- Step 3** Enable the authentication package:
- ```
switch(config)# feature imp
```
- Step 4** Create a new OSPFv3 instance with the configured instance tag:
- ```
switch(config)#router ospfv3 instance-tag
```
- Step 5** Creates one end of a virtual link to a remote router. You must create the virtual link on that remote router to complete the link.

```
switch(config-router)# area area-id virtual-link router-id
```

Step 6 Enable IPsec ESP Encryption:

```
switch(config-router-vlink)# encryption ipsec spi spi_id esp encrypt_algorithm [ 0 | 3 | 7 ] key | key-chain
enc_keychain_name | null] authentication auth_algorithm [ 0 | 3 | 7 ] key | key-chain auth_keychain_name | null]
```

You can specify the security policy index through *spi_id* and define the encryption algorithm through *encrypt_algorithm* which can be 3DES, AES 128 or null. Numbers 0, 3 and 7 specify the format of the *key*. You can define the authentication algorithm through *auth_algorithm* which can be SHA-1 or NULL.

You can also configure keys and algorithms using the **key-chain** option.

Step 7 (Optional) Display OSPFv3 information:

```
switch(config)# show running-config ospfv3
```

Configuration Example

The following example shows how to encrypt Virtual links:

```
switch(config)# feature ospfv3
switch(config)# feature imp
switch(config-if)# router ospfv3 1
switch(config-router)# area 0.0.0.1 virtual-link 3.3.3.3
switch(config-router-vlink)# encryption ipsec spi ?
<256-4294967295> SPI Value
switch(config-router-vlink)# encryption ipsec spi 256 esp ?
3des Use the triple DES algorithm
aes Use the AES algorithm
key-chain Encryption password key-chain
null Use NULL authentication
switch(config-router-vlink)# encryption ipsec spi 256 esp aes 128
123456789A123456789B123456789C12 authentication ?
null Use NULL authentication
sha1 Use the SHA1 algorithm
switch(config-router-vlink)# encryption ipsec spi 256 esp aes 128
123456789A123456789B123456789C12 authentication null
```



Note To permit multiple OSPFv3 neighbors to have IPsec ESP, the following policy-map has to be applied for a control-plane:

```
ipv6 access-list copp-acl-ipsec
10 permit ahp any any
20 permit esp any any

class-map type control-plane match-any copp-class-critical-customized-copp
match access-group name copp-acl-ipsec
policy-map type control-plane customized-copp
class copp-class-critical-customized-copp
police cir 36000 kbps bc 1280000 bytes conform transmit violate drop
control-plane
service-policy input customized-copp
```

Configuring OSPFv3 Authentication at Router Level

You can configure OSPFv3 ESP to authenticate OSPFv3 packets at the router level using the following commands.

For information on how to configure a keychain, see **Configuring Keychain Management** of *Cisco Nexus 9000 Series NX-OS Security Configuration Guide*.

Before you begin

Ensure that you have enabled OSPFv3, for more information see [Enabling OSPFv3](#) section.

SUMMARY STEPS

1. configure terminal
2. **feature ospfv3**
3. **feature imp**
4. **router ospfv3 instance-tag**
5. **[no] authentication {ipsec spi spi_id [auth_algorithm [0 | 3 | 7] key | key-chain auth_keychain_name | null]**
6. (Optional) **show running-config ospfv3**
7. (Optional) **copy running-config startup-config**

DETAILED STEPS

	Command or Action	Purpose
Step 1	configure terminal Example: switch# configure terminal switch(config)#	Enters global configuration mode.
Step 2	feature ospfv3 Example: switch(config)# feature ospfv3	Enables OSPFv3.
Step 3	feature imp Example: switch(config)# feature imp	Enables authentication mode.
Step 4	router ospfv3 instance-tag Example: switch(config)# router ospfv3 100 switch(config-router)#	Creates a new OSPFv3 instance with the configured instance tag.
Step 5	[no] authentication {ipsec spi spi_id [auth_algorithm [0 3 7] key key-chain auth_keychain_name null] Example: For authentication algorithm and key option:	Configures OSPFv3 IPsec authentication at the process (or VRF) level. The spi argument specifies the security parameter index (SPI). The range is from 256 to 4294967295.

	Command or Action	Purpose
	<pre>switch(config-router)# authentication ipsec spi 475 md5 11111111111111111111112222222222222222</pre> <p>For keychain option:</p> <pre>switch(config-router)# authentication ipsec spi 333 key-chain test1</pre>	<p>The auth argument specifies the type of authentication. The supported values are md5 or sha1.</p> <p>0 configures the password in cleartext. 3 configures the pass key as 3DES encrypted. 7 configures the key as Cisco type 7 encrypted.</p> <p>If the cleartext option (0) is used, the key argument must be 32 characters long for md5 or 40 characters long for sha1.</p> <p>Beginning with Cisco NX-OS Release 10.4(1)F, the key-chain option is provided to configure key and algorithm.</p> <p>Use the no form of this command to disable the OSPFv3 IPsec authentication.</p>
Step 6	<p>(Optional) show running-config ospfv3</p> <p>Example:</p> <pre>switch(config)# show running-config ospfv3</pre>	Displays the OSPFv3 authentication configuration information.
Step 7	<p>(Optional) copy running-config startup-config</p> <p>Example:</p> <pre>switch(config)# copy running-config startup-config</pre>	Saves this configuration change.

Configuring OSPFv3 Authentication at Area Level

You can configure OSPFv3 ESP to authenticate OSPFv3 packets at the area level using the following commands.

For information on how to configure a keychain, see **Configuring Keychain Management** of *Cisco Nexus 9000 Series NX-OS Security Configuration Guide*.

Before you begin

Ensure that you have enabled OSPFv3, for more information see [Enabling OSPFv3](#) section.

SUMMARY STEPS

1. **configure terminal**
2. **feature ospfv3**
3. **feature imp**
4. **router ospfv3 instance-tag**
5. **[no] area area-id-ip authentication {ipsec spi spi_id[auth_algorithm [0 | 3 | 7] key | key-chain auth_keychain_name | null}**
6. (Optional) **show running-config ospfv3**
7. (Optional) **copy running-config startup-config**

DETAILED STEPS

	Command or Action	Purpose
Step 1	configure terminal Example: <pre>switch# configure terminal switch(config)#</pre>	Enters global configuration mode.
Step 2	feature ospfv3 Example: <pre>switch(config)# feature ospfv3</pre>	Enables OSPFv3.
Step 3	feature imp Example: <pre>switch(config)# feature imp</pre>	Enables authentication mode.
Step 4	router ospfv3 instance-tag Example: <pre>switch(config)# router ospfv3 100 switch(config-router)#</pre>	Creates a new OSPFv3 instance with the configured instance tag.
Step 5	[no] area <i>area-id</i> ip authentication {ipsec spi <i>spi_id</i>[<i>auth_algorithm</i> [0 3 7] key key-chain <i>auth_keychain_name</i> null] Example: For authentication algorithm and key option: <pre>switch(config-router)# area 0 authentication ipsec spi 475 md5 111111111111111111112222222222222222</pre> For keychain option: <pre>switch(config-router)# area 0 authentication ipsec spi 333 key-chain test1</pre>	Configures OSPFv3 IPsec authentication at the area level. The spi argument specifies the security parameter index (SPI). The range is from 256 to 4294967295. The auth argument specifies the type of authentication. The supported values are MD5 or SHA-1. 0 configures the password in cleartext. 3 configures the pass key as 3DES encrypted. 7 configures the key as Cisco Type-7 encrypted. If the cleartext option (0) is used, the key argument must be 32 characters long for MD5 or 40 characters long for SHA-1. Beginning with Cisco NX-OS Release 10.4(1)F, the key-chain option is provided to configure key and algorithm. Use the no form of this command to disable the OSPFv3 IPsec authentication.
Step 6	(Optional) show running-config ospfv3 Example: <pre>switch(config)# show running-config ospfv3</pre>	Displays the OSPFv3 authentication configuration information.
Step 7	(Optional) copy running-config startup-config Example: <pre>switch(config)# copy running-config startup-config</pre>	Saves this configuration change.

Configuring OSPFv3 Authentication at Interface Level

You can configure OSPFv3 ESP to authenticate OSPFv3 packets at interval level using the following commands.

For information on how to configure a keychain, see **Configuring Keychain Management** of *Cisco Nexus 9000 Series NX-OS Security Configuration Guide*.

Before you begin

Ensure that you have enabled OSPFv3, for more information see [Enabling OSPFv3](#) section.

SUMMARY STEPS

1. configure terminal
2. **interface***interface-type slot/port*
3. **[no] ospfv3 authentication** {**disable** | **ipsec spi** *spi_id* {**md5** *akey* | **sha1** *akey* | **key-chain** *keychain_ah*}}
4. (Optional) **show running-config ospfv3**
5. (Optional) **copy running-config startup-config**

DETAILED STEPS

	Command or Action	Purpose
Step 1	configure terminal Example: switch# configure terminal switch(config)#	Enters global configuration mode.
Step 2	interface <i>interface-type slot/port</i> Example: switch(config)# interface ethernet 1/1 switch(config-if)#	Enters interface configuration mode.
Step 3	[no] ospfv3 authentication { disable ipsec spi <i>spi_id</i> { md5 <i>akey</i> sha1 <i>akey</i> key-chain <i>keychain_ah</i> }} Example: For authentication algorithm and key option: switch(config-if)# ospfv3 authentication ipsec spi 475 md5 111111111111111111112222222222222222 For keychain option: switch(config-if)# ospfv3 authentication ipsec spi 333 key-chain test1	Configures OSPFv3 IPsec authentication for the specified interface. The spi argument specifies the security parameter index (SPI). The range is from 256 to 4294967295. The auth argument specifies the type of authentication. The supported values are MD5 or SHA-1. 0 configures the password in cleartext. 3 configures the pass key as 3DES encrypted. 7 configures the key as Cisco Type-7 encrypted. If the cleartext option (0) is used, the key argument must be 32 characters long for MD5 or 40 characters long for SHA-1. Beginning with Cisco NX-OS Release 10.4(1)F, the key-chain option is provided to configure key and algorithm.

	Command or Action	Purpose
		Use the no form of this command to disable the OSPFv3 IPsec authentication.
Step 4	(Optional) show running-config ospfv3 Example: switch(config)# show running-config ospfv3	Displays the OSPFv3 authentication configuration information.
Step 5	(Optional) copy running-config startup-config Example: switch(config)# copy running-config startup-config	Saves this configuration change.

Configuring OSPFv3 Authentication at Virtual Links Level

You can configure OSPFv3 ESP to authenticate OSPFv3 packets at the virtual link level using the following commands.

For information on how to configure a keychain, see **Configuring Keychain Management** of *Cisco Nexus 9000 Series NX-OS Security Configuration Guide*.

Before you begin

Ensure that you have enabled OSPFv3, for more information see [Enabling OSPFv3](#) section.

SUMMARY STEPS

1. configure terminal
2. **feature ospfv3**
3. **feature imp**
4. **router ospfv3 instance-tag**
5. **area area-id virtual-link router-id**
6. **[no] authentication {ipsec spi spi_id [auth_algorithm [0 | 3 | 7] key | key-chain auth_keychain_name | null]**
7. (Optional) **show running-config ospfv3**
8. (Optional) **copy running-config startup-config**

DETAILED STEPS

	Command or Action	Purpose
Step 1	configure terminal Example: switch# configure terminal switch(config)#	Enters global configuration mode.
Step 2	feature ospfv3 Example: switch(config)# feature ospfv3	Enables OSPFv3.

	Command or Action	Purpose
Step 3	feature imp Example: switch(config)# feature imp	Enables authentication mode.
Step 4	router ospfv3 instance-tag Example: switch(config)# router ospfv3 100 switch(config-router)#	Creates a new OSPFv3 instance with the configured instance tag.
Step 5	area area-id virtual-link router-id Example: switch(config-router)# area 0.0.0.10 virtual-link 2001:0DB8::1 switch(config-router-vlink)#	Creates one end of a virtual link to a remote router. You must create the virtual link on that remote router to complete the link.
Step 6	[no] authentication {ipsec spi spi_id [auth_algorithm [0 3 7] key key-chain auth_keychain_name null]} Example: For authentication algorithm and key option: switch(config-router-vlink)# authentication ipsec spi 475 md5 111111111111111111112222222222222222 For keychain option: switch(config-router-vlink)# authentication ipsec spi 333 key-chain test1	Configures OSPFv3 IPsec authentication at the virtual link level. The spi argument specifies the security parameter index (SPI). The range is from 256 to 4294967295. The auth argument specifies the type of authentication. The supported values are MD5 or SHA-1. 0 configures the password in cleartext. 3 configures the password as 3DES encrypted. 7 configures the key as Cisco Type-7 encrypted. If the cleartext option (0) is used, the key argument must be 32 characters long for MD5 or 40 characters long for SHA-1. Beginning with Cisco NX-OS Release 10.4(1)F, the key-chain option is provided to configure key and algorithm. Use the no form of this command to disable the OSPFv3 IPsec authentication.
Step 7	(Optional) show running-config ospfv3 Example: switch(config)# show running-config ospfv3	Displays the OSPFv3 authentication configuration information.
Step 8	(Optional) copy running-config startup-config Example: switch(config)# copy running-config startup-config	Saves this configuration change.

Verifying the OSPFv3 Configuration

To display the OSPFv3 configuration, perform one of the following tasks:

Command	Purpose
show ipv6 ospfv3 [instance-tag] [vrf vrf-name]	Displays information about one or more OSPFv3 routing instances. The output includes the following area-level counts: <ul style="list-style-type: none"> • Interfaces in this area—A count of all interfaces added to this area (configured interfaces). • Active interfaces—A count of all interfaces considered to be in router link states and SPF (UP interfaces). • Passive interfaces—A count of all interfaces considered to be OSPF passive (no adjacencies will be formed). • Loopback interfaces—A count of all local loopback interfaces.
show ipv6 ospfv3 border-routers	Displays the internal OSPF routing table entries to an ABR and ASBR.
show ipv6 ospfv3 database	Displays lists of information related to the OSPFv3 database for a specific router.
show ipv6 ospfv3 interface type number [vrf {vrf-name all default management}]	Displays the OSPFv3 interface information.
show ipv6 ospfv3 neighbors	Displays the neighbor information. Use the clear ospfv3 neighbors command to remove adjacency with all neighbors.
show ipv6 ospfv3 request-list	Displays a list of LSAs requested by a router.
show ipv6 ospfv3 retransmission-list	Displays a list of LSAs waiting to be retransmitted.
show ipv6 ospfv3 summary-address	Displays a list of all summary address redistribution information configured under an OSPFv3 instance.
show ospfv3 process	Displays the OSPFv3 authentication configuration at the process level.
show ospfv3 interface interface-type slot/port	Displays the OSPFv3 authentication configuration at the interface level.
show running-configuration ospfv3	Displays the current running OSPFv3 configuration.

Monitoring OSPFv3

To display OSPFv3 statistics, use the following commands:

Command	Purpose
<code>show ipv6 ospfv3 memory</code>	Displays the OSPFv3 memory usage statistics.
<code>show ipv6 ospfv3 policy statistics area <i>area-id</i> filter-list {in out} [vrf {<i>vrf-name</i> all default management}]</code>	Displays the OSPFv3 route policy statistics for an area.
<code>show ipv6 ospfv3 policy statistics redistribute {bgp <i>id</i> direct isis <i>id</i> rip <i>id</i> static vrf {<i>vrf-name</i> all default management}}</code>	Displays the OSPFv3 route policy statistics.
<code>show ipv6 ospfv3 statistics [vrf {<i>vrf-name</i> all default management}]</code>	Displays the OSPFv3 event counters.
<code>show ipv6 ospfv3 traffic interface-type number [vrf {<i>vrf-name</i> all default management}]</code>	Displays the OSPFv3 packet counters.

Configuration Examples for OSPFv3

This example shows how to configure OSPFv3:

This example shows how to configure OSPFv3:

```
feature ospfv3
router ospfv3 201
  router-id 290.0.2.1

interface ethernet 1/2
  ipv6 address 2001:0DB8::1/48
  ipv6 ospfv3 201 area 0.0.0.10
```

This example shows how to configure OSPFv3 encryption using **key-chain** option:

```
switch(config-if)# ospfv3 encryption ipsec spi 333 esp ?
  3des      Use the triple DES algorithm
  aes       Use the AES algorithm
  key-chain Encryption password key-chain
  null      Use NULL authentication
switch(config-if)# ospfv3 encryption ipsec spi 333 esp key-chain ?
  WORD      Encryption key-chain name (Max Size 63)
switch(config-if)# ospfv3 encryption ipsec spi 333 esp key-chain test1 ?
  authentication Specify authentication parameters
switch(config-if)# ospfv3 encryption ipsec spi 333 esp key-chain test1 authentication ?
  key-chain Authentication password key-chain
  null      Use NULL authentication
switch(config-if)# ospfv3 encryption ipsec spi 333 esp key-chain test1 authentication
key-chain ?
  WORD      Authentication key-chain name (Max Size 63)
switch(config-if)# ospfv3 encryption ipsec spi 333 esp key-chain test1 authentication
key-chain test2 ?
  <CR>
switch(config-router)# sh ospfv3
Routing Process 2 with ID 20.20.10.2 VRF default
```

```
Routing Process Instance Number 1
Install discard route for summarized internal routes.
ESP Encryption 3DES, Authentication SHA1, SPI 334, ConnId 334
ESP keychains: Encr test_key_chain_01(ready), Auth test1(ready)
Number of new LSAs originated : 3
Number of new LSAs received : 0
```

Related Topics

The following topics can give more information on OSPF:

- [Configuring OSPFv2, on page 99](#)
- [Configuring Route Policy Manager, on page 515](#)

Additional References

For additional information related to implementing OSPF, see the following sections:

MIBs

MIBs	MIBs Link
MIBs related to OSPFv3	To locate and download supported MIBs, go to the following URL: ftp://ftp.cisco.com/pub/mibs/supportlists/nexus9000/Nexus9000MIBSupportList.html



CHAPTER 8

Configuring EIGRP

This chapter describes how to configure the Enhanced Interior Gateway Routing Protocol (EIGRP) on the Cisco NX-OS device.

- [About EIGRP, on page 209](#)
- [Prerequisites for EIGRP, on page 216](#)
- [Guidelines and Limitations for EIGRP, on page 216](#)
- [Default Settings, on page 218](#)
- [Configuring Basic EIGRP, on page 219](#)
- [Configuring Advanced EIGRP, on page 224](#)
- [Configuring Virtualization for EIGRP, on page 239](#)
- [Verifying the EIGRP Configuration, on page 240](#)
- [Monitoring EIGRP, on page 241](#)
- [Configuration Examples for EIGRP, on page 241](#)
- [Related Topics, on page 242](#)
- [Additional References, on page 242](#)

About EIGRP

EIGRP combines the benefits of distance vector protocols with the features of link-state protocols. EIGRP sends out periodic Hello messages for neighbor discovery. Once EIGRP learns a new neighbor, it sends a one-time update of all the local EIGRP routes and route metrics. The receiving EIGRP router calculates the route distance based on the received metrics and the locally assigned cost of the link to that neighbor. After this initial full route table update, EIGRP sends incremental updates to only those neighbors affected by the route change. This process speeds convergence and minimizes the bandwidth used by EIGRP.

EIGRP Components

EIGRP has the following basic components:

- [Reliable Transport Protocol](#)
- [Neighbor Discovery and Recovery](#)
- [Neighbor Discovery and Recovery](#)

Reliable Transport Protocol

The Reliable Transport Protocol guarantees ordered delivery of EIGRP packets to all neighbors. (See the [Neighbor Discovery and Recovery](#) section.) The Reliable Transport Protocol supports an intermixed transmission of multicast and unicast packets. The reliable transport can send multicast packets quickly when unacknowledged packets are pending. This provision helps to ensure that the convergence time remains low for various speed links. See the [Configuring Advanced EIGRP, on page 224](#) section for details about modifying the default timers that control the multicast and unicast packet transmissions.

The Reliable Transport Protocol includes the following message types:

- Hello—Used for neighbor discovery and recovery. By default, EIGRP sends a periodic multicast Hello message on the local network at the configured hello interval. By default, the hello interval is 5 seconds.
- Acknowledgment—Verify reliable reception of Updates, Queries, and Replies.
- Updates—Send to affected neighbors when routing information changes. Updates include the route destination, address mask, and route metrics such as delay and bandwidth. The update information is stored in the EIGRP topology table.
- Queries and Replies—Sent as part of the Diffusing Update Algorithm used by EIGRP.

Neighbor Discovery and Recovery

EIGRP uses the Hello messages from the Reliable Transport Protocol to discover neighboring EIGRP routers on directly attached networks. EIGRP adds neighbors to the neighbor table. The information in the neighbor table includes the neighbor address, the interface it was learned on, and the hold time, which indicates how long EIGRP should wait before declaring a neighbor unreachable. By default, the hold time is three times the hello interval or 15 seconds.

EIGRP sends a series of Update messages to new neighbors to share the local EIGRP routing information. This route information is stored in the EIGRP topology table. After this initial transmission of the full EIGRP route information, EIGRP sends Update messages only when a routing change occurs. These Update messages contain only the new or changed information and are sent only to the neighbors affected by the change. See the [EIGRP Route Updates](#) section.

EIGRP also uses the Hello messages as a keepalive to its neighbors. As long as Hello messages are received, Cisco NX-OS can determine that a neighbor is alive and functioning.

Diffusing Update Algorithm

The Diffusing Update Algorithm (DUAL) calculates the routing information based on the destination networks in the topology table. The topology table includes the following information:

- IPv4 or IPv6 address/mask—The network address and network mask for this destination.
- Successors—The IP address and local interface connection for all feasible successors or neighbors that advertise a shorter distance to the destination than the current feasible distance.
- Feasibility distance (FD)—The lowest calculated distance to the destination.

DUAL uses the distance metric to select efficient, loop-free paths. DUAL selects routes to insert into the unicast Routing Information Base (RIB) based on feasible successors. When a topology change occurs, DUAL looks for feasible successors in the topology table. If there are feasible successors, DUAL selects the feasible successor with the lowest feasible distance and inserts that into the unicast RIB, avoiding unnecessary recomputation.

When there are no feasible successors but there are neighbors advertising the destination, DUAL transitions from the passive state to the active state and triggers a recomputation to determine a new successor or next-hop router to the destination. The amount of time required to recompute the route affects the convergence time. EIGRP sends Query messages to all neighbors, searching for feasible successors. Neighbors that have a feasible successor send a Reply message with that information. Neighbors that do not have feasible successors trigger a DUAL recomputation.

EIGRP Route Updates

When a topology change occurs, EIGRP sends an Update message with only the changed routing information to affected neighbors. This Update message includes the distance information to the new or updated network destination.

The distance information in EIGRP is represented as a composite of available route metrics, including bandwidth, delay, load utilization, and link reliability. Each metric has an associated weight that determines if the metric is included in the distance calculation. You can configure these metric weights. You can fine-tune link characteristics to achieve optimal paths, but we recommend that you use the default settings for most configurable metrics.

Internal Route Metrics

Internal routes are routes that occur between neighbors within the same EIGRP autonomous system. These routes have the following metrics:

- Next hop—The IP address of the next-hop router.
- Delay—The sum of the delays configured on the interfaces that make up the route to the destination network. The delay is configured in tens of microseconds.
- Bandwidth—The calculation from the lowest configured bandwidth on an interface that is part of the route to the destination.



Note Cisco recommends that you use the default bandwidth value. This bandwidth parameter is also used by EIGRP.

- MTU—The smallest maximum transmission unit value along the route to the destination.
- Hop count—The number of hops or routers that the route passes through to the destination. This metric is not directly used in the DUAL computation.
- Reliability—An indication of the reliability of the links to the destination.
- Load—An indication of how much traffic is on the links to the destination.

By default, EIGRP uses the bandwidth and delay metrics to calculate the distance to the destination. You can modify the metric weights to include the other metrics in the calculation.

Wide Metrics

EIGRP supports wide (64-bit) metrics to improve route selection on higher-speed interfaces or bundled interfaces. Routers supporting wide metrics can interoperate with routers that do not support wide metrics as follows:

- A router that supports wide metrics—Adds local wide metrics values to the received values and sends the information on.
- A router that does not support wide metrics—Sends any received metrics on without changing the values.

EIGRP uses the following equation to calculate path cost with wide metrics:

$$\text{metric} = [k1 \times \text{bandwidth} + (k2 \times \text{bandwidth}) / (256 - \text{load}) + k3 \times \text{delay} + k6 \times \text{extended attributes}] \times [k5 / (\text{reliability} + k4)]$$

Since the unicast RIB cannot support 64-bit metric values, EIGRP wide metrics uses the following equation with a RIB scaling factor to convert the 64-bit metric value to a 32-bit value:

$$\text{RIB Metric} = (\text{Wide Metric} / \text{RIB scale value})$$

where the RIB scale value is a configurable parameter.

EIGRP wide metrics introduce the following two new metric values represented as k6 in the EIGRP metrics configuration:

- Jitter—Measured in microseconds and accumulated across all links in the route path.
- Energy—Measured in watts per kilobit and accumulated across all links in the route path.

EIGRP prefers a path with low or no jitter or energy metric values over a path with higher values.



Note EIGRP wide metrics are sent with a TLV version of 2. For more information, see the [Enabling Wide Metrics](#) section.

External Route Metrics

External routes are routes that occur between neighbors in different EIGRP autonomous systems. These routes have the following metrics:

- Next hop—The IP address of the next-hop router.
- Router ID—The router ID of the router that redistributed this route into EIGRP.
- AS number—The autonomous system number of the destination.
- Protocol ID—A code that represents the routing protocol that learned the destination route.
- Tag—An arbitrary tag that can be used for route maps.
- Metric—The route metric for this route from the external routing protocol.

EIGRP and the Unicast RIB

EIGRP adds all learned routes to the EIGRP topology table and the unicast RIB. When a topology change occurs, EIGRP uses these routes to search for a feasible successor. EIGRP also listens for notifications from the unicast RIB for changes in any routes redistributed to EIGRP from another routing protocol.

Advanced EIGRP

You can use the advanced features of EIGRP to optimize your EIGRP configuration.

Address Families

EIGRP supports both IPv4 and IPv6 address families. For backward compatibility, you can configure EIGRPv4 in route configuration mode or in IPv4 address family mode. You must configure EIGRP for IPv6 in address family mode.

Address family configuration mode includes the following EIGRP features:

- Authentication
- AS number
- Default route
- Metrics
- Distance
- Graceful restart
- Logging
- Load balancing
- Redistribution
- Router ID
- Stub router
- Timers

You cannot configure the same feature in more than one configuration mode. For example, if you configure the default metric in router configuration mode, you cannot configure the default metric in address family mode.

Authentication

You can configure authentication on EIGRP messages to prevent unauthorized or invalid routing updates in your network. EIGRP authentication supports MD5 authentication digest.

You can configure the EIGRP authentication per virtual routing and forwarding (VRF) instance or interface using keychain management for the authentication keys. Keychain management allows you to control changes to the authentication keys used by MD5 authentication digest. See the *Cisco Nexus 9000 Series NX-OS Security Configuration Guide* for more details about creating keychains.

For MD5 authentication, you configure a password that is shared at the local router and all remote EIGRP neighbors. When an EIGRP message is created, Cisco NX-OS creates an MD5 one-way message digest based on the message itself and the encrypted password and sends this digest along with the EIGRP message. The receiving EIGRP neighbor validates the digest using the same encrypted password. If the message has not changed, the calculation is identical, and the EIGRP message is considered valid.

MD5 authentication also includes a sequence number with each EIGRP message that is used to ensure that no message is replayed in the network.

Stub Routers

You can use the EIGRP stub routing feature to improve network stability, reduce resource usage, and simplify stub router configuration. Stub routers connect to the EIGRP network through a remote router. See the [Stub Routing](#) section.

When using EIGRP stub routing, you need to configure the distribution and remote routers to use EIGRP and configure only the remote router as a stub. EIGRP stub routing does not automatically enable summarization on the distribution router. In most cases, you need to configure summarization on the distribution routers.

Without EIGRP stub routing, even after the routes that are sent from the distribution router to the remote router have been filtered or summarized, a problem might occur. For example, if a route is lost somewhere in the corporate network, EIGRP could send a query to the distribution router. The distribution router could then send a query to the remote router even if routes are summarized. If a problem communicating over the WAN link between the distribution router and the remote router occurs, EIGRP could get stuck in an active condition and cause instability elsewhere in the network. EIGRP stub routing allows you to prevent queries to the remote router.

Route Summarization

You can configure a summary aggregate address for a specified interface. Route summarization simplifies route tables by replacing a number of more-specific addresses with an address that represents all the specific addresses. For example, you can replace 10.1.1.0/24, 10.1.2.0/24, and 10.1.3.0/24 with one summary address, 10.1.0.0/16.

If more specific routes are in the routing table, EIGRP advertises the summary address from the interface with a metric equal to the minimum metric of the more specific routes.

In case of process restart or system switchover, the summary address can cause traffic loss. The traffic loss will be seen on the PEER where traffic is routed using the summary address.



Note EIGRP does not support automatic route summarization.

Route Redistribution

You can use EIGRP to redistribute static routes, routes learned by other EIGRP autonomous systems, or routes from other protocols. You must configure a route map with the redistribution to control which routes are passed into EIGRP. A route map allows you to filter routes based on attributes such as the destination, origination protocol, route type, route tag, and so on. See [Configuring Route Policy Manager, on page 515](#).

You also configure the default metric that is used for all imported routes into EIGRP.

You use distribute lists to filter routes from routing updates. These filtered routes are applied to each interface with the **ip distribute-list eigrp** command.

Load Balancing

You can use load balancing to allow a router to distribute traffic over all the router network ports that are the same distance from the destination address. Load balancing increases the usage of network segments, which increases effective network bandwidth.

Cisco NX-OS supports the Equal Cost Multiple Paths (ECMP) feature with up to 16 equal-cost paths in the EIGRP route table and the unicast RIB. You can configure EIGRP to load balance traffic across some or all of those paths.



Note EIGRP in Cisco NX-OS does not support unequal cost load balancing.

Split Horizon

You can use split horizon to ensure that EIGRP never advertises a route out of the interface where it was learned.

Split horizon is a method that controls the sending of EIGRP update and query packets. When you enable split horizon on an interface, Cisco NX-OS does not send update and query packets for destinations that were learned from this interface. Controlling update and query packets in this manner reduces the possibility of routing loops.

Split horizon with poison reverse configures EIGRP to advertise a learned route as unreachable back through the interface from which EIGRP learned the route.

EIGRP uses split horizon or split horizon with poison reverse in the following scenarios:

- Exchanging topology tables for the first time between two routers in startup mode.
- Advertising a topology table change.
- Sending a Query message.

By default, the split horizon feature is enabled on all interfaces.

BFD

This feature supports bidirectional forwarding detection (BFD) for IPv4 and IPv6. BFD is a detection protocol designed to provide fast forwarding-path failure detection times. BFD provides subsecond failure detection between two adjacent devices and can be less CPU-intensive than protocol hello messages because some of the BFD load can be distributed onto the data plane on supported modules. See the [Cisco Nexus 9000 Series NX-OS Interfaces Configuration Guide](#) for more information.

Virtualization Support

EIGRP supports virtual routing and forwarding instances (VRFs).

Graceful Restart and High Availability

Cisco NX-OS supports nonstop forwarding and graceful restart for EIGRP.

You can use nonstop forwarding for EIGRP to forward data packets along known routes in the FIB while the EIGRP routing protocol information is being restored following a failover. With nonstop forwarding (NSF), peer networking devices do not experience routing flaps. During failover, data traffic is forwarded through intelligent modules while the standby supervisor becomes active.

If a Cisco NX-OS system experiences a cold reboot, the device does not forward traffic to the system and removes the system from the network topology. In this scenario, EIGRP experiences a stateless restart, and

all neighbors are removed. Cisco NX-OS applies the startup configuration, and EIGRP rediscovers the neighbors and shares the full EIGRP routing information again.

A dual-supervisor platform that runs Cisco NX-OS can experience a stateful supervisor switchover. Before the switchover occurs, EIGRP uses a graceful restart to announce that EIGRP will be unavailable for some time. During a switchover, EIGRP uses nonstop forwarding to continue forwarding traffic based on the information in the FIB, and the system is not taken out of the network topology.

The graceful restart-capable router uses Hello messages to notify its neighbors that a graceful restart operation has started. When a graceful restart-aware router receives a notification from a graceful restart-capable neighbor that a graceful restart operation is in progress, both routers immediately exchange their topology tables. The graceful restart-aware router performs the following actions to assist the restarting router as follows:

- The router expires the EIGRP Hello hold timer to reduce the time interval set for Hello messages. This process allows the graceful restart-aware router to reply to the restarting router more quickly and reduces the amount of time required for the restarting router to rediscovers neighbors and rebuild the topology table.
- The router starts the route-hold timer. This timer sets the period of time that the graceful restart-aware router will hold known routes for the restarting neighbor. The default time period is 240 seconds.
- The router notes in the peer list that the neighbor is restarting, maintains adjacency, and holds known routes for the restarting neighbor until the neighbor signals that it is ready for the graceful restart-aware router to send its topology table or the route-hold timer expires. If the route-hold timer expires on the graceful restart-aware router, the graceful restart-aware router discards held routes and treats the restarting router as a new router that joins the network and reestablishes adjacency.

After the switchover, Cisco NX-OS applies the running configuration, and EIGRP informs the neighbors that it is operational again.

Multiple EIGRP Instances

Cisco NX-OS supports multiple instances of the EIGRP protocol that run on the same system. Every instance uses the same system router ID. You can optionally configure a unique router ID for each instance. For the number of supported EIGRP instances, see the [Cisco Nexus 9000 Series NX-OS Verified Scalability Guide](#).

Prerequisites for EIGRP

EIGRP has the following prerequisites:

- You must enable EIGRP (see the [Enabling the EIGRP Feature](#) section).

Guidelines and Limitations for EIGRP

EIGRP has the following configuration guidelines and limitations:

- When you configure a table map, administrative distance of the routes and the metric, the configuration commands cause the EIGRP neighbors to flap. This is an expected behavior.
- Names in the prefix-list are case-insensitive. We recommend using unique names. Do not use the same name by modifying uppercase and lowercase characters. For example, CTCPrimaryNetworks and CtcPrimaryNetworks are not two different entries.

- A metric configuration (either through the default-metric configuration option or through a route map) is required for redistribution from any other protocol, connected routes, or static routes. See [Configuring Route Policy Manager, on page 515](#).
- For graceful restart, an NSF-aware router must be up and completely converged with the network before it can assist an NSF-capable router in a graceful restart operation.
- For graceful restart, an NSF-aware router must be up and completely converged with the network before it can assist an NSF-capable router in a graceful restart operation.
- For graceful restart, neighboring devices participating in the graceful restart must be NSF-aware or NSF-capable.
- Cisco NX-OS EIGRP is compatible with EIGRP in the Cisco IOS software.
- EIGRP is not supported in tunnel interfaces.
- Do not change the metric weights without a good reason. If you change the metric weights, you must apply the change to all EIGRP routers in the same autonomous system.
- A mix of standard metrics and wide metrics in an EIGRP network with interface speeds of 1 Gigabit or greater might result in suboptimal routing.
- Consider using stubs for larger networks.
- Until NX-OS Release 10.3(3)F, EIGRP redistribute maximum-prefix feature is enabled by default with a default limit of 10000 (10K). Later releases don't have this configuration enabled by default, and an upgrade from NX-OS Release 10.3(3)F will remove this default configuration even if a user has explicitly configured the maximum-prefix value as 10000. Only when a user configures a limit other than 10000, the configuration will be present after upgrading from 10.3(3)F.
- Avoid redistribution between different EIGRP autonomous systems because the EIGRP vector metric will not be preserved.
- The **no {ip | ipv6} next-hop-self** command does not guarantee reachability of the next hop.
- The **{ip | ipv6} passive-interface eigrp** command suppresses neighbors from forming.
- Cisco NX-OS does not support IGRP or connecting IGRP and EIGRP clouds.
- Auto summarization is disabled by default and cannot be enabled.
- Cisco NX-OS supports only IP.
- High availability is not supported with EIGRP aggressive timers.
- To configure non default aggressive hello timers, it is recommended to use BFD with EIGRP default timers.
- Beginning with Cisco NX-OS Release 9.3(4), if the filtered list is modified when redistributing routes into EIGRP and filtering prefixes with a route map or prefix list, all prefixes that are permitted by the filter, even those not touched, are refreshed in the EIGRP topology table. This refresh is signaled to all EIGRP routers in the query domain for this set of prefixes.
- Beginning with Cisco NX-OS Release 10.3(1)F, EIGRP is supported on the Cisco Nexus 9808 platform switches.
- Beginning with Cisco NX-OS Release 10.4(1)F, EIGRP is supported on the Cisco Nexus 9804 platform switches.

- Beginning with Cisco NX-OS Release 10.4(1)F, EIGRP is supported on N9KX98900CD-A and N9KX9836DM-A line cards with Cisco Nexus 9808 and 9804 switches.
- With ASCII reload, VRF configuration is added automatically for all the VRFs under EIGRP



Note If you are familiar with the Cisco IOS CLI, be aware that the Cisco NX-OS commands for this feature might differ from the Cisco IOS commands that you would use.

Default Settings

The table lists the default settings for EIGRP parameters.

Table 20: Default Settings for EIGRP Parameters

Parameters	Default
Administrative distance	<ul style="list-style-type: none"> • Internal routes—90 • External routes—170
Bandwidth percent	50 percent
Default metric for redistributed routes	<ul style="list-style-type: none"> • Bandwidth—100000 Kb/s • Delay—100 (10-microsecond units) • Reliability—255 • Loading—1 • MTU—1500
EIGRP feature	Disabled
Hello interval	5 seconds
Hold time	15 seconds
Equal-cost paths	8
Metric weights	1 0 1 0 0 0
Next-hop address advertised	IP address of local interface
NSF convergence time	120
NSF route-hold time	240
NSF signal time	20
Redistribution	Disabled

Parameters	Default
Split horizon	Enabled

Configuring Basic EIGRP

Configuring Basic EIGRP.

Enabling the EIGRP Feature

You must enable EIGRP before you can configure EIGRP.

SUMMARY STEPS

1. **configure terminal**
2. **[no] feature eigrp**
3. (Optional) **show feature**
4. (Optional) **copy running-config startup-config**

DETAILED STEPS

	Command or Action	Purpose
Step 1	configure terminal Example: <pre>switch# configure terminal switch(config)#</pre>	Enters global configuration mode.
Step 2	[no] feature eigrp Example: <pre>switch(config)# feature eigrp</pre>	Enables the EIGRP feature. The no option disables the EIGRP feature and removes all associated configurations.
Step 3	(Optional) show feature Example: <pre>switch(config)# show feature</pre>	Displays information about enabled features.
Step 4	(Optional) copy running-config startup-config Example: <pre>switch(config)# copy running-config startup-config</pre>	Saves this configuration change.

Creating an EIGRP Instance

You can create an EIGRP instance and associate an interface with that instance. You assign a unique autonomous system number for this EIGRP process (see the [Autonomous Systems](#) section). Routes are not advertised or accepted from other autonomous systems unless you enable route redistribution.

Before you begin

You must enable EIGRP (see the [Enabling the EIGRP Feature](#) section).

EIGRP must be able to obtain a router ID (for example, a configured loopback address), or you must configure the router ID option.

If you configure an instance tag that does not qualify as an AS number, you must configure the AS number explicitly or this EIGRP instance remains in the shutdown state. For IPv6, this number must be configured under the address family.

SUMMARY STEPS

1. **configure terminal**
2. **[no] router eigrp** *instance-tag*
3. (Optional) **autonomous-system** *as-number*
4. (Optional) **log-adjacency-changes**
5. (Optional) **log-neighbor-warnings** [*seconds*]
6. **interface** *interface-type slot/port*
7. **{ip | ipv6} router eigrp** *instance-tag*
8. (Optional) **show {ip | ipv6} eigrp interfaces**
9. (Optional) **copy running-config startup-config**

DETAILED STEPS

	Command or Action	Purpose
Step 1	configure terminal Example: <pre>switch# configure terminal switch(config)#</pre>	Enters global configuration mode.
Step 2	[no] router eigrp <i>instance-tag</i> Example: <pre>switch(config)# router eigrp Test1 switch(config-router)#</pre>	<p>Creates a new EIGRP process with the configured instance tag. The instance tag can be any case-sensitive, alphanumeric string up to 20 characters.</p> <p>If you configure an <i>instance-tag</i> that does not qualify as an AS number, you must use the autonomous-system command to configure the AS number explicitly, or this EIGRP instance will remain in the shutdown state.</p> <p>Use the no option with this command to delete the EIGRP process and all associated configuration.</p> <p>Note You should also remove any EIGRP commands configured in interface mode if you remove the EIGRP process.</p>
Step 3	(Optional) autonomous-system <i>as-number</i> Example: <pre>switch(config-router)# autonomous-system 33</pre>	Configures a unique AS number for this EIGRP instance. The range is from 1 to 65535.

	Command or Action	Purpose
Step 4	(Optional) log-adjacency-changes Example: <pre>switch(config-router)# log-adjacency-changes</pre>	Generates a system message whenever an adjacency changes state. This command is enabled by default.
Step 5	(Optional) log-neighbor-warnings [<i>seconds</i>] Example: <pre>switch(config-router)# log-neighbor-warnings</pre>	Generates a system message whenever a neighbor warning occurs. You can configure the time between warning messages, from 1 to 65535, in seconds. The default is 10 seconds. This command is enabled by default.
Step 6	Required: interface <i>interface-type slot/port</i> Example: <pre>switch(config-router)# interface ethernet 1/2 switch(config-if)#</pre>	Enters interface configuration mode. Use ? to determine the slot and port ranges.
Step 7	Required: {ip ipv6} router eigrp instance-tag Example: <pre>switch(config-if)# ip router eigrp Test1 R2(config-if)# vrf member eigrp-vrf Warning: Retain-L3-config is on, deleted and re-added L3 config on interface Ethernet1/8 VRF eigrp-vrf does not exist. Create vrf to make interface Ethernet1/8 operational R2(config-if)# R2(config-if)# sh ru eigrp !Command: show running-config eigrp !Running configuration last done at: Thu Aug 25 06:59:31 2022 !Time: Thu Aug 25 06:59:36 2022 version 10.3(1) Bios:version 05.47 feature eigrp router eigrp 10 vrf eigrp-vrf interface Ethernet1/8 ip router eigrp 10</pre>	Associates this interface with the configured EIGRP process. The instance tag can be any case-sensitive, alphanumeric string up to 20 characters. Note On the interfaces where EIGRP process is running and <i>vrf retain</i> is configured, in this case, when the vrf member is changed on the interface, then the newly created <i>vrf-name</i> will also be reflected under the context of EIGRP process.
Step 8	(Optional) show {ip ipv6} eigrp interfaces Example: <pre>switch(config-if)# show ip eigrp interfaces</pre>	Displays information about EIGRP interfaces.
Step 9	(Optional) copy running-config startup-config Example: <pre>switch(config-if)# copy running-config startup-config</pre>	Saves this configuration change.

Example



Note You should also remove any EIGRP commands configured in interface mode if you remove the EIGRP process.

This example shows how to create an EIGRP process and configure an interface for EIGRP:

```
switch# configure terminal
switch(config)# router eigrp Test1
switch(config-router)# interface ethernet 1/2
switch(config-if)# ip router eigrp Test1
switch(config-if)# no shutdown
switch(config-if)# copy running-config startup-config
```

For more information about other EIGRP parameters, see the [Configuring Advanced EIGRP, on page 224](#) section.

Restarting an EIGRP Instance

You can restart an EIGRP instance. This action clears all neighbors for the instance.

To restart and EIGRP instance and remove all associated neighbors, use the following commands in global configuration mode:

SUMMARY STEPS

1. (Optional) **flush-routes**
2. **restart eigrp instance-tag**

DETAILED STEPS

	Command or Action	Purpose
Step 1	(Optional) flush-routes Example: switch(config)# flush-routes	Flushes all EIGRP routes in the unicast RIB when this EIGRP instance restarts.
Step 2	restart eigrp instance-tag Example: switch(config)# restart eigrp Test1	Restarts the EIGRP instance and removes all neighbors. The instance tag can be any case-sensitive, alphanumeric string up to 20 characters.

Shutting Down an EIGRP Instance

You can gracefully shut down an EIGRP instance. This action removes all routes and adjacencies but preserves the EIGRP configuration.

To disable an EIGRP instance, use the following command in router configuration mode:

SUMMARY STEPS

1. **shutdown**

DETAILED STEPS

	Command or Action	Purpose
Step 1	shutdown Example: switch(config-router)# shutdown	Disables this instance of EIGRP. The EIGRP router configuration remains.

Configuring a Passive Interface for EIGRP

You can configure a passive interface for EIGRP. A passive interface does not participate in EIGRP adjacency, but the network address for the interface remains in the EIGRP topology table.

To configure a passive interface for EIGRP, use the following command in interface configuration mode:

SUMMARY STEPS

1. **{ip | ipv6} passive-interface eigrp instance-tag**

DETAILED STEPS

	Command or Action	Purpose
Step 1	{ip ipv6} passive-interface eigrp instance-tag Example: switch(config-if)# ip passive-interface eigrp tag10	Suppresses EIGRP hellos, which prevents neighbors from forming and sending routing updates on an EIGRP interface. The instance tag can be any case-sensitive, alphanumeric string up to 20 characters.

Shutting Down EIGRP on an Interface

You can gracefully shut down EIGRP on an interface. This action removes all adjacencies and stops EIGRP traffic on this interface but preserves the EIGRP configuration.

To disable EIGRP on an interface, use the following command in interface configuration mode:

SUMMARY STEPS

1. **{ip | ipv6} eigrp instance-tag shutdown**

DETAILED STEPS

	Command or Action	Purpose
Step 1	{ip ipv6} eigrp instance-tag shutdown Example: switch(config-if)# ip eigrp Test1 shutdown	Disables EIGRP on this interface. The EIGRP interface configuration remains. The instance tag can be any case-sensitive, alphanumeric string up to 20 characters.

Configuring Advanced EIGRP

Configuring Authentication in EIGRP

You can configure authentication between neighbors for EIGRP. See the [Authentication](#) section.

You can configure EIGRP authentication for the EIGRP process or for individual interfaces. The interface EIGRP authentication configuration overrides the EIGRP process-level authentication configuration.

Before you begin

You must enable EIGRP (see the [Enabling the EIGRP Feature](#) section).

Ensure that all neighbors for an EIGRP process share the same authentication configuration, including the shared authentication key.

Create the keychain for this authentication configuration. For more information, see the [Cisco Nexus 9000 Series NX-OS Security Configuration Guide](#).

SUMMARY STEPS

1. **configure terminal**
2. **router eigrp** *instance-tag*
3. **address-family** {ipv4 | ipv6} **unicast**
4. **authentication key-chain** *key-chain*
5. **authentication mode md5**
6. **interface** *interface-type slot/port*
7. {ip | ipv6} **router eigrp** *instance-tag*
8. {ip | ipv6} **authentication key-chain eigrp** *instance-tag keychain*
9. {ip | ipv6} **authentication mode eigrp** *instance-tag md5*
10. (Optional) **copy running-config startup-config**

DETAILED STEPS

	Command or Action	Purpose
Step 1	configure terminal Example: <pre>switch# configure terminal switch(config)#</pre>	Enters global configuration mode.
Step 2	router eigrp <i>instance-tag</i> Example: <pre>switch(config)# router eigrp Test1 switch(config-router)#</pre>	<p>Creates a new EIGRP process with the configured instance tag. The instance tag can be any case-sensitive, alphanumeric string up to 20 characters.</p> <p>If you configure an <i>instance-tag</i> that does not qualify as an AS number, you must use the autonomous-system command to configure the AS number explicitly or this EIGRP instance will remain in the shutdown state.</p>

	Command or Action	Purpose
Step 3	address-family {ipv4 ipv6} unicast Example: <pre>switch(config-router)# address-family ipv4 unicast switch(config-router-af)#</pre>	Enters the address-family configuration mode. This command is optional for IPv4.
Step 4	authentication key-chain <i>key-chain</i> Example: <pre>switch(config-router-af)# authentication key-chain routeKeys</pre>	Associates a keychain with this EIGRP process for this VRF. The keychain can be any case-sensitive, alphanumeric string up to 63 characters.
Step 5	authentication mode md5 Example: <pre>switch(config-router-af)# authentication mode md5</pre>	Configures MD5 message digest authentication mode for this VRF.
Step 6	interface <i>interface-type slot/port</i> Example: <pre>switch(config-router-af) interface ethernet 1/2 switch(config-if)#</pre>	Enters interface configuration mode. Use ? to find the supported interfaces.
Step 7	{ip ipv6} router eigrp <i>instance-tag</i> Example: <pre>switch(config-if)# ip router eigrp Test1</pre>	Associates this interface with the configured EIGRP process. The instance tag can be any case-sensitive, alphanumeric string up to 20 characters.
Step 8	{ip ipv6} authentication key-chain eigrp <i>instance-tag</i> <i>keychain</i> Example: <pre>switch(config-if)# ip authentication key-chain eigrp Test1 routeKeys</pre>	<p>Associates a keychain with this EIGRP process for this interface. This configuration overrides the authentication configuration set in the router VRF mode.</p> <p>The instance tag can be any case-sensitive, alphanumeric string up to 20 characters.</p>
Step 9	{ip ipv6} authentication mode eigrp <i>instance-tag</i> md5 Example: <pre>switch(config-if)# ip authentication mode eigrp Test1 md5</pre>	<p>Configures the MD5 message digest authentication mode for this interface. This configuration overrides the authentication configuration set in the router VRF mode.</p> <p>The instance tag can be any case-sensitive, alphanumeric string up to 20 characters.</p>
Step 10	(Optional) copy running-config startup-config Example: <pre>switch(config-if)# copy running-config startup-config</pre>	Saves this configuration change.

Example

This example shows how to configure MD5 message digest authentication for EIGRP over Ethernet interface 1/2:

```
switch# configure terminal
switch(config)# router eigrp Test1
switch(config-router)# exit
switch(config)# interface ethernet 1/2
switch(config-if)# ip router eigrp Test1
switch(config-if)# ip authentication key-chain eigrp Test1 routeKeys
switch(config-if)# ip authentication mode eigrp Test1 md5
switch(config-if)# copy running-config startup-config
```

Configuring EIGRP Stub Routing

You can configure a router for EIGRP stub routing.

To configure a router for EIGRP stub routing, use the following command in address-family configuration mode:

SUMMARY STEPS

1. **stub [direct | receive-only | redistributed [direct] leak-map map-name]**
2. (Optional) **show ip eigrp neighbor detail**

DETAILED STEPS

	Command or Action	Purpose
Step 1	stub [direct receive-only redistributed [direct] leak-map map-name] Example: switch(config-router-af)# eigrp stub redistributed	Configures a remote router as an EIGRP stub router. The map name can be any case-sensitive, alphanumeric string up to 20 characters.
Step 2	(Optional) show ip eigrp neighbor detail Example: switch(config-router-af)# show ip eigrp neighbor detail	Verifies that the router has been configured as a stub router.

Example

This example shows how to configure a stub router to advertise directly connected and redistributed routes:

```
switch# configure terminal
switch(config)# router eigrp Test1
switch(config-router)# address-family ipv6 unicast
switch(config-router-af)# stub direct redistributed
switch(config-router-af)# copy running-config startup-config
```

Use the **show ip eigrp neighbor detail** command to verify that a router has been configured as a stub router. The last line of the output shows the stub status of the remote or spoke router.

This example shows the output from the **show ip eigrp neighbor detail** command:

```
Router# show ip eigrp neighbor detail
IP-EIGRP neighbors for process 201
H Address          Interface          Hold Uptime    SRTT   RTO   Q   Seq Type
                   (sec)            (ms)          (ms)   Cnt Num
0 10.1.1.2          Se3/1              11 00:00:59    1  4500 0   7
  Version 12.1/1.2, Retrans: 2, Retries: 0
  Stub Peer Advertising ( CONNECTED SUMMARY ) Routes
```

Configuring a Summary Address for EIGRP

You can configure a summary aggregate address for a specified interface. If any more specific routes are in the routing table, EIGRP advertises the summary address out the interface with a metric equal to the minimum of all more specific routes. See the [Route Summarization](#) section.

To configure a summary aggregate address, use the following command in interface configuration mode:

SUMMARY STEPS

1. **{ip | ipv6} summary-address eigrp instance-tag ip-prefix/length [distance | leak-map map-name]**

DETAILED STEPS

	Command or Action	Purpose
Step 1	<p>{ip ipv6} summary-address eigrp instance-tag ip-prefix/length [distance leak-map map-name]</p> <p>Example:</p> <pre>switch(config-if)# ip summary-address eigrp Test1 192.0.2.0/8</pre>	<p>Configures a summary aggregate address as an IP prefix/length. The instance tag and map name can be any case-sensitive, alphanumeric string up to 20 characters.</p> <p>You can optionally configure the administrative distance for this aggregate address. The default administrative distance is 5 for aggregate addresses.</p> <p>Note We recommend that you configure the IP address using the <code>prefix/length</code> format instead of <code>address mask</code> unless EIGRP is already running. If you use the <code>address mask</code> format before the EIGRP instance has started, you will be unable to remove or alter the summary address later.</p>

Example

This example shows how to cause EIGRP to summarize network 192.0.2.0 out Ethernet 1/2 only:

```
switch# configure terminal
switch(config)# interface ethernet 1/2
switch(config-if) ip summary-address eigrp Test1 192.0.2.0/24
```

Redistributing Routes into EIGRP

You can redistribute routes in EIGRP from other routing protocols.

Before you begin

You must enable EIGRP (see the [Enabling the EIGRP Feature](#) section).

You must configure the metric (either through the default-metric configuration option or through a route map) for routes redistributed from any other protocol.

You must create a route map to control the types of routes that are redistributed into EIGRP. See [Configuring Route Policy Manager, on page 515](#).

SUMMARY STEPS

1. **configure terminal**
2. **router eigrp *instance-tag***
3. **address-family {*ipv4* | *ipv6*} unicast**
4. **redistribute {*bgp as* | {*eigrp* | *isis* | *ospf* | *ospfv3* | *rip*} *instance-tag* | *direct* | *static*} route-map *map-name***
5. **default-metric *bandwidth delay reliability loading mtu***
6. (Optional) **show {*ip* | *ipv6*} eigrp route-map statistics redistribute**
7. (Optional) **copy running-config startup-config**

DETAILED STEPS

	Command or Action	Purpose
Step 1	configure terminal Example: <pre>switch# configure terminal switch(config)#</pre>	Enters global configuration mode.
Step 2	router eigrp <i>instance-tag</i> Example: <pre>switch(config)# router eigrp Test1 switch(config-router)#</pre>	<p>Creates a new EIGRP process with the configured instance tag. The instance tag can be any case-sensitive, alphanumeric string up to 20 characters.</p> <p>If you configure an <i>instance-tag</i> that does not qualify as an AS number, you must use the autonomous-system command to configure the AS number explicitly or this EIGRP instance will remain in the shutdown state.</p>
Step 3	address-family {<i>ipv4</i> <i>ipv6</i>} unicast Example: <pre>switch(config-router)# address-family ipv4 unicast switch(config-router-af)#</pre>	Enters the address-family configuration mode. This command is optional for IPv4.
Step 4	redistribute {<i>bgp as</i> {<i>eigrp</i> <i>isis</i> <i>ospf</i> <i>ospfv3</i> <i>rip</i>} <i>instance-tag</i> <i>direct</i> <i>static</i>} route-map <i>map-name</i> Example:	Injects routes from one routing domain into EIGRP. The instance tag and map name can be any case-sensitive, alphanumeric string up to 20 characters.

	Command or Action	Purpose
	<code>switch(config-router-af)# redistribute bgp 100 route-map BGPFilter</code>	
Step 5	default-metric <i>bandwidth delay reliability loading mtu</i> Example: <code>switch(config-router-af)# default-metric 500000 30 200 1 1500</code>	Sets the metrics assigned to routes learned through route redistribution. The default values are as follows: <ul style="list-style-type: none"> • bandwidth—100000 Kbps • delay—100 (10 microsecond units) • reliability—255 • loading—1 • MTU—1492
Step 6	(Optional) show {ip ipv6} eigrp route-map statistics redistribute Example: <code>switch(config-router-af)# show ip eigrp route-map statistics redistribute bgp</code>	Displays information about EIGRP route map statistics.
Step 7	(Optional) copy running-config startup-config Example: <code>switch(config-router-af)# copy running-config startup-config</code>	Saves this configuration change.

Example

The following example shows how to redistribute BGP into EIGRP for IPv4:

```
switch# configure terminal
switch(config)# router eigrp Test1
switch(config-router)# redistribute bgp 100 route-map BGPFilter
switch(config-router)# default-metric 500000 30 200 1 1500
switch(config-router)# copy running-config startup-config
```

Limiting the Number of Redistributed Routes

Route redistribution can add many routes to the EIGRP route table. You can configure a maximum limit to the number of routes accepted from external protocols. EIGRP provides the following options to configure redistributed route limits:

- Fixed limit—EIGRP accepts the redistributed routes up to the configured maximum value. By default, EIGRP logs a warning message when a default threshold of 75% is passed and also when maximum limit is reached. You can optionally configure a threshold percentage of the maximum redistributed routes.
- Warning only—Logs a warning message when threshold percentage of set maximum value is passed. However, EIGRP continues to accept the redistributed routes.
- Withdraw—Starts the timeout period when EIGRP reaches the maximum. After the timeout period, EIGRP requests all redistributed routes if the current number of redistributed routes is less than the

maximum limit. If the current number of redistributed routes is at the maximum limit, EIGRP withdraws all redistributed routes. You must clear this condition before EIGRP accepts more redistributed routes. You can optionally configure the timeout period.

- Cisco recommends setting the maximum prefix value to 2 times the expected redistributed routes.
- Route redistribute does not support more than 8 redistribute commands. After configuring 8 commands, the new routes are not added to the routing table or dynamic routing database.



Note This task can be configured only in the IPv4 VRF address family configuration mode.

Before you begin

You must enable EIGRP (see the [Enabling the EIGRP Feature](#) section).

SUMMARY STEPS

1. **configure terminal**
2. **router eigrp** *instance-tag*
3. **redistribute** {**bgp id** | **direct** | **eigrp id** | **isis id** | **ospf id** | **rip id** | **static**} **route-map** *map-name*
4. **redistribute maximum-prefix** *max* [*threshold*] [**warning-only** | **withdraw** [*num-retries* *timeout*]]
5. (Optional) **show running-config eigrp**
6. (Optional) **copy running-config startup-config**

DETAILED STEPS

	Command or Action	Purpose
Step 1	configure terminal Example: switch# configure terminal switch(config)#	Enters global configuration mode.
Step 2	router eigrp <i>instance-tag</i> Example: switch(config)# router eigrp Test1 switch(config-router)#	Creates a new EIGRP instance with the configured instance tag.
Step 3	redistribute { bgp id direct eigrp id isis id ospf id rip id static } route-map <i>map-name</i> Example: switch(config-router)# redistribute bgp route-map FilterExternalBGP	Redistributes the selected protocol into EIGRP through the configured route map.
Step 4	redistribute maximum-prefix <i>max</i> [<i>threshold</i>] [warning-only withdraw [<i>num-retries</i> <i>timeout</i>]] Example:	Specifies a maximum number of prefixes that EIGRP distributes. The range is from 1 to 65535. Optionally specifies the following:

	Command or Action	Purpose
	<pre>switch(config-router)# redistribute maximum-prefix 1000 75 warning-only</pre>	<ul style="list-style-type: none"> • threshold —Percentage of maximum prefixes that triggers a warning message. • warning-only —Logs a warning message when the maximum number of prefixes is exceeded. • withdraw —Withdraws all redistributed routes. Optionally tries to retrieve the redistributed routes. The <i>num-retries</i> range is from 1 to 12. The <i>timeout</i> is from 60 to 600 seconds. The default is 300 seconds. Use the clear ip eigrp redistribution command if all routes are withdrawn. <p>Note In EIGRP topology, it is recommended to set the maximum-prefix value to 2 times the expected redistributed routes.</p>
Step 5	(Optional) show running-config eigrp Example: <pre>switch(config-router)# show running-config eigrp</pre>	Displays the EIGRP configuration.
Step 6	(Optional) copy running-config startup-config Example: <pre>switch(config-router)# copy running-config startup-config</pre>	Saves this configuration change.

Example

This example shows how to limit the number of redistributed routes into EIGRP:

```
switch# configure terminal
switch(config)# router eigrp Test1
switch(config-router)# redistribute bgp route-map FilterExternalBGP
switch(config-router)# redistribute maximum-prefix 1000 75
```

Configuring Load Balancing in EIGRP

You can configure load balancing in EIGRP. You can configure the number of Equal Cost Multiple Path (ECMP) routes using the **maximum-paths** option. See the [Configuring Load Balancing in EIGRP](#) section.

Before you begin

You must enable EIGRP (see the [Enabling the EIGRP Feature](#) section).

SUMMARY STEPS

1. **configure terminal**
2. **router eigrp instance-tag**

3. **address-family {ipv4 | ipv6} unicast**
4. **maximum-paths num-paths**
5. (Optional) **copy running-config startup-config**

DETAILED STEPS

	Command or Action	Purpose
Step 1	configure terminal Example: <pre>switch# configure terminal switch(config)#</pre>	Enters global configuration mode.
Step 2	router eigrp instance-tag Example: <pre>switch(config)# router eigrp Test1 switch(config-router)#</pre>	<p>Creates a new EIGRP process with the configured instance tag. The instance tag can be any case-sensitive, alphanumeric string up to 20 characters.</p> <p>If you configure an <i>instance-tag</i> that does not qualify as an AS number, you must use the autonomous-system command to configure the AS number explicitly or this EIGRP instance will remain in the shutdown state.</p>
Step 3	address-family {ipv4 ipv6} unicast Example: <pre>switch(config-router)# address-family ipv4 unicast switch(config-router-af)#</pre>	Enters the address-family configuration mode. This command is optional for IPv4.
Step 4	maximum-paths num-paths Example: <pre>switch(config-router-af)# maximum-paths 5</pre>	Sets the number of equal cost paths that EIGRP accepts in the route table. The range is from 1 to 32. The default is 8.
Step 5	(Optional) copy running-config startup-config Example: <pre>switch(config-router-af)# copy running-config startup-config</pre>	Saves this configuration change.

Example

This example shows how to configure equal cost load balancing for EIGRP over IPv4 with a maximum of six equal cost paths:

```
switch# configure terminal
switch(config)# router eigrp Test1
switch(config-router)# maximum-paths 6
switch(config-router)# copy running-config startup-config
```

Configuring Graceful Restart for EIGRP

You can configure graceful restart or nonstop forwarding for EIGRP. See the [Graceful Restart and High Availability](#) section.



Note Graceful restart is enabled by default.

Before you begin

You must enable EIGRP (see the [Enabling the EIGRP Feature](#) section).

An NSF-aware router must be up and completely converged with the network before it can assist an NSF-capable router in a graceful restart operation.

Neighboring devices participating in the graceful restart must be NSF aware or NSF capable.

SUMMARY STEPS

1. **configure terminal**
2. **router eigrp** *instance-tag*
3. **address-family** {*ipv4* | *ipv6*} **unicast**
4. **graceful-restart**
5. **timers nsf converge** *seconds*
6. **timers nsf route-hold** *seconds*
7. **timers nsf signal** *seconds*
8. (Optional) **copy running-config startup-config**

DETAILED STEPS

	Command or Action	Purpose
Step 1	configure terminal Example: <pre>switch# configure terminal</pre>	Enters global configuration mode.
Step 2	router eigrp <i>instance-tag</i> Example: <pre>switch(config)# router eigrp Test1 switch(config-router)#</pre>	Creates a new EIGRP process with the configured instance tag. The instance tag can be any case-sensitive, alphanumeric string up to 20 characters. If you configure an <i>instance-tag</i> that does not qualify as an AS number, you must use the autonomous-system command to configure the AS number explicitly or this EIGRP instance remains in the shutdown state.
Step 3	address-family { <i>ipv4</i> <i>ipv6</i> } unicast Example: <pre>switch(config-router)# address-family ipv4 unicast switch(config-router-af)#</pre>	Enters the address-family configuration mode. This command is optional for IPv4.

	Command or Action	Purpose
Step 4	graceful-restart Example: switch(config-router-af)# graceful-restart	Enables graceful restart. This feature is enabled by default.
Step 5	timers nsf converge <i>seconds</i> Example: switch(config-router-af)# timers nsf converge 100	Sets the time limit for the convergence after a switchover. The range is from 60 to 180 seconds. The default is 120.
Step 6	timers nsf route-hold <i>seconds</i> Example: switch(config-router-af)# timers nsf route-hold 200	Sets the hold time for routes learned from the graceful restart-aware peer. The range is from 20 to 300 seconds. The default is 240.
Step 7	timers nsf signal <i>seconds</i> Example: switch(config-router-af)# timers nsf signal 15	Sets the time limit for signaling a graceful restart. The range is from 10 to 30 seconds. The default is 20.
Step 8	(Optional) copy running-config startup-config Example: switch(config-router-af)# copy running-config startup-config	Saves this configuration change.

Example

This example shows how to configure graceful restart for EIGRP over IPv6 using the default timer values:

```
switch# configure terminal
switch(config)# router eigrp Test1
switch(config-router)# address-family ipv6 unicast
switch(config-router-af)# graceful-restart
switch(config-router-af)# copy running-config startup-config
```

Adjusting the Interval Between Hello Packets and the Hold Time

You can adjust the interval between Hello messages and the hold time.

By default, Hello messages are sent every 5 seconds. The hold time is advertised in Hello messages and indicates to neighbors the length of time that they should consider the sender valid. The default hold time is three times the hello interval, or 15 seconds.

On very congested and large networks, the default hold time might not be sufficient time for all routers to receive hello packets from their neighbors. In this case, you might want to increase the hold time. To change the hold time, use the step 2 command in interface configuration mode:

SUMMARY STEPS

1. **{ip | ipv6} hello-interval eigrp instance-tag seconds**
2. **{ip | ipv6} hold-time eigrp instance-tag seconds**

DETAILED STEPS

	Command or Action	Purpose
Step 1	{ip ipv6} hello-interval eigrp instance-tag seconds Example: <pre>switch(config-if)# ip hello-interval eigrp Test1 30</pre>	Configures the hello interval for an EIGRP routing process. The instance tag can be any case-sensitive, alphanumeric string up to 20 characters. The range is from 1 to 65535 seconds. The default is 5.
Step 2	{ip ipv6} hold-time eigrp instance-tag seconds Example: <pre>switch(config-if)# ipv6 hold-time eigrp Test1 30</pre>	Configures the hold time for an EIGRP routing process. The instance tag can be any case-sensitive, alphanumeric string up to 20 characters. The range is from 1 to 65535 seconds.

Example

Use the **show ip eigrp interface detail** command to verify the timer configuration.

Disabling Split Horizon

You can use split horizon to block route information from being advertised by a router out of any interface from which that information originated. Split horizon usually optimizes communications among multiple routing devices, particularly when links are broken.

By default, split horizon is enabled on all interfaces.

To disable split horizon, use the following command in interface configuration mode:

SUMMARY STEPS

1. **no {ip | ipv6} split-horizon eigrp instance-tag**

DETAILED STEPS

	Command or Action	Purpose
Step 1	no {ip ipv6} split-horizon eigrp instance-tag Example: <pre>switch(config-if)# no ip split horizon eigrp Test1</pre>	Disables split horizon.

Enabling Wide Metrics

To enable wide metrics and optionally configure a scaling factor for the RIB, use the following commands in router or address family configuration mode:

SUMMARY STEPS

1. **metrics version 64bit**
2. (Optional) **metrics rib-scale value**

DETAILED STEPS

	Command or Action	Purpose
Step 1	metrics version 64bit Example: switch(config-router)# metrics version 64bit	Enables 64-bit metric values.
Step 2	(Optional) metrics rib-scale value Example: switch(config-router)#	Configures the scaling factor used to convert the 64-bit metric values to 32 bit in the RIB. The range is from 1 to 255. The default value is 128.

Tuning EIGRP

You can configure optional parameters to tune EIGRP for your network.

You can configure the following optional parameters in address-family configuration mode:

SUMMARY STEPS

1. **default-information originate** [**always** | **route-map map-name**]
2. **distance** *internal external*
3. **metric max-hops** *hop-count*
4. **metric weights** *tos k1 k2 k3 k4 k5 k6*
5. **nsf await-redist-proto-convergence**
6. **timers active-time** *{time-limit | disabled}*
7. (Optional) **{ip | ipv6} bandwidth eigrp instance-tag bandwidth**
8. **{ip | ipv6} bandwidth-percent eigrp instance-tag percent**
9. **[no] {ip | ipv6} delay eigrp instance-tag delay**
10. **{ip | ipv6} distribute-list eigrp instance-tag {prefix-list name | route-map map-name} {in | out}**
11. **[no] {ip | ipv6} next-hop-self eigrp instance-tag**
12. **{ip | ipv6} offset-list eigrp instance-tag {prefix-list name | route-map map-name} {in | out} offset**
13. **{ip | ipv6} passive-interface eigrp instance-tag**

DETAILED STEPS

	Command or Action	Purpose
Step 1	default-information originate [always route-map map-name] Example: switch(config-router-af)# default-information originate always	Originates or accepts the default route with prefix 0.0.0.0/0. When a route-map is supplied, the default route is originated only when the route map yields a true condition. The route-map name can be any case-sensitive, alphanumeric string up to 20 characters.

	Command or Action	Purpose
Step 2	distance <i>internal external</i> Example: <pre>switch(config-router-af)# distance 25 100</pre>	Configures the administrative distance for this EIGRP process. The range is from 1 to 255. The <i>internal</i> value sets the distance for routes learned from within the same autonomous system (the default value is 90). The <i>external</i> value sets the distance for routes learned from an external autonomous system (the default value is 170).
Step 3	metric max-hops <i>hop-count</i> Example: <pre>switch(config-router-af)# metric max-hops 70</pre>	Sets the maximum allowed hops for an advertised route. Routes over this maximum are advertised as unreachable. The range is from 1 to 255. The default is 100.
Step 4	metric weights <i>tos k1 k2 k3 k4 k5 k6</i> Example: <pre>switch(config-router-af)# metric weights 0 1 3 2 1 0</pre>	<p>Adjusts the EIGRP metric or K value. EIGRP uses the following formula to determine the total metric to the network:</p> $\text{metric} = [k1 \times \text{bandwidth} + (k2 \times \text{bandwidth}) / (256 - \text{load}) + k3 \times \text{delay} + k6 \times \text{extended attributes}] * [k5 / (\text{reliability} + k4)]$ <p>Default values and ranges are as follows:</p> <ul style="list-style-type: none"> • TOS—0. The range is from 0 to 8. • k1—1. The range is from 0 to 255. • k2—0. The range is from 0 to 255. • k3—1. The range is from 0 to 255. • k4—0. The range is from 0 to 255. • k5—0. The range is from 0 to 255. • k6—0. The range is from 0 to 255.
Step 5	nsf await-redist-proto-convergence Example: <pre>switch(config-router-af)# nsf await-redist-proto-convergence</pre>	<p>Causes EIGRP to wait for the convergence of redistributed protocols before installing its own routes in the Routing Information Base (RIB) during nonstop forwarding (NSF).</p> <p>This command is useful in switchover scenarios when NSF is in progress and you want EIGRP to wait for BGP to converge and install its routes. It prevents EIGRP from installing transient routes and modifying the Forwarding Information Base (FIB) entries before BGP converges and EIGRP finds an alternate path to a destination.</p>

	Command or Action	Purpose
		<p>Note If you use this command when mutual redistribution is configured between EIGRP and BGP (for example, in a PE-CE environment), some traffic loss might occur because the provider-edge (PE) router will not install EIGRP routes into the RIB until BGP routes are available. This behavior delays the routes that the customer-edge (CE) router learns from EIGRP and advertises to the peer PE router.</p>
Step 6	<p>timers active-time <i>{time-limit disabled}</i></p> <p>Example:</p> <pre>switch(config-router-af)# timers active-time 200</pre>	Sets the time the router waits in minutes (after sending a query) before declaring the route to be stuck in the active (SIA) state. The range is from 1 to 65535. The default is 3.
Step 7	<p>(Optional) {ip ipv6} bandwidth eigrp instance-tag bandwidth</p> <p>Example:</p> <pre>switch(config-if)# ip bandwidth eigrp Test1 30000</pre>	Configures the bandwidth metric for EIGRP on an interface. The instance tag can be any case-sensitive, alphanumeric string up to 20 characters. The bandwidth range is from 1 to 2,560,000,000 Kbps.
Step 8	<p>{ip ipv6} bandwidth-percent eigrp instance-tag percent</p> <p>Example:</p> <pre>switch(config-if)# ip bandwidth-percent eigrp Test1 30</pre>	Configures the percentage of bandwidth that EIGRP might use on an interface. The instance tag can be any case-sensitive, alphanumeric string up to 20 characters. The percent range is from 0 to 100. The default is 50.
Step 9	<p>[no] {ip ipv6} delay eigrp instance-tag delay</p> <p>Example:</p> <pre>switch(config-if)# ip delay eigrp Test1 100</pre>	Configures the delay metric for EIGRP on an interface. The instance tag can be any case-sensitive, alphanumeric string up to 20 characters. The delay range is from 1 to 16777215 (in tens of microseconds).
Step 10	<p>{ip ipv6} distribute-list eigrp instance-tag {prefix-list name route-map map-name} {in out}</p> <p>Example:</p> <pre>switch(config-if)# ip distribute-list eigrp Test1 route-map EigrpTest in</pre>	Configures the route filtering policy for EIGRP on this interface. The instance tag, prefix list name, and route-map name can be any case-sensitive, alphanumeric string up to 20 characters.
Step 11	<p>[no] {ip ipv6} next-hop-self eigrp instance-tag</p> <p>Example:</p> <pre>switch(config-if)# ipv6 next-hop-self eigrp Test1</pre>	Configures EIGRP to use the received next-hop address rather than the address for this interface. The default is to use the IP address of this interface for the next-hop address. The instance tag can be any case-sensitive, alphanumeric string up to 20 characters.
Step 12	<p>{ip ipv6} offset-list eigrp instance-tag {prefix-list name route-map map-name} {in out} offset</p> <p>Example:</p>	Adds an offset to incoming and outgoing metrics to routes learned by EIGRP. The instance tag, prefix list name, and route-map name can be any case-sensitive, alphanumeric string up to 20 characters.

	Command or Action	Purpose
	<pre>switch(config-if)# ip offset-list eigrp Test1 prefix-list EigrpList in</pre>	
Step 13	<p>{ip ipv6} passive-interface eigrp instance-tag</p> <p>Example:</p> <pre>switch(config-if)# ip passive-interface eigrp Test1</pre>	Suppresses EIGRP hellos, which prevents neighbors from forming and sending routing updates on an EIGRP interface. The instance tag can be any case-sensitive, alphanumeric string up to 20 characters.

Configuring Virtualization for EIGRP

You can create multiple VRFs and use the same or multiple EIGRP processes in each VRF. You assign an interface to a VRF.



Note Configure all other parameters for an interface after you configure the VRF for an interface. Configuring a VRF for an interface deletes all other configuration for that interface.

Before you begin

You must enable EIGRP (see the [Enabling the EIGRP Feature](#) section).

Create the VRFs.

SUMMARY STEPS

1. **configure terminal**
2. **vrf context** *vrf-name*
3. **router eigrp** *instance-tag*
4. **interface ethernet** *slot/port*
5. **vrf member** *vrf-name*
6. **{ip | ipv6} router eigrp** *instance-tag*
7. **copy running-config startup-config**

DETAILED STEPS

	Command or Action	Purpose
Step 1	<p>configure terminal</p> <p>Example:</p> <pre>switch# configure terminal switch(config)#</pre>	
Step 2	<p>vrf context <i>vrf-name</i></p> <p>Example:</p> <pre>switch(config)# vrf context RemoteOfficeVRF switch(config-vrf)#</pre>	Creates a new VRF and enters VRF configuration mode. The VRF name can be any case-sensitive, alphanumeric string up to 20 characters.

	Command or Action	Purpose
Step 3	router eigrp <i>instance-tag</i> Example: <pre>switch(config-vrf)# router eigrp Test1 switch(config-router)#</pre>	<p>Creates a new EIGRP process with the configured instance tag. The instance tag can be any case-sensitive, alphanumeric string up to 20 characters.</p> <p>If you configure an <i>instance-tag</i> that does not qualify as an AS number, you must use the autonomous-system command to configure the AS number explicitly or this EIGRP instance remains in the shutdown state.</p>
Step 4	interface ethernet <i>slot/port</i> Example: <pre>switch(config)# interface ethernet 1/2 switch(config-if)#</pre>	Enters interface configuration mode. Use ? to find the slot and port ranges.
Step 5	vrf member <i>vrf-name</i> Example: <pre>switch(config-if)# vrf member RemoteOfficeVRF</pre>	Adds this interface to a VRF. The VRF name can be any case-sensitive, alphanumeric string up to 20 characters.
Step 6	{ip ipv6} router eigrp <i>instance-tag</i> Example: <pre>switch(config-if)# ip router eigrp Test1</pre>	Adds this interface to the EIGRP process. The instance tag can be any case-sensitive, alphanumeric string up to 20 characters.
Step 7	copy running-config startup-config Example: <pre>switch(config-if)# copy running-config startup-config</pre>	Saves this configuration change.

Example

This example shows how to create a VRF and add an interface to the VRF:

```
switch# configure terminal
switch(config)# vrf context NewVRF
switch(config-vrf)# router eigrp Test1
switch(config-router)# interface ethernet 1/2
switch(config-if)# ip router eigrp Test1
switch(config-if)# vrf member NewVRF
switch(config-if)# copy running-config startup-config
```

Verifying the EIGRP Configuration

To display the EIGRP configuration information, perform one of the following tasks:

Command	Purpose
show {ip ipv6} eigrp [<i>instance-tag</i>]	Displays a summary of the configured EIGRP processes.

Command	Purpose
show {ip ipv6} eigrp [<i>instance-tag</i>] interfaces [<i>type number</i>] [brief] [detail]	Displays information about all configured EIGRP interfaces.
show {ip ipv6} eigrp <i>instance-tag</i> neighbors [<i>type number</i>] [detail]	Displays information about all the EIGRP neighbors. Use this command to verify the EIGRP neighbor configuration.
show {ip ipv6} eigrp [<i>instance-tag</i>] route [<i>ip-prefix/length</i>] [active] [all-links] [detail-links] [pending] [summary] [zero-successors] [vrf vrf-name]	Displays information about all the EIGRP routes.
show {ip ipv6} eigrp [<i>instance-tag</i>] topology [<i>ip-prefix/length</i>] [active] [all-links] [detail-links] [pending] [summary] [zero-successors] [vrf vrf-name]	Displays information about the EIGRP topology table.
show running-configuration eigrp	Displays the current running EIGRP configuration.

Monitoring EIGRP

To display EIGRP statistics, use the following commands:

Command	Purpose
show {ip ipv6} eigrp [<i>instance-tag</i>] accounting [vrf vrf-name]	Displays accounting statistics for EIGRP.
show {ip ipv6} eigrp [<i>instance-tag</i>] route-map statistics redistribute	Displays redistribution statistics for EIGRP.
show {ip ipv6} eigrp [<i>instance-tag</i>] traffic [vrf vrf-name]	Displays traffic statistics for EIGRP.

Configuration Examples for EIGRP

This example shows how to configure EIGRP:

```
feature eigrp
interface ethernet 1/2
 ip address 192.0.2.55/24
 ip router eigrp Test1
 no shutdown
router eigrp Test1
 router-id 192.0.2.1
```

The following example shows how to use a route map with the **distribute-list** command to filter routes that are dynamically received from (or advertised to) EIGRP peers. The example configures a route map to match an EIGRP external protocol metric route with an allowable deviation of 100, a source protocol of BGP, and an autonomous system number of 45000. When the two match clauses are true, the tag value of the destination routing protocol is set to 5. The route map is used to distribute incoming packets for an EIGRP process.

```
switch(config)# route-map metric-range
switch(config-route-map)# match metric external 500 +- 100

switch(config-route-map)# set tag 5
switch(config-route-map)# exit
switch(config)# router eigrp 1
switch(config-router)# exit
switch(config)# interface ethernet 1/2
switch(config-if)# ip address 172.16.0.0
switch(config-if)# ip router eigrp 1
switch(config-if)# ip distribute-list eigrp 1 route-map metric-range in
```

The following example shows how to use a route map with the redistribute command to allow routes that are redistributed from the routing table to be filtered with a route map before being admitted into an EIGRP topology table. The example shows how to configure a route map to match EIGRP routes with a metric of 110, 200, or an inclusive range of 700 to 800. When the match clause is true, the tag value of the destination routing protocol is set to 10. The route map is used to redistribute EIGRP packets.

```
switch(config)# route-map metric-eigrp
switch(config-route-map)# match metric 110 200 750 +- 50
switch(config-route-map)# set tag 10
switch(config-route-map)# exit
switch(config)# router eigrp 1
switch(config-router)# redistribute eigrp route-map metric-eigrp
switch(config-router)# exit
switch(config)# interface ethernet 1/2
switch(config-if)# ip address 172.16.0.0
switch(config-if)# ip router eigrp 1
```

Related Topics

See [Configuring Route Policy Manager, on page 515](#), for more information on route maps.

Additional References

For additional information related to implementing EIGRP, see the following sections:

Related Documents

Related Topic	Document Title
EIGRP CLI commands	<i>Cisco Nexus 9000 Series NX-OS Unicast Routing Command Reference</i>
<i>Introduction to EIGRP Tech Note</i>	Introduction to EIGRP Tech Note
EIGRP Frequently Asked Questions	EIGRP Frequently Asked Questions

MIBs

MIBs	MIBs Link
MIBs related to EIGRP	To locate and download MIBs, go to the following URL: http://www.cisco.com/public/sw-center/netmgmt/cmtk/mibs.shtml



CHAPTER 9

Configuring IS-IS

This chapter describes how to configure Integrated Intermediate System-to-Intermediate System (IS-IS) on the Cisco NX-OS device.

This chapter includes the following sections:

- [About IS-IS, on page 245](#)
- [IS-IS Authentication, on page 247](#)
- [Mesh Groups, on page 248](#)
- [Overload Bit, on page 248](#)
- [Route Summarization, on page 248](#)
- [Route Redistribution, on page 249](#)
- [Link Prefix Suppression, on page 249](#)
- [Load Balancing, on page 249](#)
- [BFD, on page 249](#)
- [Virtualization Support, on page 250](#)
- [High Availability and Graceful Restart, on page 250](#)
- [Multiple IS-IS Instances, on page 250](#)
- [Prerequisites for IS-IS, on page 250](#)
- [Guidelines and Limitations for IS-IS, on page 251](#)
- [Default Settings, on page 251](#)
- [Configuring IS-IS, on page 252](#)
- [Verifying the IS-IS Configuration, on page 277](#)
- [Monitoring IS-IS, on page 278](#)
- [Configuration Examples for IS-IS, on page 279](#)
- [Related Topics, on page 279](#)

About IS-IS

IS-IS is an Interior Gateway Protocol (IGP) based on Standardization (ISO)/International Engineering Consortium (IEC) 10589. Cisco NX-OS supports Internet Protocol version 4 (IPv4) and IPv6. IS-IS is a dynamic link-state routing protocol that can detect changes in the network topology and calculate loop-free routes to other nodes in the network. Each router maintains a link-state database that describes the state of the network and sends packets on every configured link to discover neighbors. IS-IS floods the link-state information across the network to each neighbor. The router also sends advertisements and updates on the link-state database through all the existing neighbors.

IS-IS Overview

IS-IS sends a hello packet out every configured interface to discover IS-IS neighbor routers. The hello packet contains information, such as the authentication, area, and supported protocols, which the receiving interface uses to determine compatibility with the originating interface. The hello packets are also padded to ensure that IS-IS establishes adjacencies only with interfaces that have matching maximum transmission unit (MTU) settings. Compatible interfaces form adjacencies, which update routing information in the link-state database through link-state update messages (LSPs). By default, the router sends a periodic LSP refresh every 10 minutes and the LSPs remain in the link-state database for 20 minutes (the LSP lifetime). If the router does not receive an LSP refresh before the end of the LSP lifetime, the router deletes the LSP from the database.

The LSP interval must be less than the LSP lifetime or the LSPs time out before they are refreshed.

IS-IS sends periodic hello packets to adjacent routers. If you configure transient mode for hello packets, these hello packets do not include the excess padding used before IS-IS establishes adjacencies. If the MTU value on adjacent routers changes, IS-IS can detect this change and send padded hello packets for a period of time. IS-IS uses this feature to detect mismatched MTU values on adjacent routers. For more information, see the [Configuring the Transient Mode for Hello Padding](#) section.

IS-IS Areas

You can design IS-IS networks as a single area that includes all routers in the network or as multiple areas that connect into a backbone or Level 2 area. Routers in a nonbackbone area are Level 1 routers that establish adjacencies within a local area (intra-area routing). Level 2 area routers establish adjacencies to other Level 2 routers and perform routing between Level 1 areas (inter-area routing). A router can have both Level 1 and Level 2 areas configured. These Level 1/Level 2 routers act as area border routers that route information from the local area to the Level 2 backbone area (see the figure below).

Within a Level 1 area, routers know how to reach all other routers in that area. The Level 2 routers know how to reach other area border routers and other Level 2 routers. Level 1/Level 2 routers straddle the boundary between two areas, routing traffic to and from the Level 2 backbone area. Level1/Level2 routers use the attached (ATT) bit signal Level 1 routers to set a default route to this Level1/Level2 router to connect to the Level 2 area.

In some instances, such as when you have two or more Level1/Level 2 routers in an area, you may want to control which Level1/Level2 router that the Level 1 routers use as the default route to the Level 2 area. You can configure which Level1/Level2 router sets the attached bit. For more information, see the [Configuring the Transient Mode for Hello Padding](#) section.

Each IS-IS instance in Cisco NX-OS supports either a single Level 1 or Level 2 area, or one of each. By default, all IS-IS instances automatically support Level 1 and Level 2 routing.

Figure 26: IS-IS Network Divided into Areas

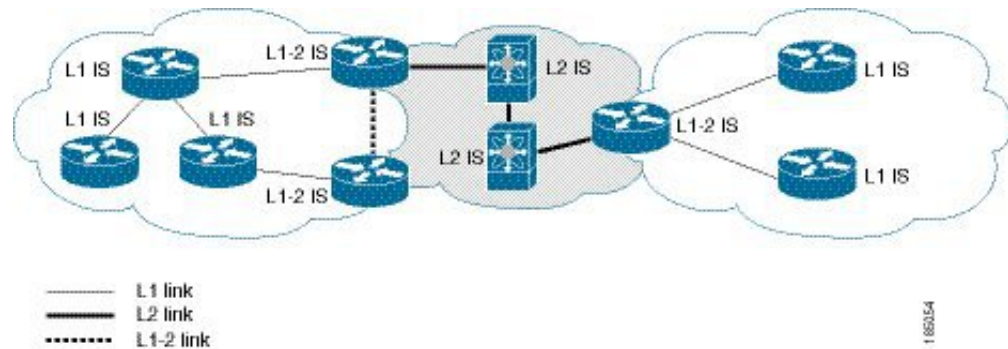

An autonomous system boundary router (ASBR) advertises external destinations throughout the IS-IS autonomous system. External routes are the routes redistributed into IS-IS from any other protocol.

NET and System ID

Each IS-IS instance has an associated network entity title (NET). The NET is comprised of the IS-IS system ID, which uniquely identifies this IS-IS instance in the area and the area ID. For example, if the NET is 47.0004.004d.0001.0001.0c11.1111.00, the system ID is 0000.0c11.1111.00 and the area ID is 47.0004.004d.0001.

Designated Intermediate System

IS-IS uses a designated intermediate system (DIS) in broadcast networks to prevent each router from forming unnecessary links with every other router on the broadcast network. IS-IS routers send LSPs to the DIS, which manages all the link-state information for the broadcast network. You can configure the IS-IS priority that IS-IS uses to select the DIS in an area.



Note No DIS is required on a point-to-point network.

IS-IS Authentication

You can configure authentication to control adjacencies and the exchange of LSPs. Routers that want to become neighbors must exchange the same password for their configured level of authentication. IS-IS blocks a router that does not have the correct password. You can configure IS-IS authentication globally or for an individual interface for Level 1, Level 2, or both Level 1/Level 2 routing.

IS-IS supports the following authentication methods:

- Clear text—All packets exchanged carry a cleartext 128-bit password.
- MD5 digest—All packets exchanged carry a message digest that is based on a 128-bit key.

To provide protection against passive attacks, IS-IS never sends the MD5 secret key as cleartext through the network. In addition, IS-IS includes a sequence number in each packet to protect against replay attacks.

You can use also keychains for hello and LSP authentication. See the [Cisco Nexus 9000 Series NX-OS Security Configuration Guide](#) for information on keychain management.

Mesh Groups

A mesh group is a set of interfaces in which all routers reachable over the interfaces have at least one link to every other router. Many links can fail without isolating one or more routers from the network.

In normal flooding, an interface receives a new LSP and floods the LSP out over all other interfaces on the router. With mesh groups, when an interface that is part of a mesh group receives a new LSP, the interface does not flood the new LSP over the other interfaces that are part of that mesh group.



Note You may want to limit LSPs in certain mesh network topologies to improve network scalability. Limiting LSP floods might also reduce the reliability of the network (in case of failures). For this reason, we recommend that you use mesh groups only if specifically required, and then only after you make a careful network design.

You can also configure mesh groups in block mode for parallel links between routers. In this mode, all LSPs are blocked on that interface in a mesh group after the routers initially exchange their link-state information.

Overload Bit

IS-IS uses the overload bit to tell other routers not to use the local router to forward traffic but to continue routing traffic destined for that local router.

You may want to use the overload bit in these situations:

- The router is in a critical condition.
- Graceful introduction and removal of the router to/from the network.
- Other (administrative or traffic engineering) reasons such as waiting for BGP convergence.

Route Summarization

You can configure a summary aggregate address. Route summarization simplifies route tables by replacing a number of more-specific addresses with an address that represents all the specific addresses. For example, you can replace 10.1.1.0/24, 10.1.2.0/24, and 10.1.3.0/24 with one summary address, 10.1.0.0/16.

If more specific routes are in the routing table, IS-IS advertises the summary address with a metric equal to the minimum metric of the more specific routes.



Note Cisco NX-OS does not support automatic route summarization.

Route Redistribution

You can use IS-IS to redistribute static routes, routes learned by other IS-IS autonomous systems, or routes from other protocols. You must configure a route map with the redistribution to control which routes are passed into IS-IS. A route map allows you to filter routes based on attributes such as the destination, origination protocol, route type, route tag, and so on. For more information, see [Configuring Route Policy Manager, on page 515](#).

Whenever you redistribute routes into an IS-IS routing domain, Cisco NX-OS does not, by default, redistribute the default route into the IS-IS routing domain. You can generate a default route into IS-IS, which can be controlled by a route policy.

You also configure the default metric that is used for all imported routes into IS-IS.

Link Prefix Suppression

By default, IS-IS advertises the addresses of connected interfaces in the system LSP. By suppressing the advertisement of unwanted interface addresses, you can reduce the size of LSPs and reduce the number of routes that IS-IS maintains, improving convergence times.

Two prefix suppression methods are provided for reducing the number of routes in the LSP:

- At the global level, you can choose to advertise only those prefixes that belong to passive interfaces, excluding other connected prefixes. See [Advertising Only Passive Interface Prefixes, on page 268](#).
- At the interface level, you can disable the advertisement of connected prefixes. See [Suppressing Prefixes on an Interface, on page 269](#).

Load Balancing

You can use load balancing to allow a router to distribute traffic over all the router network ports that are the same distance from the destination address. Load balancing increases the utilization of network segments and increases the effective network bandwidth.

Cisco NX-OS supports the Equal Cost Multiple Paths (ECMP) feature with up to 16 equal-cost paths in the IS-IS route table and the unicast RIB. You can configure IS-IS to load balance traffic across some or all of those paths.

BFD

This feature supports bidirectional forwarding detection (BFD) for IPv4 and IPv6. BFD is a detection protocol designed to provide fast forwarding-path failure detection times. BFD provides subsecond failure detection between two adjacent devices and can be less CPU-intensive than protocol hello messages because some of the BFD load can be distributed onto the data plane on supported modules. See the [Cisco Nexus 9000 Series NX-OS Interfaces Configuration Guide](#) for more information.

Virtualization Support

Cisco NX-OS supports multiple process instances for IS-IS. Each IS-IS instance can support multiple virtual routing and forwarding (VRF) instances, up to the system limit. For the number of supported IS-IS instances, see the [Cisco Nexus 9000 Series NX-OS Verified Scalability Guide](#).

High Availability and Graceful Restart

Cisco NX-OS provides a multilevel high-availability architecture. IS-IS supports stateful restart, which is also referred to as non-stop routing (NSR). If IS-IS experiences problems, it attempts to restart from its previous run-time state. The neighbors would not register any neighbor event in this case. If the first restart is not successful and another problem occurs, IS-IS attempts a graceful restart as per RFC 3847. A graceful restart, or non-stop forwarding (NSF), allows IS-IS to remain in the data forwarding path through a process restart. When the restarting IS-IS interface is operational again, it rediscovers its neighbors, establishes adjacency, and starts sending its updates again. At this point, the NSF helps recognize that the graceful restart has finished.

A stateful restart is used in the following scenarios:

- First recovery attempt after process experiences problems
- User-initiated switchover using the **system switchover** command

A graceful restart is used in the following scenarios:

- Second recovery attempt after the process experiences problems within a 4-minute interval
- Manual restart of the process using the **restart isis** command
- Active supervisor removal
- Active supervisor reload using the **reload module active-sup** command



Note Graceful restart is on by default, and we strongly recommend that you do not disable it.

Multiple IS-IS Instances

Cisco NX-OS supports multiple instances of the IS-IS protocol that run on the same node. You cannot configure multiple instances over the same interface. Every instance uses the same system router ID. For the number of supported IS-IS instances, see the [Cisco Nexus 9000 Series NX-OS Verified Scalability Guide](#).

Prerequisites for IS-IS

IS-IS has the following prerequisites:

- You must enable IS-IS (see the [Enabling the IS-IS Feature](#) section).

Guidelines and Limitations for IS-IS

IS-IS has the following configuration guidelines and limitations:

- IS-IS Level-1 routes do not populate on the connecting Level-2-only switch if an explicit configuration is not added to the Level-1/Level-2 Cisco Nexus switch.
- Because the default reference bandwidth is different for Cisco NX-OS and Cisco IOS, the advertised tunnel IS-IS metric is different for these two operating systems.
- You can configure IS-IS over segment routing for all Cisco Nexus 9000 Series switches and the Cisco Nexus 3164Q and 31128PQ switches. For information, see the [Cisco Nexus 9000 Series NX-OS Label Switching Configuration Guide](#).

Default Settings

The table lists the default settings for IS-IS parameters.

Table 21: Default IS-IS Parameters

Parameters	Default
Administrative distance	115
Area level	Level-1-2
DIS priority	64
Graceful restart	Enabled
Hello multiplier	3
Hello padding	Enabled
Hello time	10 seconds
IS-IS feature	Disabled
LSP interval	33
LSP MTU	1492
Maximum LSP lifetime	1200 seconds
Maximum paths	8
Metric	40
Reference bandwidth	40 Gbps

Configuring IS-IS

To configure IS-IS, follow these steps:

1. Enable the IS-IS feature (see the [Enabling the IS-IS Feature](#) section).
2. Create an IS-IS instance (see the [Creating an IS-IS Instance](#) section).
3. Add an interface to the IS-IS instance (see the [Configuring IS-IS on an Interface](#) section).
4. Configure optional features, such as authentication, mesh groups, and dynamic host exchange.



Note If you are familiar with the Cisco IOS CLI, be aware that the Cisco NX-OS commands for this feature might differ from the Cisco IOS commands that you would use.

IS-IS Configuration Modes

The following sections show how to enter each of the configuration modes. You can enter the ? command to display the commands available in that mode.

Router Configuration Mode

This example shows how to enter router configuration mode:

```
switch#: configure terminal  
switch(config)# router isis isp  
switch(config-router)#
```

Router Address Family Configuration Mode

This example shows how to enter router address family configuration mode:

```
switch(config)# router isis isp  
switch(config-router)# address-family ipv4 unicast  
switch(config-router-af)#
```

Enabling the IS-IS Feature

You must enable the IS-IS feature before you can configure IS-IS.

SUMMARY STEPS

1. **configure terminal**
2. **[no] feature isis**
3. (Optional) **show feature**
4. (Optional) **copy running-config startup-config**

DETAILED STEPS

	Command or Action	Purpose
Step 1	configure terminal Example: <pre>switch# configure terminal switch(config)#</pre>	Enters global configuration mode.
Step 2	[no] feature isis Example: <pre>switch(config)# feature isis</pre>	Enables or disables the IS-IS feature. Using the no option with this command disables the IS-IS feature and removes all associated configurations.
Step 3	(Optional) show feature Example: <pre>switch(config)# show feature</pre>	Displays enabled and disabled features.
Step 4	(Optional) copy running-config startup-config Example: <pre>switch(config)# copy running-config startup-config</pre>	Saves this configuration change.

Creating an IS-IS Instance

You can create an IS-IS instance and configure the area level for that instance.

Before you begin

You must enable IS-IS (see the [Enabling the IS-IS Feature](#) section).

SUMMARY STEPS

1. **configure terminal**
2. **[no] router isis** *instance-tag*
3. **net** *network-entity-title*
4. (Optional) **is-type** {*level-1* | *level-2* | *level-1-2*}
5. (Optional) **show isis** [*vrf vrf-name*] **process**
6. (Optional) **distance** *value*
7. (Optional) **log-adjacency-changes**
8. (Optional) **lsp-mtu** *size*
9. (Optional) **maximum-paths** *number*
10. (Optional) **reference-bandwidth** *bandwidth-value* {**Mbps** | **Gbps**}
11. (Optional) **clear isis** [*instance-tag*] **adjacency** [* | *system-id* | *interface*]
12. (Optional) **copy running-config startup-config**

DETAILED STEPS

	Command or Action	Purpose
Step 1	configure terminal Example: switch# configure terminal switch(config)#	Enters global configuration mode.
Step 2	[no] router isis instance-tag Example: switch(config)# router isis Enterprise switch(config-router)#	Creates a new IS-IS instance with the configured instance tag. Use the no form of this command to delete the IS-IS instance and all associated configurations. Note You must also remove any IS-IS commands that are configured in interface mode to completely remove all configurations for the IS-IS instance.
Step 3	net network-entity-title Example: switch(config-router)# net 47.0004.004d.0001.0001.0c11.1111.00	Configures the NET for this IS-IS instance.
Step 4	(Optional) is-type {level-1 level-2 level-1-2} Example: switch(config-router)# is-type level-2	Configures the area level for this IS-IS instance. The default is level-1-2.
Step 5	(Optional) show isis [vrf vrf-name] process Example: switch(config-router)# show isis process	Displays a summary of IS-IS information for all IS-IS instances.
Step 6	(Optional) distance value Example: switch(config-router)# distance 30	Sets the administrative distance for IS-IS. The range is from 1 to 255. The default is 115.
Step 7	(Optional) log-adjacency-changes Example: switch(config-router)# log-adjacency-changes	Sends a system message whenever an IS-IS neighbor changes the state.
Step 8	(Optional) lsp-mtu size Example: switch(config-router)# lsp-mtu 600	Sets the MTU for LSPs in this IS-IS instance. The range is from 128 to 4352 bytes. The default is 1492.
Step 9	(Optional) maximum-paths number Example: switch(config-router)# maximum-paths 6	Configures the maximum number of equal-cost paths that IS-IS maintains in the route table. The range is from 1 to 64. The default is 8.

	Command or Action	Purpose
Step 10	(Optional) reference-bandwidth <i>bandwidth-value</i> {Mbps Gbps} Example: switch(config-router)# reference-bandwidth 100 Gbps	Sets the default reference bandwidth used for calculating the IS-IS cost metric. The range is from 1 to 4000 Gbps. The default is 40 Gbps.
Step 11	(Optional) clear isis [<i>instance-tag</i>] adjacency [* <i>system-id</i> <i>interface</i>] Example: switch(config-router)# clear isis adjacency *	Clears neighbor statistics and removes adjacencies for this IS-IS instance.
Step 12	(Optional) copy running-config startup-config Example: switch(config-router)# copy running-config startup-config	Saves this configuration change.

Example

The following example shows how to create an IS-IS instance in a level 2 area:

```
switch# configure terminal
switch(config)# router isis Enterprise
switch(config-router)# net 47.0004.004d.0001.0001.0c11.1111.00
switch(config-router)# is-type level-2
switch(config-router)# copy running-config startup-config
```

Restarting an IS-IS Instance

You can restart an IS-IS instance. This action clears all neighbors for the instance.

To restart an IS-IS instance and remove all associated neighbors, use the following command:

SUMMARY STEPS

1. **restart isis** *instance-tag*

DETAILED STEPS

	Command or Action	Purpose
Step 1	restart isis <i>instance-tag</i> Example: switch(config)# restart isis Enterprise	Restarts the IS-IS instance and removes all neighbors.

Shutting Down IS-IS

You can shut down the IS-IS instance. This action disables this IS-IS instance and retains the configuration.

To shut down the IS-IS instance, use the following command in router configuration mode:

SUMMARY STEPS

1. **shutdown**

DETAILED STEPS

	Command or Action	Purpose
Step 1	shutdown Example: switch(config-router)# shutdown	Disables the IS-IS instance.

Configuring IS-IS on an Interface

You can add an interface to an IS-IS instance.

Before you begin

You must enable IS-IS (see the [Enabling the IS-IS Feature](#) section).

SUMMARY STEPS

1. **configure terminal**
2. **interface** *interface-type slot/port*
3. (Optional) **medium** {**broadcast** | **p2p**}
4. {**ip** | **ipv6**} **router isis** *instance-tag*
5. (Optional) **show isis** [**vrf** *vrf-name*] [*instance-tag*] **interface** [*interface-type slot/port*]
6. (Optional) **isis circuit-type** {**level-1** | **level-2** | **level-1-2**}
7. (Optional) **isis metric value** {**level-1** | **level-2**}
8. (Optional) **isis passive** {**level-1** | **level-2** | **level-1-2**}
9. (Optional) **copy running-config startup-config**

DETAILED STEPS

	Command or Action	Purpose
Step 1	configure terminal Example: switch# configure terminal switch(config)#	Enters global configuration mode.
Step 2	interface <i>interface-type slot/port</i> Example: switch(config)# interface ethernet 1/2 switch(config-if)#	Enters interface configuration mode.

	Command or Action	Purpose
Step 3	(Optional) medium {broadcast p2p} Example: switch(config-if)# medium p2p	Configures the broadcast or point-to-point mode for the interface. IS-IS inherits this mode.
Step 4	{ip ipv6} router isis instance-tag Example: switch(config-if)# ip router isis Enterprise	Associates this IPv4 or IPv6 interface with an IS-IS instance.
Step 5	(Optional) show isis [vrf vrf-name] [instance-tag] interface [interface-type slot/port] Example: switch(config-if)# show isis Enterprise ethernet 1/2	Displays IS-IS information for an interface.
Step 6	(Optional) isis circuit-type {level-1 level-2 level-1-2} Example: switch(config-if)# isis circuit-type level-2	Sets the type of adjacency that this interface participates in. Use this command only for routers that participate in both Level 1 and Level 2 areas.
Step 7	(Optional) isis metric value {level-1 level-2} Example: switch(config-if)# isis metric 30	Sets the IS-IS metric for this interface. The range is from 1 to 16777214. The default is 10.
Step 8	(Optional) isis passive {level-1 level-2 level-1-2} Example: switch(config-if)# isis passive level-2	Prevents the interface from forming adjacencies but still advertises the prefix associated with the interface.
Step 9	(Optional) copy running-config startup-config Example: switch(config-if)# copy running-config startup-config	Saves this configuration change.

Example

This example shows how to add the Ethernet 1/2 interface to an IS-IS instance:

```
switch# configure terminal
switch(config)# interface ethernet 1/2
switch(config-if)# ip router isis Enterprise
switch(config-if)# copy running-config startup-config
```

Shutting Down IS-IS on an Interface

You can gracefully shut down IS-IS on an interface. This action removes all adjacencies and stops IS-IS traffic on this interface but preserves the IS-IS configuration.

To disable IS-IS on an interface, use the following command in interface configuration mode:

SUMMARY STEPS

1. **isis shutdown**

DETAILED STEPS

	Command or Action	Purpose
Step 1	isis shutdown Example: <code>switch(config-if)# isis shutdown</code>	Disables IS-IS on this interface. The IS-IS interface configuration remains.

Configuring IS-IS Authentication in an Area

You can configure IS-IS to authenticate LSPs in an area.

Before you begin

You must enable IS-IS. See [Enabling the IS-IS Feature](#).

You must configure the keychain in global configuration mode if you reference it from the IS-IS configuration. See "Configuring Keychain Management" in the [Cisco Nexus 9000 Series NX-OS Security Configuration Guide](#).

SUMMARY STEPS

1. **configure terminal**
2. **router isis *instance-tag***
3. **authentication-type {cleartext | md5} {level-1 | level-2}**
4. **authentication key-chain *key* {level-1 | level-2}**
5. (Optional) **authentication-check {level-1 | level-2}**
6. (Optional) **copy running-config startup-config**

DETAILED STEPS

	Command or Action	Purpose
Step 1	configure terminal Example: <code>switch# configure terminal</code> <code>switch(config)#</code>	Enters global configuration mode.
Step 2	router isis <i>instance-tag</i> Example: <code>switch(config)# router isis Enterprise</code> <code>switch(config-router)#</code>	Creates a new IS-IS instance with the configured instance tag.

	Command or Action	Purpose
Step 3	authentication-type {cleartext md5} {level-1 level-2} Example: <pre>switch(config-router)# authentication-type cleartext level-2</pre>	Sets the authentication method used for a Level 1 or Level 2 area as cleartext or as an MD5 authentication digest.
Step 4	authentication key-chain <i>key</i> {level-1 level-2} Example: <pre>switch(config-router)# authentication key-chain ISISKey level-2</pre>	Configures the authentication key that is used for an IS-IS area-level authentication.
Step 5	(Optional) authentication-check {level-1 level-2} Example: <pre>switch(config-router)# authentication-check level-2</pre>	Enables checking the authentication parameters in a received packet.
Step 6	(Optional) copy running-config startup-config Example: <pre>switch(config-router)# copy running-config startup-config</pre>	Saves this configuration change.

Example

This example shows how to configure cleartext authentication on an IS-IS instance:

```
switch# configure terminal
switch(config)# router isis Enterprise
switch(config-router)# authentication-type cleartext level-2
switch(config-router)# authentication key-chain ISISKey level-2
switch(config-router)# copy running-config startup-config
```

Configuring IS-IS Authentication on an Interface

You can configure IS-IS to authenticate Hello packets on an interface.

Before you begin

You must enable IS-IS (see the [Enabling the IS-IS Feature](#) section).

SUMMARY STEPS

1. **configure terminal**
2. **interface** *interface-type slot/port*
3. **isis authentication-type** {cleartext | md5} {level-1 | level-2}
4. **isis authentication key-chain** *key* {level-1 | level-2}
5. (Optional) **isis authentication-check** {level-1 | level-2}
6. (Optional) **copy running-config startup-config**

DETAILED STEPS

	Command or Action	Purpose
Step 1	configure terminal Example: switch# configure terminal switch(config)#	Enters global configuration mode.
Step 2	interface interface-type slot/port Example: switch(config)# interface ethernet 1/2 switch(config-if)#	Enters interface configuration mode.
Step 3	isis authentication-type {cleartext md5} {level-1 level-2} Example: switch(config-if)# isis authentication-type cleartext level-2	Sets the authentication type for IS-IS on this interface as cleartext or as an MD5 authentication digest.
Step 4	isis authentication key-chain key {level-1 level-2} Example: switch(config-if)# isis authentication-key ISISKey level-2	Configures the authentication key used for IS-IS on this interface.
Step 5	(Optional) isis authentication-check {level-1 level-2} Example: switch(config-if)# isis authentication-check	Enables checking the authentication parameters in a received packet.
Step 6	(Optional) copy running-config startup-config Example: switch(config-if)# copy running-config startup-config	Saves this configuration change.

Example

This example shows how to configure cleartext authentication on an IS-IS instance:

```
switch# configure terminal
switch(config)# interface ethernet 1/2
switch(config-if)# isis authentication-type cleartext level-2
switch(config-if)# isis authentication key-chain ISISKey
switch(config-if)# copy running-config startup-config
```

Configuring a Mesh Group

You can add an interface to a mesh group to limit the amount of LSP flooding for interfaces in that mesh group. You can optionally block all LSP flooding on an interface in a mesh group.

To add an interface to a mesh group, use the following command in interface configuration mode:

SUMMARY STEPS

1. **isis mesh-group** {**blocked** | *mesh-id*}

DETAILED STEPS

	Command or Action	Purpose
Step 1	isis mesh-group { blocked <i>mesh-id</i> } Example: switch(config-if)# isis mesh-group 1	Adds this interface to a mesh group. The range is from 1 to 4294967295.

Configuring a Designated Intermediate System

You can configure a router to become the designated intermediate system (DIS) for a multiaccess network by setting the interface priority.

To configure the DIS, use the following command in interface configuration mode:

SUMMARY STEPS

1. **isis priority** *number* {**level-1** | **level-2**}

DETAILED STEPS

	Command or Action	Purpose
Step 1	isis priority <i>number</i> { level-1 level-2 } Example: switch(config-if)# isis priority 100 level-1	Sets the priority for DIS selection. The range is from 0 to 127. The default is 64.

Configuring Dynamic Host Exchange

You can configure IS-IS to map between the system ID and the hostname for a router using dynamic host exchange.

To configure dynamic host exchange, use the following command in router configuration mode:

SUMMARY STEPS

1. **hostname** *dynamic*

DETAILED STEPS

	Command or Action	Purpose
Step 1	hostname dynamic Example: switch(config-router)# hostname dynamic	Enables dynamic host exchange.

Setting the Overload Bit

You can configure the router to signal other routers not to use this router as an intermediate hop in their shortest path first (SPF) calculations. You can optionally configure the overload bit temporarily on startup, until BGP converges.

In addition to setting the overload bit, you might also want to suppress certain types of IP prefix advertisements from LSPs for Level 1 or Level 2 traffic.

To set the overload bit, use the following command in router configuration mode:

SUMMARY STEPS

1. **set-overload-bit** {always | on-startup {seconds | wait-for bgp as-number}} [suppress [interlevel | external]]

DETAILED STEPS

	Command or Action	Purpose
Step 1	set-overload-bit {always on-startup {seconds wait-for bgp as-number}} [suppress [interlevel external]] Example: switch(config-router)# set-overload-bit on-startup 30	Sets the overload bit for IS-IS. The <i>seconds</i> range is from 5 to 86400.

Configuring the Attached Bit

You can configure the attached bit to control which Level 1/Level 2 router that the Level 1 routers use as the default route to the Level 2 area. If you disable setting the attached bit, the Level 1 routers do not use this Level 1/Level 2 router to reach the Level 2 area.

To configure the attached bit for a Level 1/Level 2 router, use the following command in router configuration mode:

SUMMARY STEPS

1. [no] **set-attached-bit**

DETAILED STEPS

	Command or Action	Purpose
Step 1	[no] set-attached-bit Example: <pre>switch(config-router)# no attached-bit</pre>	Configures the Level 1/Level 2 router to set the attached bit. This feature is enabled by default.

Configuring the Transient Mode for Hello Padding

You can configure the transient mode for hello padding to pad hello packets when IS-IS establishes adjacency and remove that padding after IS-IS establishes adjacency.

To configure the mode for hello padding, use the following command in interface configuration mode:

SUMMARY STEPS

1. **[no] isis hello-padding**

DETAILED STEPS

	Command or Action	Purpose
Step 1	[no] isis hello-padding Example: <pre>switch(config-if)# no isis hello-padding</pre>	Pads the hello packet to the full maximum transmission unit (MTU). The default is enabled. Use the no form of this command to configure the transient mode of hello padding.

Configuring a Summary Address

You can create aggregate addresses that are represented in the routing table by a summary address. One summary address can include multiple groups of addresses for a given level. Cisco NX-OS advertises the smallest metric of all the more-specific routes.

Before you begin

You must enable IS-IS (see the [Enabling the IS-IS Feature](#) section).

SUMMARY STEPS

1. **configure terminal**
2. **router isis** *instance-tag*
3. **address-family** {ipv4 | ipv6} **unicast**
4. **summary-address** *ip-prefix/mask-len* {level-1 | level-2 | level-1-2}
5. (Optional) **show isis** [*vrfvrf-name*] {ip | ipv6} **summary-address** *ip-prefix* [**longer-prefixes**]
6. (Optional) **copy running-config startup-config**

DETAILED STEPS

	Command or Action	Purpose
Step 1	configure terminal Example: switch# configure terminal switch(config)#	Enters global configuration mode.
Step 2	router isis instance-tag Example: switch(config)# router isis Enterprise switch(config-router)#	Creates a new IS-IS instance with the configured instance tag.
Step 3	address-family {ipv4 ipv6} unicast Example: switch(config-router)# address-family ipv4 unicast switch(config-router-af)#	Enters address family configuration mode.
Step 4	summary-address ip-prefix/mask-len {level-1 level-2 level-1-2} Example: switch(config-router-af)# summary-address 192.0.2.0/24 level-2	Configures a summary address for an IS-IS area for IPv4 or IPv6 addresses.
Step 5	(Optional) show isis [vrfvrf-name] {ip ipv6} summary-address ip-prefix [longer-prefixes] Example: Example: switch(config-router-af)# show isis ip summary-address	Displays IS-IS IPv4 or IPv6 summary address information.
Step 6	(Optional) copy running-config startup-config Example: switch(config-router-af)# copy running-config startup-config	Saves this configuration change.

Example

This example shows how to configure an IPv4 unicast summary address for IS-IS:

```
switch# configure terminal
switch(config)# router isis Enterprise
switch(config-router)# address-family ipv4 unicast
switch(config-router-af)# summary-address 192.0.2.0/24 level-2
switch(config-router-af)# copy running-config startup-config
```

Configuring Redistribution

You can configure IS-IS to accept routing information from another routing protocol and redistribute that information through the IS-IS network. You can optionally assign a default route for redistributed routes.

Before you begin

You must enable IS-IS (see the [Enabling the IS-IS Feature](#) section).

SUMMARY STEPS

1. **configure terminal**
2. **router isis** *instance-tag*
3. **address-family** {**ipv4** | **ipv6**} **unicast**
4. **redistribute** {**bgp as** | {**eigrp** | **isis** | **ospf** | **ospfv3** | **rip**} *instance-tag* | **static** | **direct**} **route-map** *map-name*
5. (Optional) **default-information originate** [**always**] [**route-map** *map-name*]
6. (Optional) **distribute** {**level-1** | **level-2**} **into** {**level-1** | **level-2**} {**route-map** *route-map* | **all**}
7. (Optional) **show isis** [**vrf vrf-name**] {**ip** | **ipv6**} **route ip-prefix** [*detail* | **longer-prefixes** [**summary** | **detail**]]
8. (Optional) **copy running-config startup-config**

DETAILED STEPS

	Command or Action	Purpose
Step 1	configure terminal Example: <pre>switch# configure terminal switch(config)#</pre>	Enters global configuration mode.
Step 2	router isis <i>instance-tag</i> Example: <pre>switch(config)# router isis Enterprise switch(config-router)#</pre>	Creates a new IS-IS instance with the configured instance tag.
Step 3	address-family { ipv4 ipv6 } unicast Example: <pre>switch(config-router)# address-family ipv4 unicast switch(config-router-af)#</pre>	Enters address family configuration mode.
Step 4	redistribute { bgp as { eigrp isis ospf ospfv3 rip } <i>instance-tag</i> static direct } route-map <i>map-name</i> Example: <pre>switch(config-router-af)# redistribute eigrp 201 route-map ISISmap</pre>	Redistributes routes from other protocols into IS-IS.
Step 5	(Optional) default-information originate [always] [route-map <i>map-name</i>] Example:	Generates a default route into IS-IS.

	Command or Action	Purpose
	<code>switch(config-router-af) # default-information originate always</code>	
Step 6	(Optional) distribute {level-1 level-2} into {level-1 level-2} {route-map route-map all} Example: <code>switch(config-router-af) # distribute level-1 into level-2 all</code>	Redistributes routes from one IS-IS level to the other IS-IS level.
Step 7	(Optional) show isis [vrf vrf-name] {ip ipv6} route ip-prefix [detail longer-prefixes [summary detail]] Example: <code>switch(config-router-af) # show isis ip route</code>	Shows the IS-IS routes.
Step 8	(Optional) copy running-config startup-config Example: <code>switch(config-router-af) # copy running-config startup-config</code>	Saves this configuration change.

Example

This example shows how to redistribute EIGRP into IS-IS:

```
switch# configure terminal
switch(config)# router isis Enterprise
switch(config-router)# address-family ipv4 unicast
switch(config-router-af)# redistribute eigrp 201 route-map ISISmap
switch(config-router-af)# copy running-config startup-config
```

Limiting the Number of Redistributed Routes

Route redistribution can add many routes to the IS-IS route table. You can configure a maximum limit to the number of routes accepted from external protocols. IS-IS provides the following options to configure redistributed route limits:

- **Fixed limit**—Logs a message when IS-IS reaches the configured maximum. IS-IS does not accept any more redistributed routes. You can optionally configure a threshold percentage of the maximum where IS-IS logs a warning when that threshold is passed.
- **Warning only**—Logs a warning only when IS-IS reaches the maximum. IS-IS continues to accept redistributed routes.
- **Withdraw**—Starts the timeout period when IS-IS reaches the maximum. After the timeout period, IS-IS requests all redistributed routes if the current number of redistributed routes is less than the maximum limit. If the current number of redistributed routes is at the maximum limit, IS-IS withdraws all redistributed routes. You must clear this condition before IS-IS accepts more redistributed routes. You can optionally configure the timeout period.

Before you begin

You must enable IS-IS.

SUMMARY STEPS

1. **configure terminal**
2. **router isis** *instance-tag*
3. **redistribute** {*bgp id* | **direct** | *eigrpid* | *isis id* | *ospf id* | *rip id* | **static**} **route-map** *map-name*
4. **redistribute maximum-prefix** *max* [*threshold*] [**warning-only** | **withdraw** [*num-retries* *timeout*]]
5. (Optional) **show running-config isis**
6. (Optional) **copy running-config startup-config**

DETAILED STEPS

	Command or Action	Purpose
Step 1	configure terminal Example: <pre>switch# configure terminal switch(config)#</pre>	Enters global configuration mode.
Step 2	router isis <i>instance-tag</i> Example: <pre>switch(config)# router isis Enterprise switch(config-router)#</pre>	Creates a new IS-IS instance with the configured instance tag.
Step 3	redistribute { <i>bgp id</i> direct <i>eigrpid</i> <i>isis id</i> <i>ospf id</i> <i>rip id</i> static } route-map <i>map-name</i> Example: <pre>switch(config-router)# redistribute bgp route-map FilterExternalBGP</pre>	Redistributes the selected protocol into IS-IS through the configured route map.
Step 4	redistribute maximum-prefix <i>max</i> [<i>threshold</i>] [warning-only withdraw [<i>num-retries</i> <i>timeout</i>]] Example: <pre>switch(config-router)# redistribute maximum-prefix 1000 75 warning-only</pre>	Specifies a maximum number of prefixes that IS-IS distributes. The range is from 1 to 65535. You can optionally specify the following: <ul style="list-style-type: none"> • threshold—Percent of maximum prefixes that triggers a warning message. • warning-only—Logs a warning message when the maximum number of prefixes is exceeded. • withdraw—Withdraws all redistributed routes. You can optionally try to retrieve the redistributed routes. The <i>num-retries</i> range is from 1 to 12. The <i>timeout</i> is 60 to 600 seconds. The default is 300 seconds. Use the clear isis redistribution command if all routes are withdrawn.

	Command or Action	Purpose
Step 5	(Optional) show running-config isis Example: switch(config-router)# show running-config isis	Displays the IS-IS configuration.
Step 6	(Optional) copy running-config startup-config Example: switch(config-router)# copy running-config startup-config	Saves this configuration change.

Example

This example shows how to limit the number of redistributed routes into IS-IS:

```
switch# configure terminal
switch(config)# router isis Enterprise
switch(config-router)# redistribute bgp route-map FilterExternalBGP
switch(config-router)# redistribute maximum-prefix 1000 75
```

Advertising Only Passive Interface Prefixes

You can specify that only prefixes belonging to passive interfaces are advertised in the system link-state packets (LSPs).

Procedure

	Command or Action	Purpose
Step 1	configure terminal Example: switch# configure terminal switch(config)#	Enters global configuration mode.
Step 2	router isis instance-tag Example: switch(config)# router isis 200 switch(config-router)#	Creates a new IS-IS instance with the configured instance tag.
Step 3	address-family {ipv4 ipv6} unicast Example: switch(config-router)# address-family ipv4 unicast switch(config-router-af)#	Enters address family configuration mode.
Step 4	[no] advertise passive-only {level-1 level-2} Example:	Enables the advertisement of only those prefixes that belong to passive interfaces.

	Command or Action	Purpose
	<pre>switch(config-router-af)# advertise passive-only level-1 switch(config-router-af)#</pre>	

Example

This example shows how to enable only the advertising of prefixes belonging to passive interfaces:

```
switch# configure terminal
switch(config)# interface ethernet 1/2
switch(config-if)# address-family ipv4 unicast
switch(config-router-af)# advertise passive-only level-1
```

Suppressing Prefixes on an Interface

You can allow an IS-IS interface to participate in forming adjacencies without advertising connected prefixes in the system link-state packets (LSPs).

Procedure

	Command or Action	Purpose
Step 1	<p>configure terminal</p> <p>Example:</p> <pre>switch# configure terminal switch(config)#</pre>	Enters global configuration mode.
Step 2	<p>interface <i>interface-type slot/port</i></p> <p>Example:</p> <pre>switch(config)# interface ethernet 1/2 switch(config-if)#</pre>	Enters interface configuration mode.
Step 3	<p>[no] isis suppress</p> <p>Example:</p> <pre>switch(config-if)# isis suppress switch(config-if)#</pre>	Disables the advertisement of connected prefixes on the interface.

Example

This example shows how to suppress the advertising of an interface's connected prefixes in the system link-state packets (LSPs):

```
switch# configure terminal
switch(config)# interface ethernet 1/2
switch(config-if)# isis suppress
```

Disabling Strict Adjacency Mode

When both IPv4 and IPv6 address families are enabled, strict adjacency mode is enabled by default. In this mode, the device does not form an adjacency with any router that does not have both address families enabled. You can disable strict adjacency mode using the **no adjacency-check** command.

Before you begin

You must enable IS-IS (see the [Enabling the IS-IS Feature](#) section).

SUMMARY STEPS

1. **configure terminal**
2. **router isis *instance-tag***
3. **address-family ipv4 unicast**
4. **no adjacency-check**
5. **exit**
6. **address-family ipv6 unicast**
7. **no adjacency-check**
8. (Optional) **show running-config isis**
9. (Optional) **copy running-config startup-config**

DETAILED STEPS

	Command or Action	Purpose
Step 1	configure terminal Example: <pre>switch# configure terminal switch(config)#</pre>	Enters global configuration mode.
Step 2	router isis <i>instance-tag</i> Example: <pre>switch(config)# router isis Enterprise switch(config-router)#</pre>	Creates a new IS-IS instance with the configured instance tag.
Step 3	address-family ipv4 unicast Example: <pre>switch(config-router)# address-family ipv4 unicast switch(config-router-af)#</pre>	Enters address family configuration mode.
Step 4	no adjacency-check Example: <pre>switch(config-router-af)# no adjacency-check</pre>	Disables strict adjacency mode for the IPv4 address family.
Step 5	exit Example:	Exits address family configuration mode.

	Command or Action	Purpose
	<pre>switch(config-router-af)# exit switch(config-router)#</pre>	
Step 6	address-family ipv6 unicast Example: <pre>switch(config-router)# address-family ipv6 unicast switch(config-router-af)#</pre>	Enters address family configuration mode.
Step 7	no adjacency-check Example: <pre>switch(config-router-af)# no adjacency-check</pre>	Disables strict adjacency mode for the IPv6 address family.
Step 8	(Optional) show running-config isis Example: <pre>switch(config-router-af)# show running-config isis</pre>	Displays the IS-IS configuration.
Step 9	(Optional) copy running-config startup-config Example: <pre>switch(config-router-af)# copy running-config startup-config</pre>	Saves this configuration change.

Configuring a Graceful Restart

You can configure a graceful restart for IS-IS.

Before you begin

You must enable IS-IS (see the [Enabling the IS-IS Feature](#) section).

SUMMARY STEPS

1. **configure terminal**
2. **router isis *instance-tag***
3. **graceful restart**
4. **graceful-restart t3 manual *time***
5. (Optional) **show running-config isis**
6. (Optional) **copy running-config startup-config**

DETAILED STEPS

	Command or Action	Purpose
Step 1	configure terminal Example:	Enters global configuration mode.

	Command or Action	Purpose
	switch# <code>configure terminal</code> switch(config)#	
Step 2	router isis <i>instance-tag</i> Example: switch(config)# <code>router isis Enterprise</code> switch(config-router)#	Creates a new IS-IS process with the configured name.
Step 3	graceful restart Example: switch(config-router)# <code>graceful-restart</code>	Enables a graceful restart and the graceful restart helper functionality. Enabled by default.
Step 4	graceful-restart t3 manual <i>time</i> Example: switch(config-router)# <code>graceful-restart t3 manual 300</code>	Configures the graceful restart T3 timer. The range is from 30 to 65535 seconds. The default is 60.
Step 5	(Optional) show running-config isis Example: switch(config-router)# <code>show running-config isis</code>	Displays the IS-IS configuration.
Step 6	(Optional) copy running-config startup-config Example: switch(config-router)# <code>copy running-config startup-config</code>	Copies the running configuration to the startup configuration.

Example

This example shows how to enable a graceful restart:

```
switch# configure terminal
switch(config)# router isis Enterprise
switch(config-router)# graceful-restart
switch(config-router)# copy running-config startup-config
```

Configuring Virtualization

You can configure multiple IS-IS instances and multiple VRFs and use the same or multiple IS-IS instances in each VRF. You assign an IS-IS interface to a VRF.

You must configure a NET for the configured VRF.



Note Configure all other parameters for an interface after you configure the VRF for an interface. Configuring a VRF for an interface deletes all the configuration for that interface.

Before you begin

You must enable IS-IS (see the [Enabling the IS-IS Feature](#) section).

SUMMARY STEPS

1. **configure terminal**
2. **vrf context** *vrf-name*
3. **exit**
4. **router isis** *instance-tag*
5. (Optional) **vrf** *vrf-name*
6. **net** *network-entity-title*
7. **exit**
8. **exit**
9. **interface ethernet** *slot/port*
10. **vrf member** *vrf-name*
11. **{ip | ipv6} address** *ip-prefix/length*
12. **{ip | ipv6} router isis** *instance-tag*
13. (Optional) **show isis** [**vrf** *vrf-name*] [*instance-tag*] **interface** [*interface-type slot/port*]
14. (Optional) **copy running-config startup-config**

DETAILED STEPS

	Command or Action	Purpose
Step 1	configure terminal Example: <pre>switch# configure terminal switch(config)#</pre>	Enters global configuration mode.
Step 2	vrf context <i>vrf-name</i> Example: <pre>switch(config)# vrf context RemoteOfficeVRF switch(config-vrf)#</pre>	Creates a new VRF and enters VRF configuration mode.
Step 3	exit Example: <pre>switch(config-vrf)# exit switch(config)#</pre>	Exits VRF configuration mode.
Step 4	router isis <i>instance-tag</i> Example: <pre>switch(config)# router isis Enterprise switch(config-router)#</pre>	Creates a new IS-IS instance with the configured instance tag.
Step 5	(Optional) vrf <i>vrf-name</i> Example:	Enters router VRF configuration mode.

	Command or Action	Purpose
	<pre>switch(config-router)# vrf RemoteOfficeVRF switch(config-router-vrf)#</pre>	
Step 6	<p>net <i>network-entity-title</i></p> <p>Example:</p> <pre>switch(config-router-vrf)# net 47.0004.004d.0001.0001.0c11.1111.00</pre>	Configures the NET for this IS-IS instance.
Step 7	<p>exit</p> <p>Example:</p> <pre>switch(config-router-vrf)# exit switch(config-router)#</pre>	Exits router VRF configuration mode.
Step 8	<p>exit</p> <p>Example:</p> <pre>switch(config-router)# exit switch(config)#</pre>	Exits router configuration mode.
Step 9	<p>interface ethernet <i>slot/port</i></p> <p>Example:</p> <pre>switch(config)# interface ethernet 1/2 switch(config-if)#</pre>	Enters interface configuration mode.
Step 10	<p>vrf member <i>vrf-name</i></p> <p>Example:</p> <pre>switch(config-if)# vrf member RemoteOfficeVRF</pre>	Adds this interface to a VRF.
Step 11	<p>{ip ipv6} address <i>ip-prefix/length</i></p> <p>Example:</p> <pre>switch(config-if)# ip address 192.0.2.1/16</pre>	Configures an IP address for this interface. You must complete this step after you assign this interface to a VRF.
Step 12	<p>{ip ipv6} router isis <i>instance-tag</i></p> <p>Example:</p> <pre>switch(config-if)# ip router isis Enterprise</pre>	Associates this IPv4 or IPv6 interface with an IS-IS instance.
Step 13	<p>(Optional) show isis [vrf <i>vrf-name</i>] [<i>instance-tag</i>] interface [<i>interface-type slot/port</i>]</p> <p>Example:</p> <pre>switch(config-if)# show isis Enterprise ethernet 1/2</pre>	Displays IS-IS information for an interface in a VRF.
Step 14	<p>(Optional) copy running-config startup-config</p> <p>Example:</p>	Saves this configuration change.

	Command or Action	Purpose
	switch(config-if)# copy running-config startup-config	

Example

This example shows how to create a VRF and add an interface to the VRF:

```
switch# configure terminal
switch(config)# vrf context NewVRF
switch(config-vrf)# exit
switch(config)# router isis Enterprise
switch(config-router)# vrf NewVRF
switch(config-router-vrf)# net 47.0004.004d.0001.0001.0c11.1111.00
switch(config-router-vrf)# exit
switch(config-router)# exit
switch(config)# interface ethernet 1/2
switch(config-if)# vrf member NewVRF
switch(config-if)# ip address 192.0.2.1/16
switch(config-if)# ip router isis Enterprise
switch(config-if)# copy running-config startup-config
```

Tuning IS-IS

You can tune IS-IS to match your network requirements.

You can use the following optional commands to tune IS-IS:

SUMMARY STEPS

1. (Optional) **lsp-gen-interval** [level-1 | level-2] *lsp-max-wait* [*lsp-initial-wait* *lsp-second-wait*]
2. (Optional) **max-lsp-lifetime** *lifetime*
3. (Optional) **metric-style transition**
4. (Optional) **spf-interval** [level-1 | level-2] *spf-max-wait* [*spf-initial-wait* *spf-second-wait*]
5. (Optional) **adjacency-check**
6. (Optional) **isis csnp-interval** *seconds* [level-1 | level-2]
7. (Optional) **isis hello-interval** *seconds* [level-1 | level-2]
8. (Optional) **isis hello-multiplier** *num* [level-1 | level-2]
9. (Optional) **isis lsp-interval** *milliseconds*

DETAILED STEPS

	Command or Action	Purpose
Step 1	(Optional) lsp-gen-interval [level-1 level-2] <i>lsp-max-wait</i> [<i>lsp-initial-wait</i> <i>lsp-second-wait</i>] Example: switch(config-router)# lsp-gen-interval level-1 500 500 500	Configures the IS-IS throttle for LSP generation. The optional parameters are as follows: • <i>lsp-max-wait</i> —The maximum wait between the trigger and LSP generation. The range is from 500 to 65535 milliseconds.

	Command or Action	Purpose
		<ul style="list-style-type: none"> • <i>lsp-initial-wait</i>—The initial wait between the trigger and LSP generation. The range is from 50 to 65535 milliseconds. • <i>lsp-second-wait</i>—The second wait used for LSP throttle during backoff. The range is from 50 to 65535 milliseconds.
Step 2	(Optional) max-lsp-lifetime <i>lifetime</i> Example: <pre>switch(config-router)# max-lsp-lifetime 500</pre>	Sets the maximum LSP lifetime in seconds. The range is from 1 to 65535. The default is 1200.
Step 3	(Optional) metric-style transition Example: <pre>switch(config-router)# metric-style transition</pre>	Enables IS-IS to generate and accept both narrow metric-style Type Length Value (TLV) objects and wide metric-style TLV objects. The default is disabled.
Step 4	(Optional) spf-interval [level-1 level-2] <i>spf-max-wait</i> [<i>spf-initial-wait</i> <i>spf-second-wait</i>] Example: <pre>switch(config-router)# spf-interval level-2 500 500 500</pre>	Configures the interval between LSA arrivals. The optional parameters are as follows: <ul style="list-style-type: none"> • <i>lsp-max-wait</i>—The maximum wait between the trigger and SPF computation. The range is from 500 to 65535 milliseconds. • <i>lsp-initial-wait</i>—The initial wait between the trigger and SPF computation. The range is from 50 to 65535 milliseconds. • <i>lsp-second-wait</i>—The second wait used for SPF computation during backoff. The range is from 50 to 65535 milliseconds.
Step 5	(Optional) adjacency-check Example: <pre>switch(config-router-af)# adjacency-check</pre>	Performs an adjacency check to verify that an IS-IS instance forms an adjacency only with a remote IS-IS entity that supports the same address family. This command is enabled by default.
Step 6	(Optional) isis csnp-interval <i>seconds</i> [level-1 level-2] Example: <pre>switch(config-if)# isis csnp-interval 20</pre>	Sets the complete sequence number PDU (CNSP) interval in seconds for IS-IS. The range is from 1 to 65535. The default is 10.
Step 7	(Optional) isis hello-interval <i>seconds</i> [level-1 level-2] Example: <pre>switch(config-if)# isis hello-interval 20</pre>	Sets the hello interval in seconds for IS-IS. The range is from 1 to 65535. The default is 10.
Step 8	(Optional) isis hello-multiplier <i>num</i> [level-1 level-2] Example: <pre>switch(config-if)# isis hello-multiplier 20</pre>	Specifies the number of IS-IS hello packets that a neighbor must miss before the router tears down an adjacency. The range is from 3 to 1000. The default is 3.

	Command or Action	Purpose
Step 9	(Optional) isis lsp-interval <i>milliseconds</i> Example: <pre>switch(config-if)# isis lsp-interval 20</pre>	Sets the interval in milliseconds between LSPs sent on this interface during flooding. The range is from 10 to 65535. The default is 33.

Verifying the IS-IS Configuration

To display the IS-IS configuration, perform one of the following tasks:

Command	Purpose
show isis [<i>instance-tag</i>] adjacency [<i>interface</i>] [detail summary] [vrf <i>vrf-name</i>]	Displays the IS-IS adjacencies. Use the clear isis adjacency command to clear these statistics. Note If the hostname is less than 14 characters, the show isis adjacency command displays the hostname. Otherwise, the System ID is displayed.
show isis [<i>instance-tag</i>] database [level-1 level-2] [detail summary] [<i>lsp-id</i>] [{ ip ipv6 } prefix <i>ip-prefix</i>] [router-id <i>router-id</i>] [adjacency <i>node-id</i>] [zero-sequence]; [vrf <i>vrf-name</i>]	Displays the IS-IS LSP database.
show isis [<i>instance-tag</i>] hostname [vrf <i>vrf-name</i>]	Displays the dynamic host exchange information.
show isis [<i>instance-tag</i>] interface [brief <i>interface</i>] [level-1 level-2] [vrf <i>vrf-name</i>]	Displays the IS-IS interface information.
show isis [<i>instance-tag</i>] mesh-group [<i>mesh-id</i>] [vrf <i>vrf-name</i>]	Displays the mesh group information.
show isis [<i>instance-tag</i>] protocol [vrf <i>vrf-name</i>]	Displays information about the IS-IS protocol.
show isis [<i>instance-tag</i>] { ip ipv6 } redistribute route [<i>ip-address</i> summary] [<i>ip-prefix</i>] [longer-prefixes [summary]] [vrf <i>vrf-name</i>]	Displays the IS-IS route redistribution information.
show isis [<i>instance-tag</i>] { ip ipv6 } route [<i>ip-address</i> summary] [<i>ip-prefix</i>] [longer-prefixes [summary]] [detail] [vrf <i>vrf-name</i>]	Displays the IS-IS route table.
show isis [<i>instance-tag</i>] rrm [<i>interface</i>] [vrf <i>vrf-name</i>]	Displays the IS-IS interface retransmission information.
show isis [<i>instance-tag</i>] srm [<i>interface</i>] [vrf <i>vrf-name</i>]	Displays the IS-IS interface flooding information.
show isis [<i>instance-tag</i>] ssn [<i>interface</i>] [vrf <i>vrf-name</i>]	Displays the IS-IS interface PSNP information.

Command	Purpose
show isis [<i>instance-tag</i>] { ip ipv6 } summary-address [<i>ip-address</i>] [<i>ip-prefix</i>] [vrf vrf-name]	Displays the IS-IS summary address information.
show running-configuration isis	Displays the current running IS-IS configuration.
show tech-support isis [detail]	Displays the technical support details for IS-IS.

Monitoring IS-IS

To display IS-IS statistics, use the following commands:

Command	Purpose
show isis [<i>instance-tag</i>] adjacency [<i>interface</i>] [system-ID] [detail] [summary] [vrf vrf-name]	Displays the IS-IS adjacency statistics.
show isis [<i>instance-tag</i>] database [level-1 level-2] [detail] summary] [<i>lsip</i>] {{ adjacency id { ip ipv6 } prefix prefix } [router-id id] [<i>zero-sequence</i>]} [vrf vrf-name]	Displays the IS-IS database statistics.
show isis [<i>instance-tag</i>] statistics [<i>interface</i>] [vrf vrf-name]	Displays the IS-IS interface statistics.
show isis { ip ipv6 } route-map statistics redistribute { bgp id eigrp id isis id ospf id rip id static } [vrf vrf-name]	Displays the IS-IS redistribution statistics.
show isis ip route-map statistics distribute { level-1 level-2 } into { level-1 level-2 } [vrf vrf-name]	Displays IS-IS distribution statistics for routes distributed between levels.
show isis [<i>instance-tag</i>] spf-log [detail] [vrf vrf-name]	Displays the IS-IS SPF calculation statistics.
show isis [<i>instance-tag</i>] traffic [<i>interface</i>] [vrf vrf-name]	Displays the IS-IS traffic statistics.

To clear IS-IS configuration statistics, perform one of the following tasks:

Command	Purpose
clear isis [<i>instance-tag</i>] adjacency [* [<i>interface</i>] [<i>system-id id</i>]] [vrf vrf-name]	Clears the IS-IS adjacency statistics.
clear isis { ip ipv6 } route map statistics redistribute { bgp id direct eigrp id isis id ospf id rip id static } [vrf vrf-name]	Clears the IS-IS redistribution statistics
clear isis route-map statistics distribute { level-1 level-2 } into { level-1 level-2 } [vrf vrf-name]	Clears IS-IS distribution statistics for routes distributed between levels.

Command	Purpose
<code>clear isis [instance-tag] statistics [* interface] [vrf vrf-name]</code>	Clears the IS-IS interface statistics.
<code>clear isis [instance-tag] traffic [* interface] [vrf vrf-name]</code>	Clears the IS-IS traffic statistics.

Configuration Examples for IS-IS

This example shows how to configure IS-IS:

```
router isis Enterprise
 is-type level-1
 net 49.0001.0000.0000.0003.00
 graceful-restart
 address-family ipv4 unicast
  default-information originate

interface ethernet 2/1
 ip address 192.0.2.1/24
 isis circuit-type level-1
 ip router isis Enterprise
```

Related Topics

See the [Configuring Route Policy Manager, on page 515](#) for more information on route maps.



CHAPTER 10

Configuring Basic BGP

This chapter describes how to configure Border Gateway Protocol (BGP) on the Cisco NX-OS device.

This chapter includes the following sections:

- [About Basic BGP, on page 281](#)
- [Prerequisites for BGP, on page 293](#)
- [Guidelines and Limitations for Basic BGP, on page 293](#)
- [Default Settings, on page 295](#)
- [CLI Configuration Modes, on page 295](#)
- [Configuring Basic BGP, on page 297](#)
- [Verifying the Basic BGP Configuration, on page 311](#)
- [Monitoring BGP Statistics, on page 313](#)
- [Configuration Examples for Basic BGP, on page 314](#)
- [Related Topics, on page 314](#)
- [Where to Go Next, on page 314](#)
- [Additional References, on page 314](#)

About Basic BGP

Cisco NX-OS supports BGP version 4, which includes multiprotocol extensions that allow BGP to carry routing information for IP multicast routes and multiple Layer 3 protocol address families. BGP uses TCP as a reliable transport protocol to create TCP sessions with other BGP-enabled devices.

BGP uses a path-vector routing algorithm to exchange routing information between BGP-enabled networking devices or BGP speakers. Based on this information, each BGP speaker determines a path to reach a particular destination while detecting and avoiding paths with routing loops. The routing information includes the actual route prefix for a destination, the path of autonomous systems to the destination, and other path attributes.

BGP selects a single path, by default, as the best path to a destination host or network. Each path carries well-known mandatory, well-known discretionary, and optional transitive attributes that are used in BGP best-path analysis. You can influence BGP path selection by altering some of these attributes by configuring BGP policies. See the [Route Policies and Resetting BGP Sessions, on page 317](#) section for more information.

BGP also supports load balancing or equal-cost multipath (ECMP). See the [Load Sharing and Multipath](#) section for more information.

BGP Autonomous Systems

An autonomous system (AS) is a network controlled by a single administration entity. An autonomous system forms a routing domain with one or more interior gateway protocols (IGPs) and a consistent set of routing policies. BGP supports 16-bit and 32-bit autonomous system numbers. For more information, see the [Autonomous Systems](#) section.

Separate BGP autonomous systems dynamically exchange routing information through external BGP (eBGP) peering sessions. BGP speakers within the same autonomous system can exchange routing information through internal BGP (iBGP) peering sessions.

4-Byte AS Number Support

BGP supports 2-byte autonomous system (AS) numbers in plain-text notation or as.dot notation and 4-byte AS numbers in plain-text notation.

When BGP is configured with a 4-byte AS number, the **route-target auto VXLAN** command cannot be used because the AS number along with the VNI (which is already a 3-byte value) is used to generate the route target. For more information, see the [Cisco Nexus 9000 Series NX-OS VXLAN Configuration Guide](#).

Administrative Distance

An administrative distance is a rating of the trustworthiness of a routing information source. By default, BGP uses the administrative distances shown in the table.

Table 22: BGP Default Administrative Distances

Distance	Default Value	Function
External	20	Applied to routes learned from eBGP.
Internal	200	Applied to routes learned from iBGP.
Local	220	Applied to routes originated by the router.



Note The administrative distance does not influence the BGP path selection algorithm, but it does influence whether BGP-learned routes are installed in the IP routing table.

For more information, see the [Administrative Distance](#) section.

BGP Peers

A BGP speaker does not discover another BGP speaker automatically. You must configure the relationships between BGP speakers. A BGP peer is a BGP speaker that has an active TCP connection to another BGP speaker.

BGP Sessions

BGP uses TCP port 179 to create a TCP session with a peer. When a TCP connection is established between peers, each BGP peer initially exchanges all of its routes—the complete BGP routing table—with the other

peer. After this initial exchange, the BGP peers send only incremental updates when a topology change occurs in the network or when a routing policy change occurs. In the periods of inactivity between these updates, peers exchange special messages called keepalives. The hold time is the maximum time limit that can elapse between receiving consecutive BGP update or keepalive messages.

Cisco NX-OS supports the following peer configuration options:

- Individual IPv4 or IPv6 address—BGP establishes a session with the BGP speaker that matches the remote address and AS number.
- IPv4 or IPv6 prefix peers for a single AS number—BGP establishes sessions with BGP speakers that match the prefix and the AS number.
- Dynamic AS number prefix peers—BGP establishes sessions with BGP speakers that match the prefix and an AS number from a list of configured AS numbers.

Dynamic AS Numbers for Prefix Peers and Interface Peers

Cisco NX-OS accepts a range or list of AS numbers to establish BGP sessions. For example, if you configure BGP to use IPv4 prefix 192.0.2.0/8 and AS numbers 33, 66, and 99, BGP establishes a session with 192.0.2.1 with AS number 66 but rejects a session from 192.0.2.2 with AS number 50.

Beginning with Cisco NX-OS Release 9.3(6), support for dynamic AS numbers is extended to interface peers in addition to prefix peers. See [Configuring BGP Interface Peering via IPv6 Link-Local for IPv4 and IPv6 Address Families, on page 343](#).

Cisco NX-OS does not associate prefix peers with dynamic AS numbers as either interior BGP (iBGP) or external BGP (eBGP) sessions until after the session is established. See [Configuring Advanced BGP, on page 315](#) for more information on iBGP and eBGP.



Note The dynamic AS number prefix peer configuration overrides the individual AS number configuration that is inherited from a BGP template. For more information, see [Configuring Advanced BGP, on page 315](#).

BGP Router Identifier

To establish BGP sessions between peers, BGP must have a router ID, which is sent to BGP peers in the OPEN message when a BGP session is established. The BGP router ID is a 32-bit value that is often represented by an IPv4 address. You can configure the router ID. By default, Cisco NX-OS sets the router ID to the IPv4 address of a loopback interface on the router. If no loopback interface is configured on the router, the software chooses the highest IPv4 address configured to a physical interface on the router to represent the BGP router ID. The BGP router ID must be unique to the BGP peers in a network.

If BGP does not have a router ID, it cannot establish any peering sessions with BGP peers.

Each routing process has an associated router ID. You can configure the router ID to any interface in the system. If you do not configure the router ID, Cisco NX-OS selects the router ID based on the following criteria:

- Cisco NX-OS prefers loopback0 over any other interface. If loopback0 does not exist, then Cisco NX-OS prefers the first loopback interface over any other interface type.
- If you have not configured a loopback interface, Cisco NX-OS uses the first interface in the configuration file as the router ID. If you configure any loopback interface after Cisco NX-OS selects the router ID,

the loopback interface becomes the router ID. If the loopback interface is not loopback0 and you configure loopback0 with an IP address, the router ID changes to the IP address of loopback0.

- If the interface that the router ID is based on changes, that new IP address becomes the router ID. If any other interface changes its IP address, there is no router ID change.

BGP Path Selection

BGP supports sending and receiving multiple paths per prefix and advertising such paths. For information on configuring additional BGP paths, see [Configuring Advanced BGP, on page 315](#).

The best-path algorithm runs each time that a path is added or withdrawn for a given network. The best-path algorithm also runs if you change the BGP configuration. BGP selects the best path from the set of valid paths available for a given network.

Cisco NX-OS implements the BGP best-path algorithm in the following steps:

1. Compares two paths to determine which is better (see the Step 1—[BGP Path Selection - Comparing Pairs of Paths](#) section).
2. Explores all paths and determines in which order to compare the paths to select the overall best path (see the “Step 2—[BGP Path Selection - Determining the Order of Comparisons](#)” section).
3. Determines whether the old and new best paths differ enough so that the new best path should be used (see the “Step 3—[BGP Path Selection - Determining the Best-Path Change Suppression](#)” section).



Note The order of comparison determined in Part 2 is important. Consider the case where you have three paths, A, B, and C. When Cisco NX-OS compares A and B, it chooses A. When Cisco NX-OS compares B and C, it chooses B. But when Cisco NX-OS compares A and C, it might not choose A because some BGP metrics apply only among paths from the same neighboring autonomous system and not among all paths.

The path selection uses the BGP AS-path attribute. The AS-path attribute includes the list of autonomous system numbers (AS numbers) traversed in the advertised path. If you subdivide your BGP autonomous system into a collection or confederation of autonomous systems, the AS-path contains confederation segments that list these locally defined autonomous systems.



Note VXLAN deployments use a BGP path selection process that differs from the normal selection of local over remote paths. For the EVPN address family, BGP compares the sequence number in the MAC Mobility attribute (if present) and selects the path with the higher sequence number. If both paths being compared have the attribute and the sequence numbers are the same, BGP prefers the path that is learned from the remote peer over a locally originated path. For more information, see the [Cisco Nexus 9000 Series NX-OS VXLAN Configuration Guide](#).

BGP Path Selection - Comparing Pairs of Paths

This first step in the BGP best-path algorithm compares two paths to determine which path is better. The following sequence describes the basic steps that Cisco NX-OS uses to compare two paths to determine the better path:

1. Cisco NX-OS chooses a valid path for comparison. (For example, a path that has an unreachable next hop is not valid.)
2. Cisco NX-OS chooses the path with the highest weight.
3. Cisco NX-OS chooses the path with the highest local preference.
4. If one of the paths is locally originated, Cisco NX-OS chooses that path.
5. Cisco NX-OS chooses the path with the shorter AS path.



Note When calculating the length of the AS-path, Cisco NX-OS ignores confederation segments and counts AS sets as 1. See the [AS Confederations](#) section for more information.

6. Cisco NX-OS chooses the path with the lower origin. Interior Gateway Protocol (IGP) is considered lower than EGP.
7. Cisco NX-OS chooses the path with the lower multiexit discriminator (MED).

You can configure Cisco NX-OS to always perform the best-path algorithm MED comparison, regardless of the peer autonomous system in the paths. See the [Tuning the Best-Path Algorithm](#) section for more information. Otherwise, Cisco NX-OS performs a MED comparison that depends on the AS-path attributes of the two paths being compared:

You can configure Cisco NX-OS to always perform the best-path algorithm MED comparison, regardless of the peer autonomous system in the paths. Otherwise, Cisco NX-OS performs a MED comparison that depends on the AS-path attributes of the two paths being compared:

- a. If a path has no AS-path or the AS-path starts with an AS_SET, the path is internal and Cisco NX-OS compares the MED to other internal paths.
- b. If the AS-path starts with an AS_SEQUENCE, the peer autonomous system is the first AS number in the sequence and Cisco NX-OS compares the MED to other paths that have the same peer autonomous system.
- c. If the AS-path contains only confederation segments or starts with confederation segments followed by an AS_SET, the path is internal and Cisco NX-OS compares the MED to other internal paths.
- d. If the AS-path starts with confederation segments that are followed by an AS_SEQUENCE, the peer autonomous system is the first AS number in the AS_SEQUENCE and Cisco NX-OS compares the MED to other paths that have the same peer autonomous system.



Note If Cisco NX-OS receives no MED attribute with the path, Cisco NX-OS considers the MED to be 0 unless you configure the best-path algorithm to set a missing MED to the highest possible value. See the [Tuning the Best-Path Algorithm](#) section for more information.

- e. If the non-deterministic MED comparison feature is enabled, the best-path algorithm uses the Cisco IOS style of MED comparison.
8. If one path is from an internal peer and the other path is from an external peer, Cisco NX-OS chooses the path from the external peer.

9. If the paths have different IGP metrics to their next-hop addresses, Cisco NX-OS chooses the path with the lower IGP metric.
10. Cisco NX-OS uses the path that was selected by the best-path algorithm the last time that it was run.

If all path parameters in Step 1 through Step 9 are the same, you can configure the best-path algorithm to enforce comparison of the router IDs when both paths are eBGP by configuring “compare router-id”. In all other cases, the router-id comparison is done by default.

See the [Tuning the Best-Path Algorithm](#) section for more information. If the path includes an originator attribute, Cisco NX-OS uses that attribute as the router ID to compare to; otherwise, Cisco NX-OS uses the router ID of the peer that sent the path. If the paths have different router IDs, Cisco NX-OS chooses the path with the lower router ID.



Note When using the attribute originator as the router ID, it is possible that two paths have the same router ID. It is also possible to have two BGP sessions with the same peer router, so you could receive two paths with the same router ID.

11. Cisco NX-OS selects the path with the shorter cluster length. If a path was not received with a cluster list attribute, the cluster length is 0.
12. Cisco NX-OS chooses the path received from the peer with the lower IP address. Locally generated paths (for example, redistributed paths) have a peer IP address of 0.



Note Paths that are equal after Step 9 can be used for multipath if you configure multipath. See the [Load Sharing and Multipath](#) section for more information.

BGP Path Selection - Determining the Order of Comparisons

The second step of the BGP best-path algorithm implementation is to determine the order in which Cisco NX-OS compares the paths:

1. Cisco NX-OS partitions the paths into groups. Within each group, Cisco NX-OS compares the MED among all paths. Cisco NX-OS uses the same rules as in the [BGP Path Selection - Comparing Pairs of Paths](#) section to determine whether MED can be compared between any two paths. Typically, this comparison results in one group being chosen for each neighbor autonomous system. If you configure the **bgp bestpath med always** command, Cisco NX-OS chooses just one group that contains all the paths.
2. Cisco NX-OS determines the best path in each group by iterating through all paths in the group and keeping track of the best one so far. Cisco NX-OS compares each path with the temporary best path found so far and if the new path is better, it becomes the new temporary best path and Cisco NX-OS compares it with the next path in the group.
3. Cisco NX-OS forms a set of paths that contain the best path selected from each group in Step 2. Cisco NX-OS selects the overall best path from this set of paths by going through them as in Step 2.

BGP Path Selection - Determining the Best-Path Change Suppression

The next part of the implementation is to determine whether Cisco NX-OS uses the new best path or suppresses the new best path. The router can continue to use the existing best path if the new one is identical to the old path (if the router ID is the same). Cisco NX-OS continues to use the existing best path to avoid route changes in the network.

You can turn off the suppression feature by configuring the best-path algorithm to compare the router IDs. See the [Tuning the Best-Path Algorithm](#) section for more information. If you configure this feature, the new best path is always preferred to the existing one.

You cannot suppress the best-path change if any of the following conditions occur:

- The existing best path is no longer valid.
- Either the existing or new best paths were received from internal (or confederation) peers or were locally generated (for example, by redistribution).
- The paths were received from the same peer (the paths have the same router ID).
- The paths have different weights, local preferences, origins, or IGP metrics to their next-hop addresses.
- The paths have different MEDs.

BGP and the Unicast RIB

BGP communicates with the unicast routing information base (unicast RIB) to store IPv4 routes in the unicast routing table. After selecting the best path, if BGP determines that the best path change needs to be reflected in the routing table, it sends a route update to the unicast RIB.

BGP receives route notifications regarding changes to its routes in the unicast RIB. It also receives route notifications about other protocol routes to support redistribution.

BGP also receives notifications from the unicast RIB regarding next-hop changes. BGP uses these notifications to keep track of the reachability and IGP metric to the next-hop addresses.

Whenever the next-hop reachability or IGP metrics in the unicast RIB change, BGP triggers a best-path recalculation for affected routes.

BGP communicates with the IPv6 unicast RIB to perform these operations for IPv6 routes.

BGP Prefix Independent Convergence

The BGP prefix independent convergence (PIC) edge feature achieves faster convergence in the forwarding plane for BGP IP routes to a BGP backup path when there is a link failure.

The BGP PIC edge feature improves BGP convergence after a network failure. This convergence applies to edge failures in an IP network. This feature creates and stores a backup path in the routing information base (RIB) and forwarding information base (FIB) so that when the primary path fails, the backup path can immediately take over, enabling fast failover in the forwarding plane. BGP PIC edge supports only IPv4 address families.

When BGP PIC edge is configured, BGP calculates a second-best path (the backup path) along with the primary best path. BGP installs both best and backup paths for the prefixes with PIC support into the BGP RIB. BGP also downloads the backup path along with the remote next hop through APIs to the URIB, which

then updates the FIB with the next hop marked as a backup. The backup path provides a fast reroute mechanism to counter a singular network failure.

This feature detects both local interface failures and remote interface or link failures and triggers the use of the backup path

BGP PIC edge supports both unipath and multipath.

BGP PIC Edge Unipath

The following figure shows a BGP PIC edge unipath topology.

Figure 27: BGP PIC Edge Unipath

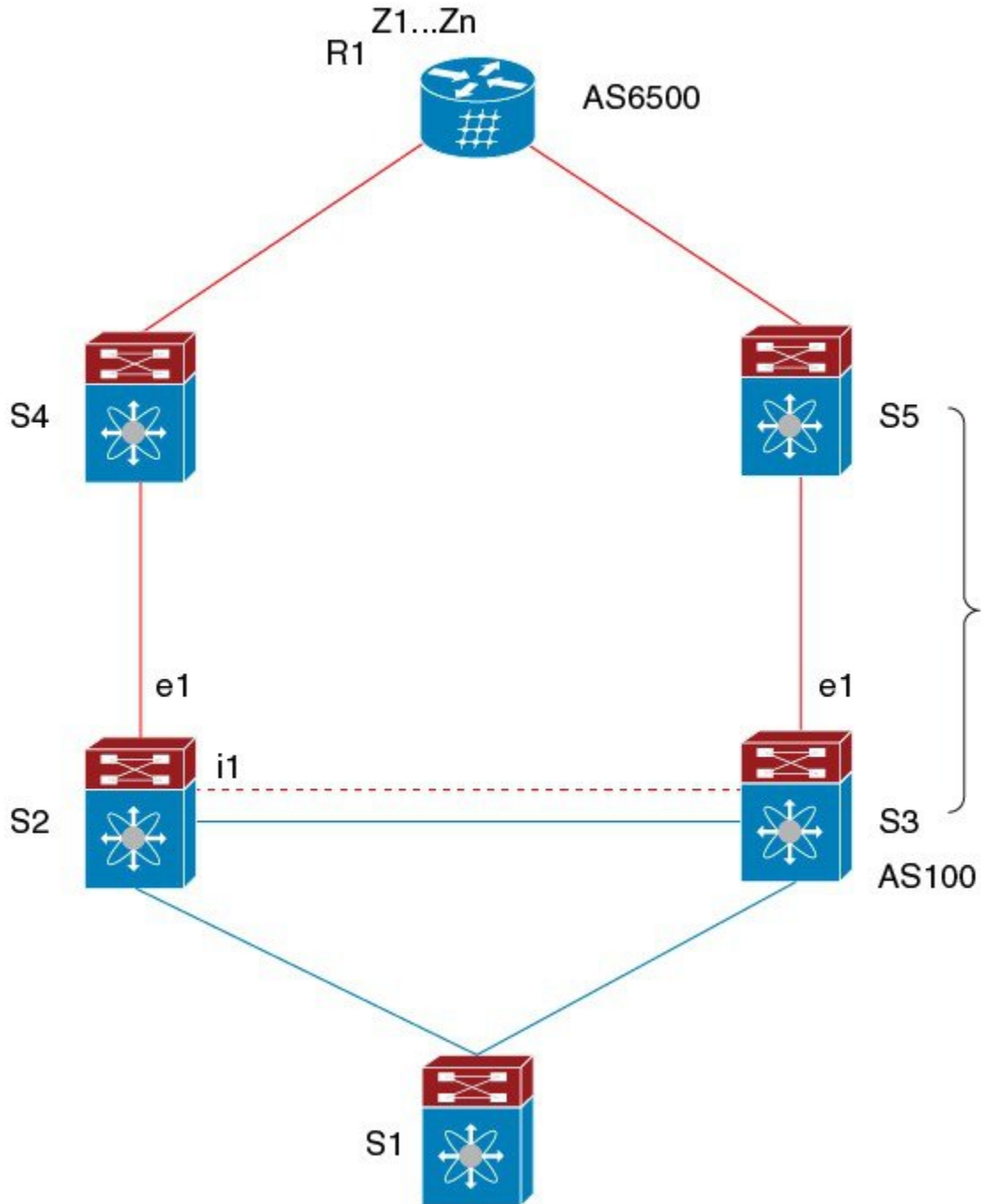

353580

In this figure:

- eBGP sessions are between S2-S4 and S3-S5.
- The iBGP session is between S2-S3.

- Traffic from S1 uses S2 and uses the e1 interface to reach prefixes Z1...Zn.
- S2 has two paths to reach Z1...Zn:
 - A primary path through S4
 - A backup path through S5

In this example, S3 advertises to S2 the prefixes Z1...Zn to reach (with itself as the next hop). With BGP PIC edge enabled, BGP on S2 installs both the best path (through S4) and the backup path (through S3 or S5) toward the AS6500 into the RIB. Then the RIB downloads both routes to the FIB.

If the S2-S4 link goes down, the FIB on S2 detects the link failure. It automatically switches from the primary path to the backup path and points to the new next hop S3. Traffic is quickly rerouted due to the local fast re-convergence in the FIB. After learning of the link failure event, BGP on S2 recomputes the best path (which is the previous backup path), removes next hop S4 from the RIB, and reinstalls S3 as the primary next hop into the RIB. BGP also computes a new backup path, if any, and notifies the RIB. With the support of the BGP PIC edge feature, the FIB can switch to the available backup route instantly upon detection of a link failure on the primary route without waiting for BGP to select the new best path and converge to achieve a fast reroute.

BGP PIC Edge with Multipath

The following figure shows a BGP PIC edge multipath topology.

Figure 28: BGP PIC Edge Multipaths

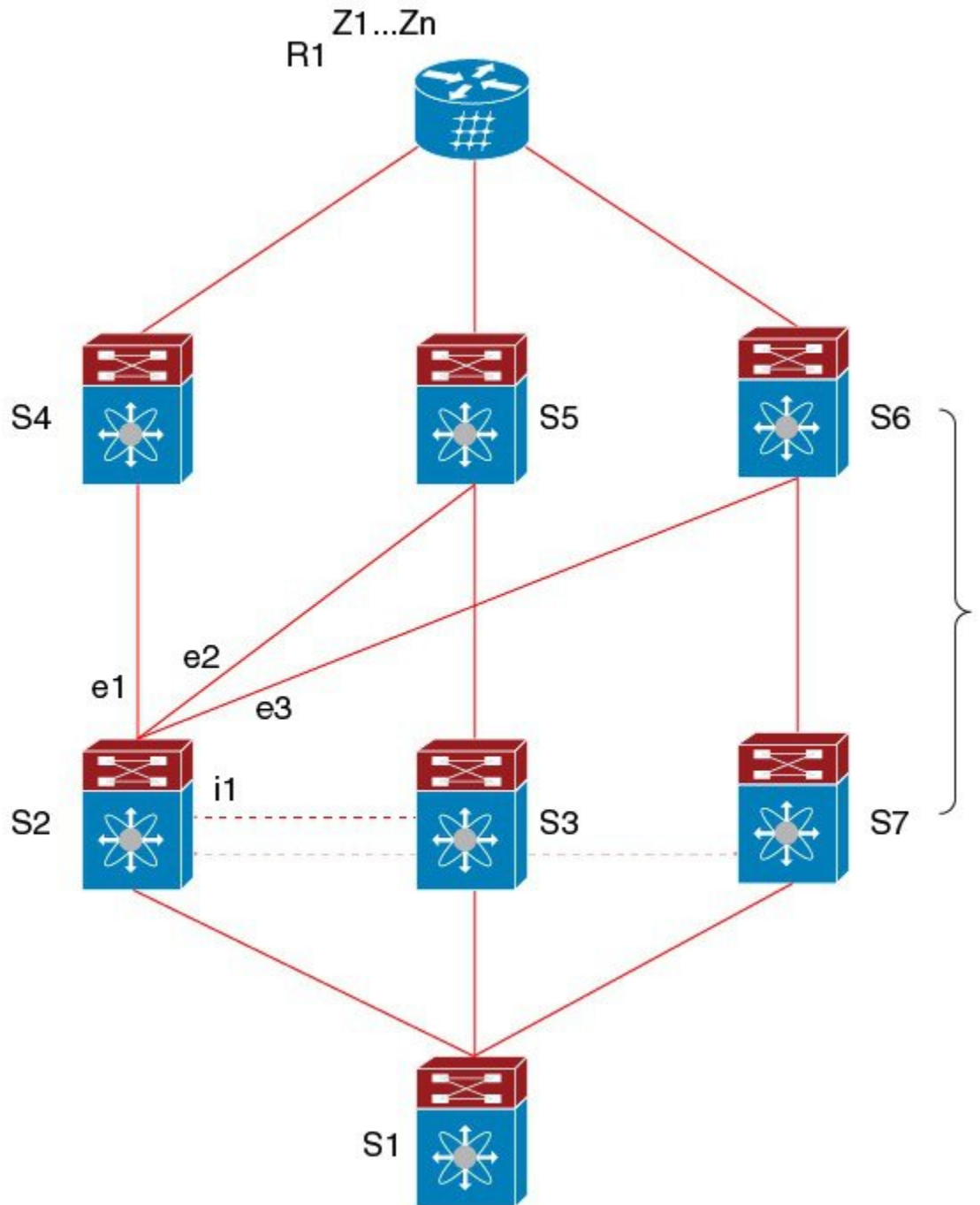

352663

In this topology, there are six paths for a given prefix:

- eBGP paths: e1, e2, e3
- iBGP paths: i1, i2, i3

The order of preference is $e1 > e2 > e3 > i1 > i2 > i3$.

The potential multipath situations are:

- No multipaths configured:
 - `bestpath = e1`
 - `multipath-set = []`
 - `backup path = e2`
 - PIC behavior: When e1 fails, e2 is activated.

- Two-way eBGP multipaths configured:
 - `bestpath = e1`
 - `multipath-set = [e1, e2]`
 - `backup path = e3`
 - PIC behavior: Active multipaths are mutually backed up. When all multipaths fail, e3 is activated.

- Three-way eBGP multipaths configured:
 - `bestpath = e1`
 - `multipath-set = [e1, e2, e3]`
 - `backup path = i1`
 - PIC behavior: Active multipaths are mutually backed up. When all multipaths fail, i1 is activated.

- Four-way eBGP multipaths configured:
 - `– bestpath = e1`
 - `– multipath-set = [e1, e2, e3, i1]`
 - `– backup path = i2`
 - `– PIC behavior: Active multipaths are mutually backed up. When all multipaths fail, i2 is activated.`

When the Equal Cost Multipath Protocol (ECMP) is enabled, none of the multipaths can be selected as the backup path.

For multipaths with the backup path scenario, faster convergence is not expected with simultaneous failure of all active multipaths.

BGP PIC Core

BGP Prefix Independent Convergence (PIC) in Core improves BGP convergence after a network failure. For example, if a link fails on Provider Edge (PE), the Routing Information Base (RIB) updates the Forwarding Information Base (FIB) with new next hop. FIB must update all BGP prefixes that point to the failed next hop and point to the new one. This can be time and resource consuming. With BGP PIC Core enabled, the prefix is programmed in the FIB in a hierarchical way. All prefixes point to the ECMP group instead of the recursive next hop. When the same failure happens, the FIB only needs to update the ECMP group to point to the new next hop without updating prefixes. This gives BGP immediate leveraging of IGP convergence.

BGP PIC Feature Support Matrix

Table 23: BGP PIC Feature Support Matrix

BGP PIC	IPv4 Unicast	IPv6 Unicast
Edge unipath	Yes	No
Edge with multipath (multiple active ECMPs, only one backup)	Yes	No
Core	Yes	Yes

BGP Virtualization

BGP supports virtual routing and forwarding (VRF) instances.

Prerequisites for BGP

BGP has the following prerequisites:

- You must enable BGP (see the [Enabling BGP](#) section).
- You should have a valid router ID configured on the system.
- You must have an AS number, either assigned by a Regional Internet Registry (RIR) or locally administered.
- You must configure at least one IGP that is capable of recursive next-hop resolution.
- You must configure an address family under a neighbor for the BGP session establishment.

Guidelines and Limitations for Basic BGP

BGP has the following configuration guidelines and limitations:

- With sufficient scale (such as - hundreds of peers and thousands of routes per peer) the Graceful Restart mechanism may fail because the default 5 minute stale-path timer might not be enough for BGP convergence to complete before the timer expires. Use the following command to verify the actual time taken for the convergence process:

```
switch# show bgp vrf all all neighbors | in First|RIB
Last End-of-RIB received 0.022810 after session start
Last End-of-RIB sent 00:08:36 after session start
First convergence 00:08:36 after session start with 398002 routes sent
```

- Beginning with Cisco NX-OS 9.3(5), a packet with a TTL value of 1 to a vPC peer is hardware forwarded.
- For large routing tables (250 K or above) when using the SNMP bulkwalk with record option (-Cr), do not use more than 10 records to avoid SNMP performance degradation.

- Names in the prefix-list are case-insensitive. We recommend using unique names. Do not use the same name by modifying uppercase and lowercase characters. For example, CTCPrimaryNetworks and CtcPrimaryNetworks are not two different entries.
- For information about supported platforms, see [Supported Platforms, on page 3](#).
- The dynamic AS number prefix peer configuration overrides the individual AS number configuration that is inherited from a BGP template.
- If you configure a dynamic AS number for prefix peers in an AS confederation, BGP establishes sessions with only the AS numbers in the local confederation.
- BGP sessions that are created through a dynamic AS number prefix peer ignore any configured eBGP multihop time-to-live (TTL) value or a disabled check for directly connected peers.
- Configure a router ID for BGP to avoid automatic router ID changes and session flaps.
- Use the maximum-prefix configuration option per peer to restrict the number of routes that are received and system resources used.
- Configure the update source to establish a session with BGP/eBGP multihop sessions.
- Specify a BGP policy if you configure redistribution.
- Define the BGP router ID within a VRF.
- For IPv6 neighbors, Cisco recommends that you configure a router ID per VRF. If a VRF does not have any IPv4 interfaces, the IPv6 BGP neighbor will not come up because its router ID must be an IPv4 address. The numerically lowest loopback IPv4 address is elected to be the router ID. If a loopback address does not exist, the lowest IP address from the VRF interfaces is elected. If that does not exist, the BGP neighbor relationship is not established.
- If you decrease the keepalive and hold timer values, you might experience BGP session flaps.
- You can configure a minimum route advertisement interval (MRAI) between the sending of BGP routing updates by using the **advertisement-interval** command.
- Although the **show ip bgp** commands are available for verifying the BGP configuration, Cisco recommends that you use the **show bgp** commands instead.
- Route-map deletion feature adds a mechanism to block the deletion of entire route-map that is associated with the BGP. With the route-map deletion blocked, the modifications to the route-map statement are still allowed.
- If there are more than one sequence in the route-map, user can still delete any route map sequence until there is at least one sequence available.
- Users can have the forward reference case for route-map from client. However, once route-map is created and associated, the deletion of route-map is blocked.
- Blocking deletion functionality is configurable dynamically using the knob.
- It is allowed to delete the BGP association to the route-map and deletion of route-map itself in a single transaction payload.
- It is allowed to add the BGP association to the route-map and an error must be thrown for deletion of route-map.
- The following is the list of the dual stage related behaviors:

- If knob and deletion occur together, dual stage has to verify and throw an error without commit.
 - If knob already exists and route-map deletion occurs in dual stage, it must throw an error.
 - If route-map and CLI knob is single commit with different order, it must throw an error.
 - If knob is not enabled and route-map deletion occurs in dual stage, it has to execute successfully.
 - In a single verify, if "cli knob is disabled AND route-map deletion" is executed, the route-map deletion is allowed.
- If the route-map used by BGP template is not inherited by any of the BGP neighbors, the entire route-map deletion will still be blocked.
 - Cloudscale IPv6 link-local BGP support requires carving > 512 ing-sup TCAM region (this requires a reload to take effect).
 - Beginning with Cisco NX-OS Release 10.3(1)F, BGP is supported on the Cisco Nexus 9808 platform switches.
 - Beginning with Cisco NX-OS Release 10.4(1)F, BGP is supported on the Cisco Nexus 9804 platform switches.
 - Beginning with Cisco NX-OS Release 10.4(1)F, BGP is supported on Cisco Nexus X98900CD-A and N9KX9836DM-A line cards with 9808 and 9804 switches.
 - Beginning with Cisco NX-OS Release 10.4(1)F, you can configure route-map in custom isolation mode for BGP routes.

Default Settings

Table 24: Default BGP Parameters

Parameters	Default
BGP feature	Disabled
Keep alive interval	60 seconds
Hold timer	180 seconds
BGP PIC edge	Disabled
Auto-summary	Always disabled
Synchronization	Always disabled

CLI Configuration Modes

The following sections describe how to enter each of the CLI configuration modes for BGP. From a mode, you can enter the ? command to display the commands available in that mode.

Global Configuration Mode

Use global configuration mode to create a BGP process and configure advanced features such as AS confederation and route dampening. For more information, see [Configuring Advanced BGP, on page 315](#).

This example shows how to enter router configuration mode:

```
switch# configuration
switch(config)# router bgp 64496
switch(config-router)#
```

BGP supports VRF. You can configure BGP within the appropriate VRF if you are using VRFs in your network. See the [Configuring Virtualization](#) section for more information.

This example shows how to enter VRF configuration mode:

```
switch(config)# router bgp 64497
switch(config-router)# vrf vrf_A
switch(config-router-vrf)#
```

Address Family Configuration Mode

You can optionally configure the address families that BGP supports. Use the address-family command in router configuration mode to configure features for an address family. Use the address-family command in neighbor configuration mode to configure the specific address family for the neighbor.

You must configure the address families if you are using route redistribution, address aggregation, load balancing, and other advanced features.

The following example shows how to enter address family configuration mode from the router configuration mode:

```
switch(config)# router bgp 64496
switch(config-router)# address-family ipv6 unicast
switch(config-router-af)#
```

The following example shows how to enter VRF address family configuration mode if you are using VRFs:

```
switch(config)# router bgp 64497
switch(config-router)# vrf vrf_A
switch(config-router-vrf)# address-family ipv6 unicast
switch(config-router-vrf-af)#
```

Neighbor Configuration Mode

Cisco NX-OS provides the neighbor configuration mode to configure BGP peers. You can use neighbor configuration mode to configure all parameters for a peer.

The following example shows how to enter neighbor configuration mode:

```
switch(config)# router bgp 64496
switch(config-router)# neighbor 192.0.2.1
switch(config-router-neighbor)#
```

The following example shows how to enter VRF neighbor configuration mode:

```
switch(config)# router bgp 64497
switch(config-router)# vrf vrf_A
switch(config-router-vrf)# neighbor 192.0.2.1
switch(config-router-vrf-neighbor)#
```

Neighbor Address Family Configuration Mode

An address family configuration submode inside the neighbor configuration submode is available for entering address family-specific neighbor configuration and enabling the address family for the neighbor. Use this mode for advanced features such as limiting the number of prefixes allowed for this neighbor and removing private AS numbers for eBGP.

With the introduction of RFC 5549, you can configure an IPv4 address family for a neighbor with an IPv6 address.

This example shows how to enter the IPv4 neighbor address family configuration mode for a neighbor with an IPv4 address:

```
switch(config)# router bgp 64496
switch(config-router)# neighbor 192.0.2.1
switch(config-router-neighbor)# address-family ipv4 unicast
switch(config-router-neighbor-af)#
```

This example shows how to enter the IPv4 neighbor address family configuration mode for a neighbor with an IPv6 address:

```
switch(config)# router bgp 64496
switch(config-router)# neighbor 2001:db8::/64 eui64
switch(config-router-neighbor)# address-family ipv4 unicast
switch(config-router-neighbor-af)#
```

This example shows how to enter the VRF IPv4 neighbor address family configuration mode for a neighbor with an IPv4 address:

```
switch(config)# router bgp 64497
switch(config-router)# vrf vrf_A
switch(config-router-vrf)# neighbor 209.165.201.1
switch(config-router-vrf-neighbor)# address-family ipv4 unicast
switch(config-router-vrf-neighbor-af)#
```

This example shows how to enter the VRF IPv4 neighbor address family configuration mode for a neighbor with an IPv6 address:

```
switch(config)# router bgp 64497
switch(config-router)# vrf vrf_A
switch(config-router-vrf)# neighbor 2001:db8::/64 eui64
switch(config-router-vrf-neighbor)# address-family ipv4 unicast
switch(config-router-vrf-neighbor-af)#
```

Configuring Basic BGP

To configure a basic BGP, you must enable BGP and configure a BGP peer. Configuring a basic BGP network consists of a few required tasks and many optional tasks. You must configure a BGP routing process and BGP peers.



Note If you are familiar with the Cisco IOS CLI, be aware that the Cisco NX-OS commands for this feature might differ from the Cisco IOS commands that you would use.

Enabling BGP

You must enable BGP before you can configure BGP.

SUMMARY STEPS

1. **configure terminal**
2. **[no] feature bgp**
3. (Optional) **show feature**
4. (Optional) **copy running-config startup-config**

DETAILED STEPS

	Command or Action	Purpose
Step 1	configure terminal Example: <pre>switch# configure terminal switch(config)#</pre>	Enters configuration mode.
Step 2	[no] feature bgp Example: <pre>switch(config)# feature bgp</pre>	Enables BGP. Use the no form of this command to disable this feature.
Step 3	(Optional) show feature Example: <pre>switch(config)# show feature</pre>	Displays enabled and disabled features.
Step 4	(Optional) copy running-config startup-config Example: <pre>switch(config)# copy running-config startup-config</pre>	Saves this configuration change.

Creating a BGP Instance

You can create a BGP instance and assign a router ID to the BGP instance. For more information, see the [BGP Router Identifier](#) section.

Before you begin

- You must enable BGP (see the [Enabling BGP](#) section).
- BGP must be able to obtain a router ID (for example, a configured loopback address).

SUMMARY STEPS

1. **configure terminal**
2. **[no] router bgp** *{autonomous-system-number | auto}*
3. **router-id** *{ip-address | auto}*

4. (Optional) **address-family** {**ipv4|ipv6**} {**unicast|multicast**}
5. (Optional) **network** {*ip-address/length* | *ip-address mask mask*} [**route-map** *map-name*]
6. (Optional) **show bgp all**
7. (Optional) **copy running-config startup-config**

DETAILED STEPS

	Command or Action	Purpose
Step 1	configure terminal Example: <pre>switch# configure terminal switch(config)#</pre>	Enters configuration mode.
Step 2	[no] router bgp { <i>autonomous-system-number</i> <i>auto</i> } Example: <pre>switch(config)# router bgp 64496 switch(config-router)#</pre>	<p>Enables BGP and assigns the AS number to the local BGP speaker. The AS number can be a 16-bit integer or a 32-bit integer in the form of a higher 16-bit decimal number and a lower 16-bit decimal number in xx.xx format.</p> <p>Auto automatically generates 4-Byte Private Autonomous System Number based on system MAC address.</p> <p>Use the no option with this command to remove the BGP process and the associated configuration.</p>
Step 3	router-id { <i>ip-address</i> <i>auto</i> } Example: <pre>switch(config-router)# router-id 192.0.2.255</pre>	<p>(Optional) Configures the BGP router ID. This IP address identifies this BGP speaker.</p> <p>"auto" option will enable the BGP router ID based on system MAC address.</p>
Step 4	(Optional) address-family { ipv4 ipv6 } { unicast multicast } Example: <pre>switch(config-router)# address-family ipv4 unicast switch(config-router-af)#</pre>	Enters global address family configuration mode for the IPv4 or IPv6 address family.
Step 5	(Optional) network { <i>ip-address/length</i> <i>ip-address mask mask</i> } [route-map <i>map-name</i>] Example: <pre>switch(config-router-af)# network 10.10.10.0/24</pre> Example: <pre>switch(config-router-af)# network 10.10.10.0 mask 255.255.255.0</pre>	<p>Specifies a network as local to this autonomous system and adds it to the BGP routing table.</p> <p>For exterior protocols, the network command controls which networks are advertised. Interior protocols use the network command to determine where to send updates.</p>
Step 6	(Optional) show bgp all Example: <pre>switch(config-router-af)# show bgp all</pre>	Displays information about all BGP address families.
Step 7	(Optional) copy running-config startup-config Example:	Saves this configuration change.

	Command or Action	Purpose
	switch(config-router-af)# copy running-config startup-config	

Example

This example shows how to enable BGP with the IPv4 unicast address family and manually add one network to advertise:

```
switch# configure terminal
switch(config)# router bgp 64496
switch(config-router)# address-family ipv4 unicast
switch(config-router-af)# network 192.0.2.0
switch(config-router-af)# copy running-config startup-config
```

Restarting a BGP Instance

You can restart a BGP instance and clear all peer sessions for the instance.

To restart a BGP instance and remove all associated peers, use the following command:

SUMMARY STEPS

1. restart `bgpinstance-tag`

DETAILED STEPS

	Command or Action	Purpose
Step 1	restart <code>bgpinstance-tag</code> Example: switch(config)# restart bgp 201	Restarts the BGP instance and resets or reestablishes all peering sessions.

Shutting Down BGP

You can shut down the BGP protocol and gracefully disable BGP while retaining the configuration.

To shut down BGP, use the following command in router configuration mode:

SUMMARY STEPS

1. shutdown

DETAILED STEPS

	Command or Action	Purpose
Step 1	shutdown Example: switch(config-router)# shutdown	Restarts the BGP instance and resets or reestablishes all peering sessions.

Configuring BGP Peers

You can configure a BGP peer within a BGP process. Each BGP peer has an associated keepalive timer and hold timers. You can set these timers either globally or for each BGP peer. A peer configuration overrides a global configuration.



Note You must configure the address family under neighbor configuration mode for each peer.

Before you begin

- You must enable BGP (see the [Enabling BGP](#) section).

SUMMARY STEPS

- configure terminal**
- router bgp** *autonomous-system-number*
- neighbor** {*ip-address* | *ipv6-address*} **remote-as** {*as-number* | *external* | *internal*}
- remote-as** {*as-number* | *external* | *internal*}
- (Optional) **description** *text*
- (Optional) **timers***keepalive-time hold-time*
- (Optional) **shutdown**
- address-family** {*ipv4*|*ipv6*} {*unicast*|*multicast*}
- (Optional) **weight** *value*
- (Optional) **show bgp** {*ipv4*|*ipv6*} {*unicast*|*multicast*} **neighbors**
- (Optional) **copy running-config startup-config**

DETAILED STEPS

	Command or Action	Purpose
Step 1	configure terminal Example: <pre>switch# configure terminal switch(config)#</pre>	Enters configuration mode.
Step 2	router bgp <i>autonomous-system-number</i> Example: <pre>switch(config)# router bgp 64496 switch(config-router)#</pre>	Enables BGP and assigns the AS number to the local BGP speaker. The AS number can be a 16-bit integer or a 32-bit integer in the form of a higher 16-bit decimal number and a lower 16-bit decimal number in xx.xx format.
Step 3	neighbor { <i>ip-address</i> <i>ipv6-address</i> } remote-as { <i>as-number</i> <i>external</i> <i>internal</i> }	Configures the IPv4 or IPv6 address and AS number for a remote BGP peer. <i>The ip-address</i> format is x.x.x.x. The <i>ipv6-address</i> format is A:B::C:D.
	Example: <pre>switch(config-router)# neighbor 209.165.201.1 remote-as 64497 switch(config-router)# neighbor</pre>	The external and internal options allow eBGP and iBGP sessions to be established without manually providing remote-as values.

	Command or Action	Purpose
Step 4	remote-as { <i>as-number</i> <i>external</i> <i>internal</i> } Example: <pre>switch(config-router-neighbor) # remote-as 64497</pre>	Configures the AS number for a remote external BGP peer. The external and internal options allow eBGP and iBGP sessions to be established without manually providing remote-as values.
Step 5	(Optional) description <i>text</i> Example: <pre>switch(config-router-neighbor) # description Peer Router B switch(config-router-neighbor) #</pre>	Adds a description for the neighbor. The description is an alphanumeric string up to 80 characters.
Step 6	(Optional) timers <i>keepalive-time hold-time</i> Example: <pre>switch(config-router-neighbor) # timers 30 90</pre>	Adds the keepalive and hold time BGP timer values for the neighbor. The range is from 0 to 3600 seconds. The default value of keepalive time is 60 seconds and hold time is 180 seconds. Note BGP sessions with a hold-timer of 10 seconds or less are not effective until the BGP session has been up for 60 seconds or more. Once the session has been up for 60 seconds, the hold-timer will work as configured.
Step 7	(Optional) shutdown Example: <pre>switch(config-router-neighbor) # shutdown</pre>	Administratively shuts down this BGP neighbor. This command triggers an automatic notification and session reset for the BGP neighbor sessions.
Step 8	address-family { <i>ipv4</i> <i>ipv6</i> } { <i>unicast</i> <i>multicast</i> } Example: <pre>switch(config-router-neighbor) # address-family ipv4 unicast switch(config-router-neighbor-af) #</pre>	Enters neighbor address family configuration mode for the unicast IPv4 or IPv6 address family.
Step 9	(Optional) weight <i>value</i> Example: <pre>switch(config-router-neighbor-af) # weight 100</pre>	Sets the default weight for routes from this neighbor. The range is from 0 to 65535. All routes learned from this neighbor have the assigned weight initially. The route with the highest weight is chosen as the preferred route when multiple routes are available to a particular network. The weights assigned with the set weight route-map command override the weights assigned with this command. If you specify a BGP peer policy template, all the members of the template inherit the characteristics configured with this command.
Step 10	(Optional) show bgp { <i>ipv4</i> <i>ipv6</i> } { <i>unicast</i> <i>multicast</i> } neighbors Example:	Displays information about BGP peers.

	Command or Action	Purpose
	<code>switch(config-router-neighbor-af)# show bgp ipv4 unicast neighbors</code>	
Step 11	(Optional) copy running-config startup-config Example: <code>switch(config-router-neighbor-af)# copy running-config startup-config</code>	Saves this configuration change.

Example

The following example shows how to configure a BGP peer:

```
switch# configure terminal
switch(config)# router bgp 64496
switch(config-router)# neighbor 192.0.2.1 remote-as 64497
switch(config-router-neighbor)# description Peer Router B
switch(config-router-neighbor)# address-family ipv4 unicast
switch(config-router-neighbor)# weight 100
switch(config-router-neighbor-af)# copy running-config startup-config
```

Configuring Dynamic AS Numbers for Prefix Peers

You can configure multiple BGP peers within a BGP process. You can limit BGP session establishment to a single AS number or multiple AS numbers in a route map.

BGP sessions configured through dynamic AS numbers for prefix peers ignore the **ebgp-multihop** command and the **disable-connected-check** command.

You can change the list of AS numbers in the route map, but you must use the **no neighbor** command to change the route-map name. Changes to the AS numbers in the configured route map affect only new sessions.

Before you begin

- You must enable BGP (see the [Enabling BGP](#) section).

SUMMARY STEPS

1. **configure terminal**
2. **router bgp** *autonomous-system-number*
3. **neighbor** *prefix remote-as route-map map-name*
4. **neighbor-as** *as-number*
5. (Optional) **show bgp** {*ipv4* | *ipv6*} {*unicast* | *multicast*} **neighbors**
6. (Optional) **copy running-config startup-config**

DETAILED STEPS

	Command or Action	Purpose
Step 1	configure terminal Example: switch# configure terminal switch(config)#	Enters configuration mode.
Step 2	router bgp <i>autonomous-system-number</i> Example: switch(config)# router bgp 64496 switch(config-router)#	Enables BGP and assigns the AS number to the local BGP speaker. The AS number can be a 16-bit integer or a 32-bit integer in the form of a higher 16-bit decimal number and a lower 16-bit decimal number in xx.xx format.
Step 3	neighbor <i>prefix</i> remote-as route-map <i>map-name</i> Example: switch(config-router)# neighbor 192.0.2.0/8 remote-as routemap BGPPeers switch(config-router-neighbor)#	Configures the IPv4 or IPv6 prefix and a route map for the list of accepted AS numbers for the remote BGP peers. The <i>prefix</i> format for IPv4 is x.x.x.x/length. The length range is from 1 to 32. The <i>prefix</i> format for IPv6 is A:B::C:D/length. The length range is from 1 to 128. The <i>map-name</i> can be any case-sensitive, alphanumeric string up to 63 characters.
Step 4	neighbor-as <i>as-number</i> Example: switch(config-router-neighbor)# remote-as 64497	Configures the AS number for a remote BGP peer.
Step 5	(Optional) show bgp {ipv4 ipv6} {unicast multicast} neighbors Example: switch(config-router-neighbor-af)# show bgp ipv4 unicast neighbors	Displays information about BGP peers.
Step 6	(Optional) copy running-config startup-config Example: switch(config-router-neighbor-af)# copy running-config startup-config	Saves this configuration change.

Example

This example shows how to configure dynamic AS numbers for a prefix peer:

```
switch# configure terminal
switch(config)# route-map BGPPeers
switch(config-route-map)# match as-number 64496, 64501-64510
switch(config-route-map)# match as-number as-path-list List1, List2
switch(config-route-map)# exit
switch(config)# router bgp 64496
switch(config-router)# neighbor 192.0.2.0/8 remote-as route-map BGPPeers
switch(config-router-neighbor)# description Peer Router B
switch(config-router-neighbor)# address-family ipv4 unicast
```

```
switch(config-router-af)# end
switch# copy running-config startup-config
```

See [Configuring Route Policy Manager, on page 515](#) for information on route maps.

Configuring BGP PIC Edge

Follow these steps to configure BGP PIC edge.



Note The BGP PIC edge feature supports only IPv4 address families.

Before you begin

You must enable BGP (see the [Enabling BGP](#) section).

SUMMARY STEPS

1. **configure terminal**
2. **router bgp** *autonomous-system-number*
3. **address-family ipv4 unicast**
4. **[no] additional-paths install backup**
5. (Optional) **copy running-config startup-config**

DETAILED STEPS

	Command or Action	Purpose
Step 1	configure terminal Example: <pre>switch# configure terminal switch(config)#</pre>	Enters configuration mode.
Step 2	router bgp <i>autonomous-system-number</i> Example: <pre>switch(config)# router bgp 64496 switch(config-router)#</pre>	Enables BGP and assigns the AS number to the local BGP speaker. The AS number can be a 16-bit integer or a 32-bit integer in the form of a higher 16-bit decimal number and a lower 16-bit decimal number in xx.xx format.
Step 3	address-family ipv4 unicast Example: <pre>switch(config-router)# address-family ipv4 unicast switch(config-router-af)#</pre>	Enters address family configuration mode for the IPv4 address family.
Step 4	[no] additional-paths install backup Example: <pre>switch(config-router-af)# [no] additional-paths install backup</pre>	Enables BGP to install the backup path to the routing table.

	Command or Action	Purpose
Step 5	(Optional) copy running-config startup-config Example: <pre>switch(config-router-af)# end switch# copy running-config startup-config</pre>	Saves this configuration change.

Example

This example shows how to configure the device to support BGP PIC edge in an IPv4 network:

```
interface Ethernet2/2
 ip address 1.1.1.5/24
 no shutdown

interface Ethernet2/3
 ip address 2.2.2.5/24
 no shutdown

router bgp 100
 address-family ipv4 unicast
  additional-paths install backup
 neighbor 2.2.2.6
  remote-as 100
 address-family ipv4 unicast
```

If BGP receives the same prefix (for example, 99.0.0.0/24) from the two neighbors 1.1.1.6 and 2.2.2.6, both paths are installed in the URIB, one as the primary path and the other as the backup path.

BGP output:

```
switch(config)# show ip bgp 99.0.0.0/24
BGP routing table information for VRF default, address family IPv4 Unicast BGP routing table
entry
for 99.0.0.0/24, version 4
Paths: (2 available, best #2)
Flags: (0x00001a) on xmit-list, is in urib, is best urib route

Path type: internal, path is valid, not best reason: Internal path, backup path AS-Path:
200 , path
sourced external to AS
2.2.2.6 (metric 0) from 2.2.2.6 (2.2.2.6)
Origin IGP, MED not set, localpref 100, weight 0

Advertised path-id 1
Path type: external, path is valid, is best path AS-Path: 200 , path sourced external to
AS
1.1.1.6 (metric 0) from 1.1.1.6 (99.0.0.1)
Origin IGP, MED not set, localpref 100, weight 0

Path-id 1 advertised to peers: 2.2.2.6
```

URIB output:

```
switch(config)# show ip route 99.0.0.0/24
IP Route Table for VRF "default" '*' denotes best ucast next-hop '*' denotes best mcast
```

```

next-hop
'[x/y]' denotes [preference/metric]
'%<string>' in via output denotes VRF <string>
99.0.0.0/24, ubest/mbest: 1/0
*via 1.1.1.6, [20/0], 14:34:51, bgp-100, external, tag 200
via 2.2.2.6, [200/0], 14:34:51, bgp-100, internal, tag 200 (backup)

```

UFIB output:

```

switch# show forwarding route 123.1.1.0 detail module 8
Prefix 123.1.1.0/24, No of paths: 1, Update time: Wed Jul 11 19:00:12 2018
Vobj id: 141 orig_as: 65002 peer_as: 65100 rnh: 10.3.0.2
10.4.0.2 Ethernet8/4 DMAC: 0018.bad8.4dfd
packets: 2 bytes: 3484 Repair path 10.3.0.2 Ethernet8/3 DMAC: 0018.bad8.4dfd packets:
0
bytes: 1

```

Configuring BGP PIC Core

Follow these steps to configure BGP PIC Core.

SUMMARY STEPS

1. **configure terminal**
2. **[no] system pic-core**
3. **copy running-config startup-config**
4. **reload**

DETAILED STEPS

	Command or Action	Purpose
Step 1	configure terminal Example: switch# configure terminal	Enter global configuration mode.
Step 2	[no] system pic-core Example: switch(config)# system pic-core	Manage PIC enable.
Step 3	copy running-config startup-config Example: switch(config)# copy running-config startup-config	Saves this configuration change.
Step 4	reload Example: switch(config)# reload	Reboots the entire device.

Clearing BGP Information

To clear BGP information, use the following commands:

Command	Purpose
clear bgp all { <i>neighbor</i> * <i>as-number</i> peer-template <i>name</i> <i>prefix</i> } [vrf <i>vrf-name</i>]	<p>Clears one or more neighbors from all address families. * clears all neighbors in all address families. The arguments are as follows:</p> <ul style="list-style-type: none"> • <i>neighbor</i>—IPv4 or IPv6 address of a neighbor. • <i>as-number</i>— Autonomous system number. The AS number can be a 16-bit integer or a 32-bit integer in the form of higher 16-bit decimal number and a lower 16-bit decimal number in xx.xx format. • <i>name</i>—Peer template name. The name can be any case-sensitive, alphanumeric string up to 64 characters. • <i>prefix</i>—IPv4 or IPv6 prefix. All neighbors within that prefix are cleared. • <i>vrf-name</i>—VRF name. All neighbors in that VRF are cleared. The name can be any case-sensitive, alphanumeric string up to 64 characters.
clear bgp all dampening [vrf <i>vrf-name</i>]	Clears route flap dampening networks in all address families. The <i>vrf-name</i> can be any case-sensitive, alphanumeric string up to 64 characters.
clear bgp all flap-statistics [vrf <i>vrf-name</i>]	Clears route flap statistics in all address families. The <i>vrf-name</i> can be any case-sensitive, alphanumeric string up to 64 characters.
clear bgp { ipv4 ipv6 } { unicast multicast } dampening [vrf <i>vrf-name</i>]	Clears route flap dampening networks in the selected address family. The <i>vrf-name</i> can be any case-sensitive, alphanumeric string up to 64 characters.
clear bgp { ipv4 ipv6 } { unicast multicast } flap-statistics [vrf <i>vrf-name</i>]	Clears route flap statistics in the selected address family. The <i>vrf-name</i> can be any case-sensitive, alphanumeric string up to 64 characters.

Command	Purpose
clear bgp { ipv4 ipv6 } { <i>neighbor</i> * <i>as-number</i> peer-template <i>name</i> <i>prefix</i> } [vrf <i>vrf-name</i>]	<p>Clears one or more neighbors from the selected address family. * clears all neighbors in the address family. The arguments are as follows:</p> <ul style="list-style-type: none"> • <i>neighbor</i>—IPv4 or IPv6 address of a neighbor. • <i>as-number</i>— Autonomous system number. The AS number can be a 16-bit integer or a 32-bit integer in the form of higher 16-bit decimal number and a lower 16-bit decimal number in xx.xx format. • <i>name</i>—Peer template name. The name can be any case-sensitive, alphanumeric string up to 64 characters. • <i>prefix</i>—IPv4 or IPv6 prefix. All neighbors within that prefix are cleared. • <i>vrf-name</i>—VRF name. All neighbors in that VRF are cleared. The name can be any case-sensitive, alphanumeric string up to 64 characters.
clear bgp { ip { unicast multicast }} { <i>neighbor</i> * <i>as-number</i> peer-template <i>name</i> <i>prefix</i> } [vrf <i>vrf-name</i>]	<p>Clears one or more neighbors. * clears all neighbors in the address family. The arguments are as follows:</p> <ul style="list-style-type: none"> • <i>neighbor</i>—IPv4 or IPv6 address of a neighbor. • <i>as-number</i>— Autonomous system number. The AS number can be a 16-bit integer or a 32-bit integer in the form of higher 16-bit decimal number and a lower 16-bit decimal number in xx.xx format. • <i>name</i>—Peer template name. The name can be any case-sensitive, alphanumeric string up to 64 characters. • <i>prefix</i>—IPv4 or IPv6 prefix. All neighbors within that prefix are cleared. • <i>vrf-name</i>—VRF name. All neighbors in that VRF are cleared. The name can be any case-sensitive, alphanumeric string up to 64 characters.

Command	Purpose
clear bgp dampening [<i>ip-neighbor</i> <i>ip-prefix</i>] [vrf <i>vrf-name</i>]	Clears route flap dampening in one or more networks. The arguments are as follows: <ul style="list-style-type: none"> • <i>ip-neighbor</i>—IPv4 address of a neighbor. • <i>ip-prefix</i>—IPv4. All neighbors within that prefix are cleared. • <i>vrf-name</i>—VRF name. All neighbors in that VRF are cleared. The name can be any case-sensitive, alphanumeric string up to 64 characters.
clear bgp flap-statistics [<i>ip-neighbor</i> <i>ip-prefix</i>] [vrf <i>vrf-name</i>]	Clears route flap statistics in one or more networks. The arguments are as follows: <ul style="list-style-type: none"> • <i>ip-neighbor</i>—IPv4 address of a neighbor. • <i>ip-prefix</i>—IPv4. All neighbors within that prefix are cleared. • <i>vrf-name</i>—VRF name. All neighbors in that VRF are cleared. The name can be any case-sensitive, alphanumeric string up to 64 characters.
clear ip mbgp { ip { unicast multicast }} { <i>neighbor</i> * <i>as-number</i> peer-template <i>name</i> <i>prefix</i> } [vrf <i>vrf-name</i>]	Clears one or more neighbors. * clears all neighbors in the address family. The arguments are as follows: <ul style="list-style-type: none"> • <i>neighbor</i>—IPv4 or IPv6 address of a neighbor. • <i>as-number</i>— Autonomous system number. The AS number can be a 16-bit integer or a 32-bit integer in the form of higher 16-bit decimal number and a lower 16-bit decimal number in xx.xx format. • <i>name</i>—Peer template name. The name can be any case-sensitive, alphanumeric string up to 64 characters. • <i>prefix</i>—IPv4 or IPv6 prefix. All neighbors within that prefix are cleared. • <i>vrf-name</i>—VRF name. All neighbors in that VRF are cleared. The name can be any case-sensitive, alphanumeric string up to 64 characters.

Command	Purpose
clear ip mbgp dampening [<i>ip-neighbor</i> <i>ip-prefix</i>] [<i>vrf vrf-name</i>]	Clears route flap dampening in one or more networks. The arguments are as follows: <ul style="list-style-type: none"> • <i>ip-neighbor</i>—IPv4 address of a neighbor. • <i>ip-prefix</i>—IPv4. All neighbors within that prefix are cleared. • <i>vrf-name</i>—VRF name. All neighbors in that VRF are cleared. The name can be any case-sensitive, alphanumeric string up to 64 characters.
clear ip mbgp flap-statistics [<i>ip-neighbor</i> <i>ip-prefix</i>] [<i>vrf vrf-name</i>]	Clears route flap statistics in one or more networks. The arguments are as follows: <ul style="list-style-type: none"> • <i>ip-neighbor</i>—IPv4 address of a neighbor. • <i>ip-prefix</i>—IPv4. All neighbors within that prefix are cleared. • <i>vrf-name</i>—VRF name. All neighbors in that VRF are cleared. The name can be any case-sensitive, alphanumeric string up to 64 characters.

Verifying the Basic BGP Configuration

To display the BGP configuration, perform one of the following tasks:

Command	Purpose
show bgp all [summary] [<i>vrf vrf-name</i>]	Displays the BGP information for all address families.
show bgp convergence [<i>vrf vrf-name</i>]	Displays the BGP information for all address families.
show bgp { <i>ipv4</i> <i>ipv6</i> } {unicast multicast} [<i>ip-address</i> <i>ipv6-prefix</i> community [regexp expression [community] [no-advertise] [no-export] [no-export-subconfed]]] [<i>vrf vrf-name</i>]	Displays the BGP routes that match a BGP community.
show bgp [<i>vrf vrf-name</i>] { <i>ipv4</i> <i>ipv6</i> } {unicast multicast} [<i>ip-address</i> <i>ipv6-prefix</i>] community-list <i>list-name</i> [<i>vrf vrf-name</i>]	Displays the BGP routes that match a BGP community list.
show bgp { <i>ipv4</i> <i>ipv6</i> } {unicast multicast} [<i>ip-address</i> <i>ipv6-prefix</i> extcommunity [regexp expression [generic [non-transitive transitive] <i>aa4:nn</i> [exact-match]]] [<i>vrf vrf-name</i>]	Displays the BGP routes that match a BGP extended community.
show bgp { <i>ipv4</i> <i>ipv6</i> } {unicast multicast} [<i>ip-address</i> <i>ipv6-prefix</i> extcommunity-list <i>list-name</i> [exact-match]]] [<i>vrf vrf-name</i>]	Displays the BGP routes that match a BGP extended community list.

Command	Purpose
show bgp { ipv4 ipv6 } { unicast multicast } [<i>ip-address</i> <i>ipv6-prefix</i>] { dampening dampened-paths [regex <i>expression</i>]} [vrf <i>vrf-name</i>]	Displays the information for BGP route dampening. Use the clear bgp dampening command to clear the route flap dampening information.
show bgp { ipv4 ipv6 } { unicast multicast } [<i>ip-address</i> <i>ipv6-prefix</i>] history-paths [regex <i>expression</i>] [vrf <i>vrf-name</i>]	Displays the BGP route history paths.
show bgp { ipv4 ipv6 } { unicast multicast } [<i>ip-address</i> <i>ipv6-prefix</i>] filter-list <i>list-name</i> [vrf <i>vrf-name</i>]	Displays the information for the BGP filter list.
show bgp { ipv4 ipv6 } { unicast multicast } [<i>ip-address</i> <i>ipv6-prefix</i>] neighbors [<i>ip-address</i> <i>ipv6-prefix</i>] [vrf <i>vrf-name</i>]	Displays the information for BGP peers. Use the clear bgp neighbors command to clear these neighbors.
show bgp { ipv4 ipv6 } unicast neighbors [<i>ip-address</i> <i>ipv6-prefix</i>] { [advertised-routes received-routes] } [detail] [vrf <i>vrf-name</i>] show bgp { ipv4 ipv6 } unicast neighbors [<i>ip-address</i> <i>ipv6-prefix</i>] [routes] { [advertised received] } [detail] [vrf <i>vrf-name</i>]	Displays the detailed information of all routes: <ul style="list-style-type: none"> received from the peer before evaluating inbound route map. advertised to the peer before updating attributes by outbound route map.
show bgp { ipv4 ipv6 } unicast neighbors [<i>ip-address</i> <i>ipv6-prefix</i>] [routes] [detail] [vrf <i>vrf-name</i>]	Displays the detailed information of all routes received from this peer after evaluating inbound route map.
show bgp { ipv4 ipv6 } unicast neighbors [<i>ip-address</i> <i>ipv6-prefix</i>] [advertised-routes processed] [vrf <i>vrf-name</i>]	Displays brief information of all routes advertised to the peer after updating path attributes by outbound route map with processed option.
show bgp { ipv4 ipv6 } unicast neighbors [<i>ip-address</i> <i>ipv6-prefix</i>] [advertised-routes processed] [detail] [vrf <i>vrf-name</i>]	Displays detailed information of all routes advertised to the peer after updating path attributes by outbound route map with processed option.
show bgp { ipv4 ipv6 } { unicast multicast } [<i>ip-address</i> <i>ipv6-prefix</i>] neighbors [<i>ip-address</i> <i>ipv6-prefix</i>] { nexthop nexthop-database } [vrf <i>vrf-name</i>]	Displays the information for the BGP route next hop.
show bgp paths	Displays the BGP path information.
show bgp { ipv4 ipv6 } { unicast multicast } [<i>ip-address</i> <i>ipv6-prefix</i>] policy <i>name</i> [vrf <i>vrf-name</i>]	Displays the BGP policy information. Use the clear bgp policy command to clear the policy information.
show bgp { ipv4 ipv6 } { unicast multicast } [<i>ip-address</i> <i>ipv6-prefix</i>] prefix-list <i>list-name</i> [vrf <i>vrf-name</i>]	Displays the BGP routes that match the prefix list.

Command	Purpose
show bgp { ipv4 ipv6 } { unicast multicast } [<i>ip-address</i> <i>ipv6-prefix</i>] received-paths [vrf <i>vrf-name</i>]	Displays the BGP paths stored for soft reconfiguration.
show bgp { ipv4 ipv6 } { unicast multicast } [<i>ip-address</i> <i>ipv6-prefix</i>] regexp <i>expression</i> [vrf <i>vrf-name</i>]	Displays the BGP routes that match the AS_path regular expression.
show bgp { ipv4 ipv6 } { unicast multicast } [<i>ip-address</i> <i>ipv6-prefix</i>] route-map <i>map-name</i> [vrf <i>vrf-name</i>]	Displays the BGP routes that match the route map.
show bgp peer-policy <i>name</i> [vrf <i>vrf-name</i>]	Displays the information about BGP peer policies.
show bgp peer-session <i>name</i> [vrf <i>vrf-name</i>] show bgp peer-session	Displays the information about BGP peer sessions.
show bgp peer-template <i>name</i> [vrf <i>vrf-name</i>]	Displays the information about BGP peer templates. Use the clear bgp peer-template command to clear all neighbors in a peer template.
show bgp process	Displays the BGP process information.
show { ipv ipv6 } bgp [<i>options</i>]	Displays the BGP status and configuration information.
show { ipv ipv6 } mbgp [<i>options</i>]	Displays the BGP status and configuration information.
show running-configuration bgp	Displays the current running BGP configuration.

Monitoring BGP Statistics

To display BGP statistics, use the following commands:

Command	Purpose
show bgp { ipv4 ipv6 } { unicast multicast } [<i>ip-address</i> <i>ipv6-prefix</i>] flap-statistics [vrf <i>vrf-name</i>]	Displays the BGP route flap statistics. Use the clear bgp flap-statistics command to clear these statistics.
show bgp sessions [vrf <i>vrf-name</i>]	Displays the BGP sessions for all peers. Use the clear bgp sessions command to clear these statistics.
show bgp statistics	Displays the BGP statistics.

Configuration Examples for Basic BGP

This example shows a basic BGP configuration:

```
switch(config)# feature bgp
switch(config)# router bgp 64496
switch(config-router)# neighbor 2001:ODB8:0:1::55 remote-as 64496
switch(config-router)# address-family ipv6 unicast
switch(config-router-af)# next-hop-self
```

Related Topics

The following topics relate to BGP:

- [Configuring Advanced BGP, on page 315](#)
- [Configuring Route Policy Manager, on page 515](#)

Where to Go Next

See [Configuring Advanced BGP, on page 315](#), for details on the following features:

- Peer templates
- Route redistribution
- Route maps

Additional References

For additional information related to implementing BGP, see the following sections:

MIBs for Basic BGP

MIBs	MIBs Link
MIBs related to BGP	To locate and download MIBs, go to the following URL: ftp://ftp.cisco.com/pub/mibs/supportlists/nexus9000/Nexus9000MIBSupportList.html



CHAPTER 11

Configuring Advanced BGP

This chapter contains the following sections:

- [About Advanced BGP, on page 316](#)
- [Prerequisites for Advanced BGP, on page 328](#)
- [Guidelines and Limitations for Advanced BGP, on page 328](#)
- [Default Settings, on page 333](#)
- [Configuring Advanced BGP, on page 333](#)
- [Configuring BGP Additional Paths, on page 352](#)
- [Configuring eBGP, on page 356](#)
- [Configuring AS Confederations, on page 361](#)
- [Configuring Route Reflector, on page 362](#)
- [Configuring Next-Hops on Reflected Routes Using an Outbound Route-Map, on page 364](#)
- [Configuring Route Dampening, on page 366](#)
- [Configuring Load Sharing and ECMP, on page 367](#)
- [Unequal Cost Multipath \(UCMP\) over BGP, on page 367](#)
- [Enabling UCMP over BGP, on page 368](#)
- [Guidelines and Limitations for UCMP over BGP, on page 368](#)
- [Configuring Maximum Prefixes, on page 368](#)
- [Configuring DSCP, on page 369](#)
- [Configuring Dynamic Capability, on page 369](#)
- [Configuring Aggregate Addresses, on page 370](#)
- [Suppressing BGP Routes, on page 371](#)
- [Configuring BGP Conditional Advertisement, on page 371](#)
- [Configuring Route Redistribution, on page 373](#)
- [DMZ Link Bandwidth, on page 375](#)
- [Advertising the Default Route, on page 386](#)
- [Configuring BGP Attribute Filtering and Error Handling, on page 387](#)
- [Tuning BGP, on page 390](#)
- [Configuring Policy-Based Administrative Distance, on page 394](#)
- [Configuring Multiprotocol BGP, on page 396](#)
- [Configuring BMP, on page 397](#)
- [BGP Local Route Leaking, on page 400](#)
- [BGP Graceful Shutdown, on page 407](#)
- [Configuring a Graceful Restart, on page 419](#)

- [Configuring Virtualization, on page 422](#)
- [Verifying the Advanced BGP Configuration, on page 423](#)
- [Monitoring BGP Statistics, on page 425](#)
- [Configuration Examples, on page 426](#)
- [Related Topics, on page 426](#)
- [Additional References, on page 427](#)

About Advanced BGP

BGP is an interdomain routing protocol that provides loop-free routing between organizations or autonomous systems. Cisco NX-OS supports BGP version 4. BGP version 4 includes multiprotocol extensions that allow BGP to carry routing information for IP multicast routes and multiple Layer 3 protocol address families. BGP uses TCP as a reliable transport protocol to create TCP sessions with other BGP-enabled devices called BGP peers. When connecting to an external organization, the router creates external BGP (eBGP) peering sessions. BGP peers within the same organization exchange routing information through internal BGP (iBGP) peering sessions.

Peer Templates

BGP peer templates allow you to create blocks of common configuration that you can reuse across similar BGP peers. Each block allows you to define a set of attributes that a peer then inherits. You can choose to override some of the inherited attributes as well, making it a very flexible scheme for simplifying the repetitive nature of BGP configurations.

Cisco NX-OS implements three types of peer templates:

- The peer-session template defines BGP peer session attributes, such as the transport details, remote autonomous system number of the peer, and session timers. A peer-session template can also inherit attributes from another peer-session template (with locally defined attributes that override the attributes from an inherited peer-session).
- A peer-policy template defines the address-family dependent policy aspects for a peer including the inbound and outbound policy, filter-lists, and prefix-lists. A peer-policy template can inherit from a set of peer-policy templates. Cisco NX-OS evaluates these peer-policy templates in the order specified by the preference value in the inherit configuration. The lowest number is preferred over higher numbers.
- The peer template can inherit the peer-session and peer-policy templates to allow for simplified peer definitions. It is not mandatory to use a peer template but it can simplify the BGP configuration by providing reusable blocks of configuration.

Authentication

You can configure authentication for a BGP neighbor session. This authentication method adds an MD5 authentication digest to each TCP segment sent to the neighbor to protect BGP against unauthorized messages and TCP security attacks.



Note The MD5 password must be identical between BGP peers.

Route Policies and Resetting BGP Sessions

You can associate a route policy to a BGP peer. Route policies use route maps to control or modify the routes that BGP recognizes. You can configure a route policy for inbound or outbound route updates. The route policies can match on different criteria, such as a prefix or AS_path attribute, and selectively accept or deny the routes. Route policies can also modify the path attributes.

When you change a route policy applied to a BGP peer, you must reset the BGP sessions for that peer. Cisco NX-OS supports the following three mechanisms to reset BGP peering sessions:

- **Hard reset**—A hard reset tears down the specified peering sessions, including the TCP connection, and deletes routes coming from the specified peer. This option interrupts packet flow through the BGP network. Hard reset is disabled by default.
- **Soft reconfiguration inbound**—A soft reconfiguration inbound triggers routing updates for the specified peer without resetting the session. You can use this option if you change an inbound route policy. Soft reconfiguration inbound saves a copy of all routes received from the peer before processing the routes through the inbound route policy. If you change the inbound route policy, Cisco NX-OS passes these stored routes through the modified inbound route policy to update the route table without tearing down existing peering sessions. Soft reconfiguration inbound can use significant memory resources to store the unfiltered BGP routes. Soft reconfiguration inbound is disabled by default.
- **Route Refresh**—A route refresh updates the inbound routing tables dynamically by sending route refresh requests to supporting peers when you change an inbound route policy. The remote BGP peer responds with a new copy of its routes that the local BGP speaker processes with the modified route policy. Cisco NX-OS automatically sends an outbound route refresh of prefixes to the peer.
- BGP peers advertise the route refresh capability as part of the BGP capability negotiation when establishing the BGP peer session. Route refresh is the preferred option and enabled by default.



Note BGP also uses route maps for route redistribution, route aggregation, route dampening, and other features. See [Configuring Route Policy Manager, on page 515](#), for more information on route maps.

eBGP

External BGP (eBGP) allows you to connect BGP peers from different autonomous systems to exchange routing updates. Connecting to external networks enables traffic from your network to be forwarded to other networks and across the Internet.

Typically eBGP peerings need to be over directly connected interfaces so that convergence will be faster when the interface goes down.

iBGP

Internal BGP (iBGP) allows you to connect BGP peers within the same autonomous system. You can use iBGP for multihomed BGP networks (networks that have more than one connection to the same external autonomous system).

The figure shows an iBGP network within a larger BGP network.

Figure 29: iBGP Network

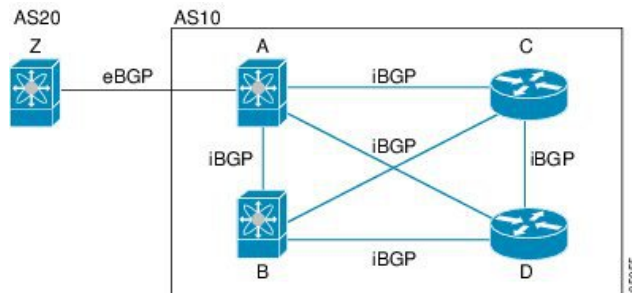

iBGP networks are fully meshed. Each iBGP peer has a direct connection to all other iBGP peers to prevent network loops.

For single-hop iBGP peers with update-source configured under neighbor configuration mode, the peer supports fast external fall-over.

You should use loopback interfaces for establishing iBGP peering sessions because loopback interfaces are less susceptible to interface flapping. An interface flap occurs when the interface is administratively brought up or down because of a failure or maintenance issue. See the [Configuring eBGP, on page 356](#) section for information on multihop, fast external fallovers, and limiting the size of the AS_path attribute.



Note You should configure a separate interior gateway protocol in the iBGP network.

AS Confederations

A fully meshed iBGP network becomes complex as the number of iBGP peers grows. You can reduce the iBGP mesh by dividing the autonomous system into multiple subautonomous systems and grouping them into a single confederation. A confederation is a group of iBGP peers that use the same autonomous system number to communicate to external networks. Each subautonomous system is fully meshed within itself and has a few connections to other subautonomous systems in the same confederation.

The figure shows the BGP network, split into two subautonomous systems and one confederation.

Figure 30: AS Confederation

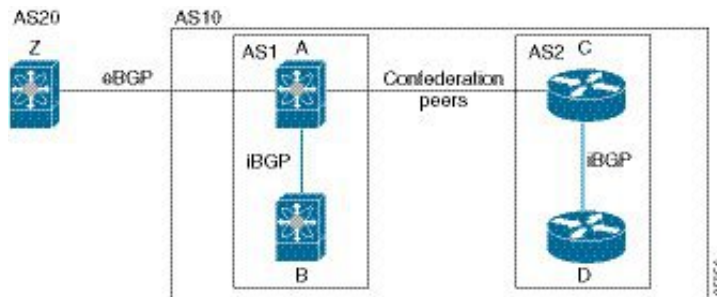

In this example, AS10 is split into two subautonomous systems, AS1 and AS2. Each subautonomous system is fully meshed, but there is only one link between the subautonomous systems. By using AS confederations, you can reduce the number of links compared to the fully meshed autonomous system.

Route Reflector

You can alternately reduce the iBGP mesh by using a route reflector configuration where route reflectors pass learned routes to neighbors so that all iBGP peers do not need to be fully meshed.

When you configure an iBGP peer to be a route reflector, it becomes responsible for passing iBGP learned routes to a set of iBGP neighbors.

The figure shows a simple iBGP configuration with four meshed iBGP speakers (routers A, B, C, and D). Without route reflectors, when router A receives a route from an external neighbor, it advertises the route to all three iBGP neighbors.

In the figure, router B is the route reflector. When the route reflector receives routes advertised from router A, it advertises (reflects) the routes to routers C and D. Router A no longer has to advertise to both routers C and D.

Figure 31: Route Reflector

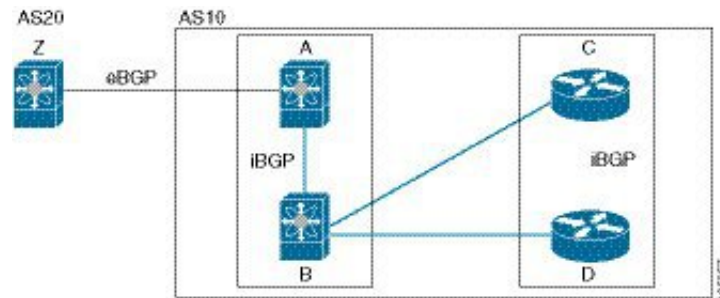

The route reflector and its client peers form a cluster. You do not have to configure all iBGP peers to act as client peers of the route reflector. You must configure any nonclient peer as fully meshed to guarantee that complete BGP updates reach all peers.

Capabilities Negotiation

A BGP speaker can learn about BGP extensions that are supported by a peer by using the capabilities negotiation feature. Capabilities negotiation allows BGP to use only the set of features supported by both BGP peers on a link.

If a BGP peer does not support capabilities negotiation, Cisco NX-OS attempts a new session to the peer without capabilities negotiation if you have configured the address family as IPv4. Any other multiprotocol configuration (such as IPv6) requires capabilities negotiation.

Route Dampening

Route dampening is a BGP feature that minimizes the propagation of flapping routes across an internetwork. A route flaps when it alternates between the available and unavailable states in rapid succession.

For example, consider a network with three BGP autonomous systems: AS1, AS2, and AS3. Suppose that a route in AS1 flaps (it becomes unavailable). Without route dampening, AS1 sends a withdraw message to AS2. AS2 propagates the withdrawal message to AS3. When the flapping route reappears, AS1 sends an advertisement message to AS2, which sends the advertisement to AS3. If the route repeatedly becomes unavailable, and then available, AS1 sends many withdrawal and advertisement messages that propagate through the other autonomous systems.

Route dampening can minimize flapping. Suppose that the route flaps. AS2 (in which route dampening is enabled) assigns the route a penalty of 1000. AS2 continues to advertise the status of the route to neighbors. Each time that the route flaps, AS2 adds to the penalty value. When the route flaps so often that the penalty exceeds a configurable suppression limit, AS2 stops advertising the route, regardless of how many times that it flaps. The route is now dampened.

The penalty placed on the route decays until the reuse limit is reached. At that time, AS2 advertises the route again. When the reuse limit is at 50 percent, AS2 removes the dampening information for the route.



Note The router does not apply a penalty to a resetting BGP peer when route dampening is enabled, even though the peer reset withdraws the route.

Load Sharing and Multipath

BGP can install multiple equal-cost eBGP or iBGP paths into the routing table to reach the same destination prefix. Traffic to the destination prefix is then shared across all the installed paths.

To configure as-path multipath-relax command effectively, configure the command per VRF under BGP. Also, configure as-path multipath-relax command under the custom VRF so that multiple routers get installed in the custom VRF Route-Target (RT).

The BGP best-path algorithm considers the paths as equal-cost paths if the following attributes are identical:

- Weight
- Local preference
- AS_path
- Origin code
- Multi-exit discriminator (MED)
- IGP cost to the BGP next hop

BGP selects only one of these multiple paths as the best path and advertises the path to the BGP peers. For more information, see the [BGP Additional Paths](#) section.



Note Paths that are received from different AS confederations are considered as equal-cost paths if the external AS_path values and the other attributes are identical.



Note When you configure a route reflector for iBGP multipath, and the route reflector advertises the selected best path to its peers, the next hop for the path is not modified.

BGP Additional Paths

Only one BGP best path is advertised, and the BGP speaker accepts only one path for a given prefix from a given peer. If a BGP speaker receives multiple paths for the same prefix within the same session, it uses the most recent advertisement.

BGP supports the additional paths feature, which allows the BGP speaker to propagate and accept multiple paths for the same prefix without the new paths replacing any previous ones. This feature allows BGP speaker peers to negotiate whether they support advertising and receiving multiple paths per prefix and advertising such paths. A special 4-byte path ID is added to the network layer reachability information (NLRI) to differentiate multiple paths for the same prefix sent across a peer session. The following figure illustrates the BGP additional paths capability.

Figure 32: BGP Route Advertisement with the Additional Paths Capability

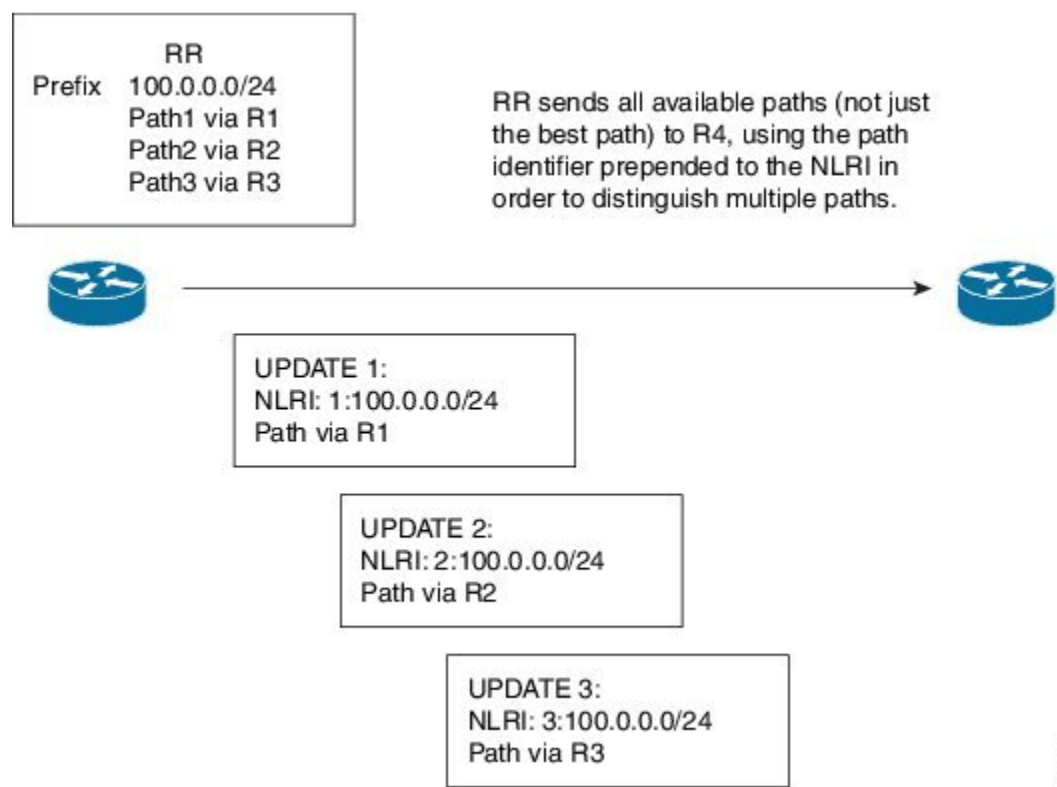

For information on configuring BGP additional paths, see the [Configuring BGP Additional Paths, on page 352](#) section.

Route Aggregation

You can configure aggregate addresses. Route aggregation simplifies route tables by replacing a number of more specific addresses with an address that represents all the specific addresses. For example, you can replace these three more specific addresses, 10.1.1.0/24, 10.1.2.0/24, and 10.1.3.0/24 with one aggregate address, 10.1.0.0/16.

Aggregate prefixes are present in the BGP route table so that fewer routes are advertised.



Note Cisco NX-OS does not support automatic route aggregation.

Route aggregation can lead to forwarding loops. To avoid this problem, when BGP generates an advertisement for an aggregate address, it automatically installs a summary discard route for that aggregate address in the local routing table. BGP sets the administrative distance of the summary discard to 220 and sets the route type to discard. BGP does not use discard routes for next-hop resolution.

A summary entry is created in the BGP table when you issue the **aggregate-address** command, but the summary entry is not eligible for advertisement until a subset of the aggregate is found in the table.

BGP Conditional Advertisement

BGP conditional advertisement allows you to configure BGP to advertise or withdraw a route based on whether or not a prefix exists in the BGP table. This feature is useful, for example, in multihomed networks, in which you want BGP to advertise some prefixes to one of the providers only if information from the other provider is not present.

Consider an example network with three BGP autonomous systems: AS1, AS2, and AS3, where AS1 and AS3 connect to the Internet and to AS2. Without conditional advertisement, AS2 propagates all routes to both AS1 and AS3. With conditional advertisement, you can configure AS2 to advertise certain routes to AS3 only if routes from AS1 do not exist (if for example, the link to AS1 fails).

BGP conditional advertisement adds an exist or not-exist test to each route that matches the configured route map. See the [Configuring BGP Conditional Advertisement](#) section for more information.

BGP Next-Hop Address Tracking

BGP monitors the next-hop address of installed routes to verify next-hop reachability and to select, install, and validate the BGP best path. BGP next-hop address tracking speeds up this next-hop reachability test by triggering the verification process when routes change in the Routing Information Base (RIB) that may affect BGP next-hop reachability.

BGP receives notifications from the RIB when the next-hop information changes (event-driven notifications). BGP is notified when any of the following events occurs:

- The next hop becomes unreachable.
- The next hop becomes reachable.
- The fully recursed Interior Gateway Protocol (IGP) metric to the next hop changes.
- The first hop IP address or first hop interface changes.
- The next hop becomes connected.
- The next hop becomes unconnected.
- The next hop becomes a local address.
- The next hop becomes a nonlocal address.



Note Reachability and recurred metric events trigger a best-path recalculation.

Event notifications from the RIB are classified as critical and noncritical. Notifications for critical and noncritical events are sent in separate batches. However, a noncritical event is sent with the critical events if the noncritical event is pending and there is a request to read the critical events.

- Critical events are related to next-hop reachability, such as the loss of next hops resulting in a switchover to a different path. A change in the IGP metric for a next hop resulting in a switchover to a different path can also be considered a critical event.
- Non-critical events are related to next hops being added without affecting the best path or changing the IGP metric to a single next hop.

See the [Configuring BGP Next-Hop Address Tracking](#) section for more information.

Route Redistribution

You can configure BGP to redistribute static routes or routes from other protocols. You must configure a route map with the redistribution to control which routes are passed into BGP. A route map allows you to filter routes based on attributes such as the destination, origination protocol, route type, route tag, and so on. See [Configuring Route Policy Manager, on page 515](#), for more information.

You can use route maps to override the default behavior in both scenarios, but be careful when doing so as incorrect use of route maps can result in network loops. The following examples show how to use route maps to change the default behavior.

You can change the default behavior for scenario 1 by modifying the route map as follows:

```
route-map foo permit 10
  match route-type internal
router ospf 1
  redistribute bgp 100 route-map foo
```

Similarly, you can change the default behavior for scenario 2 by modifying the route map as follows:

```
route-map foo deny 10
  match route-type internal
router ospf 1
  vrf bar
  redistribute bgp 100 route-map foo
```

Labeled and Unlabeled Unicast Routes

In release 7.0(3)I7(6), SAFI-1 (unlabeled unicast) and SAFI-4 (labeled unicast routing) are now supported for IPv4 BGP on a single session. For more information, see the *Cisco Nexus 9000 Series NX-OS Label Switching Configuration Guide, Release 7.x*.

BFD

This feature supports bidirectional forwarding detection (BFD) for IPv4 and IPv6. BFD is a detection protocol designed to provide fast forwarding-path failure detection times. BFD provides subsecond failure detection

between two adjacent devices and can be less CPU-intensive than protocol hello messages because some of the BFD load can be distributed onto the data plane on supported modules.

BFD for BGP is supported on eBGP peers and iBGP single-hop peers. Configure the **update-source** option in neighbor configuration mode for iBGP single-hop peers using BFD.

Beginning with Cisco NX-OS Release 9.3(3), BFD for BGP is also supported for BGP IPv4 and IPv6 prefix peers. This support enables BGP to use multihop BFD, which improves BGP convergence times. Both single-hop and multihop BGP are supported for prefix peers.

Beginning with Cisco NX-OS Release 9.3(3), BFD supports BGP Interface Peering via IPv6 Link-Local for IPv4 and IPv6 Address Families. However, BFD multihop is not supported with unnumbered BGP.

See the [Cisco Nexus 9000 Series NX-OS Interfaces Configuration Guide](#) for more information.

Tuning BGP

You can modify the default behavior of BGP through BGP timers and by adjusting the best-path algorithm.

BGP Timers

BGP uses different types of timers for neighbor session and global protocol events. Each established session has a minimum of two timers for sending periodic keepalive messages and for timing out sessions when peer keepalives do not arrive within the expected time. In addition, there are other timers for handling specific features. Typically, you configure these timers in seconds. The timers include a random adjustment so that the same timers on different BGP peers trigger at different times.

Tuning the Best-Path Algorithm

You can modify the default behavior of the best-path algorithm through optional configuration parameters, including changing how the algorithm handles the multi-exit discriminator (MED) attribute and the router ID.

Multiprotocol BGP

BGP on Cisco NX-OS supports multiple address families. Multiprotocol BGP (MP-BGP) carries different sets of routes depending on the address family. For example, BGP can carry one set of routes for IPv4 unicast routing, one set of routes for IPv4 multicast routing, and one set of routes for IPv6 multicast routing. You can use MP-BGP for reverse-path forwarding (RPF) checks in IP multicast networks.



Note Because Multicast BGP does not propagate multicast state information, you need a multicast protocol, such as Protocol Independent Multicast (PIM).

Use the router address-family and neighbor address-family configuration modes to support multiprotocol BGP configurations. MP-BGP maintains separate RIBs for each configured address family, such as a unicast RIB and a multicast RIB for BGP.

A multiprotocol BGP network is backward compatible but BGP peers that do not support multiprotocol extensions cannot forward routing information, such as address family identifier information, that the multiprotocol extensions carry.

RFC 5549

BGP supports RFC 5549, which allows an IPv4 prefix to be carried over an IPv6 next hop. Because BGP is running on every hop, all routers can forward IPv4 and IPv6 traffic. Therefore, there is no need to support IPv6 tunnels between any routers. BGP installs IPv4 over an IPv6 route to the Unicast Route Information Base (URIB).

Beginning with Cisco NX-OS Release 9.2(2), Cisco Nexus 9500 platform switches with -R line cards support RFC 5549.

Currently, NX-OS does not support IPv6 recursive next-hops (RNH) for an IPv4 route.

RFC 6368

Introduction

This section describes how the Internal Border Gateway Protocol (iBGP) between Provider Edge (PE) and Customer Edge (CE) feature is implemented in Cisco NX-OS.

In current deployments, when BGP is used as the Provider/Customer Edge routing protocol, these peering sessions are configured as an external peering between the VPN provider autonomous system (AS) and the customer network autonomous system.

RFC 6368 adds support for these peers to be configured as iBGP peers instead.

Beginning with Cisco NX-OS Release 10.1(2), RFC 6368 support is enabled for EVPN-VxLANv4 and EVPN-VxLANv6.

Framework

Beginning with Cisco NX-OS Release 10.1(2), deploying iBGP PE-CE feature:

- You can have one single Autonomous System Number (ASN) on the multiple sites of the VRF, without the deployment of External Border Gateway Protocol (eBGP) with as-override.
- You can give internal route reflection towards the CE routers, acting as if the Provider core is one transparent Route Reflector (RR).

With this feature, the VRF sites can have the same ASN as the provider core. However, in case the ASN of the VRF sites are different than the ASN of the provider core, it can be made to appear the same with the use of the feature local Autonomous System (AS).

Implement iBGP PE-CE

Here are the two major parts to make this feature work:

- A new attribute `ATTR_SET` added to the BGP protocol to carry the VPN BGP attributes across the provider core in a transparent manner.
- Make the PE router a RR for the iBGP sessions towards the CE routers in the VRF.

The new `ATTR_SET` attribute allows the provider to carry all the BGP attributes of the customer transparently and does not interfere with the provider attributes and BGP policies. Such attributes are the cluster list, local preference, and so on.

BGP Customer Route Attribute

`ATTR_SET` is the new BGP attribute used to carry the VPN BGP attributes of the provider customer. It is an optional transitive attribute. In this attribute, Local Preference, Med, Origin, AS Path, Originator ID, Cluster list attributes will be carried across the provider network. The `ATTR_SET` attribute has the format:

```
+-----+
| Attr Flags (O|T) Code = 128 |
+-----+
| Attr. Length (1 or 2 octets) |
+-----+
| Origin AS (4 octets)      |
+-----+
|Path Attributes (variable) |
+-----+
```

- Attribute Flags are regular BGP attribute flags.
- Attribute length indicates whether the length is one or two octets.
- Origin AS field is to prevent a leak of one route that originated in one AS to be leaked to another AS without proper manipulation of the `AS_PATH`.
- The variable-length path attributes field carries VPN BGP attributes that must be carried across the provider core.

For more information on the implementation of iBGP PE-CE, see [IOS Implementation of the iBGP PE-CE Feature](#).

This example shows BGP neighbor configuration on PE device for iBGP Customer Edge device:

```
router bgp 200
vrf nxbgp3-leaf2-2
address-family ipv4 unicast
redistribute static route-map ALLOW-ALL
address-family ipv6 unicast
redistribute static route-map ALLOW-ALL
neighbor 101.101.101.101 remote-as 200
description ibgp sample config
internal-vpn-client (1)
address-family ipv4 unicast
route-reflector-client (2)
next-hop-self (3)
```

BGP Monitoring Protocol

The BGP Monitoring Protocol (BMP) monitors BGP updates and peer statistics and is supported for all Cisco Nexus 9000 Series switches.

Using this protocol, the BGP speaker connects to external BMP servers and sends them information regarding BGP events. A maximum of two BMP servers can be configured in a BGP speaker, and each BGP peer can be configured for monitoring by all or a subset of the BMP servers. The BGP speaker does not accept any information from the BMP server.

Graceful Restart and High Availability

Cisco NX-OS supports nonstop forwarding and graceful restart for BGP.

You can use nonstop forwarding (NSF) for BGP to forward data packets along known routes in the Forward Information Base (FIB) while the BGP routing protocol information is being restored following a failover. With NSF, BGP peers do not experience routing flaps. During a failover, the data traffic is forwarded through intelligent modules while the standby supervisor becomes active.

If a Cisco NX-OS router experiences a cold reboot, the network does not forward traffic to the router and removes the router from the network topology. In this scenario, BGP experiences a nongraceful restart and removes all routes. When Cisco NX-OS applies the startup configuration, BGP reestablishes peering sessions and relearns the routes.

A Cisco NX-OS router that has dual supervisors can experience a stateful supervisor switchover. During the switchover, BGP uses nonstop forwarding to forward traffic based on the information in the FIB, and the system is not removed from the network topology. A router whose neighbor is restarting is referred to as a "helper." After the switchover, a graceful restart operation begins. When it is in progress, both routers reestablish their neighbor relationship and exchange their BGP routes. The helper continues to forward prefixes pointing to the restarting peer, and the restarting router continues to forward traffic to peers even though those neighbor relationships are restarting. When the restarting router has all route updates from all BGP peers that are graceful restart capable, the graceful restart is complete, and BGP informs the neighbors that it is operational again.

BGP needs to converge before graceful-restart timer expires. BGP graceful-restart timer needs to be increased in high route scale network accordingly in order to avoid temporary traffic loss. If BGP itself provides the reachability to open other BGP sessions, then stalepath-time should also be increased to accommodate for the extra time needed to converge the overlay session after the initial underlay session has already converged.

When a router detects that a graceful restart operation is in progress, both routers exchange their topology tables. When the router has route updates from all BGP peers, it removes all the stale routes and runs the best-path algorithm on the updated routes.

After the switchover, Cisco NX-OS applies the running configuration, and BGP informs the neighbors that it is operational again.

For single-hop iBGP peers with update-source configured under neighbor configuration mode, the peer supports fast external fall-over.

Beginning with Cisco NX-OS Release 9.3(3), BGP prefix peers support graceful restarts.

With the additional BGP paths feature, if the number of paths advertised for a given prefix is the same before and after restart, the choice of path ID guarantees the final state and removal of stale paths. If fewer paths are advertised for a given prefix after a restart, stale paths can occur on the graceful restart helper peer.

Low Memory Handling

BGP reacts to low memory for the following conditions:

- Minor alert—BGP does not establish any new eBGP peers. BGP continues to establish new iBGP peers and confederate peers. Established peers remain, but reset peers are not re-established.
- Severe alert—BGP shuts down select established eBGP peers every two minutes until the memory alert becomes minor. For each eBGP peer, BGP calculates the ratio of total number of paths received to the number of paths selected as best paths. The peers with the highest ratio are selected to be shut down to reduce memory usage. You must clear a shutdown eBGP peer before you can bring the eBGP peer back up to avoid oscillation.



Note You can exempt important eBGP peers from this selection process.

- Critical alert—BGP gracefully shuts down all the established peers. You must clear a shutdown BGP peer before you can bring the BGP peer back up.

See the [Tuning BGP](#) section for more information on how to exempt a BGP peer from a shutdown due to a low memory condition.

Virtualization Support

You can configure one BGP instance. BGP supports virtual routing and forwarding (VRF) instances.

Prerequisites for Advanced BGP

Advanced BGP has the following prerequisites:

- You must enable BGP (see the [Enabling BGP](#) section).
- You should have a valid router ID configured on the system.
- You must have an AS number, either assigned by a Regional Internet Registry (RIR) or locally administered.
- You must have reachability (such as an interior gateway protocol [IGP], a static route, or a direct connection) to the peer that you are trying to make a neighbor relationship with.
- You must explicitly configure an address family under a neighbor for the BGP session establishment.

Guidelines and Limitations for Advanced BGP

Advanced BGP has the following configuration guidelines and limitations:

- There are three scenarios in which the command behavior has changed beginning with Cisco NX-OS Release 9.3(5):

- Router bgp 1

```

      Template peer abc
        Ttl-security hops 30
      Neighbor 1.2.3.4
        Inherit peer abc
      
```

If you later enter the **ebgp-multihop 20** command, the configuration is blocked due to the presence of **ttl-security hops 30** command. Beginning with the Cisco NX-OS Release 9.3(5), the configuration is no longer blocked. However, the **ttl-security hops** command has priority and would be the enabled functionality.

- Router bgp 1

```

      Template peer abc
        Ebgp-multihops 20
      
```

```
Neighbor 1.2.3.4
  Inherit peer abc
```

If you later enter the **ttl-security hops 30** command, the configuration is blocked due to the presence of **ebgp-multihop 20** command. Beginning with Cisco NX-OS Release 9.3(5), the configuration is no longer blocked. However again, the **ttl-security hops** command has priority and would be the enabled functionality.

```
• Router bgp 1
  Template peer abc
    Remote-as 1
  Neighbor 1.2.3.4
    Inherit peer abc
```

If you later enter the **ttl-security hops 30** or **ebgp-multihop 20** commands, they are blocked. Beginning with Cisco NX-OS Release 9.3(5), the configuration is not blocked. However, their functionalities are turned off as the **remote-as** command has priority which makes the peer an iBGP peer.

- Prefix peering operates only in passive TCP mode. It accepts incoming connections from remote peers if the peer address falls within the prefix.
- Beginning with Cisco NX-OS 9.3(5), a packet with a TTL value of 1 to a vPC peer is hardware that is forwarded.
- Configuring the **advertise-maps** command multiple times is not supported.
- Names in the prefix-list are case-insensitive. We recommend using unique names. Do not use the same name by modifying uppercase and lowercase characters. For example, CTCPrimaryNetworks and CtcPrimaryNetworks are not two different entries.
- The dynamic AS number prefix peer configuration overrides the individual AS number configuration that is inherited from a BGP template.
- If you configure a dynamic AS number for prefix peers in an AS confederation, BGP establishes sessions with only the AS numbers in the local confederation.
- BGP sessions that are created through a dynamic AS number prefix peer ignore any configured eBGP multihop time-to-live (TTL) value or a disabled check for directly connected peers.
- Configure a router ID for BGP to avoid automatic router ID changes and session flaps.
- Use the maximum-prefix configuration option per peer to restrict the number of routes that are received and system resources used.
- Configure the update source to establish a session with eBGP multihop sessions.
- Specify a BGP route map if you configure a redistribution.
- Configure the BGP router ID within a VRF.
- If you decrease the keepalive and hold timer values, the network might experience session flaps.
- When you redistribute BGP to IGP, iBGP is redistributed as well. To override this behavior, you must insert an extra deny statement into the route map.
- To enable BFD for iBGP single-hop peers, you must configure the **update-source** option on the physical interface.

- Beginning with Cisco NX-OS Release 9.3(3), BFD for BGP is supported for BGP IPv4 and IPv6 prefix peers.
- The following guidelines and limitations apply to the **remove-private-as** command:
 - It applies only to eBGP peers.
 - It applies only to routers in a public AS only. The workaround to this restriction would be to apply the **neighbor local-as** command on a per-neighbor basis, with the local AS number being a public AS number.
 - It can be configured only in neighbor configuration mode and not in neighbor-address-family mode.
 - If the AS-path includes both private and public AS numbers, the private AS numbers are not removed.
 - If the AS-path contains the AS number of the eBGP neighbor, the private AS numbers are not removed.
 - Private AS numbers are removed only if all AS numbers in that AS-path belong to a private AS number range. Private AS numbers are not removed if a peer's AS number or a non-private AS number is found in the AS-path segment.
- If you use the **aggregate-address** command to configure aggregate addresses and the **suppress-fib-pending** command to suppress BGP routes, lossless traffic for aggregates cannot be ensured on BGP or system triggers.
- When you enable FIB suppression on the switch and route programming fails in the hardware, BGP advertises routes that are not programmed locally in the hardware.
- If you disable a command in the neighbor, template peer, template peer-session, or template peer-policy configuration mode (and the **inherit peer** or **inherit peer-session** command is present), you must use the **default** keyword to return the command to its default state. For example, to disable the **update-source loopback 0** command from the running configuration, you must enter the **default update-source loopback 0** command.
- When next-hop-self is configured for route-reflector clients, the route reflector advertises routes to its clients with itself as the next hop.
- The following guidelines and limitations apply to weighted ECMP:
 - Weighted ECMP is supported only for the IPv4 address family.
 - BGP uses the Link Bandwidth EXTCOMM defined in the draft-ietf-idr-link-bandwidth-06.txt to implement the weighted ECMP feature.
 - BGP accepts the Link Bandwidth EXTCOMM from both iBGP and eBGP peers.
- The following guidelines and limitations apply to BGP Interface Peering via IPv6 Link-Local for IPv4 and IPv6 Address Families:
 - This feature does not support having the same link-local address configured across multiple interfaces.
 - While configuring BGP interface peering using IP6 Link-Local static IPv6 address, ensure the subnet is matching with the peer for BGP to work.
 - This feature is not supported on logical interfaces (loopback). Only Ethernet interfaces, port-channel interfaces, subinterfaces, and breakout interfaces are supported.

- Beginning with Cisco NX-OS Release 9.3(6), VLAN interfaces are supported.
- This feature is supported only for IPv6-enabled interfaces with link-local addresses.
- This feature is not supported when the configured prefix peer and interface have the same remote peer.
- The following commands are not supported in neighbor interface configuration mode:
 - **disable-connected-check**
 - **maximum-peers**
 - **update-source**
 - **ebgp-multihop**
- BFD multihop and the following commands are not supported for BGP Interface Peering via IPv6 Link-Local for IPv4 and IPv6 Address Families:
 - **bfd-multihop**
 - **bfd multihop interval**
 - **bfd multihop authentication**
- BGP requires faster convergence time for route advertisements. To speed up detection of the Route Advertisement (RA) link-level protocol, enter the following commands on each IPv6-enabled interface that is using BGP Interface Peering via IPv6 Link-Local for IPv4 and IPv6 Address Families:

```
interface Ethernet port/slot
ipv6 nd ra-interval 4 min 3
ipv6 nd ra-lifetime 10
```

- When configuring the BGP neighbor with link-local, you need to customize the TCAM "ing-sup" from 512 to 768 except for Cisco Nexus 34XX-S platform, where default carving is sufficient.
- The command [**maximum-paths eibgp**] is supported only in MPLS environments.
- Route-map deletion feature adds a mechanism to block the deletion of entire route-map that is associated with the BGP. With the route-map deletion blocked, the modifications to the route-map statement are still allowed.
- If there are more than one sequence in the route-map, user can still delete any route map sequence until there is at least one sequence available.
- Users can have the forward reference case for route-map from client. However, once route-map is created and associated, the deletion of route-map is blocked.
- Blocking deletion functionality is configurable dynamically using the knob.
- It is allowed to delete the BGP association to the route-map and deletion of route-map itself in a single transaction payload.
- It is allowed to add the BGP association to the route-map and an error must be thrown for deletion of route-map.
- The following is the list of the dual stage related behaviors:

- If knob and deletion occur together, dual stage has to verify and throw an error without commit.
 - If knob already exists and route-map deletion occurs in dual stage, it must throw an error.
 - If route-map and CLI knob is single commit with different order, it must throw an error.
 - If knob is not enabled and route-map deletion occurs in dual stage, it has to execute successfully.
 - In a single verify, if "cli knob is disabled AND route-map deletion" is executed, the route-map deletion is allowed.
- If the route-map used by BGP template is not inherited by any of the BGP neighbors, the entire route-map deletion will still be blocked.
 - There are few commands under vrf context that are owned by BGP, but are not part of bgpInst.
 - Cloudscale IPv6 link-local BGP support requires carving > 512 ing-sup TCAM region (this requires a reload to take effect).
 - As the VPN address family (L3VPN and EVPN) is not supported, the routes received from confederate peers are not advertised in the VPN address family.
 - Beginning with Cisco NX-OS Release 10.3(1)F, BGP is supported on the Cisco Nexus 9808 switches.
 - Beginning with Cisco NX-OS Release 10.4(1)F, BGP is supported on the Cisco Nexus 9804 switches.
 - Beginning with Cisco NX-OS Release 10.3(1)F, VXLAN EVPN is supported only as transit on Cisco Nexus 9808 switches.
 - Beginning with Cisco NX-OS Release 10.4(1)F, VXLAN EVPN is supported only as transit on Cisco Nexus 9804 switches.
 - Beginning with Cisco NX-OS Release 10.3(3)F, Type-6 encryption for BGP password is supported on Cisco NX-OS switches with the following limitations:
 - If Type-6 encryption is configured, you won't be able to modify the existing Type-6 encrypted password to Type-0/Type-3/Type-7 password.
 - If you downgrade the system by cold reboot with an old image where Type-6 encryption is not supported, ensure to remove the Type-6 configuration and then proceed with cold reboot. Otherwise there will be configuration loss, the results are such that there is no configuration for the neighbor.
 - Primary key configuration is local to the switch. If you take the Type-6 configured running data from one switch and try to apply it on other switch where different primary key is configured, decryption on the new switch will fail.
 - During ISSU, if you migrate from old image (where Type-0/Type-3/Type-7 encrypted keys are there in the configuration) to new image (where Type-6 encryption is supported), BGP won't convert the existing keys to Type-6 encrypted one until or unless reencryption is enforced using the **encryption re-encrypt obfuscated** command.
 - BGP Type-6 passwords will not be supported in non-DME platforms.
 - It is highly recommended for user to specify the password type and password when programmatically (RESTCONF, NETCONF and so on) configuring a neighbor or template's password. When either one of the property is missing in the programmatic call, BGP will use already available (or default) value of the missing property to configure the neighbor or template's password.

If the user has to configure with a property missing then the user has to follow the same sequence of steps in both peer routers.

- Beginning with Cisco NX-OS Release 10.4(1)F, BGP is supported on Cisco Nexus X98900CD-A and X9836DM-A line cards with 9808 and 9804 switches.

Default Settings

The table lists the default settings for advanced BGP parameters.

Parameters	Default
BGP feature	Disabled
BGP additional paths	Disabled
Keep alive interval	60 seconds
Hold timer	180 seconds
Dynamic capability	Enabled

Configuring Advanced BGP

Enabling IP Forward on an Interface

To use RFC 5549, you must configure at least one IPv4 address. If you do not want to configure an IPv4 address, you must enable the IP forward feature to use RFC 5549.

SUMMARY STEPS

1. **configure terminal**
2. **interface** *type slot/port*
3. **ip forward**
4. (Optional) **copy running-config startup-config**

DETAILED STEPS

	Command or Action	Purpose
Step 1	configure terminal Example: <pre>switch# configure terminal switch(config)#</pre>	Enters global configuration mode.
Step 2	interface <i>type slot/port</i> Example:	Enters interface configuration mode.

	Command or Action	Purpose
	<pre>switch(config)# interface ethernet 1/2 switch(config-if)#</pre>	
Step 3	ip forward Example: <pre>switch(config-if)# ip forward</pre>	Allows IPv4 traffic on the interface even when there is no IP address configuration on that interface.
Step 4	(Optionally) copy running-config startup-config Example: <pre>switch(config-if)# copy running-config startup-config</pre>	Saves this configuration change.

Configuring BGP Session Templates

You can use BGP session templates to simplify the BGP configuration for multiple BGP peers with similar configuration needs. BGP templates allow you to reuse common configuration blocks. You configure BGP templates first and then apply these templates to BGP peers.

With BGP session templates, you can configure session attributes such as inheritance, passwords, timers, and security.

A peer-session template can inherit from one other peer-session template. You can configure the second template to inherit from a third template. The first template also inherits this third template. This indirect inheritance can continue for up to seven peer-session templates.

Any attributes configured for the neighbor take priority over any attributes inherited by that neighbor from a BGP template.

Before you begin

You must enable BGP (see the [Enabling BGP](#) section).



Note

- When editing a template, you can use the **no** form of a command at either the peer or template level to explicitly override a setting in a template. You must use the default form of the command to reset that attribute to the default state.
- When using BGP Peer Template, there is no check for the commands used inside template to verify if that command applies to iBGP/eBGP peer or not. For example if you create a template and add a command "Remove-private-as" inside a template and then assign this template to iBGP peer, then no error will be printed saying this command "Remove-private-as" does not apply to iBGP peer.

SUMMARY STEPS

1. **configure terminal**
2. **router bgp** *autonomous-system-number*
3. **template peer-session** *template-name*
4. (Optional) **password** *number password*

5. (Optional) **timers** *keepalive hold*
6. **exit**
7. **neighbor** *ip-address remote-as as-number*
8. **inherit peer-session** *template-name*
9. (Optional) **description** *text*
10. (Optional) **show bgp peer-session** *template-name*
11. (Optional) **copy running-config startup-config**

DETAILED STEPS

	Command or Action	Purpose
Step 1	configure terminal Example: <pre>switch# configure terminal switch(config)#</pre>	Enters global configuration mode.
Step 2	router bgp <i>autonomous-system-number</i> Example: <pre>switch(config)# router bgp 65535 switch(config-router)#</pre>	Enables BGP and assigns the autonomous system number to the local BGP speaker.
Step 3	template peer-session <i>template-name</i> Example: <pre>switch(config-router)# template peer-session BaseSession switch(config-router-stmp)#</pre>	Enters peer-session template configuration mode.
Step 4	(Optional) password <i>number password</i> Example: <pre>switch(config-router-stmp)# password 0 test</pre>	Adds the clear text password test to the neighbor. The password is stored and displayed in type 3 encrypted form (3DES).
Step 5	(Optional) timers <i>keepalive hold</i> Example: <pre>switch(config-router-stmp)# timers 30 90</pre>	Adds the BGP keepalive and holdtimer values to the peer-session template. The default keepalive interval is 60. The default hold time is 180.
Step 6	exit Example: <pre>switch(config-router-stmp)# exit switch(config-router)#</pre>	Exits peer-session template configuration mode.
Step 7	neighbor <i>ip-address remote-as as-number</i> Example: <pre>switch(config-router)# neighbor 192.168.1.2 remote-as 65535 switch(config-router-neighbor)#</pre>	Places the router in the neighbor configuration mode for BGP routing and configures the neighbor IP address.

	Command or Action	Purpose
Step 8	inherit peer-session <i>template-name</i> Example: <pre>switch(config-router-neighbor) # inherit peer-session BaseSession switch(config-router-neighbor) #</pre>	Applies a peer-session template to the peer.
Step 9	(Optional) description <i>text</i> Example: <pre>switch(config-router-neighbor) # description Peer Router A switch(config-router-neighbor) #</pre>	Adds a description for the neighbor.
Step 10	(Optional) show bgp peer-session <i>template-name</i> Example: <pre>switch(config-router-neighbor) # show bgp peer-session BaseSession</pre>	Displays the peer-policy template.
Step 11	(Optional) copy running-config startup-config Example: <pre>switch(config-router-neighbor) # copy running-config startup-config</pre>	Saves this configuration change. Use the show bgp neighbor command to see the template applied.

Example

This example shows how to configure a BGP peer-session template and apply it to a BGP peer:

```
switch# configure terminal
switch(config)# router bgp 65536
switch(config-router)# template peer-session BaseSession
switch(config-router-stmp)# timers 30 90
switch(config-router-stmp)# exit
switch(config-router)# neighbor 192.168.1.2 remote-as 65536
switch(config-router-neighbor)# inherit peer-session BaseSession
switch(config-router-neighbor)# description Peer Router A
switch(config-router-neighbor)# address-family ipv4 unicast
switch(config-router-neighbor-af)# copy running-config startup-config
```

Configuring BGP Peer-Policy Templates

You can configure a peer-policy template to define attributes for a particular address family. You assign a preference to each peer-policy template and these templates are inherited in the order specified, for up to five peer-policy templates in a neighbor address family.

Cisco NX-OS evaluates multiple peer policies for an address family using the preference value. The lowest preference value is evaluated first. Any attributes configured for the neighbor take priority over any attributes inherited by that neighbor from a BGP template.

Peer-policy templates can configure address family-specific attributes such as AS-path filter lists, prefix lists, route reflection, and soft reconfiguration.



Note Use the **show bgp neighbor** command to see the template applied. See the *Cisco Nexus 9000 Series NX-OS Unicast Routing Command Reference*, for details on all commands available in the template.

Before you begin

You must enable BGP (see the [Enabling BGP](#) section).



Note When editing a template, you can use the **no** form of a command at either the peer or template level to explicitly override a setting in a template. You must use the default form of the command to reset that attribute to the default state.

SUMMARY STEPS

1. **configure terminal**
2. **router bgp** *autonomous-system-number*
3. **template peer-session** *template-name*
4. (Optional) **advertise-active-only**
5. (Optional) **maximum-prefix** *number*
6. **exit**
7. **neighbor** *ip-address* **remote-as** *as-number*
8. **address-family** {*ipv4* | *ipv6*} {**multicast** | **unicast**}
9. **inherit peer-policy** *template-name* *preference*
10. (Optional) **show bgp peer-policy** *template-name*
11. (Optional) **copy running-config startup-config**

DETAILED STEPS

	Command or Action	Purpose
Step 1	configure terminal Example: switch# configure terminal	Enters configuration mode.
Step 2	router bgp <i>autonomous-system-number</i> Example: switch(config)# router bgp 65535 switch(config-router)#	Enables BGP and assigns the autonomous system number to the local BGP speaker.
Step 3	template peer-session <i>template-name</i> Example: switch(config-router)# template peer-policy BasePolicy switch(config-router-ptmp)#	Creates a peer-policy template.

	Command or Action	Purpose
Step 4	(Optional) advertise-active-only Example: switch(config-router-ptmp) # advertise-active-only	Advertises only active routes to the peer.
Step 5	(Optional) maximum-prefix <i>number</i> Example: switch(config-router-ptmp) # maximum-prefix 20	Sets the maximum number of prefixes allowed from this peer.
Step 6	exit Example: switch(config-router-ptmp) # exit switch(config-router) #	Exits peer-policy template configuration mode.
Step 7	neighbor <i>ip-address</i> remote-as <i>as-number</i> Example: switch(config-router) # neighbor 192.168.1.2 remote-as 65535 switch(config-router-neighbor) #	Places the router in the neighbor configuration mode for BGP routing and configures the neighbor IP address.
Step 8	address-family { ipv4 ipv6 } { multicast unicast } Example: switch(config-router-neighbor) # address-family ipv4 unicast switch(config-router-neighbor-af) #	Enters global address family configuration mode for the address family specified.
Step 9	inherit peer-policy <i>template-name</i> <i>preference</i> Example: switch(config-router-neighbor-af) # inherit peer-policy BasePolicy 1	Applies a peer-policy template to the peer address family configuration and assigns the preference value for this peer policy.
Step 10	(Optional) show bgp peer-policy <i>template-name</i> Example: switch(config-router-neighbor-af) # show bgp peer-policy BasePolicy	Displays the peer-policy template.
Step 11	(Optional) copy running-config startup-config Example: switch(config-router-neighbor-af) # copy running-config startup-config	Saves this configuration change. Use the show bgp neighbor command to see the template applied.

Example

This example shows how to configure a BGP peer-policy template and apply it to a BGP peer:

```

switch# configure terminal
switch(config)# router bgp 65536
switch(config-router)# template peer-session BasePolicy
switch(config-router-ptmp)# maximum-prefix 20
switch(config-router-ptmp)# exit
switch(config-router)# neighbor 192.168.1.1 remote-as 65536
switch(config-router-neighbor)# address-family ipv4 unicast
switch(config-router-neighbor-af)# inherit peer-policy BasePolicy
switch(config-router-neighbor-af)# copy running-config startup-config

```

Configuring BGP Peer Templates

You can configure BGP peer templates to combine session and policy attributes in one reusable configuration block. Peer templates can also inherit peer-session or peer-policy templates. Any attributes configured for the neighbor take priority over any attributes inherited by that neighbor from a BGP template. You configure only one peer template for a neighbor, but that peer template can inherit peer-session and peer-policy templates.

Peer templates support session and address family attributes, such as eBGP multihop time-to-live, maximum prefix, next-hop self, and timers.

Before you begin

You must enable BGP (see the [Enabling BGP](#) section).



Note When editing a template, you can use the **no** form of a command at either the peer or template level to explicitly override a setting in a template. You must use the default form of the command to reset that attribute to the default state.

SUMMARY STEPS

1. **configure terminal**
2. **router bgp** *autonomous-system-number*
3. **template peer** *template-name*
4. (Optional) **inherit peer-session** *template-name*
5. (Optional) **address-family** {*ipv4|ipv6*} {**multicast|unicast**}
6. (Optional) **inherit peer-policy** *template-name*
7. **exit**
8. (Optional) **timers** *keepalive hold*
9. **exit**
10. **neighbor** *ip-address* **remote-as** *as-number*
11. **inherit peer** *template-name*
12. (Optional) **timers** *keepalive hold*
13. (Optional) **show bgp peer-template** *template-name*
14. (Optional) **copy running-config startup-config**

DETAILED STEPS

	Command or Action	Purpose
Step 1	configure terminal Example: switch# configure terminal	Enters global configuration mode.
Step 2	router bgp <i>autonomous-system-number</i> Example: switch(config)# router bgp 65535	Enters BGP mode and assigns the autonomous system number to the local BGP speaker.
Step 3	template peer <i>template-name</i> Example: switch(config-router)# template peer BasePeer	Enters peer template configuration mode.
Step 4	(Optional) inherit peer-session <i>template-name</i> Example: switch(config-router-neighbor)# inherit peer-session BaseSession	Adds a peer-session template to the peer template.
Step 5	(Optional) address-family { ipv4 ipv6 } { multicast unicast } Example: switch(config-router-neighbor)# address-family ipv4 unicast switch(config-router-neighbor-af)	Configures the global address family configuration mode for the specified address family.
Step 6	(Optional) inherit peer-policy <i>template-name</i> Example: switch(config-router-neighbor-af)# inherit peer-policy BasePolicy 1	Applies a peer-policy template to the neighbor address family configuration.
Step 7	exit Example: switch(config-router-neighbor-af)# exit	Exits BGP neighbor address family configuration mode.
Step 8	(Optional) timers <i>keepalive hold</i> Example: switch(config-router-neighbor)# timers 45 100	Adds the BGP timer values to the peer. These values override the timer values in the peer-session template, BaseSession.
Step 9	exit Example: switch(config-router-neighbor)# exit	Exits BGP neighbor configuration mode.
Step 10	neighbor <i>ip-address</i> remote-as <i>as-number</i> Example:	Places the router in neighbor configuration mode for BGP routing and configures the neighbor IP address.

	Command or Action	Purpose
	<pre>switch(config-router)# neighbor 192.168.1.2 remote-as 65535 switch(config-router-neighbor)#</pre>	
Step 11	<p>inherit peer <i>template-name</i></p> <p>Example:</p> <pre>switch(config-router-neighbor)# inherit peer BasePeer</pre>	Inherits the peer template.
Step 12	<p>(Optional) timers <i>keepalive hold</i></p> <p>Example:</p> <pre>switch(config-router-neighbor)# timers 60 120</pre>	<p>Adds the BGP timer values to this neighbor.</p> <p>These values override the timer values in the peer template and the peer-session template.</p>
Step 13	<p>(Optional) show bgp peer-template <i>template-name</i></p> <p>Example:</p> <pre>switch(config-router-neighbor)# show bgp peer-template BasePeer</pre>	Displays the peer template.
Step 14	<p>(Optional) copy running-config startup-config</p> <p>Example:</p> <pre>switch(config-router-neighbor)# copy running-config startup-config</pre>	<p>Saves this configuration change.</p> <p>Use the show bgp neighbor command to see the template applied.</p>

Example

This example shows how to configure a BGP peer template and apply it to a BGP peer:

```
switch# configure terminal
switch(config)# router bgp 65536
switch(config-router)# template peer BasePeer
switch(config-router-neighbor)# inherit peer-session BaseSession
switch(config-router-neighbor)# address-family ipv4 unicast
switch(config-router-neighbor-af)# inherit peer-policy BasePolicy 1
switch(config-router-neighbor-af)# exit
switch(config-router-neighbor)# exit
switch(config-router)# neighbor 192.168.1.2 remote-as 65536
switch(config-router-neighbor)# inherit peer BasePeer
switch(config-router-neighbor)# copy running-config startup-config
```

Configuring Prefix Peering

BGP supports the definition of a set of peers using a prefix for both IPv4 and IPv6. This feature allows you to not have to add each neighbor to the configuration.

When defining a prefix peering, you must specify the remote AS number with the prefix. BGP accepts any peer that connects from that prefix and autonomous system if the prefix peering does not exceed the configured maximum peers allowed.

When a BGP peer that is part of a prefix peering disconnects, Cisco NX-OS holds its peer structures for a defined prefix peer timeout value. An established peer can reset and reconnect without danger of being blocked because other peers have consumed all slots for that prefix peering.

SUMMARY STEPS

1. **timers prefix-peer-timeout** *value*
2. **maximum-peers** *value*

DETAILED STEPS

	Command or Action	Purpose
Step 1	timers prefix-peer-timeout <i>value</i> Example: <pre>switch(config-router-neighbor)# timers prefix-peer-timeout 120</pre>	Configures the BGP prefix peering timeout value in router configuration mode. The range is from 0 to 1200 seconds. The default value is 30. Note For prefix peers, set the prefix peer timeout to be greater than the configured graceful restart timer. If the prefix peer timeout is greater than the graceful restart timer, a peer's route is retained during its restart. If the prefix peer timeout is less than the graceful restart timer, the peer's route is purged by the prefix peer timeout, which may occur before the restart is complete.
Step 2	maximum-peers <i>value</i> Example: <pre>switch(config-router-neighbor)# maximum-peers 120</pre>	Configures the maximum number of peers for this prefix peering in neighbor configuration mode. The range is from 1 to 1000.

Example

This example shows how to configure a prefix peering that accepts up to 10 peers:

```
switch(config)# router bgp 65536
switch(config-router)# timers prefix-peer-timeout 120
switch(config-router)# neighbor 10.100.200.0/24 remote-as 65536
switch(config-router-neighbor)# maximum-peers 10
switch(config-router-neighbor)# address-family ipv4 unicast
switch(config-router-neighbor-af)#
```

Use the **show bgp ipv4 unicast neighbors** command to show the details of the configuration for that prefix peering with a list of the currently accepted instances and the counts of active, maximum concurrent, and total accepted peers.

Configuring BGP Interface Peering via IPv6 Link-Local for IPv4 and IPv6 Address Families

You can configure BGP Interface Peering via IPv6 Link-Local for IPv4 and IPv6 Address Families for automatic BGP neighbor discovery using unnumbered interfaces. Doing so allows you to set up BGP sessions using an interface name as a BGP peer (rather than interface-scoped addresses). This feature relies on ICMPv6 neighbor discovery (ND) route advertisement (RA) for automatic neighbor discovery and on RFC 5549 for sending IPv4 routes with IPv6 next hop.

Before you begin

You must enable BGP (see the [Enabling BGP](#) section).

Procedure

	Command or Action	Purpose
Step 1	configure terminal Example: <code>switch# configure terminal</code>	Enters configuration mode.
Step 2	router bgp <i>autonomous-system-number</i> Example: <code>switch(config)# router bgp 65535</code> <code>switch(config-router)#</code>	Enables BGP and assigns the autonomous system number to the local BGP speaker. The AS number can be a 16-bit integer or a 32-bit integer in the form of a higher 16-bit decimal number and a lower 16-bit decimal number in xx.xx format.
Step 3	neighbor <i>interface-name</i> remote-as {<i>as-number</i> route-map <i>map-name</i>} Example: <code>switch(config-router)# neighbor</code> <code>Ethernet1/1 remote-as 65535</code> <code>switch(config-router-neighbor)#</code>	Places the router in the neighbor configuration mode for BGP routing and configures the interface for BGP peering. Note You can specify only Ethernet interfaces, port-channel interfaces, subinterfaces, and breakout interfaces. Beginning with Cisco NX-OS Release 9.3(6), you can specify a route map, which can contain AS lists and ranges. See Dynamic AS Numbers for Prefix Peers and Interface Peers, on page 283 for more information about using dynamic AS numbers. <i>interface-name</i> can be a range if the configuration needs to be applied to more than one interface.
Step 4	inherit peer <i>template-name</i> Example: <code>switch(config-router-neighbor)# inherit peer PEER</code>	Inherits the peer template.
Step 5	address-family {<i>ipv4</i> <i>ipv6</i>} unicast Example:	Enters global address family configuration mode for the address family specified.

	Command or Action	Purpose
	<pre>switch(config-router-neighbor) # address-family ipv4 unicast switch(config-router-neighbor-af) #</pre>	
Step 6	<p>(Optional) show bgp {ipv4 ipv6} unicast neighbors interface</p> <p>Example:</p> <pre>switch(config-router-neighbor-af) # show bgp ipv4 unicast neighbors e1/25</pre> <p>Example:</p> <pre>switch(config-router-neighbor-af) # show bgp ipv6 unicast neighbors 3FFE:700:20:1::11</pre>	Displays information about BGP peers.
Step 7	<p>(Optional) show ip bgp neighbors interface-name</p> <p>Example:</p> <pre>switch(config-router-neighbor-af) # show ip bgp neighbors Ethernet1/1</pre>	Displays the interface used as a BGP peer.
Step 8	<p>(Optional) show ipv6 routers [interface interface]</p> <p>Example:</p> <pre>switch(config-router-neighbor-af) # show ipv6 routers interface Ethernet1/1</pre>	Displays the link-local address of remote IPv6 routers, which is learned through IPv6 ICMP router advertisement.
Step 9	<p>(Optional) copy running-config startup-config</p> <p>Example:</p> <pre>switch(config-router-neighbor-af) # copy running-config startup-config</pre>	Saves this configuration change.

Example

This example shows how to configure BGP Interface Peering via IPv6 Link-Local for IPv4 and IPv6 Address Families.

iBGP Interface Peering Configuration for Leaf 1:

```
switch# configure terminal
switch(config)# router bgp 65000
switch(config-router)# neighbor Ethernet1/1 remote-as 65000
switch(config-router-neighbor)# inherit peer PEER
switch(config-router-neighbor)# address-family ipv4 unicast
switch(config-router-neighbor)# address-family ipv6 unicast
switch(config-router-neighbor-af)# copy running-config startup-config
```

This example shows sample output for BGP Interface Peering via IPv6 Link-Local for IPv4 and IPv6 Address Families:

```
switch(config-router-neighbor)# show bgp ipv4 unicast neighbors e1/15.1
BGP neighbor is fe80::2, remote AS 100, ibgp link, Peer index 4
Peer is an instance of interface peering Ethernet1/15.1
BGP version 4, remote router ID 5.5.5.5
Neighbor previous state = OpenConfirm
```

```

BGP state = Established, up for 2d16h
Neighbor vrf: default
Peer is directly attached, interface Ethernet1/15.1
Last read 00:00:54, hold time = 180, keepalive interval is 60 seconds
Last written 00:00:08, keepalive timer expiry due 00:00:51
Received 3869 messages, 0 notifications, 0 bytes in queue
Sent 3871 messages, 0 notifications, 0(0) bytes in queue
Enhanced error processing: On
0 discarded attributes
Connections established 2, dropped 1
Last reset by peer 2d16h, due to session closed
Last error length received: 0
Reset error value received 0
Reset error received major: 104 minor: 0
Notification data received:
Last reset by us never, due to No error
Last error length sent: 0
Reset error value sent: 0
Reset error sent major: 0 minor: 0
--More--

```

Interface Configuration:

IPv6 needs to be enabled on the corresponding interface using one of the following commands:

- **ipv6 address** *ipv6-address*
- **ipv6 address use-link-local-only**
- **ipv6 link-local** *link-local-address*

```

switch# configure terminal
switch(config)# interface Ethernet1/1
switch(config-if)# ipv6 address use-link-local-only

```



Note If an IPv4 address is not configured on the interface, the **ip forward** command must be configured on the interface to enable IPv4 forwarding.



Note IPv6 ND timers can be tuned to speed up neighbor discovery and for BGP faster route convergence.

```

switch(config-if)# ipv6 nd ra-interval 4 min 3
switch(config-if)# ipv6 nd ra-lifetime 10

```



Note Beginning with Cisco NX-OS Release 9.3(6), for customer deployments with parallel links, the following command must be added in interface mode:

```

switch(config-if)# ipv6 link-local use-bia

```

The command makes IPv6 LLA unique across different interfaces.

Configuring BGP Authentication

You can configure BGP to authenticate route updates from peers using MD5 digests.

Alternatively, beginning with Cisco NX-OS Release 10.4(2)F, you can configure BGP to authenticate route updates from peers using TCP Authentication Option (TCP AO).

Beginning with Cisco NX-OS Release 10.3(3)F, Type-6 encryption for BGP password is supported on Cisco NX-OS switches. Following encryption types are supported:

- AES based encryption
- A configurable encryption-key called as primary-key is used for encryption and decryption of secrets.

To configure BGP to use MD5 digests or TCP AO, use the following command in neighbor configuration mode:

Before you begin

- Ensure the primary-key is configured using the **key config-key ascii** *<primary_key>* command on Cisco NX-OS switches.
- For Type-6 encryption to function properly, ensure **feature password encryption aes** is enabled on Cisco NX-OS switches.
- See [Configuring TCP Authentication Option](#) to configure and use TCP keychain authentication option for BGP neighbor session authentication.

SUMMARY STEPS

1. **key config-key ascii** *<primary_key>*
2. **configure terminal**
3. **feature password encryption aes**
4. **router bgp** *AS number*
5. **template peer** *template name*
6. **password** {0 | 3 | 7 | 6} *string*
7. (Optional) **encryption re-encrypt obfuscated**
8. (Optional) **encryption delete type-6**
9. (Optional) **ao** *<Keychain-name>* [**include-tcp-options**]

DETAILED STEPS

	Command or Action	Purpose
Step 1	key config-key ascii <i><primary_key></i> Example:	Configures the primary-key.

	Command or Action	Purpose
	switch# key config-key ascii 0123456789012345	<p>Note</p> <ul style="list-style-type: none"> • Enter this command only if the primary key is not configured. • If the primary key is already configured and if you enter this command, you are actually modifying the existing primary-key value. To modify to the new value, enter the existing primary-key value when prompted.
Step 2	<p>configure terminal</p> <p>Example:</p> <pre>switch# configure terminal</pre>	Enters global configuration mode.
Step 3	<p>feature password encryption aes</p> <p>Example:</p> <pre>switch(config)# feature password encryption aes</pre>	Enables the AES password encryption.
Step 4	<p>router bgp AS number</p> <p>Example:</p> <pre>switch(config-router)# router bgp 1</pre>	Enters to BGP router mode.
Step 5	<p>template peer template name</p> <p>Example:</p> <pre>switch(config-router-neighbor)# template peer abc</pre>	Enters to BGP neighbor mode.
Step 6	<p>password {0 3 7 6} string</p> <p>Example:</p> <pre>switch(config-router-neighbor)# password 6 1M6L6257E7y02c371Qc/2Lank7PNy/E6ygnWHPwSCeP0r81Q1s3XGTA=</pre>	<p>Configures an MD5 password for BGP neighbor sessions.</p> <p>Note When you configure the Type-0/Type-3/Type-7 newly, if primary-key is configured and then if feature password encryption aes is enabled, the Type-0/3/7 is automatically encrypted to the Type-6 password.</p>
Step 7	<p>(Optional) encryption re-encrypt obfuscated</p> <p>Example:</p> <pre>switch# encryption re-encrypt obfuscated</pre>	Encrypts the existing Type-0/Type-3/Type-7 password to Type-6 password.
Step 8	<p>(Optional) encryption delete type-6</p> <p>Example:</p> <pre>switch# encryption delete type-6</pre>	Deletes the Type-6 encrypted password.
Step 9	(Optional) ao <Keychain-name> [include-tcp-options]	Configures option to specify whether the TCP option headers (other than TCP AO option) will be included while computing the MAC digest of the packets.

Resetting a BGP Session

If you modify a route policy for BGP, you must reset the associated BGP peer sessions. If the BGP peers do not support route refresh, you can configure a soft reconfiguration for inbound policy changes. Cisco NX-OS automatically attempts a soft reset for the session.

To configure soft reconfiguration inbound, use the following command in neighbor address-family configuration mode:

SUMMARY STEPS

1. **soft-reconfiguration inbound**
2. (Optional) **clear bgp {ipv4 | ipv6} {unicast | multicast} ip-address soft {in | out}**
3. **clear bgp {ipv4 | ipv6} {unicast | multicast} ip-address soft (in | out)**

DETAILED STEPS

	Command or Action	Purpose
Step 1	soft-reconfiguration inbound Example: switch(config-router-neighbor-af)# soft-reconfiguration inbound	Enables soft reconfiguration to store the inbound BGP route updates. This command triggers an automatic soft clear or refresh of BGP neighbor sessions.
Step 2	(Optional) clear bgp {ipv4 ipv6} {unicast multicast} ip-address soft {in out} Example: switch# clear bgp ip unicast 192.0.2.1 soft in	Resets the BGP session without tearing down the TCP session.
Step 3	clear bgp {ipv4 ipv6} {unicast multicast} ip-address soft (in out) Example: switch# clear bgp ip unicast 192.0.2.1 soft in	Resets the BGP session without tearing down the TCP session.

Modifying the Next-Hop Address

You can modify the next-hop address used in a route advertisement in the following ways:

- Disable next-hop calculation and use the local BGP speaker address as the next-hop address.
- Set the next-hop address as a third-party address. Use this feature in situations where the original next-hop address is on the same subnet as the peer that the route is being sent to. Using this feature saves an extra hop during forwarding.

To modify the next-hop address, use the following commands in address-family configuration mode:

SUMMARY STEPS

1. **next-hop-self**

2. next-hop-third-party

DETAILED STEPS

	Command or Action	Purpose
Step 1	next-hop-self Example: <pre>switch(config-router-neighbor-af) # next-hop-self</pre>	Uses the local BGP speaker address as the next-hop address in route updates. This command triggers an automatic soft clear or refresh of BGP neighbor sessions.
Step 2	next-hop-third-party Example: <pre>switch(config-router-neighbor-af) # next-hop-third-party</pre>	Sets the next-hop address as a third-party address. Use this command for single-hop eBGP peers that do not have next-hop-self configured.

Configuring BGP Next-Hop Address Tracking

BGP next-hop address tracking is enabled by default and cannot be disabled.

You can modify the delay interval between RIB checks to increase the performance of BGP next-hop tracking.

To modify the BGP next-hop address tracking, use the following commands in address-family configuration mode:

SUMMARY STEPS

1. `nexthop trigger-delay {critical | non-critical} milliseconds`

DETAILED STEPS

	Command or Action	Purpose
Step 1	nexthop trigger-delay {critical non-critical} milliseconds Example: <pre>switch(config-router-af) # nexthop trigger-delay critical 5000</pre>	Specifies the next-hop address tracking delay timer for critical next-hop reachability routes and for noncritical routes. The range is from 1 to 4294967295 milliseconds. The critical timer default is 3000. The noncritical timer default is 10000.

Configuring Next-Hop Filtering

BGP next-hop filtering allows you to specify that when a next-hop address is checked with the RIB, the underlying route for that next-hop address is passed through the route map. If the route map rejects the route, the next-hop address is treated as unreachable.

BGP marks all next hops that are rejected by the route policy as invalid and does not calculate the best path for the routes that use the invalid next-hop address.

To configure BGP next-hop filtering, use the following command in address-family configuration mode:

SUMMARY STEPS

1. `nexthop route-map name`

DETAILED STEPS

	Command or Action	Purpose
Step 1	nexthop route-map name Example: <pre>switch(config-router-af) # nexthop route-map nextHopLimits</pre>	Specifies a route map to match the BGP next-hop route to. The name can be any case-sensitive, alphanumeric string up to 63 characters.

Configuring Next-Hop Resolution via Default Route

BGP next-hop resolution allows you to specify if the IP default route is used for BGP next-hop resolution.

To configure BGP next-hop resolution, use the following command in router configuration mode:

SUMMARY STEPS

1. `[no] nexthop suppress-default-resolution`

DETAILED STEPS

	Command or Action	Purpose
Step 1	[no] nexthop suppress-default-resolution Example: <pre>switch(config-router) # nexthop suppress-default-resolution</pre>	Prevents resolution of BGP next hop through the IP default route. When this command is enabled: <ul style="list-style-type: none"> • The output of the show bgp process detail command includes the following line: Use default route for nexthop resolution: No • The output of the show routing clients bgp command includes the following line: Owned rnh will never resolve to 0.0.0.0/0

Controlling Reflected Routes Through Next-Hop-Self

NX-OS enables controlling the iBGP routes being sent to a specific peer through the **next-hop-self** [all] arguments. By using these arguments, you can selectively change the next-hop of routes even if the route is reflected.

Command	Purpose
next-hop-self [all] Example: <pre>switch(config-router-af) # next-hop-self all</pre>	Uses the local BGP speaker address as the next-hop address in route updates. The all keyword is optional. If you specify all, all routes are sent to the peer with next-hop-self. If you do not specify all, the next hops of reflected routes are not changed.

Shrinking Next-Hop Groups When A Session Goes Down

You can configure BGP to shrink ECMP groups in an accelerated way when a session goes down.

This feature applies to the following BGP path failure events:

- Any single or multiple Layer 3 link failures
- Line card failures
- BFD failure detections for BGP neighbors
- Administrative shutdown of BGP neighbors (using the shutdown command)

The accelerated handling of the first two events (Layer 3 link failures and line card failures) is enabled by default and does not require a configuration command to be enabled.

To configure the accelerated handling of the last two events, use the following command in router configuration mode:

SUMMARY STEPS

1. **neighbor-down fib-accelerate**

DETAILED STEPS

	Command or Action	Purpose
Step 1	neighbor-down fib-accelerate Example: <pre>switch(config-router) # neighbor-down fib-accelerate</pre>	Withdraws the corresponding next hop from all next-hop groups (ECMP groups and single next-hop routes) whenever a BGP session goes down. Note This command applies to both IPv4 and IPv6 routes.

Disabling Capabilities Negotiation

You can disable capabilities negotiations to interoperate with older BGP peers that do not support capabilities negotiation.

To disable capabilities negotiation, use the following command in neighbor configuration mode:

SUMMARY STEPS

1. **dont-capability-negotiate**

DETAILED STEPS

	Command or Action	Purpose
Step 1	dont-capability-negotiate Example: <pre>switch(config-router-neighbor) # dont-capability-negotiate</pre>	Disables capabilities negotiation. You must manually reset the BGP sessions after configuring this command.

Disabling Policy Batching

In BGP deployments where prefixes have unique attributes, BGP tries to identify routes with similar attributes to bundle in the same BGP update message. To avoid the overhead of this additional BGP processing, you can disable batching.

Cisco recommends that you disable policy batching for BGP deployments that have a large number of routes with unique next hops.

To disable policy batching, use the following command in router configuration mode:

SUMMARY STEPS

1. **disable-policy-batching**

DETAILED STEPS

	Command or Action	Purpose
Step 1	disable-policy-batching Example: <pre>switch(config-router) # disable-policy-batching</pre>	Disables the batching evaluation of prefix advertisements to all peers.

Configuring BGP Additional Paths

BGP supports sending and receiving multiple paths per prefix and advertising such paths.

Advertising the Capability of Sending and Receiving Additional Paths

You can configure BGP to advertise the capability of sending and receiving additional paths to and from the BGP peers. To do so, use the following commands in neighbor address-family configuration mode:

SUMMARY STEPS

1. **[no] capability additional-paths send [disable]**

2. `[no] capability additional-paths receive [disable]`
3. `show bgp neighbor`

DETAILED STEPS

	Command or Action	Purpose
Step 1	<p><code>[no] capability additional-paths send [disable]</code></p> <p>Example:</p> <pre>switch(config-router-neighbor-af)# capability additional-paths send</pre>	<p>Advertises the capability to send additional paths to the BGP peer. The disable option disables the advertising capability of sending additional paths.</p> <p>The no form of this command disables the capability of sending additional paths.</p>
Step 2	<p><code>[no] capability additional-paths receive [disable]</code></p> <p>Example:</p> <pre>switch(config-router-neighbor-af)# capability additional-paths receive</pre>	<p>Advertises the capability to receive additional paths from the BGP peer. The disable option disables the advertising capability of receiving additional paths.</p> <p>The no form of this command disables the capability of receiving additional paths.</p>
Step 3	<p><code>show bgp neighbor</code></p> <p>Example:</p> <pre>switch(config-router-neighbor-af)# show bgp neighbor</pre>	<p>Displays whether the local peer has advertised the additional paths send or receive capability to the remote peer.</p>

Example

This example shows how to configure BGP to advertise the capability to send and receive additional paths to and from the BGP peer:

```
switch# configure terminal
switch(config)# router bgp 100
switch(config-router)# neighbor 10.131.31.2 remote-as 100
switch(config-router-neighbor)# address-family ipv4 unicast
switch(config-router-neighbor-af)# capability additional-paths send
switch(config-router-neighbor-af)# capability additional-paths receive
```

Configuring the Sending and Receiving of Additional Paths

You can configure the capability of sending and receiving additional paths to and from the BGP peers. To do so, use the following commands in address-family configuration mode:

SUMMARY STEPS

1. `[no] additional-paths send`
2. `[no] additional-paths receive`
3. `show bgp neighbor`

DETAILED STEPS

	Command or Action	Purpose
Step 1	[no] additional-paths send Example: switch(config-router-af) # additional-paths send	Enables the send capability of additional paths for all of the neighbors under this address family for which the capability has not been disabled. The no form of this command disables the send capability.
Step 2	[no] additional-paths receive Example: switch(config-router-af) # additional-paths receive	Enables the receive capability of additional paths for all of the neighbors under this address family for which the capability has not been disabled. The no form of this command disables the receive capability.
Step 3	show bgp neighbor Example: switch(config-router-af) # show bgp neighbor	Displays whether the local peer as advertised the additional paths send or receive capability to the remote peer.

Example

This example shows how to enable the additional paths send and receive capability for all neighbors under the specified address family for which this capability has not been disabled:

```
switch# configure terminal
switch(config)# router bgp 100
switch(config-router)# address-family ipv4 unicast
switch(config-router-af)# additional-paths send
switch(config-router-af)# additional-paths receive
```

Configuring Advertised Paths

You can specify the paths that are advertised for BGP. To do so, use the following commands in route-map configuration mode:

SUMMARY STEPS

1. **[no] set ip next-hop unchanged**
2. **[no] set path-selection { all | backup | best2 | multipaths } | advertise**
3. **show bgp { ipv4 | ipv6 } unicast [ip-address | ipv6-prefix] [vrf vrf-name]**

DETAILED STEPS

	Command or Action	Purpose
Step 1	[no] set ip next-hop unchanged Example: switch(config-route-map)# set ip next-hop unchanged	Specifies and unchanged next-hop IP address.

	Command or Action	Purpose
Step 2	<p>[no] set path-selection { all backup best2 multipaths } advertise</p> <p>Example:</p> <pre>switch(config-route-map)# set path-selection all advertise</pre>	<p>Specifies that all paths be advertised for a given prefix. You can use one of the following options:</p> <ul style="list-style-type: none"> • all—Advertises all available valid paths. • backup—Advertises paths marked as backup paths. This option requires that backup paths be enabled using the <code>additional-path install backup</code> command. • best2—Advertises the second best path, which is the best path of the remaining available paths, except the already calculated best path. • multipaths—Advertises all multipaths. This option requires that multipaths be enabled using the <code>maximum-paths</code> command. <p>Note If there are no multipaths, the <code>backup</code> and <code>best2</code> options are the same. If there are multipaths, <code>best2</code> is the first path on the list of multipaths while <code>backup</code> is the best path of all available paths, except the calculated best path and multipaths.</p> <p>The no form of this command specifies that only the best path be advertised.</p>
Step 3	<p>show bgp { ipv4 ipv6 } unicast [ip-address ipv6-prefix] [vrf vrf-name]</p> <p>Example:</p> <pre>switch(config-route-map)# show bgp ipv4 unicast</pre>	<p>Displays the path ID for the additional paths of a prefix and advertisement information for these paths.</p>

Example

This example show how to specify that all paths be advertised for the prefix list p1:

```
switch# configure terminal
switch(config)# route-map PATH_SELECTION_RMAP
switch(config-route-map)# match ip address prefix-list p1
switch(config-route-map)# set path-selection all advertise
```

Configuring Additional Path Selection

You can configure the capability fo selecting additional paths for a prefix. To do so, use the following commands in address-family configuration mode:

SUMMARY STEPS

1. **[no] additional-paths selection route-map *map-name***

2. show bgp {ipv4 | ipv6} unicast [ip-address | ipv6-prefix] [vrf vrf-name]

DETAILED STEPS

	Command or Action	Purpose
Step 1	<p>[no] additional-paths selection route-map <i>map-name</i></p> <p>Example:</p> <pre>switch(config-router-af) # additional paths selection route-map map1</pre>	<p>Configures the capability of selecting additional paths for a prefix.</p> <p>The no form of this command disables the additional paths selection capability.</p>
Step 2	<p>show bgp {ipv4 ipv6} unicast [ip-address ipv6-prefix] [vrf vrf-name]</p> <p>Example:</p> <pre>switch(config-route-af) # show bgp ipv4 unicast</pre>	<p>Displays the path ID for the additional paths of a prefix and advertisement information for these paths.</p>

Example

This example shows how to configure additional paths selection under the specified address family:

```
switch# configure terminal
switch(config)# router bgp 100
switch(config-router)# address-family ipv4 unicast
switch(config-router-af)# additional-paths selection route-map PATH_SELECTION_RMAP
```

Configuring eBGP

Disabling eBGP Single-Hop Checking

You can configure eBGP to disable checking whether a single-hop eBGP peer is directly connected to the local router. Use this option for configuring a single-hop loopback eBGP session between directly connected switches.

To disable checking whether or not a single-hop eBGP peer is directly connected, use the following command in neighbor configuration mode:

SUMMARY STEPS

1. disable-connected-check

DETAILED STEPS

	Command or Action	Purpose
Step 1	<p>disable-connected-check</p> <p>Example:</p> <pre>switch(config-router-neighbor) # disable-connected-check</pre>	<p>Disables checking whether or not a single-hop eBGP peer is directly connected. You must manually reset the BGP sessions after using this command.</p>

Configuring TTL Security Hops

Perform this task to allow BGP to establish or maintain a session only if the TTL value in the IP packet header is equal to or greater than the TTL value configured for the BGP neighbor session.

Before you begin

To maximize the effectiveness of the BGP Support for TTL Security Check feature, we recommend that you configure it on each participating router. Enabling this feature secures the eBGP session in the incoming direction only and has no effect on outgoing IP packets or the remote router.



Note

- The **neighbor ebgp-multihop** command is not needed when the BGP Support for TTL Security Check feature is configured for a multihop neighbor session and should be disabled before configuring this feature.
- The effectiveness of the BGP Support for TTL Security Check feature is reduced in large-diameter multihop peerings. In the event of a CPU utilization-based attack against a BGP router that is configured for large-diameter peering, you may still need to shut down the affected neighbor sessions to handle the attack.
- This feature is not effective against attacks from a peer that has been compromised inside of the local and remote network. This restriction also includes peers that are on the network segment between the local and remote network.

SUMMARY STEPS

1. **enable**
2. **trace** *[protocol] destination*
3. **configure terminal**
4. **router bgp** *autonomous-system-number*
5. **neighbor** *ip-address*
6. **ttl-security hops** *hop-count*
7. **end**
8. **show running-config**
9. **show ip bgp neighbors** *[ip-address]*

DETAILED STEPS

	Command or Action	Purpose
Step 1	enable Example: switch(config)# enable	Enables privileged EXEC mode. Enter your password if prompted.
Step 2	trace <i>[protocol] destination</i> Example: switch(config)# trace ip 10.1.1.1	Discovers the routes of the specified protocol that packets will actually take when traveling to their destination. Enter the trace command to determine the number of hops to the specified peer.

	Command or Action	Purpose
Step 3	configure terminal Example: <pre>switch(config)# configure terminal</pre>	Enters global configuration mode.
Step 4	router bgp <i>autonomous-system-number</i> Example: <pre>switch(config)# router bgp 65000</pre>	Enters router configuration mode, and creates a BGP routing process.
Step 5	neighbor <i>ip-address</i> Example: <pre>switch(config)# neighbor 10.1.1.1</pre>	Configures the neighbor IP address.
Step 6	ttl-security hops <i>hop-count</i> Example: <pre>switch(config)# ttl-security hops 2</pre>	<p>Configures the maximum number of hops that separate two peers.</p> <p>The hop-count argument is set to the number of hops that separate the local and remote peer. If the expected TTL value in the IP packet header is 254, then the number 1 should be configured for the hop-count argument. The range of values is a number from 1 to 254.</p> <p>When the BGP Support for TTL Security Check feature is enabled, BGP will accept incoming IP packets with a TTL value that is equal to or greater than the expected TTL value. Packets that are not accepted are discarded.</p> <p>The example configuration sets the expected incoming TTL value to at least 253, which is 255 minus the TTL value of 2, and this is the minimum TTL value expected from the BGP peer. The local router will accept the peering session from the 10.1.1.1 neighbor only if it is one or two hops away.</p>
Step 7	end Example: <pre>switch(config)# end</pre>	Exits router configuration mode and enters privileged EXEC mode.
Step 8	show running-config Example: <pre>switch(config)# show running-config begin bgp</pre>	<p>(Optional) Displays the contents of the currently running configuration file.</p> <p>The output of this command displays the configuration of the neighbor ttl-security command for each peer under the BGP configuration section of output. That section includes the neighbor address and the configured hop count.</p> <p>Note Only the syntax applicable to this task is used in this example. For more details, see the Cisco IOS IP Routing: BGP Command Reference.</p>

	Command or Action	Purpose
Step 9	show ip bgp neighbors <i>[ip-address]</i> Example: <pre>switch(config)# show ip bgp neighbors 10.4.9.5</pre>	(Optional) Displays information about the TCP and BGP connections to neighbors. This command displays "External BGP neighbor may be up to number hops away" when the BGP Support for TTL Security Check feature is enabled. The number value represents the hop count. It is a number from 1 to 254. Note Only the syntax applicable to this task is used in this example. For more details, see the Cisco IOS IP Routing: BGP Command Reference.

Configuring eBGP Multihop

You can configure the eBGP time-to-live (TTL) value to support eBGP multihop. In some situations, an eBGP peer is not directly connected to another eBGP peer and requires multiple hops to reach the remote eBGP peer. You can configure the eBGP TTL value for a neighbor session to allow these multihop sessions.



Note This configuration is not supported for BGP interface peering.

To configure eBGP multihop, use the following command in neighbor configuration mode:

SUMMARY STEPS

1. **ebgp-multihop** *ttl-value*

DETAILED STEPS

	Command or Action	Purpose
Step 1	ebgp-multihop <i>ttl-value</i> Example: <pre>switch(config-router-neighbor)# ebgp-multihop 5</pre>	Configures the eBGP TTL value for eBGP multihop. The range is from 2 to 255. You must manually reset the BGP sessions after using this command.

Disabling a Fast External Fallover

By default, the Cisco NX-OS device supports fast external fallover for neighbors in all VRFs and address families (IPv4 or IPv6). Typically, when a BGP router loses connectivity to a directly connected eBGP peer, BGP triggers a fast external fallover by resetting the eBGP session to the peer. You can disable this fast external fallover to limit the instability caused by link flaps.

To disable fast external fallover, use the following command in router configuration mode:

SUMMARY STEPS

1. **no fast-external-fallover**

DETAILED STEPS

	Command or Action	Purpose
Step 1	no fast-external-fallover Example: <pre>switch(config-router)# no fast-external-fallover</pre>	Disables a fast external fallover for eBGP peers. This command is enabled by default.

Limiting the AS-path Attribute

You can configure eBGP to discard routes that have a high number of AS numbers in the AS-path attribute.

To discard routes that have a high number of AS numbers in the AS-path attribute, use the following command in router configuration mode:

SUMMARY STEPS

1. **maxas-limit** *number*

DETAILED STEPS

	Command or Action	Purpose
Step 1	maxas-limit <i>number</i> Example: <pre>switch(config-router)# maxas-limit 50</pre>	Discards eBGP routes that have a number of AS-path segments that exceed the specified limit. The range is from 1 to 2000.

Configuring Local AS Support

The local-AS feature allows a router to appear to be a member of a second autonomous system (AS), in addition to its real AS. Local AS allows two ISPs to merge without modifying peering arrangements. Routers in the merged ISP become members of the new autonomous system but continue to use their old AS numbers for their customers.

This feature can only be used for true eBGP peers. You cannot use this feature for two peers that are members of different confederation subautonomous systems.

Furthermore, the remote peer's ASN configured with the remote-as command cannot be identical to the local device's ASN configured with the local-as command.

To configure eBGP local AS support, use the following command in neighbor configuration mode:

SUMMARY STEPS

1. **local-as** *number* [**no-prepend** [**replace-as** [**dual-as**]]]

DETAILED STEPS

	Command or Action	Purpose
Step 1	local-as <i>number</i> [no-prepend [replace-as [dual-as]]] Example: <pre>switch(config-router-neighbor)# local-as 1.1</pre>	Configures eBGP to prepend the local AS <i>number</i> to the AS_PATH attribute. The AS <i>number</i> can be a 16-bit integer or a 32-bit integer in the form of a higher 16-bit decimal number and a lower 16-bit decimal number in xx.xx format.

Example

This example shows how to configure local AS support on a VRF:

```
switch# configure terminal
switch(config)# router bgp 1
switch(config-router)# vrf test
switch(config-router-vrf)# local-as 1
switch(config-router-vrf)# show running-config bgp
```

Configuring AS Confederations

To configure an AS confederation, you must specify a confederation identifier. To the outside world, the group of autonomous systems within the AS confederation look like a single autonomous system with the confederation identifier as the autonomous system number.

To configure a BGP confederation identifier, use the following command in router configuration mode:

SUMMARY STEPS

1. **confederation identifier** *as-number*
2. **bgp confederation peers** *as-number* [*as-number2...*]

DETAILED STEPS

	Command or Action	Purpose
Step 1	confederation identifier <i>as-number</i> Example: <pre>switch(config-router)# confederation identifier 4000</pre>	<p>In router configuration mode, this command configures a BGP confederation identifier.</p> <p>The command triggers an automatic notification and session reset for the BGP neighbor sessions.</p>
Step 2	bgp confederation peers <i>as-number</i> [<i>as-number2...</i>] Example: <pre>switch(config-router)# bgp confederation peers 5 33 44</pre>	<p>In router configuration mode, this command configures the autonomous systems that belong to the AS confederation.</p> <p>The command specifies a list of autonomous systems that belong to the confederation and it triggers an automatic notification and session reset for the BGP neighbor sessions.</p>

Configuring Route Reflector

You can configure iBGP peers as route reflector clients to the local BGP speaker, which acts as the route reflector. Together, a route reflector and its clients form a cluster. A cluster of clients usually has a single route reflector. In such instances, the cluster is identified by the router ID of the route reflector. To increase redundancy and avoid a single point of failure in the network, you can configure a cluster with more than one route reflector. You must configure all route reflectors in the cluster with the same 4-byte cluster ID so that a route reflector can recognize updates from route reflectors in the same cluster.

Before you begin

You must enable BGP.

SUMMARY STEPS

1. **configure terminal**
2. **router bgp** *as-number*
3. **cluster-id** *cluster-id*
4. **address-family** {*ipv4* | *ipv6*} {**unicast** | **multicast**}
5. (Optional) **client-to-client reflection**
6. **exit**
7. **neighbor** *ip-address* **remote-as** *as-number*
8. **address-family** {*ipv4* | *ipv6*} {**unicast** | **multicast**}
9. **route-reflector-client**
10. (Optional) **show bgp** {*ipv4* | *ipv6*} {**unicast** | **multicast**} **neighbors**
11. (Optional) **copy running-config startup-config**

DETAILED STEPS

	Command or Action	Purpose
Step 1	configure terminal Example: switch# configure terminal	Enters global configuration mode.
Step 2	router bgp <i>as-number</i> Example: switch(config)# router bgp 65535 switch(config-router)#	Enters BGP mode and assigns the autonomous system number to the local BGP speaker.
Step 3	cluster-id <i>cluster-id</i> Example: switch(config-router)# cluster-id 192.0.2.1	Configures the local router as one of the route reflectors that serve the cluster. You specify a cluster ID to identify the cluster. This command triggers an automatic soft clear or refresh of BGP neighbor sessions.
Step 4	address-family { <i>ipv4</i> <i>ipv6</i> } { unicast multicast } Example:	Enters router address family configuration mode for the specified address family.

	Command or Action	Purpose
	<pre>switch(config-router)# address-family ipv4 unicast switch(config-router-af)#</pre>	
Step 5	<p>(Optional) client-to-client reflection</p> <p>Example:</p> <pre>switch(config-router-af)# client-to-client reflection</pre>	Configures client-to-client route reflection. This feature is enabled by default. This command triggers an automatic soft clear or refresh of BGP neighbor sessions.
Step 6	<p>exit</p> <p>Example:</p> <pre>switch(config-router-af)# exit switch(config-router)#</pre>	Exits router address configuration mode.
Step 7	<p>neighbor ip-address remote-as as-number</p> <p>Example:</p> <pre>switch(config-router)# neighbor 192.0.2.10 remote-as 65535 switch(config-router-neighbor)#</pre>	Configures the IP address and AS number for a remote BGP peer.
Step 8	<p>address-family {ipv4 ipv6} {unicast multicast}</p> <p>Example:</p> <pre>switch(config-router-neighbor)# address-family ipv4 unicast switch(config-router-neighbor-af)#</pre>	Enters neighbor address family configuration mode for the unicast IPv4 address family.
Step 9	<p>route-reflector-client</p> <p>Example:</p> <pre>switch(config-router-neighbor-af)# route-reflector-client</pre>	Configures the device as a BGP route reflector and configures the neighbor as its client. This command triggers an automatic notification and session reset for the BGP neighbor sessions.
Step 10	<p>(Optional) show bgp {ipv4 ipv6} {unicast multicast} neighbors</p> <p>Example:</p> <pre>switch(config-router-neighbor-af)# show bgp ipv4 unicast neighbors</pre>	Displays the BGP peers.
Step 11	<p>(Optional) copy running-config startup-config</p> <p>Example:</p> <pre>switch(config-router-neighbor-af)# copy running-config startup-config</pre>	Saves this configuration change.

Example

This example shows how to configure the router as a route reflector and add one neighbor as a client:

```
switch(config)# router bgp 65536
switch(config-router)# neighbor 192.0.2.10 remote-as 65536
switch(config-router-neighbor)# address-family ip unicast
```

```
switch(config-router-neighbor-af) # route-reflector-client
switch(config-router-neighbor-af) # copy running-config startup-config
```

Configuring Next-Hops on Reflected Routes Using an Outbound Route-Map

You can change the next-hop on reflected routes on a BGP route reflector using an outbound route-map. You can configure the outbound route-map to specify the peer's local address as the next-hop address.



Note The **next-hop-self** command does not enable this functionality for routes being reflected to clients by a route reflector. This functionality can only be enabled using an outbound route-map.

Before you begin

You must enable BGP (see the [Enabling BGP](#) section).

Ensure that you are in the correct VDC (or use the **switchto vdc** command).

You must enter the **set next-hop** command to configure an address family-specific next-hop address. For example, for the IPv6 address family, you must enter the **set ipv6 next-hop peer-address** command.

- When setting IPv4 next-hops using route-maps—If **set ip next-hop peer-address** matches the route-map, the next-hop is set to the peer's local address. If no next-hop is set in the route-map, the next-hop is set to the one stored in the path.
- When setting IPv6 next-hops using route-maps—If **set ipv6 next-hop peer-address** matches the route-map, the next-hop is set as follows:
 - For IPv6 peers, the next-hop is set to the peer's local IPv6 address.
 - For IPv4 peers, if **update-source** is configured, the next-hop is set to the source interface's IPv6 address, if any. If no IPv6 address is configured, no next-hop is set
 - For IPv4 peers, if **update-source** is not configured, the next-hop is set to the outgoing interface's IPv6 address, if any. If no IPv6 address is configured, no next-hop is set.

SUMMARY STEPS

1. **configure terminal**
2. **router bgp** *as-number*
3. **neighbor** *ip-address* **remote-as** *as-number*
4. (Optional) **update-source** *interface number*
5. **address-family** {*ipv4* | *ipv6*} {*unicast* | *multicast*}
6. **route-reflector-client**
7. **route-map** *map-name* **out**
8. (Optional) **show bgp** {*ipv4* | *ipv6*} {*unicast* | *multicast*} [*ip-address* | *ipv6-prefix*] **route-map** *map-name* [**vrf** *vrf-name*]
9. (Optional) **copy running-config startup-config**

DETAILED STEPS

	Command or Action	Purpose
Step 1	configure terminal Example: switch# configure terminal switch(config)#	Enters global configuration mode.
Step 2	router bgp <i>as-number</i> Example: switch(config)# router bgp 200 switch(config-router)#	Enters BGP mode and assigns the autonomous system number to the local BGP speaker.
Step 3	neighbor <i>ip-address</i> remote-as <i>as-number</i> Example: switch(config-router)# neighbor 192.0.2.12 remote-as 200 switch(config-router-neighbor)#	Configures the IP address and AS number for a remote BGP peer.
Step 4	(Optional) update-source <i>interface number</i> Example: switch(config-router-neighbor)# update-source loopback 300	Specifies and updates the source of the BGP session.
Step 5	address-family {<i>ipv4</i> <i>ipv6</i>} {unicast multicast} Example: switch(config-router-neighbor)# address-family ipv4 unicast switch(config-router-neighbor-af)#	Enters router address family configuration mode for the specified address family.
Step 6	route-reflector-client Example: switch(config-router-neighbor-af)# route-reflector-client	Configures the device as a BGP route reflector and configures the neighbor as its client. This command triggers an automatic notification and session reset for the BGP neighbor sessions.
Step 7	route-map <i>map-name</i> out Example: switch(config-router-neighbor-af)# route-map setrrnh out	Applies the configured BGP policy to outgoing routes.
Step 8	(Optional) show bgp {<i>ipv4</i> <i>ipv6</i>} {unicast multicast} [<i>ip-address</i> <i>ipv6-prefix</i>] route-map <i>map-name</i> [<i>vrf vrf-name</i>] Example: switch(config-router-neighbor-af)# show bgp ipv4 unicast route-map setrrnh	Displays the BGP routes that match the route map.

	Command or Action	Purpose
Step 9	(Optional) copy running-config startup-config Example: switch(config-router-neighbor-af)# copy running-config startup-config	Saves this configuration change.

Example

This example shows how to configure the next-hop on reflected routes on a BGP route reflector using an outbound route-map:

```
switch(config)# interface loopback 300
switch(config-if)# ip address 192.0.2.11/32
switch(config-if)# ipv6 address 2001::a0c:1a65/64
switch(config-if)# ip router ospf 1 area 0.0.0.0
switch(config-if)# exit
switch(config)# route-map setrrnh permit 10
switch(config-route-map)# set ip next-hop peer-address
switch(config-route-map)# exit
switch(config)# route-map setrrnhv6 permit 10
switch(config-route-map)# set ipv6 next-hop peer-address
switch(config-route-map)# exit
switch(config)# router bgp 200
switch(config-router)# neighbor 192.0.2.12 remote-as 200
switch(config-router-neighbor)# update-source loopback 300
switch(config-router-neighbor)# address-family ipv4 unicast
switch(config-router-neighbor-af)# route-reflector-client
switch(config-router-neighbor-af)# route-map setrrnh out
switch(config-router-neighbor-af)# exit
switch(config-router-neighbor)# address-family ipv6 unicast
switch(config-router-neighbor-af)# route-reflector-client
switch(config-router-neighbor-af)# route-map setrrnhv6 out
```

Configuring Route Dampening

You can configure route dampening to minimize route flaps propagating through your iBGP network.

To configure route dampening, use the following command in address-family or VRF address family configuration mode:

SUMMARY STEPS

1. **dampening** [*{half-life reuse-limit suppress-limit max-suppress-time | route-map map-name}*]

DETAILED STEPS

	Command or Action	Purpose
Step 1	dampening [<i>{half-life reuse-limit suppress-limit max-suppress-time route-map map-name}</i>] Example:	Disables capabilities negotiation. The parameter values are as follows: <ul style="list-style-type: none"> • <i>half-life</i>—The range is from 1 to 45.

	Command or Action	Purpose
	<pre>switch(config-router-af)# dampening route-map bgpDamp</pre>	<ul style="list-style-type: none"> • <i>reuse-limit</i>—The range is from 1 to 20000. • <i>suppress-limit</i>—The range is from 1 to 20000. • <i>max-suppress-time</i>—The range is from 1 to 255.

Configuring Load Sharing and ECMP

You can configure the maximum number of paths that BGP adds to the route table for equal-cost multipath (ECMP) load balancing.

To configure the maximum number of paths, use the following command in router address-family configuration mode:

SUMMARY STEPS

1. **maximum-paths [ibgp] maxpaths**

DETAILED STEPS

	Command or Action	Purpose
Step 1	maximum-paths [ibgp] maxpaths Example: <pre>switch(config-router-af)# maximum-paths 8</pre>	Configures the maximum number of equal-cost paths for load sharing. The default is 1.

Unequal Cost Multipath (UCMP) over BGP

UCMP is also known as Weighted ECMP. It is a mechanism that allows multiple routes to the same destination with different weights per next-hop and load-balances the routed traffic over those multiple next-hops. The basic UCMP works for most of the customers' requirements. The load entropy is the best way to maximize the link usage efficiency.

Often, the application distribution in the network can be unbalanced. The new clusters roll in at different over-subscription rates than the old clusters. The new clusters have powerful servers than the old clusters and they are capable of handling more load per CPU. As the network is not perfect, some control over routing behavior is needed. You can configure Weighted ECMP over BGP for balancing the traffic load and for administering control over the routing behavior.



Note The Link-Bandwidth Extended Community must be advertised across eBGP sessions, although it is defined as a non-transitive attribute.

Next-hop-self must strip the Link-Bandwidth Extended Community from advertisements.

Enabling UCMP over BGP

The solution for the unequal distribution of the resources and sub-optimal traffic distribution use-cases is to configure Weighted ECMP over BGP. You can inject the routes (from the host or the controller) and signal a weight for each instance. You can then aggregate the weights across the infrastructure and deliver the traffic in the direct proportion to the application deployment distribution.

Guidelines and Limitations for UCMP over BGP

- BGP uses the Link-Bandwidth Extended Community defined in the draft-ietf-idr-link-bandwidth-06.txt to implement the weighted ECMP feature. The Link-Bandwidth Extended Community is advertised across eBGP sessions, although it's defined as a non-transitive attribute, as long as next-hop is unchanged.
- You can accept Link-Bandwidth Extended Community from both iBGP and eBGP peers.
- For weights programming, the Link-Bandwidth Extended Community has the link bandwidth encoded in bytes/second, as a four byte floating point integer, that is normalized between 0 and 1000 before downloading to RIB.
- The hardware ECMP width is fixed as 64 in size.

Configuring Maximum Prefixes

You can configure the maximum number of prefixes that BGP can receive from a BGP peer. If the number of prefixes exceeds this value, you can optionally configure BGP to generate a warning message or tear down the BGP session to the peer.

To configure the maximum allowed prefixes for a BGP peer, use the following command in neighbor address-family configuration mode:

SUMMARY STEPS

1. **maximum-prefix** *maximum* [*threshold*] [**restart time** | **warning-only**]

DETAILED STEPS

	Command or Action	Purpose
Step 1	maximum-prefix <i>maximum</i> [<i>threshold</i>] [restart time warning-only] Example: <pre>switch(config-router-neighbor-af) # maximum-prefix 12</pre>	Configures the maximum number of prefixes from a peer. The parameter ranges are as follows: <ul style="list-style-type: none"> • <i>maximum</i>—The range is from 1 to 300000. • <i>threshold</i>—The range is from 1 to 100 percent. The default is 75 percent. • <i>time</i>—The range is from 1 to 65535 minutes. This command triggers an automatic notification and session reset for the BGP neighbor sessions if the prefix is exceeded.

Configuring DSCP

You can configure a differentiated services code point (DSCP) for a neighbor. You can specify a DSCP value for locally originated packets for IPv4 or IPv6.

To configure the DSCP value, use the following command in neighbor configuration mode:

SUMMARY STEPS

1. `dscp dscp_value`

DETAILED STEPS

	Command or Action	Purpose
Step 1	<p><code>dscp dscp_value</code></p> <p>Example:</p> <pre>switch(config-router-neighbor)# dscp 63</pre> <p>Below is an example of the corresponding show command:</p> <pre>show ipv6 bgp neighbors BGP neighbor is 10.1.1.1, remote AS 0, unknown link, Peer index 4 BGP version 4, remote router ID 0.0.0.0 BGP state = Idle, down for 00:13:34, retry in 0.000000 DSCP (DiffServ CodePoint): 0 Last read never, hold time = 180, keepalive interval is 60 seconds</pre>	<p>Sets the differentiated services code point (DSCP) value for the neighbor. The DSCP value can be a number from 0 to 63, or it can be one of the following keywords: ef, af11, af12, af13, af21, af22, af23, af31, af32, af33, af41, af42, af43, cs1, cs2, cs3, cs4, cs5, cs6, or cs7.</p> <p>The default value is cs6.</p>

Configuring Dynamic Capability

You can configure dynamic capability for a BGP peer.

To configure dynamic capability, use the following command in neighbor configuration mode:

SUMMARY STEPS

1. `dynamic-capability`

DETAILED STEPS

	Command or Action	Purpose
Step 1	<p><code>dynamic-capability</code></p> <p>Example:</p> <pre>switch(config-router-neighbor)# dynamic-capability</pre>	<p>Enables dynamic capability. This command triggers an automatic notification and session reset for the BGP neighbor sessions.</p>

Configuring Aggregate Addresses

You can configure aggregate address entries in the BGP route table.

To configure an aggregate address, use the following command in router address-family configuration mode:

SUMMARY STEPS

1. **aggregate-address** *ip-prefix/length* [**as-set**] [**summary-only**] [**advertise-map** *map-name*] [**attribute-map** *map-name*] [**suppress-map** *map-name*]

DETAILED STEPS

	Command or Action	Purpose
Step 1	<p>aggregate-address <i>ip-prefix/length</i> [as-set] [summary-only] [advertise-map <i>map-name</i>] [attribute-map <i>map-name</i>] [suppress-map <i>map-name</i>]</p> <p>Example:</p> <pre>switch(config-router-af)# aggregate-address 192.0.2.0/8 as-set</pre>	<p>Creates an aggregate address. The path advertised for this route is an autonomous system set that consists of all elements contained in all paths that are being summarized:</p> <ul style="list-style-type: none"> • The as-set keyword generates autonomous system set path information and community information from contributing paths. • The summary-only keyword filters all more specific routes from updates. • The advertise-map keyword and argument specify the route map used to select attribute information from selected routes. • The attribute-map keyword and argument specify the route map used to select attribute information from the aggregate. • The suppress-map keyword and argument conditionally filter more specific routes. If you specify the suppress-map option while performing a BGP route aggregation, you can set the community attribute for a BGP route update. This option enables you to set community attributes on the more-specific routes. • The suppress-map keyword and argument conditionally filter more specific routes. If you specify the suppress-map option while performing a BGP route aggregation, you can either suppress certain more-specific routes from being advertised to its peers, or decide to advertise the more-specific routes with some community attributes set on them, depending upon the suppress-map route-map configuration. A route-map configured with only match clauses will suppress the more-specific routes that satisfy the match criteria. However, if a route-map is configured with match and set clauses, then the routes satisfying the

	Command or Action	Purpose
		match criteria will be advertised with the appropriate attributes as modified by the route-map. The second option enables you to set community attributes on the more-specific routes.

Suppressing BGP Routes

You can configure Cisco NX-OS to advertise newly learned BGP routes only after these routes are confirmed by the Forwarding Information Base (FIB) and programmed in the hardware. After the routes are programmed, subsequent changes to these routes do not require this hardware-programming check.

To suppress BGP routes, use the following command in router configuration mode:

SUMMARY STEPS

1. `suppress-fib-pending`

DETAILED STEPS

	Command or Action	Purpose
Step 1	suppress-fib-pending Example: <pre>switch(config-router)# suppress-fib-pending</pre>	Suppresses newly learned BGP routes (IPv4 or IPv6) from being advertised to downstream BGP neighbors until the routes have been programmed in the hardware.

Configuring BGP Conditional Advertisement

You can configure BGP conditional advertisement to limit the routes that BGP propagates. You define the following two route maps:

- **Advertise map**—Specifies the conditions that the route must match before BGP considers the conditional advertisement. This route map can contain any appropriate match statements.
- **Exist map or nonexist map**—Defines the prefix that must exist in the BGP table before BGP propagates a route that matches the advertise map. The nonexist map defines the prefix that must not exist in the BGP table before BGP propagates a route that matches the advertise map. BGP processes only the permit statements in the prefix list match statements in these route maps.

If the route does not pass the condition, BGP withdraws the route if it exists in the BGP table.

Before you begin

You must enable BGP (see the [Enabling BGP](#) section).

SUMMARY STEPS

1. **configure terminal**
2. **router bgp** *as-number*
3. **neighbor** *ip-address* **remote-as** *as-number*
4. **address-family** {*ipv4* | *ipv6*} {**unicast** | **multicast**}
5. **advertise-map** *adv-map* {**exist-map** *exist-rmap*|**non-exist-map** *nonexist-rmap*}
6. (Optional) **show bgp** {*ipv4* | *ipv6*} {**unicast** | **multicast**} **neighbors**
7. (Optional) **copy running-config startup-config**

DETAILED STEPS

	Command or Action	Purpose
Step 1	configure terminal Example: <pre>switch# configure terminal switch(config)#</pre>	Enters configuration mode.
Step 2	router bgp <i>as-number</i> Example: <pre>switch(config)# router bgp 65535 switch(config-router)#</pre>	Enters BGP mode and assigns the autonomous system number to the local BGP speaker.
Step 3	neighbor <i>ip-address</i> remote-as <i>as-number</i> Example: <pre>switch(config-router)# neighbor 192.168.1.2 remote-as 65534 switch(config-router-neighbor)#</pre>	Places the router in neighbor configuration mode for BGP routing and configures the neighbor IP address.
Step 4	address-family { <i>ipv4</i> <i>ipv6</i> } { unicast multicast }	Enters address family configuration mode.
Step 5	advertise-map <i>adv-map</i> { exist-map <i>exist-rmap</i> non-exist-map <i>nonexist-rmap</i> }	Configures BGP to conditionally advertise routes based on the two configured route maps:
	Example: <pre>switch(config-router-neighbor-af)# advertise-map advertise exist-map exist</pre>	<ul style="list-style-type: none"> • <i>adv-map</i>—Specifies a route map with match statements that the route must pass before BGP passes the route to the next route map. The <i>adv-map</i> is a case-sensitive, alphanumeric string up to 63 characters. • <i>exist-rmap</i>—Specifies a route map with match statements for a prefix list. A prefix in the BGP table must match a prefix in the prefix list before BGP advertises the route. The <i>exist-rmap</i> is a case-sensitive, alphanumeric string up to 63 characters. • <i>nonexist-rmap</i>—Specifies a route map with match statements for a prefix list. A prefix in the BGP table

	Command or Action	Purpose
		<p>must not match a prefix in the prefix list before BGP advertises the route. The <i>nonexist-rmap</i> is a case-sensitive, alphanumeric string up to 63 characters.</p> <p>Note For BGP conditional advertisement feature, ensure that the "le" or "ge" statements are not used on prefix-list when associated to exist or nonexist map.</p>
Step 6	<p>(Optional) show bgp {ipv4 ipv6} {unicast multicast} neighbors</p> <p>Example:</p> <pre>switch(config-router-neighbor-af)# show ip bgp neighbor</pre>	Displays information about BGP and the configured conditional advertisement route maps.
Step 7	<p>(Optional) copy running-config startup-config</p> <p>Example:</p> <pre>switch(config-router-neighbor-af)# copy running-config startup-config</pre>	Saves this configuration change.

Example

This example shows how to configure BGP conditional advertisement:

```
switch# configure terminal
switch(config)# router bgp 65536
switch(config-router)# neighbor 192.0.2.2 remote-as 65537
switch(config-router-neighbor)# address-family ipv4 unicast
switch(config-router-neighbor-af)# advertise-map advertise exist-map exist
switch(config-router-neighbor-af)# exit
switch(config-router-neighbor)# exit
switch(config-router)# exit
switch(config)# route-map advertise
switch(config-route-map)# match as-path pathList
switch(config-route-map)# exit
switch(config)# route-map exit
switch(config-route-map)# match ip address prefix-list plist
switch(config-route-map)# exit
switch(config)# ip prefix-list plist permit 209.165.201.0/27
```

Configuring Route Redistribution

You can configure BGP to accept routing information from another routing protocol and redistribute that information through the BGP network. Optionally, you can assign a default route for redistributed routes.

Before you begin

You must enable BGP.

SUMMARY STEPS

1. **configure terminal**
2. **router bgp** *as-number*
3. **address-family** {*ipv4* | *ipv6* } {*unicast* | *multicast*}
4. **address-family** {*ipv4* | *ipv6*} {*unicast* | *multicast*}
5. **redistribute** {*direct* | {*eigrp* | *isis* | *ospf* | *ospfv3* | *rip*} *instance-tag* | *static* | *icmpv6*} **route-map** *map-name*
6. (Optional) **default-metric** *value*
7. (Optional) **copy running-config startup-config**

DETAILED STEPS

	Command or Action	Purpose
Step 1	configure terminal Example: switch# configure terminal switch(config)#	Enters global configuration mode.
Step 2	router bgp <i>as-number</i> Example: switch(config)# router bgp 65535 switch(config-router)#	Enters BGP mode and assigns the autonomous system number to the local BGP speaker.
Step 3	address-family { <i>ipv4</i> <i>ipv6</i> } { <i>unicast</i> <i>multicast</i> } Example: switch(config-router)# address-family vpngv4 unicast switch(config-router-af)#	Enters address family configuration mode.
Step 4	address-family { <i>ipv4</i> <i>ipv6</i> } { <i>unicast</i> <i>multicast</i> } Example: switch(config-router)# address-family ipv4 unicast switch(config-router-af)#	Enters address-family configuration mode.
Step 5	redistribute { <i>direct</i> { <i>eigrp</i> <i>isis</i> <i>ospf</i> <i>ospfv3</i> <i>rip</i> } <i>instance-tag</i> <i>static</i> <i>icmpv6</i> } route-map <i>map-name</i> Example: switch(config-router-af)# redistribute eigrp 201 route-map Eigrpmap	Redistributes routes from other protocols into BGP. Beginning with Cisco NX-OS Release 10.3(3)F, the keyword icmpv6 is supported to redistribute icmpv6 routes from other protocols into BGP.
Step 6	(Optional) default-metric <i>value</i> Example: switch(config-router-af)# default-metric 33	Generates a default route into BGP.
Step 7	(Optional) copy running-config startup-config Example:	Saves this configuration change.

	Command or Action	Purpose
	switch(config-router-af)# copy running-config startup-config	

Example

This example shows how to redistribute EIGRP into BGP:

```
switch# configure terminal
switch(config)# router bgp 65536
switch(config-router)# address-family ipv4 unicast
switch(config-router-af)# redistribute eigrp 201 route-map Eigrpmap
switch(config-router-af)# copy running-config startup-config
```

DMZ Link Bandwidth

The DMZ Link Bandwidth feature is used to enable traffic load balancing towards a BGP learnt route reachable via multiple autonomous system exit links. The load balancing is done proportional to the bandwidth of these links.

Link Bandwidth Extended Community is used to carry the bandwidth of the link between two directly connected (single hop) eBGP peers. A nexus device will attach this extended community to BGP routes received from a directly connected eBGP neighbor if the `dmz-link-bandwidth` command is configured under that neighbor's address-family mode. This extended community is then propagated to iBGP peers when extended community exchange is enabled with the `send-community extended` or `send-community both` command. This attribute is used as a load sharing value relative to other paths in forwarding.

In addition, user may want to forcefully change the Link Bandwidth Extended Community for routes received from a BGP peer. They may also only want to set this extended community for only a subset of routes received from the peer. They can achieve that by configuring an inbound route-map towards the peer and configure 'set extcommunity bandwidth <1-4000000>' under it.

Guidelines and Limitations

BGP DMZ Link Bandwidth

Consider the following guidelines and limitations before configuring the Link Bandwidth feature:

- The **dmz-link-bandwidth** command can be configured only under IPv4 unicast and IPv6 unicast address families under a BGP neighbor.
- It will only attach the Link Bandwidth Extended Community to routes received from directly connected BGP neighbors. It will not do so for BGP multi-hop neighbors.
- It can be configured under both global mode and VRF mode.
- BGP multipath load balancing must be configured under the address-family using **maximum-paths** command for this feature to be enabled.
- BGP extended community exchange must be enabled between iBGP neighbors to which the Link Bandwidth Extended Community is to be advertised.

- Link Bandwidth Extended Community will be seamlessly carried to routes leaked from one VRF to another VRF.

Configuring BGP DMZ Link Bandwidth

Beginning with Cisco NX-OS Release 10.5(1)F, you can configure this feature.

SUMMARY STEPS

1. **configure terminal**
2. **router bgp** *as-number*
3. **address-family** [ipv4|ipv6] **unicast**
4. **maximum-paths** *max-path*
5. **template peer** *peer-template-name*
6. **address-family** [ipv4 | ipv6] **unicast**
7. **dmz-link-bandwidth**
8. **neighbor** *neighbor*
9. **remote-as** *remote-as*
10. **address-family** [ipv4 | ipv6] **unicast**
11. **dmz-link-bandwidth**
12. **route-map** *name* **permit** *route*
13. **set extcommunity bandwidth** <1-4000000>
14. **neighbor** *neighbor* **address-family** [ipv4 | ipv6] **unicast** **route-map** *name* **in**

DETAILED STEPS

	Command or Action	Purpose
Step 1	configure terminal Example: switch# configure terminal	Enters global configuration mode.
Step 2	router bgp <i>as-number</i> Example: switch# configure terminal	Enters router configuration mode to create or configure a BGP routing process.
Step 3	address-family [ipv4 ipv6] unicast Example: switch(config)# address-family ipv4 unicast	Configures address family IPv4 or IPv6 unicast.
Step 4	maximum-paths <i>max-path</i> Example: switch(config)# maximum-paths 10	Enable BGP multi-path under address-family.
Step 5	template peer <i>peer-template-name</i> Example:	Enters template mode and configures peer parameter.

	Command or Action	Purpose
	<code>switch(config)# template peer host_peer</code>	
Step 6	address-family [ipv4 ipv6] unicast Example: <code>switch(config)# address-family ipv4 unicast</code>	Configures the address family for IPv4 or IPv6.
Step 7	dmz-link-bandwidth Example: <code>switch(config)# dmz-link-bandwidth</code>	Configures BGP to consider load balancing some traffic towards this directly connected peer by attaching link bandwidth extended community to routes received from it.
Step 8	neighbor <i>neighbor</i> Example: <code>switch(config)# neighbor 1.1.1.1</code> <code>or</code> <code>switch(config)# neighbor 11::1</code>	Configure BGP neighbor.
Step 9	remote-as <i>remote-as</i> Example: <code>switch(config)# remote-as 100</code>	Specify Autonomous System Number of the neighbor .
Step 10	address-family [ipv4 ipv6] unicast Example: <code>switch(config)# address-family ipv4 unicast</code>	Configures the address family IPv4 or IPv6 unicast.
Step 11	dmz-link-bandwidth Example: <code>switch(config)# dmz-link-bandwidth</code>	Configures BGP to consider load balancing some traffic towards this directly connected peer by attaching link bandwidth extended community to routes received from it.
Step 12	route-map <i>name</i> permit <i>route</i> Example: <code>switch(config)# route-map change_link_bandwidth</code> <code>permit 10</code>	Configure route-map.
Step 13	set extcommunity bandwidth <1-400000> Example: <code>switch(config-route-map)# set extcommunity</code> <code>bandwidth 1000</code>	Configure route-map to set link bandwidth extended community.
Step 14	neighbor <i>neighbor</i> address-family [ipv4 ipv6] unicast route-map <i>name</i> in Example: <code>switch(config-router)# neighbor 1.1.1.1</code> <code>switch (config-router-neighbor)# address-family</code> <code>ipv4 unicast</code>	Configure neighbor to be attached to an inbound route-map.

Command or Action	Purpose
switch(config-router-neighbor-af)# route-map change_link_bandwidth in	

Configuration Examples for BGP DMZ Link Bandwidth

In the following example, AS 1 is attached to AS 2 through two unequal bandwidth links. B-D link is 10G and C-D link is 100G. B-D link is 10G and C-D link is 100G. A-B and A-C connected by IBGP session. B-D and C-D connected by EBGP Session.

If you want traffic to be proportionally load balanced according to these link bandwidths that is A should send 10 times the outgoing traffic to C as compared to B, configure dmz-link-bandwidth command on B and C towards EBGP neighbor D. B will package B-D bandwidth into Link Bandwidth Extended Community (LBEC) and attach it to the BGP path for route entry 1.1.1.1/32. Similarly, C will package C-D bandwidth into LBEC and attach it to the BGP path for route entry 1.1.1.1/32.

B and C will advertise the route to iBGP peer A along with LBEC.

On A, BGP will program forwarding with hash 10/110 for NH-B and 100/110 for NH-C.

Figure 33: DMZ Link Bandwidth Configuration

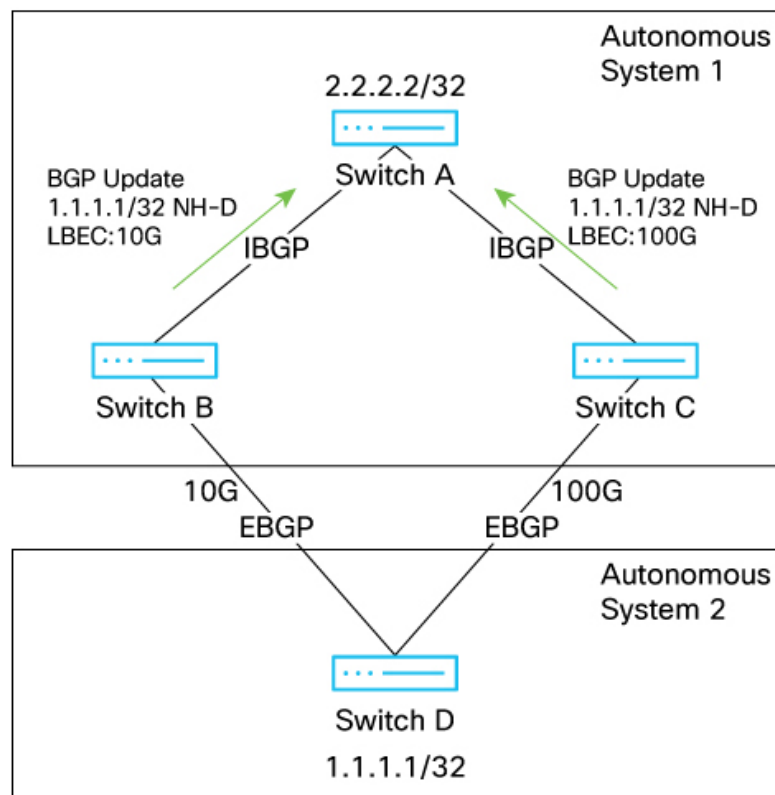

Switch B to D and B to A Configuration

```
router bgp 1
```

```

neighbor D
  address-family ipv4|v6 unicast
    dmz-link-bandwidth
neighbor A
  address-family ipv4|v6 unicast
    send-community extended

```

Switch C to D and C to A Configuration

```

router bgp 1
  neighbor D
    address-family ipv4|v6 unicast
      dmz-link-bandwidth
  neighbor A
    address-family ipv4|v6 unicast
      send-community extended

```

Switch A Control Plane and Data Plane State

BGP table state:

```

1.1.1.1/32
  NH-B    LBEC: 10G
  NH-C    LBEC: 100G

```

Forwarding state:

```

1.1.1.1/32
  NH-B    hash 10:110
  NH-C    hash 100:110

```

Configuring Unequal Cost Multipath (UCMP) Using Link Bandwidth Extended Community

Before you begin

See [Configuring BGP DMZ Link Bandwidth](#). That feature must be first configured at edge devices for this feature to work. This means that at the edge devices, the Link Bandwidth Extended Community must be attached to a BGP route received from a directly connected ebgp peer by either configuring **dmz-link-bandwidth** command or by configuring an inbound route-map with **set extcommunity link-bandwidth <1-4000000>** command. Until that happens, none of the functionality described in this section will work.

Beginning with Cisco NX-OS Release 10.5(1)F, a BGP speaker has the ability to convey to its directly connected BGP neighbor the cumulative bandwidth available from itself to a BGP learnt route if the command 'link-bandwidth cumulative' is configured under the neighbor's address-family mode. It does that by leveraging the Link Bandwidth Extended Community. It will advertise the BGP route with the value n inserted in this extended community, where n = min (Sum of bandwidth obtained from Link Bandwidth Extended Community of all available multi-paths, Bandwidth of link towards the neighbor to which advertisement is being sent).

Guidelines and Limitations

Consider the following guidelines and limitations before configuring the BGP UCMP feature:

- The **link-bandwidth cumulative** command can be configured only under IPv4 unicast and IPv6 unicast address families under a BGP neighbor.
- It will only take effect to towards directly connected BGP neighbors.
- This command will only take effect if all of the available multi-paths have the Link Bandwidth Extended Community.
- It can be configured under both global mode and vrf mode.
- Link Bandwidth Extended Community will be seamlessly carried to routes leaked from one VRF to another VRF.

SUMMARY STEPS

1. **configure terminal**
2. **router bgp** *as-number*
3. **neighbor** *neighbor*
4. **remote-as** *remote-as*
5. **address-family [ipv4 | ipv6] unicast**
6. **send-community extended**
7. **link-bandwidth cumulative**

DETAILED STEPS

	Command or Action	Purpose
Step 1	configure terminal Example: switch# configure terminal	Enters global configuration mode.
Step 2	router bgp <i>as-number</i> Example: switch(config)# router bgp 120	Enters router configuration mode to create or configure a BGP routing process.
Step 3	neighbor <i>neighbor</i> Example: switch(config)# neighbor 1.1.1.1 or switch(config)# neighbor 11::1	Configure BGP neighbor.
Step 4	remote-as <i>remote-as</i> Example: switch(config)# remote-as 100	Specify Autonomous System Number of the neighbor.
Step 5	address-family [ipv4 ipv6] unicast Example: switch(config)# address-family ipv4 unicast	Configures the address family IPv4 or IPv6 unicast.

	Command or Action	Purpose
Step 6	send-community extended Example: <pre>switch(config)# send-community extended</pre>	Configures sending of BGP extended community towards this neighbor.
Step 7	link-bandwidth cumulative Example: <pre>switch(config)# link-bandwidth cumulative</pre>	Sends cumulative link bandwidth towards the neighbor. This configuration doesn't advertise the cumulative link bandwidth to the neighbor if any of the multi-paths doesn't have the link bandwidth extended community.

Configuration Example

Configuration Example

In the following figures:

- Single hop directly connected ebgp devices in 4 clos layers.
- All links are 100G, except B-D and B-E, which are 10G. This means traffic from B to destination 1.1.1.1 is bottle necked at a 20G link bandwidth.
- User wants end-to-end traffic load balancing should account for this lower link bandwidth.
- On each device in Layer T1, configure command **dmz-link-bandwidth** towards every BGP neighbor in Layer T0.
- On each device in Layer T1, configure command **link-bandwidth cumulative** towards every BGP peer in layer T2.
- On each device in Layer T2, configure command **link-bandwidth cumulative** towards every BGP peer in layer T1 and T3.
- On each device in Layer T3, configure command **link-bandwidth cumulative** towards every BGP peer in layer T2.
- Command **dmz-link-bandwidth** will cause switch D to package the bandwidth of link D-F into Link Bandwidth Extended Community (LBEC) and attach it to the corresponding BGP path for route entry 1.1.1.1/32.
- Command **dmz-link-bandwidth** will cause switch E package the bandwidth of link E-F into LBEC and attach it to the corresponding BGP path for route entry 1.1.1.1/32.
- Command **link-bandwidth cumulative** will cause switches A, B, C, D, and E to insert bandwidth **n** into LBEC while advertising BGP update to the peers under which it is configured.
- The value **n** is calculated by using the formula min(Sum of LBEC of all multi-paths, bandwidth towards peer where update is to be advertised.)
- Propagation of LBEC in BGP update will cause forwarding on all devices to be programmed with proportional hashes
- LBEC will be dynamically recalculated in case of link failures.

Figure 34: Configuration Example 1

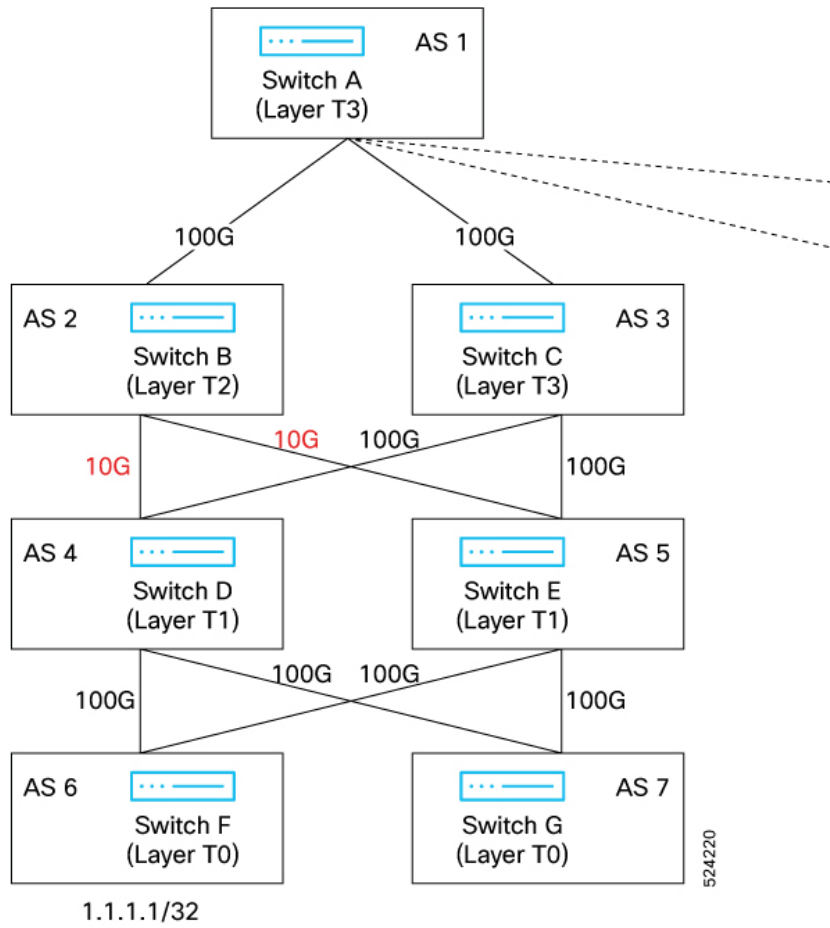
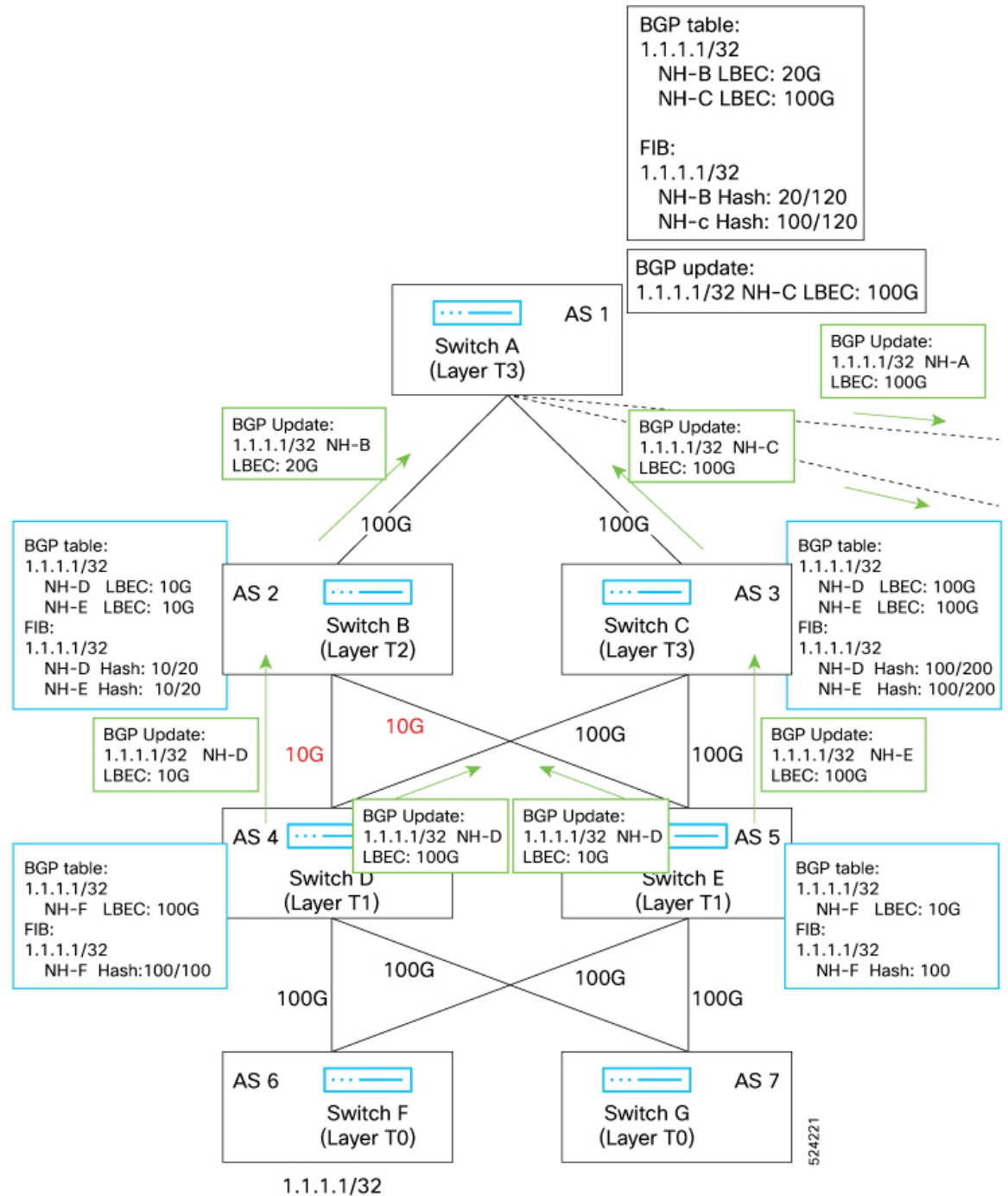

Figure 35: Configuration Example 2



Configuring A to B and C

```
router bgp 1
neighbor B
address-family ipv4|v6 unicast
```

```

        link-bandwidth cumulative
        send-community extended
neighbor C
    address-family ipv4|v6 unicast
        link-bandwidth cumulative
        send-community extended
neighbor B'
    address-family ipv4|v6 unicast
        link-bandwidth cumulative
        send-community extended
neighbor C'
    address-family ipv4|v6 unicast
        link-bandwidth cumulative
        send-community extended

```

Configuring B to D, A, and E

```

router bgp 1
neighbor B
    address-family ipv4|v6 unicast
        link-bandwidth cumulative
        send-community extended
neighbor C
    address-family ipv4|v6 unicast
        link-bandwidth cumulative
        send-community extended
neighbor B'
    address-family ipv4|v6 unicast
        link-bandwidth cumulative
        send-community extended
neighbor C'
    address-family ipv4|v6 unicast
        link-bandwidth cumulative
        send-community extended

```

Configuring C to A, D, and E

```

router bgp 3
neighbor A
    address-family ipv4|v6 unicast
        link-bandwidth cumulative
        send-community extended
neighbor D
    address-family ipv4|v6 unicast
        link-bandwidth cumulative
        send-community extended
neighbor E
    address-family ipv4|v6 unicast
        link-bandwidth cumulative
        send-community extended

```

Configuring D to F, B, and C

```

router bgp 4
neighbor F
    address-family ipv4|v6 unicast
        dmz-link-bandwidth
neighbor B
    address-family ipv4|v6 unicast
        link-bandwidth cumulative
        send-community extended
neighbor C

```

```
address-family ipv4|v6 unicast
  link-bandwidth cumulative
  send-community extended
```

Configuring E to F, B, and C

```
router bgp 5
  neighbor F
    address-family ipv4|v6 unicast
      dmz-link-bandwidth
  neighbor B
    address-family ipv4|v6 unicast
      link-bandwidth cumulative
      send-community extended
  neighbor C
    address-family ipv4|v6 unicast
      link-bandwidth cumulative
      send-community extended
```

Verifying Configuration

Use the following commands to verify configuration:

- Use the following command to see if the dmz-link-bandwidth command is enabled towards a peer

```
show bgp ipv4 unicast neighbors 192.168.11.2 | i i link
dmz-link-bandwidth is enabled
```

- Use the following command to see if the link-bandwidth cumulative command is enabled towards a peer

```
show bgp ipv4 unicast neighbors 10.1.1.2 | i i link
link-bandwidth cumulative is enabled
```

- Use the following command to confirm if BGP path has Link Bandwidth Extended Community

```
show bgp ipv4 unicast 1.1.1.1/32
BGP routing table information for VRF default, address family IPv4 Unicast
BGP routing table entry for 1.1.1.1/32, version 403 Paths: (1 available, best #1) Flags:
  (0x8000001a) (high32 0x002000) on xmit-list, is in urib, is best urib route, is in HW

Advertised path-id 1 Path type: external, path is valid, is best path, no labeled
nexthop, in rib

AS-Path: 10 33299 51178 47751 {27016} , path sourced external to AS 192.168.11.2 (metric
  0) from 192.168.11.2 (192.168.11.2) Origin EGP, MED 2219, localpref 100, weight 0
Community: 1:1 Extcommunity: LB:1:125000000

Path type: external, path is valid, is multi-path, no labeled nexthop, in rib
AS-Path: 10 33299 51178 47751 {27016} , path sourced external to AS 192.168.11.3 (metric
  0) from 192.168.11.2 (192.168.11.2) Origin EGP, MED 2219, localpref 100, weight 0
Community: 1:1 Extcommunity: LB:1:250000000
```

- Use the following command to confirm if routing table has the hashing ratios

```
show ip route 1.1.1.1/32 detail

100.1.1.1/32, ubest/mbest: 1/0 *via 192.168.11.2, [20/2219], 00:14:22, bgp-1, bw:333,
external, tag 10 client-specific data: 10 recursive next hop: 192.168.11.2/32 extended
route information: BGP origin AS 0 BGP peer AS 10
100.1.1.2/32, ubest/mbest: 1/0 *via 192.168.11.3, [20/2219], 00:14:22, bgp-1, bw:666,
external, tag 10 client-specific data: 10 recursive next hop: 192.168.11.3/32 extended
route information: BGP origin AS 0 BGP peer AS 10
```

Advertising the Default Route

You can configure BGP to advertise the default route (network 0.0.0.0).

Before you begin

You must enable BGP (see the [Enabling BGP](#) section).

SUMMARY STEPS

1. **configure terminal**
2. **route-map allow permit**
3. **exit**
4. **ip route *ip-address network-mask* null *null-interface-number***
5. **router bgp *as-number***
6. **address-family {*ipv4* | *ipv6*} unicast**
7. **default-information originate**
8. **redistribute static route-map allow**
9. (Optional) **copy running-config startup-config**

DETAILED STEPS

	Command or Action	Purpose
Step 1	configure terminal Example: <pre>switch# configure terminal switch(config)#</pre>	Enters global configuration mode.
Step 2	route-map allow permit Example: <pre>switch(config)# route-map allow permit switch(config-route-map)#</pre>	Enters router map configuration mode and defines the conditions for redistributing routes.
Step 3	exit Example: <pre>switch(config-route-map)# exit switch(config)#</pre>	Exits router map configuration mode.
Step 4	ip route <i>ip-address network-mask</i> null <i>null-interface-number</i> Example: <pre>switch(config)# ip route 192.0.2.1 255.255.255.0 null 0</pre>	Configures the IP address.
Step 5	router bgp <i>as-number</i> Example:	Enters BGP mode and assigns the AS number to the local BGP speaker.

	Command or Action	Purpose
	<pre>switch(config)# router bgp 65535 switch(config-router)#</pre>	
Step 6	address-family {ipv4 ipv6} unicast Example: <pre>switch(config-router)# address-family ipv4 unicast switch(config-router-af)#</pre>	Enters address-family configuration mode.
Step 7	default-information originate Example: <pre>switch(config-router-af)# default-information originate</pre>	Advertises the default route.
Step 8	redistribute static route-map allow Example: <pre>switch(config-router-af)# redistribute static route-map allow</pre>	Redistributes the default route.
Step 9	(Optional) copy running-config startup-config Example: <pre>switch(config-router-af)# copy running-config startup-config</pre>	Saves this configuration change.

Configuring BGP Attribute Filtering and Error Handling

Beginning with Cisco NX-OS Release 9.3(3), you can configure BGP attribute filtering and error handling to provide an increased level of security. The following features are available and implemented in the following order:

- **Path attribute treat-as-withdraw:** Allows you to treat-as-withdraw a BGP update from a specific neighbor if the update contains a specified attribute type. The prefixes contained in the update are removed from the routing table.
- **Path attribute discard:** Allows you to remove specific path attributes in a BGP update from a specific neighbor.
- **Enhanced attribute error handling:** Prevents peer sessions from flapping due to a malformed update.

Attribute types 1, 2, 3, 4, 5, 8, 14, 15, and 16 cannot be configured for path attribute treat-as-withdraw and path attribute discard. Attribute type 9 (Originator) and type 10 (Cluster-id) can be configured for eBGP neighbors only.

Treating as Withdraw Path Attributes from a BGP Update Message

To "treat-as-withdraw" BGP updates that contain specific path attributes, use the following command in router neighbor configuration mode:

Procedure

	Command or Action	Purpose
Step 1	<p>[no] path-attribute treat-as-withdraw [<i>value</i> range start end] in</p> <p>Example:</p> <pre>switch#(config-router)# neighbor 10.20.30.40 switch(config-router-neighbor)# path-attribute treat-as-withdraw 100 in</pre> <p>Example:</p> <pre>switch#(config-router)# neighbor 10.20.30.40 switch(config-router-neighbor)# path-attribute treat-as-withdraw range 21 255 in</pre>	<p>Treats as withdraw any incoming BGP update messages that contain the specified path attribute or range of path attributes and triggers an inbound route refresh to ensure that the routing table is up to date. Any prefixes in a BGP update that are treat-as-withdraw are removed from the BGP routing table.</p> <p>This command is also supported for BGP template peers and BGP template peer sessions.</p>

Discarding Path Attributes from a BGP Update Message

To discard BGP updates that contain specific path attributes, use the following command in router neighbor configuration mode:

Procedure

	Command or Action	Purpose
Step 1	<p>[no] path-attribute discard [<i>value</i> range start end] in</p> <p>Example:</p> <pre>switch#(config-router)# neighbor 10.20.30.40 switch(config-router-neighbor)# path-attribute discard 100 in</pre> <p>Example:</p> <pre>switch#(config-router)# neighbor 10.20.30.40 switch(config-router-neighbor)# path-attribute discard range 100 255 in</pre>	<p>Drops specified path attributes in BGP update messages for the specified neighbor and triggers an inbound route refresh to ensure that the routing table is up to date. You can configure a specific attribute or an entire range of unwanted attributes.</p> <p>This command is also supported for BGP template peers and BGP template peer sessions.</p> <p>Note When the same path attribute is configured for both discard and treat-as-withdraw, treat-as-withdraw has a higher priority.</p>

Enabling or Disabling Enhanced Attribute Error Handling

BGP enhanced attribute error handling is enabled by default but can be disabled. This feature, which complies with RFC 7606, prevents peer sessions from flapping due to a malformed update. The default behavior applies to both eBGP and iBGP peers.

To disable or reenble enhanced error handling, use the following command in router configuration mode:

Procedure

	Command or Action	Purpose
Step 1	[no] enhanced-error Example: <pre>switch(config)# router bgp 1000 switch(config-router)# enhanced-error</pre>	Enables or disables BGP enhanced attribute error handling.

Displaying Discarded or Unknown Path Attributes

To display information about discarded or unknown path attributes, perform one of the following tasks:

Command	Purpose
show bgp {ipv4 ipv6} unicast path-attribute discard]	Displays all prefixes for which an attribute has been discarded.
show bgp {ipv4 ipv6} unicast path-attribute unknown]	Displays all prefixes that have an unknown attribute.
show bgp {ipv4 ipv6} unicast ip-address	Displays the unknown attributes and discarded attributes associated with a prefix.

The following example shows the prefixes for which an attribute has been discarded:

```
switch# show bgp ipv4 unicast path-attribute discard
Network      Next Hop
1.1.1.1/32   20.1.1.1
1.1.1.2/32   20.1.1.1
1.1.1.3/32   20.1.1.1
```

The following example shows the prefixes that have an unknown attribute:

```
switch# show bgp ipv4 unicast path-attribute unknown
Network      Next Hop
2.2.2.2/32   20.1.1.1
2.2.2.3/32   20.1.1.1
```

The following example shows the unknown attributes and discarded attributes associated with a prefix:

```
switch# show bgp ipv4 unicast 2.2.2.2
BGP routing table entry for 2.2.2.2/32, version 6241
Paths: (1 available, best #1, table default)
  Not advertised to any peer
  Refresh Epoch 1
  1000
    20.1.1.1 from 20.1.1.1 (20.1.1.1)
      Origin IGP, localpref 100, valid, external, best
      unknown transitive attribute: flag 0xE0 type 0x62 length 0x64
        value 0000 0000 0100 0000 0200 0000 0300 0000
              0400 0000 0500 0000 0600 0000 0700 0000
              0800 0000 0900 0000 0A00 0000 0B00 0000
              0C00 0000 0D00 0000 0E00 0000 0F00 0000
              1000 0000 1100 0000 1200 0000 1300 0000
              1400 0000 1500 0000 1600 0000 1700 0000
```

```

1800 0000
rx pathid: 0, tx pathid: 0x0
Updated on Jul 20 2019 07:50:43 PST

```

Tuning BGP

You can tune BGP characteristics through a series of optional parameters.

To tune BGP, use the following optional commands in router configuration mode:

Command	Purpose
<pre> bestpath [always-compare-med as-pathmultipath-relax compare-routerid cost-community ignore igp-metric ignore med {confed missing-as-worst non-deterministic}] </pre> <p>Example:</p> <pre> switch(config-router)# bestpath always-compare-med </pre>	<p>Modifies the best-path algorithm. The optional parameters are as follows:</p> <ul style="list-style-type: none"> • always-compare-med —Compares MED on paths from different autonomous systems. • as-path multipath-relax —Allows load sharing across the providers with different (but equal-length) AS paths. Without this option, the AS paths must be identical for load sharing. • compare-routerid —Compares the router IDs for identical eBGP paths. • cost-community ignore —Ignores the cost community for BGP best-path calculations. • igp-metric ignore —Ignores the Interior Gateway Protocol (IGP) metric for next hop during best-path selection. This option is supported beginning with Cisco NX-OS Release 9.2(2). • med confed —Forces bestpath to do a MED comparison only between paths originated within a confederation. • med missing-as-worst —Treats a missing MED as the highest MED. • med non-deterministic —Does not always pick the best MED path from among the paths from the same autonomous system.
<pre> enforce-first-as </pre> <p>Example:</p> <pre> switch(config-router)# enforce-first-as </pre>	<p>Enforces the neighbor autonomous system to be the first AS number listed in the AS_path attribute for eBGP.</p>

Command	Purpose
<p>log-neighbor-changes</p> <p>Example:</p> <pre>switch(config-router)# log-neighbor-changes</pre>	<p>Generates a system message when any neighbor changes state.</p> <p>Note To suppress neighbor status change messages for a specific neighbor, you can use the log-neighbor-changes disable command in router address-family configuration mode.</p>
<p>router-id <i>id</i></p> <p>Example:</p> <pre>switch(config-router)# router-id 10.165.20.1</pre>	<p>Manually configures the router ID for this BGP speaker.</p>
<p>timers [<i>prefix-peer-wait</i> <i>bgp holdtime</i> prefix-peer-timeout <i>timeout</i> bestpath-limit <i>bestpath-timeout</i>]</p> <p>Example:</p> <pre>switch(config-router)# timers bestpath-limit 300</pre>	<p>Sets BGP timer values. The optional parameters are as follows:</p> <ul style="list-style-type: none"> • <i>prefix-peer-wait</i> —Wait timer for a prefix peer. The range is from 0 to 1200 seconds. The default value is 90. • <i>bgp</i> —BGP session keepalive time. The range is from 0 to 3600 seconds. The default value is 60. • <i>holdtime</i> —Different bgp keepalive and holdtimes. The range is from 0 to 3600 seconds. The default value is 60. • <i>timeout</i> —Prefix peer timeout value. The range is from 0 to 1200 seconds. The default value is 30. • <i>bestpath-timeout</i> —Bestpath timeout in seconds. The default value is 300. When a high-scale BGP setup is expected, the timeout value needs to be set between 480 and 1200, based on the scale. <p>You must manually reset the BGP sessions after configuring this command.</p>

To tune BGP, use the following optional commands in router address-family configuration mode:

Command	Purpose
<p>distance <i>ebgp-distance ibgp-distance local-distance</i></p> <p>Example:</p> <pre>switch(config-router-af)# distance 20 100 200</pre>	<p>Sets the administrative distance for BGP. The range is from 1 to 255. The defaults are as follows:</p> <ul style="list-style-type: none"> • <i>ebgp-distance</i> —20. • <i>ibgp-distance</i> —200. • <i>local-distance</i> —220. Local-distance is the administrative distance used for aggregate discard routes when they are installed in the RIB. <p>After you enter the value for the external administrative distance, you must enter the value for the administrative distance for the internal routes or/and the value for the administrative distance for the local routes depending on your requirement; so that the internal/local routes are also considered in the route administration.</p>
<p>log-neighbor-changes [disable]</p> <p>Example:</p> <pre>switch(config-router-af)# log-neighbor-changes disable</pre>	<p>Generates a system message when this specific neighbor changes state.</p> <p>The disable option suppresses neighbor status changes messages for this specific neighbor.</p>

To tune BGP, use the following optional commands in neighbor configuration mode:

Command	Purpose
<p>description <i>string</i></p> <p>Example:</p> <pre>switch(config-router-neighbor)# description main site</pre>	<p>Sets a descriptive string for this BGP peer. The string can be up to 80 alphanumeric characters.</p>
<p>low-memory exempt</p> <p>Example:</p> <pre>switch(config-router-neighbor)# low-memory exempt</pre>	<p>Exempts this BGP neighbor from a possible shutdown due to a low memory condition.</p>
<p>transport connection-mode passive</p> <p>Example:</p> <pre>switch(config-router-neighbor)# transport connection-mode passive</pre>	<p>Allows a passive connection setup only. This BGP speaker does not initiate a TCP connection to a BGP peer. You must manually reset the BGP sessions after configuring this command.</p>

Command	Purpose
<p>[no default] remove-private-as [all replace-as]</p> <p>Example:</p> <pre>switch(config-router-neighbor) # remove-private-as</pre>	<p>Removes private AS numbers from outbound route updates to an eBGP peer. This command triggers an automatic soft clear or refresh of BGP neighbor sessions.</p> <p>The optional parameters are as follows:</p> <ul style="list-style-type: none"> • no —Disables the command. • default —Moves the command to its default mode. • all —Removes all private-as numbers from the AS-path value. • replace-as —Replaces all private AS numbers with the replace-as AS-path value. <p>See the Guidelines and Limitations for Advanced BGP, on page 328 section for additional information on this command.</p>
<p>update-source <i>interface-type number</i></p> <p>Example:</p> <pre>switch(config-router-neighbor) # update-source ethernet 2/1</pre>	<p>Configures the BGP speaker to use the source IP address of the configured interface for BGP sessions to the peer. This command triggers an automatic notification and session reset for the BGP neighbor sessions. Single-hop iBGP peers support fast external fallover when update-source is configured.</p>

To tune BGP, use the following optional commands in neighbor address-family configuration mode:

Command	Purpose
<p>allows in</p> <p>Example:</p> <pre>switch(config-router-neighbor-af) # allows in</pre>	<p>Allows routes that have their own AS in the AS path to be installed in the BRIB.</p>
<p>default-originate [route-map <i>map-name</i>]</p> <p>Example:</p> <pre>switch(config-router-neighbor-af) # default-originate</pre>	<p>Generates a default route to the BGP peer.</p>
<p>disable-peer-as-check</p> <p>Example:</p> <pre>switch(config-router-neighbor-af) # disable-peer-as-check</pre>	<p>Disables peer AS-number checking while the device advertises routes learned from one node to another node in the same AS path.</p>

Command	Purpose
<p>filter-list <i>list-name</i> {in out}</p> <p>Example:</p> <pre>switch(config-router-neighbor-af) # filter-list BGPFilter in</pre>	Applies an AS_path filter list to this BGP peer for inbound or outbound route updates. This command triggers an automatic soft clear or refresh of BGP neighbor sessions.
<p>prefix-list <i>list-name</i> {in out}</p> <p>Example:</p> <pre>switch(config-router-neighbor-af) # prefix-list PrefixFilter in</pre>	Applies a prefix list to this BGP peer for inbound or outbound route updates. This command triggers an automatic soft clear or refresh of BGP neighbor sessions.
<p>send-community</p> <p>Example:</p> <pre>switch(config-router-neighbor-af) # send-community</pre>	Sends the community attribute to this BGP peer. This command triggers an automatic soft clear or refresh of BGP neighbor sessions.
<p>send-community extended</p> <p>Example:</p> <pre>switch(config-router-neighbor-af) # send-community extended</pre>	Sends the extended community attribute to this BGP peer. This command triggers an automatic soft clear or refresh of BGP neighbor sessions.
<p>suppress-inactive</p> <p>Example:</p> <pre>switch(config-router-neighbor-af) # suppress-inactive</pre>	Advertises the best (active) routes only to the BGP peer. This command triggers an automatic soft clear or refresh of BGP neighbor sessions.
<p>[no default] as-override</p> <p>Example:</p> <pre>switch(config-router-neighbor-af) # as-override</pre>	<p>no - (Optional) Disables the command.</p> <p>default - (Optional) Moves the command to its default mode.</p> <p>as-override - While sending updates to eBGP peer, replaces in the <i>path</i> attribute all occurrences of the peer's AS number with the local AS number.</p>

Configuring Policy-Based Administrative Distance

You can configure a distance for external BGP (eBGP) and internal BGP (iBGP) routes that match a policy described in the configured route map. The distance configured in the route map is downloaded to the unicast RIB along with the matching routes. BGP uses the best path to determine the administrative distance when downloading next hops in the unicast RIB table. If there is no match or a deny clause in the policy, BGP uses the distance configured in the distance command or the default distance for routes.

The policy-based administrative distance feature is useful when there are two or more different routes to the same destination from two different routing protocols.

Before you begin

You must enable BGP.

SUMMARY STEPS

1. switch# **configure terminal**
2. switch(config)# **ip prefix-list** *name seq number permit prefix-length*
3. switch(config)# **route-map** *map-tag permit sequence-number*
4. switch(config-route-map)# **match ip address prefix-list** *prefix-list-name*
5. switch(config-route-map)# **set distance** *value1 value2 value3*
6. switch(config-route-map)# **exit**
7. switch(config)# **router bgp** *as-number*
8. switch(config-router)# **address-family** {*ipv4 | ipv6 | vpnv4 | vpnv6*} **unicast**
9. switch(config-router-af)# **table-map** *map-name*
10. (Optional) switch(config-router-af)# **show forwarding distribution**
11. (Optional) switch(config)# **copy running-config startup-config**

DETAILED STEPS

	Command or Action	Purpose
Step 1	switch# configure terminal	Enters global configuration mode.
Step 2	switch(config)# ip prefix-list <i>name seq number permit prefix-length</i>	Creates a prefix list to match IP packets or routes with the permit keyword.
Step 3	switch(config)# route-map <i>map-tag permit sequence-number</i>	Creates a route map and enters route-map configuration mode with the permit keyword. If the match criteria for the route is met in the policy, the packet is policy routed.
Step 4	switch(config-route-map)# match ip address prefix-list <i>prefix-list-name</i>	Matches IPv4 network routes based on a prefix list. The prefix-list name can be any alphanumeric string up to 63 characters.
Step 5	switch(config-route-map)# set distance <i>value1 value2 value3</i>	Specifies the administrative distance for interior BGP (iBGP) or exterior BGP (eBGP) routes and BGP routes originated in the local autonomous system. The range is from 1 to 255. After you enter the value for the external administrative distance, you must enter the value for the administrative distance for the internal routes or/and the value for the administrative distance for the local routes depending on your requirement; so that the internal/local routes are also considered in the route administration.
Step 6	switch(config-route-map)# exit	Exits route-map configuration mode.
Step 7	switch(config)# router bgp <i>as-number</i>	Enters BGP mode and assigns the AS number to the local BGP speaker.

	Command or Action	Purpose
Step 8	switch(config-router)# address-family { ipv4 ipv6 vpn4 vpn6 } unicast	Enters address family configuration mode.
Step 9	switch(config-router-af)# table-map <i>map-name</i>	Configures the selective administrative distance for a route map for BGP routes before forwarding them to the RIB table. The table-map name can be any alphanumeric string up to 63 characters. Note You can also configure the table-map command under the VRF address-family configuration mode.
Step 10	(Optional) switch(config-router-af)# show forwarding distribution	Displays forwarding information distribution.
Step 11	(Optional) switch(config)# copy running-config startup-config	Saves the change persistently through reboots and restarts by copying the running configuration to the startup configuration.

Configuring Multiprotocol BGP

You can configure MP-BGP to support multiple address families, including IPv4 and IPv6 unicast and multicast routes.

Before you begin

You must enable BGP.

SUMMARY STEPS

1. **configure terminal**
2. **router bgp** *as-number*
3. **neighbor** *ip-address* **remote-as** *as-number*
4. **address-family** {**ipv4** | **ipv6**} {**unicast** | **multicast**}
5. (Optional) **copy running-config startup-config**

DETAILED STEPS

	Command or Action	Purpose
Step 1	configure terminal Example: switch# configure terminal switch(config)#	Enters global configuration mode.
Step 2	router bgp <i>as-number</i> Example: switch(config)# router bgp 65535 switch(config-router)#	Enters BGP mode and assigns the autonomous system number to the local BGP speaker.

	Command or Action	Purpose
Step 3	neighbor <i>ip-address remote-as as-number</i> Example: <pre>switch(config-router)# neighbor 192.168.1.2 remote-as 65534 switch(config-router-neighbor)#</pre>	Places the router in neighbor configuration mode for BGP routing and configures the neighbor IP address.
Step 4	address-family { <i>ipv4 ipv6</i> } { <i>unicast multicast</i> } Example: <pre>switch(config-router-neighbor)# address-family ipv4 multicast switch(config-router-neighbor-af)#</pre>	Enters address family configuration mode.
Step 5	(Optional) copy running-config startup-config Example: <pre>switch(config-router-neighbor-af)# copy running-config startup-config</pre>	Saves this configuration change.

Example

This example shows how to enable advertising and receiving IPv4 and IPv6 routes for multicast RPF for a neighbor:

```
switch# configure terminal
switch(config)# interface ethernet 2/1
switch(config-if)# ipv6 address 2001:0DB8::1
switch(config-if)# router bgp 65536
switch(config-router)# neighbor 192.168.1.2 remote-as 35537
switch(config-router-neighbor)# address-family ipv4 multicast
switch(config-router-neighbor-af)# exit
switch(config-router-neighbor)# address-family ipv6 multicast
switch(config-router-neighbor-af)# copy running-config startup-config
```

Configuring BMP

Beginning with Cisco NX-OS Release 7.0(3)I5(2), you can configure BMP on the device.

Before you begin

You must enable BGP (see the [Enabling BGP](#) section).

SUMMARY STEPS

1. **configure terminal**
2. **router bgp as-number**
3. **bmp server server-number**
4. **address ip-address port-number port-number**
5. **description string**

6. **initial-refresh** { *skip* / *delay time* }
7. **initial-delay** *time*
8. **stats-reporting-period** *time*
9. shutdown
10. **vrf** *vrf-name*
11. **update-source** <*interface-name*>
12. **neighbor ip-address**
13. **remote-as** *as-number*
14. **bmp-activate-server** *server-number*
15. (Optional) **show bgp bmp server** [*server-number*] [*detail*]
16. (Optional) **copy running-config startup-config**

DETAILED STEPS

	Command or Action	Purpose
Step 1	configure terminal Example: switch# configure terminal	Enters global configuration mode.
Step 2	router bgp as-number Example: switch(config)# router bgp 200	Enters BGP mode and assigns the autonomous system number to the local BGP speaker.
Step 3	bmp server server-number Example: switch(config-router-bmp)# bmp-server 1	Configures the BMP server to which BGP should send information. The server number is used as a key. Note You can configure up to two BMP servers.
Step 4	address ip-address port-number port-number Example: switch(config-router-bmp)# address 10.1.1.1 port-number 2000	Configures the IPv4 or IPv6 address of the host and the port number on which the BMP speaker connects to the BMP server.
Step 5	description string Example: switch(config-router-bmp)# description BMPserver1	Configures the BMP server description. You can enter up to 256 alphanumeric characters.
Step 6	initial-refresh { skip / delay time } Example: switch(config-router-bmp)# initial-refresh delay 100	Configures the option to send a route refresh when BGP is converged and the BMP server connection is established later. The skip option specifies to not send a route refresh if the BMP server connection comes up later. The delay option specifies the time in seconds after which the route refresh should be sent. The range is from 30 to 720 seconds, and the default value is 30 seconds.

	Command or Action	Purpose
Step 7	initial-delay <i>time</i> Example: switch(config-router-bmp)# initial-delay 120	Configures the delay after which a connection is attempted to the BMP server. The range is from 30 to 720 seconds, and the default value is 45 seconds.
Step 8	stats-reporting-period <i>time</i> Example: switch(config-router-bmp)# stats-reporting-period 50	Configures the time interval in which the BMP server receives the statistics report from BGP neighbors. The range is from 30 to 720 seconds, and the default is disabled.
Step 9	shutdown Example: switch(config-router-bmp)# shutdown	Disables the connection to the BMP server.
Step 10	vrf <i>vrf-name</i> Example: switch(config-router-bmp)# vrf BMP	Selects vrf in which BMP server is reachable.
Step 11	update-source < <i>interface-name</i> > Example: switch(config-router-bmp)# update-source ethernet4/2	Selects local interface to be used for establishing BMP server connection.
Step 12	neighbor ip-address Example: switch(config-router-bmp)# neighbor 192.168.1.2	Enters neighbor configuration mode for BGP routing and configures the neighbor IP address.
Step 13	remote-as <i>as-number</i> Example: switch(config-router-neighbor)# remote-as 65535	Configures the AS number for a remote BGP peer.
Step 14	bmp-activate-server <i>server-number</i> Example: switch(config-router-neighbor)# bmp-activate-server 1	Configures the BMP server to which a neighbor's information should be sent.
Step 15	(Optional) show bgp bmp server [<i>server-number</i>] [<i>detail</i>] Example: switch(config-router-neighbor)# show bgp bmp server	Displays BMP server information.
Step 16	(Optional) copy running-config startup-config Example: switch(config-router-neighbor)# copy running-config startup-config	Saves this configuration change.

BGP Local Route Leaking

About BGP Local Route Leaking

Beginning with release 9.3(1), NX-OS BGP supports leaking imported VPN routes between:

- The VPN route table and default VRF route table
- The VPN route table and VRF-lite route table
- Border leaf (BL) switch route tables for leaf-to-leaf connectivity

This feature enables the propagation of routes between the route tables. You can control route leaking for a VRF by configuring an import or export map, which now includes an option to allow or prevent incoming locally originated routes and specify whether they should be advertised. Local route leaking is bidirectional, so routes that are locally originated can be leaked from a VRF out to a BGP VPN, and routes that are imported from the BGP VPN can be leaked into a VRF.



Note NX-OS supports a similar feature called centralized route leaking. For information, see [Configuring Layer 3 Virtualization, on page 471](#).

Guidelines and Limitations for BGP Local Route Leaking

The following are the guidelines and limitations for the BGP local route leaking feature:

- The following Cisco hardware supports this feature:
 - Cisco Nexus 9332C, 9364C, 9300-EX, 9300-FX/FXP/FX2/FX3, and 9300-GX platform switches, and Cisco Nexus 9500 platform switches with 9700-EX/FX line cards
 - Cisco Nexus 9500 platform switches with -R line cards
- When using route-targets, the same route-targets might have duplicated paths pointing to the same remote path, which can negatively impact the switch's memory and performance. Be careful when using route targets.
- Be careful when using local route leaking in a leaf-to-leaf case, where border-leaf routers (BLs) are leaking between the same VRFs. This scenario is more prone to routing loops. We recommend using inbound route-maps to exclude the imported routes from other BLs.
- After a remote path gets withdrawn, it can take up to 20 seconds more for BGP to completely clean up the path.

Configuring Routes Imported from a VPN to Leak into the Default VRF

You can configure a VRF to allow routes that are imported from a BGP VPN to be exported to the default VRF. Use this procedure for a non-default VRF.

Before you begin

If you have not already enabled BGP, enable it now (**feature bgp**).

SUMMARY STEPS

1. **config terminal**
2. **vrf context** *vrf-name*
3. **address-family** *address-family sub family*
4. **export vrf default** [*prefix-limit*] **maproute-map allow-vpn**

DETAILED STEPS

	Command or Action	Purpose
Step 1	config terminal Example: <pre>switch-1# config terminal Enter configuration commands, one per line. End with CNTL/Z. switch-1(config)#</pre>	Enters global configuration mode.
Step 2	vrf context <i>vrf-name</i> Example: <pre>switch-1(config)# vrf context vpn1 switch-1(config-vrf)#</pre>	Creates a new VRF and enters VRF configuration mode. The name can be any case-sensitive, alphanumeric string up to 32 characters.
Step 3	address-family <i>address-family sub family</i> Example: <pre>switch-1(config-vrf)# address-family ipv4 unicast switch-1(config-vrf-af-ipv4)#</pre>	
Step 4	export vrf default [<i>prefix-limit</i>] maproute-map allow-vpn Example: <pre>switch-1(config-vrf-af-ipv4)# export vrf default map vpnmap1 allow-vpn switch-1(config-vrf-af-ipv4)#</pre>	Configures the current VRF to allow routes that are imported from a BGP VPN to be exported to the default VRF.

Configuring Routes Leaked from the Default-VRF to Export to a VPN

You can configure a VRF to allow routes leaked from the default VRF to be exported to a BGP VPN. Use this procedure for a non-default VRF.

Before you begin

If you have not already enabled BGP, enable it now (**feature bgp**).

SUMMARY STEPS

1. **config terminal**
2. **vrf context** *vrf-name*

3. **address-family** *address-family sub family*
4. **import vrf default** [*prefix-limit*] **maproute-map advertise-vpn**

DETAILED STEPS

	Command or Action	Purpose
Step 1	config terminal Example: <pre>switch-1# config terminal Enter configuration commands, one per line. End with CNTL/Z. switch-1(config)#</pre>	Enters global configuration mode.
Step 2	vrf context <i>vrf-name</i> Example: <pre>switch-1(config)# vrf context vpn1 switch-1(config-vrf)#</pre>	Creates a new VRF and enters VRF configuration mode. The name can be any case-sensitive, alphanumeric string up to 32 characters.
Step 3	address-family <i>address-family sub family</i> Example: <pre>switch-1(config-vrf)# address-family ipv4 unicast switch-1(config-vrf-af-ipv4)#</pre>	
Step 4	import vrf default [<i>prefix-limit</i>] maproute-map advertise-vpn Example: <pre>switch-1(config-vrf-af-ipv4)# import vrf map vpnmap1 advertise-vpn switch-1(config-vrf-af-ipv4)#</pre>	Configures the current VRF to allow routes imported from the default VRF to be exported to a BGP VPN.

Configuring Routes Imported from a VPN to Export to a VRF

You can configure a VRF to allow VPN imported routes to be exported to another VRF. Use this procedure for non-default VRFs.

Before you begin

If you have not already enabled BGP, enable it now (**feature bgp**).

SUMMARY STEPS

1. **config terminal**
2. **vrf context** *vrf-name*
3. **address-family** *address-family sub family*
4. **export vrf allow-vpn**

DETAILED STEPS

	Command or Action	Purpose
Step 1	config terminal Example: <pre>switch-1# config terminal Enter configuration commands, one per line. End with CNTL/Z. switch-1(config)#</pre>	Enters global configuration mode.
Step 2	vrf context vrf-name Example: <pre>switch-1(config)# vrf context vpn1 switch-1(config-vrf)#</pre>	Creates a new VRF and enters VRF configuration mode. The name can be any case-sensitive, alphanumeric string up to 32 characters.
Step 3	address-family address-family sub family Example: <pre>switch-1(config-vrf)# address-family ipv4 unicast switch-1(config-vrf-af-ipv4)#</pre>	
Step 4	export vrf allow-vpn Example: <pre>switch-1(config-vrf-af-ipv4)# export vrf allow-vpn nxosv2(config-vrf-af-ipv4)#</pre>	Configures a VRF to allow routes imported from a BGP VPM to be exported to a non-default VRF.

Configuring Routes Imported from a VRF to Export to a VPN

You can configure a VRF to allow routes imported from another VRF to be exported to a BGP VPN. Use this procedure for non-default VRFs.

Before you begin

If you have not already enabled BGP, enable it now (**feature bgp**).

SUMMARY STEPS

1. **config terminal**
2. **vrf context vrf-name**
3. **address-family address-family sub family**
4. **import vrf advertise-vpn**

DETAILED STEPS

	Command or Action	Purpose
Step 1	config terminal Example: <pre>switch-1# config terminal Enter configuration commands, one per line. End</pre>	Enters global configuration mode.

	Command or Action	Purpose
	with CNTL/Z. switch-1(config)#	
Step 2	vrf context <i>vrf-name</i> Example: switch-1(config)# vrf context vpn1 switch-1(config-vrf)#	Creates a new VRF and enters VRF configuration mode. The name can be any case-sensitive, alphanumeric string up to 32 characters.
Step 3	address-family <i>address-family sub family</i> Example: switch-1(config-vrf)# address-family ipv4 unicast switch-1(config-vrf-af-ipv4)#	
Step 4	import vrf advertise-vpn Example: switch-1(config-vrf-af-ipv4)# import vrf advertise-vpn nxosv2(config-vrf-af-ipv4)#	Configures the current VRF to allow routes that are imported from another VRF to be exported to a BGP VPN.

Configuration Examples

The following show sample configurations for the BGP local route leaking feature.

Configuring BGP VPN to Default VRF Reachability

In this example, the configuration enables route re-importation through an intermediate VRF, called VRF_A, which is between the VPN and the default VRF.

```
vrf context VRF_A
  address-family ipv4 unicast
  route-target both auto evpn
  import vrf default map MAP_1 advertise-vpn
  export vrf default map MAP_1 allow-vpn
```

Route re-importation is enabled by using the **advertise-vpn** option to control importing routes from the VPN into VRF_A, and **allow-vpn** for the export map to control exporting VPN-imported routes from VRF_A out to the default VRF. Configuration occurs on the intermediate VRF.

Configuring VPN to VRF-Lite Reachability

In this example, the VPN connects to a tenant VRF, called VRF_A. VRF_A connects a VRF-Lite, called VRF-B. The configuration enables VPN imported routes to be leaked from VRF_A to VRF_B.

```
vrf context VRF_A
  address-family ipv4 unicast
  route-target both auto
  route-target both auto evpn
  route-target import 3:3
  route-target export 2:2
  import vrf advertise-vpn
  export vrf allow-vpn
vrf context VRF_B
  address-family ipv4 unicast
  route-target both 1:1
```



```
route-target import 2:2
route-target export 3:3
```

Route leaking between the two is enabled by using the **allow-vpn** in an export map configured in VRF_A (tenant). The export map in VRF_A allows route imported from the VPN to be leaked into the VRF_B. Routes processed by the export map have the **route-mapexport** and **export-map** attributes added to the route's set of route targets. The import map uses **advertise-vpn** which enables routes that are imported from the VRF-Lite for be exported out to the VPN.

After a route leaks between the VRFs, it is reoriginated and its route targets are replaced by the route target export and export map attributes specified by the new VRF's configuration.

Leaf-to-Leaf Reachability

In this example, two VPNs exist and two VRFs exist. VPN_1 is connected to VRF_A and VPN_2 is connected to VRF_B. Both VRFs are route distinguishers (RDs).

```
vrf context VRF_A
  address-family ipv4 unicast
  route-target both auto
  route-target both auto evpn
  route-target import 3:3
  route-target export 2:2
  import vrf advertise-vpn
  export vrf allow-vpn
vrf context VRF_B
  address-family ipv4 unicast
  route-target both 1:1
  route-target import 2:2
  route-target export 3:3
  import vrf advertise-vpn
  export vrf allow-vpn
```

Route leaking between the two is enabled by **allow-vpn** in an export map configured in VRF_A and VRF_B. VPN imported routes have **route-mapexport** and **export-map** attributes added to the route's set of route targets. An import map uses the **advertise-vpn** option which enables routes that are imported from each VRF to be exported out to the VPN.

After a route leaks between the VRFs, it is reoriginated and its route targets are replaced by the route target export and export map attributes specified by the new VRF's configuration.

Leaf-to-Leaf with Loop Prevention

In the leaf-to-leaf configuration, you can inadvertently cause loops between the BLs that are leaking between the same VRFs unless you are careful with your route maps:

- You can use an inbound route map in each BL to deny updates from every other BL.
- If a BL originates a route, a standard community can be applied, which enables other BLs to accept the routes. This community is then stripped in the receiving BL.

In the following example, VTEPs 3.3.3.3, 4.4.4.4 and 5.5.5.5 are the BLs.

```
ip prefix-list BL_PREFIX_LIST seq 5 permit 3.3.3.3/32
ip prefix-list BL_PREFIX_LIST seq 10 permit 4.4.4.4/32
ip prefix-list BL_PREFIX_LIST seq 20 permit 5.5.5.5/32
ip community-list standard BL_COMMUNITY seq 10 permit 123:123
route-map INBOUND_MAP permit 5
  match community BL_COMMUNITY
  set community none
route-map INBOUND_MAP deny 10
```

```

    match ip next-hop prefix-list BL_PREFIX_LIST
route-map INBOUND_MAP permit 20
route-map OUTBOUND_SET_COMM permit 10
    match evpn route-type 2 mac-ip
    set community 123:123
route-map SET_COMM permit 10
    set community 123:123
route-map allow permit 10

vrf context vni100
    vni 100
    address-family ipv4 unicast
        route-target import 2:2
        route-target export 1:1
        route-target both auto
        route-target both auto evpn
    import vrf advertise-vpn
    export vrf allow-vpn

vrf context vni200
    vni 200
    address-family ipv4 unicast
        route-target import 1:1
        route-target export 2:2
        route-target both auto
        route-target both auto evpn
    import vrf advertise-vpn
    export vrf allow-vpn

router bgp 100
    template peer rr
        remote-as 100
        update-source loopback0
        address-family l2vpn evpn
            send-community
            send-community extended
            route-map INBOUND_MAP in
            route-map OUTBOUND_SET_COMM out
    neighbor 101.101.101.101
        inherit peer rr
    neighbor 102.102.102.102
        inherit peer rr
    vrf vni100
        address-family ipv4 unicast
            network 3.3.3.100/32 route-map SET_COMM
    vrf vni200
        address-family ipv4 unicast
            network 3.3.3.200/32 route-map SET_COMM

```

In this example, the tenant VRFs for the border leaf (BL) router can leak traffic by enabling extra import export flows, and the route targets in the route maps determine where the routes are imported from or exported to.

Multipath in a VRF

In this example, a VPN has multiple incoming paths. This configuration enables route leaking through an intermediate VRF, called VRF_A, which is between the VPN and another VRF, named VRF_B. Assume that multipathing is enabled in VRF_A.

```

vrf context VRF_A
    address-family ipv4 unicast
        route-target both auto evpn
        route-target export 3:3

```

```

export vrf allow-vpn
vrf context VRF_B
  address-family ipv4 unicast
  route-target import 3:3

```

Route leaking is enabled by **allow-vpn** in the export map configured in VRF_A. When two paths for a given prefix are learnt from a VPN and imported into VRF_A, two different paths exist in VRF_B with the same source RD (VRF_A's local RD). Each route is distinguished by the original source RD (remote RD).

Path Duplication

In this example, the configuration enables a single VPN path to be imported into both VRF_A and VRF_B. Because VRF_A is configured with **export vrf allow-vpn**, VRF_A also leaks its routes into VRF_B. VRF_B then has two paths with same source RD (VRF_A's local RD), each one distinguished by the original source RD (remote RD).

```

vrf context VRF_A
  address-family ipv4 unicast
  route-target import 1:1 evpn
  route-target export 1:1 evpn
  route-target export 2:2
  export vrf allow-vpn
vrf context VRF_B
  address-family ipv4 unicast
  route-target import 1:1 evpn
  route-target import 2:2

```

This configuration creates a situation in which multipathing does not exist.

Displaying BGP Local Route Leaking Information

The following show commands contain information for the BGP local route leaking feature.

Command	Action
show bgp vrf <i>vrf-name</i> process	For a default or non-default VRF, shows the enabled state (Yes or No) of the import advertise-vpn and export allow-vpn options.
show bgp vrf <i>vrf-name</i> ipv4 unicast <i>prefix</i>	Shows information about imported paths, including a list of destinations a route has been imported from.

BGP Graceful Shutdown

About BGP Graceful Shutdown

Beginning with release 9.3(1), BGP supports the graceful shutdown feature. This BGP feature works with the BGP **shutdown** command to:

- Dramatically decrease the network convergence time when a router or link is taken offline.
- Reduce or eliminate dropped packets that are in transit when a router or link is taken offline.

Despite the name, BGP graceful shutdown does not actually cause a shutdown. Instead, it alerts connected routers that a router or link will be going down soon.

The graceful shutdown feature uses the GRACEFUL_SHUTDOWN well-known community (0xFFFF0000 or 65535:0), which is identified by IANA and the IETF through RFC 8326. This well-known community can be attached to any routes, and it is processed like any other attribute of a route.

Because this feature announces that a router or link will be going down, the feature is useful in preparation of maintenance windows or planned outages. Use this feature before shutting down BGP to limit the impact on traffic.

Graceful Shutdown Aware and Activate

BGP routers can control the preference of all routes with the GRACEFUL_SHUTDOWN community through the concept of GRACEFUL SHUTDOWN awareness. Graceful shutdown awareness is enabled by default, which enables the receiving peers to deprefer incoming routes carrying the GRACEFUL_SHUTDOWN community. Although not a typical use case, you can disable and reenable graceful shutdown awareness through the **graceful-shutdown aware** command.

Graceful shutdown aware is applicable only at the BGP global context. For information about contexts, see [Graceful Shutdown Contexts, on page 408](#). The aware option operates with another option, the **activate** option, which you can assign to a route map for more granular control over graceful shutdown routes.

Interaction of the Graceful Shutdown Aware and Activate Options

When a graceful shutdown is activated, the GRACEFUL_SHUTDOWN community is appended to route updates only when you specify the **activate** keyword. At this point, new route updates that contain the community are generated and transmitted. When the **graceful-shutdown aware** command is configured, all routers that receive the community then deprefer (lower the route preference of) the routes in the update. Without the **graceful-shutdown aware** command, BGP does not deprefer routes with the GRACEFUL_SHUTDOWN community.

After the feature is activated and the routers are aware of graceful shutdown, BGP still considers the routes with the GRACEFUL_SHUTDOWN community as valid. However, those routes are given the lowest priority in the best-path calculation. If alternate paths are available, new best paths are chosen, and convergence occurs to accommodate the router or link that will soon go down.

Graceful Shutdown Contexts

BGP graceful shutdown feature has two contexts that determine what the feature affects and what functionality is available.

Context	Affects	Commands
Global	The entire switch and all routes processed by it. For example, readvertise all routes with the GRACEFUL_SHUTDOWN community.	graceful-shutdown activate [route-map route-map] graceful-shutdown aware

Context	Affects	Commands
Peer	A BGP peer or a link between neighbors. For example, advertise only one link between peers with GRACEFUL_SHUTDOWN community.	graceful-shutdown activate [route-map route-map]

Graceful Shutdown with Route Maps

Graceful shutdown works with the route policy manager (RPM) feature to control how the switch's BGP router transmits and receives routes with the GRACEFUL_SHUTDOWN community. Route maps can process route updates with the community in the inbound and outbound directions. Typically, route maps are not required. However, if needed, you can use them to customize the control of graceful shutdown routes.

Normal Inbound Route Maps

Normal inbound route maps affect routes that are incoming to the BGP router. Normal inbound route maps are not commonly used with the graceful shutdown feature because routers are aware of graceful shutdown by default.

Cisco Nexus switches running Cisco NX-OS Release 9.3(1) and later do not require an inbound route map for the graceful shutdown feature. Cisco NX-OS Release 9.3(1) and later have implicit inbound route maps that automatically deprefer any routes that have the GRACEFUL_SHUTDOWN community if the BGP router is graceful shutdown aware.

Normal inbound route maps can be configured to match against the well-known GRACEFUL_SHUTDOWN community. Although these inbound route maps are not common, there are some cases where they are used:

- If switches are running a Cisco NX-OS release earlier than 9.3(1), they do not have the implicit inbound route map present in NX-OS 9.3(1). To use the graceful shutdown feature on these switches, you must create a graceful shutdown inbound route map. The route map must match inbound routes with the well-known GRACEFUL_SHUTDOWN community, permit them, and deprefer them. If an inbound route map is needed, create it on the BGP peer that is running a version of NX-OS earlier than 9.3(1) and is receiving the graceful shutdown routes.
- If you want to disable graceful shutdown aware, but still want the router to act on incoming routes with GRACEFUL_SHUTDOWN community from some BGP neighbors, you can configure an inbound route map under the respective peers.

Normal Outbound Route Maps

Normal outbound route maps control forwarding the routes that a BGP router sends. Normal outbound route maps can affect the graceful shutdown feature. For example, you can configure an outbound route map to match on the GRACEFUL_SHUTDOWN community and set attributes, and it takes precedence over any graceful shutdown outbound route maps.

Graceful Shutdown Outbound Route Maps

Outbound Graceful shutdown route maps are specific type of outbound route map for the graceful shutdown feature. They are optional, but they are useful when you already have a community list that is associated with

a route map. The typical graceful shutdown outbound route map contains only `set` clauses to set or modify certain attributes.

You can use outbound route maps in the following ways:

- For customers that already have existing outbound route maps, you can add a new entry with a higher sequence number, match on the `GRACEFUL_SHUTDOWN` well-known community, and add any attributes that you want.
- You can also use a graceful shutdown outbound route map with the **graceful-shutdown activate route-map *name*** option. This is the typical use case.

This route map requires no match clauses, so the route map matches on all routes being sent to the neighbor.

Route Map Precedence

When multiple route maps are present on the same router, the following order of precedence is applied to determine how routes with the community are processed: Consider the following example. Assume you have a standard outbound route map name Red that sets a local-preference of 60. Also, assume you have a peer graceful-shutdown route map that is named Blue that sets local-pref to 30. When the route update is processed, the local preference will be set to 60 because Red overwrites Blue.

- Normal outbound route maps take precedence over peer graceful shutdown maps.
- Peer graceful shutdown maps take precedence over global graceful shutdown maps.

Guidelines and Limitations

The following are limitations and guidelines for BGP global shutdown:

- Graceful shutdown feature can only help avoid traffic loss when alternative routes exist in the network for the affected routers. If the router has no alternate routes, routes carrying the `GRACEFUL_SHUTDOWN` community are the only ones available, and therefore, are used in the best-path calculation. This situation defeats the purpose of the feature.
- Configuring a BGP send community is required to send the `GRACEFUL_SHUTDOWN` community.
- For route maps:
 - When global route maps and neighbor route maps are configured, the per-neighbor route maps take precedence.
 - Outbound route maps take precedence over any global route maps configured for graceful shutdown.
 - Outbound route maps take precedence over any peer route maps configured for graceful shutdown.
- To add the graceful shutdown functionality to legacy (existing) inbound route maps, follow this order:
 1. Add the graceful shutdown match clause to the top of the route map by setting a low sequence number for the clause (for example, sequence number 0).
 2. Add a continue statement after the graceful shutdown clause. If you omit the continue statement, route-map processing stops when it matches the graceful shutdown clause, any other clauses with higher sequence numbers (for example, 1 and higher) are not processed.

Graceful Shutdown Task Overview

To use the graceful shutdown feature, you typically enable graceful-shutdown aware on all Cisco Nexus switches and leave the feature enabled. When a BGP router must be taken offline, you configure graceful-shutdown activate on it.

The following details document the best practice for using the graceful shutdown feature.

To bring the router or link down:

1. Configure the Graceful Shutdown feature.
2. Watch the neighbor for the best path.
3. When the best path is recalculated, issue the **shutdown** command to disable BGP.
4. Perform the work that required you to shut down the router or link.

To bring the router or link back online:

1. When you finish the work that required the shutdown, reenables BGP (**no shutdown**).
2. Disable the graceful shutdown feature (**no graceful-shutdown activate** in config router mode).

Configuring Graceful Shutdown on a Link

This task enables you to configure graceful shutdown on a specific link between two BGP routers.

Before you begin

If you have not already enabled BGP, enable it now (**feature bgp**).

SUMMARY STEPS

1. **config terminal**
2. **router bgp** *autonomous-system-number*
3. **neighbor** { *ipv4-address|ipv6-address* } **remote-as** *as-number*
4. **graceful-shutdown activate** [*route-map map-name*]

DETAILED STEPS

	Command or Action	Purpose
Step 1	config terminal Example: <pre>switch-1# configure terminal switch-1(config)#</pre>	Enters global configuration mode.
Step 2	router bgp <i>autonomous-system-number</i> Example: <pre>switch-1(config)# router bgp 110 switch-1(config-router)#</pre>	Enters router configuration mode to create or configure a BGP routing process.

	Command or Action	Purpose
Step 3	neighbor { ipv4-address ipv6-address } remote-as as-number Example: <pre>switch-1(config-router)# neighbor 10.0.0.3 remote-as 200 switch-1(config-router-neighbor)#</pre>	Configures the autonomous system (AS) to which the neighbor belongs.
Step 4	graceful-shutdown activate [route-map map-name] Example: <pre>switch-1(config-router-neighbor)# graceful-shutdown activate route-map gshutPeer switch-1(config-router-neighbor)#</pre>	<p>Configures graceful shutdown on the link to the neighbor. Also, advertises the routes with the well-known GRACEFUL_SHUTDOWN community and applies the route map to the outbound route updates.</p> <p>The routes are advertised with the graceful-shutdown community by default. In this example, routes are advertised to the neighbor with the Graceful-shutdown community with a route-map named gshutPeer.</p> <p>The devices receiving the gshut community look at the communities of the route and optionally use the communities to apply routing policy.</p>

Filtering BGP Routes and Setting Local Preference Based On GRACEFUL_SHUTDOWN Communities

Switches that are not yet running 9.3(1) do not have an inbound route map that matches against the GRACEFUL_SHUTDOWN community name. Therefore, they have no way of identifying and deprefering the correct routes.

For switches running a release of NX-OS that is earlier than 9.3(1), you must configure an inbound route map that matches on the community value for graceful shutdown (65535:0) and deprefers routes.

If your switch is running 9.3(1) or later, you do not need to configure an inbound route map.

SUMMARY STEPS

1. **configure terminal**
2. **ip community list standard community-list-name seq sequence-number { permit | deny } value**
3. **route map map-tag {deny | permit} sequence-number**
4. **match community community-list-name**
5. **set local-preference local-pref-value**
6. **exit**
7. **router bgp community-list-name**
8. **neighbor { ipv4-address|ipv6-address }**
9. **address-family { address-family sub family }**
10. **send community**
11. **route map map-tag in**

DETAILED STEPS

	Command or Action	Purpose
Step 1	configure terminal Example: <pre>switch-1# configure terminal switch-1(config)#</pre>	Enters global configuration mode.
Step 2	ip community list standard <i>community-list-name</i> seq <i>sequence-number</i> { permit deny } <i>value</i> Example: <pre>switch-1(config)# ip community-list standard GSHUT seq 10 permit 65535:0 switch-1(config)#</pre>	Configures a community list and permits or denies routes that have the well-known graceful shutdown community value.
Step 3	route map <i>map-tag</i> {deny permit} <i>sequence-number</i> Example: <pre>switch-1(config)# route-map RM_GSHUT permit 10 switch-1(config-route-map)#</pre>	Configures a route map as sequence 10 and permits routes that have the GRACEFUL_SHUTDOWN community.
Step 4	match community <i>community-list-name</i> Example: <pre>switch-1(config-route-map)# match community GSHUT switch-1(config-route-map)#</pre>	Configures that routes that match the IP community list GSHUT are processed by Route Policy Manager (RPM).
Step 5	set local-preference <i>local-pref-value</i> Example: <pre>switch-1(config-route-map)# set local-preference 10 switch-1(config-route-map)#</pre>	Configures that the routes that match the IP community list GSHUT will be given a specified local preference.
Step 6	exit Example: <pre>switch-1(config-route-map)# exit switch-1(config)#</pre>	Leaves route map configuration and returns to global configuration mode.
Step 7	router bgp <i>community-list-name</i> Example: <pre>switch-1(config)# router bgp 100 switch-1(config-router)#</pre>	Enters router configuration mode and creates a BGP instance.
Step 8	neighbor { <i>ipv4-address</i> <i>ipv6-address</i> } Example: <pre>switch-1(config-router)# neighbor 10.0.0.3 switch-1(config-router-neighbor)#</pre>	Enters route BGP neighbor mode for a specified neighbor.
Step 9	address-family { <i>address-family</i> <i>sub family</i> } Example:	Puts the neighbor into address family (AF) configuration mode.

	Command or Action	Purpose
	<code>nxosv2 (config-router-neighbor) # address-family ipv4 unicast nxosv2 (config-router-neighbor-af) #</code>	
Step 10	send community Example: <code>nxosv2 (config-router-neighbor-af) # send-community nxosv2 (config-router-neighbor-af) #</code>	Enables BGP community exchange with the neighbor.
Step 11	route map <i>map-tag</i> in Example: <code>nxosv2 (config-router-neighbor-af) # route-map RM_GSHUT in nxosv2 (config-router-neighbor-af) #</code>	Applies the route map to incoming routes from the neighbor. In this example, the route map that is named RM_GSHUT permits routes with the GRACEFUL_SHUTDOWN community from the neighbor.

Configuring Graceful Shutdown for All BGP Neighbors

You can manually apply the GRACEFUL_SHUTDOWN well-known community to all the neighbors of a graceful shutdown initiator.

You can configure graceful shutdown at the global level for all BGP neighbors.

Before you begin

If you have not already enabled BGP, enable it now (**feature bgp**).

SUMMARY STEPS

1. **configure terminal**
2. **router bgp *autonomous-system-number***
3. **graceful-shutdown activate [route-map *map-name*]**

DETAILED STEPS

	Command or Action	Purpose
Step 1	configure terminal Example: <code>switch-1# configure terminal switch-1 (config) #</code>	Enters global configuration mode.
Step 2	router bgp <i>autonomous-system-number</i> Example: <code>switch-1 (config) # router bgp 110 switch-1 (config-router) #</code>	Enters router configuration mode to create or configure a BGP routing process.
Step 3	graceful-shutdown activate [route-map <i>map-name</i>] Example:	Configures graceful shutdown route map for the links to all neighbors. Also, advertises all routes with the well-known

	Command or Action	Purpose
	<pre>switch-1(config-router-neighbor)# graceful-shutdown activate route-map gshutPeer switch-1(config-router-neighbor)#</pre>	<p>GRACEFUL_SHUTDOWN community and applies the route map to the outbound route updates.</p> <p>The routes are advertised with the GRACEFUL_SHUTDOWN community by default. In this example, routes are advertised to all neighbors with the community with a route-map named gshutPeer. The route map should contain only set clauses.</p> <p>The devices receiving the GRACEFUL_SHUTDOWN community look at the communities of the route and optionally use the communities to apply routing policy.</p>

Controlling the Preference for All Routes with the GRACEFUL_SHUTDOWN Community

Cisco NX-OS enables lowering the preference of incoming routes that have the GRACEFUL_SHUTDOWN community. When **graceful shutdown aware** is enabled, BGP considers routes carrying the community as the lowest preference during best path calculation. By default, lowering the preference is enabled, but you can selectively disable this option.

Whenever you enable or disable this option, you trigger a BGP best-path calculation. This option gives you the flexibility to control the behavior of the BGP best-path calculation for the graceful shutdown well-known community.

Before you begin

If you have not enabled BGP, enable it now (**feature bgp**).

SUMMARY STEPS

1. **configure terminal**
2. **router bgp** *autonomous-system*
3. (Optional) **no graceful-shutdown aware**

DETAILED STEPS

	Command or Action	Purpose
Step 1	<p>configure terminal</p> <p>Example:</p> <pre>switch-1(config)# config terminal switch-1(config)#</pre>	Enters global configuration mode.
Step 2	<p>router bgp <i>autonomous-system</i></p> <p>Example:</p> <pre>switch-1(config)# router bgp 100 switch-1(config-router)#</pre>	Enters router configuration mode and configures a BGP routing process.

	Command or Action	Purpose
Step 3	(Optional) no graceful-shutdown aware Example: <pre>switch-1(config-router)# no graceful-shutdown aware switch-1(config-router)#</pre>	For this BGP router, do not give lower preference for all routes that have the GRACEFUL_SHUTDOWN community. The default action is to deprefer routes when the graceful shutdown aware feature is disabled, so using the no form of the command is optional for not deprefering graceful shutdown routes.

Preventing Sending the GRACEFUL_SHUTDOWN Community to a Peer

If you no longer need the GRACEFUL_SHUTDOWN community that is appended as a route attribute to outbound route updates, you can remove the community, which no longer sends it to a specified neighbor. One use case would be when a router is at an autonomous system boundary, and you do not want the graceful shutdown functionality to propagate outside of an autonomous system boundary.

To prevent sending the GRACEFUL_SHUTDOWN to a peer, you can disable the send community option or strip the community from the outbound route map.

Choose either of the following methods:

- Disable the send-community in the running config.

Example:

```
nxosv2(config-router-neighbor-af)# no send-community standard
nxosv2(config-router-neighbor-af)#
```

If you use this option, the GRACEFUL_SHUTDOWN community is still received by the switch, but it is not sent to the downstream neighbor through the outbound route map. All standard communities are not sent either.

- Delete the GRACEFUL_SHUTDOWN community through an outbound route map by following these steps:
 1. Create an IP community list matches the GRACEFUL_SHUTDOWN community.
 2. Create an outbound route map to match against the GRACEFUL_SHUTDOWN community.
 3. Use a **set community-list delete** clause to strip GRACEFUL_SHUTDOWN community.

If you use this option, the community list matches and permits the GRACEFUL_SHUTDOWN community, then the outbound route map matches against the community and then deletes it from the outbound route map. All other communities pass through the outbound route map without issue.

Displaying Graceful Shutdown Information

Information about the graceful shutdown feature is available through the following **show** commands.

Command	Action
show ip bgp community-list graceful-shutdown	Shows all entries in the BGP routing table that have the GRACEFUL_SHUTDOWN community.
show running-config bgp	Shows the running BGP configuration.

Command	Action
show running-config bgp all	Shows all information for the running BGP configuration including information about the graceful shutdown feature.
show bgp <i>address-family</i> neighbors <i>neighbor-address</i>	When the feature is configured for the peer, shows the following: <ul style="list-style-type: none"> • The state of the graceful-shutdown-activate feature for the specified neighbor • The name of any graceful shutdown route map configured for the specified neighbor
show bgp process	Shows different information depending on the context. <p>When the graceful-shutdown-activate option is configured in peer context, shows the enabled or disabled state for the feature through <code>graceful-shutdown-active</code>.</p> <p>When the graceful-shutdown-activate option is configured in global context and has a graceful-shutdown route map, shows the enabled state of the feature through the following:</p> <ul style="list-style-type: none"> • <code>graceful-shutdown-active</code> • <code>graceful-shutdown-aware</code> • <code>graceful-shutdown route-map</code>
show ip bgp <i>address</i>	For the specified address, shows the BGP routing table information, including the following: <ul style="list-style-type: none"> • The state of the specified address as the best path • Whether the specified address is part of the GRACEFUL_SHUTDOWN community

Graceful Shutdown Configuration Examples

These examples show some configurations for using the graceful shutdown feature.

Configuring Graceful Shutdown for a BGP Link

The following example shows how to configure graceful shutdown while setting a local preference and a community:

- Configuring graceful shutdown activate for the link to the specified neighbor
- Adding the GRACEFUL_SHUTDOWN community to the routes
- Setting a route map named `gshutPeer` with only set clauses for outbound routes with the community.

```

router bgp 100
  neighbor 20.0.0.3 remote-as 200
  graceful-shutdown activate route-map gshutPeer
  address-family ipv4 unicast
    send-community

route-map gshutPeer permit 10
  set local-preference 0
  set community 200:30

```

Configuring Graceful Shutdown for All-Neighbor BGP Links

The following example shows:

- Configuring graceful shutdown activate for all the links connecting the local router and all its neighbors.
- Adding the GRACEFUL_SHUTDOWN community to the routes.
- Setting a route map that is named gshutAall with only set clauses for all outbound routes.

```

router bgp 200
  graceful-shutdown activate route-map gshutAll

route-map gshutAll permit 10
  set as-path prepend 10 100 110
  set community 100:80

route-map Red permit 10
  set local-pref 20

router bgp 100
  graceful-shutdown activate route-map gshutAll
  router-id 2.2.2.2
  address-family ipv4 unicast
    network 2.2.2.2/32
  neighbor 1.1.1.1 remote-as 100
  update-source loopback0
  address-family ipv4 unicast
    send-community
  neighbor 20.0.0.3 remote-as 200
  address-family ipv4 unicast
    send-community
  route-map Red out

```

In this example, the `gshutAll` route-map takes effect for neighbor 1.1.1.1, but not neighbor 20.0.0.3, because the outbound route-map `Red` configured under neighbor 20.0.0.3 takes precedence instead.

Configuring Graceful Shutdown Under a Peer-Template

This example configures the graceful shutdown feature under a peer-session template, which is inherited by a neighbor.

```

router bgp 200
  template peer-session p1
    graceful-shutdown activate route-map gshut_out
  neighbor 1.1.1.1 remote-as 100
  inherit peer-session p1
  address-family ipv4 unicast
    send-community

```

Filtering BGP Routes and Setting Local Preference Based on GRACEFUL_SHUTDOWN Community Using and Inbound Route Map

This example shows how to use a community list to filter the incoming routes that have the GRACEFUL_SHUTDOWN community. This configuration is useful for legacy switches that are not running Cisco NX-OS 9.3(1) as a minimum version.

The following example shows:

- An IP Community List that permits routes that have the GRACEFUL_SHUTDOWN community.
- A route map that is named RM_GSHUT that permits routes based on a standard community list named GSHUT.
- The route map also sets the preference for the routes it processes to 0 so that those routes are given lower preference for best path calculation when the router goes offline. The route map is applied to incoming IPv4 routes from the neighbor (20.0.0.2).

```
ip community-list standard GSHUT permit 65535:0

route-map RM_GSHUT permit 10
  match community GSHUT
  set local-preference 0

router bgp 200
  neighbor 20.0.0.2 remote-as 100
  address-family ipv4 unicast
    send-community
    route-map RM_GSHUT in
```

Configuring a Graceful Restart

You can configure a graceful restart and enable the graceful restart helper feature for BGP.



Note Cisco NX-OS Release 10.1(1) supports a higher number of BFD sessions. If BGP sessions are associated with BFD, the BGP **restart-time** may need to be increased to maintain peer connection during ISSU.



Note From the perspective of BGP Graceful Restart, if there are idle peers during a node restart, they can potentially cause traffic loss during an ISSU because they may delay the establishment of the first best-path. It is recommended to either bring all these idle neighbors up, or configure 'shutdown' under each of them, or remove them entirely from the configuration.

Before you begin

You must enable BGP (see the "Enabling BGP" section).

Create the VRFs.

SUMMARY STEPS

1. **configure terminal**

2. **router bgp** *as-number*
3. (Optional) **timers prefix-peer-timeout** *timeout*
4. **graceful-restart**
5. **graceful-restart** {**restart-time** *time*|**stalepath-time** *time*}
6. **graceful-restart-helper**
7. (Optional) **show running-config bgp**
8. (Optional) **copy running-config startup-config**

DETAILED STEPS

	Command or Action	Purpose
Step 1	configure terminal Example: <pre>switch# configure terminal switch(config)#</pre>	Enters configuration mode.
Step 2	router bgp <i>as-number</i> Example: <pre>switch(config)# router bgp 65535 switch(config-router)#</pre>	Creates a new BGP process with the configured autonomous system number.
Step 3	(Optional) timers prefix-peer-timeout <i>timeout</i> Example: <pre>switch(config-router)# timers prefix-peer-timeout 20</pre>	Configures the timeout value (in seconds) for BGP prefix peers. The default value is 90 seconds. Note This command is supported beginning with Cisco NX-OS Release 9.3(3).
Step 4	graceful-restart Example: <pre>switch(config-router)# graceful-restart</pre>	Enables a graceful restart and the graceful restart helper functionality. This command is enabled by default. This command triggers an automatic notification and session reset for the BGP neighbor sessions.
Step 5	graceful-restart { restart-time <i>time</i> stalepath-time <i>time</i> } Example: <pre>switch(config-router)# graceful-restart restart-time 300</pre>	Configures the graceful restart timers. The optional parameters are as follows: <ul style="list-style-type: none"> • restart-time—Maximum time for a restart sent to the BGP peer. The range is from 1 to 3600 seconds. The default is 120. Note Cisco NX-OS Release 10.1(1) supports a higher number of BFD sessions. If BGP sessions are associated with BFD, the BGP restart-time may need to be increased to maintain peer connection during ISSU. <ul style="list-style-type: none"> • stalepath-time—Maximum time that BGP keeps the stale routes from the restarting BGP peer. The range is from 1 to 3600 seconds. The default is 300.

	Command or Action	Purpose
		In NX-OS software release 10.2(1), a manual reset of a BGP session is needed for the BGP session to advertise Graceful Restart capabilities. For NX-OS software releases 10.2(2) and later, BGP sessions dynamically advertise Graceful Restart capabilities without needing to restart the BGP sessions when this command is enabled.
Step 6	graceful-restart-helper Example: <pre>switch(config-router)# graceful-restart restart-time 300</pre>	With BGP GR disabled, the N9K itself will not necessarily preserve its own forwarding state during certain GR-capable events like SSO, BGP process restart, etc. occurring locally on the N9K. However, as a GR helper, it will support a peer that has advertised its GR capability and is restarting. This means, when the N9K detects the peering has gone down (other than a holdtimer expiration or receipt of a Notification message), the N9K will stale the routes pointing to the peer and will wait for the peer's EOR (or stalepath timeout). When the peer restarts and re-establishes its peering with the N9K, it will re-advertise all its own routes and the N9K will refresh them in its BGP and routing tables. On receipt of the EOR from the peer or the stalepath timeout (whichever occurs first), the N9K will flush any remaining stale routes from that peer. In the absence of helper mode, the N9K would instantly clear out the routes learnt from the remote peer that was restarting which could lead to traffic loss.
Step 7	(Optional) show running-config bgp Example: <pre>switch(config-router)# show running-config bgp</pre>	Displays the BGP configuration.
Step 8	(Optional) copy running-config startup-config Example: <pre>switch(config-router)# copy running-config startup-config</pre>	Saves this configuration change.

Example

This example shows how to enable a graceful restart:

```
switch# configure terminal
switch(config)# router bgp 65536
switch(config-router)# graceful-restart
switch(config-router)# graceful-restart restart-time 300
switch(config-router)# copy running-config startup-config
```

Configuring Virtualization

You can configure one BGP process, create multiple VRFs, and use the same BGP process in each VRF.

Before you begin

You must enable BGP.

SUMMARY STEPS

1. **configure terminal**
2. **vrf context** *vrf-name*
3. **exit**
4. **router bgp** *as-number*
5. **vrf** *vrf-name*
6. **neighbor** *ip-address* **remote-as** *as-number*
7. (Optional) **copy running-config startup-config**

DETAILED STEPS

	Command or Action	Purpose
Step 1	configure terminal Example: <pre>switch# configure terminal switch(config)#</pre>	Enters global configuration mode.
Step 2	vrf context <i>vrf-name</i> Example: <pre>switch(config)# vrf context RemoteOfficeVRF switch(config-vrf)#</pre>	Creates a new VRF and enters VRF configuration mode.
Step 3	exit Example: <pre>switch(config-vrf)# exit switch(config)#</pre>	Exits VRF configuration mode.
Step 4	router bgp <i>as-number</i> Example: <pre>switch(config)# router bgp 65535 switch(config-router)#</pre>	Creates a new BGP process with the configured autonomous system number.
Step 5	vrf <i>vrf-name</i> Example: <pre>switch(config-router)# vrf RemoteOfficeVRF switch(config-router-vrf)#</pre>	Enters the router VRF configuration mode and associates this BGP instance with a VRF.

	Command or Action	Purpose
Step 6	neighbor <i>ip-address</i> remote-as <i>as-number</i> Example: <pre>switch(config-router-vrf)# neighbor 209.165.201.1 remote-as 65535 switch(config-router--vrf-neighbor)#</pre>	Configures the IP address and AS number for a remote BGP peer.
Step 7	(Optional) copy running-config startup-config Example: <pre>switch(config-router-vrf-neighbor)# copy running-config startup-config</pre>	Saves this configuration change.

Example

This example shows how to create a VRF and configure the router ID in the VRF:

```
switch# configure terminal
switch(config)# vrf context NewVRF
switch(config-vrf)# exit
switch(config)# router bgp 65536
switch(config-router)# vrf NewVRF
switch(config-router-vrf)# neighbor 209.165.201.1 remote-as 65536
switch(config-router-vrf-neighbor)# copy running-config startup-config
```

Verifying the Advanced BGP Configuration

To display the BGP configuration, perform one of the following tasks:

Command	Purpose
show bgp all [summary] [vrf <i>vrf-name</i>]	Displays the BGP information for all address families.
show bgp convergence [vrf <i>vrf-name</i>]	Displays the BGP information for all address families.
show bgp { ipv4 ipv6 } { unicast multicast } [<i>ip-address</i> <i>ipv6-prefix</i>] community { regexp <i>expression</i> [community] [no-advertise] [no-export] [no-export-subconfed]} [vrf <i>vrf-name</i>]	Displays the BGP routes that match a BGP community.
show bgp [vrf <i>vrf-name</i>] { ipv4 ipv6 } { unicast multicast } [<i>ip-address</i> <i>ipv6-prefix</i>] community-list <i>list-name</i> [vrf <i>vrf-name</i>]	Displays the BGP routes that match a BGP community list.
show bgp { ipv4 ipv6 } { unicast multicast } [<i>ip-address</i> <i>ipv6-prefix</i>] extcommunity { regexp <i>expression</i> generic [non-transitive transitive] <i>aa4:nn</i> [exact-match]} [vrf <i>vrf-name</i>]	Displays the BGP routes that match a BGP extended community.
show bgp { ipv4 ipv6 } { unicast multicast } [<i>ip-address</i> <i>ipv6-prefix</i>] extcommunity-list <i>list-name</i> [exact-match]} [vrf <i>vrf-name</i>]	Displays the BGP routes that match a BGP extended community list.

Command	Purpose
show bgp { ipv4 ipv6 } { unicast multicast } [<i>ip-address</i> <i>ipv6-prefix</i>] extcommunity-list <i>list-name</i> [exact-match] [vrf <i>vrf-name</i>]	Displays the information for BGP route dampening. Use the clear bgp dampening command to clear the route flap dampening information.
show bgp { ipv4 ipv6 } { unicast multicast } [<i>ip-address</i> <i>ipv6-prefix</i>] { dampening dampened-paths [regex <i>expression</i>]} [vrf <i>vrf-name</i>]	Displays the BGP route history paths.
show bgp { ipv4 ipv6 vpn4 vpn6 } { unicast multicast } [<i>ip-address</i> <i>ipv6-prefix</i>] filter-list <i>list-name</i> [vrf <i>vrf-name</i>]	Displays the information for the BGP filter list.
show bgp { ipv4 ipv6 vpn4 vpn6 } { unicast multicast } [<i>ip-address</i> <i>ipv6-prefix</i>] neighbors [<i>ip-address</i> <i>ipv6-prefix</i>] [vrf <i>vrf-name</i>]	Displays the information for BGP peers. Use the clear bgp neighbors command to clear these neighbors.
show bgp { ipv4 ipv6 } { unicast multicast } [<i>ip-address</i> <i>ipv6-prefix</i>] { nexthop nexthop-database } [vrf <i>vrf-name</i>]	Displays the information for the BGP route next hop.
show bgp paths	Displays the BGP path information.
show bgp { ipv4 ipv6 } { unicast multicast } [<i>ip-address</i> <i>ipv6-prefix</i>] policy <i>name</i> [vrf <i>vrf-name</i>]	Displays the BGP policy information. Use the clear bgp policy command to clear the policy information.
show bgp { ipv4 ipv6 } { unicast multicast } [<i>ip-address</i> <i>ipv6-prefix</i>] prefix-list <i>list-name</i> [vrf <i>vrf-name</i>]	Displays the BGP routes that match the prefix list.
show bgp { ipv4 ipv6 } { unicast multicast } [<i>ip-address</i> <i>ipv6-prefix</i>] received-paths [vrf <i>vrf-name</i>]	Displays the BGP paths stored for soft reconfiguration.
show bgp { ipv4 ipv6 } { unicast multicast } [<i>ip-address</i> <i>ipv6-prefix</i>] regex <i>expression</i> [vrf <i>vrf-name</i>]	Displays the BGP routes that match the AS_path regular expression.
show bgp { ipv4 ipv6 } { unicast multicast } [<i>ip-address</i> <i>ipv6-prefix</i>] route-map <i>map-name</i> [vrf <i>vrf-name</i>]	Displays the BGP routes that match the route map.
show bgp peer-policy <i>name</i> [vrf <i>vrf-name</i>]	Displays the information about BGP peer policies.
show bgp peer-session <i>name</i> [vrf <i>vrf-name</i>]	Displays the information about BGP peer sessions.
show bgp peer-template <i>name</i> [vrf <i>vrf-name</i>]	Displays the information about BGP peer templates. Use the clear bgp peer-template command to clear all neighbors in a peer template.

Command	Purpose
<code>show bgp process</code>	Displays the BGP process information.
<code>show bgp {ipv4 ipv6} unicast neighbors interface</code>	Displays information about BGP peers for the specified interface.
<code>show ip bgp neighbors interface-name</code>	Displays the interface used as a BGP peer.
<code>show ip route ip-address detail vrf all i bw</code>	Displays the link bandwidth EXTCOMM fields. <code>bw:xx</code> (such as <code>bw:40</code>) in the output indicates that BGP peers are sending BGP extended attributes with the bandwidth (for weighted ECMP).
<code>show {ipv4 ipv6} bgp options</code>	Displays the BGP status and configuration information.
<code>show {ipv4 ipv6} mbgp options</code>	Displays the BGP status and configuration information.
<code>show ipv6 routers interface interface</code>	Displays the link-local address of remote IPv6 routers, which is learned through IPv6 ICMP router advertisement.
<code>show running-configuration bgp</code>	Displays the current running BGP configuration.

Monitoring BGP Statistics

To display BGP statistics, use the following commands:

Command	Purpose
<code>show bgp {ipv4 ipv6} {unicast multicast} [ip-address ipv6-prefix] flap-statistics [vrf vrf-name]</code>	Displays the BGP route flap statistics. Use the clear bgp flap-statistics command to clear these statistics.
<code>show bgp {ipv4 ipv6} unicast injected-routes</code>	Displays injected routes in the routing table.
<code>show bgp sessions [vrf vrf-name]</code>	Displays the BGP sessions for all peers. Use the clear bgp sessions command to clear these statistics.
<code>show bgp statistics</code>	Displays the BGP statistics.

Configuration Examples

This example shows how to enable BFD for individual BGP neighbors:

```
router bgp 400
  router-id 2.2.2.2
  neighbor 172.16.2.3
    bfd
    remote-as 400
    update-source Vlan1002
    address-family ipv4 unicast
```

This example shows how to enable BFD for BGP prefix peers:

```
router bgp 400
  router-id 1.1.1.1
  neighbor 172.16.2.0/24
    bfd
    remote-as 400
    update-source Vlan1002
    address-family ipv4 unicast
```

This example shows how to configure MD5 authentication for prefix-based neighbors:

```
template peer BasePeer-V6
  description BasePeer-V6
  password 3 f4200cfc725bbd28
  transport connection-mode passive
  address-family ipv6 unicast
template peer BasePeer-V4
  bfd
  description BasePeer-V4
  password 3 f4200cfc725bbd28
  address-family ipv4 unicast
--
neighbor fc00::10:3:11:0/127 remote-as 65006
  inherit peer BasePeer-V6
neighbor 10.3.11.0/31 remote-as 65006
  inherit peer BasePeer-V4
```

This example shows how to enable neighbor status change messages globally and suppress them for a specific neighbor:

```
router bgp 65100
  log-neighbor-changes
  neighbor 209.165.201.1 remote-as 65535
    description test
    address-family ipv4 unicast
    soft-reconfiguration inbound
    disable log-neighbor-changes
```

Related Topics

The following topics can give more information on BGP:

- [Configuring Basic BGP, on page 281](#)
- [Configuring Route Policy Manager, on page 515](#)

Additional References

For additional information related to implementing BGP, see the following sections:

MIBs

MIBs	MIBs Link
MIBs related to BGP	To locate and download supported MIBs, go to the following URL: ftp://ftp.cisco.com/pub/mibs/supportlists/nexus9000/Nexus9000MIBSupportList.html



CHAPTER 12

Configuring RIP

This chapter contains the following sections:

- [About RIP, on page 429](#)
- [Prerequisites for RIP, on page 431](#)
- [Guidelines and Limitations for RIP, on page 432](#)
- [Default Settings for RIP Parameters, on page 432](#)
- [Configuring RIP, on page 432](#)
- [Verifying the RIP Configuration, on page 445](#)
- [Displaying RIP Statistics, on page 446](#)
- [Configuration Examples for RIP, on page 446](#)
- [Related Topics, on page 447](#)

About RIP

RIP Overview

RIP uses User Datagram Protocol (UDP) data packets to exchange routing information in small internetworks. RIPv2 supports IPv4. RIPv2 uses an optional authentication feature supported by the RIPv2 protocol (see the [RIPv2 Authentication](#) section).

RIP uses the following two message types:

- **Request**—Sent to the multicast address 224.0.0.9 to request route updates from other RIP-enabled routers.
- **Response**—Sent every 30 seconds by default (see the [Verifying the RIP Configuration](#) section). The router also sends response messages after it receives a request message. The response message contains the entire RIP route table. RIP sends multiple response packets for a request if the RIP routing table cannot fit in one response packet.

RIP uses a hop count for the routing metric. The hop count is the number of routers that a packet can traverse before reaching its destination. A directly connected network has a metric of 1. An unreachable network has a metric of 16. This small range of metrics makes RIP an unsuitable routing protocol for large networks.

RIPv2 Authentication

You can configure authentication on RIP messages to prevent unauthorized or invalid routing updates in your network. Cisco NX-OS supports a simple password or an MD5 authentication digest.

You can configure the RIP authentication per interface by using keychain management for the authentication keys. Keychain management allows you to control changes to the authentication keys used by an MD5 authentication digest or simple text password authentication. See the [Cisco Nexus 9000 Series NX-OS Security Configuration Guide](#) for more details about creating keychains.

To use an MD5 authentication digest, you configure a password that is shared at the local router and all remote RIP neighbors. Cisco NX-OS creates an MD5 one-way message digest based on the message itself and the encrypted password and sends this digest with the RIP message (Request or Response). The receiving RIP neighbor validates the digest by using the same encrypted password. If the message has not changed, the calculation is identical, and the RIP message is considered valid.

An MD5 authentication digest also includes a sequence number with each RIP message to ensure that no message is replayed in the network.

Split Horizon

You can use split horizon to ensure that RIP never advertises a route out of the interface where it was learned.

Split horizon is a method that controls the sending of RIP update and query packets. When you enable split horizon on an interface, Cisco NX-OS does not send update packets for destinations that were learned from this interface. Controlling update packets in this manner reduces the possibility of routing loops.

You can use split horizon with poison reverse to configure an interface to advertise routes learned by RIP as unreachable over the interface that learned the routes.

The following figure shows a sample RIP network with split horizon and poison reverse enabled.

Figure 36: RIP with Split Horizon Poison Reverse

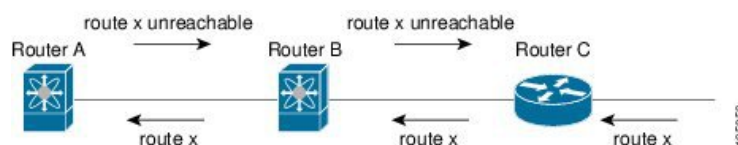

Router C learns about route X and advertises that route to Router B. Router B in turn advertises route X to Router A but sends a route X unreachable update back to Router C.

By default, split horizon is enabled on all interfaces.

Route Filtering

You can configure a route policy on a RIP-enabled interface to filter the RIP updates. Cisco NX-OS updates the route table with only those routes that the route policy allows.

Route Summarization

You can configure multiple summary aggregate addresses for a specified interface. Route summarization simplifies route tables by replacing a number of more-specific addresses with an address that represents all

the specific addresses. For example, you can replace 10.1.1.0/24, 10.1.2.0/24, and 10.1.3.0/24 with one summary address, 10.1.0.0/16.

If more specific routes are in the routing table, RIP advertises the summary address from the interface with a metric equal to the maximum metric of the more specific routes.



Note Cisco NX-OS does not support automatic route summarization.

Route Redistribution

You can use RIP to redistribute static routes or routes from other protocols. You must configure a route map with the redistribution to control which routes are passed into RIP. A route policy allows you to filter routes based on attributes such as the destination, origination protocol, route type, route tag, and so on. For more information, see [Configuring Route Policy Manager, on page 515](#).

Whenever you redistribute routes into a RIP routing domain, Cisco NX-OS does not, by default, redistribute the default route into the RIP routing domain. You can generate a default route into RIP, which can be controlled by a route policy.

You also configure the default metric that is used for all imported routes into RIP.

Load Balancing

You can use load balancing to allow a router to distribute traffic over all the router network ports that are the same distance from the destination address. Load balancing increases the usage of network segments and increases effective network bandwidth.

Cisco NX-OS supports the Equal Cost Multiple Paths (ECMP) feature with up to 16 equal-cost paths in the RIP route table and the unicast RIB. You can configure RIP to load balance traffic across some or all of those paths.

High Availability for RIP

Cisco NX-OS supports stateless restarts for RIP. After a reboot or supervisor switchover, Cisco NX-OS applies the running configuration, and RIP immediately sends request packets to repopulate its routing table.

Virtualization Support for RIP

Cisco NX-OS supports multiple instances of the RIP protocol that run on the same system. RIP supports virtual routing and forwarding (VRF) instances.

Prerequisites for RIP

RIP has the following prerequisites:

- You must enable RIP (see the [Enabling RIP](#) section).

Guidelines and Limitations for RIP

RIP has the following configuration guidelines and limitations:

- Names in the prefix-list are case-insensitive. We recommend using unique names. Do not use the same name by modifying upper-case and lower-case characters. For example, CTCPrimaryNetworks and CtcPrimaryNetworks are not two different entries.
- Cisco NX-OS does not support RIPv1. If Cisco NX-OS receives an RIPv1 packet, it logs a message and drops the packet.
- Cisco NX-OS does not establish adjacencies with RIPv1 routers.
- RIP is not supported in tunnel interfaces.



Note RIP only supports an 8-bit KeyID, that is less than or equal to 255. This is the keyID used while configuring authentication with RIP.

Default Settings for RIP Parameters

The table lists the default settings for RIP parameters.

Default RIP Parameters

Parameters	Default
Maximum paths for load balancing	16
RIP feature	Disabled
Split horizon	Enabled

Configuring RIP



Note If you are familiar with the Cisco IOS CLI, be aware that the Cisco NX-OS commands for this feature might differ from the Cisco IOS commands that you would use.

Enabling RIP

You must enable RIP before you can configure RIP.

SUMMARY STEPS

1. **configure terminal**
2. **[no] feature rip**
3. (Optional) **show feature**
4. (Optional) **copy running-config startup-config**

DETAILED STEPS

	Command or Action	Purpose
Step 1	configure terminal Example: <pre>switch# configure terminal switch(config)#</pre>	Enters global configuration mode.
Step 2	[no] feature rip Example: <pre>switch(config)# feature rip</pre>	Enables the RIP feature.
Step 3	(Optional) show feature Example: <pre>switch(config)# show feature</pre>	Displays enabled and disabled features.
Step 4	(Optional) copy running-config startup-config Example: <pre>switch(config)# copy running-config startup-config</pre>	Saves this configuration change.

Creating a RIP Instance

You can create a RIP instance and configure the address family for that instance.

Before you begin

You must enable RIP (see the [Enabling RIP](#) section).

SUMMARY STEPS

1. **configure terminal**
2. **[no] router rip *instance-tag***
3. **address-family ipv4 unicast**
4. (Optional) **show ip rip [*instance instance-tag*] [*vrf vrf-name*]**
5. (Optional) **distance *value***
6. (Optional) **maximum-paths *number***
7. (Optional) **copy running-config startup-config**

DETAILED STEPS

	Command or Action	Purpose
Step 1	configure terminal Example: switch# configure terminal switch(config)#	Enters global configuration mode.
Step 2	[no] router rip <i>instance-tag</i> Example: switch(config)# router RIP Enterprise switch(config-router)#	Creates a new RIP instance with the configured <i>instance-tag</i> .
Step 3	address-family ipv4 unicast Example: switch(config-router)# address-family ipv4 unicast switch(config-router-af)#	Configures the address family for this RIP instance and enters address-family configuration mode.
Step 4	(Optional) show ip rip [instance <i>instance-tag</i>] [vrf <i>vrf-name</i>] Example: switch(config-router-af)# show ip rip	Displays a summary of RIP information for all RIP instances.
Step 5	(Optional) distance <i>value</i> Example: switch(config-router-af)# distance 30	Sets the administrative distance for RIP. The range is from 1 to 255. The default is 120. See the Administrative Distance section.
Step 6	(Optional) maximum-paths <i>number</i> Example: switch(config-router-af)# maximum-paths 6	Configures the maximum number of equal-cost paths that RIP maintains in the route table. The range is from 1 to 64. The default is 16.
Step 7	(Optional) copy running-config startup-config Example: switch(config-router-af)# copy running-config startup-config	Saves this configuration change.

Example

This example shows how to create a RIP instance for IPv4 and set the number of equal-cost paths for load balancing:

```
switch# configure terminal
switch(config)# router rip Enterprise
switch(config-router)# address-family ipv4 unicast
switch(config-router-af)# max-paths 10
switch(config-router-af)# copy running-config startup-config
```

Restarting a RIP Instance

You can restart a RIP instance and remove all associated neighbors for the instance.

To restart a RIP instance and remove all associated neighbors, use the following command in global configuration mode:

SUMMARY STEPS

1. **restart rip** *instance-tag*

DETAILED STEPS

	Command or Action	Purpose
Step 1	restart rip <i>instance-tag</i> Example: switch(config)# restart rip Enterprise	Restarts the RIP instance and removes all neighbors.

Configuring RIP on an Interface

Before you begin

You must enable RIP (see the [Enabling RIP](#) section).

SUMMARY STEPS

1. **configure terminal**
2. **interface** *interface-type slot/port*
3. **ip router rip** *instance-tag*
4. (Optional) **show ip rip** [*instance instance-tag*] **interface** [*interface-type slot/port*] [*vrf vrf-name*] [**detail**]
5. (Optional) **copy running-config startup-config**

DETAILED STEPS

	Command or Action	Purpose
Step 1	configure terminal Example: switch# configure terminal switch(config)#	Enters global configuration mode.
Step 2	interface <i>interface-type slot/port</i> Example: switch(config)# interface ethernet 1/2 switch(config-if)#	Enters interface configuration mode.
Step 3	ip router rip <i>instance-tag</i> Example:	Associates this interface with a RIP instance.

	Command or Action	Purpose
	<code>switch(config-if)# ip router rip Enterprise</code>	
Step 4	(Optional) show ip rip [<i>instance instance-tag</i>] interface [<i>interface-type slot/port</i>] [<i>vrf vrf-name</i>] [detail] Example: <code>switch(config-if)# show ip rip Enterprise tethernet 1/2</code>	Displays RIP information for an interface.
Step 5	(Optional) copy running-config startup-config Example: <code>switch(config-if)# copy running-config startup-config</code>	Saves this configuration change.

Example

This example shows how to add Ethernet 1/2 interface to a RIP instance:

```
switch# configure terminal
switch(config)# interface ethernet 1/2
switch(config-if)# ip router rip Enterprise
switch(config)# copy running-config startup-config
```

Configuring RIP Authentication

You can configure authentication for RIP packets on an interface.

Before you begin

You must enable RIP (see the [Enabling RIP](#) section).

Configure a keychain if necessary before enabling authentication. For details about implementing keychains, see the [Cisco Nexus 9000 Series NX-OS Security Configuration Guide](#).

SUMMARY STEPS

1. **configure terminal**
2. **interface** *interface-type slot/port*
3. **ip rip authentication mode** {*text* | *md5*}
4. **ip rip authentication key-chain** *key*
5. (Optional) **copy running-config startup-config**

DETAILED STEPS

	Command or Action	Purpose
Step 1	configure terminal Example:	Enters global configuration mode.

	Command or Action	Purpose
	switch# configure terminal switch(config)#	
Step 2	interface <i>interface-type slot/port</i> Example: switch(config)# interface ethernet 1/2 switch(config-if)#	Enters interface configuration mode.
Step 3	ip rip authentication mode {text md5} Example: switch(config-if)# ip rip authentication mode md5	Sets the authentication type for RIP on this interface as cleartext or MD5 authentication digest.
Step 4	ip rip authentication key-chain <i>key</i> Example: switch(config-if)# ip rip authentication key-chain RIPKey	Configures the authentication key used for RIP on this interface.
Step 5	(Optional) copy running-config startup-config Example: switch(config-if)# copy running-config startup-config	Saves this configuration change.

Example

This example shows how to create a keychain and configure MD5 authentication on a RIP interface:

```
switch# configure terminal
switch(config)# key chain RIPKey
switch(config-keychain)# key 2
switch(config-keychain-key)# accept-lifetime 00:00:00 Jan 01 2000 infinite
switch(config-keychain-key)# send-lifetime 00:00:00 Jan 01 2000 infinite
switch(config-keychain-key)# exit
switch(config-keychain)# exit
switch(config)# interface ethernet 1/2
switch(config-if)# ip rip authentication mode md5
switch(config-if)# ip rip authentication key-chain RIPKey
switch(config-if)# copy running-config startup-config
```

Configuring a Passive Interface

You can configure a RIP interface to receive routes but not send route updates by setting the interface to passive mode.

To configure a RIP interface in passive mode, use the following command in interface configuration mode:

SUMMARY STEPS

1. **ip rip passive-interface**

DETAILED STEPS

	Command or Action	Purpose
Step 1	ip rip passive-interface Example: <pre>switch(config-if)# ip rip passive-interface</pre>	Sets the interface to passive mode.

Configuring Split Horizon with Poison Reverse

You can configure an interface to advertise routes learned by RIP as unreachable over the interface that learned the routes by enabling poison reverse.

To configure split horizon with poison reverse on an interface, use the following command in interface configuration mode:

SUMMARY STEPS

1. **ip rip poison-reverse**

DETAILED STEPS

	Command or Action	Purpose
Step 1	ip rip poison-reverse Example: <pre>switch(config-if)# ip rip poison-reverse</pre>	Enables split horizon with poison reverse. Split horizon with poison reverse is disabled by default.

Configuring Route Summarization

You can create aggregate addresses that are represented in the routing table by a summary address. Cisco NX-OS advertises the summary address metric that is the smallest metric of all the more specific routes.

To configure a summary address on an interface, use the following command in interface configuration mode:

SUMMARY STEPS

1. **ip rip summary-address *ip-prefix/mask-len***

DETAILED STEPS

	Command or Action	Purpose
Step 1	ip rip summary-address <i>ip-prefix/mask-len</i> Example: <pre>switch(config-if)# ip rip summary-address 1.1.1.1/32</pre>	Configures a summary address for RIP for IPv4 addresses.

Configuring Route Redistribution

You can configure RIP to accept routing information from another routing protocol and redistribute that information through the RIP network. Redistributed routes can optionally be assigned a default route.

Before you begin

You must enable RIP (see the [Enabling RIP](#) section)

Configure a route map before configuring redistribution . See the [Configuring Route Maps](#) section for details on configuring route maps.

SUMMARY STEPS

1. **configure terminal**
2. **router rip** *instance-tag*
3. **address-family ipv4 unicast**
4. **redistribute** {*bgp as* | **direct** | {*eigrp* | *isis* | *ospf* | *ospfv3* | **rip**} *instance-tag* | **static**} **route-map** *map-name*
5. (Optional) **default-information originate** [*always*] [**route-map** *map-name*]
6. (Optional) **default-metric** *value*
7. (Optional) **show ip rip route** [*ip-prefix* [*longer-prefixes* | *shorter-prefixes*]] [*vrf vrf-name*] [*summary*]
8. (Optional) **copy running-config startup-config**

DETAILED STEPS

	Command or Action	Purpose
Step 1	configure terminal Example: switch# configure terminal switch(config)#	Enters global configuration mode.
Step 2	router rip <i>instance-tag</i> Example: switch(config)# router rip Enterprise switch(config-router)#	Creates a new RIP instance with the configured <i>instance-tag</i> .
Step 3	address-family ipv4 unicast Example: switch(config-router)# address-family ipv4 unicast switch(config-router-af)#	Enters address-family configuration mode.
Step 4	redistribute { <i>bgp as</i> direct { <i>eigrp</i> <i>isis</i> <i>ospf</i> <i>ospfv3</i> rip } <i>instance-tag</i> static } route-map <i>map-name</i> Example: switch(config-router-af)# redistribute eigrp 201 route-map RIPmap	Redistributes routes from other protocols into RIP.

	Command or Action	Purpose
Step 5	(Optional) default-information originate [always] [route-map map-name] Example: switch(config-router-af) # default-information originate always	Generates a default route into RIP, optionally controlled by a route map.
Step 6	(Optional) default-metric value Example: switch(config-router-af) # default-metric 2	Sets the default metric for all redistributed routes. The range is from 1 to 15. The default is 1.
Step 7	(Optional) show ip rip route [ip-prefix [longer-prefixes shorter-prefixes]] [vrf vrf-name] [summary] Example: switch(config-router-af) # show ip rip route	Shows the routes in RIP.
Step 8	(Optional) copy running-config startup-config Example: switch(config-router-af) # copy running-config startup-config	Saves this configuration change.

Example

This example shows how to redistribute EIGRP into RIP:

```
switch# configure terminal
switch(config)# router rip Enterprise
switch(config-router)# address-family ipv4 unicast
switch(config-router-af)# redistribute eigrp 201 route-map RIPmap
switch(config-router-af)# copy running-config startup-config
```

Configuring Cisco NX-OS RIP for Compatibility with Cisco IOS RIP

You can configure Cisco NX-OS RIP to behave like Cisco IOS RIP in the way that routes are advertised and processed.

Directly connected routes are treated with cost 1 in Cisco NX-OS RIP and with cost 0 in Cisco IOS RIP. When routes are advertised in Cisco NX-OS RIP, the receiving device adds a minimum cost of +1 to all received routes and installs the routes in its routing table. In Cisco IOS RIP, this cost increment is done on the sending router, and the receiving router installs the routes without any modification. This difference in behavior can cause issues when both Cisco NX-OS and Cisco IOS devices are working together. You can prevent these compatibility issues by configuring Cisco NX-OS RIP to advertise and process routes like Cisco IOS RIP.

Before you begin

You must enable RIP (see the [Enabling RIP](#) section).

SUMMARY STEPS

1. **configure terminal**
2. **router rip** *instance-tag*
3. **[no] metric direct 0**
4. (Optional) **show running-config rip**
5. (Optional) **copy running-config startup-config**

DETAILED STEPS

	Command or Action	Purpose
Step 1	configure terminal Example: <pre>switch# configure terminal switch(config)#</pre>	Enters global configuration mode.
Step 2	router rip <i>instance-tag</i> Example: <pre>switch(config)# router rip 100 switch(config-router)#</pre>	Creates a new RIP instance with the configured instance tag. You can enter 100, 201, or up to 20 alphanumeric characters for the instance tag.
Step 3	[no] metric direct 0 Example: <pre>switch(config-router)# metric direct 0</pre>	Configures all directly connected routes with cost 0 instead of the default of cost 1 in order to make Cisco NX-OS RIP compatible with Cisco IOS RIP in the way that routes are advertised and processed. Note This command must be configured on all Cisco NX-OS devices that are present in any RIP network that also contains Cisco IOS devices.
Step 4	(Optional) show running-config rip Example: <pre>switch(config-router)# show running-config rip</pre>	Displays the current running RIP configuration.
Step 5	(Optional) copy running-config startup-config Example: <pre>switch(config-router)# copy running-config startup-config</pre>	Saves this configuration change.

Example

This example shows how to disable Cisco NX-OS RIP compatibility with Cisco IOS RIP by returning all direct routes from cost 0 to cost 1:

```
switch# configure terminal
switch(config)# router rip 100
switch(config-router)# no metric direct 0
```

```
switch(config-router)# show running-config rip
switch(config-router)# copy running-config startup-config
```

Configuring Virtualization

You can configure multiple RIP instances, create multiple VRFs, and use the same or multiple RIP instances in each VRF. You assign a RIP interface to a VRF.



Note Configure all other parameters for an interface after you configure the VRF for an interface. Configuring a VRF for an interface deletes all the configurations for that interface.

Before you begin

You must enable RIP (see the [Enabling RIP](#) section).

SUMMARY STEPS

1. **configure terminal**
2. **vrf context** *vrf-name*
3. **exit**
4. **router rip** *instance-tag*
5. **vrf** *vrf-name*
6. (Optional) **address-family ipv4 unicast**
7. (Optional) **redistribute** {**bgp as** | **direct** | {**eigrp** | **isis** | **ospf** | **ospfv3** | **rip**} *instance-tag* | **static**}
route-map *map-name*
8. **interface ethernet** *slot/port*
9. **vrf member** *vrf-name*
10. **ip address** *ip-prefix/length*
11. **ip router rip** *instance-tag*
12. (Optional) **show ip rip** [**instance** *instance-tag*] **interface** [*interface-type slot/port*] [**vrf** *vrf-name*]
13. (Optional) **copy running-config startup-config**

DETAILED STEPS

	Command or Action	Purpose
Step 1	configure terminal Example: <pre>switch# configure terminal switch(config)#</pre>	Enters global configuration mode.
Step 2	vrf context <i>vrf-name</i> Example: <pre>switch(config)# vrf context RemoteOfficeVRF switch(config-vrf)#</pre>	Creates a new VRF and enters VRF configuration mode.

	Command or Action	Purpose
Step 3	exit Example: <pre>switch(config-vrf)# exit switch(config)#</pre>	Exits VRF configuration mode.
Step 4	router rip <i>instance-tag</i> Example: <pre>switch(config)# router rip Enterprise switch(config-router)#</pre>	Creates a new RIP instance with the configured instance tag.
Step 5	vrf <i>vrf-name</i> Example: <pre>switch(config-router)# vrf RemoteOfficeVRF switch(config-router-vrf)#</pre>	Creates a new VRF.
Step 6	(Optional) address-family ipv4 unicast Example: <pre>switch(config-router-vrf)# address-family ipv4 unicast switch(config-router-vrf-af)#</pre>	Configures the VRF address family for this RIP instance.
Step 7	(Optional) redistribute {<i>bgp as</i> <i>direct</i> {<i>eigrp</i> <i>isis</i> <i>ospf</i> <i>ospfv3</i> <i>rip</i>} <i>instance-tag</i> <i>static</i>} route-map <i>map-name</i> Example: <pre>switch(config-router-vrf-af)# redistribute eigrp 201 route-map RIPmap</pre>	Redistributes routes from other protocols into RIP. See Configuring Route Maps, on page 537 for more information about route maps.
Step 8	interface ethernet <i>slot/port</i> Example: <pre>switch(config-router-vrf-af)# interface ethernet 1/2 switch(config-if)#</pre>	Enters interface configuration mode.
Step 9	vrf member <i>vrf-name</i> Example: <pre>switch(config-if)# vrf member RemoteOfficeVRF</pre>	Adds this interface to a VRF.
Step 10	ip address <i>ip-prefix/length</i> Example: <pre>switch(config-if)# ip address 192.0.2.1/16</pre>	Configures an IP address for this interface. You must perform this step after you assign this interface to a VRF.
Step 11	ip router rip <i>instance-tag</i> Example: <pre>switch(config-if)# ip router rip Enterprise</pre>	Associates this interface with a RIP instance.

	Command or Action	Purpose
Step 12	(Optional) show ip rip [instance <i>instance-tag</i>] interface [<i>interface-type slot/port</i>] [vrf <i>vrf-name</i>] Example: switch(config-if)# show ip rip Enterprise ethernet 1/2	Displays RIP information for an interface in a VRF.
Step 13	(Optional) copy running-config startup-config Example: switch(config-if)# copy running-config startup-config	Saves this configuration change.

Example

This example shows how to create a VRF and add an interface to the VRF:

```
switch# configure terminal
switch(config)# vrf context RemoteOfficeVRF
switch(config-vrf)# exit
switch(config)# router rip Enterprise
switch(config-router)# vrf RemoteOfficeVRF
switch(config-router-vrf)# address-family ipv4 unicast
switch(config-router-vrf-af)# redistribute eigrp 201 route-map RIPmap
switch(config-router-vrf-af)# interface ethernet 1/2
switch(config-if)# vrf member RemoteOfficeVRF
switch(config-if)# ip address 192.0.2.1/16
switch(config-if)# ip router rip Enterprise
switch(config-if)# copy running-config startup-config
```

Tuning RIP

You can tune RIP to match your network requirements. RIP uses several timers that determine the frequency of routing updates, the length of time before a route becomes invalid, and other parameters. You can adjust these timers to tune routing protocol performance to better suit your internetwork needs.



Note You must configure the same values for the RIP timers on all RIP-enabled routers in your network.

You can use the following optional commands in address-family configuration mode to tune RIP:

Command	Purpose
<p>timers basic <i>update timeout holddown garbage-collection</i></p> <p>Example :</p> <pre>switch(config-router-af)# timers basic 40 120 120 100</pre>	<p>Sets the RIP timers in seconds. The parameters are as follows:</p> <ul style="list-style-type: none"> • <i>update</i>—The range is from 5 to any positive integer. The default is 30. • <i>timeout</i>—The time that Cisco NX-OS waits before declaring a route as invalid. If Cisco NX-OS does not receive route update information for this route before the timeout interval ends, Cisco NX-OS declares the route as invalid. The range is from 1 to any positive integer. The default is 180. • <i>holddown</i>—The time during which Cisco NX-OS ignores better route information for an invalid route. The range is from 0 to any positive integer. The default is 180. • <i>garbage-collection</i>—The time from when Cisco NX-OS marks a route as invalid until Cisco NX-OS removes the route from the routing table. The range is from 1 to any positive integer. The default is 120.

You can use the following optional commands in interface configuration mode to tune RIP:

Command	Purpose
<p>ip rip metric-offset <i>value</i></p> <p>Example :</p> <pre>switch(config-if)# ip rip metric-offset 10</pre>	<p>Adds a value to the metric for every route received on this interface. The range is from 1 to 15. The default is 1.</p>
<p>ip rip route-filter {prefix-list <i>list-name</i> route-map <i>map-name</i> [in out]}</p> <p>Example :</p> <pre>switch(config-if)# ip rip route-filter route-map InputMap in</pre>	<p>Specifies a route map to filter incoming or outgoing RIP updates.</p>

Verifying the RIP Configuration

To display the RIP configuration, perform one of the following tasks:

Command	Purpose
show ip rip instance [<i>instance-tag</i>] [vrf <i>vrf-name</i>]	Displays the status for an instance of RIP.

Command	Purpose
show ip rip [<i>instance instance-tag</i>] interface <i>slot/port detail</i> [<i>vrf vrf-name</i>]	Displays the RIP status for an interface.
show ip rip [<i>instance instance-tag</i>] neighbor [<i>interface-type number</i>] [<i>vrf vrf-name</i>]	Displays the RIP neighbor table.
show ip rip [<i>instance instance-tag</i>] route [<i>ip-prefix/length</i>] [longer-prefixes shorter-prefixes]] [summary] [<i>vrf vrf-name</i>]	Displays the RIP route table.
show running-configuration rip	Displays the current running RIP configuration.

Displaying RIP Statistics

To display RIP statistics, use the following commands:

Command	Purpose
show ip rip [<i>instance instance-tag</i>] policy statistics redistribute { <i>bgp as</i> direct { eigrp isis ospf ospfv3 rip } [<i>instance-tag</i> static] [<i>vrf vrf-name</i>]	Displays the RIP policy statistics.
show ip rip [<i>instance instance-tag</i>] statistics <i>interface-type number</i> [<i>vrf vrf-name</i>]	Displays the RIP statistics.

Use the **clear rip policy statistics redistribute** *protocol process-tag* command to clear policy statistics.

Use the **clear ip rip statistics** command to clear RIP statistics.

Configuration Examples for RIP

The following example shows how to create the Enterprise RIP instance in a VRF and add Ethernet interface 1/2 to this RIP instance. The example also shows how to configure authentication for Ethernet interface 1/2 and redistribute EIGRP into this RIP domain.

```
vrf context NewVRF
!
feature rip
router rip Enterprise
vrf NewVRF
address-family ipv4 unicast
redistribute eigrp 201 route-map RIPmap
maximum-paths 10
!
interface ethernet 1/2
vrf member NewVRF
ip address 192.0.2.1/16
ip router rip Enterprise
ip rip authentication mode md5
ip rip authentication key-chain RIPKey
```

The following example shows a valid keyID configuration:

```
### Valid
key-chain kcl
key 255
key-string ...
```

Related Topics

See [Configuring Route Policy Manager, on page 515](#) for more information on route maps.



CHAPTER 13

Configuring RIPng

This chapter contains the following sections:

- [About RIPng, on page 449](#)
- [Prerequisites for RIPng, on page 451](#)
- [Guidelines and Limitations for RIPng, on page 451](#)
- [Default Settings for RIPng Parameters, on page 452](#)
- [Configuring RIPng, on page 452](#)
- [Verifying the RIPng Configuration, on page 461](#)
- [Displaying RIPng Statistics, on page 461](#)
- [Configuration Examples for RIPng, on page 461](#)
- [Related Topics, on page 462](#)

About RIPng

RIPng Overview

RIPng uses User Datagram Protocol (UDP) data packets to exchange routing information in small internetworks.

RIPng supports IPv6 and uses the following two message types:

- **Request**—Sent to the multicast address FF02::9 to request route updates from other RIPng-enabled routers.
- **Response**—Sent every 30 seconds by default (see the [Verifying the RIPng Configuration, on page 461](#) section). The router also sends response messages after it receives a request message. The response message contains the entire RIPng route table. RIPng sends multiple response packets for a request if the RIPng routing table cannot fit in one response packet.

RIPng uses a hop count for the routing metric. The hop count is the number of routers that a packet can traverse before reaching its destination. A directly connected network has a metric of 1. An unreachable network has a metric of 16. This small range of metrics makes RIPng an unsuitable routing protocol for large networks.

Split Horizon

You can use split horizon to ensure that RIPng never advertises a route out of the interface where it was learned.

Split horizon is a method that controls the sending of RIPng update and query packets. When you enable split horizon on an interface, Cisco NX-OS does not send update packets for destinations that were learned from this interface. Controlling update packets in this manner reduces the possibility of routing loops.

You can use split horizon with poison reverse to configure an interface to advertise routes learned by RIPng as unreachable over the interface that learned the routes.

The following figure shows a sample RIPng network with split horizon and poison reverse enabled.

Figure 37: RIPng with Split Horizon Poison Reverse

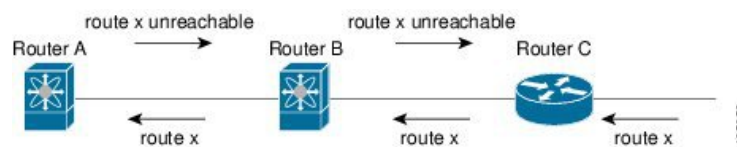

Router C learns about route X and advertises that route to Router B. Router B in turn advertises route X to Router A but sends a route X unreachable update back to Router C.

By default, split horizon is enabled on all interfaces.

Route Filtering

You can configure a route policy on an RIPng-enabled interface to filter the RIPng updates. Cisco NX-OS updates the route table with only those routes that the route policy allows.

Load Balancing

You can use load balancing to allow a router to distribute traffic over all the router network ports that are the same distance from the destination address. Load balancing increases the usage of network segments and increases effective network bandwidth.

Cisco NX-OS supports the Equal Cost Multiple Paths (ECMP) feature with up to 16 equal-cost paths in the RIPng route table and the unicast RIB. You can configure RIPng to load balance traffic across some or all of those paths.

Default Information Origination and Generation

Cisco NX-OS supports default-information origination and generation for RIPng IPv6.

To generate a default route into the Routing Information Protocol (RIP), use the default-information originate command in router address-family configuration mode. To disable this feature, use the **no** form of this command.

```
default-information originate [always] [route-map map-name]
```

```
no default-information originate
```



Note Use the `always` keyword to generate the default route if the route is not present in the RIP routing information base, that is the RIP internal RIB. Use the `route-map` keyword along with the `map-name` variable to generate the default route only if the route is permitted by the route map. The map name is any alphanumeric string up to 63 characters. Use the `originate` to send the default route along with regular updates.

The following example shows how to originate a default route to all routes that pass the condition route map.

```
switch(config)# router rip Enterprise
switch(config-router)# address-family ipv6 unicast
switch(config-router-af)# default-information originate route-map Condition
```

High Availability for RIPng

Cisco NX-OS supports stateless restarts for RIPng. After a reboot or supervisor switchover, Cisco NX-OS applies the running configuration, and RIPng immediately sends request packets to repopulate its routing table.

Virtualization Support for RIPng

Cisco NX-OS supports multiple instances of the RIPng protocol that run on the same system. RIPng supports virtual routing and forwarding (VRF) instances.

Prerequisites for RIPng

RIPng has the following prerequisites:

- You must enable RIPng (see the [Enabling RIPng, on page 452](#) section).

Guidelines and Limitations for RIPng

RIPng has the following configuration guidelines and limitations:

- Beginning with Cisco NX-OS Release 10.2(3)F, RIPng feature is introduced to support IPv6 on Cisco Nexus 9300 and 9500 series platform switches.
- Names in the prefix-list are case-insensitive. We recommend using unique names. Do not use the same name by modifying upper-case and lower-case characters. For example, CTCPrimaryNetworks and CtcPrimaryNetworks are not two different entries.
- Cisco NX-OS does not support RIPv1. If Cisco NX-OS receives an RIPv1 packet, it logs a message and drops the packet.
- Cisco NX-OS does not establish adjacencies with RIPv1 routers.

Default Settings for RIPng Parameters

The table lists the default settings for RIPng parameters.

Default RIPng Parameters

Parameters	Default
Maximum paths for load balancing	16
RIPng feature	Disabled
Split horizon	Enabled

Configuring RIPng



Note If you are familiar with the Cisco IOS CLI, be aware that the Cisco NX-OS commands for this feature might differ from the Cisco IOS commands that you would use.

Enabling RIPng

You must enable RIPng before you can configure RIPng.

SUMMARY STEPS

1. **configure terminal**
2. **[no] feature rip**
3. (Optional) **show feature**
4. (Optional) **copy running-config startup-config**

DETAILED STEPS

	Command or Action	Purpose
Step 1	configure terminal Example: <pre>switch# configure terminal switch(config)#</pre>	Enters global configuration mode.
Step 2	[no] feature rip Example: <pre>switch(config)# feature rip</pre>	Enables the RIPng feature.

	Command or Action	Purpose
Step 3	(Optional) show feature Example: switch(config)# show feature	Displays enabled and disabled features.
Step 4	(Optional) copy running-config startup-config Example: switch(config)# copy running-config startup-config	Saves this configuration change.

Creating an RIPng Instance

You can create an RIPng instance and configure the address family for that instance.

Before you begin

You must enable RIPng (see the [Enabling RIPng, on page 452](#) section).

SUMMARY STEPS

1. **configure terminal**
2. **[no] router rip** *instance-tag*
3. **address-family ipv6 unicast**
4. (Optional) **show ipv6 rip** [*instance instance-tag*] [*vrf vrf-name*]
5. (Optional) **distance** *value*
6. (Optional) **maximum-paths** *number*
7. (Optional) **copy running-config startup-config**

DETAILED STEPS

	Command or Action	Purpose
Step 1	configure terminal Example: switch# configure terminal switch(config)#	Enters global configuration mode.
Step 2	[no] router rip <i>instance-tag</i> Example: switch(config)# router RIP Enterprise switch(config-router)#	Creates a new RIPng instance with the configured <i>instance-tag</i> .
Step 3	address-family ipv6 unicast Example: switch(config-router)# address-family ipv6 unicast switch(config-router-af)#	Configures the address family for this RIPng instance and enters address-family configuration mode.

	Command or Action	Purpose
Step 4	(Optional) <code>show ipv6 rip [instance <i>instance-tag</i>] [vrf <i>vrf-name</i>]</code> Example: <code>switch(config-router-af)# show ipv6 rip</code>	Displays a summary of RIPng information for all RIPng instances.
Step 5	(Optional) <code>distance value</code> Example: <code>switch(config-router-af)# distance 30</code>	Sets the administrative distance for RIPng. The range is from 1 to 255. The default is 120. See the Administrative Distance section.
Step 6	(Optional) <code>maximum-paths number</code> Example: <code>switch(config-router-af)# maximum-paths 6</code>	Configures the maximum number of equal-cost paths that RIPng maintains in the route table. The range is from 1 to 64. The default is 16.
Step 7	(Optional) <code>copy running-config startup-config</code> Example: <code>switch(config-router-af)# copy running-config startup-config</code>	Saves this configuration change.

Example

This example shows how to create an RIPng instance for IPv6 and set the number of equal-cost paths for load balancing:

```
switch# configure terminal
switch(config)# router rip Enterprise
switch(config-router)# address-family ipv6 unicast
switch(config-router-af)# max-paths 10
switch(config-router-af)# copy running-config startup-config
```

Restarting an RIPng Instance

You can restart an RIPng instance and remove all associated neighbors for the instance.

To restart an RIPng instance and remove all associated neighbors, use the following command in global configuration mode:

SUMMARY STEPS

1. `restart rip instance-tag`

DETAILED STEPS

	Command or Action	Purpose
Step 1	<code>restart rip <i>instance-tag</i></code> Example: <code>switch(config)# restart rip Enterprise</code>	Restarts the RIPng instance and removes all neighbors.

Configuring RIPng on an Interface

Before you begin

You must enable RIPng (see the [Enabling RIPng, on page 452](#) section).

SUMMARY STEPS

1. **configure terminal**
2. **interface** *interface-type slot/port*
3. **ipv6 router rip** *instance-tag*
4. (Optional) **show ipv6 rip** [*instance instance-tag*] **interface** [*interface-type slot/port*] [**vrf** *vrf-name*] [**detail**]
5. (Optional) **copy running-config startup-config**

DETAILED STEPS

	Command or Action	Purpose
Step 1	configure terminal Example: <pre>switch# configure terminal switch(config)#</pre>	Enters global configuration mode.
Step 2	interface <i>interface-type slot/port</i> Example: <pre>switch(config)# interface ethernet 1/2 switch(config-if)#</pre>	Enters interface configuration mode.
Step 3	ipv6 router rip <i>instance-tag</i> Example: <pre>switch(config-if)# ipv6 router rip Enterprise</pre>	Associates this interface with an RIPng instance.
Step 4	(Optional) show ipv6 rip [<i>instance instance-tag</i>] interface [<i>interface-type slot/port</i>] [vrf <i>vrf-name</i>] [detail] Example: <pre>switch(config-if)# show ipv6 rip Enterprise ethernet 1/2</pre>	Displays RIPng information for an interface.
Step 5	(Optional) copy running-config startup-config Example: <pre>switch(config-if)# copy running-config startup-config</pre>	Saves this configuration change.

Example

This example shows how to add Ethernet 1/2 interface to an RIPng instance:

```
switch# configure terminal
switch(config)# interface ethernet 1/2
switch(config-if)# ipv6 router rip Enterprise
switch(config)# copy running-config startup-config
```

Configuring Split Horizon with Poison Reverse

You can configure an interface to advertise routes learned by RIPng as unreachable over the interface that learned the routes by enabling poison reverse.

To configure split horizon with poison reverse on an interface, use the following command in interface configuration mode:

SUMMARY STEPS

1. `ipv6 rip poison-reverse`

DETAILED STEPS

	Command or Action	Purpose
Step 1	ipv6 rip poison-reverse Example: switch(config-if)# ipv6 rip poison-reverse	Enables split horizon with poison reverse. Split horizon with poison reverse is disabled by default.

Configuring Cisco NX-OS RIPng for Compatibility with Cisco IOS RIPng

You can configure Cisco NX-OS RIPng to behave like Cisco IOS RIPng in the way that routes are advertised and processed.

Directly connected routes are treated with cost 1 in Cisco NX-OS RIPng and with cost 0 in Cisco IOS RIPng. When routes are advertised in Cisco NX-OS RIPng, the receiving device adds a minimum cost of +1 to all received routes and installs the routes in its routing table. In Cisco IOS RIPng, this cost increment is done on the sending router, and the receiving router installs the routes without any modification. This difference in behavior can cause issues when both Cisco NX-OS and Cisco IOS devices are working together. You can prevent these compatibility issues by configuring Cisco NX-OS RIPng to advertise and process routes like Cisco IOS RIPng.

Before you begin

You must enable RIPng (see the [Enabling RIPng, on page 452](#) section).

SUMMARY STEPS

1. `configure terminal`
2. `router rip instance-tag`
3. `[no] metric direct 0`
4. (Optional) `show running-config rip`
5. (Optional) `copy running-config startup-config`

DETAILED STEPS

	Command or Action	Purpose
Step 1	configure terminal Example: switch# configure terminal switch(config)#	Enters global configuration mode.
Step 2	router rip <i>instance-tag</i> Example: switch(config)# router rip 100 switch(config-router)#	Creates a new RIPng instance with the configured instance tag. You can enter 100, 201, or up to 20 alphanumeric characters for the instance tag.
Step 3	[no] metric direct 0 Example: switch(config-router)# metric direct 0	Configures all directly connected routes with cost 0 instead of the default of cost 1 in order to make Cisco NX-OS RIPng compatible with Cisco IOS RIPng in the way that routes are advertised and processed. Note This command must be configured on all Cisco NX-OS devices that are present in any RIPng network that also contains Cisco IOS devices.
Step 4	(Optional) show running-config rip Example: switch(config-router)# show running-config rip	Displays the current running RIPng configuration.
Step 5	(Optional) copy running-config startup-config Example: switch(config-router)# copy running-config startup-config	Saves this configuration change.

Example

This example shows how to disable Cisco NX-OS RIPng compatibility with Cisco IOS RIPng by returning all direct routes from cost 0 to cost 1:

```
switch# configure terminal
switch(config)# router rip 100
switch(config-router)# no metric direct 0
switch(config-router)# show running-config rip
switch(config-router)# copy running-config startup-config
```

Configuring Virtualization

You can configure multiple RIPng instances, create multiple VRFs, and use the same or multiple RIPng instances in each VRF. You assign an RIPng interface to a VRF.



Note Configure all other parameters for an interface after you configure the VRF for an interface. Configuring a VRF for an interface deletes all the configurations for that interface.

Before you begin

You must enable RIPng (see the [Enabling RIPng, on page 452](#) section).

SUMMARY STEPS

1. **configure terminal**
2. **vrf context** *vrf-name*
3. **exit**
4. **router rip** *instance-tag*
5. **vrf** *vrf-name*
6. (Optional) **address-family ipv6 unicast**
7. **interface ethernet** *slot/port*
8. **vrf member** *vrf-name*
9. **ipv6 address** *ipv6-prefix/length*
10. **ipv6 router rip** *instance-tag*
11. (Optional) **show ipv6 rip** [**instance** *instance-tag*] **interface** [*interface-type slot/port*] [**vrf** *vrf-name*]
12. (Optional) **copy running-config startup-config**

DETAILED STEPS

	Command or Action	Purpose
Step 1	configure terminal Example: <pre>switch# configure terminal switch(config)#</pre>	Enters global configuration mode.
Step 2	vrf context <i>vrf-name</i> Example: <pre>switch(config)# vrf context RemoteOfficeVRF switch(config-vrf)#</pre>	Creates a new VRF and enters VRF configuration mode.
Step 3	exit Example: <pre>switch(config-vrf)# exit switch(config)#</pre>	Exits VRF configuration mode.
Step 4	router rip <i>instance-tag</i> Example: <pre>switch(config)# router rip Enterprise switch(config-router)#</pre>	Creates a new RIPng instance with the configured instance tag.

	Command or Action	Purpose
Step 5	vrf <i>vrf-name</i> Example: switch(config-router)# vrf RemoteOfficeVRF switch(config-router-vrf)#	Creates a new VRF.
Step 6	(Optional) address-family ipv6 unicast Example: switch(config-router-vrf)# address-family ipv6 unicast switch(config-router-vrf-af)#	Configures the VRF address family for this RIPng instance.
Step 7	interface ethernet <i>slot/port</i> Example: switch(config-router-vrf-af)# interface ethernet 1/2 switch(config-if)#	Enters interface configuration mode.
Step 8	vrf member <i>vrf-name</i> Example: switch(config-if)# vrf member RemoteOfficeVRF	Adds this interface to a VRF.
Step 9	ipv6 address <i>ipv6-prefix/length</i> Example: switch(config-if)# ipv6 address 1001::1/64	Configures an IP address for this interface. You must perform this step after you assign this interface to a VRF.
Step 10	ipv6 router rip <i>instance-tag</i> Example: switch(config-if)# ipv6 router rip Enterprise	Associates this interface with an RIPng instance.
Step 11	(Optional) show ipv6 rip [<i>instance instance-tag</i>] interface [<i>interface-type slot/port</i>] [vrf <i>vrf-name</i>] Example: switch(config-if)# show ipv6 rip Enterprise ethernet 1/2	Displays RIPng information for an interface in a VRF.
Step 12	(Optional) copy running-config startup-config Example: switch(config-if)# copy running-config startup-config	Saves this configuration change.

Example

This example shows how to create a VRF and add an interface to the VRF:

```
switch# configure terminal
switch(config)# vrf context RemoteOfficeVRF
switch(config-vrf)# exit
```

```

switch(config)# router rip Enterprise
switch(config-router)# vrf RemoteOfficeVRF
switch(config-router-vrf)# address-family ipv6 unicast
switch(config-router-vrf-af)# interface ethernet 1/2
switch(config-if)# vrf member RemoteOfficeVRF
switch(config-if)# ipv6 address 1001::1/64
switch(config-if)# ipv6 router rip Enterprise
switch(config-if)# copy running-config startup-config

```

Tuning RIPng

You can tune RIPng to match your network requirements. RIPng uses several timers that determine the frequency of routing updates, the length of time before a route becomes invalid, and other parameters. You can adjust these timers to tune routing protocol performance to better suit your internetwork needs.



Note You must configure the same values for the RIPng timers on all RIPng-enabled routers in your network.

You can use the following optional commands in address-family configuration mode to tune RIPng:

Command	Purpose
<p>timers basic <i>update timeout holddown garbage-collection</i></p> <p>Example:</p> <pre>switch(config-router-af)# timers basic 40 120 120 100</pre>	<p>Sets the RIPng timers in seconds. The parameters are as follows:</p> <ul style="list-style-type: none"> • <i>update</i>—The range is from 5 to any positive integer. The default is 30. • <i>timeout</i>—The time that Cisco NX-OS waits before declaring a route as invalid. If Cisco NX-OS does not receive route update information for this route before the timeout interval ends, Cisco NX-OS declares the route as invalid. The range is from 1 to any positive integer. The default is 180. • <i>holddown</i>—The time during which Cisco NX-OS ignores better route information for an invalid route. The range is from 0 to any positive integer. The default is 180. • <i>garbage-collection</i>—The time from when Cisco NX-OS marks a route as invalid until Cisco NX-OS removes the route from the routing table. The range is from 1 to any positive integer. The default is 120.

You can use the following optional commands in interface configuration mode to tune RIPng:

Command	Purpose
ipv6 rip route-filter { prefix-list <i>list-name</i> route-map <i>map-name</i> [in out]} Example : <pre>switch(config-if)# ipv6 rip route-filter route-map InputMap in</pre>	Specifies a route map to filter incoming or outgoing RIPng updates.

Verifying the RIPng Configuration

To display the RIPng configuration, perform one of the following tasks:

Command	Purpose
show ipv6 rip instance [<i>instance-tag</i>] [vrf <i>vrf-name</i>]	Displays the status for an instance of RIPng.
show ipv6 rip [instance <i>instance-tag</i>] interface <i>slot/port</i> detail [vrf <i>vrf-name</i>]	Displays the RIPng status for an interface.
show ipv6 rip [instance <i>instance-tag</i>] neighbor [<i>interface-type number</i>] [vrf <i>vrf-name</i>]	Displays the RIPng neighbor table.
show ipv6 rip [instance <i>instance-tag</i>] route [<i>ip-prefix/length</i> [longer-prefixes shorter-prefixes]] [summary] [vrf <i>vrf-name</i>]	Displays the RIPng route table.
show running-configuration rip	Displays the current running RIPng configuration.

Displaying RIPng Statistics

To display RIPng statistics, use the following commands:

Command	Purpose
show ipv6 rip [instance <i>instance-tag</i>] statistics <i>interface-type number</i> [vrf <i>vrf-name</i>]	Displays the RIPng statistics.

Use the **clear ipv6 rip statistics** command to clear RIPng statistics.

Configuration Examples for RIPng

The following example shows how to create the Enterprise RIPng instance in a VRF and add Ethernet interface 1/2 to this RIPng instance.

```
router rip Enterprise
address-family ipv6 unicast
distance 33
maximum-paths 8
default-information originate always
```

```
timers basic 31 181 181 121

interface ethernet 1/2
ipv6 router rip Enterprise
```

Related Topics

See [Configuring Route Policy Manager, on page 515](#) for more information on route maps.



CHAPTER 14

Configuring Static Routing

This chapter describes how to configure static routing on the Cisco NX-OS device.

This chapter contains the following sections:

- [About Static Routing, on page 463](#)
- [Prerequisites for Static Routing, on page 465](#)
- [Default Settings, on page 465](#)
- [Configuring Static Routing, on page 465](#)
- [Configuration Example for Static Routing, on page 470](#)

About Static Routing

Routers forward packets using either route information from route table entries that you manually configure or the route information that is calculated using dynamic routing algorithms.

Static routes, which define explicit paths between two routers, cannot be automatically updated. You must manually reconfigure static routes when network changes occur. Static routes use less bandwidth than dynamic routes. No CPU cycles are used to calculate and analyze routing updates.

You can supplement dynamic routes with static routes where appropriate. You can redistribute static routes into dynamic routing algorithms, but you cannot redistribute routing information calculated by dynamic routing algorithms into the static routing table.

You should use static routes in environments where network traffic is predictable and where the network design is simple. You should not use static routes in large, constantly changing networks because static routes cannot react to network changes. Most networks use dynamic routes to communicate between routers but might have one or two static routes configured for special cases. Static routes are also useful for specifying a gateway of last resort (a default router to which all unroutable packets are sent).

Administrative Distance

An administrative distance is the metric used by routers to choose the best path when there are two or more routes to the same destination from two different routing protocols. An administrative distance guides the selection of one routing protocol (or static route) over another, when more than one protocol adds the same route to the unicast routing table. Each routing protocol is prioritized in order of most to least reliable using an administrative distance value.

Static routes have a default administrative distance of 1. A router prefers a static route to a dynamic route because the router considers a route with a low number to be the shortest. If you want a dynamic route to override a static route, you can specify an administrative distance for the static route. For example, if you have two dynamic routes with an administrative distance of 120, you would specify an administrative distance that is greater than 120 for the static route if you want the dynamic route to override the static route.

Directly Connected Static Routes

You must specify only the output interface (the interface on which all packets are sent to the destination network) in a directly connected static route. The router assumes that the destination is directly attached to the output interface and the packet destination is used as the next-hop address. The next hop can be an interface, but only for point-to-point interfaces. For broadcast interfaces, the next hop must be an IPv4/IPv6 address.

Fully Specified Static Routes

You must specify either the output interface (the interface on which all packets are sent to the destination network) or the next-hop address in a fully specified static route. You can use a fully specified static route when the output interface is a multi-access interface and you need to identify the next-hop address. The next-hop address must be directly attached to the specified output interface.

Floating Static Routes

A floating static route is a static route that the router uses to back up a dynamic route. You must configure a floating static route with a higher administrative distance than the dynamic route that it backs up. In this instance, the router prefers a dynamic route to a floating static route. You can use a floating static route as a replacement if the dynamic route is lost.



Note By default, a router prefers a static route to a dynamic route because a static route has a smaller administrative distance than a dynamic route.

Remote Next Hops for Static Routes

You can specify the next-hop address of a neighboring router that is not directly connected to the router for static routes with remote (non-directly attached) next hops. If a static route has remote next hops during data forwarding, the next hops are recursively used in the unicast routing table to identify the corresponding directly attached next hops that have reachability to the remote next hops.

BFD

This feature supports bidirectional forwarding detection (BFD). BFD is a detection protocol that is designed to provide fast forwarding-path failure detection times. BFD provides subsecond failure detection between two adjacent devices and can be less CPU intensive than protocol hello messages because some of the BFD load can be distributed onto the data plane on supported modules. See the [Cisco Nexus 9000 Series NX-OS Interfaces Configuration Guide, Release 9.3\(x\)](#) for more information.

Virtualization Support

Static routes support virtual routing and forwarding (VRF) instances.

Prerequisites for Static Routing

Static routing has the following prerequisites:

- A static route will not be added to the unicast routing table if there is no unicast route containing its next hop address.

Default Settings

The table lists the default settings for static routing parameters.

Table 25: Default Static Routing Parameters

Parameters	Default
Administrative distance	1
RIP feature	Disabled

Configuring Static Routing



Note If you are familiar with the Cisco IOS CLI, be aware that the Cisco NX-OS commands for this feature might differ from the Cisco IOS commands that you would use.

Configuring a Static Route

You can configure a static route on the device.

SUMMARY STEPS

1. **configure terminal**
2. Enter one of these commands:
 - **ip route** *{ip-prefix | ip-addr/ip-mask} {[next-hop | nh-prefix] | [interface next-hop | nh-prefix]} [name nexthop-name] [tag tag-value] [preference]*
 - **ipv6 route** *ipv6-prefix {nh-prefix | link-local-nh-prefix} | {nexthop [interface] | link-local-nexthop [interface]} [name nexthop-name] [tag tag-value] [preference]*
3. (Optional) **show {ip | ipv6} static-route**
4. (Optional) **copy running-config startup-config**

DETAILED STEPS

	Command or Action	Purpose
Step 1	configure terminal Example: <pre>switch# configure terminal switch(config)#</pre>	Enters global configuration mode.
Step 2	Enter one of these commands: <ul style="list-style-type: none"> • ip route <i>{ip-prefix ip-addr/ip-mask}</i> <i>{[next-hop nh-prefix] [interface next-hop nh-prefix]}</i> [name nexthop-name] [tag tag-value] <i>[preference]</i> • ipv6 route <i>ipv6-prefix {nh-prefix link-local-nh-prefix}</i> <i>{[nexthop [interface] link-local-nexthop [interface]}</i> [name nexthop-name] [tag tag-value] <i>[preference]</i> Example: <pre>switch(config)# ip route 192.0.2.0/8 ethernet 1/2 192.0.2.4 switch(config)# ipv6 route 2001:0DB8::/48 6::6 ethernet 2/1</pre>	Configures a static route and the interface for this static route. Use ? to display a list of supported interfaces. You can specify a null interface by using null 0 . You can optionally configure the next-hop address. The <i>preference</i> value sets the administrative distance. The range is from 1 to 255. The default is 1. Note Use the no {ip ipv6} route command to remove the static route.
Step 3	(Optional) show {ip ipv6} static-route Example: <pre>switch(config)# show ip static-route</pre>	Displays information about static routes.
Step 4	(Optional) copy running-config startup-config Example: <pre>switch(config)# copy running-config startup-config</pre>	Saves this configuration change.

Example

This example shows how to configure a static route for a null interface:

```
switch# configure terminal
switch(config)# ip route 1.1.1.1/32 null 0
switch(config)# copy running-config startup-config
```

Configuring a Static Route Over a VLAN

You can configure a static route without next-hop support over a VLAN.

Before you begin

Ensure that the access port is part of the VLAN.

SUMMARY STEPS

1. **configure terminal**
2. **feature interface vlan**
3. **interface-vlan** *vlan-id*
4. **ip address** *ip-addr/length*
5. **[no] ip route** *ip-addr/length vlan-id*
6. (Optional) **show ip route**
7. (Optional) **copy running-config startup-config**

DETAILED STEPS

	Command or Action	Purpose
Step 1	configure terminal Example: switch# configure terminal switch(config)#	Enters global configuration mode.
Step 2	feature interface vlan Example: switch(config)# feature interface-vlan	Enables VLAN interface mode.
Step 3	interface-vlan <i>vlan-id</i> Example: switch(config)# interface-vlan 10	Creates an SVI and enters interface configuration mode. The range for the vlan-id argument is from 1 to 4094, except for the VLANs reserved for the internal switch.
Step 4	ip address <i>ip-addr/length</i> Example: switch(config)# ip address 192.0.2.1/8	Configures an IP address for the VLAN.
Step 5	[no] ip route <i>ip-addr/length vlan-id</i> Example: switch(config)# ip route 209.165.200.224/27 vlan 10	Adds an interface static route without a next hop on the switch virtual interface (SVI). The IP address is the address that is configured on the interface that is connected to the switch. Use the no keyword with this command to remove the static route.
Step 6	(Optional) show ip route Example: switch(config)# show ip route	Displays routes from the Unicast Route Information Base (URIB).
Step 7	(Optional) copy running-config startup-config Example: switch(config)# copy running-config startup-config	Saves this configuration change.

Example

This example shows how to configure a static route without a next hop over an SVI:

```
switch# configure terminal
switch(config)# feature interface-vlan
switch(config)# interface vlan 10
switch(config-if)# ip address 192.0.2.1/8
switch(config-if)# ip route 209.165.200.224/27 vlan 10 <===209,165.200.224 is the IP
address of the interface that is configured on the interface that is directly connected to
the switch.
switch(config-if)# copy running-config startup-config
```

Configuring Virtualization

You can configure a static route in a VRF.



Note When a **ip route** command is applied on a VRF context, the **show run vrf** command displays some octets that have changed from the initial configuration.

SUMMARY STEPS

1. **configure terminal**
2. **vrf context** *vrf-name*
3. Enter one of these commands:
 - **ip route** {*ip-prefix* | *ip-addr ip-mask*} {*next-hop* | *nh-prefix* | *interface*} [**name** *nexthop-name*] [**tag** *tag-value*] [*preference*]
 - **ipv6 route** *ipv6-prefix* {*nh-prefix* | *link-local-nh-prefix*} | {*nexthop* [*interface*] | *link-local-nexthop* [*interface*]} [**name** *nexthop-name*] [**tag** *tag-value*] [*preference*]
4. (Optional) **show** {**ip** | **ipv6**} **static-route** **vrf** *vrf-name*
5. (Optional) **copy running-config startup-config**

DETAILED STEPS

	Command or Action	Purpose
Step 1	configure terminal Example: <pre>switch# configure terminal switch(config)#</pre>	Enters global configuration mode.
Step 2	vrf context <i>vrf-name</i> Example: <pre>switch(config)# vrf context StaticVrf switch(config-vrf)#</pre>	Creates a VRF and enters VRF configuration mode.

	Command or Action	Purpose
Step 3	<p>Enter one of these commands:</p> <ul style="list-style-type: none"> • ip route <i>{ip-prefix ip-addr ip-mask} {next-hop nh-prefix interface} [name nexthop-name] [tag tag-value] [preference]</i> • ipv6 route <i>ipv6-prefix {nh-prefix link-local-nh-prefix} {nexthop [interface] link-local-nexthop [interface]} [name nexthop-name] [tag tag-value] [preference]</i> <p>Example:</p> <pre>switch(config-vrf)# ip route 192.0.2.0/8 ethernet 1/2 switch(config-vrf)# ipv6 route 2001:0DB8::/48 6::6 ethernet 2/1</pre>	<p>Configures a static route and the interface for this static route. Use ? to display a list of supported interfaces. You can specify a null interface by using null 0.</p> <p>You can optionally configure the next-hop address.</p> <p>The <i>preference</i> value sets the administrative distance. The range is from 1 through 255. The default is 1.</p>
Step 4	<p>(Optional) show {ip ipv6} static-route vrf vrf-name</p> <p>Example:</p> <pre>switch(config-vrf)# show ip static-route</pre>	Displays information about static routes.
Step 5	<p>(Optional) copy running-config startup-config</p> <p>Example:</p> <pre>switch(config-vrf)# copy running-config startup-config</pre>	Saves this configuration change.

Example

This example shows how to configure a static route:

```
switch# configure terminal
switch(config)# vrf context StaticVrf
switch(config-vrf)# ip route 192.0.2.0/8 192.0.2.10
switch(config-vrf)# copy running-config startup-config
```

Verifying the Static Routing Configuration

To display the static routing configuration, perform one of the following tasks:

Command	Purpose
show {ip ipv6} static-route	Displays the configured static routes.
show ipv6 static-route vrf vrf-name	Displays static route information for each VRF.
show {ip ipv6} static-route track-table	Displays information table about the IPv4 or IPv6 static-route track table.

Configuration Example for Static Routing

This example shows how to configure static routing:

```
configure terminal
ip route 192.0.2.0/8 192.0.2.10
copy running-config startup-config
```



CHAPTER 15

Configuring Layer 3 Virtualization

This chapter describes how to configure Layer 3 virtualization on the Cisco NX-OS device.

This chapter includes the following sections:

- [About Layer 3 Virtualization, on page 471](#)
- [Prerequisites for VRF, on page 475](#)
- [Guidelines and Limitations for VRFs, on page 475](#)
- [Guidelines and Limitations for VRF Route Leaking, on page 476](#)
- [Default Settings, on page 477](#)
- [Configuring VRFs, on page 477](#)
- [Verifying the VRF Configuration, on page 484](#)
- [Configuration Examples for VRFs, on page 484](#)
- [Additional References, on page 491](#)

About Layer 3 Virtualization

Cisco NX-OS supports multiple virtual routing and forwarding instances (VRFs). Each VRF contains a separate address space with unicast and multicast route tables for IPv4 and IPv6 and makes routing decisions independent of any other VRF.

Each router has a default VRF and a management VRF.

Management VRF

- The management VRF is for management purposes only.
- Only the mgmt 0 interface can be in the management VRF.
- The mgmt 0 interface cannot be assigned to another VRF.
- No routing protocols can run in the management VRF (static only).

Default VRF

- All Layer 3 interfaces exist in the default VRF until they are assigned to another VRF.
- Routing protocols run in the default VRF context unless another VRF context is specified.
- The default VRF uses the default routing context for all show commands.

- The default VRF is similar to the global routing table concept in Cisco IOS.



Note When you upgrade to Cisco NX-OS Release 10.4(3)F, the default configuration for limit-resource will be changed to 4096.

When you upgrade to Cisco NX-OS Release 10.3(5), the default configuration for limit-resource will be changed to 4096.

Egress Loadbalance Resolution VRF

Egress Loadbalance Resolution (egress-loadbalance-resolution-) is an internal VRF which is created automatically. This VRF is similar to default VRF.

The purpose of this VRF is to assist in additional computation and resolution of routes for a VXLAN EVPN feature.



Note • This VRF is not configurable by the user and cannot be deleted, as this is a benign empty VRF.

- The VRF limit is increased from 4096 to 4097 to accommodate this new implicit VRF.

For example:

- Existing default configuration

```
vdc switch id 1
limit-resource vrf minimum 2 maximum 4096
```

- New default configuration

```
vdc switch id 1
limit-resource vrf minimum 2 maximum 4097
```

VRF and Routing

All unicast and multicast routing protocols support VRFs. When you configure a routing protocol in a VRF, you set routing parameters for the VRF that are independent of routing parameters in another VRF for the same routing protocol instance.

You can assign interfaces and route protocols to a VRF to create virtual Layer 3 networks. An interface exists in only one VRF. The following figure shows one physical network split into two virtual networks with two VRFs. Routers Z, A, and B exist in VRF Red and form one address domain. These routers share route updates that do not include Router C because Router C is configured in a different VRF.

Figure 38: VRFs in a Network

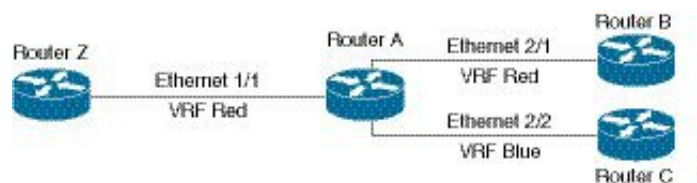

By default, Cisco NX-OS uses the VRF of the incoming interface to select which routing table to use for a route lookup. You can configure a route policy to modify this behavior and set the VRF that Cisco NX-OS uses for incoming packets.

Cisco NX-OS supports route leaking (import or export) between VRFs.

Route Leaking and Importing Routes from the Default VRF

Cisco NX-OS supports route leaking (import or export) between VRFs.

You can import IP prefixes from the global routing table (the default VRF) into any other VRF by using an import policy. The VRF import policy uses a route map to specify the prefixes to be imported into a VRF. The policy can import IPv4 and IPv6 unicast prefixes.



Note Routes in the BGP default VRF can be imported directly. Any other routes in the default VRF should be redistributed into BGP first.

IP prefixes are defined as match criteria for the import route map through standard route policy filtering mechanisms. For example, you can create an IP prefix list or an as-path filter to define an IP prefix or IP prefix range and use that prefix list or as-path filter in a match clause for the route map. Prefixes that pass through the route map are imported into the specified VRF using the import policy. IP prefixes that are imported into a VRF through this import policy cannot be reimported into another VRF.

For more information, see the [Guidelines and Limitations for VRF Route Leaking](#) section.

BGP VRF Router-ID for IPv6 Only Environments

The following are the sources to obtain router-id in order of priority:

1. VRF level router-id command
2. IPv4 address configured VRF interface
3. Inherit non-default VRF router-id from default VRF router-id config



Note The third source for router-id has the least priority and applies only if the first and second sources are unavailable.



Note In the absence of router-id, BGP OPEN messages cannot be sent.

VRF-Aware Services

A fundamental feature of the Cisco NX-OS architecture is that every IP-based feature is VRF aware.

The following VRF-aware services can select a particular VRF to reach a remote server or to filter information based on the selected VRF:

- AAA—See the [Cisco Nexus 9000 Series NX-OS Security Configuration Guide](#) for more information.
- Call Home—See the [Cisco Nexus 9000 Series NX-OS System Management Configuration Guide](#) for more information.
- DNS—See [Configuring DNS, on page 91](#) for more information.
- HSRP—See [Configuring HSRP, on page 567](#) for more information.
- HTTP—See the [Cisco Nexus 9000 Series NX-OS Fundamentals Configuration Guide](#) for more information.
- NTP—See the [Cisco Nexus 9000 Series NX-OS System Management Configuration Guide](#) for more information.
- Ping and Traceroute—See the [Cisco Nexus 9000 Series NX-OS Fundamentals Configuration Guide](#) for more information.
- RADIUS—See the [Cisco Nexus 9000 Series NX-OS Security Configuration Guide](#) for more information.
- SNMP—See the [Cisco Nexus 9000 Series NX-OS System Management Configuration Guide](#) for more information.
- SSH—See the [Cisco Nexus 9000 Series NX-OS Security Configuration Guide](#) for more information.
- Syslog—See the [Cisco Nexus 9000 Series NX-OS System Management Configuration Guide](#) for more information.
- TACACS+—See the [Cisco Nexus 9000 Series NX-OS Security Configuration Guide](#) for more information.
- TFTP—See the [Cisco Nexus 9000 Series NX-OS Fundamentals Configuration Guide](#) for more information.
- VRRP—See [Configuring VRRP, on page 593](#) for more information.
- XML—See the [Cisco NX-OS XML Management Interface User Guide](#) for more information.

See the appropriate configuration guide for each service for more information on configuring VRF support in that service.

Reachability

Reachability indicates which VRF contains the routing information necessary to get to the server providing the service. For example, you can configure an SNMP server that is reachable on the management VRF. When you configure that server address on the router, you also configure which VRF Cisco NX-OS must use to reach the server.

The following figure shows an SNMP server that is reachable over the management VRF. You configure Router A to use the management VRF for SNMP server host 192.0.2.1.

Figure 39: Service VRF Reachability

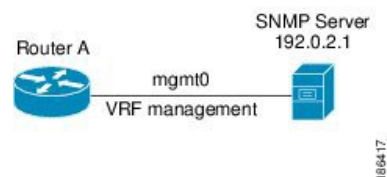

Filtering

Filtering allows you to limit the type of information that goes to a VRF-aware service based on the VRF. For example, you can configure a syslog server to support a particular VRF. The following figure shows two syslog servers with each server supporting one VRF. Syslog server A is configured in VRF Red, so Cisco NX-OS sends only system messages generated in VRF Red to syslog server A.

Figure 40: Service VRF Filtering

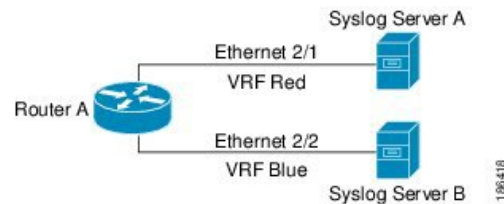

Combining Reachability and Filtering

You can combine reachability and filtering for VRF-aware services. You can configure the VRF that Cisco NX-OS uses to connect to that service as well as the VRF that the service supports. If you configure a service in the default VRF, you can optionally configure the service to support all VRFs.

The following figure shows an SNMP server that is reachable on the management VRF. You can configure the SNMP server to support only the SNMP notifications from VRF Red, for example.

Figure 41: Service VRF Reachability Filtering

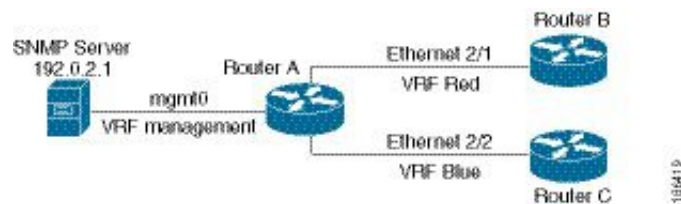

Prerequisites for VRF

You must install the Advanced Services license to use virtual device contexts (VDCs) besides the default VDC. The license requirement for VRF is same as VDC.

Guidelines and Limitations for VRFs

VRFs have the following configuration guidelines and limitations:

- Names in the prefix-list are case-insensitive. We recommend using unique names. Do not use the same name by modifying upper-case and lower-case characters. For example, CTCPrimaryNetworks and CtcPrimaryNetworks are not two different entries.
- When you make an interface a member of an existing VRF, Cisco NX-OS removes all Layer 3 configurations. You should configure all Layer 3 parameters after adding an interface to a VRF.

- You should add the mgmt0 interface to the management VRF and configure the mgmt0 IP address and other parameters after you add it to the management VRF.
- If you configure an interface for a VRF before the VRF exists, the interface is operationally down until you create the VRF.
- Cisco NX-OS creates the default and management VRFs by default. You should make the mgmt0 interface a member of the management VRF.
- The **write erase boot** command does not remove the management VRF configurations. You must use the **write erase** command and then the **write erase boot** command.
- The following guidelines and limitations are for route targets:
 - It is a best practice to assign different route targets for Layer-2 and Layer-3.
 - For automatic route-target generation, route targets are generated from their EVIs. It is a best practice to have different EVI ranges for Layer 2 and Layer 3, which ensures that Layer-2 and Layer-3 EVIs do not use the same identifier.
- Beginning with Cisco NX-OS Release 10.3(1)F, multi VRF is supported on the Cisco Nexus 9808 platform switches.
- Beginning with Cisco NX-OS Release 10.4(1)F, multi VRF is supported on the Cisco Nexus 9804 platform switches.
- Beginning with Cisco NX-OS Release 10.4(1)F, multi VRF is supported on the Cisco Nexus X98900CD-A and N9KX9836DM-A line cards with Cisco Nexus 9808 and 9804 switches.

Guidelines and Limitations for VRF Route Leaking

VRF route leaking has the following configuration guidelines and limitations:

- Route leaking is supported between any two non-default VRFs and from the default VRF to a non-default VRF.



Note Route leaking between VRFs is not supported for MPLS Segment Routing (SR-MPLS).

Route leaking between VRFs is not supported for BGP. A BGP speaker cannot connect to a peer IP that is routed through a different VRF.

- You can restrict route leaking to specific routes using route map filters to match designated IP addresses.
- Route synchronization between NX-OS and Guestshell container does not happen when the route points towards another VRF.
- By default, the maximum number of IP prefixes that can be imported from the default VRF into a non-default VRF and vice versa is 1000 routes.
- There is no limit on the number of routes that can be leaked between two non-default VRFs.

- Beginning with Cisco NX-OS Release 10.3(1)F, route leak between VRFs is supported on the Cisco Nexus 9808 switches.
- Beginning with Cisco NX-OS Release 10.4(1)F, route leak between VRFs is supported on the Cisco Nexus 9804 switches.
- Beginning with Cisco NX-OS Release 10.4(1)F, route leak between VRFs is supported on Cisco Nexus X98900CD-A and X9836DM-A line cards with 9808 and 9804 switches.

Default Settings

The table lists the default settings for VRF parameters.

Table 26: Default VRF Parameters

Parameters	Default
Configured VRFs	Default, management
Routing context	Default VRF

Configuring VRFs



Note If you are familiar with the Cisco IOS CLI, be aware that the Cisco NX-OS commands for this feature might differ from the Cisco IOS commands that you would use.

Creating a VRF

You can create a VRF.



Note Any commands available in global configuration mode are also available in VRF configuration mode.

SUMMARY STEPS

1. **configure terminal**
2. **[no] vrf context name**
3. (Optional) **ip route** *{ip-prefix | ip-addr ip-mask} {[next-hop | nh-prefix] | [interface next-hop | nh-prefix]}*
[tag tag-value [preference]
4. (Optional) **show vrf [vrf-name]**
5. (Optional) **copy running-config startup-config**

DETAILED STEPS

	Command or Action	Purpose
Step 1	configure terminal Example: switch# configure terminal switch(config)#	Enters global configuration mode.
Step 2	[no] vrf context name Example: switch(config)# vrf context Enterprise switch(config-vrf)#	Creates a new VRF and enters VRF configuration mode. The <i>name</i> can be any case-sensitive, alphanumeric string up to 32 characters. Using the no option with this command deletes the VRF and all associated configurations.
Step 3	(Optional) ip route { <i>ip-prefix</i> <i>ip-addr ip-mask</i> } {[<i>next-hop</i> <i>nh-prefix</i>] [<i>interface next-hop</i> <i>nh-prefix</i>]} [tag tag-value] [<i>preference</i>] Example: switch(config-vrf)# ip route 192.0.2.0/8 ethernet 1/2 192.0.2.4	Configures a static route and the interface for this static route. You can optionally configure the next-hop address. The <i>preference</i> value sets the administrative distance. The range is from 1 to 255. The default is 1.
Step 4	(Optional) show vrf [<i>vrf-name</i>] Example: switch(config-vrf)# show vrf Enterprise	Displays VRF information.
Step 5	(Optional) copy running-config startup-config Example: switch(config-vrf)# copy running-config startup-config	Saves this configuration change.

Example

This example show how to create a VRF and add a static route to the VRF:

```
switch# configure terminal
switch(config)# vrf context Enterprise
switch(config-vrf)# ip route 192.0.2.0/8 ethernet 1/2
switch(config-vrf)# exit
switch(config)# copy running-config startup-config
```

Assigning VRF Membership to an Interface

You can make an interface a member of a VRF.

Before you begin

Assign the IP address for an interface after you have configured the interface for a VRF.

SUMMARY STEPS

1. **configure terminal**
2. **interface** *interface-type slot/port*
3. **vrf member** *vrf-name*
4. **ip address** *ip-prefix/length*
5. (Optional) **show vrf** *vrf-name interface interface-type number*
6. (Optional) **copy running-config startup-config**

DETAILED STEPS

	Command or Action	Purpose
Step 1	configure terminal Example: switch# configure terminal switch(config)#	Enters global configuration mode.
Step 2	interface <i>interface-type slot/port</i> Example: switch(config)# interface ethernet 1/2 switch(config-if)#	Enters interface configuration mode.
Step 3	vrf member <i>vrf-name</i> Example: switch(config-if)# vrf member RemoteOfficeVRF	Adds this interface to a VRF.
Step 4	ip address <i>ip-prefix/length</i> Example: switch(config-if)# ip address 192.0.2.1/16	Configures an IP address for this interface. You must do this step after you assign this interface to a VRF.
Step 5	(Optional) show vrf <i>vrf-name interface interface-type number</i> Example: switch(config-vrf)# show vrf Enterprise interface ethernet 1/2	Displays VRF information.
Step 6	(Optional) copy running-config startup-config Example: switch(config-vrf)# copy running-config startup-config	Saves this configuration change.

Example

This example shows how to add an interface to the VRF:

```
switch# configure terminal
switch(config)# interface ethernet 1/2
```

```
switch(config-if)# vrf member RemoteOfficeVRF
switch(config-if)# ip address 192.0.2.1/16
switch(config-if)# copy running-config startup-config
```

Configuring VRF Parameters for a Routing Protocol

You can associate a routing protocol with one or more VRFs. See the appropriate chapter for information on how to configure VRFs for the routing protocol. This section uses OSPFv2 as an example protocol for the detailed configuration steps.

SUMMARY STEPS

1. **configure terminal**
2. **router ospf** *instance-tag*
3. **vrf** *vrf-name*
4. (Optional) **maximum-paths** *paths*
5. **exit**
6. **exit**
7. **interface** *interface-type slot/port*
8. **vrf member** *vrf-name*
9. **ip address** *ip-prefix/length*
10. **ip router ospf** *instance-tag area area-id*
11. (Optional) **copy running-config startup-config**

DETAILED STEPS

	Command or Action	Purpose
Step 1	configure terminal Example: switch# configure terminal switch(config)#	Enters global configuration mode.
Step 2	router ospf <i>instance-tag</i> Example: switch (config-vrf)# router ospf 201 switch(config-router)#	Creates a new OSPFv2 instance with the configured instance tag.
Step 3	vrf <i>vrf-name</i> Example: switch(config-router)# vrf RemoteOfficeVRF switch(config-router-vrf)#	Enters VRF configuration mode.
Step 4	(Optional) maximum-paths <i>paths</i> Example: switch(config-router-vrf)# maximum-paths 4	Configures the maximum number of equal OSPFv2 paths to a destination in the route table for this VRF. This command is used for load balancing.

	Command or Action	Purpose
Step 5	exit Example: <pre>switch(config-router-vrf)# exit switch(config-router)#</pre>	Exits VRF configuration mode.
Step 6	exit Example: <pre>switch(config-router)# exit switch(config)#</pre>	Exits router configuration mode.
Step 7	interface <i>interface-type slot/port</i> Example: <pre>switch(config)# interface ethernet 1/2 switch(config-if)#</pre>	Enters interface configuration mode.
Step 8	vrf member <i>vrf-name</i> Example: <pre>switch(config-if)# vrf member RemoteOfficeVRF</pre>	Adds this interface to a VRF.
Step 9	ip address <i>ip-prefix/length</i> Example: <pre>switch(config-if)# ip address 192.0.2.1/16</pre>	Configures an IP address for this interface. You must do this step after you assign this interface to a VRF.
Step 10	ip router ospf <i>instance-tag area area-id</i> Example: <pre>switch(config-if)# ip router ospf 201 area 0</pre>	Assigns this interface to the OSPFv2 instance and area configured.
Step 11	(Optional) copy running-config startup-config Example: <pre>switch(config-if)# copy running-config startup-config</pre>	Copies the running configuration to the startup configuration.

Example

This example shows how to create a VRF and add an interface to the VRF:

```
switch# configure terminal
switch(config)# vrf context RemoteOfficeVRF
switch(config-vrf)# exit
switch(config)# router ospf 201
switch(config-router)# vrf RemoteOfficeVRF
switch(config-router-vrf)# maximum-paths 4
switch(config-router-vrf)# interface ethernet 1/2
switch(config-if)# vrf member RemoteOfficeVRF
switch(config-if)# ip address 192.0.2.1/16
switch(config-if)# ip router ospf 201 area 0
```

```
switch(config-if)# exit
switch(config)# copy running-config startup-config
```

Configuring a VRF-Aware Service

You can configure a VRF-aware service for reachability and filtering.

This section uses SNMP and IP domain lists as example services for the detailed configuration steps.

SUMMARY STEPS

1. **configure terminal**
2. **snmp-server host** *ip-address* [**filter-vrf** *vrf-name*] [**use-vrf** *vrf-name*]
3. **vrf context** *vrf-name*
4. **ip domain-list** *domain-name* [**all-vrfs**] [**use-vrf** *vrf-name*]
5. (Optional) **copy running-config startup-config**

DETAILED STEPS

	Command or Action	Purpose
Step 1	configure terminal Example: switch# configure terminal switch(config)#	Enters global configuration mode.
Step 2	snmp-server host <i>ip-address</i> [filter-vrf <i>vrf-name</i>] [use-vrf <i>vrf-name</i>] Example: switch(config)# snmp-server host 192.0.2.1 use-vrf Red	Configures a global SNMP server and configures the VRF that Cisco NX-OS uses to reach the service. Use the filter-vrf keyword to filter information from the selected VRF to this server.
Step 3	vrf context <i>vrf-name</i> Example: switch(config)# vrf context Blue switch(config-vrf)#	Creates a new VRF.
Step 4	ip domain-list <i>domain-name</i> [all-vrfs] [use-vrf <i>vrf-name</i>] Example: switch(config-vrf)# ip domain-list List all-vrfs use-vrf Blue	Configures the domain list in the VRF and optionally configures the VRF that Cisco NX-OS uses to reach the domain name listed.
Step 5	(Optional) copy running-config startup-config Example: switch(config-vrf)# copy running-config startup-config	Saves this configuration change.

Example

This example shows how to send SNMP information for all VRFs to SNMP host 192.0.2.1, reachable on VRF Red:

```
switch# configure terminal
switch(config)# snmp-server host 192.0.2.1 for-all-vrfs use-vrf Red
switch(config)# copy running-config startup-config
```

This example shows how to filter SNMP information for VRF Blue to SNMP host 192.0.2.12, reachable on VRF Red:

```
switch# configure terminal
switch(config)# vrf context Blue
switch(config-vrf)# snmp-server host 192.0.2.12 use-vrf Red
switch(config)# copy running-config startup-config
```

Setting the VRF Scope

You can set the VRF scope for all EXEC commands (for example, **show** commands). Doing so automatically restricts the scope of the output of EXEC commands to the configured VRF. You can override this scope by using the VRF keywords available for some EXEC commands.

SUMMARY STEPS

1. **routing-context vrf** *vrf-name*

DETAILED STEPS

	Command or Action	Purpose
Step 1	routing-context vrf <i>vrf-name</i> Example: switch# routing-context vrf red switch%red#	Sets the routing context for all EXEC commands. The default routing context is the default VRF. Note Use the routing-context vrf default command to return to the default VRF scope.

Example

To return to the default VRF scope, use the following command in EXEC mode:

Command	Purpose
routing-context vrf default Example: switch%red# routing-context vrf default switch#	Sets the default routing context.



Note When you do a shutdown of the VPN VRF with BGP configurations, it will take around 50 seconds for the shutdown process to complete.

Verifying the VRF Configuration

To display VRF configuration information, perform one of the following tasks:

Command	Purpose
<code>show bgp process vrf [vrf-name]</code>	Displays the information for all or one VRF.
<code>show vrf [vrf-name]</code>	Displays the information for all or one VRF.
<code>show vrf [vrf-name] detail</code>	Displays detailed information for all or one VRF.
<code>show vrf [vrf-name] [interface interface-type slot/port]</code>	Displays the VRF status for an interface.

Configuration Examples for VRFs

For more information on VRF configuration, see [Configuring VRFs, on page 477](#).



Note

- The `snmp-server host` command is available both globally and under the `vrf-context` command. The following example shows the configuration under `vrf-context`.
- Ensure that the host is configured on the switch before attaching any attributes (such as `use-vrf`, `source-interface`, `filter-vrf` etc).

Configuration Example for VRF Red

```
!SNMP server configuration under VRF context Red:
vrf context Red
  snmp-server host 192.168.0.12 use-vrf Red

!OSPF instance configuration to VRF Red
router ospf 201
  vrf Red

!interface configuration for VRF Red
interface ethernet 1/2
  vrf member Red
  ip address 192.168.0.1/16
  ip router ospf 201 area 0
  no shutdown
```

Configuration Example for VRF Red and Blue

```

!VRFs (Red, and Blue) creation
vrf context Red
vrf context Blue

!Configures OSPF per VRF
feature ospf
router ospf Lab
    vrf Red

router ospf Production
    vrf Blue
        router-id 192.168.1.0

interface ethernet 1/2
    vrf member Red
    ip address 192.168.0.1/16
    ip router ospf Lab area 0
    no shutdown

interface ethernet 10/2
    vrf member Blue
    ip address 192.168.0.1/16
    ip router ospf Production area 0
    no shutdown

!SNMP server configuration under VRF
!Note: Use the SNMP context "lab" to access the OSPF-MIB values for the OSPF instance Lab
in VRF "Red" in this example.
!Create SNMP entities (v2c and/or v3) with appropriate groups/roles as needed on the switch
to access the MIBs on the switch
!Create SNMP v3 user that can be used for SNMP queries, for example:
snmp-server user admin network-admin auth md5 password1
!Create SNMP v2c community that can be used for SNMP queries, for example:
snmp-server community public ro

!Create SNMP contexts that can be used along with the entities for SNMP queries, for example:
snmp-server context lab instance Lab vrf Red
snmp-server context production instance Production vrf Blue

```

VRFs Configuration Example for Route Leaking

```

!VRF configuration
feature bgp
vrf context red
    ip route 192.168.33.0/32 192.168.3.1
    address-family ipv4 unicast
        route-target import 3:3
        route-target export 2:2
    export map test
    import map test
    import vrf default map test

interface Ethernet1/7
    vrf member red
    ip address 192.168.3.2/24
    no shutdown

vrf context blue
    ip route 192.168.44.0/32 192.168.4.1
    address-family ipv4 unicast
        route-target import 1:1
        route-target import 2:2
        route-target export 3:3
    export map test
    import map test

```

```

import vrf default map test

interface Ethernet1/11
 vrf member blue
 ip address 192.168.4.2/24
 no shutdown
!IP prefix list configuration
ip prefix-list test seq 5 permit 0.0.0.0/0 le 32
route-map test permit 10
 match ip address prefix-list test

ip route 192.168.101.101/32 192.168.55.1
!BGP per VRF assignment
router bgp 100
 address-family ipv4 unicast
  redistribute static route-map test

vrf red
 address-family ipv4 unicast
  redistribute static route-map test

vrf blue
 address-family ipv4 unicast
  redistribute static route-map test

```

Verification Example for route leaking between global and non-default VRFs

```

switch# show ip route vrf all
IP Route Table for VRF "default"
 '*' denotes best ucast next-hop
 *** denotes best mcast next-hop
 '[x/y]' denotes [preference/metric]
 '%<string>' in via output denotes VRF <string>

192.168.55.0/24, ubest/mbest: 1/0, attached
   *via 192.168.55.5, Lo0, [0/0], 00:07:59, direct
192.168.55.5/32, ubest/mbest: 1/0, attached
   *via 192.168.55.5, Lo0, [0/0], 00:07:59, local
192.168.101.101/32, ubest/mbest: 1/0
   *via 192.168.55.1, [1/0], 00:07:42, static
!
IP Route Table for VRF "management"
 '*' denotes best ucast next-hop
 *** denotes best mcast next-hop
 '[x/y]' denotes [preference/metric]
 '%<string>' in via output denotes VRF <string>

0.0.0.0/0, ubest/mbest: 1/0
   *via 10.29.176.1, [1/0], 12:53:54, static
10.29.176.0/24, ubest/mbest: 1/0, attached
   *via 10.29.176.233, mgmt0, [0/0], 13:11:57, direct
10.29.176.233/32, ubest/mbest: 1/0, attached
   *via 10.29.176.233, mgmt0, [0/0], 13:11:57, local
!
IP Route Table for VRF "red"
 '*' denotes best ucast next-hop
 *** denotes best mcast next-hop
 '[x/y]' denotes [preference/metric]
 '%<string>' in via output denotes VRF <string>

192.168.33.0/32, ubest/mbest: 1/0
   *via 192.168.3.1, [1/0], 00:23:44, static
35.35.1.0/24, ubest/mbest: 1/0, attached
   *via 35.35.1.2, Eth1/7, [0/0], 00:26:46, direct

```

```

35.35.1.2/32, ubest/mbest: 1/0, attached
  *via 35.35.1.2, Eth1/7, [0/0], 00:26:46, local
192.168.44.0/32, ubest/mbest: 1/0
  *via 192.168.4.1%blue, [20/0], 00:12:08, bgp-100, external, tag 100
192.168.101.101/32, ubest/mbest: 1/0
  *via 192.168.55.1%default, [20/0], 00:07:41, bgp-100, external, tag 100
!
IP Route Table for VRF "blue"
'*' denotes best ucast next-hop
'***' denotes best mcast next-hop
'[x/y]' denotes [preference/metric]
'%<string>' in via output denotes VRF <string>
192.168.33.0/32, ubest/mbest: 1/0
  *via 192.168.3.1%red, [20/0], 00:12:34, bgp-100, external, tag 100
192.168.44.0/32, ubest/mbest: 1/0
  *via 192.168.4.1, [1/0], 00:23:16, static
45.45.1.0/24, ubest/mbest: 1/0, attached
  *via 192.168.4.2, Eth1/11, [0/0], 00:25:53, direct
192.168.4.2/32, ubest/mbest: 1/0, attached
  *via 192.168.4.2, Eth1/11, [0/0], 00:25:53, local
192.168.101.101/32, ubest/mbest: 1/0
  *via 192.168.55.1%default, [20/0], 00:07:41, bgp-100, external, tag 100
switch(config)#

```

Configuration Example of Export VRF Default

The following example shows how to allow re-importation of already imported routes that is introduced in the “export vrf default” command to allow VPN imported routes to be re-imported into the default-VRF.

```

vrf context vpn1
  address-family ipv4 unicast
    export vrf default [<prefix-limit>] map <route-map> [allow-vpn]
  address-family ipv6 unicast
    export vrf default [<prefix-limit>] map <route-map> [allow-vpn]

```

Configuration Example of Border-leaf Configuration

- To configure IP prefix list, use the following commands:

```

!IP prefix list configuration
ip prefix-list DEFAULT_ROUTE seq 5 permit 0.0.0.0/0
route-map NO_DEFAULT_ROUTE deny 5
  match ip address prefix-list DEFAULT_ROUTE
route-map NO_DEFAULT_ROUTE permit 10
route-map allow permit 10

!Creation of VRFs, and importing the route maps
vrf context vni100
  vni 100
  ip route 0.0.0.0/0 Null0
  rd auto
  address-family ipv4 unicast
    route-target import 100:200
    route-target import 100:200 evpn
    route-target both auto
    route-target both auto evpn
  import vrf default map allow
  export vrf default map NO_DEFAULT_ROUTE allow-vpn

vrf context vni200
  vni 200
  ip route 0.0.0.0/0 Null0
  rd auto
  address-family ipv4 unicast

```

```

route-target import 100:100
route-target import 100:100 evpn
route-target both auto
route-target both auto evpn
import vrf default map allow
export vrf default map NO_DEFAULT_ROUTE

!BGP configuration
router bgp 100
  address-family ipv4 unicast
    redistribute direct route-map allow
  address-family ipv6 unicast
    redistribute direct route-map allow

  neighbor 192.168.101.101
    remote-as 100
    update-source loopback0
    address-family l2vpn evpn
      send-community extended

  neighbor 192.168.30.2
    remote-as 300
    address-family ipv4 unicast

vrf vni100
  address-family ipv4 unicast
    network 0.0.0.0/0
    advertise l2vpn evpn
    redistribute direct route-map allow

vrf vni200
  address-family ipv4 unicast
    network 0.0.0.0/0
    advertise l2vpn evpn
    redistribute direct route-map allow

```

Verification Example of BGP IPv4 Unicast configuration

```

switch(config-vrf)# show bgp ipv4 unicast 192.168.11.11/32
BGP routing table information for VRF default, address family IPv4 Unicast
BGP routing table entry for 192.168.11.11/32, version 14
Paths: (1 available, best #1)
Flags: (0x08041a) on xmit-list, is in urib, is best urib route, is in HW

  Advertised path-id 1
  Path type: internal, path is valid, is best path, in rib
    Imported from 192.168.3.3:3:192.168.11.11/32 (VRF vni100)
  AS-Path: 150 , path sourced external to AS
    192.168.1.0 (metric 81) from 192.168.101.101 (192.168.101.101)
      Origin incomplete, MED 0, localpref 100, weight 0
      Received label 100
      Extcommunity:
        RT:100:100
        ENCAP:8
        Router MAC:5254.004e.a437
      Originator: 192.168.1.0 Cluster list: 192.168.101.101

  Path-id 1 advertised to peers:
    192.168.30.2

```

Verification Example of BGP IPv4 Unicast configuration per VRF

```

switch(config-vrf)# show bgp vrf vni100 ipv4 unicast 192.168.11.11/32
BGP routing table information for VRF vni100, address family IPv4 Unicast

```

```

BGP routing table entry for 192.168.11.11/32, version 8
Paths: (1 available, best #1)
Flags: (0x08041e) on xmit-list, is in urib, is best urib route, is in HW
      vpn: version 19, (0x100002) on xmit-list

Advertised path-id 1, VPN AF advertised path-id 1
Path type: internal, path is valid, is best path, in rib
          Imported from 192.168.1.0:3:[5]:[0]:[0]:[32]:[192.168.11.11]:[0.0.0.0]/224
AS-Path: 150 , path sourced external to AS
192.168.1.0 (metric 81) from 192.168.101.101 (192.168.101.101)
Origin incomplete, MED 0, localpref 100, weight 0
Received label 100
Extcommunity:
      RT:100:100
      ENCAP:8
      Router MAC:5254.004e.a437
Originator: 192.168.1.0 Cluster list: 192.168.101.101

VRF advertise information:
Path-id 1 not advertised to any peer

VPN AF advertise information:
Path-id 1 not advertised to any peer

```

Verification Examples of BGP IPv6 Unicast configuration

```

switch(config-vrf)# show bgp ipv6 unicast 2001:DB8:1::1/64
BGP routing table information for VRF default, address family IPv6 Unicast
BGP routing table entry for 2001:DB8:1::1/64, version 13
Paths: (1 available, best #1)
Flags: (0x08041a) on xmit-list, is in u6rib, is best u6rib route, is in HW

Advertised path-id 1
Path type: internal, path is valid, is best path
          Imported from 192.168.3.3:3:2001:DB8:1::1/64 (VRF vni100)
AS-Path: 150 , path sourced external to AS
::ffff:192.168.1.0 (metric 81) from 192.168.101.101 (192.168.101.101)
Origin incomplete, MED 0, localpref 100, weight 0
Received label 100
Extcommunity:
      RT:100:100
      ENCAP:8
      Router MAC:5254.004e.a437
Originator: 192.168.1.0 Cluster list: 192.168.101.101

Path-id 1 advertised to peers:
30::2

```

Verification Example of BGP IPv6 Unicast configuration per VRF

```

switch(config-vrf)# show bgp vrf vni100 ipv6 unicast 2001:DB8:1::1/64
BGP routing table information for VRF vni100, address family IPv6 Unicast
BGP routing table entry for 2001:DB8:1::1/128, version 6
Paths: (1 available, best #1)
Flags: (0x08041e) on xmit-list, is in u6rib, is best u6rib route, is in HW
      vpn: version 7, (0x100002) on xmit-list

Advertised path-id 1, VPN AF advertised path-id 1
Path type: internal, path is valid, is best path
          Imported from 192.168.1.0:3:[5]:[0]:[0]:[128]:[2001:DB8:1::1]:[0::]/416
AS-Path: 150 , path sourced external to AS
::ffff:192.168.1.0 (metric 81) from 192.168.101.101 (192.168.101.101)
Origin incomplete, MED 0, localpref 100, weight 0
Received label 100

```

```

Extcommunity:
  RT:100:100
  ENCAP:8
  Router MAC:5254.004e.a437
  Originator: 192.168.1.0 Cluster list: 192.168.101.101

```

```

VRF advertise information:
Path-id 1 not advertised to any peer

```

```

VPN AF advertise information:
Path-id 1 not advertised to any peer

```

Verification Example of IPv4 Route configuration

```

switch(config-if)# show ip route
IP Route Table for VRF "default"
'*' denotes best ucast next-hop
'***' denotes best mcast next-hop
'[x/y]' denotes [preference/metric]
'%<string>' in via output denotes VRF <string>

0.0.0.0/0, ubest/mbest: 1/0
  *via vrf vni100, Null0, [20/0], 1d04h, bgp-100, external, tag 100
192.168.1.0/32, ubest/mbest: 1/0
  *via 192.168.103.1, Eth1/1, [110/81], 1d04h, ospf-100, intra
192.168.2.2/32, ubest/mbest: 1/0
  *via 192.168.103.1, Eth1/1, [110/81], 1d04h, ospf-100, intra
192.168.3.3/32, ubest/mbest: 2/0, attached
  *via 192.168.3.3, Lo0, [0/0], 1d04h, local
  *via 192.168.3.3, Lo0, [0/0], 1d04h, direct
192.168.9.9/32, ubest/mbest: 1/0, attached
  *via 192.168.9.9%vni100, Lo9, [20/0], 1d03h, bgp-100, external, tag 100
192.168.10.0/24, ubest/mbest: 1/0
  *via 192.168.1.0, [200/0], 1d04h, bgp-100, internal, tag 100 (evpn) segid: 100 tunnelid:
  0x1010101 encap: VXLAN
192.168.11.11/32, ubest/mbest: 1/0
  *via 192.168.1.0, [200/0], 1d04h, bgp-100, internal, tag 150 (evpn) segid: 100 tunnelid:
  0x1010101 encap: VXLAN
192.168.20.0/24, ubest/mbest: 1/0
  *via 192.168.2.2, [200/0], 1d04h, bgp-100, internal, tag 100 (evpn) segid: 200 tunnelid:
  0x2020202 encap: VXLAN
192.168.22.22/32, ubest/mbest: 1/0
  *via 192.168.2.2, [200/0], 1d04h, bgp-100, internal, tag 250 (evpn) segid: 200 tunnelid:
  0x2020202 encap: VXLAN
192.168.30.0/24, ubest/mbest: 1/0, attached
  *via 192.168.30.1, Eth1/2, [0/0], 1d04h, direct
192.168.30.1/32, ubest/mbest: 1/0, attached
  *via 192.168.30.1, Eth1/2, [0/0], 1d04h, local
192.168.33.0/32, ubest/mbest: 1/0
  *via 192.168.30.2, [20/0], 1d04h, bgp-100, external, tag 300
192.168.100.0/24, ubest/mbest: 1/0, attached
  *via 192.168.100.3%vni100, Vlan100, [20/0], 1d04h, bgp-100, external, tag 100
192.168.101.0/24, ubest/mbest: 1/0
  *via 192.168.103.1, Eth1/1, [110/80], 1d04h, ospf-100, intra
192.168.101.101/32, ubest/mbest: 1/0
  *via 192.168.103.1, Eth1/1, [110/41], 1d04h, ospf-100, intra
192.168.102.0/24, ubest/mbest: 1/0
  *via 192.168.103.1, Eth1/1, [110/80], 1d04h, ospf-100, intra
192.168.103.0/24, ubest/mbest: 1/0, attached
  *via 192.168.103.2, Eth1/1, [0/0], 1d04h, direct
192.168.103.2/32, ubest/mbest: 1/0, attached

```

Verification Example of IPv6 Route configuration

```

switch(config-if)# show ipv6 route
IPv6 Routing Table for VRF "default"
'*' denotes best ucast next-hop
'***' denotes best mcast next-hop
'[x/y]' denotes [preference/metric]
'%<string>' in via output denotes VRF <string>

::/0, ubest/mbest: 1/0
    *via vrf vni100, Null0, [20/0], 1d04h, bgp-100, external, tag 100
2001:DB8:1::/64, ubest/mbest: 1/0, attached
    *via 2001:DB8:1::1, Eth1/1, [0/0], 1d04h, direct
2001:DB8:2:2::/128, ubest/mbest: 1/0
    *via 2001:DB8:103:1::1, Eth1/1, [110/81], 1d04h, ospf-100, intra
2001:DB8:3:3::/128, ubest/mbest: 2/0, attached
    *via 2001:DB8:3:3::3, Lo0, [0/0], 1d04h, local
    *via 2001:DB8:3:3::3, Lo0, [0/0], 1d04h, direct
2001:DB8:9:9::/128, ubest/mbest: 1/0, attached
    *via 2001:DB8:9:9::9%vni100, Lo9, [20/0], 1d03h, bgp-100, external, tag 100
2001:DB8:10::/64, ubest/mbest: 1/0
    *via 2001:DB8:1::, [200/0], 1d04h, bgp-100, internal, tag 100 (evpn) segid: 100 tunnelid:
    0x1010101 encap: VXLAN
2001:DB8:11:11::/128, ubest/mbest: 1/0
    *via 2001:DB8:1::, [200/0], 1d04h, bgp-100, internal, tag 150 (evpn) segid: 100 tunnelid:
    0x1010101 encap: VXLAN
2001:DB8:20::/64, ubest/mbest: 1/0
    *via 2001:DB8:2:2::2, [200/0], 1d04h, bgp-100, internal, tag 100 (evpn) segid: 200
    tunnelid: 0x2020202 encap: VXLAN
2001:DB8:22:22::/128, ubest/mbest: 1/0
    *via 2001:DB8:2:2::2, [200/0], 1d04h, bgp-100, internal, tag 250 (evpn) segid: 200
    tunnelid: 0x2020202 encap: VXLAN
2001:DB8:30::/64, ubest/mbest: 1/0, attached
    *via 2001:DB8:30::1, Eth1/2, [0/0], 1d04h, direct
2001:DB8:30::1/128, ubest/mbest: 1/0

```

Additional References

For additional information related to implementing virtualization, see the following sections:

Related Documents for VRFs

Related Topic	Document Title
VRFs	<p><i>Cisco Nexus 9000 Series NX-OS Fundamentals Configuration Guide</i></p> <p><i>Cisco Nexus 9000 Series NX-OS System Management Configuration Guide</i></p>

Standards

Standards	Title
No new or modified standards are supported by this feature, and support for existing standards has not been modified by this feature.	—



CHAPTER 16

Managing the Unicast RIB and FIB

This chapter contains the following sections:

- [About the Unicast RIB and FIB, on page 493](#)
- [Guidelines and Limitations for the Unicast RIB, on page 494](#)
- [Managing the Unicast RIB and FIB, on page 495](#)
- [Verifying the Unicast RIB and FIB Configuration, on page 514](#)
- [Additional References, on page 514](#)

About the Unicast RIB and FIB

The unicast Routing Information Base (IPv4 RIB and IPv6 RIB) and Forwarding Information Base (FIB) are part of the Cisco NX-OS forwarding architecture, as shown in the following figure.

Figure 42: Cisco NX-OS Forwarding Architecture

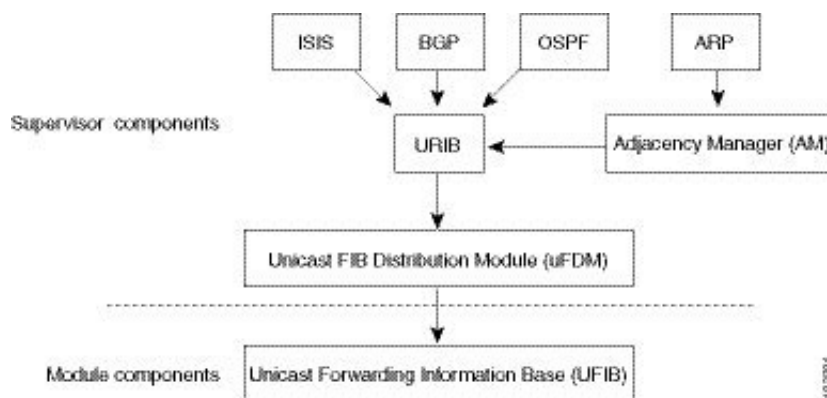

The unicast RIB exists on the active supervisor. It maintains the routing table with directly connected routes, static routes, and routes learned from dynamic unicast routing protocols. The unicast RIB also collects adjacency information from sources such as the Address Resolution Protocol (ARP). The unicast RIB determines the best next hop for a given route and populates the unicast forwarding information bases (FIBs) on the modules by using the services of the unicast FIB distribution module (FDM).

Each dynamic routing protocol must update the unicast RIB for any route that has timed out. The unicast RIB then deletes that route and recalculates the best next hop for that route (if an alternate path is available).

Layer 3 Consistency Checker

In rare instances, an inconsistency can occur between the unicast RIB and the FIB on each module. Cisco NX-OS supports the Layer 3 consistency checker. This feature detects inconsistencies between the unicast IPv4 RIB on the supervisor module and the FIB on each interface module. Inconsistencies include the following:

- Missing prefix
- Extra prefix
- Wrong next-hop address
- Incorrect Layer 2 rewrite string in the ARP or neighbor discovery (ND) cache

The Layer 3 consistency checker compares the FIB entries to the latest adjacency information from the Adjacency Manager (AM) and logs any inconsistencies. The consistency checker then compares the unicast RIB prefixes to the module FIB and logs any inconsistencies. See the [Triggering the Layer 3 Consistency Checker](#) section.

You can then manually clear any inconsistencies. See the [Clearing Forwarding Information in the FIB](#) section.

When more routes are learned exceeding the hardware limit, the **show consistency-checker forwarding ipv4** command is run, consistency may still show as pass. The same is true when it is transitioning from an inconsistent state to a consistent state. It may show as a failure. Until and unless the **test forwarding ipv4 inconsistency route** command is run again, it doesn't leave this state. This is an expected behavior.

Guidelines and Limitations for the Unicast RIB

The following guidelines and limitations apply to the URIB or U6RIB:

- In a virtual domain context (VDC), when modifying memory resource limits for the IPv4 or IPv6 unicast route, the modified limits do not take effect immediately.

You must issue the **copy running-config startup-config** command followed by the **reload** command to activate the modified limits

For example, if you issue either of the following commands, you will need to issue **copy running-config startup-config**, then reload the switch an extra time to activate the new setting:

- **limit-resource u4route-mem**
- **limit-resource u6route-mem**



Note If “feature pim” is configured for limit-resource, ensure that the value of **limit-resource u4route-mem** plus **limit-resource u6route-mem** is ≤ 1024 MB (1GB).

- Beginning with Cisco NX-OS Release 10.3(1)F, Unicast consistency checker is supported on Cisco Nexus 9808 platform switches.
 - Beginning with Cisco NX-OS Release 10.4(1)F, Unicast consistency checker is supported on Cisco Nexus X98900CD-A and X9836DM-A line cards with Cisco Nexus 9808 switches.

- Beginning with Cisco NX-OS Release 10.4(1)F, Unicast consistency checker is supported on Cisco Nexus 9804 platform switches, and Cisco Nexus X98900CD-A and X9836DM-A line cards.
- Beginning with Cisco NX-OS Release 10.5(1)F, the Layer 3 ECMP Dynamic Load Balancing (DLB) feature provides support to efficiently load balance traffic, depending on the current state of utilization of the outgoing links.

Managing the Unicast RIB and FIB



Note If you are familiar with the Cisco IOS CLI, be aware that the Cisco NX-OS commands for this feature might differ from the Cisco IOS commands that you would use.

Displaying Module FIB Information

To display the FIB information on a module, use the following commands in any mode:

Command	Purpose
show forwarding {ipv4 ipv6} adjacency module <i>slot</i> Example: switch# show forwarding ipv6 adjacency module 2	Displays the adjacency information for IPv4 or IPv6.
show forwarding {ipv4 ipv6} route module slot Example: switch# show forwarding ipv6 route module 2	Displays the route table for IPv4 or IPv6.

Configuring Load Sharing in the Unicast FIB

Dynamic routing protocols such as Open Shortest Path First (OSPF) support load balancing with equal-cost multipath (ECMP). The routing protocol determines its best routes based on the metrics configured for the protocol and installs up to the protocol-configured maximum paths in the unicast RIB. The unicast RIB compares the administrative distances of all routing protocol paths in the RIB and selects a best path set from all of the path sets installed by the routing protocols. The unicast RIB installs this best path set into the FIB for use by the forwarding plane.

The forwarding plane uses a load-sharing algorithm to select one of the installed paths in the FIB to use for a given data packet.



Note Load sharing uses the same path for all packets in a given flow. A flow is defined by the load-sharing method that you configure. For example, if you configure source-destination load sharing, then all packets with the same source IP address and destination IP address pair follow the same path.

To configure the unicast FIB load-sharing algorithm, use the following command in global configuration mode:

SUMMARY STEPS

1. **ip load-sharing address** {destination port destination | source-destination [port source-destination] | source } [exclude-l3-proto] hardware lb-keyshift *value* lb-2nd-heir-keyshift *value* [universal-id *seed*] [rotate *rotate*] [concatenation]
2. (Optional) **show ip load-sharing**
3. (Optional) **show routing hash** source-addr dest-addr [source-port dest-port] [vrf vrf-name]

DETAILED STEPS

	Command or Action	Purpose
Step 1	<p>ip load-sharing address {destination port destination source-destination [port source-destination] source } [exclude-l3-proto] hardware lb-keyshift <i>value</i> lb-2nd-heir-keyshift <i>value</i> [universal-id <i>seed</i>] [rotate <i>rotate</i>] [concatenation]</p> <p>Example:</p> <pre>ip load-sharing address source-destination port source-destination hardware lb-keyshift 1 lb-2nd-hier-keyshift 10</pre>	<p>Configures the unicast FIB load-sharing algorithm for data traffic.</p> <p>Note On Cisco Nexus 9808/9804 switches, only address source-destination port source-destination option is supported during ip load-sharing address configuration.</p> <p>Beginning with Cisco NX-OS Release 10.3(3)F, the hardware option is added to support the following parameters in the IHB_ECMP_LB_KEY_CFG tables only on Cisco Nexus 9600-R/RX line cards:</p> <ul style="list-style-type: none"> • lb-keyshift: Sets the ECMP_LB_KEY_SHIFT value for load balancing. The range is 1-10. • lb-2nd-hier-keyshift: Sets the ECMP_2ND_HIER_LB_KEY_SHIFT value for load balancing. The range is 1-10. <p>Beginning with Cisco NX-OS Release 10.5(1)F, the exclude-l3-proto option has been introduced. This option allows the exclusion of the IP protocol from ECMP hashing during next-hop selection on Cisco Nexus 9300-GX2 Series switches.</p> <p>The following options are available for all IP load sharing configurations:</p> <ul style="list-style-type: none"> • The universal-id option sets the random seed for the hash algorithm and shifts the flow from one link to another. <p>You do not need to configure the universal ID. Cisco NX-OS chooses the universal ID if you do not configure it. The <i>universal-id</i> range is from 1 to 4294967295.</p> <ul style="list-style-type: none"> • The rotate option causes the hash algorithm to rotate the link picking selection so that it does not continually

	Command or Action	Purpose
		<p>choose the same link across all nodes in the network. It does so by influencing the bit pattern for the hash algorithm. This option shifts the flow from one link to another and load balances the already load-balanced (polarized) traffic from the first ECMP level across multiple links.</p> <p>If you specify a <i>rotate</i> value, the 64-bit stream is interpreted starting from that bit position in a cyclic rotation. The <i>rotate</i> range is from 1 to 63, and the default is 32.</p> <p>Note With multi-tier Layer 3 topology, polarization is possible. To avoid polarization, use a different rotate bit at each tier of the topology.</p> <p>Note To configure a rotation value for port channels, use the port-channel load-balance src-dst ip-l4port rotate rotate command. For more information on this command, see the <i>Cisco Nexus 9000 Series NX-OS Interfaces Configuration Guide</i>.</p> <ul style="list-style-type: none"> • The concatenation option ties together the hash tag values for ECMP and the hash tag values for port channels in order to use a stronger 64-bit hash. If you do not use this option, you can control ECMP load-balancing and port-channel load-balancing independently. The default is disabled.
<p>Step 2</p>	<p>(Optional) show ip load-sharing</p> <p>Example:</p> <pre>switch(config)# show ip load-sharing address source-destination</pre>	<p>Displays the unicast FIB load-sharing algorithm for data traffic.</p>
<p>Step 3</p>	<p>(Optional) show routing hash source-addr dest-addr [source-port dest-port] [vrf vrf-name]</p> <p>Example:</p> <pre>switch(config)# show routing hash 192.0.2.1 10.0.0.1</pre>	<p>Displays the route that the unicast RIB and unicast FIB use for a source and destination address pair. The source address and destination address format is x.x.x.x. The source port and destination port range is from 1 to 65535. The VRF name can be any case-sensitive, alphanumeric string up to 64 characters.</p>

Example

This example shows how to display the route selected for a source/destination pair:

```
switch# show routing hash 10.0.0.5 192.0.0.2
Load-share parameters used for software forwarding:
```

```
load-share mode: address source-destination port source-destination
Universal-id seed: 0xe05e2e85
Hash for VRF "default"
Hashing to path *172.0.0.2 (hash: 0x0e), for route:
```

This example shows the output of **show ip load-sharing** command:

```
switch(config)# show ip load-sharing
IPv4/IPv6 ECMP load sharing:
Universal-id (Random Seed): 1913447906
Load-share mode : address source
Exclude L3 proto from ECMP hashing : Enabled
Rotate: 32
switch(config)#
```

Dynamic Load Balancing

About Dynamic Load Balancing

Dynamic Load Balancing (DLB) refers to a networking technique used to distribute traffic across multiple paths or links that have the same cost in terms of routing metrics. This is done at the IP layer (Layer 3 in the OSI model) and is often implemented in modern networking hardware such as Nexus 9000 series Cloud Scale switches from Cisco NX-OS Release 10.5(1)F.

ECMP is used to increase the bandwidth available to applications by allowing multiple parallel paths for traffic to flow between any two points in a network. When a router must forward a packet to a destination for which it has multiple equal-cost paths, it uses a hashing algorithm to decide which path to use for that packet. The algorithm typically takes into consideration parameters such as the source and destination IP addresses, source and destination port numbers, and sometimes even the protocol type.

In traditional load balancing, the path does not change over time unless there is a change in the network topology or manual reconfiguration by a network administrator. In contrast, Layer 3 ECMP Dynamic Load Balancing implies that the selection of the path can change according to the current state of the network. The router or switch can monitor the traffic load on each path and select a path with least link utilization to better distribute the traffic across all available paths. Thus, the Layer 3 ECMP DLB on Nexus 9000 switches allows for the efficient distribution of traffic across multiple equal-cost paths in the network.

The Layer 3 ECMP DLB is supported on RDMA over Ethernet (RoCE) with leaf-and-spine architecture that are especially used in back-end AI/ML training networks. A fabric with DLB when combined with PFC along with ECN provides an optimal network behavior by way of better utilization, low latency, and loss-less fabric.

Features

- Faster convergence in case of link or node failures
- Maximize the utilization of available network paths
- Provide redundancy in case of link or node failures
- Minimize congestion by evenly spreading traffic across all paths
- Increase overall network performance without needing additional or specialized infrastructure

Topology

The DLB topology is useful in Artificial Intelligence (AI) and Machine Learning (ML) training networks. These networks use the spine-leaf architecture shown in the image. Here, the AI and ML hosts (server) are connected to Interface-1 (Intf-1) and Interface-2 (Intf-2) of the leaf switches. Intf-3 and Intf-4 of the leaf switches are connected to two spines, Spine 1 and Spine 2. While synchronizing data, for example, training data, across the AI and ML hosts, the training data gets transferred through the spine-leaf fabric among all the hosts.

Figure 43: DLB Topology

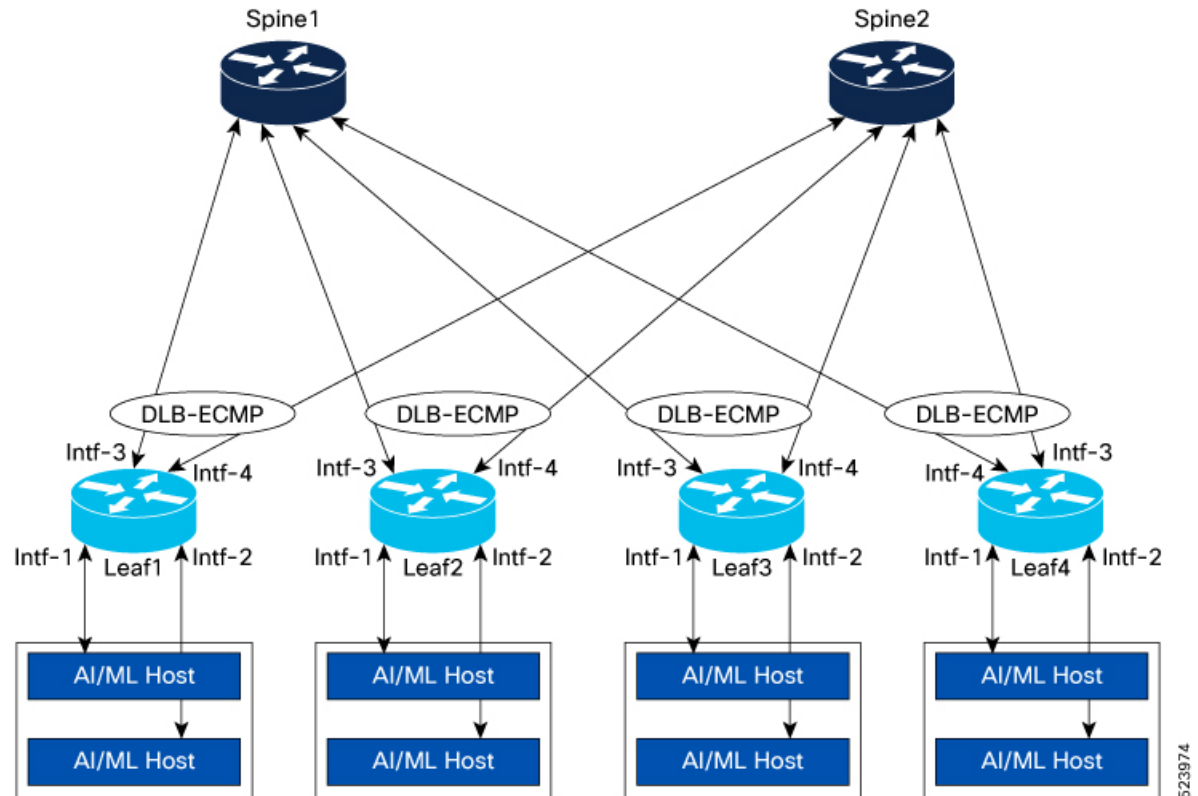

As leaf switches are connected to spines with more than one link, ECMP is used to load-share traffic across multiple links. Unlike traditional networks, in the AI and ML training networks, the number of traffic flows (having unique 5-Tuple IP fields) are fewer. With fewer flows, the traditional ECMP can lead to polarization issues (suboptimal use of redundant paths), leading to over-subscription on few links or interfaces. Over-subscription of few links can result in traffic loss due to under or no utilization of the remaining links despite their presence in the architecture.

The ECMP DLB feature overcomes the no utilization or under utilization of links by ensuring that all the links are used properly. If necessary, the utilization is also customizable. When DLB is enabled on all the ports that are part of an ECMP group, a link with the least Tx link utilization is chosen among the available links for every new flow. In the above image, DLB is enabled on Intf-3 and Intf-4. If intf-3 is fully used and a new flow is received, intf-4 is picked. In traditional ECMP, the possibility is that Intf-3 gets picked even though it is oversubscribed.

ECMP DLB also supports static pinning, where the user can pin traffic coming from a certain source port to be always sent on a specific DLB enabled egress port. In the image, for traffic taking a DLB ECMP group in

which Intf-3 and Intf-4 are members. User can pin traffic from Intf-1 to always take Intf-3 and from Intf-2 to always take Intf-4.

Key Concepts of Dynamic Load Balancing

Fast Link Failover

Fast link failover in the context of Layer 3 ECMP load balancing on Nexus 9000 switches is a feature that allows the network to quickly respond to and recover from physical link failures. When a link used in an ECMP group fails, fast link failover ensures that traffic is immediately redirected to the remaining operational links without waiting for traditional routing protocol convergence times.

For the Layer 3 ECMP DLB feature running on Nexus 9000 switches, the link failover is detected by the hardware, and new link will be selected from the remaining links automatically. As this is done at the hardware layer, this provides faster convergence.

Dynamic Rate Estimator

A Dynamic Rate Estimator (DRE) is implemented in the hardware for measuring the current link utilization. The role of the DRE withing DLB is to provide real-time estimation of the traffic rate on various links. This real-time analysis allows the switch to make more informed decisions when distributing traffic to ensure that no single path becomes over saturated. When a new flow starts, the DLB uses the DRE metric to determine the least utilized path within the multiple paths in a DLB ECMP Group.

At any point in time, a DLB-enabled interface can be at one of the DRE levels from level-1 to level-7 based on the utilization of the link and configured DRE thresholds. Level-1 indicates lowest utilization and level-7 the highest utilization. During the DLB decision, always a link with lowest DRE level is selected. If more than one link is available with the same lowest DRE level, one of the links among them is selected randomly. For more information, see [Calculate Link Utilization Level](#).

Modes

Layer 3 ECMP Dynamic Load Balancing supports any one of the following modes in global configuration:

- Flowlet Load Balancing (FLB) – In this mode, load balancing is done at flowlet level based on DRE metrics. This is the default mode.
- Per-packet Load Balancing (PLB) – In this mode, the load balancing decision is taken at a per-packet level instead of the flowlet level.

FLB

Flowlets are bursts of packets from a flow, identified by their 5-tuple (or selected fields from the packet), that are separated by large enough gaps such that they can be routed independently without causing reordering.

The flowlet is a unit of traffic used when the DLB works in flowlet mode. For each flowlet, the best outgoing port is picked by the hardware, which has the least Tx utilization, indicated by a per-port DRE. If utilization is the same for all ports, one of the ports is randomly selected.

Once a port is selected for a flowlet, the same port is used for all subsequent packets from that flow. A new port selection is triggered only when there is an inter-packet gap in the flowlet that is greater than the configured flowlet-aging time or when the currently utilized port goes down.

PLB

Per-packet Load Balancing can be used for scenarios where the end points (for example, Smart NICs) allow for packet re-ordering. This mode distributes traffic across the available links in a DLB ECMP and helps spread traffic out, reducing network congestion. For each packet in a flow, a new output port selection happens. So, the packets from the same flow can be sent across multiple paths causing packet re-ordering. The port selection process uses DRE, that is, port with the least DRE metric is selected for every packet. If DRE is the same for all ports, one of the ports is randomly selected.

Static Pinning

Static pinning is supported on DLB. In static pinning, a source port is pinned to a destination port that is part of a DLB enabled ECMP group. All the traffic from this source port is sent to the pinned destination port if this port is part of the DLB ECMP group used for this flow. Front panel ports (including breakout ports) can be used as static pinning source interface. Destination interface must be part of the DLB interfaces list.

When static pinning is enabled, static pinning overrides the DLB DRE-based port selection.

When a DLB port is used as destination port in static pinning, this port cannot be removed from the dlb-interface list unless the static pinning configuration for that port is removed.



Note You can enable either static pinning or PLB mode. You cannot enable both.

Guidelines and Limitations for Dynamic Load Balancing

The guidelines and limitations for Layer 3 Dynamic Load Balancing are categorized as follows and listed under these sections:

- [ECMP group](#)
- [Feature support](#)
- [Ports](#)
- [DLB parameters](#)

ECMP group

- The decision to enable DLB should be done during ECMP group creation when these three conditions are met:
 - All the members of an ECMP group are in the DLB-enabled interface list. If an ECMP group has one or more members that are not in the DLB interface list, regular ECMP will be used for that ECMP group.
 - The members of an ECMP group can only be L3 interfaces. Break-out ports, sub interfaces, SVI, and port-channels cannot be members of a DLB ECMP group.
 - ECMP is not weighted ECMP or Resilient ECMP.
- Resilient ECMP and DLB features cannot be enabled together. For more information about resilient ECMP, refer to [Cisco Nexus 9000 Series NX-OS Interfaces Configuration Guide](#).
- For weighted ECMP groups, DLB is not applicable. For more information about weighted ECMP, refer to [Cisco Nexus 9000 Series NX-OS Unicast Routing Configuration Guide](#).

- The show routing hash command does not work for routes using DLB ECMP Groups because, when DLB enabled, the port selection is done dynamically based on the link utilization instead of using static hash.
- In cases where the DLB ECMP scale is reached or if due to any condition DLB cannot be enabled, the regular ECMP without DLB will be in use.



Note When one of the member ports in a DLB-enabled ECMP group goes down, the port will be immediately taken out for sending traffic by Hardware. This ensures that there is negligible traffic loss in link failure conditions.

Feature support

- This feature is supported only on
 - Layer 3 physical interfaces,
 - IP routed fabrics and VXLAN fabrics, and
 - 9300-FX3, GX, GX2, and HX TOR platforms.
- This feature is not supported on TORs that have line-card expansion modules (LEM) and N9K-C9408.
- Egress Access-list policies, Egress QOS policies and TX SPAN configured on the egress interfaces are not applied for flows using ECMP DLB.
- MPLS/GRE tunnel do not use DLB ECMP, they fall back to regular ECMP.
- When this feature is used, Cisco recommends using the system pic-core option, especially when the DLB ECMP scale used is high.
- DLB is not applicable to traffic flows to which policy-based routing (PBR) logic is applied. These flows use the regular ECMP feature.
- MTU should be configured on all DLB-enabled interfaces based on the maximum size of the packets used in the DLB flows. Otherwise, traffic is dropped on egress interfaces as output drops.
- Only Unicast IPv4 and IPv6 traffic is supported.

Ports

- Breakout ports, port-channels, SVIs, port-channel members, or sub-interfaces cannot be part of DLB-enabled interface list.
- A maximum of 63 physical ports can be part of the DLB interface list.

DLB parameters

This section lists the guidelines for DLB-related parameters such as MAC, Aging, DRE Thresholds, Mode, and Static Pinning.

- A switch reload is required when a DLB interface list is configured for the first time or modified for the configuration to take effect.

- Choose the flowlet-aging time based on the round-trip time in the fabric; otherwise, the flows can be re-ordered.
- All the DLB-related parameters under DLB configuration are programmed in hardware only when there is a valid applied DLB interface list.
- When any one of the MAC, Aging, Mode, or DRE Threshold configurations are removed, all parameters are set to default values.
- After adding a port to the DLB interface list, if the port is either modified to be a breakout port or added to be part of a PO or a sub interface is created on this interface, DLB will no longer be enabled for ECMP groups that contain the port. The user should remove the port from the DLB interface list.
- Any change to the DRE thresholds can have a momentary traffic impact on DLB-enabled flows. This is a disruptive trigger.
- The DLB MAC configuration should be the same on all the nodes in the fabric. If the DLB MAC configuration is changed on a switch without changing this in the connected nodes in the fabric receiving these flows, the traffic is dropped.
- Static pinning and Per-packet DLB modes cannot be supported at the same time.
- Breakout ports can be part of the static pinning source interfaces. However, sub-interfaces and port-channels cannot be part of the static pinning source interfaces.

Configure Dynamic Load Balancing

To configure Layer 3 Dynamic Load Balancing, use the following commands in the **hardware profile dlb** sub mode.

SUMMARY STEPS

1. **configure terminal**
2. **hardware profile dlb**
3. **dlb-interface** *<interface_range>*
4. (Optional) **dre-thresholds** [**level-1** *percentage_1* | **level-2** *percentage_2* | **level-3** *percentage_3* | **level-4** *percentage_4* | **level-5** *percentage_5* | **level-6** *percentage_6* | **level-7** *percentage_7*]
5. (Optional) **flowlet-aging** *usec*
6. (Optional) **mac-address** *macaddr*
7. (Optional) **mode** [**flowlet** | **per-packet**]
8. (Optional) **static-pinning**
9. (Optional) **source** *source physical interface* **destination** *destination physical interface*

DETAILED STEPS

	Command or Action	Purpose
Step 1	configure terminal Example: switch# configure terminal	Enters global configuration mode.

	Command or Action	Purpose
Step 2	hardware profile dlb Example: <pre>switch(config)# hardware profile dlb</pre>	Enters the hardware profile dynamic load balancing mode.
Step 3	dlb-interface <interface_range> Example: <pre>switch(config-dlb)# dlb-interface Eth1/5,Eth1/7,Eth1/17,Eth1/21,Eth1/26</pre>	<p>Specifies the list of interfaces for which DLB will be enabled. This list cannot be changed dynamically, and requires switch reload for the interface list to be effective. Add comma-separated interfaces.</p> <p>Note</p> <ul style="list-style-type: none"> Any change in interface list requires reload for the configuration to be effective. To verify the current applied list, use the show hardware profile dlb command. Incremental addition or deletion to the interface-list is not supported. The config gets replaced with the new interface list provided.
Step 4	(Optional) dre-thresholds [level-1 percentage_1 level-2 percentage_2 level-3 percentage_3 level-4 percentage_4 level-5 percentage_5 level-6 percentage_6 level-7 percentage_7] Example: <pre>switch(config-dlb)# dre-thresholds level-1 15 level-2 20 level-3 30 level-4 15 level-5 10 level-6 5 level-7 5</pre>	<p>Defines DRE levels from level 1 to level 7. The value configured per level is the percentage utilization range of port bandwidth from the previous level. The total of all the levels specified must be equal to 100. If you do not configure the DRE threshold levels, the following default values are used: 30, 20, 15, 10, 10, 10, and 5.</p> <p>For more information about DRE level link utilization, see Calculate Link Utilization Level.</p>
Step 5	(Optional) flowlet-aging usec Example: <pre>switch(config-dlb)# flowlet-aging 600</pre>	<p>Configures flowlet aging time. The value is in usecs. The default is 500 usecs and the maximum value is 2 seconds or 2000000 usecs.</p> <p>Note Ensure that you choose the flowlet aging time with utmost care, else the flows can get re-ordered.</p>
Step 6	(Optional) mac-address macaddr Example: <pre>switch(config-dlb)# mac-address aa:bb:cc:dd:ee:ff</pre>	<p>Configures DLB MAC address. This address is used as next-hop MAC address for all the flows using DLB. This DLB MAC is used to re-write the Destination MAC for DLB flows instead of the learned next-hop MAC address for the egress interfaces.</p> <p>The following guidelines and limitations apply:</p> <ul style="list-style-type: none"> If you do not configure this command, the default DLB MAC address used during the feature initialization is used as the default DMAC, that is, 00:CC:CC:CC:CC:CC.

	Command or Action	Purpose
		<ul style="list-style-type: none"> • If you configure the DLB MAC address, then the default MAC is replaced with the newly configurable MAC address. • All packets received on the switch with this DLB MAC as destination MAC are treated as routed packets. • When applying this configuration, ensure that all other nodes in the fabric are configured with the same DLB MAC. • If there is no dlb-interface list applied, then the DLB MAC cannot be used as additional router MAC. • Broadcast and multicast MAC addresses cannot be configured as DLB MAC address.
Step 7	(Optional) mode [flowlet per-packet] Example: <pre>switch(config-dlb)# mode flowlet</pre>	Enables either flowlet or per-packet DLB mode. The default mode is flowlet. Note For per-packet mode, static pinning cannot be enabled.
Step 8	(Optional) static-pinning Example: <pre>switch(config-dlb)# static-pinning</pre>	Configures static pinning feature. Note For static pinning, per-packet mode cannot be enabled.
Step 9	(Optional) source <i>source physical interface</i> destination <i>destination physical interface</i> Example: <pre>switch(config-dlb-static-pinning)# source ethernet 1/1 destination ethernet 1/2</pre>	Configures source and destination interfaces for static pinning. However, these should be physical interfaces only, that is, the front panel Ethernet interfaces. SVI, port-channels, or sub-interface cannot be source or destination interface. The following guidelines and limitations apply: <ul style="list-style-type: none"> • The destination interface should be a part of the DLB applied or configured interface-list, but a source interface cannot be a part of this list. • If the same source interface is used for two configurations, then the first destination interface gets replaced with the second destination interface, as the source interface is the same. • Break-out ports can be configured as source interface. • When no breakout or break-out operations are performed on the ports, the user should update the DLB or static pinning configuration. • An interface cannot be deleted from the DLB interface list if it is configured as a destination interface in static pinning. To delete it, first remove the static pinning

	Command or Action	Purpose
		configuration and then delete the interface from the DLB interface list.

Calculate Link Utilization Level

The link utilization at each level is calculated as follows:

- Current Level Range Start: Sum of % values specified for all the previous levels.
- Current Level Range End: Current Level Range Start + Current Level value.

For example:

Level-1: 30, Level-2: 20, Level-3: 15, Level-4: 10, Level-5: 10, Level-6: 10, Level-7: 5.

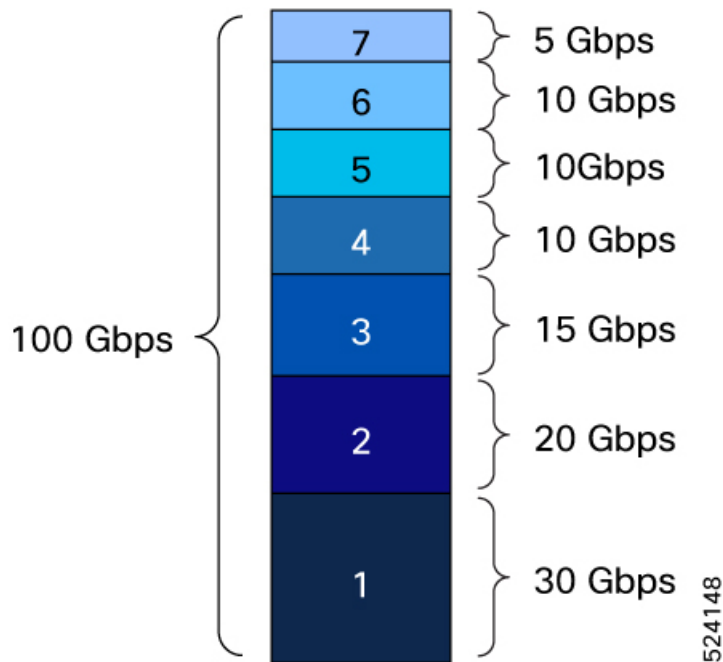

- Level-5 Range Start: 75% (30 + 20 + 15 + 10)
- Level-5 Range End: 85% (75 + 10)

Guidelines for DRE Threshold Levels

A few guidelines and limitations related to [Dynamic Rate Estimator](#) (DRE) threshold levels are as follows:

- The above-mentioned logic applies to a scenario when any level is zero (0). You add up the levels, then that level will have the same range as the previous level with the non-zero value.

For example,

Level-1: 30, Level-2: 0, Level-3: 35, Level-4: 10, Level-5: 10, Level-6: 10, Level-7: 5.

- Level-2 Range: Level 2 will be the same as Level-1, that is 30%.

- If all previous values are zero, the current level will be the first non-zero level specified.

For example,

Level-1: 0, Level-2: 0, Level-3: 0, Level-4: 0, Level-5: 50, Level-6: 30, Level-7: 20.

- In this case, the starting level for link utilization will be Level-5.

- Specify all the levels. If a few levels are not specified, they will be considered as zero.

For example,

Level-1: 50, Level-2: 0, Level-3: 0, Level-4: 0, Level-5: 0, Level-6: 30, Level-7: 20

- Levels 2, 3, 4, and 5 are considered zero.

Configuration Example for Dynamic Load Balancing

```
switch# configure terminal
switch(config)# hardware profile dlb
switch(config-dlb)# dlb-interface Eth1/5,Eth1/7,Eth1/17,Eth1/21,Eth1/26 switch(config-dlb)#
dre-thresholds level-1 15 level-2 20 level-3 30 level-4 15 level-5 10 level-6 5 level-7 5
switch(config-dlb)# flowlet-aging 600 switch(config-dlb)# mac-address aa:bb:cc:dd:ee:ff
switch(config-dlb)# mode flowlet switch(config-dlb)# static-pinning
switch(config-dlb-static-pinning)# source ethernet 1/1 destination ethernet 1/1
```

Verify Dynamic Load Balancing

Execute one of the following commands to view Dynamic Load Balancing configuration information.

Command	Purpose
show hardware profile dlb	<p>Displays the DLB configuration.</p> <p>Note</p> <ul style="list-style-type: none"> • Configured Interface-list — Provides the list of current interfaces configured using the Command Line Interface. After reload, the same list is populated in the applied interface-list. • Applied Interface-list — Provides the list of interfaces that are being used currently for DLB.
show system config reload-pending	<p>Displays the reload-pending configuration. In the case of DLB, this shows the interface-list pending to be applied if there was any change to the interface list configuration.</p>



Note The **show routing hash** command does not work for routes that use DLB ECMP Groups.

Show command output

A sample output of the **show hardware profile dlb** command is as follows:

```
switch# show hardware profile dlb
DLB Configurations:
=====

Enabled:                yes
Mode:                   flowlet
Mac-address:            aa:bb:cc:dd:ee:ff
Flowlet aging time:    600 usec(s)
DRE-thresholds:
    Level-1:15
    Level-2:20
    Level-3:30
    Level-4:15
    Level-5:10
    Level-6:5
    Level-7:5
DLB interface list:
-----

Configured Interface-list (size: 5):
    Eth1/5,Eth1/7,Eth1/17,Eth1/21,Eth1/26

Applied interface-list (size: 5):
    Eth1/5,Eth1/7,Eth1/17,Eth1/21,Eth1/26

Static-pinning enabled: yes

DLB static-pinning pairs:
-----

static-pinning pairs (1):
    source: Eth1/1    dest: Eth1/5
```

A sample output of the **show system config reload-pending** command is as follows:

```
switch# show system config reload-pending

Following config commands require copy r s + reload :
=====
0      hardware profile dlb ; dlb-interface Eth1/5,Eth1/7,Eth1/17,Eth1/21,Eth1/26
=====
```

Troubleshoot Dynamic Load Balancing

Consistency checker can be used to troubleshoot the routes using DLB ECMP as follows:

- Global Consistency Checker
 - **test consistency-checker forwarding ipv4 unicast**
 - **show consistency-checker forwarding ipv4 unicast**

Sample output

```
Leaf1# test consistency-checker forwarding ipv4 unicast
Consistency check started.
Leaf1#
Leaf1#
```



```
Leaf1# show consistency-checker forwarding ipv4 unicast
IPV4 Consistency check : table_id(0x1)
Execution time : 28 ms ()
No inconsistent adjacencies.
No inconsistent routes.
Consistency-Checker: PASS for ALL
```

• Single Route Consistency Checker

- **show consistency-checker forwarding single-route ipv4 *ipv4 address* vrf *vrf***

Sample output

```
Leaf1# show consistency-checker forwarding single-route ipv4 64.60.60.0/24 vrf default

Consistency checker passed for 64.60.60.0/24
Leaf1#
```

Displaying Routing and Adjacency Information

To display routing and adjacency information, use the following commands in any mode:

Command	Purpose
<p>show {ip ipv6} route [<i>route-type</i> interface <i>interface-type number</i> next-hop]</p> <p>switch# show ip route</p>	<p>Displays the unicast route table. The <i>route-type</i> argument can be a single route prefix or a direct, static, or dynamic route protocol. Use the ? command to see the supported interfaces.</p>
<p>show {ip ipv6} adjacency [<i>prefix</i> <i>interface-type number</i> [summary] non-best] [detail] [vrf <i>vrf-id</i>]</p> <p>Example:</p> <p>switch# show ip adjacency</p>	<p>Displays the adjacency table. The argument ranges are as follows:</p> <ul style="list-style-type: none"> • <i>prefix</i>—Any IPv4 or IPv6 prefix address. • <i>interface-type number</i>—Use the ? command to see the supported interfaces. • <i>vrf-id</i>—Any case-sensitive, alphanumeric string up to 64 characters.
<p>show {ip ipv6} routing [<i>route-type</i> interface <i>interface-type number</i> next-hop recursive-next-hop summary updated {since until} time]</p> <p>Example:</p> <p>switch# show routing summary</p>	<p>Displays the unicast route table. The <i>route-type</i> argument can be a single route prefix or a direct, static, or dynamic route protocol. Use the ? command to see the supported interfaces.</p>

This example shows how to display the unicast route table:

```

switch# show ip route
IP Route Table for Context "default"
'*' denotes best ucast next-hop '**' denotes best mcast next-hop
'[x/y]' denotes [preference/metric]

0.0.0.0/0, 1 ucast next-hops, 0 mcast next-hops
  *via 10.1.1.1, mgmt0, [1/0], 5d21h, static
0.0.0.0/32, 1 ucast next-hops, 0 mcast next-hops
  *via Null0, [220/0], 1w6d, local, discard
10.1.0.0/22, 1 ucast next-hops, 0 mcast next-hops, attached
  *via 10.1.1.55, mgmt0, [0/0], 5d21h, direct
10.1.0.0/32, 1 ucast next-hops, 0 mcast next-hops, attached
  *via 10.1.0.0, Null0, [0/0], 5d21h, local
10.1.1.1/32, 1 ucast next-hops, 0 mcast next-hops, attached
  *via 10.1.1.1, mgmt0, [2/0], 5d16h, am
10.1.1.55/32, 1 ucast next-hops, 0 mcast next-hops, attached
  *via 10.1.1.55, mgmt0, [0/0], 5d21h, local
10.1.1.253/32, 1 ucast next-hops, 0 mcast next-hops, attached
  *via 10.1.1.253, mgmt0, [2/0], 5d20h, am
10.1.3.255/32, 1 ucast next-hops, 0 mcast next-hops, attached
  *via 10.1.3.255, mgmt0, [0/0], 5d21h, local
255.255.255.255/32, 1 ucast next-hops, 0 mcast next-hops
  *via Eth Inband Port, [0/0], 1w6d, local

```

This example shows how to display the adjacency information:

```

switch# show ip adjacency
IP Adjacency Table for context default
Total number of entries: 2
Address      Age      MAC Address      Pref Source      Interface      Best
10.1.1.1     02:20:54  00e0.b06a.71eb   50  arp         mgmt0         Yes
10.1.1.253   00:06:27  0014.5e0b.81d1   50  arp         mgmt0         Yes

```

Triggering the Layer 3 Consistency Checker

You can manually trigger the Layer 3 consistency checker.

To manually trigger the Layer 3 consistency checker, use the following commands in global configuration mode:

SUMMARY STEPS

1. **test forwarding [ipv4 | ipv6] [unicast] inconsistency [vrf vrf-name] [module {slot | all}]**
2. **test forwarding [ipv4 | ipv6] [unicast] inconsistency [vrf vrf-name] [module {slot | all}] stop**
3. **show forwarding [ipv4 | ipv6] [unicast] inconsistency [vrf vrf-name] [module {slot | all}]**
4. **show consistency-checker forwarding unicast**

DETAILED STEPS

	Command or Action	Purpose
Step 1	test forwarding [ipv4 ipv6] [unicast] inconsistency [vrf vrf-name] [module {slot all}] Example: switch(config)# test forwarding inconsistency	Starts a Layer 3 consistency check. The <i>vrf-name</i> can be any case-sensitive, alphanumeric string up to 64 characters. The <i>slot</i> range is from 1 to 26.

	Command or Action	Purpose
Step 2	test forwarding [ipv4 ipv6] [unicast] inconsistency [vrf vrf-name] [module {slot all}] stop Example: <pre>switch(config)# test forwarding inconsistency stop</pre>	Stops a Layer 3 consistency check. The <i>vrf-name</i> can be any case sensitive, alphanumeric string up to 64 characters. The <i>slot</i> range is from 1 to 26.
Step 3	show forwarding [ipv4 ipv6] [unicast] inconsistency [vrf vrf-name] [module {slot all}] Example: <pre>switch(config)# show forwarding inconsistency</pre>	Displays the results of a Layer 3 consistency check. The <i>vrf-name</i> can be any case-sensitive, alphanumeric string up to 64 characters. The <i>slot</i> range is from 1 to 26.
Step 4	show consistency-checker forwarding unicast Example: <pre>switch(config)# show consistency-checker forwarding unicast</pre>	Displays the results of a Layer 3 consistency check for unicast routes.

Clearing Forwarding Information in the FIB

You can clear one or more entries in the FIB. Clearing a FIB entry does not affect the unicast RIB.



Caution The **clear forwarding** command disrupts forwarding on the device.

To clear an entry in the FIB, including a Layer 3 inconsistency, use the following command in any configuration mode:

Command	Purpose
clear forwarding {ipv4 ipv6} route {* prefix} [vrf vrf-name] module {slot all} Example: <pre>switch# clear forwarding ipv4 route * module 1</pre>	Clears one or more entries from the FIB. The route options are as follows: <ul style="list-style-type: none"> • <i>*</i>—All routes. • <i>prefix</i>—Any IP or IPv6 prefix. The <i>vrf-name</i> can be any case-sensitive, alphanumeric string up to 64 characters. The <i>slot</i> range is from 1 to 26.

Configuring Maximum Routes for the Unicast RIB

You can configure the maximum number of routes allowed in the routing table.

SUMMARY STEPS

1. configure terminal

2. **vrf context** *vrf-name*
3. **address-family** {*ipv4* | *ipv6*} **unicast**
4. **maximum routes** *max-routes* [*threshold* [**reinstall** *threshold*] | **warning -only**]
5. (Optional) **copy running-config startup-config**

DETAILED STEPS

	Command or Action	Purpose
Step 1	configure terminal Example: <pre>switch# configure terminal switch(config)#</pre>	Enters global configuration mode.
Step 2	vrf context <i>vrf-name</i> Example: <pre>switch(config)# vrf context management2 switch(config-vrf)#</pre>	Creates a VRF and enters VRF configuration mode.
Step 3	address-family { <i>ipv4</i> <i>ipv6</i> } unicast Example: <pre>switch(config-vrf)# address-family ipv4 unicast switch(config-vrf-af-ipv4)</pre>	Enters the address-family configuration mode.
Step 4	maximum routes <i>max-routes</i> [<i>threshold</i> [reinstall <i>threshold</i>] warning -only] Example: <pre>switch(config-vrf-af-ipv4)# maximum routes 300000</pre>	<p>Configures the maximum number of routes allowed in the routing table. The range is from 1 to 4294967295.</p> <p>You can optionally specify the following:</p> <ul style="list-style-type: none"> • threshold—Percentage of maximum routes that triggers a warning message. The range is from 1 to 100. • warning-only—Logs a warning message when the maximum number of routes is exceeded. • reinstall threshold—Reinstalls routes that previously exceeded the maximum route limit and were rejected and specifies the threshold value at which to reinstall them. The threshold range is from 1 to 100.
Step 5	(Optional) copy running-config startup-config Example: <pre>switch(config-vrf-af-ipv4)# copy running-config startup-config</pre>	Saves this configuration change.

Estimating Memory Requirements for Routes

You can estimate the memory that a number of routes and next-hop addresses will use.

To estimate the memory requirements for routes, use the following command in any mode:

Command	Purpose
<pre>show routing {ipv6} memory estimate routes num-routes next-hops num-nexthops</pre> <p>Example:</p> <pre>switch# show routing memory estimate routes 5000 next-hops 2</pre>	<p>Displays the memory requirements for routes. The <i>num-routes</i> range is from 1000 to 1000000. The <i>num-nexthops</i> range is from 1 to 16.</p>

Clearing Routes in the Unicast RIB

You can clear one or more routes from the unicast RIB.



Caution The * keyword is severely disruptive to routing.

To clear one or more entries in the unicast RIB, use the following commands in any configuration mode:

Command	Purpose
<pre>clear {ip ip4 ipv6} route {* {route prefix/length} [next-hop interface]} [vrf vrf-name]</pre> <p>Example:</p> <pre>switch(config)# clear ip route 10.2.2.2</pre>	<p>Clears one or more routes from both the unicast RIB and all the module FIBs. The route options are as follows:</p> <ul style="list-style-type: none"> • *—All routes. • <i>route</i>—An individual IP or IPv6 route. • <i>prefix/length</i>—Any IP or IPv6 prefix. • <i>next-hop</i>—The next-hop address. • <i>interface</i>—The interface to reach the next-hop address. <p>The <i>vrf-name</i> can be an case-sensitive, alphanumeric string up to 64 characters.</p>
<pre>clear routing [multicast unicast] [ip ip4 ipv6] {* {route prefix/length} [next-hop interface]} [vrf vrf-name]</pre> <p>Example:</p> <pre>switch(config)# clear routing ip 10.2.2.2</pre>	<p>Clears one or more routes from the unicast RIB. The route options are as follows:</p> <ul style="list-style-type: none"> • *—All routes. • <i>route</i>—An individual IP or IPv6 route. • <i>prefix/length</i>—Any IP or IPv6 prefix. • <i>next-hop</i>—The next-hop address. • <i>interface</i>—The interface to reach the next-hop address. <p>The <i>vrf-name</i> can be an case-sensitive, alphanumeric string up to 64 characters.</p>

Verifying the Unicast RIB and FIB Configuration

To display the unicast RIB and FIB configuration information, perform one the following tasks:

Command	Purpose
<code>show forwarding adjacency</code>	Displays the adjacency table on a module.
<code>show forwarding distribution {clients fib-state}</code>	Displays the FIB distribution information.
<code>show forwarding interfaces module slot</code>	Displays the FIB information for a module.
<code>show forwarding {ip ipv4 ipv6} route</code>	Displays routes in the FIB.
<code>show {ip ipv6} adjacency</code>	Displays the adjacency table.
<code>show {ip ipv6} route</code>	Displays the IPv4 or IPv6 routes from the unicast RIB.
<code>show routing</code>	Displays routes from the unicast RIB.
<code>show system internal access-list dest-miss stats</code>	<p>Displays statistics for packets dropped due to missing the FIB routes for the destinations, also called as DEST MISS. The output displays increment in the DEST MISS counters.</p> <p>Note Beginning with Cisco NX-OS Release 10.1(1), this feature is supported on Cisco Nexus 9300-FX3 platform switches.</p>

Additional References

For additional information related to managing unicast RIB and FIB, see the following sections:

- [Related Documents](#)

Related Documents

Related Topic	Document Title
Configuring EEM	Cisco Nexus 9000 Series NX-OS System Management Configuration Guide



CHAPTER 17

Configuring Route Policy Manager

This chapter contains the following sections:

- [About Route Policy Manager, on page 515](#)
- [Guidelines and Limitations for Route Policy Manager, on page 524](#)
- [Default Settings for Route Policy Manager Parameters, on page 525](#)
- [Configuring Route Policy Manager, on page 526](#)
- [Global Commands to Block the Deletion of Route-Map, on page 544](#)
- [Verifying the Route Policy Manager Configuration, on page 545](#)
- [Configuration Examples for Route Policy Manager, on page 545](#)
- [Related Topics, on page 545](#)

About Route Policy Manager

Route Policy Manager supports route maps and IP prefix lists. These features are used for route redistribution. A prefix list contains one or more IPv4 or IPv6 network prefixes and the associated prefix length values. You can use a prefix list by itself in features such as Border Gateway Protocol (BGP) templates, route filtering, or redistribution of routes that are exchanged between routing domains.

Route maps can apply to both routes and IP packets. Route filtering and redistribution pass a route through a route map.

Prefix Lists

You can use prefix lists to permit or deny an address or range of addresses. Filtering by a prefix list involves matching the prefixes of routes or packets with the prefixes listed in the prefix list. An implicit deny is assumed if a given prefix does not match any entries in a prefix list.

You can configure multiple entries in a prefix list and permit or deny the prefixes that match the entry. Each entry has an associated sequence number that you can configure. If you do not configure a sequence number, Cisco NX-OS assigns a sequence number automatically. Cisco NX-OS evaluates prefix lists starting with the lowest sequence number. Cisco NX-OS processes the first successful match for a given prefix. Once a match occurs, Cisco NX-OS processes the permit or deny statement and does not evaluate the rest of the prefix list.



Note An empty prefix list permits all routes.

MAC Lists

You can use MAC lists to permit or deny a MAC address or range of addresses. A MAC list consists of a list of MAC addresses and optional MAC masks. A MAC mask is a wild-card mask that is logically AND-ed with the MAC address when the route map matches on the MAC list entry. Filtering by a MAC list involves matching the MAC address of packets with the MAC addresses listed in the MAC list. An implicit deny is assumed if a given MAC address does not match any entries in a MAC list.

You can configure multiple entries in a MAC list and permit or deny the MAC addresses that match the entry. Each entry has an associated sequence number that you must configure. Cisco NX-OS evaluates MAC lists starting with the lowest sequence number. Cisco NX-OS processes the first successful match for a given MAC address. Once a match occurs, Cisco NX-OS processes the permit or deny statement and does not evaluate the rest of the MAC list.

Route Maps

You can use route maps for route redistribution. Route map entries consist of a list of match and set criteria. The match criteria specify match conditions for incoming routes or packets, and the set criteria specify the action taken if the match criteria are met.

You can configure multiple entries in the same route map. These entries contain the same route map name and are differentiated by a sequence number.

You create a route map with one or more route map entries arranged by the sequence number under a unique route map name. The route map entry has the following parameters:

- Sequence number
- Permission—permit or deny
- Match criteria
- Set changes

By default, a route map processes routes or IP packets in a linear fashion (that is, starting from the lowest sequence number). You can configure the route map to process in a different order using the **continue** statement, which allows you to determine which route map entry to process next.

Default Action for Sequences in a Route Map

The default action for any sequence in a route map is **permit**. The permit action is applied under the following situations:

- When you configure a new sequence in a route map without explicitly specifying either **permit** or **deny**.
- When you edit a configured sequence in a route map and do not specify an action. In this situation, the **permit** action is applied even if the edited route map was configured originally with **deny**. For example, assume sequence 10 was configured with **deny**. If you later edit sequence 10 without specifying **deny** again, the action for that sequence is set to **permit**.

When configuring or editing a sequence of a route map, always set the correct action. Failure to do so causes the default action, **permit**, to be applied.

Default Sequence Number for a Route Map

The default sequence number for a route-map with no specified sequence value is 10. If you create a new route-map without specifying a sequence number, by default the sequence number for the new route will be 10. The default sequence number is applied under the following situations as well:

- **Existing Route-map with Sequence Number 10:** If a route-map already exists with sequence number 10 and you configure the same route-map again without specifying a sequence number, any modifications will be applied to sequence number 10 of that route-map.
- **Existing Route-map with other Sequence Numbers (20, 30, 40, and so on):** If a route-map already has sequence numbers assigned (20, 30, 40, etc.) and you configure it again without specifying a sequence number, a new entry with sequence number 10 will be created for that route-map.

Match Criteria

You can use a variety of criteria to match a route or IP packet in a route map. Some criteria, such as BGP community lists, are applicable only to a specific routing protocol while other criteria, such as the IP source or the destination address, can be used for any route or IP packet.

When Cisco NX-OS processes a route or packet through a route map, it compares the route or packet to each of the match statements configured. If the route or packet matches the configured criteria, Cisco NX-OS processes it based on the permit or deny configuration for that match entry in the route map and any set criteria configured.

The match categories and parameters are as follows:

- BGP parameters—Match based on AS numbers, AS-path, community attributes, or extended community attributes.
- Prefix lists—Match based on an address or range of addresses.
- Multicast parameters—Match based on rendezvous point, groups, or sources.
- Other parameters—Match based on IP next-hop address or packet length.

Set Changes

Once a route or packet matches an entry in a route map, the route or packet can be changed based on one or more configured set statements.

The set changes are as follows:

- BGP parameters—Change the AS-path, tag, community, extended community, dampening, local preference, origin, or weight attributes.
- Metrics—Change the route-metric or the route-type.
- Other parameters—Change the forwarding address or the IP next-hop address.

Access Lists

IP access lists can match the packet to a number of IP packet fields such as the following:

- Source or destination IPv4 or IPv6 address
- Protocol

- Precedence
- ToS
- You can use ACLs in a route map for policy-based routing only.

AS Numbers for BGP

You can configure a list of AS numbers to match against BGP peers. If a BGP peer matches an AS number in the list and matches the other BGP peer configuration, BGP creates a session. If the BGP peer does not match an AS number in the list, BGP ignores the peer. You can configure the AS numbers as a list or a range of AS numbers, or you can use an AS-path list to compare the AS numbers against a regular expression.

AS-Path Lists for BGP

You can configure an AS-path list to filter inbound or outbound BGP route updates. If the route update contains an AS-path attribute that matches an entry in the AS-path list, the router processes the route based on the permit or deny condition configured. You can configure AS-path lists within a route map.

You can configure multiple AS-path entries in an AS-path list by using the same AS-path list name. The router processes the first entry that matches.

Community Lists for BGP

You can filter BGP route updates based on the BGP community attribute by using community lists in a route map. You can match the community attribute based on a community list, and you can set the community attribute using a route map.

A community list contains one or more community attributes. If you configure more than one community attribute in the same community list entry, the BGP route must match all community attributes listed to be considered a match.

You can also configure multiple community attributes as individual entries in the community list by using the same community list name. In this case, the router processes the first community attribute that matches the BGP route, using the permit or deny configuration for that entry.

You can configure community attributes in the community list in one of the following formats:

- A named community attribute, such as **internet** or **no-export**.
- In *aa:nn* format, where the first two bytes represent the two-byte AS number and the last two bytes represent a user-defined network number.
- A regular expression.

Extended Community Lists for BGP

Extended community lists support 4-byte AS numbers. You can configure community attributes in the extended community list in one of the following formats:

- In *aa4:nn* format, where the first four bytes represent the four-byte AS number and the last two bytes represent a user-defined network number.
- A regular expression.

Cisco NX-OS supports generic specific extended community lists, which provide similar functionality to regular community lists for four-byte AS numbers. You can configure generic specific extended community lists with the following properties:

- Transitive—BGP propagates the community attributes across autonomous systems.
- Nontransitive—BGP removes community attributes before propagating the route to another autonomous system.

Configuring NX-OS BGP Large Communities

About NX-OS BGP Large Communities

NX-OS BGP supports only standard and extended communities. The use of a 4-byte ASN is limited to how you classify the routes as each standard communities have a limit of 4 bytes each and extended communities have a limit of 8 bytes. Out of 8 bytes, 2 bytes are used to define the community type and the remaining 6 bytes available. Large communities are standardized by an IETF RFC (8092) which allows you to define large communities that are 12 bytes in size and provides the flexibility in classification of BGP routes.

This feature provides the ability to classify routes from different data centers in different ASNs using communities to tag the routes. Large communities serve the purpose of classification of routes from different ASNs as they are each 12-bytes long. By adding support for RFC8092, NX-OS BGP will allow you the capability to classify the routes from 4-byte ASNs using standard route policy methods. It will also enable more flexibility in configuring networks and routing policies by removing the 4-byte restrictions of standard BGP communities.

Configuring Large Community List (Expanded)

The following are the steps to configure large community list in expanded form:

SUMMARY STEPS

1. **configure terminal**
2. **ip large-community-list *expanded***
3. **ip large-community-list *expanded* *list-name***
4. **ip large-community-list *expanded* *abcd* *seq***
5. **ip large-community-list *expanded* *abcd* *seq* **10** {*deny* | *permit*}**
6. **ip large-community-list *expanded* *abcd* *seq* **10** *permit* *XX:YY:ZZ***

DETAILED STEPS

	Command or Action	Purpose
Step 1	configure terminal Example: <pre>switch# configure terminal switch(config)#</pre>	Enters global configuration mode.
Step 2	ip large-community-list <i>expanded</i> Example: <pre>switch(config)# ip large-community-list expanded</pre>	This option adds an expanded large community list entry.

	Command or Action	Purpose
Step 3	ip large-community-list expanded <i>list-name</i> Example: switch(config)# ip large-community-list expanded list-name	This option provides the name of the expanded large community list. The <i>list-name</i> can be any case-sensitive, alphanumeric string up to 63 characters.
Step 4	ip large-community-list expanded abcd <i>seq</i> Example: switch(config)# ip large-community-list expanded abcd seq	This option provides the sequence number of the entry.
Step 5	ip large-community-list expanded abcd seq 10 {deny permit} Example: switch(config)# ip large-community-list expanded abcd seq 10 {deny permit}	The first option specifies the large community to reject. The second option specifies the large community to accept.
Step 6	ip large-community-list expanded abcd seq 10 permit XX:YY:ZZ Example: switch(config)# ip large-community-list expanded abcd seq 10 permit XX:YY:ZZ	This option provides the regular expression which uses a XX:YY:ZZ format. XX can have a range of <0-4294967294> and is a four octet global administrator field which represents ASN. Whereas, YY and ZZ are four octet local data fields, which are defined by an owner of the ASN. The ":" is a separator between global and local data fields.

Example

The following example shows how to create a large community list in expanded form:

```
switch(config)# ip large-community-list expanded abcd seq 10 permit "^100:200:300$"
switch(config)# sh run rpm
<<SNIP>>
ip large-community-list expanded abcd seq 10 permit "^100:200:300$"
```

Configuring Large Community List (Standard)

The following are the steps to configure large community list in standard form:

SUMMARY STEPS

1. **configure terminal**
2. **ip large-community-list *standard***
3. **ip large-community-list standard *list-name***
4. **ip large-community-list standard efgh *seq***
5. **ip large-community-list standard efgh seq 15 {deny | permit}**
6. **ip large-community-list standard efgh seq 15 deny XX:YY:ZZ**

DETAILED STEPS

	Command or Action	Purpose
Step 1	configure terminal Example: <pre>switch# configure terminal switch(config)#</pre>	Enters global configuration mode.
Step 2	ip large-community-list standard Example: <pre>switch(config)# ip large-community-list standard</pre>	This option adds a standard large community list entry.
Step 3	ip large-community-list standard list-name Example: <pre>switch(config)# ip large-community-list standard list-name</pre>	This option provides the name of the standard large community list. The <i>list-name</i> can be any case-sensitive, alphanumeric string up to 63 characters.
Step 4	ip large-community-list standard efgh seq Example: <pre>switch(config)# ip large-community-list standard efgh seq</pre>	This option provides the sequence number of the entry.
Step 5	ip large-community-list standard efgh seq 15 {deny permit} Example: <pre>switch(config)# ip large-community-list standard efgh seq 15 {deny permit}</pre>	<p>The first option specifies the large community to reject.</p> <p>The second option specifies the large community to accept.</p>
Step 6	ip large-community-list standard efgh seq 15 deny XX:YY:ZZ Example: <pre>switch(config)# ip large-community-list standard efgh seq 15 deny XX:YY:ZZ</pre>	<p>This option provides the regular expression which uses a XX:YY:ZZ format. XX can have a range of <0-4294967294> and is a four octet global administrator field which represents ASN. Whereas, YY and ZZ are four octet local data fields, which are defined by an owner of the ASN.</p> <p>The ":" is a separator between global and local data fields.</p>

Example

The following example shows how to create a large community list in standard form:

```
switch(config-route-map)# ip large-community-list standard efgh seq 15 deny 1000300:123:456
switch(config)# sh run rpm
<<SNIP>>
ip large-community-list standard efgh seq 15 deny 1000300:123:456
```

Configuring Route-map Match for Large Community

The following are the steps to configure route-map match for large community:

SUMMARY STEPS

1. **configure terminal**
2. **match *large-community***
3. **match large-community *list-name***
4. **match large-community *abcd exact-match***

DETAILED STEPS

	Command or Action	Purpose
Step 1	configure terminal Example: switch# configure terminal switch(config)#	Enters global configuration mode.
Step 2	match <i>large-community</i> Example: switch(config-route-map)# match large-community	This option matches BGP large community list.
Step 3	match large-community <i>list-name</i> Example: switch(config-route-map)# match large-community list-name	This option provides the name of the community list. The <i>list-name</i> can be any case-sensitive, alphanumeric string up to 63 characters.
Step 4	match large-community <i>abcd exact-match</i> Example: switch(config-route-map)# match large-community abcde exact-match	This option does the exact matching of the communities.

Example

The following example shows how to create a large community list in expanded form:

```
switch(config-route-map)# sh run rpm
<<SNIP>>
route-map test permit 10
  match large-community abcd efgh
```

Configuring Route Map Set for Large Community

The following are the steps to configure route-map set for large community:

SUMMARY STEPS

1. **configure terminal**
2. **set large-community-list**
3. **set large-community-list list-name**
4. **set large-community-list list-name delete**
5. **set large-community {none | XX:YY:ZZ [additive] | additive}**

DETAILED STEPS

	Command or Action	Purpose
Step 1	configure terminal Example: <pre>switch# configure terminal switch(config)#</pre>	Enters global configuration mode.
Step 2	set large-community-list Example: <pre>switch(config-route-map)# set large-community-list</pre>	This option sets BGP large community attribute.
Step 3	set large-community-list list-name Example: <pre>switch(config-route-map)# set large-community-list list-name</pre>	This option sets the name of the large community list. The <i>list-name</i> can be any case-sensitive, alphanumeric string up to 63 characters.
Step 4	set large-community-list list-name delete Example: <pre>switch(config-route-map)# set large-community-list list-name delete</pre> Example: <pre>switch(config-route-map)# sh run rpm route-map test permit 10 set large-community-list list-name delete</pre>	This option deletes the matching large communities.
Step 5	set large-community {none XX:YY:ZZ [additive] additive} Example: <pre>switch(config-route-map)# set large-community {none XX:YY:ZZ [additive] additive} switch(config-route-map)# set large-community 1000:1235:7629 200:30048:234 additive</pre> Example: <pre>switch(config-route-map)# sh run rpm route-map test permit 10 set large-community additive</pre>	This command sets the large-community attribute for a BGP route update. <ul style="list-style-type: none"> • The 'XX:YY:ZZ' option represents the large-community attribute in XX:YY:ZZ format and sets that value alone for a BGP route update. A maximum of 32 large-community attributes can be added in one set command. • The 'additive' option represents an addition to the existing large-community attribute, and is used along with the XX:YY:ZZ option. When used in this manner, it adds the XX:YY:ZZ attribute to the existing large-community attribute.

	Command or Action	Purpose
	<pre>switch(config-route-map)# sh run rpm route-map test permit 10 set large-community 1000300:123:456 switch(config-route-map)# sh run rpm route-map test permit 10 set large-community none</pre>	<ul style="list-style-type: none"> The 'none' option represents that no large-community attribute will be set.

Route Redistribution and Route Maps

You can use route maps to control the redistribution of routes between routing domains. Route maps match on the attributes of the routes to redistribute only those routes that pass the match criteria. The route map can also modify the route attributes during this redistribution using the set changes.

The router matches redistributed routes against each route map sequences. If there are multiple match statements under a route-map sequence, then the route must pass all the match criteria under that route-map sequence. If a route passes the match criteria defined in a route map sequence, then the set-actions defined in that sequences are executed. If the route does not match the criteria in a route-map sequence, then the router compares the route against subsequent route map sequence. This route evaluation against the route-map continues until a match is made, or the route is evaluated by all the sequences in the route map. Finally, if the route does not match against any of the route-map sequences, then the router denies acceptance of the route (for inbound route maps) or denies forwarding of the route (for outbound route maps).



Note When you redistribute BGP to IGP, iBGP is redistributed as well. To override this behavior, you must insert an additional deny statement into the route map.

Guidelines and Limitations for Route Policy Manager

Route Policy Manager has the following configuration guidelines and limitations:

- Names in the prefix-list are case-insensitive. We recommend using unique names. Do not use the same name by modifying upper-case and lowercase characters. For example, CTCPrimaryNetworks and CtcPrimaryNetworks are two different entries.
- If no route map exists, all routes are denied.
- If no prefix list exists, all routes are permitted.
- When matching two irrelevant entities in the route-map entry, the permission (permit or deny) of the route-map entry decides the result for all the routes or packets. It also applies the set criteria of the route-map entry. For example, the following route-map, when associated with the BGP configuration, tries to match the ospf-area which results in permitting the irrelevant match and sets the metric to 100:

```
route-map abc permit seq 10
match ospf-area 2
set metric 100
```

- Without any match statement in a route-map entry, the permission (permit or deny) of the route-map entry decides the result for all the routes or packets.

- If referred policies (for example, prefix lists) within a match statement of a route-map entry return either a no-match or a deny-match, Cisco NX-OS fails the match statement and processes the next route-map entry.
- When you change a route map, Cisco NX-OS holds all the changes until you exit from the route-map configuration submode. Cisco NX-OS then sends all the changes to the protocol clients to take effect.
- Cisco recommends that you do not have both IPv4 and IPv6 match statements in the same route-map sequence. If both are required, they should be specified in different sequences in the same route-map.
- Because you can use a route map before you define it, verify that all your route maps exist when you finish a configuration change.
- You can view the route-map usage for redistribution and filtering. Each individual routing protocol provides a way to display these statistics.
- When you redistribute BGP to IGP, iBGP is redistributed as well. To override this behavior, you must insert an additional deny statement into the route map.
- Route Policy Manager does not support MAC lists.
- The maximum number of characters for ACL names in the ip access-list name command is 64. However, ACL names that are associated with RPM commands (such as ip prefix-list and match ip address) accept a maximum of only 63 characters.
- BGP supports only specific **match** commands. For details, see the **match** commands table in the [Configuring Route Maps](#) section.
- If you create an ACL named "prefix-list," it cannot be associated with a route map that is created using the match ip address command. The RPM command match ip address prefix-list makes the previous command (with the "prefix-list" ACL name) ambiguous.
- You can configure only one ACL when using the match ip address command.
- If policy is applied via config profile, it is not preferred to attempt unconfiguration (with short no form) of the particular CLI via normal CLI configuration mode. If any changes are required, unapply the profile first, and then modify the profile and apply again.
- For any RPM profile, if you're planning to configure and apply the config profile ensure not to configure and unconfigure (with short no form) the same profile, if you wish to use "config profile" later.
- If you configure standard ip community-list and ip large-community-list in multiple lines in config-profile, only the last configured line of that sequence persists. To execute these 2 commands, you need to configure all the community values and execute as a single command in config-profile.
- Beginning with Cisco NX-OS Release 10.2(2)F, matching on tags for BGP NLRI (for inbound and outbound facing route-maps) is now supported. However, this is only intended for the use of the L2VPN EVPN address family in L4-7 service integration in VXLAN.

Default Settings for Route Policy Manager Parameters

The following table lists the default settings for Route Policy Manager.

Table 27: Default Route Policy Manager Parameters

Parameters	Default
Route Policy Manager	Enabled
Administrative distance	115

Configuring Route Policy Manager



Note If you are familiar with the Cisco IOS CLI, be aware that the Cisco NX-OS commands for this feature might differ from the Cisco IOS commands that you would use.

Configuring IP Prefix Lists

IP prefix lists match the IP packet or route against a list of prefixes and prefix lengths. You can create an IP prefix list for IPv4 and create an IPv6 prefix list for IPv6.

You can configure the prefix list entry to match the prefix length exactly or to match any prefix with a length that matches the configured range of prefix lengths.

Beginning with Cisco NX-OS Release 9.3(9), make sure to add the sequence number when configuring the prefix-list in the NDFC/config-profile/dual-stage configuration modes. Also, when modifying a sequence or inserting a new one, ensure that there is a gap in the sequence number, preferably in increments of 5 or 10, instead of assigning a continuous number.

For example:

```
ip prefix-list allowprefix seq 10 permit 192.0.2.0/23 eq 24
ip prefix-list allowprefix seq 20 permit 209.165.201.0/27 eq 28
```



Note Beginning with Cisco NX-OS Release 9.3.9, if prefix-list does not have sequence numbers in the config-profile ensure to add the sequence numbers before upgrading to that release or higher.

Use the **ge** and **lt** keywords to create a range of possible prefix lengths. The incoming packet or route matches the prefix list if the prefix matches and if the prefix length is greater than or equal to the **ge** keyword value (if configured) and less than or equal to the **lt** keyword value (if configured). When using the **eq** keyword, the value you set must be greater than the mask length for the prefix.

Use the **mask** keyword to define a range of possible contiguous or non-contiguous routes to be compared to the prefix address.

SUMMARY STEPS

1. **configure terminal**
2. **{ ip | ipv6 } prefix-list name description string**

3. **{ip | ipv6} prefix-list name [seq number] [{ permit | deny } prefix { [eq prefix-length] | [ge prefix-length] | [le prefix-length] }] [mask mask]**
4. (Optional) **show { ip | ipv6 } prefix-list name**
5. (Optional) **copy running-config startup-config**

DETAILED STEPS

	Command or Action	Purpose
Step 1	configure terminal Example: <pre>switch# configure terminal switch(config)#</pre>	Enters global configuration mode.
Step 2	Required: { ip ipv6 } prefix-list name description string Example: <pre>switch(config)# ip prefix-list AllowPrefix description allows engineering server</pre>	Adds an information string about the prefix list.
Step 3	{ip ipv6} prefix-list name [seq number] [{ permit deny } prefix { [eq prefix-length] [ge prefix-length] [le prefix-length] }] [mask mask] Example: <pre>switch(config)# ip prefix-list AllowPrefix seq 10 permit 192.0.2.0/23 eq 24 switch(config)# ipv6 prefix-list AllowIPv6Prefix seq 10 permit 2001:0DB8:: le 32 switch(config)# ip prefix-list even permit 0.0.0.0/32 mask 0.0.0.1 switch(config)# ipv6 prefix-list even permit 2001:0DB8::/64 mask ffff:1::</pre>	Creates an IPv4 or IPv6 prefix list or adds a prefix to an existing prefix list. The <i>prefix-length</i> is matched as follows: <ul style="list-style-type: none"> • eq —Matches the exact <i>prefix-length</i> . This value must be greater than the mask length. • ge —Matches a prefix length that is equal to or greater than the configured <i>prefix-length</i> . • le —Matches a prefix length that is equal to or less than the configured <i>prefix-length</i> . • mask —Specifies the bits of a prefix address in a prefix list that are compared to the bits of the prefix address used in routing protocols. This option is available for IPv6 prefix lists beginning with Cisco NX-OS Release 9.3(3) for Cisco Nexus 9200, 9300-EX, and 9300-FX platform switches and 9700-EX and 9700-FX line cards.
Step 4	(Optional) show { ip ipv6 } prefix-list name Example: <pre>switch(config)# show ip prefix-list AllowPrefix</pre>	Displays information about prefix lists.
Step 5	(Optional) copy running-config startup-config Example: <pre>switch(config)# copy running-config startup-config</pre>	Saves this configuration change.

Example

This example shows how to create an IPv4 prefix list with two entries and apply the prefix list to a BGP neighbor:

```
switch# configure terminal
switch(config)# ip prefix-list allowprefix seq 10 permit 192.0.2.0/23 eq 24
switch(config)# ip prefix-list allowprefix seq 20 permit 209.165.201.0/27 eq 28
switch(config)# router bgp 65535
switch(config-router)# neighbor 192.0.2.1/16 remote-as 65534
switch(config-router-neighbor)# address-family ipv4 unicast
switch(config-router-neighbor-af)# prefix-list allowprefix in
```

This example shows how to create an IPv4 prefix list with a match mask for all /24 odd IP addresses:

```
switch# configure terminal
switch(config)# ip prefix-list list1 seq 7 permit 22.1.1.0/24 mask 255.255.1.0
switch(config)# show route-map test
route-map test, permit, sequence 7
Match clauses:
ip address prefix-lists: list1
Set clauses:
extcommunity COST:igp:10:20
switch(config)# show ip prefix-list list1
ip prefix-list list1: 1 entries
seq 7 permit 22.1.1.0/24 mask 255.255.1.0
```

This example shows how to create an IPv4 prefix list that matches all subnets of 21.1.0.0/16 where the subnet prefix is 17 or greater. Due to the mask option, only those incoming prefixes where the first bit in the third octet is unset (even) will be matched.

```
switch# configure terminal
switch(config)# ip prefix-list list1 seq 10 permit 21.1.0.0/16 ge 17 mask 255.255.1.0
```

Configuring MAC Lists

You can configure a MAC list to permit or deny a range of MAC addresses.

Beginning with Cisco NX-OS Release 10.4(2)F, make sure to add the sequence number when configuring the prefix-list in the NDFC/config-profile/dual-stage configuration modes. Also, when modifying a sequence or inserting a new one, ensure that there is a gap in the sequence number, preferably in increments of 5 or 10, instead of assigning a continuous number.

For example:

```
mac-list AllowMac seq 5 permit 0022.5579.a4c1 ffff.ffff.0000
mac-list AllowMac seq 10 permit 0033.5510.a4c1 ffff.ffff.0000
```



Note Beginning with Cisco NX-OS Release 10.4(2)F, if mac-list does not have sequence numbers in the config-profile ensure to add the sequence numbers before upgrading to that release or higher.

SUMMARY STEPS

1. **configure terminal**

2. `mac-list name seq number {permit | deny } mac-address [mac-mask]`
3. (Optional) `show mac-list name`
4. (Optional) `copy running-config startup-config`

DETAILED STEPS

	Command or Action	Purpose
Step 1	configure terminal Example: <pre>switch# configure terminal switch(config)#</pre>	Enters global configuration mode.
Step 2	Required: <code>mac-list name seq number {permit deny } mac-address [mac-mask]</code> Example: <pre>switch(config)# mac-list AllowMac seq 5 permit 0022.5579.a4c1 ffff.ffff.0000</pre>	Creates a MAC list or adds a MAC address to an existing MAC list. The seq range is from 1 to 4294967294. The <i>mac-mask</i> specifies the portion of the MAC address to match against and is in MAC address format.
Step 3	(Optional) <code>show mac-list name</code> Example: <pre>switch(config)# show mac-list name</pre>	Displays information about prefix lists.
Step 4	(Optional) <code>copy running-config startup-config</code> Example: <pre>switch(config)# copy running-config startup-config</pre>	Saves this configuration change.

Configuring AS-path Lists

You can specify an AS-path list filter on both inbound and outbound BGP routes. Each filter is an access list based on regular expressions. If the regular expression matches the representation of the AS-path attribute of the route as an ASCII string, the permit or deny condition applies.

SUMMARY STEPS

1. `configure terminal`
2. `ip as-path access-list name {deny | permit} expression`
3. (Optional) `show {ip | ipv6} as-path-access-list name`
4. (Optional) `copy running-config startup-config`

DETAILED STEPS

	Command or Action	Purpose
Step 1	configure terminal Example: <pre>switch# configure terminal switch(config)#</pre>	Enters global configuration mode.

	Command or Action	Purpose
Step 2	ip as-path access-list <i>name</i> {deny permit} <i>expression</i> Example: <pre>switch(config)# ip as-path access-list Allow40 permit 40</pre>	Creates a BGP AS-path list using a regular expression.
Step 3	(Optional) show {ip ipv6} as-path-access-list <i>name</i> Example: <pre>switch(config)# show ip as-path-access-list Allow40</pre>	Displays information about as-path access lists.
Step 4	(Optional) copy running-config startup-config Example: <pre>switch(config)# copy running-config startup-config</pre>	Saves this configuration change.

Example

This example shows how to create an AS-path list with two entries and apply the AS path list to a BGP neighbor:

```
switch# configure terminal
switch(config)# ip as-path access-list AllowAS permit 64510
switch(config)# ip as-path access-list AllowAS permit 64496
switch(config)# copy running-config startup-config
switch(config)# router bgp 65535:20
switch(config-router)# neighbor 192.0.2.1/16 remote-as 65535:20
switch(config-router-neighbor)# address-family ipv4 unicast
switch(config-router-neighbor-af)# filter-list AllowAS in
```

Replacing BGP AS-path Attribute

The following procedures allow you to manipulate the BGP routing policy by modifying the BGP as-path attribute in inbound and outbound route maps.

Consider the following guidelines when replacing the BGP as-path attribute:

- This feature is applicable to only eBGP neighbors on a per address family identifier (AFI) basis. If you attempt to configure the feature on iBGP neighbors, the configuration is ignored.
- A route map with this feature can be applied to both the inbound and outbound sides of a BGP neighbor.
- This feature supports any combination of AS_SET, AS_SEQUENCE, CONFED_SET, and CONFED_SEQUENCE.
- When interacting with a BGP speaker that supports only a 2-byte AS, the 4-byte AS number is replaced by the reserved 2-byte AS number 23456.
- If a confederation identifier is configured, consider using the confederation identifier as the local ASN in the CLI when interacting with a peer that is outside the confederation. When interacting with a peer belonging to the same confederation, consider using the process ASN in the **router bgp asn** command.

- When the BGP **local-as** feature is configured, the configured local-as will be considered as local ASN in the CLI.
- For outbound route-maps, the local ASN will always be prepended to the resulting `as_path` from the CLI.
- A maximum of 32 AS numbers can be configured in a **set as-path** or **set as-path replace** command.
- Only one of these options can be configured under one route-map sequence: **set as-path**, **set as-path prepend**, and **set as-path replace**.
- If **remove-private-as** is configured, it will be applied before applying the new route-map commands on the outbound side.
- If **as-override** is configured, it will be applied after applying the new route-map commands on the outbound side.
- AS_PATH loop checks will execute on the original AS_PATH before the new route-map commands are applied on both inbound and outbound sides. These checks can be relaxed by using **allow-as in** on the inbound side and **disable-peer-as-check** on the outbound side.

Replacing the Complete AS-path

Use this procedure to modify the AS-path in an incoming or outgoing BGP update to a custom AS-path. You can also remove the AS-path completely.

Procedure

	Command or Action	Purpose
Step 1	configure terminal Example: <pre>switch# configure terminal switch(config)#</pre>	Enters global configuration mode.
Step 2	route-map map-name [permit deny] [seq] Example: <pre>switch(config)# route-map Testmap permit 10 switch(config-route-map)#</pre>	Creates a route map or enters route-map configuration mode for an existing route map. Use <i>seq</i> to order the entries in a route map.
Step 3	[no] set as-path { none {as-number remote-as local-as}+] } Example: <pre>switch(config-route-map)# set as-path 11 local-as remote-as 13</pre>	Replaces AS_PATH with a list of custom ASNs or clears the AS_PATH. The command options are: <ul style="list-style-type: none"> • <i>as-number</i>: The specified AS number. • remote-as: The AS number of the BGP peer. • local-as: The local AS number. The none keyword removes the AS-path completely.

Example

In the following examples, these values are assumed:

- The original AS_PATH is **10 20 30 40 50 60**.
- The local-as is **100**.
- The remote-as is **200**.

This example shows how to specify a custom AS-path. This command will change the AS-path to **11 100 200 13 200 10.10 65535**.

```
switch# configure terminal
switch(config)# route-map Testmap permit 10
switch(config-route-map)# set as-path 11 local-as remote-as 13 remote-as 10.10 65535
```

This example shows how to clear the AS-path. This command will cause the AS-path to be empty.

```
switch# configure terminal
switch(config)# route-map Testmap permit 10
switch(config-route-map)# set as-path none
```

Replacing Selected AS Numbers in the AS-path

Use this procedure to replace specific AS numbers in the AS-path and replace them with custom AS numbers in an incoming or outgoing BGP update. You can also specify **private-as** as a match keyword. In this case, any instance of a private-as is matched and can be replaced or removed.

Procedure

	Command or Action	Purpose
Step 1	configure terminal Example: switch# configure terminal switch(config)#	Enters global configuration mode.
Step 2	route-map map-name [permit deny] [seq] Example: switch(config)# route-map Testmap permit 10 switch(config-route-map)#	Creates a route map or enters route-map configuration mode for an existing route map. Use <i>seq</i> to order the entries in a route map.
Step 3	[no] set as-path replace {asn_list private-as} [with {as-number remote-as none}] Example: switch(config-route-map)# set as-path replace 1, 2, private-as with remote-as	<p>If the with keyword is not specified, substitute the local-as for any instance of an ASN mentioned in the comma separated <i>asn_list</i>, or for any private-as if the private-as keyword is specified.</p> <p>If the with keyword is specified, substitute the value after the with keyword for any matched ASN, or any private-as if the private-as keyword is specified.</p> <p>The command options following the with keyword are:</p> <ul style="list-style-type: none"> • <i>as-number</i>: The matched values are replaced by the specified AS number.

	Command or Action	Purpose
		<ul style="list-style-type: none"> • remote-as: The matched values are replaced by the AS number of the BGP peer. • none: The matched values are removed from the AS-path.

Example

In the following examples, these values are assumed:

- The original AS_PATH is **1 5 2 10.10 65534 20**.
- The local-as is **100**.
- The remote-as is **200**.

This example shows how to replace two specific ASNs and a private-as with the local-as. This command will change the AS-path to **100 5 100 10.10 100 20**.

```
switch# configure terminal
switch(config)# route-map Testmap permit 10
switch(config-route-map)# set as-path replace 1, 2, private-as
```

This example shows how to replace two specific ASNs and a private-as with the neighbor's ASN (remote-as). This command will change the AS-path to **200 5 200 10.10 200 20**.

```
switch# configure terminal
switch(config)# route-map Testmap permit 10
switch(config-route-map)# set as-path replace 1, 2, private-as with remote-as
```

This example shows how to remove two specific ASNs and a private-as. This command will change the AS-path to **5 10.10 20**.

```
switch# configure terminal
switch(config)# route-map Testmap permit 10
switch(config-route-map)# set as-path replace 1, 2, private-as with none
```

Configuring Community Lists

You can use community lists to filter BGP routes based on the community attribute. The community number consists of a 4-byte value in the *aa:nn* format. The first two bytes represent the autonomous system number, and the last two bytes represent a user-defined network number.

When you configure multiple values in the same community list statement, all community values must match to satisfy the community list filter. When you configure multiple values in separate community list statements, the first list that matches a condition is processed.

Use community lists in a match statement to filter BGP routes based on the community attribute.

SUMMARY STEPS

1. **configure terminal**
2. Enter one of the following:
 - **ip community-list standard** *list-name* {deny | permit} [*community-list*] [internet] [local-AS] [no-advertise] [no-export] [graceful-shutdown] [blackhole]
 - or
 - **ip community-list expanded** *list-name* {deny | permit} *expression*
3. (Optional) **show ip community list** *name*
4. (Optional) **copy running-config startup-config**

DETAILED STEPS

	Command or Action	Purpose
Step 1	configure terminal Example: <pre>switch# configure terminal switch(config)#</pre>	Enters global configuration mode.
Step 2	Enter one of the following: <ul style="list-style-type: none"> • ip community-list standard <i>list-name</i> {deny permit} [<i>community-list</i>] [internet] [local-AS] [no-advertise] [no-export] [graceful-shutdown] [blackhole] or • ip community-list expanded <i>list-name</i> {deny permit} <i>expression</i> Example: <pre>switch(config)# ip community-list standard BGPCommunity permit no-advertise 65535:20 or switch(config)# ip community-list expanded BGPComplex deny 50000:[0-9][0-9]</pre>	The first option creates a standard BGP community list. The <i>list-name</i> can be any case-sensitive, alphanumeric string up to 63 characters. The <i>community-list</i> can be one or more communities in the <i>aa:nn</i> format. The second option creates an expanded BGP community list using a regular expression.
Step 3	(Optional) show ip community list <i>name</i> Example: <pre>switch(config)# show ip community-list BGPCommunity</pre>	Displays information about community lists.
Step 4	(Optional) copy running-config startup-config Example: <pre>switch(config)# copy running-config startup-config</pre>	Saves this configuration change.

Example

This example shows how to create a community list with two entries:

```

switch# configure terminal
switch(config)# ip community-list standard BGPCcommunity permit no-advertise 65535:20
switch(config)# ip community-list standard BGPCcommunity permit local-AS no-export
switch(config)# copy running-config startup-config

```

Configuring Extended Community Lists

You can use extended community lists to filter BGP routes based on the community attribute. The community number consists of a 6-byte value in the *aa4:nn* format. The first four bytes represent the autonomous system number, and the last two bytes represent a user-defined network number.

When you configure multiple values in the same extended community list statement, all extended community values must match to satisfy the extended community list filter. When you configure multiple values in separate extended community list statements, the first list that matches a condition is processed.

Use extended community lists in a match statement to filter BGP routes based on the extended community attribute.



Note Configure **extcommunity** in AS2:NN or AS4:NN (as-plain) formats always. Beginning with NX-OS release 10.4(3)F, you can configure **extcommunity** in AS.dot format.

SUMMARY STEPS

1. **configure terminal**
2. Enter one of the following:
 - **ip extcommunity-list standard** *list-name* {deny | permit} seq 5 4byteas-generic {transitive | nontransitive} *community1* [*community2...*] rt 2:2 soo 3:3
 - or
 - **ip extcommunity-list expanded** *list-name* seq 5 {deny | permit} *expression*
3. **ip extcommunity-list standard** *commext* seq 5 permit 4byteas-generic transitive 1:1 rt 2:2 soo 3:3
4. (Optional) **show ip community-list** *name*
5. (Optional) **copy running-config startup-config**

DETAILED STEPS

	Command or Action	Purpose
Step 1	configure terminal Example: <pre> switch# configure terminal switch(config)# </pre>	Enters global configuration mode.

	Command or Action	Purpose
Step 2	<p>Enter one of the following:</p> <ul style="list-style-type: none"> • ip extcommunity-list standard <i>list-name</i> {deny permit} seq 5 4byteas-generic {transitive nontransitive} community1 [community2...] rt 2:2 soo 3:3 <p>or</p> <ul style="list-style-type: none"> • ip extcommunity-list expanded <i>list-name</i> seq 5 {deny permit} <i>expression</i> <p>Example:</p> <pre>switch(config)# ip extcommunity-list standard BGPExtCommunity seq 5 permit 4byteas-generic transitive 65535:20 rt 2:2 soo 3:3</pre> <p>or</p> <pre>switch(config)# ip extcommunity-list expanded BGPExtComplex seq 5 deny 1.5:[0-9][0-9]</pre>	<p>The first option creates a standard BGP extended community list. The <i>community</i> can be one or more extended communities in the <i>aa4:nn</i> format.</p> <p>The second option creates an expanded BGP extended community list using a regular expression.</p>
Step 3	<p>ip extcommunity-list standard <i>commext</i> seq 5 permit 4byteas-generic transitive 1:1 rt 2:2 soo 3:3</p> <p>Example:</p> <pre>switch(config)# ip extcommunity-list standard commext seq 5 permit 4byteas-generic transitive 1:1 rt 2:2 soo 3:3</pre>	<p>Sequence number is added as an input parameter to the CLI. Henceforth, you must enter the input sequence number while configuring extcommunity lists.</p> <p>Note For config replace, the user config file must contain a valid running configuration collected from a device. It can be collected from a device running any NX-OS image label. It must be a valid file that which is not tampered manually.</p>
Step 4	<p>(Optional) show ip community-list <i>name</i></p> <p>Example:</p> <pre>switch(config)# show ip community-list BGPCommunity</pre>	Displays information about extended community lists.
Step 5	<p>(Optional) copy running-config startup-config</p> <p>Example:</p> <pre>switch(config)# copy running-config startup-config</pre>	Saves this configuration change.

Example

This example shows how to create a generic specific extended community list:

```
switch# configure terminal
switch(config)# ip extcommunity-list standard test1 seq 5 permit 4byteas-generic transitive
65535:40 65535:60
switch(config)# copy running-config startup-config
```

Configuring Route Maps

You can use route maps for route redistribution or route filtering. Route maps can contain multiple match criteria and multiple set criteria.

Configuring a route map for BGP triggers an automatic soft clear or refresh of BGP neighbor sessions.

SUMMARY STEPS

1. **configure terminal**
2. **route-map** *map-name* [**permit** | **deny**] [*seq*]
3. (Optional) **continue** *seq*
4. (Optional) **exit**
5. (Optional) **copy running-config startup-config**

DETAILED STEPS

	Command or Action	Purpose
Step 1	configure terminal Example: switch# configure terminal switch(config)#	Enters global configuration mode.
Step 2	route-map <i>map-name</i> [permit deny] [<i>seq</i>] Example: switch(config)# route-map Testmap permit 10 switch(config-route-map)#	Creates a route map or enters route-map configuration mode for an existing route map. Use <i>seq</i> to order the entries in a route map.
Step 3	(Optional) continue <i>seq</i> Example: switch(config-route-map)# continue 10	Determines what sequence statement to process next in the route map. Used only for filtering and redistribution.
Step 4	(Optional) exit Example: switch(config-route-map)# exit	Exits route-map configuration mode.
Step 5	(Optional) copy running-config startup-config Example: switch(config-route-map)# copy running-config startup-config	Copies the running configuration to the startup configuration.

Example

You can configure the following optional match parameters for route maps in route-map configuration mode:



Note The **default-information originate** command ignores **match** statements in the optional route map.

Command	Purpose
<p>match as-path <i>name</i> [<i>name...</i>]</p> <p>Example:</p> <pre>switch(config-route-map)# match as-path Allow40</pre>	<p>Matches against one or more AS-path lists. Create the AS-path list with the ip as-path access-list command.</p>
<p>match as-number { <i>number</i> [,<i>number...</i>] as-path-list <i>name</i> [<i>name...</i>] }</p> <p>Example:</p> <pre>switch(config-route-map)# match as-number 33,50-60</pre>	<p>Matches against one or more AS numbers or AS-path lists. Create the AS-path list with the ip as-path access-list command. The number range is from 1 to 65535. The AS-path list name can be any case-sensitive, alphanumeric string up to 63 characters.</p>
<p>match community <i>name</i> [<i>name...</i>] [exact-match]</p> <p>Example:</p> <pre>switch(config-route-map)# match community BGPCommunity</pre>	<p>Matches against one or more community lists. Create the community list with the ip community-list command.</p>
<p>match extcommunity <i>name</i> [<i>name...</i>] [exact-match]</p> <p>Example:</p> <pre>switch(config-route-map)# match extcommunity BGPextCommunity</pre>	<p>Matches against one or more extended community lists. Create the community list with the ip extcommunity-list command.</p>
<p>match interface <i>interface-type</i> <i>number</i> [<i>interface-type</i> <i>number...</i>]</p> <p>Example:</p> <pre>switch(config-route-map)# match interface e 1/2</pre>	<p>Matches any routes that have their next hop out one of the configured interfaces. Use ? to find a list of supported interface types.</p> <p>Note BGP does not support this command.</p>
<p>match ip address prefix-list <i>name</i> [<i>name...</i>]</p> <p>Example:</p> <pre>switch(config-route-map)# match ip address prefix-list AllowPrefix</pre>	<p>Matches against one or more IPv4 prefix lists. Use the ip prefix-list command to create the prefix list.</p>
<p>match ipv6 address prefix-list <i>name</i> [<i>name...</i>]</p> <p>Example:</p> <pre>switch(config-route-map)# match ip address prefix-list AllowIPv6Prefix</pre>	<p>Matches against one or more IPv6 prefix lists. Use the ipv6 prefix-list command to create the prefix list.</p>

Command	Purpose
<p>match ip multicast [source <i>ipsource</i>] [[group <i>ipgroup</i>] [rp <i>iprp</i>]]</p> <p>Example:</p> <pre>switch(config-route-map)# match ip multicast rp 192.0.2.1</pre>	<p>Matches an IPv4 multicast packet based on the multicast source, group, or rendezvous point.</p> <p>Note BGP does not support this command.</p>
<p>match ipv6 multicast [source <i>ipsource</i>][[group <i>ipgroup</i>] [rp <i>iprp</i>]]</p> <p>Example:</p> <pre>switch(config-route-map)# match ip multicast source 2001:0DB8::1</pre>	<p>Matches an IPv6 multicast packet based on the multicast source, group, or rendezvous point.</p> <p>Note BGP does not support this command.</p>
<p>match ip next-hop prefix-list <i>name</i> [<i>name</i> ...]</p> <p>Example:</p> <pre>switch(config-route-map)# match ip next-hop prefix-list AllowPrefix</pre>	<p>Matches the IPv4 next-hop address of a route to one or more IP prefix lists. Use the ip prefix-list command to create the prefix list.</p>
<p>match ipv6 next-hop prefix-list <i>name</i> [<i>name</i> ...]</p> <p>Example:</p> <pre>switch(config-route-map)# match ipv6 next-hop prefix-list AllowIPv6Prefix</pre>	<p>Matches the IPv6 next-hop address of a route to one or more IP prefix lists. Use the ipv6 prefix-list command to create the prefix list.</p>
<p>match ip route-source prefix-list <i>name</i> [<i>name</i> ...]</p> <p>Example:</p> <pre>switch(config-route-map)# match ip route-source prefix-list AllowPrefix</pre>	<p>Matches the IPv4 route source address of a route to one or more IP prefix lists. Use the ip prefix-list command to create the prefix list.</p>
<p>match ipv6 route-source prefix-list <i>name</i> [<i>name</i> ...]</p> <p>Example:</p> <pre>switch(config-route-map)# match ipv6 route-source prefix-list AllowIPv6Prefix</pre>	<p>Matches the IPv6 route-source address of a route to one or more IP prefix lists. Use the ipv6 prefix-list command to create the prefix list.</p>
<p>match metric <i>value</i> [+- <i>deviation.</i>] [<i>value.</i>]</p> <p>Example:</p> <pre>switch(config-route-map)# match metric 50 + 10</pre>	<p>Matches the route metric against one or more metric values or value ranges. Use +- <i>deviation</i> argument to set a metric range. The route map matches any route metric that falls within the range:</p> <p><i>value</i> - <i>deviation</i> to <i>value</i> + <i>deviation</i>.</p>
<p>match ospf-area <i>area-id</i></p> <p>Example:</p> <pre>switch(config-route-map)# match ospf-area 1</pre>	<p>Matches the OSPFv2 or OSPFv3 area ID.</p> <p>The area-id range is from 0 to 4294967295.</p> <p>Note BGP does not support this command.</p>

Command	Purpose
<p>match route-type <i>route-type</i></p> <p>Example:</p> <pre>switch(config-route-map)# match route-type level 1 level 2</pre>	<p>Matches against a type of route. The <i>route-type</i> can be one or more of the following:</p> <ul style="list-style-type: none"> • external—The external route (BGP, EIGRP, and OSPF type 1 or 2) • inter-area—The OSPF inter-area route • internal—The internal route (including the OSPF intra- or inter-area) • intra-area—The OSPF intra-area route • level-1—The IS-IS level 1 route • level-2—The IS-IS level 2 route • local—The locally generated route • nssa-external—The NSSA external route (OSPF type 1 or 2). • type-1—The OSPF external type 1 route • type-2—The OSPF external type 2 route <p>Note BGP does not support this command.</p>
<p>match vlan <i>vlan-id</i> [<i>vlan-range</i>]</p> <p>Example:</p> <pre>switch(config-route-map)# match vlan 3, 5-10</pre>	<p>Matches against a VLAN.</p> <p>Note BGP does not support this command.</p>
<p>match rpki { invalid not-found valid }</p> <p>Example:</p> <pre>switch(config-route-map)# match rpki invalid</pre>	<p>For iBGP learned paths, matches against the incoming RPKI EXTCOMM update.</p> <p>For eBGP learned paths, matches against the validation state obtained from the ROA database lookup.</p> <p>The parameters of the match rpki command are described as follows:</p> <ul style="list-style-type: none"> • invalid: This is an invalid origin-AS in the RPKI database. • not-found: This origin-AS is unknown in the RPKI database. • valid: This is a valid origin-AS in the RPKI database.

You can configure the following optional set parameters for route maps in route-map configuration mode:

Command	Purpose
<p>set as-path { tag prepend { last-as <i>number</i> <i>as-1</i> [<i>as-2...</i>] }</p> <p>Example:</p> <pre>switch(config-route-map)# set as-path prepend 10 100 110</pre>	<p>Modifies an AS-path attribute for a BGP route. You can prepend the configured <i>number</i> of last AS numbers or a string of particular AS-path values (<i>as-1 as-2...as-n</i>).</p>
<p>set comm-list <i>name</i> delete</p> <p>Example:</p> <pre>switch(config-route-map)# set comm-list BGPCommunity delete</pre>	<p>Removes communities from the community attribute of an inbound or outbound BGP route update. Use the ip community-list command to create the community list.</p>
<p>set community { none additive local-AS no-advertise no-export graceful-shutdown blackhole <i>community-1</i> [<i>community-2...</i>] }</p> <p>Example:</p> <pre>switch(config-route-map)# set community local-AS</pre>	<p>Sets the community attribute for a BGP route update.</p> <p>Note When you use both the set community and set comm-list delete commands in the same sequence of a route map attribute, the deletion operation is performed before the set operation.</p> <p>Note Use the send-community command in BGP neighbor address-family configuration mode to propagate BGP community attributes to BGP peers.</p>
<p>set dampening <i>half life reuse suppress duration</i></p> <p>Example:</p> <pre>switch(config-route-map)# set dampening 30 1500 10000 120</pre>	<p>Sets the following BGP route dampening parameters:</p> <ul style="list-style-type: none"> • <i>half-life</i> —The range is from 1 to 45 minutes. The default is 15. • <i>reuse</i> —The range is from is 1 to 20000 seconds. The default is 750. • <i>suppress</i> —The range is from is 1 to 20000. The default is 2000. • <i>duration</i> —The range is from is 1 to 255 minutes. The default is 60.
<p>set distance <i>value</i></p> <p>Example:</p> <pre>switch(config-route-map)# set distance 150</pre>	<p>Sets the administrative distance of routes for OSPFv2 or OSPFv3. The range is from 1 to 255.</p>
<p>set extcomm-list <i>name</i> delete</p> <p>Example:</p> <pre>switch(config-route-map)# set extcomm-list BGPextCommunity delete</pre>	<p>Removes communities from the extended community attribute of an inbound or outbound BGP route update. Use the ip extcommunity-list command to create the extended community list.</p>

Command	Purpose
<p>set extcommunity 4byteas-generic { transitive nontransitive } { none additive } [community-1 [community-2...]</p> <p>Example:</p> <pre>switch(config-route-map)# set extcommunity generic transitive 1.0:30</pre>	<p>Sets the extended community attribute for a BGP route update.</p> <p>Note When you use both the set extcommunity and set extcomm-list delete commands in the same sequence of a route map attribute, the deletion operation is performed before the set operation.</p> <p>Use the send-community command in BGP neighbor address-family configuration mode to propagate BGP extended community attributes to BGP peers.</p>
<p>set extcommunity cost community-id1 cost [igp pre-bestpath] [community-id2...]</p> <p>Example:</p> <pre>switch(config-route-map)# set extcommunity cost 33 1.0:30</pre>	<p>Sets the cost community attribute for a BGP route update. This attribute allows you to customize the BGP best-path selection process for a local autonomous system or confederation. The community-id range is from 0 to 255. The <i>cost</i> range is from 0 to 4294967295. The path with the lowest cost is preferred. For paths with equal cost, the path with the lowest community ID is preferred.</p> <p>The igp keyword compares the cost after the IGP cost comparison. The pre-bestpath keyword compares before all other steps in the bestpath algorithm.</p>
<p>set extcommunity rt community-1 [additive] [community-2...]</p> <p>Example:</p> <pre>switch(config-route-map)# set extcommunity rt 1.0:30</pre>	<p>Sets the extended community route target attribute for a BGP route update. The community value can be a 2-byte AS number:4-byte network number, a 4-byte AS number:2-byte network number, or an IP address:2-byte network number.</p> <p>Use the additive keyword to add a route target to an existing extended community route target attribute.</p>
<p>set forwarding-address</p> <p>Example:</p> <pre>switch(config-route-map)# set forwarding-address</pre>	<p>Sets the forwarding address for OSPF.</p>
<p>set ip next-hop unchanged</p> <p>Example:</p> <pre>switch(config-route-map)# set ip next-hop unchanged</pre>	<p>Specifies an unchanged next-hop IP address. This command is required for BGP IPv6-over-IPv4 peering.</p> <p>Note For a BGP IPv6 unicast route with IPv4 next-hop, NX-OS does not support set IPv6 next-hop unchanged command configured in an outbound route-map configured towards a BGP neighbor.</p>
<p>set level { backbone level-1 level-1-2 level-2 }</p> <p>Example:</p> <pre>switch(config-route-map)# set level backbone</pre>	<p>Sets what area to import routes to for IS-IS. The options for IS-IS are level-1, level-1-2, or level-2. The default is level-1.</p>

Command	Purpose
set local-preference <i>value</i> Example: <pre>switch(config-route-map)# set local-preference 4000</pre>	Sets the BGP local preference value. The range is from 0 to 4294967295.
set metric [+ -] <i>bandwidth-metric</i> Example: <pre>switch(config-route-map)# set metric +100</pre>	Adds or subtracts from the existing metric value. The metric is in Kb/s. The range is from 0 to 4294967295.
set metric <i>bandwidth [delay reliability load mtu]</i> Example : <pre>switch(config-route-map)# set metric 33 44 100 200 1500</pre>	Sets the route metric values. Metrics are as follows: <ul style="list-style-type: none"> • <i>metric0</i>—Bandwidth in Kb/s. The range is from 0 to 4294967295. • <i>metric1</i>—Delay in 10-microsecond units. • <i>metric2</i>—Reliability. The range is from 0 to 255 (100 percent reliable). • <i>metric3</i>—Loading. The range is from 1 to 255 (100 percent loaded). • <i>metric4</i>—MTU of the path. The range is from 1 to 16777215.
set metric-type { external internal type-1 type-2 } Example: <pre>switch(config-route-map)# set metric-type internal</pre>	Sets the metric type for the destination routing protocol. The options are as follows: external—IS-IS external metric internal—IGP metric as the MED for BGP type-1—OSPF external type 1 metric type-2—OSPF external type 2 metric
set nssa-only Example: <pre>switch(config-route-map)# set nssa-only</pre>	Sets Type-7 LSA generated on ASBR with no P bit set. This prevents Type-7 to Type-5 LSA translation in OSPF.
set origin { egp <i>as-number</i> igp incomplete } Example: <pre>switch(config-route-map)# set origin incomplete</pre>	Sets the BGP origin attribute. The EGP <i>as-number</i> range is from 0 to 65535.

Command	Purpose
set weight count Example: <pre>switch(config-route-map)# set weight 33</pre>	Sets the weight for the BGP route. The range is from 0 to 65535.
set as-path-length difference <value> Example: <pre>switch(config-route-map)# set as-path-length difference 5</pre>	Configures the difference in as-path-length of path compared to best path for unequal cost load balance. The range is 1–255.
set metric difference <value> Example: <pre>switch(config-route-map)# set metric difference 100</pre>	Configures the difference in metric value of path compared to best path for unequal cost load balance. The range is 1–65535.
set maximum-paths <value> Example: <pre>switch(config-route-map)# set maximum-paths 5</pre>	Configures the maximum number of multipaths to be computed and installed for egress load-balancing. The range is 1–64.

The **set metric-type internal** command affects an outgoing policy and an eBGP neighbor only. If you configure both the **metric** and **metric-type internal** commands in the same BGP peer outgoing policy, Cisco NX-OS ignores the **metric-type internal** command.

Global Commands to Block the Deletion of Route-Map

This section provides the details of global commands to block the deletion of route-map. The following are the global commands:

- Use the **system default route-map validate-applied** command to enable the blocking of the deletion of route-map.
- Use the **no system default route-map validate-applied** command to disable the blocking of the deletion of route-map.
- Use the **show running-config rpm** command to view the non-default configuration.



Note By default this command is in default state.

- Use the **show running-config rpm all** command to view the default configuration.



Note By default this command is in default state.



Note The global commands are by default generic. Beginning with Cisco NX-OS release 10.2(2)F, the functionality to block the route-map deletion, if used by client is applicable only for BGP.

Verifying the Route Policy Manager Configuration

To display route policy manager configuration information, perform one of the following tasks:

Command	Purpose
<code>show ip community-list [name]</code>	Displays information about a community list.
<code>show ip ext community-list [name]</code>	Displays information about an extended community list.
<code>show [ip ipv6] prefix-list [name]</code>	Displays information about an IPv4 or IPv6 prefix list.
<code>show route-map [name]</code>	Displays information about a route map.
<code>show route-map [name] brief</code>	Provides information about blocking route-map deletion functionality and the list of clients associated with the route-map.

Configuration Examples for Route Policy Manager

This example shows how to use an address family to configure Route Policy Manager so that any unicast and multicast routes from neighbor 172.16.0.1 are accepted if they match prefix-list AllowPrefix:

```
router bgp 64496

neighbor 172.16.0.1 remote-as 64497
  address-family ipv4 unicast
    route-map filterBGP in

route-map filterBGP
  match ip address prefix-list AllowPrefix

ip prefix-list AllowPrefix 10 permit 192.0.2.0/24
ip prefix-list AllowPrefix 20 permit 172.16.201.0/27
```

Related Topics

The following topics can give more information on Route Policy Manager:

- [Configuring Basic BGP](#)



CHAPTER 18

Configuring Policy-Based Routing

This chapter contains the following sections:

- [About Policy-Based Routing, on page 547](#)
- [Prerequisites for Policy-Based Routing, on page 550](#)
- [Guidelines and Limitations for Policy-Based Routing, on page 550](#)
- [Default Settings for Policy-Based Routing, on page 553](#)
- [Configuring Policy-Based Routing, on page 553](#)
- [Verifying the Policy-Based Routing Configuration, on page 562](#)
- [Configuration Examples for Policy-Based Routing, on page 562](#)
- [Related Documents for Policy-Based Routing, on page 566](#)

About Policy-Based Routing

With policy-based routing, you can configure a defined policy for IPv4 and IPv6 traffic flows that lessens the reliance on routes derived from routing protocols. All packets received on an interface with policy-based routing enabled are passed through enhanced packet filters or route maps. The route maps dictate the policy that determines where to forward packets.

Policy-based routing includes the following features:

- **Source-based routing**—Routes traffic that originates from different sets of users through different connections across the policy routers.
- **Quality of Service (QoS)**—Differentiates traffic by setting the precedence or type of service (ToS) values in the IP packet headers at the periphery of the network and leveraging queuing mechanisms to prioritize traffic in the core or backbone of the network (see the Cisco Nexus 9000 Series NX-OS Quality of Service Configuration Guide).
- **Load sharing**—Distributes traffic among multiple paths based on the traffic characteristics.

Policy Route Maps

Each entry in a route map contains a combination of match and set statements. The match statements define the criteria for whether appropriate packets meet the particular policy (that is, the conditions to be met). The set clauses explain how the packets should be routed once they have met the match criteria.

You can mark the route-map statements as permit or deny. You can interpret the statements as follows:

- If the statement is marked as permit and the packets meet the match criteria, the set clause is applied. One of these actions involves choosing the next hop.
- If a statement is marked as deny, the packets that meet the match criteria are sent back through the normal forwarding channels, and destination-based routing is performed.
- If the statement is marked as permit and the packets do not match any route-map statements, the packets are sent back through the normal forwarding channels, and destination-based routing is performed.



Note Policy routing is specified on the interface that receives the packets, not on the interface from which the packets are sent.

Set Criteria for Policy-Based Routing

The Cisco Nexus 9000 Series switches support the following **set** commands for route maps used in policy-based routing:

- **set {ip | ipv6} next-hop**
- **set {ip | ipv6} default next-hop**
- **set {ip | ipv6} vrf *vrf-name* next-hop**
- **set {ip | ipv6} default vrf *vrf-name* next-hop**
- **set interface null0**

These **set** commands are mutually exclusive within the route-map sequence.

In the first command, the IP address specifies the adjacent next-hop router in the path toward the destination to which the packets should be forwarded. The first IP address associated with a currently up connected interface is used to route the packets.



Note You can optionally configure this command for next-hop addresses to load balance traffic for up to 32 IP addresses. In this case, Cisco NX-OS sends all traffic for each IP flow to a particular IP next-hop address.

If the packets do not meet any of the defined match criteria, those packets are routed through the normal destination-based routing process.

For more information on set commands configuration, see [Configuring a Route Policy, on page 556](#) section.

Route Map Support Matrix for Policy-Based Routing

The following tables include the configurable match and set statements for policy-based routing on Cisco Nexus 9000 Series Switches running the latest shipping release.

The following legend applies to the tables:

- Yes—The statement is supported for policy-based routing.

- No—The statement is not supported for policy-based routing.
- If a statement does not apply for policy-based routing, there is an em dash (—) in the column next to the statement.
- Where clarification is required, information is added in the appropriate row/column.

Table 28: SET Route Map Statements for Policy-Based Routing

SET Route Map Statement	Policy-Based Routing (PBR)
IPv4 Next Hop	Yes
IPv6 Next Hop	Yes
IPv4 vrf Next Hop	Yes
IPv6 vrf Next Hop	Yes
Default IPv4 Next Hop	Yes
Default IPv6 Next Hop	Yes
Default IPv4 vrf Next Hop	Yes
Default IPv6 vrf Next Hop	Yes
IPv4 Next Hop Verify Availability	Yes
IPv6 Next Hop Verify Availability	Yes
IPv4 vrf Next Hop Verify Availability	Yes
IPv6 vrf Next Hop Verify Availability	Yes
Default IPv4 Next Hop Verify Availability	Yes
Default IPv6 Next Hop Verify Availability	Yes
Default IPv4 vrf Next Hop Verify Availability	Yes
Default IPv6 vrf Next Hop Verify Availability	Yes
Interface null0	Yes
VRF	No

Route-Map Processing Logic

When an interface with a route map receives a packet, the forwarding logic processes each route-map statement according to the sequence number.

If the route-map statement encountered is a route-map...permit statement, the packet is matched against the criteria in the **match** command. This command may refer to an ACL that has one or more access control

entries (ACEs). If the packet matches the permit ACEs in the ACL, the policy-based routing logic executes the action that the **set** command specifies on the packet.

If the route-map statement encountered is a route-map... deny statement, the packet is matched against the criteria in the match command. This command may refer to an ACL that has one or more ACEs. If the packet matches the permit ACEs in the ACL, policy-based routing processing stops, and the packet is routed using the default IP routing table.



Note The **set** command has no effect inside a **route-map... deny** statement.

- If the route-map configuration does not contain a match statement, the policy-based routing logic executes the action specified by the **set** command on the packet. All packets are routed using policy-based routing.
- If the route-map configuration references a match statement but the match statement references a non-existing ACL or an existing ACL without any access control entries (ACEs), the packet is routed using the default routing table.
- If the next-hop specified in the **set { ip | ipv6 } next-hop** command is down, is not reachable, or is removed, the packet is routed using the default routing table.

Beginning Cisco NX-OS Release 9.2(3), you can balance policy-based routing traffic if the next hop is recursive over ECMP paths using the **next-hop ip-address load-share** command. This situation is supported on the following switches, line cards, and modules:

- N9K-C9372TX
- N9K-X9564TX
- N9K-X9732C-EX

For all the next hop routing requests, the Routing Profile Manager (RPM) resolves them using unicast Routing Information Base (uRIB). RPM also programs all ECMP paths, which helps to uniformly load balance all the ECMP paths. PBR over ECMP is supported only on IPv4.

Prerequisites for Policy-Based Routing

Policy-based routing has the following prerequisites:

- Install the correct license.
- You must enable policy-based routing.
- Assign an IP address on the interface and bring the interface up before you apply a route map on the interface for policy-based routing.

Guidelines and Limitations for Policy-Based Routing

Policy-based routing has the following configuration guidelines and limitations:

- Cisco Nexus 9500 platform switches with 9700-EX/FX line cards do not support PBR IPv6 Default Next hop for FIB Miss traffic.
- The following switches support IPv4 and IPv6 policy-based routing:
 - Cisco Nexus 9200 platform switches
 - Cisco Nexus 9300-EX/FX/FX2/FX3/GX platform switches
 - Cisco Nexus 9508 switches with 9636C-R, 9636C-RX, and 9636Q-R line cards (For these line cards, PBR policy has a higher priority over attached and local routes. Explicit white listing might be required if protocol neighbors are directly attached.)
- A policy-based routing route map can have only one match statement per route-map statement.
- A policy-based routing route map can have only one set statement per route-map statement, unless you are using IP SLA policy-based routing. For information on IP SLA policy-based routing, see the *Cisco Nexus 9000 Series NX-OS IP SLAs Configuration Guide*.



Note Cisco Nexus 9508 switches with 9636C-R, 9636C-RX, and 9636Q-R line cards do not support IP SLA.

- A match command cannot refer to more than one ACL in a route map used for policy-based routing.
- The same route map can be shared among different interfaces for policy-based routing as long as the interfaces belong to the same virtual routing and forwarding (VRF) instance.
- Using a prefix list as a match criteria is not supported. Do not use a prefix list in a policy-based routing route map.
- Policy-based routing supports only unicast traffic. Multicast traffic is not supported.
- Policy-based routing is not supported with inbound traffic on FEX ports.
- Policy-based routing is not supported on FEX ports for Cisco Nexus 9300-EX platform switches.
- Only Cisco Nexus 9508 switches with 9636C-R, 9636C-RX, and 9636Q-R line cards support policy-based routing with Layer 3 port-channel subinterfaces.
- Beginning with Cisco NX-OS Release 10.1(2), policy-based routing with Layer 3 port-channel subinterfaces are supported on Cisco Nexus 9300-X Cloud Scale Switches.
- An ACL used in a policy-based routing route map cannot include deny access control entries (ACEs).
- Policy-based routing is supported only in the default system routing mode.
- Cisco Nexus 9000 Series switches do not support the **set vrf** command.
- When you configure multiple features on an interface (such as PBR and ingress ACL), the ACLs for those features are merged for TCAM optimization. As a result, statistics are not supported.
- For PBR with VXLAN, the load-share keyword is not required.



Note Cisco Nexus 9500 platform switches with the 9700-EX/FX line cards support IPv4/IPv6 policy-based routing over VXLAN. Cisco Nexus 9508 switches with 9636C-R, 9636C-RX, and 9636Q-R line cards do not support policy-based routing over VXLAN.

- The Cisco Nexus 9000 Series switches support policy-based ACLs (PBACLs), also referred to as object-group ACLs. For more information, see the *Cisco Nexus 9000 Series NX-OS Security Configuration Guide*.



Note Cisco Nexus 9508 switches with 9636C-R, 9636C-RX, and 9636Q-R line cards do not support PBACLs.

- The following guidelines and limitations apply to PBR over VXLAN EVPN:
 - PBR over VXLAN EVPN is supported only for Cisco Nexus 9300-EX/FX/FX2/FX3/GX/GX2 platform switches.
 - PBR over VXLAN EVPN does not support the following features: VTEP ECMP and the load-share keyword in the **set {ip | ipv6} next-hop ip-address** command.
 - PBR over VXLAN EVPN support **set {ip | ipv6} vrf vrf-name next-hop ip-address** command, and by using multiple lines of **set {ip | ipv6} vrf vrf-name next-hop ip-address** command PBR over VXLAN EVPN supports different VRF on each multiple next-hop.
- The following guidelines and limitations apply to PBR over tunnel interface:
 - Beginning with Cisco NX-OS Release 10.3(3)F, the PBR next-hop redirecting to a tunnel interface is supported on Cisco Nexus 9000 Series platform switches with the following limitations:
 - Only **gre ip** and **ipip ip** modes are supported.
 - The **load-share** keyword in the route-map, won't be supported if multiple configured next-hops resolve to combination of tunnel interface and non-tunnel interface.
 - Overlay ECMP (same next-hop resolving to multiple tunnels with equal cost path) is not supported.
- The following guidelines and limitations apply to PBR fast convergence:
 - PBR fast convergence is supported only for policies that have route-map sequences defined with multiple alternate next-hops, without load-share option, and with SLA probes for tracking next-hop availability.
 - Simultaneous failures of primary and back-up next-hops are not handled in the fast path. In such events, the system will fall back to control plane updates.
 - PBR fast convergence is primarily supported in events where adjacency loss is detected.
 - PBR fast convergence is not supported for next-hops reachable over VXLAN.

- PBR fast convergence should not be used when next-hops are specified with millisecond SLAs/tracks to track availability.

For more information about SLA, see the *Cisco Nexus 9000 Series NX-OS IP SLAs Configuration Guide*.

- When PBR fast convergence is disabled, the number of ACL redirect entries is proportional to the number of unique primary next-hops across the PBR policies. When PBR fast convergence is enabled, the system may require ACL redirect entries per port-slice that is proportional to the number of unique combinations of primary and back-up next-hops configured across the route-map sequences in the PBR policies.
- The following platforms support PBR fast convergence: N9K-C93180YC-FX, N9K-C93180YC2-FX, N9K-C93180YC-FX-24, N9K-C93108TC-FX, N9K-C93108TC2-FX, N9K-C93108TC-FX-24, N9K-C9336C-FX2, N9K-C93240YC-FX2, N9K-C93360YC-FX2, N9K-C93216TC-FX2, N9K-C9336C-FX2-E, N9K-C9316D-GX, N9K-C93600CD-GX, N9K-C9364C-GX.
- Beginning with Cisco NX-OS Release 10.3(2)F, default IPv4/IPv6 next-hop VRF selection for PBR is provided on Cisco Nexus 9000 Series platform switches.
- Beginning with Cisco NX-OS Release 10.3(2)F, PBR over IP Tunnels is supported only for tunnels having gre and ipip mode. However, PBR over IP Tunnels does not support the **load-share** keyword in all variants of **set {ip | ipv6} next-hop** commands.

Default Settings for Policy-Based Routing

Table 29: Default Policy-Based Routing Parameters

Parameters	Default
Policy-based routing	Disabled

Configuring Policy-Based Routing

Enabling the Policy-Based Routing Feature

You must enable the policy-based routing feature before you can configure a route policy.

SUMMARY STEPS

1. **configure terminal**
2. **[no] feature pbr**
3. (Optional) **show feature**
4. (Optional) **copy running-config startup-config**

DETAILED STEPS

	Command or Action	Purpose
Step 1	configure terminal Example: switch# configure terminal switch(config)#	Enters global configuration mode.
Step 2	[no] feature pbr Example: switch(config)# feature pbr	Enables the policy-based routing feature. Use the no form of this command to disable the policy-based routing feature. Note The no feature pbr command removes the policies applied under the interfaces. It does not remove the ACL or route-map configuration nor does it create a system checkpoint.
Step 3	(Optional) show feature Example: switch(config)# show feature	Displays enabled and disabled features.
Step 4	(Optional) copy running-config startup-config Example: switch(config)# copy running-config startup-config	Copies the running configuration to the startup configuration.

Enabling the Policy-Based Routing over ECMP

PBR over ECMP is not enabled by default. You must enable the policy-based routing feature before you can configure a route policy.

SUMMARY STEPS

1. **configure terminal**
2. **[no] feature pbr**
3. (Optional) **show feature**
4. **[no] hardware profile pbr ecmp paths max-paths**
5. **show system internal rpm state**

DETAILED STEPS

	Command or Action	Purpose
Step 1	configure terminal Example: switch# configure terminal switch(config)#	Enters global configuration mode.

	Command or Action	Purpose
Step 2	<p>[no] feature pbr</p> <p>Example:</p> <pre>switch(config)# feature pbr</pre>	<p>Enables the policy-based routing feature.</p> <p>Use the no form of this command to disable the policy-based routing feature.</p> <p>Note The no feature pbr command removes the policies applied under the interfaces. It does not remove the ACL or route-map configuration nor does it create a system checkpoint.</p>
Step 3	<p>(Optional) show feature</p> <p>Example:</p> <pre>switch(config)# show feature</pre>	Displays enabled and disabled features.
Step 4	<p>[no] hardware profile pbr ecmp paths max-paths</p> <p>Example:</p> <pre>switch(config)# hardware profile pbr ecmp paths max-paths 12 Warning!!: The pbr ecmp path limits have been changed. Please reload the switch now for the change to take effect. switch(config)# switch(config)# no hardware profile pbr ecmp paths max-paths 12 Warning!!: The pbr ecmp path limits have been changed. Please reload the switch now for the change to take effect. switch(config)#</pre>	<p>Configure the number of ECMP paths for IP next hop. However, the traffic may not go through all the paths unless you explicitly configure the load share in the set IP next hop. Whenever you remove or modify the PBR ECMP paths, the changes will take effect only after next reload. The range is from 1 through 64.</p>
Step 5	show system internal rpm state	Displays the currently configured and operational values of PBR ECMP paths.

Configuring PBR Fast Convergence

In the case of a failure of a next-hop that is currently in use in PBR, PBR fast convergence can reduce the traffic convergence time to sub-second. PBR fast convergence assists policies that have route-map sequences defined with multiple alternate next-hops, without the load-share option, and with SLA probes for tracking next-hop availability.

PBR fast convergence is disabled on the switch by default. After configuring PBR fast convergence and saving the configuration, you must reload the switch to activate PBR fast convergence.

Before you begin

You must enable the policy-based routing feature before you can configure PBR fast convergence.

SUMMARY STEPS

1. **configure terminal**
2. **[no] feature pbr**
3. **[no] hardware profile pbr next-hop fast-convergence**
4. **copy running-config startup-config**

DETAILED STEPS

	Command or Action	Purpose
Step 1	configure terminal Example: <pre>switch# configure terminal switch(config)#</pre>	Enters global configuration mode.
Step 2	[no] feature pbr Example: <pre>switch(config)# feature pbr</pre>	Enables the policy-based routing feature.
Step 3	[no] hardware profile pbr next-hop fast-convergence Example: <pre>switch(config)# hardware profile pbr next-hop fast-convergence</pre>	Configures PBR fast convergence. Use the no form of this command to disable PBR fast convergence. Note Enabling or disabling PBR fast convergence takes effect after the switch is reloaded.
Step 4	copy running-config startup-config Example: <pre>switch(config)# copy running-config startup-config</pre>	Copies the running configuration to the startup configuration.

Example

This example enables PBR fast convergence and reloads the switch:

```
switch(config)# hardware profile pbr next-hop fast-convergence
Warning: Please save config and reload the system for the configuration to take effect.
switch(config)# copy running-config startup-config
switch(config)# reload
```

What to do next

After enabling or disabling PBR fast convergence and saving the configuration, reload the switch.

Configuring a Route Policy

You can use route maps in policy-based routing to assign routing policies to the inbound interface. Cisco NX-OS routes the packets when it finds a next hop and an interface.

SUMMARY STEPS

1. **configure terminal**
2. **interface** *type slot/port*
3. **ip policy route-map** *map-name*
4. **ipv6 policy route-map** *map-name*
5. **match** {ip | ipv6} **address** [*accesslist-name*]
6. **set** {ip | ipv6} **next-hop** *address1* [*address2...*] [*load-share*] [*drop-on-fail*] [*force-order*]
7. **set** {ip | ipv6} **vrf** *vrf-name* **next-hop** *address1* [*address2...*] [*force-order*] [*drop-on-fail*] [*load-share*]
8. **set** {ip | ipv6} **default next-hop** *address2* [*address2...*] [*load-share*]
9. **set** {ip | ipv6} **default vrf** *vrf-name* **next-hop** *address1* [*address2...*] [*load-share*]
10. **set** {ip | ipv6} **next-hop verify-availability** *next-hop-address* **track** *object*
11. **set** {ip | ipv6} **vrf** *vrf-name* **next-hop verify-availability** *next-hop-address* **track** *object*
12. **set** {ip | ipv6} **default next-hop verify-availability** *next-hop-address* **track** *object*
13. **set** {ip | ipv6} **default vrf** *vrf-name* **next-hop verify-availability** *next-hop-address* **track** *object*
14. **set interface** {*null0*}

DETAILED STEPS

	Command or Action	Purpose
Step 1	configure terminal Example: switch# configure terminal	Enters global configuration mode.
Step 2	interface <i>type slot/port</i> Example: switch(config)# interface ethernet 1/2 switch(config-if)#	Enters interface configuration mode.
Step 3	ip policy route-map <i>map-name</i> Example: switch(config-if)# ip policy route-map Testmap switch(config-route-map)#	Assigns a route map for IPv4 policy-based routing to the interface.
Step 4	ipv6 policy route-map <i>map-name</i> Example: switch(config-if)# ipv6 policy route-map Testmap switch(config-route-map)#	Assigns a route map for IPv6 policy-based routing to the interface.
Step 5	match {ip ipv6} address [<i>accesslist-name</i>] Example: For IPv4 switch(config-route-map)# match ip address ACL1_v4 For IPv6	Matches an IPv4 or IPv6 address against one or more IP or IPv6 access control lists (ACLs). This command is used for policy-based routing and is ignored by route filtering or redistribution.

	Command or Action	Purpose
	<pre>switch(config-route-map)# match ipv6 address ACL1_v6</pre>	
Step 6	<p>set {ip ipv6} next-hop address1 [address2...][load-share] [drop-on-fail] [force-order]</p> <p>Example:</p> <p>For IPv4</p> <pre>switch(config-route-map)# set ip next-hop 192.0.2.1</pre> <p>For IPv6</p> <pre>switch(config-route-map)# set ipv6 next-hop 2001:0DB8::1</pre>	<p>Sets the IPv4 or IPv6 next-hop address for policy-based routing. This command uses the first valid next-hop address if multiple addresses are configured.</p> <p>Use the optional load-share keyword to load balance traffic across a maximum of 32 next-hop addresses.</p> <p>Use the optional force-order keyword to enable next-hop ordering as specified in the CLI.</p> <p>Use the optional drop-on-fail keyword to drop packets instead of using default routing when the configured next hop becomes unreachable. This option is supported for Cisco Nexus 9200, 9300-EX/FX/FX2 and 9364C platform switches and Cisco Nexus 9500 platform switches with -EX/FX line cards.</p>
Step 7	<p>set {ip ipv6} vrf vrf-name next-hop address1 [address2...][force-order] [drop-on-fail][load-share]</p> <p>Example:</p> <p>For IPv4</p> <pre>switch(config-route-map)# set ip vrf vrf1 next-hop 192.0.2.2</pre> <p>For IPv6</p> <pre>switch(config-route-map)# set ipv6 vrf vrf1 next-hop 2001:0DB8::1</pre>	<p>Sets the IPv4 or IPv6 next-hop address based on default or user-defined vrf for policy-based routing.</p> <p>This command supports inter-VRF routing packets arriving at a VRF interface are routed through any other VRF based on configured next-hop.</p> <p>This command uses the first valid next-hop address if multiple addresses are configured.</p> <p>Use the optional force-order keyword to enable next-hop ordering as specified in the CLI.</p> <p>Use the optional drop-on-fail keyword to drop packets instead of using default routing when the configured next hop becomes unreachable. This option is supported for Cisco Nexus 9200, 9300-EX/FX/FX2 and 9364C platform switches and Cisco Nexus 9500 platform switches with -EX/FX line cards.</p> <p>Use the optional load-share keyword to load balance traffic across a maximum of 32 next-hop addresses.</p>
Step 8	<p>set {ip ipv6} default next-hop address2 [address2...][load-share]</p> <p>Example:</p> <p>For IPv4</p> <pre>switch(config-route-map)#set ip default next-hop 192.0.2.2</pre> <p>For IPv6</p> <pre>switch(config-route-map)#set ipv6 default next-hop 2001:0DB8::1</pre>	<p>Sets the IPv4 or IPv6 next-hop address for policy-based routing when there is no explicit route to a destination. This command uses the first valid next-hop address if multiple addresses are configured. This can be done with next-hop tracking only.</p> <ul style="list-style-type: none"> Use the optional load-share keyword to load balance traffic across a maximum of 32 next-hop addresses. <p>From Cisco NX-OS Release 10.2(2)F, below are supported:</p> <ul style="list-style-type: none"> Command set ip default next-hop is supported on GX, GX2, and FX3 platform switches.

	Command or Action	Purpose
		<ul style="list-style-type: none"> Use the optional verify-availability keyword to verify the reachability of the tracked object. <p>Note This command is currently not supported on N9K-C950x.</p>
<p>Step 9</p>	<p>set {ip ipv6} default vrf vrf-name next-hop address1 [address2...] [load-share]</p> <p>Example:</p> <p>For IPv4</p> <pre>switch(config-route-map)# set ip default vrf vrf1 next-hop 192.0.2.2</pre> <p>For IPv6</p> <pre>switch(config-route-map)# set ipv6 default vrf vrf1 next-hop 2001:0DB8::1</pre>	<p>Sets the IPv4 or IPv6 next-hop address for policy-based routing when there is no explicit route to a destination.</p> <p>This command supports inter-VRF routing packets arriving at a VRF interface that are routed through any other VRF based on configured next-hop.</p> <p>This command uses the first valid next-hop address if multiple addresses are configured.</p> <p>Note This command does not allow multiple VRFs in set statement.</p> <p>Use the optional load-share keyword to load balance traffic across a maximum of 32 next-hop addresses.</p>
<p>Step 10</p>	<p>set {ip ipv6} next-hop verify-availability next-hop-address track object</p> <p>Example:</p> <pre>switch(config-route-map)# set ip next-hop verify-availability 192.0.2.2 track 1</pre>	<p>Sets the IPv4 or IPv6 next-hop address for policy-based routing.</p> <p>Use this command to configure policy routing to verify the reachability of the next hop of the route map before the switch performs policy routing to that next hop. Repeat this step to configure the route map to verify the reachability of other tracked objects.</p> <p>Note For additional information about object tracking, see the Cisco Nexus 9000 Series NX-OS IP SLAs Configuration Guide.</p>
<p>Step 11</p>	<p>set {ip ipv6} vrf vrf-name next-hop verify-availability next-hop-address track object</p> <p>Example:</p> <pre>switch(config-route-map)# set ip vrf vrf1 next-hop verify-availability 192.0.2.2 track 1</pre>	<p>Sets the IPv4 or IPv6 next-hop address based on default or user-defined vrf for policy-based routing.</p> <p>This command supports inter-VRF routing packets arriving at a VRF interface are routed through any other VRF based on configured next-hop.</p> <p>Use this command to configure policy routing to verify the reachability of the next hop of the route map before the switch performs policy routing to that next hop. Repeat this step to configure the route map to verify the reachability of other tracked objects.</p> <p>Note For additional information about object tracking, see the Cisco Nexus 9000 Series NX-OS IP SLAs Configuration Guide.</p>

	Command or Action	Purpose
Step 12	<p>set {ip ipv6} default next-hop verify-availability next-hop-address track object</p> <p>Example:</p> <pre>switch(config-route-map)# set ip default next-hop verify-availability 192.0.2.2 track 1</pre>	<p>Sets the IPv4 or IPv6 next-hop address for policy-based routing when there is no explicit route to a destination.</p> <p>Use this command to configure policy routing to verify the reachability of the next hop of the route map before the switch performs policy routing to that next hop. Repeat this step to configure the route map to verify the reachability of other tracked objects.</p> <p>Note For additional information about object tracking, see the Cisco Nexus 9000 Series NX-OS IP SLAs Configuration Guide.</p>
Step 13	<p>set {ip ipv6} default vrf vrf-name next-hop verify-availability next-hop-address track object</p> <p>Example:</p> <pre>switch(config-route-map)# set ip default vrf vrf1 next-hop verify-availability 192.0.2.2 track 1</pre>	<p>Sets the IPv4 or IPv6 next-hop address for policy-based routing when there is no explicit route to a destination.</p> <p>This command supports inter-VRF routing packets arriving at a VRF interface that are routed through any other VRF based on configured next-hop.</p> <p>Use this command to configure policy routing to verify the reachability of the default VRF next hop of the route map before the switch performs policy routing to that next hop. Repeat this step to configure the route map to verify the reachability of other tracked objects.</p> <p>Note For additional information about object tracking, see the Cisco Nexus 9000 Series NX-OS IP SLAs Configuration Guide.</p>
Step 14	<p>set interface {null0}</p> <p>Example:</p> <pre>switch(config-route-map)# set interface null0</pre>	<p>Sets the interface used for routing. Use the null0 interface to drop packets.</p>

Redirecting Default Route Match to Next-Hop

Beginning with Cisco NX-OS Release 10.3(3)F, you can redirect the default route match to next-hop on Cisco Nexus 9300-EX/FX/FX2/GX platform switches.

SUMMARY STEPS

1. **configure terminal**
2. **[no] feature pbr**
3. **hardware access-list tcam pbr match-default-route**
4. **{ip | ipv6} policy route-map map-name**
5. **route-map map-name**
6. **match {ip | ipv6} address [accesslist-name]**
7. **set {ip | ipv6} default next-hop address2 [address2...] [load-share]**

DETAILED STEPS

	Command or Action	Purpose
Step 1	configure terminal Example: <pre>switch# configure terminal switch(config)#</pre>	Enters global configuration mode.
Step 2	[no] feature pbr Example: <pre>switch(config)# feature pbr</pre>	Enables the policy-based routing feature.
Step 3	hardware access-list tcam pbr match-default-route Example: <pre>switch(config)# hardware access-list tcam pbr match-default-route</pre>	<p>Redirects the packets that match the default route to a specified Next-Hop in the policy.</p> <p>When the hardware access-list tcam pbr match-default-route command is used, the following order is followed during traffic forwarding:</p> <p>Specific FIB route => PBR => Default route Explanation - Specific route will be preferred over PBR 2)</p> <p>Note When the command is enabled, it will take effect on all the new polices configured.</p> <p>If this command is not enabled, the following order is followed during traffic forwarding:</p> <p>Any FIB route (specific route or default route) => PBR Explanation - Any route (specific route or default route) will be preferred over PBR 3)</p>
Step 4	{ip ipv6} policy route-map map-name Example: For IPv4 <pre>switch(config-if)# ip policy route-map Testmap</pre> For IPv6 <pre>switch(config-if)# ipv6 policy route-map Testmap</pre>	Assigns a route map for IPv4/IPv6 policy-based routing to the interface.
Step 5	route-map map-name Example: <pre>switch(config-if)# route-map Testmap switch(config-route-map)#</pre>	Creates a route map or enters route-map configuration mode for an existing route map.
Step 6	match {ip ipv6} address [accesslist-name] Example: For IPv4	Matches an IPv4 or IPv6 address against one or more IP or IPv6 access control lists (ACLs). This command is used for policy-based routing and is ignored by route filtering or redistribution.

	Command or Action	Purpose
	<pre>switch(config-route-map)# match ip address ACL1_v4</pre> <p>For IPv6</p> <pre>switch(config-route-map)# match ipv6 address ACL1_v6</pre>	
Step 7	<p>set {ip ipv6} default next-hop address2 [address2...] [load-share]</p> <p>Example:</p> <p>For IPv4</p> <pre>switch(config-route-map)#set ip default next-hop 192.0.2.2</pre> <p>For IPv6</p> <pre>switch(config-route-map)#set ipv6 default next-hop 2001:0DB8::1</pre>	<p>Sets the IPv4 or IPv6 next-hop address for policy-based routing when there is no explicit route to a destination. This command uses the first valid next-hop address if multiple addresses are configured. This can be done with next-hop tracking only.</p> <ul style="list-style-type: none"> • Use the optional load-share keyword to load balance traffic across a maximum of 32 next-hop addresses. • Command set ip default next-hop is supported on GX, GX2, and FX3 platform switches. • Use the optional verify-availability keyword to verify the reachability of the tracked object.

Verifying the Policy-Based Routing Configuration

To display policy-based routing configuration information, perform one of the following tasks:

Command	Purpose
show [ip ipv6] policy [name]	Displays information about an IPv4 or IPv6 policy.
show route-map [name] pbr-statistics	Displays policy statistics.

Use the **route-map map-name pbr-statistics** command to enable policy statistics. Use the **clear route-map map-name pbr-statistics** command to clear these policy statistics.

Configuration Examples for Policy-Based Routing

This example shows how to configure a simple route policy on an interface:

```
feature pbr
ip access-list pbr-sample_1
  permit tcp host 10.1.1.1 host 192.168.2.1 eq 80
ip access-list pbr-sample_2
  permit tcp host 10.1.1.2 host 192.168.2.2 eq 80
!
route-map pbr-sample permit 10
match ip address pbr-sample_1
set ip next-hop 192.168.1.1
route-map pbr-sample permit 20
match ip address pbr-sample_2
set ip next-hop 192.168.1.2
!
```

```

route-map pbr-sample pbr-statistics

interface ethernet 1/2
 ip policy route-map pbr-sample

```

The following output verifies this configuration:

```

switch# show route-map pbr-sample

route-map pbr-sample, permit, sequence 10
 Match clauses:
  ip address (access-lists): pbr-sample_1
 Set clauses:
  ip next-hop 192.168.1.1
route-map pbr-sample, permit, sequence 20
 Match clauses:
  ip address (access-lists): pbr-sample_2
 Set clauses:
  ip next-hop 192.168.1.2

switch# show route-map pbr-sample pbr-statistics

route-map pbr-sample, permit, sequence 10
Policy routing matches: 84 packets

route-map pbr-sample, permit, sequence 20
Policy routing matches: 94 packets

Default routing: 233 packets

```



Note **Policy routing matches** shown against every route-map sequence contains the number of packets in the incoming data traffic that has a match with the sequence in the route-map. This counter increments irrespective of whether the PBR redirection ('set' command of that sequence) is resolved or not. Correspondingly, in the example shown above, policy routing matches is shown against two route-map sequence (sequence 10 and 20) in the show route-map pbr-statistics pbr-sample output.



Note **Default routing** contains the number of packets in the incoming data traffic that has no match with any of the sequence in the route-map. Correspondingly, in the example shown above, default routing is shown only once at the end in the show route-map pbr-statistics pbr-sample output.

This example shows load sharing between ECMP and non ECMP paths:

```

switch# show run rpm
!Command: show running-config rpm
!Running configuration last done at: Sun Dec 23 16:02:32 2018
!Time: Sun Dec 23 16:06:13 2018

version 9.2(3) Bios:version 08.35
feature pbr

route-map policy1 pbr-statistics
route-map policy1 permit 10
  match ip address acl2
  set ip next-hop 131.1.1.2 load-share
route-map policy2 pbr-statistics
route-map policy2 permit 10
  match ip address acl2

```

```

set ip next-hop verify-availability 131.1.1.2 track 1
set ip next-hop verify-availability 30.1.1.2 track 2 load-share

interface Ethernet1/31
 ip policy route-map policy2

```

This example displays information about next hop routing request:

```

switch# show system internal rpm pbr ip nexthop
PBR IPv4 nexthop table for vrf default

30.1.1.2 Usable
  via 28.1.1.2 Ethernet1/18 a46c.2ae3.02a7

131.1.1.2 Usable
  via 111.1.1.2 Vlan81 8478.ac58.afc1
Usable
  via 112.1.1.2 Vlan82 8478.ac58.afc1
Usable
  via 113.1.1.2 Vlan83 8478.ac58.afc1
Usable
  via 114.1.1.2 Vlan84 8478.ac58.afc1
Usable
  via 115.1.1.2 Vlan85 8478.ac58.afc1
Usable
  via 116.1.1.2 Vlan86 8478.ac58.afc1
Usable
  via 117.1.1.2 Vlan87 8478.ac58.afc1
Usable
  via 118.1.1.2 Vlan88 8478.ac58.afc1

```

This example display routes from the unicast RIB:

```

switch# show ip route 130.1.1.2
IP Route Table for VRF "default"
 '*' denotes best ucast next-hop
 '**' denotes best mcast next-hop
 '[x/y]' denotes [preference/metric]
 '%<string>' in via output denotes VRF <string>

130.1.1.0/24, ubest/mbest: 8/0
  *via 111.1.1.2, Vlan81, [110/120], 00:07:57, ospf-1, inter
  *via 112.1.1.2, Vlan82, [110/120], 00:07:57, ospf-1, inter
  *via 113.1.1.2, Vlan83, [110/120], 00:07:57, ospf-1, inter
  *via 114.1.1.2, Vlan84, [110/120], 00:07:57, ospf-1, inter
  *via 115.1.1.2, Vlan85, [110/120], 00:07:57, ospf-1, inter
  *via 116.1.1.2, Vlan86, [110/120], 00:07:57, ospf-1, inter
  *via 117.1.1.2, Vlan87, [110/120], 00:07:57, ospf-1, inter
  *via 118.1.1.2, Vlan88, [110/120], 00:07:57, ospf-1, inter

switch# show ip route 30.1.1.2
IP Route Table for VRF "default"
 '*' denotes best ucast next-hop
 '**' denotes best mcast next-hop
 '[x/y]' denotes [preference/metric]
 '%<string>' in via output denotes VRF <string>

30.1.1.0/24, ubest/mbest: 1/0
  *via 28.1.1.2, [1/0], 00:38:36, static

```

This example displays Policy-Based Routing with vrf-based next hop:

```
route-map policy_vrf_default_v4 permit 10
  match ip address acl1_v4_tc1
  set ip vrf default next-hop 31.1.1.1

route-map policy_vrf_nondefault_v4 permit 10
  match ip address acl1_v4_tc2
  set ip vrf vrf1 next-hop 32.1.1.1

show route-map policy_vrf_default_v4
route-map policy_vrf_default_v4, permit, sequence 10
  Match clauses:
    ip address (access-lists): acl1_v4_tc1
  Set clauses:
    ip vrf default next-hop 31.1.1.1

show route-map policy_vrf_nondefault_v4
route-map policy_vrf_nondefault_v4, permit, sequence 10
  Match clauses:
    ip address (access-lists): acl1_v4_tc2
  Set clauses:
    ip vrf vrf1 next-hop 32.1.1.1
```

This example displays Policy-Based Routing with default next hop:

```
route-map policy_default_v4 permit 10
  match ip address acl1_v4_tc1
  set ip default next-hop 21.1.1.2

show route-map policy_default_v4
route-map policy_default_v4, permit, sequence 10
  Match clauses:
    ip address (access-lists): acl1_v4_tc1
  Set clauses:
    ip default next-hop 21.1.1.2
```

This example displays Policy-Based Routing with vrf-based default next hop:

```
route-map policy_default_vrf_default_v4 permit 10
  match ip address acl1_v4_tc1
  set ip default vrf default next-hop 21.1.1.2
route-map policy_default_vrf_nondefault_v4 permit 10
  match ip address acl1_v4_tc1
  set ip default vrf vrf1 next-hop 22.1.1.2

show route-map policy_default_vrf_default_v4
route-map policy_default_vrf_default_v4, permit, sequence 10
  Match clauses:
    ip address (access-lists): acl1_v4_tc1
  Set clauses:
    ip default vrf default next-hop 21.1.1.2
show route-map policy_default_vrf_nondefault_v4
route-map policy_default_vrf_nondefault_v4, permit, sequence 10
  Match clauses:
    ip address (access-lists): acl1_v4_tc1
  Set clauses:
    ip default vrf vrf1 next-hop 22.1.1.2
```

Related Documents for Policy-Based Routing

Related Topic	Document Title
IP SLA PBR object tracking	Cisco Nexus 9000 Series NX-OS IP SLAs Configuration Guide
Troubleshooting information	Cisco Nexus 9000 Series NX-OS Troubleshooting Guide



CHAPTER 19

Configuring HSRP

This chapter contains the following sections:

- [About HSRP, on page 567](#)
- [HSRP Subnet VIP, on page 571](#)
- [HSRP Authentication, on page 571](#)
- [HSRP Messages, on page 571](#)
- [HSRP Load Sharing, on page 572](#)
- [Object Tracking and HSRP, on page 572](#)
- [vPCs and HSRP, on page 573](#)
- [BFD, on page 573](#)
- [High Availability and Extended Nonstop Forwarding, on page 573](#)
- [Virtualization Support, on page 574](#)
- [Prerequisites for HSRP, on page 574](#)
- [Guidelines and Limitations for HSRP, on page 574](#)
- [Default Settings for HSRP Parameters, on page 576](#)
- [Configuring HSRP, on page 576](#)
- [Verifying the HSRP Configuration, on page 589](#)
- [Configuration Examples for HSRP, on page 590](#)
- [Additional References, on page 591](#)

About HSRP

HSRP is a first-hop redundancy protocol (FHRP) that allows a transparent failover of the first-hop IP router. HSRP provides first-hop routing redundancy for IP hosts on Ethernet networks configured with a default router IP address. You use HSRP in a group of routers for selecting an active router and a standby router. In a group of routers, the active router is the router that routes packets; the standby router is the router that takes over when the active router fails or when preset conditions are met.

Many host implementations do not support any dynamic router discovery mechanisms but can be configured with a default router. Running a dynamic router discovery mechanism on every host is not practical for many reasons, including administrative overhead, processing overhead, and security issues. HSRP provides failover services to these hosts.

HSRP Overview

When you use HSRP, you configure the HSRP *virtual IP address* as the host's default router (instead of the IP address of the actual router). The virtual IP address is an IPv4 or IPv6 address that is shared among a group of routers that run HSRP.

When you configure HSRP on a network segment, you provide a *virtual MAC address* and a virtual IP address for the HSRP group. You configure the same virtual address on each HSRP-enabled interface in the group. You also configure a unique IP address and MAC address on each interface that acts as the real address. HSRP selects one of these interfaces to be the *active router*. The active router receives and routes packets destined for the virtual MAC address of the group.

HSRP detects when the designated active router fails. At that point, a selected *standby router* assumes control of the virtual MAC and IP addresses of the HSRP group. HSRP also selects a new standby router at that time.

HSRP uses a priority designator to determine which HSRP-configured interface becomes the default active router. To configure an interface as the active router, you assign it with a priority that is higher than the priority of all the other HSRP-configured interfaces in the group. The default priority is 100, so if you configure just one interface with a higher priority, that interface becomes the default active router.

Interfaces that run HSRP send and receive multicast User Datagram Protocol (UDP)-based hello messages to detect a failure and to designate active and standby routers. When the active router fails to send a hello message within a configurable period of time, the standby router with the highest priority becomes the active router. The transition of packet forwarding functions between the active and standby router is completely transparent to all hosts on the network.

You can configure multiple HSRP groups on an interface.

The following figure shows a network configured for HSRP. By sharing a virtual MAC address and a virtual IP address, two or more interfaces can act as a single virtual router.

Figure 44: HSRP Topology with Two Enabled Routers

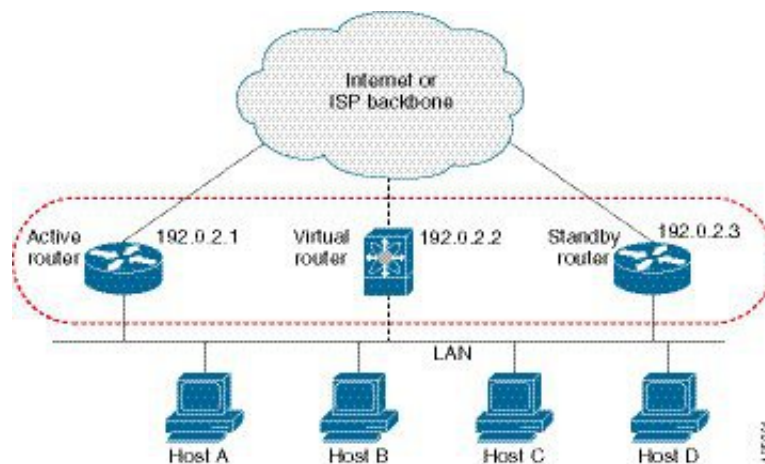

The virtual router does not physically exist but represents the common default router for interfaces that are configured to provide backup to each other. You do not need to configure the hosts on the LAN with the IP address of the active router. Instead, you configure them with the IP address of the virtual router (virtual IP address) as their default router. If the active router fails to send a hello message within the configurable period of time, the standby router takes over, responds to the virtual addresses, and becomes the active router, assuming the active router duties. From the host perspective, the virtual router remains the same.



Note Packets received on a routed port destined for the HSRP virtual IP address terminate on the local router, regardless of whether that router is the active HSRP router or the standby HSRP router. This process includes ping and Telnet traffic. Packets received on a Layer 2 (VLAN) interface destined for the HSRP virtual IP address terminate on the active router.

HSRP Versions

Cisco NX-OS supports HSRP version 1 by default. You can configure an interface to use HSRP version 2.

HSRP version 2 has the following enhancements to HSRP version 1:

Expands the group number range. HSRP version 1 supports group numbers from 0 to 255. HSRP version 2 supports group numbers from 0 to 4095.

For IPv4, uses the IPv4 multicast address 224.0.0.102 or the IPv6 multicast address FF02::66 to send hello packets instead of the multicast address of 224.0.0.2, which is used by HSRP version 1.

Uses the MAC address range from 0000.0C9F.F000 to 0000.0C9F.FFFF for IPv4 and 0005.73A0.0000 through 0005.73A0.0FFF for IPv6 addresses. HSRP version 1 uses the MAC address range 0000.0C07.AC00 to 0000.0C07.ACFF.

Adds support for MD5 authentication.

When you change the HSRP version, Cisco NX-OS reinitializes the group because it now has a new virtual MAC address.

HSRP version 2 has a different packet format than HSRP version 1. The packet format uses a type-length-value (TLV) format. HSRP version 2 packets received by an HSRP version 1 router are ignored.

HSRP for IPv4

HSRP routers communicate with each other by exchanging HSRP hello packets. These packets are sent to the destination IP multicast address 224.0.0.2 (reserved multicast address used to communicate to all routers) on UDP port 1985. The active router sources hello packets from its configured IP address and the HSRP virtual MAC address while the standby router sources hellos from its configured IP address and the interface MAC address, which might be the burned-in address (BIA). The BIA is the last six bytes of the MAC address that is assigned by the manufacturer of the network interface card (NIC).

Because hosts are configured with their default router as the HSRP virtual IP address, hosts must communicate with the MAC address associated with the HSRP virtual IP address. This MAC address is a virtual MAC address, 0000.0C07.ACxy, where xy is the HSRP group number in hexadecimal based on the respective interface. For example, HSRP group 1 uses the HSRP virtual MAC address of 0000.0C07.AC01. Hosts on the adjoining LAN segment use the normal Address Resolution Protocol (ARP) process to resolve the associated MAC addresses.

HSRP version 2 uses the new IP multicast address 224.0.0.102 to send hello packets instead of the multicast address of 224.0.0.2, which is used by version 1. HSRP version 2 permits an expanded group number range of 0 to 4095 and uses a new MAC address range of 0000.0C9F.F000 to 0000.0C9F.FFFF.

HSRP for IPv6

IPv6 hosts learn of available IPv6 routers through IPv6 neighbor discovery (ND) router advertisement (RA) messages. These messages are multicast periodically, or might be solicited by hosts, but the time delay for detecting when a default route is down might be 30 seconds or more. HSRP for IPv6 provides a much faster switchover to an alternate default router than the IPv6 ND protocol provides, less than a second if the milliseconds timers are used. HSRP for IPv6 provides a virtual first hop for IPv6 hosts.

When you configure an IPv6 interface for HSRP, the periodic RAs for the interface link-local address stop after IPv6 ND sends a final RA with a router lifetime of zero. No restrictions occur for the interface IPv6 link-local address. Other protocols continue to receive and send packets to this address.

IPv6 ND sends periodic RAs for the HSRP virtual IPv6 link-local address when the HSRP group is active. These RAs stop after a final RA is sent with a router lifetime of 0 when the HSRP group leaves the active state. HSRP uses the virtual MAC address for active HSRP group messages only (hello, coup, and resign).

HSRP for IPv6 uses the following parameters:

- HSRP version 2
- UDP port 2029
- Virtual MAC address range from 0005.73A0.0000 through 0005.73A0.0FFF
- Multicast link-local IP destination address of FF02::66
- Hop limit set to 255

HSRP for IPv6 Addresses

An HSRP IPv6 group has a virtual MAC address that is derived from the HSRP group number and a virtual IPv6 link-local address that is derived, by default, from the HSRP virtual MAC address. The default virtual MAC address for an HSRP IPv6 group is always used to form the virtual IPv6 link-local address, regardless of the actual virtual MAC address used by the group.

The following table shows the MAC and IP addresses used for IPv6 neighbor discovery packets and HSRP packets.

Table 30: HSRP and IPv6 ND Addresses

Packet	MAC Source Address	IPv6 Source Address	IPv6 Destination Address	Link-Layer Address Option
Neighbor solicitation (NS)	Interface MAC address	Interface IPv6 address	—	Interface MAC address
Router solicitation (RS)	Interface MAC address	Interface IPv6 address	—	Interface MAC address
Neighbor advertisement (NA)	Interface MAC address	Interface IPv6 address	Virtual IPv6 address	HSRP virtual MAC address
Route advertisement (RA)	Interface MAC address	Virtual IPv6 address	—	HSRP virtual MAC address

Packet	MAC Source Address	IPv6 Source Address	IPv6 Destination Address	Link-Layer Address Option
HSRP (inactive)	Interface MAC address	Interface IPv6 address	—	—
HSRP (active)	Virtual MAC address	Interface IPv6 address	—	—

HSRP does not add IPv6 link-local addresses to the Unicast Routing Information Base (URIB). Link-local addresses have no secondary virtual IP addresses.

For global unicast addresses, HSRP adds the virtual IPv6 address to the URIB and IPv6.

HSRP Subnet VIP

You can configure an HSRP subnet virtual IP (VIP) address in a different subnet than that of the interface IP address.



Note You can configure HSRP subnet VIPs for Cisco Nexus 9508 platform switches with the 9636C-R, 9636C-RX, and 9636Q-R line cards.

This feature enables you to conserve public IPv4 addresses by using a VIP as a public IP address and an interface IP as a private IP address. HSRP subnet VIPs are not needed for IPv6 addresses because a larger pool of IPv6 addresses is available and because routable IPv6 addresses can be configured on an SVI and used with regular HSRP.

This feature also enables periodic ARP synchronization to vPC peers and allows ARP to source with the VIP when an HSRP subnet VIP is configured for hosts in the VIP subnet.

For more information, see [Guidelines and Limitations for HSRP](#) and [Configuration Examples for HSRP](#).

HSRP Authentication

HSRP message digest 5 (MD5) algorithm authentication protects against HSRP-spoofing software and uses the industry-standard MD5 algorithm for improved reliability and security. HSRP includes the IPv4 or IPv6 address in the authentication TLVs.

HSRP Messages

Routers that are configured with HSRP exchange the following types of multicast messages:

- Hello—The hello message conveys the HSRP priority and state information of the router to other HSRP routers.
- Coup—When a standby router wants to assume the function of the active router, it sends a coup message.
- Resign—The active router sends this message when it no longer wants to function as the active router.

HSRP Load Sharing

HSRP allows you to configure multiple groups on an interface. You can configure two overlapping IPv4 HSRP groups to load share traffic from the connected hosts while providing the default router redundancy expected from HSRP. The following figure shows an example of a load-sharing HSRP IPv4 configuration.

Figure 45: HSRP Load Sharing

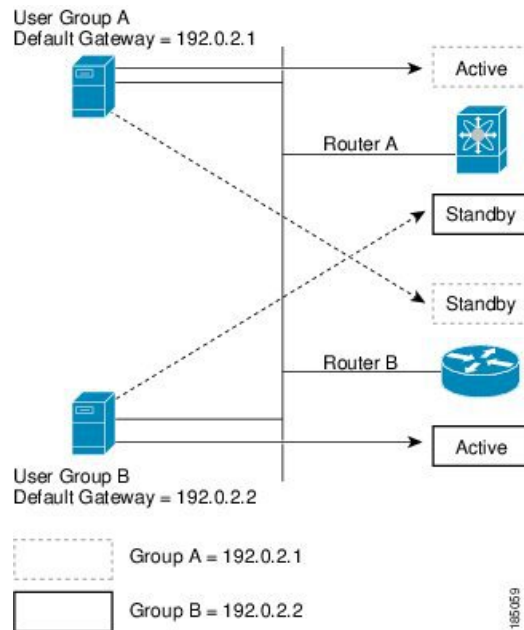

This figure shows two routers (A and B) and two HSRP groups. Router A is the active router for group A but is the standby router for group B. Similarly, router B is the active router for group B and the standby router for group A. If both routers remain active, HSRP load balances the traffic from the hosts across both routers. If either router fails, the remaining router continues to process traffic for both hosts.



Note HSRP for IPv6 load balances by default. If two HSRP IPv6 groups are on the subnet, hosts learn of both groups from their router advertisements and choose to use one so that the load is shared between the advertised routers.

Object Tracking and HSRP

You can use object tracking to modify the priority of an HSRP interface based on the operational state of another interface. Object tracking allows you to route to a standby router if the interface to the main network fails.

Two objects that you can track are the line protocol state of an interface or the reachability of an IP route. If the specified object goes down, Cisco NX-OS reduces the HSRP priority by the configured amount. For more information, see the [Configuring HSRP Object Tracking](#) section.

vPCs and HSRP

HSRP interoperates with virtual port channels (vPCs). vPCs allow links that are physically connected to two different Cisco Nexus 9000 Series switches to appear as a single port channel by a third device. See the [Cisco Nexus 9000 Series NX-OS Layer 2 Switching Configuration Guide](#) for more information on vPCs.

vPC forwards traffic through both the active HSRP router and the standby HSRP router. For more information, see the [Configuring the HSRP Priority](#) section and the [Configuration Examples for HSRP](#) section.



Note HSRP active can be distributed on both the primary and secondary vPC peers for different SVIs.

vPC Peer Gateway and HSRP

Some third-party devices can ignore the HSRP virtual MAC address and instead use the source MAC address of an HSRP router. In a vPC environment, the packets that use this source MAC address might be sent across the vPC peer link, causing a potential dropped packet. Configure the vPC peer gateway to enable the HSRP routers to directly handle packets sent to the local vPC peer MAC address, the remote vPC peer MAC address, and the HSRP virtual MAC address. See the [Cisco Nexus 9000 Series NX-OS Layer 2 Switching Configuration Guide](#) for more information on the vPC peer gateway.

BFD

This feature supports bidirectional forwarding detection (BFD). BFD is a detection protocol that provides fast-forwarding and path-failure detection times. BFD provides subsecond failure detection between two adjacent devices and can be less CPU-intensive than protocol hello messages because some of the BFD load can be distributed onto the data plane on supported modules. See the [Cisco Nexus 9000 Series NX-OS Interfaces Configuration Guide](#) for more information.

High Availability and Extended Nonstop Forwarding

HSRP supports stateful restarts and stateful switchovers. A stateful restart occurs when the HSRP process fails and is restarted. A stateful switchover occurs when the active supervisor switches to the standby supervisor. Cisco NX-OS applies the run-time configuration after the switchover.

If HSRP hold timers are configured for short time periods, these timers might expire during a controlled switchover. HSRP supports extended nonstop forwarding (NSF) to temporarily extend these HSRP hold timers during a controlled switchover.

With extended NSF configured, HSRP sends hello messages with the extended timers. HSRP peers update their hold timers with these new values. The extended timers prevent unnecessary HSRP state changes during the switchover. After the switchover, HSRP restores the hold timers to their original configured values. If the switchover fails, HSRP restores the hold timers after the extended hold timer values expire.

See the [Configuring Extended Hold Timers for HSRP](#) section for more information.

Virtualization Support

HSRP supports virtual routing and forwarding (VRF) instances.

Prerequisites for HSRP

- You must enable the HSRP feature in a device before you can configure and enable any HSRP groups.

Guidelines and Limitations for HSRP

HSRP has the following configuration guidelines and limitations:

- Configure an IP address for the interface that you configure HSRP on and enables that interface before HSRP becomes active.
- Cisco Nexus 9500 platform switches running in max-host routing mode do not support four-way HSRP.
- Configure HSRP version 2 when you configure an IPv6 interface for HSRP.
- For IPv4, the virtual IP address must be in the same subnet as the interface IP address.
- We recommend that you do not configure more than one first-hop redundancy protocol on the same interface.
- HSRP version 2 does not interoperate with HSRP version 1. An interface cannot operate both version 1 and version 2 because both versions are mutually exclusive. However, the different versions can be run on different physical interfaces of the same router.
- You cannot change from version 2 to version 1 if you have configured groups above the allowed group number range for version 1 (0-255).
- HSRP for IPv4 is supported with BFD. HSRP for IPv6 is not supported with BFD.
- If HSRP IPv4 and IPv6 use the same virtual MAC address on an SVI, the HSRP state must be the same for both HSRP IPv4 and IPv6. The priority and preemption should be configured to result in the same state after failovers.
- Cisco NX-OS removes all Layer 3 configurations on an interface when you change the interface VRF membership, port channel membership, or the port mode to Layer 2.
- If you configure virtual MAC addresses with vPC, you must configure the same virtual MAC address on both vPC peers.
- You cannot use the HSRP MAC address burned-in option on a VLAN interface that is a vPC member.
- Cisco NX-OS supports having the same HSRP groups on all nodes in a double-sided vPC.
- If you have not configured authentication, the **show hsrp** command displays the following string:

```
Authentication text "cisco"
```

The default behavior of HSRP is as defined in RFC 2281:

If no authentication data is configured, the RECOMMENDED default value is 0x63 0x69 0x73 0x63 0x6F 0x00 0x00 0x00.

- When configuring 4-way HSRP using 2 pairs of vPC switches (new deployment or migration scenarios), the HSRP priorities should be configured such that the vPC pairs of Nexus 9000 switches are in Active/Standby state and Listen/Listen state. There is no support for Cisco Nexus 9000 vPC peers to be in HSRP Active/Listen state, or Standby/Listen state.
- The HSRP subnet VIP feature has the following guidelines and limitations:
 - This feature is supported for Cisco Nexus 9000 Series switches and for Cisco Nexus 9508 switches with the 9636C-R, 9636C-RX, and 9636Q-R line cards.
 - This feature is supported only for IPv4 addresses and only in a vPC topology.
 - Primary or secondary VIPs can be subnet VIPs, but subnet VIPs must not overlap any interface subnet.
 - Regular host VIPs use a mask length of 0 or 32. If you specify a mask length for a subnet VIP, it must be greater than 0 and less than 32.
 - URPF is not supported with this feature.
 - DHCP sourcing with VIPs is also not supported.
 - This feature does not support using a DHCP relay agent to relay DHCP packets with a VIP as the source.
 - VIP direct routes must be explicitly advertised to routing protocols using redistribute commands and route maps.
 - Supervisor-generated traffic (pings, trace routes, and so on) destined for VIP subnets continues to source with SVI IP addresses and not with the VIP.
 - If the subnet VIP is configured with /32 as the length, you must use the **no** command with /32 to remove the IP address (for example, **no ip ip-address/32**).
- To remove an SVI configuration with its sub-configurations, that are configured using a configuration profile, you must first remove the profile or clear the manual configuration settings under the VLAN before executing **no interface vlan** command.
- The following are configuration guidelines to enforce the pre-empt reload timer. The guidelines are listed in order of decreasing preference.
 1. In triangle topologies, we recommend that the HSRP peers are configured within a single VPC domain. This configuration prevents the Spanning-Tree root bridge from changing on the HSRP peer when the Cisco Nexus 9000 configuration is reloaded.
 2. Make sure the Spanning Tree root bridge for all VLANs is not on the Cisco Nexus 9000 that is being reloaded.
 3. If 1 and 2 are not possible, make sure that the switch has an enabled link for all the SVI VLANs that is connected to another switch that is not the HSRP peer.

Default Settings for HSRP Parameters

Default HSRP Parameters

Parameters	Default
HSRP	Disabled
Authentication	Enabled as text for version 1, with cisco as the password
HSRP version	Version 1
Preemption	Disabled
Priority	100
Virtual MAC address	Derived from HSRP group number

Configuring HSRP

Enabling HSRP

You must globally enable HSRP before you can configure and enable any HSRP groups.

SUMMARY STEPS

1. `[no] feature hsrp`

DETAILED STEPS

	Command or Action	Purpose
Step 1	<code>[no] feature hsrp</code> Example: <code>switch(config)# feature hsrp</code>	Enables the HSRP feature. Use the no form of this command to disable HSRP for all groups.

Configuring the HSRP Version

You can configure the HSRP version. If you change the version for existing groups, Cisco NX-OS reinitializes HSRP for those groups because the virtual MAC address changes. The HSRP version applies to all groups on the interface



Note IPv6 HSRP groups must be configured as HSRP version 2.

SUMMARY STEPS

1. **hsrp version {1 | 2}**

DETAILED STEPS

	Command or Action	Purpose
Step 1	hsrp version {1 2} Example: switch(config-if)# hsrp version 2	Confirms the HSRP version. Version 1 is the default.

Configuring an HSRP Group for IPv4

You can configure an HSRP group on an IPv4 interface and configure the virtual IP address and virtual MAC address for the HSRP group.

Before you begin

Ensure that you have enabled the HSRP feature (see the [Enabling HSRP](#) section).

Cisco NX-OS enables an HSRP group once you configure the virtual IP address. You must configure HSRP attributes such as authentication, timers, and priority before you enable the HSRP group.

SUMMARY STEPS

1. **configure terminal**
2. **interface** *interface-type slot/port*
3. **ip** *ip-address/length*
4. **hsrp** *group-number [ipv4]*
5. **ip** [*ip-address [secondary]*]
6. **exit**
7. **no shutdown**
8. (Optional) **show hsrp** [**group** *group-number*] [**ipv4**]
9. (Optional) **copy running-config startup-config**

DETAILED STEPS

	Command or Action	Purpose
Step 1	configure terminal Example: switch# configure terminal switch(config)#	Enters global configuration mode.
Step 2	interface <i>interface-type slot/port</i> Example: switch(config)# interface ethernet 1/2 switch(config-if)#	Enters interface configuration mode.

	Command or Action	Purpose
Step 3	ip <i>ip-address/length</i> Example: switch(config-if)# ip 192.0.2.2/8	Configures the IPv4 address of the interface.
Step 4	hsrp group-number [ipv4] Example: switch(config-if)# hsrp 2 switch(config-if-hsrp)#	Creates an HSRP group and enters HSRP configuration mode. The range for HSRP version 1 is from 0 to 255. The range is for HSRP version 2 is from 0 to 4095. The default value is 0.
Step 5	ip [<i>ip-address</i> [secondary]] Example: switch(config-if-hsrp)# ip 192.0.2.1	Configures the virtual IP address for the HSRP group and enables the group. This address should be in the same subnet as the IPv4 address of the interface.
Step 6	exit Example: switch(config-if-hsrp)# exit	Exits HSRP configuration mode.
Step 7	no shutdown Example: switch(config-if-hsrp)# no shutdown	Enables the interface.
Step 8	(Optional) show hsrp [group <i>group-number</i>] [ipv4] Example: switch(config-if-hsrp)# show hsrp group 2	Displays HSRP information.
Step 9	(Optional) copy running-config startup-config Example: switch(config-if-hsrp)# copy running-config startup-config	Copies the running configuration to the startup configuration.

Example



Note You should use the **no shutdown** command to enable the interface after you finish the configuration.

This example shows how to configure an HSRP group on Ethernet 1/2:

```
switch# configure terminal
switch(config)# interface ethernet 1/2
switch(config-if)# ip 192.0.2.2/8
switch(config-if)# hsrp 2
switch(config-if-hsrp)# ip 192.0.2.1
switch(config-if-hsrp)# exit
switch(config-if)# no shutdown
switch(config-if)# copy running-config startup-config
```

Configuring an HSRP Group for IPv6

You can configure an HSRP group on an IPv6 interface and configure the virtual MAC address for the HSRP group.

When you configure an HSRP group for IPv6, HSRP generates a link-local address from the link-local prefix. HSRP also generates a modified EUI-64 format interface identifier in which the EUI-64 interface identifier is created from the relevant HSRP virtual MAC address.

Before you begin

You must enable HSRP (see the [Enabling HSRP](#) section).

Ensure that you have enabled HSRP version 2 on the interface on which you want to configure an IPv6 HSRP group.

Ensure that you have configured HSRP attributes such as authentication, timers, and priority before you enable the HSRP group.

SUMMARY STEPS

1. **configure terminal**
2. **interface** *interface-type slot/port*
3. **ipv6 address** *ipv6-address/length*
4. **hsrp version 2**
5. **hsrp group-number** **ipv6**
6. **ip** *ipv6-address*
7. **ip autoconfig**
8. **exit**
9. **no shutdown**
10. (Optional) **show hsrp** [**group** *group-number*] [**ipv6**]
11. (Optional) **copy running-config startup-config**

DETAILED STEPS

	Command or Action	Purpose
Step 1	configure terminal Example: <pre>switch# configure terminal switch(config)#</pre>	Enters global configuration mode.
Step 2	interface <i>interface-type slot/port</i> Example: <pre>switch(config)# interface ethernet 3/2 switch(config-if)#</pre>	Enters interface configuration mode.
Step 3	ipv6 address <i>ipv6-address/length</i> Example: <pre>switch(config-if)# ipv6 address 2001:0DB8::0001:0001/64</pre>	Configures the IPv6 address of the interface.

	Command or Action	Purpose
Step 4	hsrp version 2 Example: switch(config-if-hsrp)# hsrp version 2	Configures the group for HSRP version 2.
Step 5	hsrp group-number ipv6 Example: switch(config-if)# hsrp 10 ipv6 switch(config-if-hsrp)#	Creates an IPv6 HSRP group and enters HSRP configuration mode. The range for HSRP version 2 is from 0 to 4095. The default value is 0.
Step 6	ip ipv6-address Example: switch(config-if-hsrp)# ip 2001:DB8::1	Configures the virtual IPv6 address for the HSRP group and enables the group.
Step 7	ip autoconfig Example: switch(config-if-hsrp)# ip autoconfig	Autoconfigures the virtual IPv6 address for the HSRP group from the calculated link-local virtual IPv6 address and enables the group.
Step 8	exit Example: switch(config-if-hsrp)# exit switch(config-if)#	Exits HSRP configuration mode.
Step 9	no shutdown Example: switch(config-if)# no shutdown	Enables the interface.
Step 10	(Optional) show hsrp [group group-number] [ipv6] Example: switch(config-if)# show hsrp group 10	Displays HSRP information.
Step 11	(Optional) copy running-config startup-config Example: switch(config-if)# copy running-config startup-config	Copies the running configuration to the startup configuration.

Example



Note You should use the **no shutdown** command to enable the interface after you finish the configuration.

This example shows how to configure an IPv6 HSRP group on Ethernet 3/2:

```
switch# configure terminal
switch(config)# interface ethernet 3/2
switch(config-if)# ipv6 address 2001:0DB8::0001:0001/64
```



```
switch(config-if-hsrp)# hsrp version 2
switch(config-if)# hsrp 2 ipv6
switch(config-if-hsrp)# ip 2001:DB8::1
switch(config-if-hsrp)# exit
switch(config-if)# no shutdown
switch(config-if)# copy running-config startup-config
```

Configuring the HSRP Virtual MAC Address

You can override the default virtual MAC address that HSRP derives from the configured group number.



Note You must configure the same virtual MAC address on both vPC peers of a vPC link.

SUMMARY STEPS

1. **mac-address** *string*
2. (Optional) **hsrp use-bia** [*scope interface*]

DETAILED STEPS

	Command or Action	Purpose
Step 1	mac-address <i>string</i> Example: switch(config-if-hsrp)# mac-address 5000.1000.1060	Configures the virtual MAC address for an HSRP group. The string uses the standard MAC address format (xxxx.xxxx.xxxx).
Step 2	(Optional) hsrp use-bia [<i>scope interface</i>] Example: switch(config-if)# hsrp use-bia	<p>Note To configure HSRP to use the burned-in MAC address of the interface for the virtual MAC address, use the following command in interface configuration mode:</p> <p>Configures HSRP to use the burned-in MAC address of the interface for the HSRP virtual MAC address. You can optionally configure HSRP to use the burned-in MAC address for all groups on this interface by using the scope interface keyword.</p>

Authenticating HSRP

You can configure HSRP to authenticate the protocol using cleartext or MD5 digest authentication. MD5 authentication uses a keychain. For more details, see the [Cisco Nexus 9000 Series NX-OS Security Configuration Guide](#).

Before you begin

You must enable HSRP (see the [Enabling HSRP](#) section).

Ensure that you have configured the same authentication and keys on all members of the HSRP group.

Ensure that you have created the keychain if you are using MD5 authentication.

SUMMARY STEPS

1. **configure terminal**
2. **interface** *interface-type slot/port*
3. **hsrp group-number** [**ipv4** | **ipv6**]
4. **authentication** {*text string* | **md5** {*key-chain key-chain* | **key-string** {**0** | **7**} *text* [**compatibility**] [**timeout seconds**]}}
5. (Optional) **show hsrp** [**group group-number**]
6. (Optional) **copy running-config startup-config**

DETAILED STEPS

	Command or Action	Purpose
Step 1	configure terminal Example: <pre>switch# configure terminal switch(config)#</pre>	Enters global configuration mode.
Step 2	interface <i>interface-type slot/port</i> Example: <pre>switch(config)# interface ethernet 1/2 switch(config-if)#</pre>	Enters interface configuration mode.
Step 3	hsrp group-number [ipv4 ipv6] Example: <pre>switch(config-if)# hsrp 2 switch(config-if-hsrp)#</pre>	Creates an HSRP group and enters HSRP configuration mode.
Step 4	authentication { <i>text string</i> md5 { <i>key-chain key-chain</i> key-string { 0 7 } <i>text</i> [compatibility] [timeout seconds]}} Example: <pre>switch(config-if-hsrp)# authentication text mypassword</pre> Example: <pre>switch(config-if-hsrp)# authentication md5 key-chain hsrp-keys</pre>	<p>Configures cleartext authentication for HSRP on this interface using the authentication text command or configures MD5 authentication for HSRP on this interface using the authentication md5 command.</p> <p>If you configure MD5 authentication, you can use a keychain or key string. If you use a key string, you can optionally set the timeout for when HSRP only accepts a new key. The range is from 0–32,767 seconds.</p> <p>Compatibility: Designed for authentication compatibility between Cisco IOS and Cisco NX-OS. Compatibility mode is for MD5 key-string authentication. When a hidden authentication type is configured on both Cisco IOS and Cisco NX-OS, the compatibility flag has to be enabled in NX-OS to bring up the HSRP session.</p>
Step 5	(Optional) show hsrp [group group-number] Example: <pre>switch(config-if-hsrp)# show hsrp group 2</pre>	Displays HSRP information.

	Command or Action	Purpose
Step 6	(Optional) copy running-config startup-config Example: <pre>switch(config-if-hsrp)# copy running-config startup-config</pre>	Copies the running configuration to the startup configuration.

Example

This example shows how to configure MD5 authentication for HSRP on Ethernet 1/2 after creating the keychain:

```
switch# configure terminal

switch(config)# key chain hsrp-keys
switch(config-keychain)# key 0
switch(config-keychain-key)# key-string 7 zqdest
switch(config-keychain-key) accept-lifetime 00:00:00 Jun 01 2013 23:59:59 Sep 12 2013
switch(config-keychain-key) send-lifetime 00:00:00 Jun 01 2013 23:59:59 Aug 12 2013
switch(config-keychain-key) key 1
switch(config-keychain-key) key-string 7 uaeqdyito
switch(config-keychain-key) accept-lifetime 00:00:00 Aug 12 2013 23:59:59 Dec 12 2013
switch(config-keychain-key) send-lifetime 00:00:00 Sep 12 2013 23:59:59 Nov 12 2013
switch(config-keychain-key)# interface ethernet 1/2
switch(config-if)# hsrp 2
switch(config-if-hsrp)# authentication md5 key-chain hsrp-keys
switch(config-if-hsrp)# copy running-config startup-config
```

Configuring HSRP Object Tracking

You can configure an HSRP group to adjust its priority based on the availability of other interfaces or routes. The priority of an HSRP group can change dynamically if it has been configured for object tracking and the object that is being tracked goes down.

The tracking process periodically polls the tracked objects and notes any value change. The value change triggers HSRP to recalculate the priority. The HSRP interface with the higher priority becomes the active router if you configure the HSRP interface for preemption.

SUMMARY STEPS

1. **configure terminal**
2. **track *object-id* interface *interface-type slot/port* {**line-protocol** | **ip routing** | **ipv6 routing**}**
3. **track *object-id* {**ip** | **ipv6**} route *ip-prefix/length* **reachability****
4. **exit**
5. **interface *interface-type slot/port***
6. **hsrp *group-number* [**ipv4** | **ipv6**]**
7. **priority [*value*]**
8. **track *object-id* [**decrement** *value*]**
9. **preempt [**delay** [*minimum seconds*] [**reload** *seconds*] [**sync** *seconds*]]**
10. (Optional) **show hsrp interface *interface-type slot/port***
11. (Optional) **copy running-config startup-config**

DETAILED STEPS

	Command or Action	Purpose
Step 1	configure terminal Example: <pre>switch# configure terminal switch(config)#</pre>	Enters global configuration mode.
Step 2	track <i>object-id</i> interface <i>interface-type</i> <i>slot/port</i> {line-protocol ip routing ipv6 routing} Example: <pre>switch(config)# track 1 interface ethernet 2/2 line-protocol switch(config-track)#</pre>	Configures the interface that the track object tracks. Changes in the state of the interface affect the track object status as follows: <ul style="list-style-type: none"> • You configure the interface and corresponding object number that you use with the track command in global configuration mode. • The line-protocol keyword tracks whether the interface is up. The ip routing or ipv6 routing keyword also checks that IP routing is enabled on the interface and an IP address is configured.
Step 3	track <i>object-id</i> {ip ipv6} route <i>ip-prefix/length</i> reachability Example: <pre>switch(config-track)# track 2 ip route 192.0.2.0/8 reachability</pre>	Creates a tracked object for a route and enters tracking configuration mode. The <i>object-id</i> range is from 1 to 500.
Step 4	exit Example: <pre>switch(config-track)# exit switch(config)#</pre>	Exits track configuration mode.
Step 5	interface <i>interface-type</i> <i>slot/port</i> Example: <pre>switch(config)# interface ethernet 1/2 switch(config-if)#</pre>	Enters interface configuration mode.
Step 6	hsrp <i>group-number</i> [ipv4 ipv6] Example: <pre>switch(config-if)# hsrp 2 switch(config-if-hsrp)#</pre>	Creates an HSRP group and enters HSRP configuration mode.
Step 7	priority [<i>value</i>] Example: <pre>switch(config-if-hsrp)# priority 254</pre>	Sets the priority level used to select the active router in an HSRP group. The range is from 0 to 255. The default is 100.
Step 8	track <i>object-id</i> [decrement <i>value</i>] Example:	Specifies an object to be tracked that affects the weighting of an HSRP interface.

	Command or Action	Purpose
	<code>switch(config-if-hsrp)# track 1 decrement 20</code>	The <i>value</i> argument specifies a reduction in the priority of an HSRP interface when a tracked object fails. The range is from 1 to 255. The default is 10.
Step 9	<p>preempt [delay [minimum seconds] [reload seconds] [sync seconds]]</p> <p>Example:</p> <pre>switch(config-if-hsrp)# preempt delay minimum 60</pre>	Configures the router to take over as the active router for an HSRP group if it has a higher priority than the current active router. This command is disabled by default. Optionally, a delay can be configured that delays the HSRP group preemption by the configured time. The range is from 0 to 3600 seconds.
Step 10	<p>(Optional) show hsrp interface <i>interface-type slot/port</i></p> <p>Example:</p> <pre>switch(config-if-hsrp)# show hsrp interface ethernet 1/2</pre>	Displays HSRP information for an interface.
Step 11	<p>(Optional) copy running-config startup-config</p> <p>Example:</p> <pre>switch(config-if-hsrp)# copy running-config startup-config</pre>	Copies the running configuration to the startup configuration.

Example

This example shows how to configure HSRP object tracking on Ethernet interface 1/2:

```
switch# configure terminal
switch(config)# track 1 interface ethernet 2/2 line-protocol
switch(config-track)# track 2 ip route 192.0.2.0/8 reachability
switch(config-track)# exit
switch(config)# interface ethernet 1/2
switch(config-if)# hsrp 2
switch(config-if-hsrp)# priority 254
switch(config-if-hsrp)# track 1 decrement 20
switch(config-if-hsrp)# preempt delay minimum 60
switch(config-if-hsrp)# copy running-config startup-config
```

Configuring the HSRP Priority

You can configure the priority of an HSRP group. HSRP uses the priority to determine which HSRP group member acts as the active router. If you configure HSRP on a vPC-enabled interface, you can optionally configure the upper and lower threshold values to control when to fail over to the vPC trunk. If the standby router priority falls below the lower threshold, HSRP sends all standby router traffic across the vPC trunk to forward through the active HSRP router. HSRP maintains this scenario until the standby HSRP router priority increases above the upper threshold.

For IPv6 HSRP groups, if all group members have the same priority, HSRP selects the active router based on the IPv6 link-local address.

To configure the HSRP priority, use the following command in the HSRP group configuration mode:

SUMMARY STEPS

1. **priority** *level* [**forwarding-threshold lower** *lower-value* **upper** *upper-value*]

DETAILED STEPS

	Command or Action	Purpose
Step 1	priority <i>level</i> [forwarding-threshold lower <i>lower-value</i> upper <i>upper-value</i>] Example: <pre>switch(config-if-hsrp)# priority 60 forwarding-threshold lower 40 upper 50</pre>	Sets the priority level used to select the active router in an HSRP group. The <i>level</i> range is from 0 to 255. The default is 100. Optionally, this command sets the upper and lower threshold values used by vPC to determine when to fail over to the vPC trunk. The <i>lower-value</i> range is from 1 to 255. The default is 1. The <i>upper-value</i> range is from 1 to 255. The default is 255.

Customizing HSRP in HSRP Configuration Mode

You can optionally customize the behavior of HSRP. Be aware that as soon as you enable an HSRP group by configuring a virtual IP address, that group becomes operational. If you enable an HSRP group before customizing HSRP, the router could take control over the group and become the active router before you finish customizing the feature. If you plan to customize HSRP, you should do so before you enable the HSRP group.

SUMMARY STEPS

1. (Optional) **name** *string*
2. (Optional) **preempt** [**delay** [**minimum** *seconds*] [**reload** *seconds*] [**sync** *seconds*]]
3. (Optional) **timers** [**msec**] *hellotime* [**msec**] *holdtime*
4. (Optional) **hsrp delay** **minimum** *seconds*
5. (Optional) **hsrp delay** **reload** *seconds*

DETAILED STEPS

	Command or Action	Purpose
Step 1	(Optional) name <i>string</i> Example: <pre>switch(config-if-hsrp)# name HSRP-1</pre>	Specifies the IP redundancy name for an HSRP group. The <i>string</i> is from 1 to 255 characters. The default string has the following format: <i>hsrp-interface short-name group-id</i> . For example, <i>hsrp-Eth2/1-1</i> .
Step 2	(Optional) preempt [delay [minimum <i>seconds</i>] [reload <i>seconds</i>] [sync <i>seconds</i>]] Example: <pre>switch(config-if-hsrp)# preempt delay minimum 60</pre>	Configures the router to take over as an active router for an HSRP group if it has a higher priority than the current active router. This command is disabled by default. Optionally, a delay can be configured that delays the HSRP group preemption by the configured time. The range is from 0 to 3600 seconds.
Step 3	(Optional) timers [msec] <i>hellotime</i> [msec] <i>holdtime</i> Example:	Configures the hello and hold time for this HSRP member as follows:

	Command or Action	Purpose
	<code>switch(config-if-hsrp)# timers 5 18</code>	<ul style="list-style-type: none"> • <i>hellotime</i>—The interval between successive hello packets sent. The range is from 1 to 254 seconds. • <i>holdtime</i>—The interval before the information in the hello packet is considered invalid. The range is from 3 to 255. <p>The optional msec keyword specifies that the argument is expressed in milliseconds instead of the default seconds. The timer ranges for milliseconds are as follows:</p> <ul style="list-style-type: none"> • <i>hellotime</i>—The interval between successive hello packets sent. The range is from 250 to 999 milliseconds. • <i>holdtime</i>—The interval before the information in the hello packet is considered invalid. The range is from 750 to 3000 milliseconds.
Step 4	(Optional) hsrp delay minimum <i>seconds</i> Example: <code>switch(config-if)# hsrp delay minimum 30</code>	Specifies the minimum amount of time that HSRP waits after a group is enabled before participating in the group. The range is from 0 to 10000 seconds. The default is 0.
Step 5	(Optional) hsrp delay reload <i>seconds</i> Example: <code>switch(config-if)# hsrp delay reload 30</code>	Specifies the minimum amount of time that HSRP waits after a reload and before participating in the group. The range is from 0 to 10000 seconds. The default is 0. Note When using preempt delay with 'reload' option, the recommendation is to use it along with hsrp delay reload (interface-level command). This is to avoid the scenario where after reload, higher priority HSRP Standby becomes Active on hold timer expiry (10 seconds) because the preempt delay reload timer didn't start as SVI is UP but the physical link/port-channel is not yet UP after reload. Timers can be tuned according to scale. Example - Instead of configuring preempt delay reload 200 , configure preempt delay reload 140 and hsrp delay reload 60 . This is to ensure that the SVI and physical link/port-channel are both UP, when HSRP starts the start machine from INIT state after reload delay expiry (60 sec).

Customizing HSRP in Interface Configuration Mode

You can optionally customize the behavior of HSRP. Be aware that as soon as you enable an HSRP group by configuring a virtual IP address, that group becomes operational. If you enable an HSRP group before

customizing HSRP, the router could take control over the group and become the active router before you finish customizing the feature. If you plan to customize HSRP, you should do so before you enable the HSRP group.

SUMMARY STEPS

1. **configure terminal**
2. **interface** *interface-type slot/port*
3. **hsrp delay minimum** *seconds*
4. **hsrp delay reload** *seconds*
5. (Optional) **copy running-config startup-config**

DETAILED STEPS

	Command or Action	Purpose
Step 1	configure terminal Example: <pre>switch# configure terminal switch(config)#</pre>	Enters global configuration mode.
Step 2	interface <i>interface-type slot/port</i> Example: <pre>switch(config)# interface ethernet 1/2 switch(config-if)#</pre>	Enters interface configuration mode.
Step 3	hsrp delay minimum <i>seconds</i> Example: <pre>switch(config-if)# hsrp delay minimum 30</pre>	Specifies the minimum amount of time that HSRP waits after a group is enabled before participating in the group. The range is from 0 to 10000 seconds. The default is 0.
Step 4	hsrp delay reload <i>seconds</i> Example: <pre>switch(config-if)# hsrp delay reload 30</pre>	Specifies the minimum amount of time that HSRP waits after a reload and before participating in the group. The range is from 0 to 10000 seconds. The default is 0.
Step 5	(Optional) copy running-config startup-config Example: <pre>switch(config-if)# copy running-config startup-config</pre>	Copies the running configuration to the startup configuration.

Configuring Extended Hold Timers for HSRP

You can configure HSRP to use extended hold timers to support extended NSF during a controlled (graceful) switchover. You should configure extended hold timers on all HSRP routers.



Note You must configure extended hold timers on all HSRP routers if you configure extended hold timers. If you configure a nondefault hold timer, you should configure the same value on all HSRP routers when you configure HSRP extended hold timers.



Note HSRP extended hold timers are not applied if you configure millisecond hello and hold timers for HSRPv1. This statement does not apply to HSRPv2.

SUMMARY STEPS

1. (Optional) **hsrp timers extended-hold** *[timer]*
2. (Optional) **show hsrp**

DETAILED STEPS

	Command or Action	Purpose
Step 1	(Optional) hsrp timers extended-hold <i>[timer]</i> Example: <pre>switch(config)# hsrp timers extended-hold</pre>	Sets the HSRP extended hold timer in seconds for both IPv4 and IPv6 groups. The <i>timer</i> range is from 10 to 255. The default is 10. Note Use the show hsrp command or the show running-config hsrp command to display the extended hold time.
Step 2	(Optional) show hsrp Example: <pre>switch(config)# show hsrp</pre>	Displays the HSRP extended hold time.

Example

Use the **show hsrp** command or the **show running-config hsrp** command to display the extended hold time.

Verifying the HSRP Configuration

To display HSRP configuration information, perform one of the following tasks:

Command	Purpose
show hsrp [group <i>group-number</i>]	Displays the HSRP status for all groups or one group.
show hsrp delay [interface <i>interface-type slot/port</i>]	Displays the HSRP delay value for all interfaces or one interface.
show hsrp [interface <i>interface-type slot/port</i>]	Displays the HSRP status for an interface.
show hsrp [group <i>group-number</i>] [interface <i>interface-type slot/port</i>] [active] [all] [init] [learn] [listen] [speak] [standby]	Displays the HSRP status for a group or interface for virtual forwarders in the active, init, learn, listen, or standby state. Use the all keyword to see all states, including disabled.

Command	Purpose
show hsrp [<i>group group-number</i>] [interface interface-type slot/port] [active] [all] [init] [learn] [listen] [speak] [standby] brief	Displays a brief summary of the HSRP status for a group or interface for virtual forwarders in the active, init, learn, listen, or standby state. Use the all keyword to see all states, including disabled.
show ip local-pt	Displays whether the netstack has programmed a subnet route for the VIP subnet.

Configuration Examples for HSRP

The following example shows how to enable HSRP on an interface with MD5 authentication and interface tracking:

```
key chain hsrp-keys
key 0
key-string 7 zqdest
accept-lifetime 00:00:00 Jun 01 2013 23:59:59 Sep 12 2013
send-lifetime 00:00:00 Jun 01 2013 23:59:59 Aug 12 2013
key 1
key-string 7 uaeqdyito
accept-lifetime 00:00:00 Aug 12 2013 23:59:59 Nov 12 2013
send-lifetime 00:00:00 Sep 12 2013 23:59:59 Nov 12 2013

feature hsrp
track 2 interface ethernet 2/2 ip
interface ethernet 1/2
ip address 192.0.2.2/8
hsrp 1
authenticate md5 key-chain hsrp-keys
priority 90
track 2 decrement 20
ip 192.0.2.10
no shutdown
```

The following example shows how to configure the HSRP priority on an interface:

```
interface vlan 1
hsrp 0
preempt
priority 100 forwarding-threshold lower 80 upper 90
ip 192.0.2.2
track 1 decrement 30
```

This example shows how to configure an HSRP subnet VIP address, which is configured in a different subnet than that of the interface IP address.

```
sswitch# configure terminal
switch(config)# feature hsrp
switch(config)# feature interface-vlan
switch(config)# interface vlan 2
switch(config-if)# ip address 192.0.2.1/24
switch(config-if)# hsrp 2
switch(config-if-hsrp)# ip 209.165.201.1/24
```

This example shows how to configure an HSRP subnet VIP address, which is configured in a different subnet than that of the interface IP address.

```
switch# configure terminal
switch(config)# feature hsrp
switch(config)# feature interface-vlan
switch(config)# interface vlan 2
switch(config-if)# ip address 192.0.2.1/24
switch(config-if)# hsrp 2
switch(config-if-hsrp)# ip 209.165.201.1
!ERROR: VIP subnet mismatch with interface IP!
```

This example shows a VIP mismatch error when the HSRP subnet VIP address is configured in the same subnet as the interface IP address.

```
switch# configure terminal
switch(config)# feature hsrp
switch(config)# feature interface-vlan
switch(config)# interface vlan 2
switch(config-if)# ip address 192.0.2.1/24
switch(config-if)# hsrp 2
switch(config-if-hsrp)# ip 192.0.2.10/24
!ERROR: Subnet VIP cannot be in same subnet as interface IP!
```

Additional References

For additional information related to implementing HSRP, see the following sections:

- [Related Documents](#)
- [MIBs](#)

Related Documents

Related Topic	Document Title
Configuring the Virtual Router Redundancy Protocol	Configuring VRRP
Configuring high availability	Cisco Nexus 9000 Series NX-OS High Availability and Redundancy Guide

MIBs

MIBs	MIBs Link
MIBs related to HSRP	To locate and download supported MIBs, go to the following URL: ftp://ftp.cisco.com/pub/mibs/supportlists/nexus9000/Nexus9000MIBSupportList.html



CHAPTER 20

Configuring VRRP

This chapter contains the following sections:

- [About VRRP, on page 593](#)
- [Information About VRRPv3 and VRRS, on page 598](#)
- [High Availability, on page 599](#)
- [Virtualization Support, on page 599](#)
- [Guidelines and Limitations for VRRP, on page 599](#)
- [Guidelines and Limitations for VRRPv3, on page 600](#)
- [Default Settings for VRRP Parameters, on page 601](#)
- [Default Settings for VRRPv3 Parameters, on page 601](#)
- [Configuring VRRP, on page 601](#)
- [Configuring VRRPv3, on page 612](#)
- [Verifying the VRRP Configuration, on page 619](#)
- [Verifying the VRRPv3 Configuration, on page 619](#)
- [Monitoring and Clearing VRRP Statistics, on page 619](#)
- [Monitoring and Clearing VRRPv3 Statistics, on page 620](#)
- [Configuration Examples for VRRP, on page 620](#)
- [Configuration Examples for VRRPv3, on page 621](#)
- [Additional References, on page 623](#)

About VRRP

VRRP allows for a transparent failover at the first-hop IP router by configuring a group of routers to share a virtual IP address. VRRP selects an allowed router in that group to handle all packets for the virtual IP address. The remaining routers are in standby and take over if the allowed router fails.

VRRP Operation

A LAN client can determine which router should be the first hop to a particular remote destination by using a dynamic process or static configuration. Examples of dynamic router discovery are as follows:

Proxy ARP—The client uses Address Resolution Protocol (ARP) to get the destination it wants to reach, and a router responds to the ARP request with its own MAC address.

Routing protocol—The client listens to dynamic routing protocol updates (for example, from Routing Information Protocol [RIP]) and forms its own routing table.

ICMP Router Discovery Protocol (IRDP) client—The client runs an Internet Control Message Protocol (ICMP) router discovery client.

The disadvantage to dynamic discovery protocols is that they incur some configuration and processing overhead on the LAN client. Also, if a router fails, the process of switching to another router can be slow.

An alternative to dynamic discovery protocols is to statically configure a default router on the client. Although this approach simplifies client configuration and processing, it creates a single point of failure. If the default gateway fails, the LAN client is limited to communicating only on the local IP network segment and is cut off from the rest of the network.

VRRP can solve the static configuration problem by enabling a group of routers (a VRRP group) to share a single virtual IP address. You can then configure the LAN clients with the virtual IP address as their default gateway.

The following figure shows a basic VLAN topology. In this example, Routers A, B, and C form a VRRP group. The IP address of the group is the same address that was configured for the Ethernet interface of Router A (10.0.0.1).

Figure 46: Basic VRRP Topology

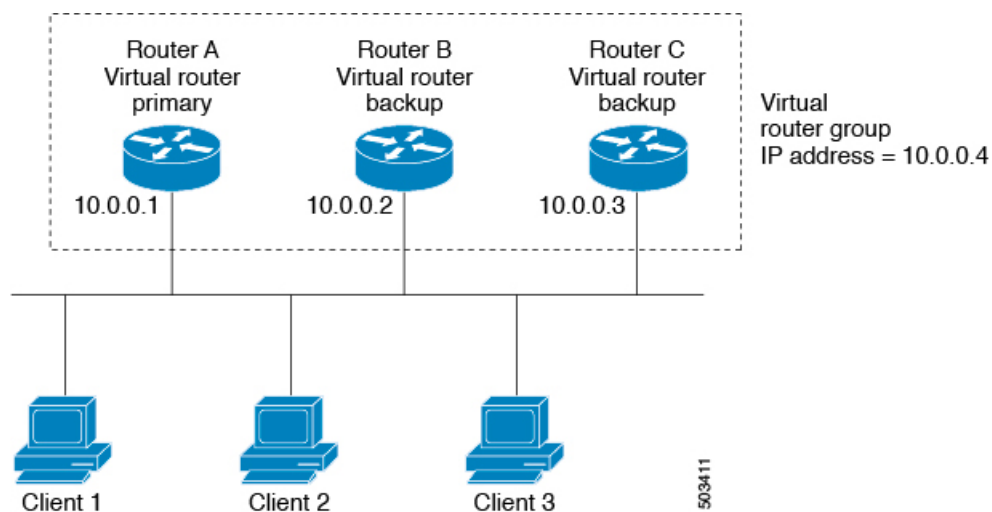

Because the virtual IP address uses the IP address of the physical Ethernet interface of Router A, Router A is the primary (also known as the IP address owner). As the primary, Router A owns the virtual IP address of the VRRP group and forwards packets sent to this IP address. Clients 1 through 3 are configured with the default gateway IP address of 10.0.0.1.

Routers B and C function as backups. If the primary fails, the backup router with the highest priority becomes the primary and takes over the virtual IP address to provide uninterrupted service for the LAN hosts. When Router A recovers, it becomes the primary again.



Note Packets received on a routed port destined for the VRRP virtual IP address terminate on the local router, regardless of whether that router is the primary VRRP router or a backup VRRP router. These packets include ping and Telnet traffic. Packets received on a Layer 2 (VLAN) interface destined for the VRRP virtual IP address terminate on the primary router.

VRRP Benefits

The benefits of VRRP are as follows:

- **Redundancy**—Enables you to configure multiple routers as the default gateway router, which reduces the possibility of a single point of failure in a network.
- **Load sharing**—Allows traffic to and from LAN clients to be shared by multiple routers. The traffic load is shared more equitably among available routers.
- **Multiple VRRP groups**—Supports multiple VRRP groups on a router physical interface if the platform supports multiple MAC addresses. Multiple VRRP groups enable you to implement redundancy and load sharing in your LAN topology.
- **Multiple IP addresses**—Allows you to manage multiple IP addresses, including secondary IP addresses. If you have multiple subnets that are configured on an Ethernet interface, you can configure VRRP on each subnet.
- **Preemption**—Enables you to preempt a backup router that has taken over for a failing primary with a higher priority backup router that has become available.
- **Advertisement protocol**—Uses a dedicated Internet Assigned Numbers Authority (IANA) standard multicast address (224.0.0.18) for VRRP advertisements. This addressing scheme minimizes the number of routers that must service the multicasts and allows test equipment to accurately identify VRRP packets on a segment. IANA has assigned the IP protocol number 112 to VRRP.
- **VRRP tracking**—Ensures that the best VRRP router is the primary for the group by altering VRRP priorities based on interface states.

Multiple VRRP Groups

You can configure multiple VRRP groups on a physical interface. For the number of supported VRRP groups, see the [Cisco Nexus 9000 Series NX-OS Verified Scalability Guide](#).

The number of VRRP groups that a router interface can support depends on the following factors:

- Router processing capability
- Router memory capability

In a topology where multiple VRRP groups are configured on a router interface, the interface can act as a primary for one VRRP group and as a backup for one or more other VRRP groups.

The following image shows a LAN topology in which VRRP is configured so that Routers A and B share the traffic to and from clients 1 through 4. Routers A and B act as backups to each other if either router fails.

Figure 47: Load Sharing and Redundancy VRRP Topology

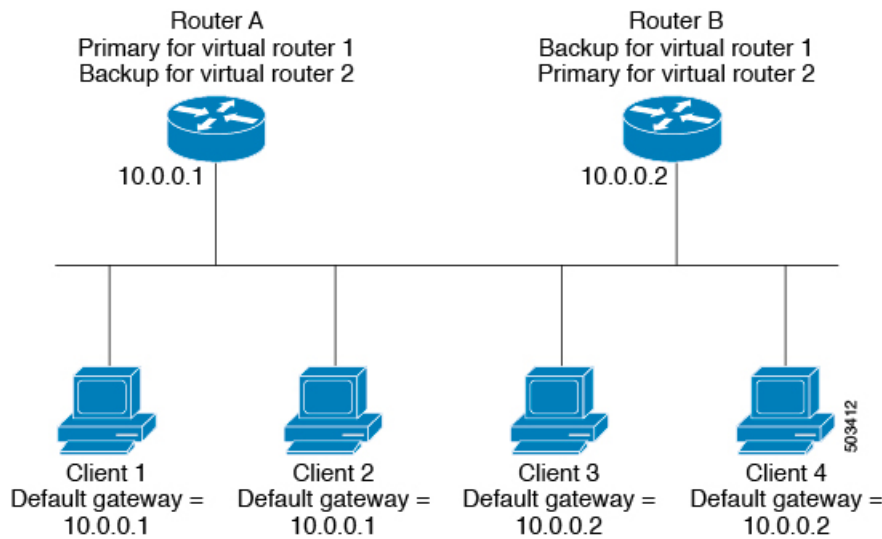

This topology contains two virtual IP addresses for two VRRP groups that overlap. For VRRP group 1, Router A is the owner of IP address 10.0.0.1 and is the primary. Router B is the backup to Router A. Clients 1 and 2 are configured with the default gateway IP address of 10.0.0.1.

For VRRP group 2, Router B is the owner of IP address 10.0.0.2 and is the primary. Router A is the backup to router B. Clients 3 and 4 are configured with the default gateway IP address of 10.0.0.2.

VRRP Router Priority and Preemption

An important aspect of the VRRP redundancy scheme is the VRRP router priority because the priority determines the role that each VRRP router plays and what happens if the primary router fails.

If a VRRP router owns the virtual IP address and the IP address of the physical interface, this router functions as the primary. The priority of the primary is 255.

The priority also determines if a VRRP router functions as a backup router and the order of ascendancy to becoming a primary if the primary fails.

For example, if Router A, the primary in a LAN topology, fails, VRRP must determine if backups B or C should take over. If you configure Router B with priority 101 and Router C with the default priority of 100, VRRP selects Router B to become the primary because it has the higher priority. If you configure Routers B and C with the default priority of 100, VRRP selects the backup with the higher IP address to become the primary.

VRRP uses preemption to determine what happens after a VRRP backup router becomes the primary. With preemption enabled by default, VRRP switches to a backup if that backup comes online with a priority higher than the new primary. For example, if Router A is the primary and fails, VRRP selects Router B (next in order of priority). If Router C comes online with a higher priority than Router B, VRRP selects Router C as the new primary, even though Router B has not failed.

If you disable preemption, VRRP switches only if the original primary recovers or the new primary fails.

vPCs and VRRP

VRRP interoperates with virtual port channels (vPCs). vPCs allow links that are physically connected to two different Cisco Nexus 9000 Series switches to appear as a single port channel by a third device. See the [Cisco Nexus 9000 Series NX-OS Layer 2 Switching Configuration Guide](#) for more information on vPCs.

vPCs forward traffic through both the primary VRRP router and the backup VRRP router. See the [Configuring VRRP Priority](#) section.



Note You should configure VRRP on the primary vPC peer device as active and VRRP on the vPC secondary device as standby.

VRRP Advertisements

The VRRP primary sends VRRP advertisements to other VRRP routers in the same group. The advertisements communicate the priority and state of the primary. Cisco NX-OS encapsulates the VRRP advertisements in IP packets and sends them to the IP multicast address assigned to the VRRP group. Cisco NX-OS sends the advertisements once every second by default, but you can configure a different advertisement interval.

VRRP Authentication

VRRP supports the following authentication functions:

- No authentication
- Plain text authentication

VRRP rejects packets in any of the following cases:

- The authentication schemes differ on the router and in the incoming packet.
- Text authentication strings differ on the router and in the incoming packet.

VRRP Tracking

VRRP supports the following options for tracking:

- Native interface tracking—Tracks the state of an interface and uses that state to determine the priority of the VRRP router in a VRRP group. The tracked state is down if the interface is down or if the interface does not have a primary IP address.
- Object tracking—Tracks the state of a configured object and uses that state to determine the priority of the VRRP router in a VRRP group. See [Configuring Object Tracking](#) for more information on object tracking.

If the tracked state (interface or object) goes down, VRRP updates the priority based on what you configure the new priority to be for the tracked state. When the tracked state comes up, VRRP restores the original priority for the virtual router group.

For example, you might want to lower the priority of a VRRP group member if its uplink to the network goes down so another group member can take over as primary for the VRRP group. See the [Configuring VRRP Interface State Tracking](#) section for more information.



Note VRRP does not support Layer 2 interface tracking.

BFD for VRRP

This feature supports bidirectional forwarding detection (BFD). BFD is a detection protocol that provides fast-forwarding and path-failure detection times. BFD provides subsecond failure detection between two adjacent devices and can be less CPU-intensive than protocol hello messages because some of the BFD load can be distributed onto the data plane on supported modules. See the [Cisco Nexus 9000 Series NX-OS Interfaces Configuration Guide](#) for more information.

Information About VRRPv3 and VRRS

VRRP version 3 (VRRPv3) enables a group of switches to form a single virtual switch in order to provide redundancy and reduce the possibility of a single point of failure in a network. The LAN clients can then be configured with the virtual switch as their default gateway. The virtual switch, representing a group of switches, is also known as a VRRPv3 group.

Virtual Router Redundancy Service (VRRS) improves the scalability of VRRPv3 by providing a stateless redundancy service to VRRS pathways and VRRS clients by monitoring VRRPv3. VRRPv3 acts as a VRRS server that pushes VRRPv3 status information (such as current and previous redundancy states, active and inactive Layer 2 and Layer 3 addresses, and so on) to VRRS pathways and all registered VRRS clients.

VRRS clients are other Cisco processes or applications that use VRRPv3 to provide or withhold a service or resource dependent upon the state of the group. VRRS pathways are special VRRS clients that use the VRRS database information to provide scaled first-hop gateway redundancy across scaled interface environments.

VRRS by itself is limited to maintaining its own state. Linking a VRRS client to a VRRPv3 group provides a mechanism that allows VRRS to provide a service to client applications so that they can implement stateless or Stateful Failovers. A Stateful Failover requires communication with a nominated backup before the failure so that operational data is not lost when the failover occurs.

VRRS pathways operate in a similar way to clients but are integrated with the VRRS architecture. They provide a means to scale first-hop gateway redundancy by allowing you to configure a virtual address across hundreds of interfaces. The virtual gateway state of a VRRS pathway follows the state of a First-Hop Redundancy Protocol (FHRP) VRRS server.

VRRPv3 notifies VRRS of its current state (primary, backup, or nonoperational initial state [INIT]) and passes that information to pathways or clients. The VRRPv3 group name activates VRRS and associates the VRRPv3 group with any clients or pathways that are configured as part of VRRS with the same name.

Pathways and clients act on the VRRPv3 server state. When a VRRPv3 group changes states, VRRS pathways and clients alter their behavior (performing tasks such as shutting down interfaces or appending accounting logs) depending on the state that is received from VRRS.

VRRPv3 Benefits

The benefits of VRRPv3 are as follows:

- Interoperability in multi-vendor environments
- Support for the IPv4 and IPv6 address families
- Improved scalability through the use of VRRS pathways

VRRPv3 Object Tracking

Beginning with Cisco NX-OS Release 9.2(2), VRRPv3 supports object tracking, which tracks the state of a configured object and uses that state to determine the priority of the VRRPv3 router in a VRRPv3 group. See [Configuring Object Tracking](#) for more information on object tracking.

If the tracked object goes down, VRRPv3 decrements the priority by the configured value. The default value is 10. If the same tracked object goes down again, no action is taken. When the tracked object comes up, VRRPv3 increments the priority by the configured value.



Note VRRPv3 does not support Layer 2 interface tracking or native interface tracking.

High Availability

VRRP supports high availability through stateful restarts and stateful switchovers. A stateful restart occurs when the VRRP process fails and is restarted. A stateful switchover occurs when the active supervisor switches to the standby supervisor. Cisco NX-OS applies the run-time configuration after the switchover.

VRRPv3 does not support stateful switchovers.

Virtualization Support

VRRP supports virtual routing and forwarding (VRF) instances.

Guidelines and Limitations for VRRP

VRRP has the following configuration guidelines and limitations:

- You cannot configure VRRP on the management interface.
- When VRRP is enabled, you should replicate the VRRP configuration across devices in your network.
- We recommend that you do not configure more than one first-hop redundancy protocol on the same interface.
- You must configure an IP address for the interface on which you configure VRRP and enable that interface before VRRP becomes active.

- Cisco NX-OS removes all Layer 3 configurations on an interface when you change the interface VRF membership or the port channel membership or when you change the port mode to Layer 2.
- When you configure VRRP to track a Layer 2 interface, you must shut down the Layer 2 interface and reenable the interface to update the VRRP priority to reflect the state of the Layer 2 interface.

BFD for VRRP can only be configured between two routers.

Guidelines and Limitations for VRRPv3

VRRPv3 has the following configuration guidelines and limitations:

- In release 9.3(1), the VRRPv3 feature supports a maximum of 4095 VRRPv3 groups and VRRS pathways on Cisco Nexus 9504, 9508, and 9516 switches with -R line cards.
- VRRPv3 is not intended as a replacement for existing dynamic protocols. VRRPv3 is designed for use over multi-access, multicast, or broadcast-capable Ethernet LANs.
- VRRPv3 is supported only on Ethernet and Fast Ethernet interfaces, bridge group virtual interfaces (BVI), Gigabit Ethernet interfaces, and VLANs.
- When VRRPv3 is in use, VRRPv2 is unavailable. To configure VRRPv3, you must disable any VRRPv2 configuration.
- VRRS is currently available only for use with VRRPv3.
- Use VRRPv3 millisecond timers only where absolutely necessary and with careful consideration and testing. Millisecond values work only under favorable circumstances. The millisecond timer values are compatible with third-party vendors as long as they also support VRRPv3.
- Full network redundancy can be achieved only if VRRPv3 operates over the same network path as the VRRS pathway redundant interfaces. For full redundancy, the following restrictions apply:
 - VRRS pathways should use the same physical interface as the parent VRRPv3 group or be configured on a subinterface with the same physical interface as the parent VRRPv3 group.
 - VRRS pathways can be configured on switch virtual interfaces (SVIs) only if the associated VLAN shares the same trunk as the VLAN on which the parent VRRPv3 group is configured.
- Unlike VRRPv2, VRRPv3 does not support bidirectional forwarding for faster failure detection.
- Unlike VRRPv2, VRRPv3 does not support native interface tracking.
- You must create the object before configuring object tracking.
- The following guidelines and limitations apply to VRRPv3 object tracking:
 - Beginning with Cisco NX-OS Release 9.2(2), all Cisco Nexus 9000 Series switches and line cards support VRRPv3 object tracking.
 - We recommend that you do not use VRRPv3 object tracking in a vPC domain.

Default Settings for VRRP Parameters

The following table lists the default settings for VRRP parameters.

Table 31: Default VRRP Parameters

Parameters	Default
VRRP	Disabled
Advertisement interval	1 second
Authentication	No authentication
Preemption	Enabled
Priority	100

Default Settings for VRRPv3 Parameters

The following table lists the default settings for VRRPv3 parameters.

Table 32: Default VRRPv3 Parameters

Parameters	Default
VRRPv3	Disabled
VRRS	Disabled
VRRPv3 secondary address matching	Enabled
Priority of a VRRPv3 group	100
VRRPv3 advertisement timer	1000 milliseconds

Configuring VRRP



Note If you are familiar with the Cisco IOS CLI, be aware that the Cisco NX-OS commands for this feature might differ from the Cisco IOS commands that you would use.

Enabling VRRP

You must globally enable VRRP before you configure and enable any VRRP groups.

SUMMARY STEPS

1. **configure terminal**
2. **[no] feature vrrp**
3. (Optional) **copy running-config startup-config**

DETAILED STEPS

	Command or Action	Purpose
Step 1	configure terminal Example: <pre>switch# configure terminal switch(config)#</pre>	Enters global configuration mode.
Step 2	[no] feature vrrp Example: <pre>switch(config)# feature vrrp</pre>	Enables VRRP. Use the no form of this command to disable VRRP.
Step 3	(Optional) copy running-config startup-config Example: <pre>switch(config)# copy running-config startup-config</pre>	Copies the running configuration to the startup configuration.

Configuring VRRP Groups

You can create a VRRP group, assign the virtual IP address, and enable the group.

You can configure one virtual IPv4 address for a VRRP group. By default, the primary VRRP router drops the packets addressed directly to the virtual IP address because the VRRP primary is intended only as a next-hop router to forward packets. Some applications require that Cisco NX-OS accept packets that are addressed to the virtual router IP address. Use the secondary option to the virtual IP address to accept these packets when the local router is the VRRP primary.

Once you have configured the VRRP group, you must explicitly enable the group before it becomes active.

Before you begin

Ensure that you have configured an IP address on the interface. See [Configuring IPv4 Addressing, on page 27](#).

SUMMARY STEPS

1. **configure terminal**
2. **interface** *interface-type slot/port*
3. **vrrp** *number*
4. **address** *ip-address* [**secondary**]
5. **no shutdown**
6. (Optional) **show vrrp**
7. (Optional) **copy running-config startup-config**

DETAILED STEPS

	Command or Action	Purpose
Step 1	configure terminal Example: switch# configure terminal switch(config)#	Enters global configuration mode.
Step 2	interface interface-type slot/port Example: switch(config)# interface ethernet 2/1 switch(config-if)#	Enters interface configuration mode.
Step 3	vrrp number Example: switch(config-if)# vrrp 250 switch(config-if-vrrp)#	Creates a virtual router group. The range is 1–255.
Step 4	address ip-address [secondary] Example: switch(config-if-vrrp)# address 192.0.2.8	Configures the virtual IPv4 address for the specified VRRP group. This address should be in the same subnet as the IPv4 address of the interface. Use the secondary option only if applications require that VRRP routers accept the packets sent to the virtual router's IP address and deliver to applications.
Step 5	no shutdown Example: switch(config-if-vrrp)# no shutdown	Enables the VRRP group, which is disabled by default.
Step 6	(Optional) show vrrp Example: switch(config-if-vrrp)# show vrrp	Displays a summary of VRRP information.
Step 7	(Optional) copy running-config startup-config Example: switch(config-if-vrrp)# copy running-config startup-config	Copies the running configuration to the startup configuration.

Configuring VRRP Priority

The valid priority range for a virtual router is from 1 to 254 (1 is the lowest priority and 254 is the highest). The default priority value for backups is 100. For devices whose interface IP address is the same as the primary virtual IP address (the primary), the default value is 255.

If you configure VRRP on a vPC-enabled interface, you can optionally configure the upper and lower threshold values to control when to fail over to the vPC trunk. If the backup router priority falls below the lower threshold, VRRP sends all backup router traffic across the vPC trunk to forward through the primary VRRP router. VRRP maintains this scenario until the backup VRRP router priority increases above the upper threshold.

Before you begin

Ensure that you have configured an IP address on the interface. See [Configuring IPv4 Addressing, on page 27](#).

Ensure that you have enabled VRRP. (see the [Configuring VRRP](#) section).

SUMMARY STEPS

1. **configure terminal**
2. **interface** *interface-type slot/port*
3. **vrrp** *number*
4. **shutdown**
5. **priority** *level* [**forwarding-threshold** *lower lower-value upper upper-value*]
6. **no shutdown**
7. (Optional) **show vrrp**
8. (Optional) **copy running-config startup-config**

DETAILED STEPS

	Command or Action	Purpose
Step 1	configure terminal Example: <pre>switch# configure terminal switch(config)#</pre>	Enters global configuration mode.
Step 2	interface <i>interface-type slot/port</i> Example: <pre>switch(config)# interface ethernet 2/1 switch(config-if)#</pre>	Enters interface configuration mode.
Step 3	vrrp <i>number</i> Example: <pre>switch(config-if)# vrrp 250 switch(config-if-vrrp)#</pre>	Creates a virtual router group.
Step 4	shutdown Example: <pre>switch(config-if-vrrp)# shutdown</pre>	Disables the VRRP group.
Step 5	priority <i>level</i> [forwarding-threshold <i>lower lower-value upper upper-value</i>] Example: <pre>switch(config-if-vrrp)# priority 60 forwarding-threshold lower 40 upper 50</pre>	<p>Sets the priority level used to select the active router in a VRRP group. The <i>level</i> range is 1–254. The default is 100 for backups and 255 for a primary that has an interface IP address equal to the virtual IP address.</p> <p>Optionally, sets the upper and lower threshold values that are used by vPC to determine when to fail over to the vPC trunk. The <i>lower-value</i> range is 1–255. The default is 1. The <i>upper-value</i> range is 1–255. The default is 255.</p>

	Command or Action	Purpose
Step 6	no shutdown Example: <pre>switch(config-if-vrrp)# no shutdown</pre>	Enables the VRRP group.
Step 7	(Optional) show vrrp Example: <pre>switch(config-if-vrrp)# show vrrp</pre>	Displays a summary of VRRP information.
Step 8	(Optional) copy running-config startup-config Example: <pre>switch(config-if-vrrp)# copy running-config startup-config</pre>	Copies the running configuration to the startup configuration.

Configuring VRRP Authentication

You can configure simple text authentication for a VRRP group.

Before you begin

Ensure that you have configured an IP address on the interface (see [Configuring IPv4 Addressing, on page 27](#)).

Ensure that you have enabled VRRP (see the [Configuring VRRP](#) section).

Ensure that the authentication configuration is identical for all VRRP devices in the network.

SUMMARY STEPS

1. **configure terminal**
2. **interface** *interface-type slot/port*
3. **vrrp** *number*
4. **shutdown**
5. **authentication text** *password*
6. **no shutdown**
7. (Optional) **show vrrp**
8. (Optional) **copy running-config startup-config**

DETAILED STEPS

	Command or Action	Purpose
Step 1	configure terminal Example: <pre>switch# configure terminal switch(config)#</pre>	Enters global configuration mode.

	Command or Action	Purpose
Step 2	interface <i>interface-type slot/port</i> Example: switch(config)# interface ethernet 2/1 switch(config-if)#	Enters interface configuration mode.
Step 3	vrrp <i>number</i> Example: switch(config-if)# vrrp 250 switch(config-if-vrrp)#	Creates a virtual router group.
Step 4	shutdown Example: switch(config-if-vrrp)# shutdown	Disables the VRRP group.
Step 5	authentication text <i>password</i> Example: switch(config-if-vrrp)# authentication text aPassword	Assigns the simple text authentication option and specifies the keyname password. The keyname range is from 1 to 255 characters. We recommend that you use at least 16 characters. The text password is up to eight alphanumeric characters.
Step 6	no shutdown Example: switch(config-if-vrrp)# no shutdown	Enables the VRRP group, which is disabled by default.
Step 7	(Optional) show vrrp Example: switch(config-if-vrrp)# show vrrp	Displays a summary of VRRP information.
Step 8	(Optional) copy running-config startup-config Example: switch(config-if-vrrp)# copy running-config startup-config	Copies the running configuration to the startup configuration.

Configuring Time Intervals for Advertisement Packets

You can configure the time intervals for advertisement packets.

Before you begin

Ensure that you have configured an IP address on the interface (see [Configuring IPv4 Addressing](#), on page 27).

Ensure that you have enabled VRRP (see the [Configuring VRRP](#) section).

SUMMARY STEPS

1. configure terminal

2. **interface** *interface-type slot/port*
3. **vrrp** *number*
4. **shutdown**
5. **advertisement interval** *seconds*
6. **no shutdown**
7. (Optional) **show vrrp**
8. (Optional) **copy running-config startup-config**

DETAILED STEPS

	Command or Action	Purpose
Step 1	configure terminal Example: <pre>switch# configure terminal switch(config)#</pre>	Enters global configuration mode.
Step 2	interface <i>interface-type slot/port</i> Example: <pre>switch(config)# interface ethernet 2/1 switch(config-if)#</pre>	Enters interface configuration mode.
Step 3	vrrp <i>number</i> Example: <pre>switch(config-if)# vrrp 250 switch(config-if-vrrp)#</pre>	Creates a virtual router group.
Step 4	shutdown Example: <pre>switch(config-if-vrrp)# shutdown</pre>	Disables the VRRP group.
Step 5	advertisement interval <i>seconds</i> Example: <pre>switch(config-if-vrrp)# advertisement-interval 15</pre>	Sets the interval time in seconds between sending advertisement frames. The range is from 1 to 255. The default is 1 second.
Step 6	no shutdown Example: <pre>switch(config-if-vrrp)# no shutdown</pre>	Enables the VRRP group.
Step 7	(Optional) show vrrp Example: <pre>switch(config-if-vrrp)# show vrrp</pre>	Displays a summary of VRRP information.
Step 8	(Optional) copy running-config startup-config Example: <pre>switch(config-if-vrrp)# copy running-config startup-config</pre>	Copies the running configuration to the startup configuration.

Disabling Preemption

You can disable preemption for a VRRP group member. If you disable preemption, a higher-priority backup router does not take over for a lower-priority primary router. Preemption is enabled by default.

Before you begin

Ensure that you have configured an IP address on the interface. See [Configuring IPv4 Addressing, on page 27](#).

Ensure that you have enabled VRRP. See the [Configuring VRRP](#) section.

SUMMARY STEPS

1. **configure terminal**
2. **interface** *interface-type slot/port*
3. **vrrp** *number*
4. **shutdown**
5. **no preempt**
6. **no shutdown**
7. (Optional) **show vrrp**
8. (Optional) **copy running-config startup-config**

DETAILED STEPS

	Command or Action	Purpose
Step 1	configure terminal Example: <pre>switch# configure terminal switch(config)#</pre>	Enters global configuration mode.
Step 2	interface <i>interface-type slot/port</i> Example: <pre>switch(config)# interface ethernet 2/1 switch(config-if)#</pre>	Enters interface configuration mode.
Step 3	vrrp <i>number</i> Example: <pre>switch(config-if)# vrrp 250 switch(config-if-vrrp)#</pre>	Creates a virtual router group.
Step 4	shutdown Example: <pre>switch(config-if-vrrp)# shutdown</pre>	Disables the VRRP group.
Step 5	no preempt Example: <pre>switch(config-if-vrrp)# no preempt</pre>	Disables the preempt option and allows the primary to remain when a higher-priority backup appears.

	Command or Action	Purpose
Step 6	no shutdown Example: <pre>switch(config-if-vrrp)# no shutdown</pre>	Enables the VRRP group.
Step 7	(Optional) show vrrp Example: <pre>switch(config-if-vrrp)# show vrrp</pre>	Displays a summary of VRRP information.
Step 8	(Optional) copy running-config startup-config Example: <pre>switch(config-if-vrrp)# copy running-config startup-config</pre>	Copies the running configuration to the startup configuration.

Configuring VRRP Interface State Tracking

Interface state tracking changes the priority of the virtual router based on the state of another interface in the device. When the tracked interface goes down or the IP address is removed, Cisco NX-OS assigns the tracking priority value to the virtual router. When the tracked interface comes up and an IP address is configured on this interface, Cisco NX-OS restores the configured priority to the virtual router (see the [Configuring VRRP Priority](#) section).



Note VRRP does not support Layer 2 interface tracking.

Before you begin

Ensure that you have configured an IP address on the interface (see [Configuring IPv4 Addressing](#), on page 27).

Ensure that you have enabled VRRP (see the [Configuring VRRP](#) section).

Ensure that you have enabled the virtual router (see the [Configuring VRRP Groups](#) section).

Ensure that you have enabled preemption on the interface.

SUMMARY STEPS

1. **configure terminal**
2. **interface** *interface-type slot/port*
3. **vrrp** *number*
4. **shutdown**
5. **track interface** *type slot/port* **priority** *value*
6. **no shutdown**
7. (Optional) **show vrrp**
8. (Optional) **copy running-config startup-config**

DETAILED STEPS

	Command or Action	Purpose
Step 1	configure terminal Example: switch# configure terminal switch(config)#	Enters global configuration mode.
Step 2	interface interface-type slot/port Example: switch(config)# interface ethernet 2/1 switch(config-if)#	Enters interface configuration mode.
Step 3	vrrp number Example: switch(config-if)# vrrp 250 switch(config-if-vrrp)#	Creates a virtual router group.
Step 4	shutdown Example: switch(config-if-vrrp)# shutdown	Disables the VRRP group.
Step 5	track interface type slot/port priority value Example: switch(config-if-vrrp)# track interface ethernet 2/10 priority 254	Enables interface priority tracking for a VRRP group. The priority range is from 1 to 254.
Step 6	no shutdown Example: switch(config-if-vrrp)# no shutdown	Enables the VRRP group.
Step 7	(Optional) show vrrp Example: switch(config-if-vrrp)# show vrrp	Displays a summary of VRRP information.
Step 8	(Optional) copy running-config startup-config Example: switch(config-if-vrrp)# copy running-config startup-config	Copies the running configuration to the startup configuration.

Configuring VRRP Object Tracking

You can track an IPv4 object using VRRP.

Before you begin

Make sure that VRRP is enabled.

Configure object tracking using the commands in [Configuring Object Tracking](#) section.

SUMMARY STEPS

1. **configure terminal**
2. **interface type number**
3. **vrrp number address-family ipv4**
4. **track object-number decrement number**
5. (Optional) **show running-config vrrp**
6. (Optional) **copy running-config startup-config**

DETAILED STEPS

	Command or Action	Purpose
Step 1	configure terminal Example: <pre>switch# configure terminal switch(config)#</pre>	Enters global configuration mode.
Step 2	interface type number Example: <pre>switch(config)# switch(config-if)# interface ethernet 2/1 switch(config-if)#</pre>	Specifies an interface and enters interface configuration mode.
Step 3	vrrp number address-family ipv4 Example: <pre>switch(config-if)# vrrp 5 address-family ipv4 switch(config-if-vrrp-group)#</pre>	Creates a VRRP group for IPv4 and enters VRRP vrrp number address-family ipv4 group configuration mode. The range is from 1 to 255.
Step 4	track object-number decrement number Example: <pre>switch(config-if-vrrp-group)# track 1 decrement 2</pre>	Creates a virtual router group. The range is from 1 to 255.
Step 5	(Optional) show running-config vrrp Example: <pre>switch(config-if-vrrp-group)# show running-config vrrp</pre>	Displays the running configuration for VRRP.
Step 6	(Optional) copy running-config startup-config Example: <pre>switch(config-if-vrrp-group)# copy running-config startup-config</pre>	Saves this configuration change.

Configuring VRRPv3

Enabling VRRPv3 and VRRS

You must globally enable VRRPv3 before you can configure and enable any VRRPv3 groups.

SUMMARY STEPS

1. **configure terminal**
2. **[no] feature vrrpv3**
3. (Optional) **copy running-config startup-config**

DETAILED STEPS

	Command or Action	Purpose
Step 1	configure terminal Example: <pre>switch# configure terminal switch(config)#</pre>	Enters global configuration mode.
Step 2	[no] feature vrrpv3 Example: <pre>switch(config)# feature vrrpv3</pre>	Enables VRRP version 3 and Virtual Router Redundancy Service (VRRS). The no form of this command disables VRRPv3 and VRRS. If VRRPv2 is currently configured, use the no feature vrrp command in global configuration mode to remove the VRRPv2 configuration and then use the feature vrrpv3 command to enable VRRPv3.
Step 3	(Optional) copy running-config startup-config Example: <pre>switch(config)# copy running-config startup-config</pre>	Copies the running configuration to the startup configuration.

Creating VRRPv3 Groups

You can create a VRRPv3 group, assign the virtual IP address, and enable the group.

Before you begin

Make sure that VRRPv3 is enabled.

Make sure that you have configured an IP address on the interface.

SUMMARY STEPS

1. **configure terminal**
2. **interface ethernet slot/port**

3. **vrrpv3** *number address-family [ipv4 | ipv6]*
4. (Optional) **address** *ip-address [primary | secondary]*
5. (Optional) **description** *description*
6. (Optional) **match-address**
7. (Optional) **preempt** [**delay minimum** *seconds*]
8. (Optional) **priority** *level*
9. (Optional) **timers advertise** *interval*
10. (Optional) **vrrp2**
11. (Optional) **vrrs leader** *vrrs-leader-name*
12. (Optional) **shutdown**
13. (Optional) **show fhrp** [*interface-type interface-number*] [**verbose**]
14. (Optional) **show vrrpv3** *interface-type interface-number*
15. (Optional) **copy running-config startup-config**

DETAILED STEPS

	Command or Action	Purpose
Step 1	configure terminal Example: <pre>switch# configure terminal switch(config)#</pre>	Enters global configuration mode.
Step 2	interface ethernet <i>slot/port</i> Example: <pre>switch(config)# interface ethernet 2/1 switch(config-if)#</pre>	Enters interface configuration mode.
Step 3	vrrpv3 <i>number address-family [ipv4 ipv6]</i> Example: <pre>switch(config-if)# vrrpv3 5 address-family ipv4 switch(config-if-vrrpv3-group)#</pre>	Creates a VRRPv3 group and enters VRRPv3 group configuration mode. The range is 1–255.
Step 4	(Optional) address <i>ip-address [primary secondary]</i> Example: <pre>switch(config-if-vrrpv3-group)# address 100.0.1.10 primary</pre>	Specifies a primary or secondary IPv4 or IPv6 address for the VRRPv3 group. To utilize secondary IP addresses in a VRRPv3 group, you must first configure a primary IP address on the same group.
Step 5	(Optional) description <i>description</i> Example: <pre>switch(config-if-vrrpv3-group)# description group3</pre>	Specifies a description for the VRRPv3 group. You can enter up to 80 alphanumeric characters.
Step 6	(Optional) match-address Example: <pre>switch(config-if-vrrpv3-group)# match-address</pre>	Matches the secondary address in the advertisement packet against the configured address.

	Command or Action	Purpose
Step 7	(Optional) preempt [delay minimum seconds] Example: switch(config-if-vrrpv3-group)# preempt delay minimum 30	Enables preemption of a lower priority primary switch with an optional delay. The range is 0–3600.
Step 8	(Optional) priority level Example: switch(config-if-vrrpv3-group)# priority 3	Specifies the priority of the VRRPv3 group. The range is 1–254.
Step 9	(Optional) timers advertise interval Example: switch(config-if-vrrpv3-group)# timers advertise 1000	Sets the advertisement timer in milliseconds. The range is 100–40950. Cisco recommends that you set this timer to a value greater than or equal to 1 second.
Step 10	(Optional) vrrp2 Example: switch(config-if-vrrpv3-group)# vrrp2	Enables support for VRRPv2 simultaneously to ensure interoperability with devices that support only VRRPv2. VRRPv2 compatibility mode is provided to allow an upgrade from VRRPv2 to VRRPv3. This is not a full VRRPv2 implementation and should be used only to perform an upgrade.
Step 11	(Optional) vrrs leader vrrs-leader-name Example: switch(config-if-vrrpv3-group)# vrrs leader leader1	Specifies a leader's name to be registered with VRRS.
Step 12	(Optional) shutdown Example: switch(config-if-vrrpv3-group)# shutdown	Disables the VRRP configuration for the VRRPv3 group.
Step 13	(Optional) show fhrp [<i>interface-type interface-number</i>] [verbose] Example: switch(config-if-vrrpv3-group)# show fhrp ethernet 2/1 verbose	Displays First Hop Redundancy Protocol (FHRP) information. Use the verbose keyword to view detailed information.
Step 14	(Optional) show vrrpv3 <i>interface-type interface-number</i> Example: switch(config-if-vrrpv3-group)# show vrrpv3 ethernet 2/1	Displays the VRRPv3 configuration information for the specified interface.
Step 15	(Optional) copy running-config startup-config Example: switch(config-if-vrrpv3-group)# copy running-config startup-config	Copies the running configuration to the startup configuration.

Configuring VRRPv3 Control Groups

You can configure VRRPv3 control groups.

Before you begin

Make sure that VRRPv3 is enabled.

Make sure that you have configured an IP address on the interface.

SUMMARY STEPS

1. **configure terminal**
2. **interface ethernet** *slot/port*
3. **ip address** *ip-address mask* [**secondary**]
4. **vrrpv3 number address-family** [**ipv4** | **ipv6**]
5. (Optional) **address** *ip-address* [**primary** | **secondary**]
6. (Optional) **shutdown**
7. (Optional) **show fhrp** [*interface-type interface-number*] [**verbose**]
8. (Optional) **show vrrpv3** *interface-type interface-number*
9. (Optional) **copy running-config startup-config**

DETAILED STEPS

	Command or Action	Purpose
Step 1	configure terminal Example: switch# configure terminal switch(config)#	Enters global configuration mode.
Step 2	interface ethernet <i>slot/port</i> Example: switch(config)# interface ethernet 2/1 switch(config-if)#	Enters interface configuration mode.
Step 3	ip address <i>ip-address mask</i> [secondary] Example: switch(config-if)# ip address 209.165.200.230 255.255.255.224	Configures the IP address on the interface. You can use the secondary keyword to configure additional IP addresses on the interface.
Step 4	vrrpv3 number address-family [ipv4 ipv6] Example: switch(config-if)# vrrpv3 5 address-family ipv4 switch(config-if-vrrpv3-group)#	Creates a VRRPv3 group and enters VRRPv3 group configuration mode. The range is from 1 to 255.
Step 5	(Optional) address <i>ip-address</i> [primary secondary] Example: switch(config-if-vrrpv3-group)# address 209.165.200.227 primary	Specifies a primary or secondary IPv4 or IPv6 address for the VRRPv3 group.

	Command or Action	Purpose
Step 6	(Optional) shutdown Example: switch(config-if-vrrpv3-group)# shutdown	Disables the VRRP configuration for the VRRPv3 group.
Step 7	(Optional) show fhrp [<i>interface-type interface-number</i>] [verbose] Example: switch(config-if-vrrpv3-group)# show fhrp ethernet 2/1 verbose	Displays First Hop Redundancy Protocol (FHRP) information. Use the verbose keyword to view detailed information.
Step 8	(Optional) show vrrpv3 <i>interface-type interface-number</i> Example: switch(config-if-vrrpv3-group)# show vrrpv3 ethernet 2/1	Displays the VRRPv3 configuration information for the specified interface.
Step 9	(Optional) copy running-config startup-config Example: switch(config-if-vrrpv3-group)# copy running-config startup-config	Copies the running configuration to the startup configuration.

Configuring VRRPv3 Object Tracking

You can track an IPv4 or IPv6 object using VRRPv3.

Before you begin

Make sure that VRRPv3 is enabled.

Configure object tracking using the commands in [Configuring Object Tracking](#) section.

SUMMARY STEPS

1. **configure terminal**
2. **interface type number**
3. **vrrpv3 number address-family [ipv4 | ipv6]**
4. **track object-number decrement number**
5. (Optional) **show running-config vrrpv3**
6. (Optional) **copy running-config startup-config**

DETAILED STEPS

	Command or Action	Purpose
Step 1	configure terminal Example: switch# configure terminal switch(config)#	Enters global configuration mode.

	Command or Action	Purpose
Step 2	interface type number Example: <pre>switch(config)# switch(config-if)# interface ethernet 2/1 switch(config-if)#</pre>	Specifies an interface and enters interface configuration mode.
Step 3	vrrpv3 number address-family [ipv4 ipv6] Example: <pre>switch(config-if)# vrrpv3 5 address-family ipv6 switch(config-if-vrrpv3-group)#</pre>	Creates a VRRPv3 group for IPv4 or IPv6 and enters VRRPv3 group configuration mode. The range is from 1 to 255.
Step 4	track object-number decrement number Example: <pre>switch(config-if-vrrpv3-group)# object-track 1 decrement 2</pre>	Configures the process to track the state of the IPv4 or IPv6 object using the VRRPv3 group. VRRPv3 on the interface registers with the tracking process to be informed of any changes to the object in the VRRPv3 group. If the object state on the interface goes down, the priority of the VRRPv3 group is reduced by the decrement number specified.
Step 5	(Optional) show running-config vrrpv3 Example: <pre>switch(config-if-vrrp-group)# show running-config vrrp</pre>	Displays the running configuration for VRRPv3.
Step 6	(Optional) copy running-config startup-config Example: <pre>switch(config-if-vrrp-group)# copy running-config startup-config</pre>	Saves this configuration change.

Configuring VRRS Pathways

You can configure a Virtual Router Redundancy Service (VRRS) pathway. In scaled environments, VRRS pathways should be used in combination with VRRPv3 control groups.

Before you begin

Make sure that VRRPv3 is enabled.

Make sure that you have configured an IP address on the interface.

SUMMARY STEPS

1. **configure terminal**
2. **interface ethernet slot/port**
3. **ip address ip-address mask [secondary]**
4. **vrrs pathway vrrs-tag**
5. **mac address {mac-address | inherit}**
6. **address ip-address**

7. (Optional) **show vrrs pathway interface-type interface-number**
8. (Optional) **copy running-config startup-config**

DETAILED STEPS

	Command or Action	Purpose
Step 1	configure terminal Example: <pre>switch# configure terminal switch(config)#</pre>	Enters global configuration mode.
Step 2	interface ethernet slot/port Example: <pre>switch(config)# interface ethernet 2/1 switch(config-if)#</pre>	Enters interface configuration mode.
Step 3	ip address ip-address mask [secondary] Example: <pre>switch(config-if)# ip address 209.165.200.230 255.255.255.224</pre>	Configures the IP address on the interface. You can use the secondary keyword to configure additional IP addresses on the interface.
Step 4	vrrs pathway vrrs-tag Example: <pre>switch(config-if)# vrrs pathway path1 switch(config-if-vrrs-pw)#</pre>	Defines the VRRS pathway for a VRRS group and enters VRRS pathway configuration mode. The <i>vrrs-tag</i> argument specifies the name of the VRRS tag that is being associated with the pathway.
Step 5	mac address {mac-address inherit} Example: <pre>switch(config-if-vrrs-pw)# mac address fe24.fe24.fe24</pre>	Specifies a MAC address for the pathway. The inherit keyword causes the pathway to inherit the virtual MAC address of the VRRPv3 group with which the pathway is associated.
Step 6	address ip-address Example: <pre>switch(config-if-vrrs-pw)# address 209.165.201.10</pre>	Defines the virtual IPv4 or IPv6 address for a pathway. A VRRPv3 group is capable of controlling more than one pathway.
Step 7	(Optional) show vrrs pathway interface-type interface-number Example: <pre>switch(config-if-vrrs-pw)# show vrrs pathway ethernet 1/2</pre>	Displays the VRRS pathway information for different pathway states, such as active, inactive, and not ready.
Step 8	(Optional) copy running-config startup-config Example: <pre>switch(config-if-vrrs-pw)# copy running-config startup-config</pre>	Copies the running configuration to the startup configuration.

Verifying the VRRP Configuration

To display VRRP configuration information, perform one of the following tasks:

Command	Purpose
show interface <i>interface-type</i>	Displays the virtual router configuration for an interface.
show fhrp <i>interface-type interface-number</i>	Displays First Hop Redundancy Protocol (FHRP) information.
show vrrp [<i>group-number</i>]	Displays the VRRP status for all groups or for a specific VRRP group.

Verifying the VRRPv3 Configuration

To display VRRPv3 configuration information, perform one of the following tasks:

Command	Purpose
show vrrpv3 [all brief detail]	Displays the VRRPv3 configuration information.
show vrrpv3 <i>interface-type interface-number</i>	Displays the VRRPv3 configuration information for a specific interface.
show vrrs client [<i>client-name</i>]	Displays the VRRS client information.
show vrrs pathway [<i>interface-type interface-number</i>]	Displays the VRRS pathway information for different pathway states, such as active, inactive, and not ready.
show vrrs server	Displays the VRRS server information.
show vrrs tag [<i>tag-name</i>]	Displays the VRRS tag information.

Monitoring and Clearing VRRP Statistics

To display VRRP statistics, use the following commands:

Command	Purpose
show vrrp statistics	Displays the VRRP statistics.

Use the **clear vrrp statistics** command to clear the VRRP statistics for all interfaces on the device.

Monitoring and Clearing VRRPv3 Statistics

To display VRRPv3 statistics, use the following commands:

Command	Purpose
<code>show vrrpv3 statistics</code>	Displays the VRRPv3 statistics.

Use the `clear vrrpv3 statistics` command to clear the VRRPv3 statistics for all interfaces on the device.

Configuration Examples for VRRP

In this example, Router A and Router B each belong to three VRRP groups. In the configuration, each group has the following properties:

- Group 1:
 - Virtual IP address is 10.1.0.10.
 - Router A becomes the primary for this group with priority 120.
 - Advertising interval is 3 seconds.
 - Pre-emption is enabled.
- Group 5:
 - Router B becomes the primary for this group with priority 200.
 - Advertising interval is 30 seconds.
 - Pre-emption is enabled.
- Group 100:
 - Router A becomes the primary for this group first because it has a higher IP address (10.1.0.2).
 - Advertising interval is the default of 1 second.
 - Pre-emption is disabled.

Router A

```
switch (config)# interface ethernet 1/1
switch (config-if)# ip address 10.1.0.1/16
switch (config-if)# no shutdown
switch (config-if)# vrrp 1
switch (config-if-vrrp)# priority 120
switch (config-if-vrrp)# authentication text cisco
switch (config-if-vrrp)# advertisement-interval 3
switch (config-if-vrrp)# address 10.1.0.10
switch (config-if-vrrp)# no shutdown
switch (config-if-vrrp)# exit
switch (config-if)# vrrp 5
switch (config-if-vrrp)# priority 100
```



```

switch (config-if-vrrp) # advertisement-interval 30
switch (config-if-vrrp) # address 10.1.0.50
switch (config-if-vrrp) # no shutdown
switch (config-if-vrrp) # exit
switch (config-if) # vrrp 100
switch (config-if-vrrp) # no preempt
switch (config-if-vrrp) # address 10.1.0.100
switch (config-if-vrrp) # no shutdown

```

Router B

```

switch (config) # interface ethernet 1/1
switch (config-if) # ip address 10.1.0.2/16
switch (config-if) # no shutdown
switch (config-if) # vrrp 1
switch (config-if-vrrp) # priority 100
switch (config-if-vrrp) # authentication text cisco
switch (config-if-vrrp) # advertisement-interval 3
switch (config-if-vrrp) # address 10.1.0.10
switch (config-if-vrrp) # no shutdown
switch (config-if-vrrp) # exit
switch (config-if) # vrrp 5
switch (config-if-vrrp) # priority 200
switch (config-if-vrrp) # advertisement-interval 30
switch (config-if-vrrp) # address 10.2.0.50
switch (config-if-vrrp) # no shutdown
switch (config-if-vrrp) # exit
switch (config-if) # vrrp 100
switch (config-if-vrrp) # no preempt
switch (config-if-vrrp) # address 10.2.0.100
switch (config-if-vrrp) # no shutdown

```

Configuration Examples for VRRPv3

This example shows how to enable VRRPv3 and create and customize a VRRPv3 group:

```

switch# configure terminal
switch(config) # feature vrrpv3
switch(config) # interface ethernet 4/6
switch(config-if) # vrrpv3 5 address-family ipv4
switch(config-if-vrrpv3-group) # address 209.165.200.225 primary
switch(config-if-vrrpv3-group) # description group3
switch(config-if-vrrpv3-group) # match-address
switch(config-if-vrrpv3-group) # preempt delay minimum 30
switch(config-if-vrrpv3-group) # show fhrp ethernet 4/6 verbose
switch(config-if-vrrpv3-group) # show vrrpv3 ethernet 4/6

```

This example shows how to configure a VRRPv3 control group:

```

switch# configure terminal
switch(config) # interface ethernet 1/2
switch(config-if) # ip address 209.165.200.230 255.255.255.224
switch(config-if) # vrrpv3 5 address-family ipv4
switch(config-if-vrrpv3-group) # address 209.165.200.227 primary
switch(config-if-vrrpv3-group) # vrrs leader leader1
switch(config-if-vrrpv3-group) # shutdown
switch(config-if-vrrpv3-group) # show fhrp ethernet 1/2 verbose
switch(config-if-vrrpv3-group) # show vrrpv3 ethernet 1/2

```

This example shows how to configure object tracking for VRRPv3:

```

track 1 interface Ethernet1/12 ip routing
track 2 interface Ethernet1/12 ipv6 routing
track 3 interface Ethernet1/12 line-protocol
track 4 interface Ethernet1/12.1 ip routing
track 5 interface Ethernet1/12.1 ipv6 routing
track 6 interface Ethernet1/12.1 line-protocol
track 7 interface loopback1 ip routing
track 8 interface loopback1 ipv6 routing
track 9 interface loopback1 line-protocol
track 10 interface port-channell1 ip routing
track 11 interface port-channell1 ipv6 routing
track 12 interface port-channell1 line-protocol
track 13 ip route 170.10.10.10/24 reachability
track 14 ip route 180.10.10.0/24 reachability hmm
track 15 ipv6 route 2001::170:10:10:10/128 reachability
track 16 list boolean and
object 1
object 2
interface Vlan10
vrrpv3 10 address-family ipv4
timers advertise 100
priority 200
object-track 1 decrement 2
object-track 2 decrement 2
object-track 3 decrement 2
object-track 4 decrement 2
object-track 5 decrement 2
object-track 6 decrement 2
object-track 7 decrement 2
object-track 8 decrement 2
object-track 9 decrement 2
object-track 10 decrement 2
address 10.10.10.3 primary
interface Vlan10
vrrpv3 10 address-family ipv6
timers advertise 100
priority 200
object-track 1 decrement 4
object-track 2 decrement 4
object-track 3 decrement 4
object-track 4 decrement 4
object-track 5 decrement 4
object-track 6 decrement 4
object-track 7 decrement 4
object-track 8 decrement 4

```

This example shows how to configure VRRS pathways:

```

switch# configure terminal
switch(config)# interface ethernet 1/2
switch(config-if)# ip address 209.165.200.230 255.255.255.224
switch(config-if)# vrrs pathway path1
switch(config-if-vrrs-pw)# mac address inherit
switch(config-if-vrrs-pw)# address 209.165.201.10
switch(config-if-vrrs-pw)# show vrrs pathway ethernet 1/2

```

Additional References

Related Documents for VRRP

Related Topic	Document Title
Configuring the Hot Standby Routing Protocol (HSRP)	Configuring HSRP, on page 567
Configuring high availability	Cisco Nexus 9000 Series NX-OS High Availability and Redundancy Guide



CHAPTER 21

Configuring Object Tracking

This chapter contains the following sections:

- [Information About Object Tracking, on page 625](#)
- [Configuration Examples for Object Tracking, on page 627](#)
- [Guidelines and Limitations for Object Tracking, on page 627](#)
- [Default Settings, on page 627](#)
- [Configuring Object Tracking, on page 627](#)
- [Verifying the Object Tracking Configuration, on page 638](#)
- [Configuration Examples for Object Tracking, on page 638](#)
- [Related Topics, on page 638](#)
- [Additional References, on page 638](#)

Information About Object Tracking

Object tracking allows you to track specific objects on the device, such as the interface line protocol state, IP routing, and route reachability, and to take action when the tracked object's state changes. This feature allows you to increase the availability of the network and shorten recovery time if an object state goes down.

Object Tracking Overview

Object tracking allows you to track specific objects on the device, such as the interface line protocol state, IP routing, and route reachability, and to take action when the state of the tracked object changes. This feature allows you to increase the availability of the network and shorten recovery time if an object state goes down.

The object tracking feature allows you to create a tracked object that multiple clients can use to modify the client behavior when a tracked object changes. Several clients register their interest with the tracking process, track the same object, and take different actions when the object state changes.

Clients include the following features:

- Embedded Event Manager (EEM)
- Hot Standby Redundancy Protocol (HSRP)
- Virtual port channel (vPC)
- Virtual Router Redundancy Protocol (VRRP) and VRRPv3

The object tracking monitors the status of the tracked objects and communicates any changes made to interested clients. Each tracked object is identified by a unique number that clients can use to configure the action to take when a tracked object changes state.

Cisco NX-OS tracks the following object types:

- Interface line protocol state—Tracks whether the line protocol state is up or down.
- Interface IP routing state—Tracks whether the interface has an IPv4 or IPv6 address and if IPv4 or IPv6 routing is enabled and active.
- IP route reachability—Tracks whether an IPv4 or IPv6 route exists and is reachable from the local device.

For example, you can configure HSRP to track the line protocol of the interface that connects one of the redundant routers to the rest of the network. If that link protocol goes down, you can modify the priority of the affected HSRP router and cause a switchover to a backup router that has better network connectivity.

Object Track List

An object track list allows you to track the combined states of multiple objects. Object track lists support the following capabilities:

- Boolean "and" function—Each object defined within the track list must be in an up state so that the track list object can become up.
- Boolean "or" function—At least one object defined within the track list must be in an up state so that the tracked object can become up.
- Threshold percentage—The percentage of up objects in the tracked list must be greater than the configured up threshold for the tracked list to be in the up state. If the percentage of down objects in the tracked list is above the configured track list down threshold, the tracked list is marked as down.
- Threshold weight—Assign a weight value to each object in the tracked list and a weight threshold for the track list. If the combined weights of all up objects exceed the track list weight up threshold, the track list is in an up state. If the combined weights of all the down objects exceed the track list weight down threshold, the track list is in the down state.

Other entities, such as virtual port channels (vPCs) can use an object track list to modify the state of a vPC based on the state of the multiple peer links that create the vPC. See the [Cisco Nexus 9000 Series NX-OS Interfaces Configuration Guide](#) for more information on vPCs.

See the [Configuring an Object Track List with a Boolean Expression](#) section for more information on track lists.

High Availability

Object tracking supports high availability through stateful restarts. A stateful restart occurs when the object tracking process crashes. Object tracking also supports a stateful switchover on a dual-supervisor system. Cisco NX-OS applies the runtime configuration after the switchover.

You can also use object tracking to modify the behavior of a client to improve overall network availability.

Virtualization Support

Object tracking supports virtual routing and forwarding (VRF) instances. By default, Cisco NX-OS tracks the route reachability state of objects in the default VRF. If you want to track objects in another VRF, you must configure the object to be a member of that VRF (see the [Configuring Object Tracking for a Nondefault VRF](#) section).

Configuration Examples for Object Tracking

This example shows how to configure object tracking for route reachability and use VRF Red to look up reachability information for this route:

```
switch# configure terminal
switch(config)# track 2 ip route 209.165.201.0/8 reachability
switch(config-track)# vrf member Red
switch(config-track)# copy running-config startup-config
```

Guidelines and Limitations for Object Tracking

Object tracking has the following configuration guidelines and limitations:

- Supports Ethernet, subinterfaces, port channels, loopback interfaces, and VLAN interfaces.
- Supports one tracked object per HSRP group.
- VRRP and VRRPv3 support object tracking. For more information and configuration instructions, see [Configuring VRRP](#).

Default Settings

The following table lists the default settings for object tracking parameters.

Table 33: Default Object Tracking Parameters

Parameters	Default
Tracked object VRF	Member of default VRF

Configuring Object Tracking

For information on configuring IP SLA object tracking, see the [Cisco Nexus 9000 Series NX-OS IP SLAs Configuration Guide](#).

Configuring Object Tracking for an Interface

You can configure Cisco NX-OS to track the line protocol or IPv4 or IPv6 routing state of an interface.

SUMMARY STEPS

1. **configure terminal**
2. **track *object-id* interface *interface-type number* {ip routing | ipv6 routing | line-protocol}**
3. (Optional) **show track [*object-id*]**
4. (Optional) **copy running-config startup-config**

DETAILED STEPS

	Command or Action	Purpose
Step 1	configure terminal Example: <pre>switch# configure terminal switch(config)#</pre>	Enters global configuration mode.
Step 2	track <i>object-id</i> interface <i>interface-type number</i> {ip routing ipv6 routing line-protocol} Example: <pre>switch(config)# track 1 interface ethernet 1/2 line-protocol switch(config-track)#</pre>	Creates a tracked object for an interface and enters tracking configuration mode. The <i>object-id</i> range is from 1 to 512.
Step 3	(Optional) show track [<i>object-id</i>] Example: <pre>switch(config-track)# show track 1</pre>	Displays object tracking information.
Step 4	(Optional) copy running-config startup-config Example: <pre>switch(config-track)# copy running-config startup-config</pre>	Copies the running configuration to the startup configuration.

Example

This example shows how to configure object tracking for the line protocol state on Ethernet 1/2:

```
switch# configure terminal
switch(config)# track 1 interface ethernet 1/2 line-protocol
switch(config-track)# copy running-config startup-config
```

This example shows how to configure object tracking for the IPv4 routing state on Ethernet 1/2:

```
switch# configure terminal
switch(config)# track 2 interface ethernet 1/2 ip routing
switch(config-track)# copy running-config startup-config
```

This example shows how to configure object tracking for the IPv6 routing state on Ethernet 1/2:

```
switch# configure terminal
switch(config)# track 3 interface ethernet 1/2 ipv6 routing
switch(config-track)# copy running-config startup-config
```

Deleting a Tracking Object

SUMMARY STEPS

1. **configure terminal**
2. **no track *object-id***
3. (Optional) **copy running-config startup-config**

DETAILED STEPS

	Command or Action	Purpose
Step 1	configure terminal Example: <pre>switch# configure terminal switch(config)#</pre>	Enters global configuration mode.
Step 2	no track <i>object-id</i> Example: <pre>switch(config)# no track 1 switch(config-track)#</pre>	Deletes a tracked object for an interface. The <i>object-id</i> range is from 1 to 512.
Step 3	(Optional) copy running-config startup-config Example: <pre>switch(config-track)# copy running-config startup-config</pre>	Copies the running configuration to the startup configuration.

Example

This example shows how to delete a tracked object:

```
switch# configure terminal
switch(config)# no track 1
switch(config-track)# copy running-config startup-config
```

Configuring Object Tracking for Route Reachability

You can configure Cisco NX-OS to track the existence and reachability of an IP route or an IPv6 route.

SUMMARY STEPS

1. **configure terminal**
2. **track *object-id* {ip | ipv6} route *prefix/length* reachability**
3. (Optional) **show track [*object-id*]**
4. (Optional) **copy running-config startup-config**

DETAILED STEPS

	Command or Action	Purpose
Step 1	configure terminal Example: switch# configure terminal switch(config)#	Enters global configuration mode.
Step 2	track <i>object-id</i> {ip ipv6} route <i>prefix/length</i> reachability Example: switch(config)# track 3 ipv6 route 2::5/64 reachability switch(config-track)#	Creates a tracked object for a route and enters tracking configuration mode. The <i>object-id</i> range is from 1 to 512. The prefix format for IPv4 is A.B.C.D/length, where the length range is from 1 to 32. The prefix format for IPv6 is A:B::C:D/length, where the length range is from 1 to 128.
Step 3	(Optional) show track [<i>object-id</i>] Example: switch(config-track)# show track 1	Displays object tracking information.
Step 4	(Optional) copy running-config startup-config Example: switch(config-track)# copy running-config startup-config	Copies the running configuration to the startup configuration.

Example

This example shows how to configure object tracking for an IPv4 route in the default VRF:

```
switch# configure terminal
switch(config)# track 4 ip route 192.0.2.0/8 reachability
switch(config-track)# copy running-config startup-config
```

This example shows how to configure object tracking for an IPv6 route in the default VRF:

```
switch# configure terminal
switch(config)# track 5 ipv6 route 10::10/128 reachability
switch(config-track)# copy running-config startup-config
```

Configuring an Object Track List with a Boolean Expression

You can configure an object track list that contains multiple tracked objects. A tracked list contains one or more objects. The Boolean expression enables two types of calculation by using either "and" or "or" operators. For example, when tracking two interfaces using the "and" operator, up means that both interfaces are up, and down means that either interface is down.

SUMMARY STEPS

1. **configure terminal**
2. **track *track-number* list boolean {and | or}**
3. **object *object-number* [not]**
4. (Optional) **show track [*object-id*]**

5. (Optional) copy running-config startup-config

DETAILED STEPS

	Command or Action	Purpose
Step 1	configure terminal Example: <pre>switch# configure terminal switch(config)#</pre>	Enters global configuration mode.
Step 2	track track-number list boolean {and or} Example: <pre>switch(config)# track 1 list boolean and switch(config-track)#</pre>	<p>Configures a tracked list object and enters tracking configuration mode. Specifies that the state of the tracked list is based on a Boolean calculation. The keywords are as follows:</p> <ul style="list-style-type: none"> • and—Specifies that the list is up if all objects are up or down if one or more objects are down. For example, when tracking two interfaces, up means that both interfaces are up, and down means that either interface is down. • or—Specifies that the list is up if at least one object is up. For example, when tracking two interfaces, up means that either interface is up, and down means that both interfaces are down. <p>The <i>track-number</i> range is from 1 to 512.</p>
Step 3	object object-number [not] Example: <pre>switch(config-track)# object 10</pre>	<p>Adds a tracked object to the track list. The <i>object-id</i> range is from 1 to 512. The not keyword optionally negates the tracked object state.</p> <p>Note The example means that when object 10 is up, the tracked list detects object 10 as down.</p>
Step 4	(Optional) show track [object-id] Example: <pre>switch(config-track)# show track</pre>	Displays object tracking information.
Step 5	(Optional) copy running-config startup-config Example: <pre>switch(config-track)# copy running-config startup-config</pre>	Copies the running configuration to the startup configuration.

Example

This example shows how to configure a track list with multiple objects as a Boolean “and”:

```
switch# configure terminal
switch(config)# track 1 list boolean and
```

```
switch(config-track)# object 10
switch(config-track)# object 20 not
```

Configuring an Object Track List with a Percentage Threshold

You can configure an object track list that contains a percentage threshold. A tracked list contains one or more objects. The percentage of up objects must exceed the configured track list up percent threshold before the track list is in an up state. For example, if the tracked list has three objects and you configure an up threshold of 60 percent, two of the objects must be in the up state (66 percent of all objects) for the track list to be in the up state.

SUMMARY STEPS

1. **configure terminal**
2. **track *track-number* list threshold percentage**
3. **threshold percentage up *up-value* down *down-value***
4. **object *object-id***
5. (Optional) **show track [*object-id*]**
6. (Optional) **copy running-config startup-config**

DETAILED STEPS

	Command or Action	Purpose
Step 1	configure terminal Example: switch# configure terminal switch(config)#	Enters global configuration mode.
Step 2	track <i>track-number</i> list threshold percentage Example: switch(config)# track 1 list threshold percentage switch(config-track)#	Configures a tracked list object and enters tracking configuration mode. Specifies that the state of the tracked list is based on a configured threshold percent. The <i>track-number</i> range is from 1 to 512.
Step 3	threshold percentage up <i>up-value</i> down <i>down-value</i> Example: switch(config-track)# threshold percentage up 70 down 30	Configures the threshold percent for the tracked list. The range is from 0 to 100 percent.
Step 4	object <i>object-id</i> Example: switch(config-track)# object 10	Adds a tracked object to the track list. The <i>object-id</i> range is from 1 to 512.
Step 5	(Optional) show track [<i>object-id</i>] Example: switch(config-track)# show track	Displays object tracking information.

	Command or Action	Purpose
Step 6	(Optional) copy running-config startup-config Example: switch(config-track)# copy running-config startup-config	Copies the running configuration to the startup configuration.

Example

This example shows how to configure a track list with an up threshold of 70 percent and a down threshold of 30 percent:

```
switch# configure terminal
switch(config)# track 1 list threshold percentage
switch(config-track)# threshold percentage up 70 down 30
switch(config-track)# object 10
switch(config-track)# object 20
switch(config-track)# object 30
```

Configuring an Object Track List with a Weight Threshold

You can configure an object track list that contains a weight threshold. A tracked list contains one or more objects. The combined weight of up objects must exceed the configured track list up weight threshold before the track list is in an up state. For example, if the tracked list has three objects with the default weight of 10 each, and you configure an up threshold of 15, two of the objects must be in the up state (combined weight of 20) for the track list to be in the up state.

SUMMARY STEPS

1. **configure terminal**
2. **track *track-number* list threshold weight**
3. **threshold weight up *up-value* down *down-value***
4. **object *object-id* weight *value***
5. (Optional) **show track [*object-id*]**
6. (Optional) **copy running-config startup-config**

DETAILED STEPS

	Command or Action	Purpose
Step 1	configure terminal Example: switch# configure terminal switch(config)#	Enters global configuration mode.
Step 2	track <i>track-number</i> list threshold weight Example: switch(config)# track 1 list threshold weight switch(config-track)#	Configures a tracked list object and enters tracking configuration mode. Specifies that the state of the tracked list is based on a configured threshold weight. The <i>track-number</i> range is from 1 to 512.

	Command or Action	Purpose
Step 3	threshold weight up <i>up-value</i> down <i>down-value</i> Example: switch(config-track)# threshold weight up 30 down 10	Configures the threshold weight for the tracked list. The range is from 1 to 255.
Step 4	object <i>object-id</i> weight <i>value</i> Example: switch(config-track)# object 10 weight 15	Adds a tracked object to the track list. The <i>object-id</i> range is from 1 to 512. The <i>value</i> range is from 1 to 255. The default weight value is 10.
Step 5	(Optional) show track [<i>object-id</i>] Example: switch(config-track)# show track	Displays object tracking information.
Step 6	(Optional) copy running-config startup-config Example: switch(config-track)# copy running-config startup-config	Copies the running configuration to the startup configuration.

Example

This example shows how to configure a track list with an up weight threshold of 30 and a down threshold of 10:

```
switch# configure terminal
switch(config)# track 1 list threshold weight
switch(config-track)# threshold weight up 30 down 10
switch(config-track)# object 10 weight 15
switch(config-track)# object 20 weight 15
switch(config-track)# object 30
```

In this example, the track list is up if object 10 and object 20 are up, and the track list goes to the down state if all three objects are down.

Configuring an Object Tracking Delay

You can configure a delay for a tracked object or an object track list that delays when the object or list triggers a state change. The tracked object or track list starts the delay timer when a state change occurs but does not recognize a state change until the delay timer expires. At that point, Cisco NX-OS checks the object state again and records a state change only if the object or list currently has a changed state. Object tracking ignores any intermediate state changes before the delay timer expires.

For example, for an interface line-protocol tracked object that is in the up state with a 20-second down delay, the delay timer starts when the line protocol goes down. The object is not in the down state unless the line protocol is down 20 seconds later.

You can configure independent up delay and down delay for a tracked object or track list. When you delete the delay, object tracking deletes both the up and down delay.

You can change the delay at any point. If the object or list is already counting down the delay timer from a triggered event, the new delay is computed as follows:

- If the new configuration value is less than the old configuration value, the timer starts with the new value.
- If the new configuration value is more than the old configuration value, the timer is calculated as the new configuration value minus the current timer countdown minus the old configuration value.

SUMMARY STEPS

1. **configure terminal**
2. **track** *object-id* {*parameters*}
3. **track** *track-number list* {*parameters*}
4. **delay** {**up** *up-time* [**down** *down-time*] | **down** *down-time* [**up** *up-time*]}
5. (Optional) **show track** [*object-id*]
6. (Optional) **copy running-config startup-config**

DETAILED STEPS

	Command or Action	Purpose
Step 1	configure terminal Example: switch# configure terminal switch(config)#	Enters global configuration mode.
Step 2	track <i>object-id</i> { <i>parameters</i> }	Creates a tracked object for a route and enters tracking configuration mode. The <i>object-id</i> range is from 1 to 512. The prefix format for IPv4 is A.B.C.D/length, where the length range is from 1 to 32. The prefix format for IPv6 is A::B::C:D/length, where the length range is from 1 to 128.
Step 3	track <i>track-number list</i> { <i>parameters</i> }	Configures a tracked list object and enters tracking configuration mode. Specifies that the state of the tracked list is based on a configured threshold weight. The <i>track-number</i> range is from 1 to 512.
Step 4	delay { up <i>up-time</i> [down <i>down-time</i>] down <i>down-time</i> [up <i>up-time</i>]}	Configures the object delay timers. The range is from 0 to 180 seconds. The <i>track-number</i> range is from 1 to 512.
Step 5	(Optional) show track [<i>object-id</i>] Example: switch(config-track)# show track 3	Displays object tracking information.
Step 6	(Optional) copy running-config startup-config Example: switch(config-track)# copy running-config startup-config	Copies the running configuration to the startup configuration.

Example

This example shows how to configure object tracking for a route and use delay timers:

```
switch# configure terminal
switch(config)# track 2 ip route 209.165.201.0/8 reachability
switch(config-track)# delay up 20 down 30
switch(config-track)# copy running-config startup-config
```

This example shows how to configure a track list with an up weight threshold of 30 and a down threshold of 10 with delay timers:

```
switch# configure terminal
switch(config)# track 1 list threshold weight
switch(config-track)# threshold weight up 30 down 10
switch(config-track)# object 10 weight 15
switch(config-track)# object 20 weight 15
switch(config-track)# object 30
switch(config-track)# delay up 20 down 30
```

This example shows the delay timer in the show track command output before and after an interface is shut down:

```
switch(config-track)# show track
Track 1
Interface loopback1 Line Protocol
Line Protocol is UP
1 changes, last change 00:00:13
Delay down 10 secs
switch(config-track)# interface loopback 1
switch(config-if)# shutdown
switch(config-if)# show track
Track 1
Interface loopback1 Line Protocol
Line Protocol is delayed DOWN (8 secs remaining) <----- delay timer counting down
1 changes, last change 00:00:22
Delay down 10 secs
```

Configuring Object Tracking for a Nondefault VRF

You can configure Cisco NX-OS to track an object in a specific VRF.

Before you begin

Ensure that nondefault VRFs are created first.

SUMMARY STEPS

1. **configure terminal**
2. **track *object-id* {ip | ipv6} route *prefix/length* reachability**
3. **vrf member *vrf-name***
4. (Optional) **show track [*object-id*]**
5. (Optional) **copy running-config startup-config**

DETAILED STEPS

	Command or Action	Purpose
Step 1	configure terminal Example: switch# configure terminal switch(config)#	Enters global configuration mode.
Step 2	track object-id {ip ipv6} route prefix/length reachability Example: switch(config)# track 3 ipv6 route 1::2/64 reachability switch(config-track)#	Creates a tracked object for a route and enters tracking configuration mode. The <i>object-id</i> range is from 1 to 512. The prefix format for IPv4 is A.B.C.D/length, where the length range is from 1 to 32. The prefix format for IPv6 is A:B::C:D/length, where the length range is from 1 to 128.
Step 3	vrf member vrf-name Example: switch(config-track)# vrf member Red	Configures the VRF to use for tracking the configured object.
Step 4	(Optional) show track [object-id] Example: switch(config-track)# show track 3	Displays object tracking information.
Step 5	(Optional) copy running-config startup-config Example: switch(config-track)# copy running-config startup-config	Copies the running configuration to the startup configuration.

Example

This example shows how to configure object tracking for a route and use VRF Red to look up reachability information for this object:

```
switch# configure terminal
switch(config)# track 2 ip route 209.165.201.0/8 reachability
switch(config-track)# vrf member Red
switch(config-track)# copy running-config startup-config
```

This example shows how to configure object tracking for an IPv6 route and use VRF Red to look up reachability information for this object:

```
switch# configure terminal
switch(config)# track 3 ipv6 route 1::2/64 reachability
switch(config-track)# vrf member Red
switch(config-track)# copy running-config startup-config
```

This example shows how to modify tracked object 2 to use VRF Blue instead of VRF Red to look up reachability information for this object:

```
switch# configure terminal
switch(config)# track 2
switch(config-track)# vrf member Blue
switch(config-track)# copy running-config startup-config
```

Verifying the Object Tracking Configuration

To display object tracking configuration information, perform one of the following tasks:

Command	Purpose
<code>show track [object-id] [brief]</code>	Displays the object tracking information for one or more objects.
<code>show track [object-id] interface [brief]</code>	Displays the interface-based object tracking information.
<code>show track [object-id] {ip ipv6} route [brief]</code>	Displays the IPv4 or IPv6 route-based object tracking information.

Configuration Examples for Object Tracking

This example shows how to configure object tracking for route reachability and use VRF Red to look up reachability information for this route:

```
switch# configure terminal
switch(config)# track 2 ip route 209.165.201.0/8 reachability
switch(config-track)# vrf member Red
switch(config-track)# copy running-config startup-config
```

Related Topics

See the following topics for information related to object tracking:

- [Configuring Layer 3 Virtualization](#)
- [Configuring HSRP](#)

Additional References

For additional information related to implementing object tracking, see the following sections:

- [Related Documents](#)

Related Documents

Related Topic	Document Title
Configuring the Embedded Event Manager	Cisco Nexus 9000 Series NX-OS System Management Configuration Guide

Related Topic	Document Title
Configuring IP SLA Object Tracking	Cisco Nexus 9000 Series NX-OS IP SLAs Configuration Guide



APPENDIX **A**

IETF RFCs Supported by Cisco NX-OS Unicast Features

This appendix lists the IETF RFCs for unicast routing supported in Cisco NX-OS.

- [BGP RFCs, on page 641](#)
- [First-Hop Redundancy Protocols RFCs, on page 642](#)
- [IP Services RFCs, on page 643](#)
- [IPv6 RFCs, on page 643](#)
- [IS-IS RFCs, on page 644](#)
- [OSPF RFCs, on page 644](#)
- [RIP RFCs, on page 645](#)

BGP RFCs

RFCs	Title
RFC 1997	<i>BGP Communities Attribute</i>
RFC 2385	<i>Protection of BGP Sessions via the TCP MD5 Signature Option</i>
RFC 2439	<i>BGP Route Flap Damping</i>
RFC 2519	<i>A Framework for Inter-Domain Route Aggregation</i>
RFC 2545	<i>Use of BGP-4 Multiprotocol Extensions for IPv6 Inter-Domain Routing</i>
RFC 2858	<i>Multiprotocol Extensions for BGP-4</i>
RFC 2918	<i>Route Refresh Capability for BGP-4</i>
RFC 3065	<i>Autonomous System Confederations for BGP</i>
RFC 3392	<i>Capabilities Advertisement with BGP-4</i>
RFC 4271	<i>A Border Gateway Protocol 4 (BGP-4)</i>
RFC 4273	<i>Definitions of Managed Objects for BGP-4</i>

RFCs	Title
RFC 4456	<i>BGP Route Reflection: An Alternative to Full Mesh Internal BGP (IBGP)</i>
RFC 4486	<i>Subcodes for BGP Cease Notification Message</i>
RFC 4724	<i>Graceful Restart Mechanism for BGP</i>
RFC 4760	<i>Multiprotocol Extensions for BGP-4</i>
RFC 4781	<i>Graceful Restart Mechanism for BGP with MPLS</i>
RFC 4893	<i>BGP Support for Four-octet AS Number Space</i>
RFC 5004	<i>Avoid BGP Best Path Transitions from One External to Another</i>
RFC 5396 ¹	<i>Textual Representation of Autonomous System (AS) Numbers</i>
RFC 5549	<i>Advertising IPv4 Network Layer Reachability Information with an IPv6 Next Hop</i>
RFC 5668	<i>4-Octet AS Specific BGP Extended Community</i>
RFC 7606	<i>Revised Error Handling for BGP Update Messages</i>
RFC 7854	<i>BGP Monitoring Protocol (BMP)</i>
draft-ietf-idr-add-paths-08.txt	<i>Advertisement of Multiple Paths in BGP</i>
draft-ietf-idr-bgp4-mib-15.txt	<i>BGP4-MIB</i>
draft-kato-bgp-ipv6-link-local-00.txt	<i>BGP4+ Peering Using IPv6 Link-local Address</i>
draft-ietf-idr-avoid-transition-05.txt	<i>Bestpath Transition Avoidance</i>
draft-ietf-idr-bgp4-mib-15.txt	<i>Peer Table Objects</i>
draft-ietf-idr-dynamic-cap-03.txt	<i>Dynamic Capability</i>

¹ RFC 5396 is partially supported. The asplain and asdot notations are supported, but the asdot+ notation is not.

First-Hop Redundancy Protocols RFCs

RFCs	Title
RFC 2281	<i>Hot Standby Redundancy Protocol</i>
RFC 3768	<i>Virtual Router Redundancy Protocol</i>
RFC 5798	<i>Virtual Router Redundancy Protocol (VRRP) Version 3 for IPv4 and IPv6</i>

IP Services RFCs

RFCs	Title
RFC 768	<i>UDP</i>
RFC 791	<i>IP</i>
RFC 792	<i>ICMP</i>
RFC 793	<i>TCP</i>
RFC 826	<i>ARP</i>
RFC 1027	<i>Proxy ARP</i>
RFC 1591	<i>DNS Client</i>
RFC 1812	<i>IPv4 routers</i>
RFC 4022	<i>TCP-MIB</i>
RFC 4292	<i>IP-FORWARDING-TABLE-MIB</i>
RFC 4293	<i>IP-MIB</i>

IPv6 RFCs

RFCs	Title
RFC 1981	Path MTU Discovery for IP version 6
RFC 2374	An Aggregatable Global Unicast Address Format
RFC 2460	Internet Protocol, Version 6 (IPv6) Specification
RFC 2464	Transmission of IPv6 Packets over Ethernet Networks
RFC 3021	Using 31-Bit Prefixes on IPv4 Point-to-Point Links
RFC 4191	Default Router preferences and more specific routes
RFC 4193	Unique Local IPv6 Unicast Addresses Note RFC 4193 is partially supported. Section 3.2.2 is not supported.
RFC 4291 (replaced RFC 2373)	IP Version 6 Addressing Architecture
RFC 4443 (replaced RFC 2463)	ICMPv6

RFCs	Title
RFC 4861 (replaced RFC 2461)	Neighbor Discovery for IP Version 6 (IPv6)
RFC 4862 (replaced RFC 2462)	IPv6 Stateless Address Autoconfiguration
RFC 6106	IPv6 Router Advertisement Options for DNS Configuration
RFC 2526	Reserved IPv6 Subnet Anycast Addresses

IS-IS RFCs

RFCs	Title
RFC 1142	<i>OSI 10589 intermediate system to intermediate system intro-domain routing exchange protocol</i>
RFC 1195	<i>Use of OSI IS-IS for routing in TCP/IP and dual environment</i>
RFC 2763, RFC 5301	<i>Dynamic Hostname Exchange Mechanism for IS-IS</i>
RFC 2966, RFC 5302	<i>Domain-wide Prefix Distribution with Two-Level IS-IS</i>
RFC 2972	<i>IS-IS Mesh Groups</i>
RFC 3277	<i>IS-IS Transient Blackhole Avoidance</i>
RFC 3373, RFC 5303	<i>Three-Way Handshake for IS-IS Point-to-Point Adjacencies</i>
RFC 3567, RFC 5304	<i>IS-IS Cryptographic Authentication</i>
RFC 3784, RFC 5305	<i>IS-IS Extensions for Traffic Engineering</i>
RFC 3847, RFC 5306	<i>Restart Signaling for IS-IS</i>
RFC 4205, RFC 5307	<i>IS-IS Extensions in Support of Generalized Multi-Protocol Label Switching</i>
draft-ietf-isis-igp-p2p-over-lan-06.txt	<i>Internet Draft Point-to-point operation over LAN in link-state routing protocols</i>

OSPF RFCs

RFCs	Title
RFC 2328	<i>OSPF Version 2</i>
RFC 2370	<i>The OSPF Opaque LSA Option</i>
RFC 2740	<i>OSPF for IPv6</i>

RFCs	Title
RFC 3101	<i>The OSPF Not-So-Stubby Area (NSSA) Option</i>
RFC 3137	<i>OSPF Stub Router Advertisement</i>
RFC 3623	<i>Graceful OSPF Restart</i>
RFC 5709	<i>OSPFv2 HMAC-SHA Cryptographic Authentication</i>
draft-ietf-ospf-ospfv3-graceful-restart-04.txt	<i>OSPFv3 Graceful Restart</i>

RIP RFCs

RFCs	Title
RFC 2082	<i>RIP-2 MD5 Authentication</i>
RFC 2453	<i>RIP Version 2</i>



APPENDIX **B**

Configuration Limits for Cisco NX-OS Layer 3 Unicast Features

- [Configuration Limits for Cisco NX-OS Layer 3 Unicast Features, on page 647](#)

Configuration Limits for Cisco NX-OS Layer 3 Unicast Features

The configuration limits are documented in the [Cisco Nexus 9000 Series NX-OS Verified Scalability Guide](#).



INDEX

{ip | ipv6} [526–527](#)
{ip | ipv6} address [273–274](#)
{ip | ipv6} bandwidth eigrp [236, 238](#)
{ip | ipv6} bandwidth-percent eigrp [236, 238](#)
{ip | ipv6} delay eigrp [236, 238](#)
{ip | ipv6} distribute-list eigrp [236, 238](#)
{ip | ipv6} hello-interval eigrp [235](#)
{ip | ipv6} hold-time eigrp [235](#)
{ip | ipv6} next-hop-self eigrp [236, 238](#)
{ip | ipv6} passive-interface eigrp [236, 239](#)
{ip | ipv6} prefix-list [527](#)
{ip | ipv6} router eigrp [239–240](#)
{ip | ipv6} router isis [256–257, 273–274](#)
{ip | ipv6} split-horizon eigrp [235](#)

A

additional-paths receive [353–354](#)
additional-paths selection route-map [355–356](#)
additional-paths send [353–354](#)
address [602–603, 613, 615, 617–618](#)
address-family [224–225, 228, 364–365](#)
address-family {ipv4 | ipv6} {unicast | multicast} [396–397](#)
address-family {ipv4 | ipv6} {unicast | multicast} [362–363, 372, 374](#)
address-family {ipv4 | ipv6} unicast [232–233, 263–265, 386–387](#)
address-family {ipv4|ipv6} {multicast|unicast} [337–340, 343](#)
address-family {ipv4|ipv6} {unicast|multicast} [299, 301–302](#)
address-family ipv4 unicast [270, 433–434, 439, 442–443](#)
address-family ipv6 unicast [169–171, 173–174, 179–184, 187–188, 270–271, 453, 458–459](#)
adjacency-check [275–276](#)
administrative distance [463](#)
advertise-active-only [337–338](#)
advertise-map [372](#)
advertisement interval [607](#)
aggregate-address [330](#)
allows in [393](#)
area [115, 119–124, 126–127, 132–133, 169–174, 176–177, 182–183](#)
as-override [394](#)
authentication [126–127](#)
authentication key-chain [224–225, 258–259](#)
authentication mode md5 [224–225](#)
authentication text [605–606](#)
authentication-check {level-1 | level-2} [258–259](#)
authentication-key [126–127](#)

authentication-type {cleartext | md5} {level-1 | level-2} [258–259](#)
autonomous-system [220, 232](#)

B

bgp confederation peers [361](#)

C

capability additional-paths receive [353](#)
capability additional-paths send [352–353](#)
clear [513](#)
clear bgp [308](#)
clear bgp {ipv4 | ipv6} {unicast | multicast} [348](#)
clear bgp {ipv4 | ipv6} {unicast | multicast} flap-statistics [vrf] [308](#)
clear bgp all [308](#)
clear bgp all dampening [308](#)
clear bgp all flap-statistics [308](#)
clear bgp dampening [310](#)
clear bgp flap-statistics [310](#)
clear forwarding [511](#)
clear ip eigrp redistribution [231](#)
clear ip mbgp [310](#)
clear ip mbgp dampening [311](#)
clear ip mbgp flap-statistics [311](#)
clear ip rip statistics [446](#)
clear ip rip statistics [461](#)
clear isis [253, 255](#)
clear rip policy statistics redistribute [446](#)
clear routing [513](#)
clear vrrpv3 statistics [620](#)
client-to-client reflection [362–363](#)
cluster-id [362](#)
confederation identifier [361](#)
configuration examples [461](#)
 RIPng [461](#)
configuring RIPng [455](#)
 on an interface [455](#)
continue [537](#)
creating [453](#)
 RIPng instance [453](#)

D

dampening [366](#)
 dead-interval [126–127, 176–177](#)
 default settings [452](#)
 RIPng [452](#)
 default-information originate [129–130, 179, 236, 265, 386–387, 439–440](#)
 default-metric [129–130, 179–180, 228–229, 374, 439–440](#)
 default-originate [393](#)
 delay [635](#)
 delay restore [162](#)
 description [301–302, 335–336, 392, 613](#)
 disable-connected-check [303, 356](#)
 disable-peer-as-check [393](#)
 disable-policy-batching [352](#)
 distance [111, 165–166, 236–237, 253–254, 392, 433–434, 453–454](#)
 distribute {level-1 | level-2} into {level-1 | level-2} [265–266](#)
 distribute-list [241](#)
 dont-capability-negotiate [352](#)
 dscp [369](#)
 dynamic routing protocols [10](#)

E

ebgp-multihop [303, 359](#)
 enforce-first-as [390](#)
 enhanced-error [389](#)
 Equal Cost Multiple Paths (ECMP) [450](#)

F

feature bgp [298](#)
 feature eigrp [219](#)
 feature hsrp [576](#)
 feature interface vlan [467](#)
 feature isis [252–253](#)
 feature ospf [108](#)
 feature ospfv3 [163–164](#)
 feature pbr [553–556, 560–561](#)
 feature rip [433, 452](#)
 feature vrrp [602](#)
 feature vrrpv3 [612](#)
 filter-list [394](#)
 flush-routes [222](#)

G

gateway protocols [10](#)
 graceful restart [271–272](#)
 graceful-restart [140–141, 189–190, 233–234, 420](#)
 graceful-restart grace-period [140–141, 189–190](#)
 graceful-restart helper-disable [140–141, 189–190](#)
 graceful-restart planned-only [140–141, 189–190](#)
 graceful-restart t3 manual [271–272](#)
 graceful-restart-helper [420–421](#)

guidelines [451](#)
 RIPng [451](#)

H

hardware ip glean throttle [45](#)
 hardware ip glean throttle maximum [45–46](#)
 hardware ip glean throttle maximum timeout [46](#)
 hello-interval [126–127, 176–177](#)
 high availability [451](#)
 RIPng [451](#)
 hostname dynamic [261–262](#)
 hsrp [577–580, 582–584](#)
 hsrp timers extended-hold [589](#)
 hsrp version {1 | 2} [577](#)
 hsrp version 2 [579–580](#)

I

inherit peer [339, 341, 343](#)
 inherit peer-policy [337–340](#)
 inherit peer-session [335–336, 339–340](#)
 interface [224–225, 455](#)
 configuring RIPng [455](#)
 interface ethernet [27–28](#)
 interface-vlan [467](#)
 ip [217, 577–580](#)
 ip | ipv6} offset-list eigrp [236, 238](#)
 ip address [27–28, 112–113, 142–143, 442–443, 467, 479–481, 615, 617–618](#)
 ip arp address [37](#)
 ip arp gratuitous {request | update} [41](#)
 ip as-path access-list [529–530](#)
 ip authentication key-chain eigrp [224–225](#)
 ip authentication mode eigrp [224–225](#)
 ip autoconfig [579–580](#)
 ip community-list expanded [534](#)
 ip community-list standard [534](#)
 ip directed-broadcast [44](#)
 ip domain-list [93–96, 482](#)
 ip domain-lookup [93–94](#)
 ip domain-name [93–95](#)
 ip extcommunity-list expanded [535–536](#)
 ip extcommunity-list standard [535–536](#)
 ip host [93](#)
 ip name-server [93–96](#)
 ip ospf authentication [116–117](#)
 ip ospf authentication key-chain [116–117](#)
 ip ospf authentication-key [115–117](#)
 ip ospf cost [112–113](#)
 ip ospf dead-interval [112, 114, 138–139](#)
 ip ospf hello-interval [113–114, 138–139](#)
 ip ospf message-digest-key [115–117](#)
 ip ospf mtu-ignore [113–114](#)
 ip ospf passive-interface [113–114](#)

- ip ospf retransmit-interval [138–139](#)
- ip ospf transmit-delay [138–139](#)
- ip passive-interface eigrp [223](#)
- ip proxy arp [38](#)
- ip rip authentication keychain [436–437](#)
- ip rip authentication mode [436–437](#)
- ip rip metric-offset [445](#)
- ip rip passive-interface [437–438](#)
- ip rip poison-reverse [438](#)
- ip rip route-filter [445](#)
- ip rip summary-address [438](#)
- ip route [386, 465–469, 477–478](#)
- ip router eigrp [220–221, 224–225](#)
- ip router ospf [112–113, 142–143, 480–481](#)
- ip router rip [435, 442–443](#)
- ip source [47](#)
- ip summary-address eigrp [227](#)
- ip tcp path-mtu-discovery [43–44](#)
- IPv4 [49](#)
 - related documents [49](#)
- ipv6 [217](#)
- ipv6 address [71–72, 167, 191–192, 458–459, 579](#)
- ipv6 address use-link-local-only [72](#)
- ipv6 authentication key-chain eigrp [224–225](#)
- ipv6 authentication mode eigrp [224–225](#)
- ipv6 ospfv3 [191–192](#)
- ipv6 passive-interface eigrp [223](#)
- ipv6 rip poison-reverse [456](#)
- ipv6 rip route-filter [461](#)
- ipv6 route [465–466, 468–469](#)
- ipv6 router eigrp [220–221, 224–225](#)
- ipv6 router ospfv3 [167, 175](#)
- ipv6 router rip [455, 458–459](#)
- ipv6 summary-address eigrp [227](#)
- isis-type {level-1 | level-2 | level-1-2} [253–254](#)
- isis authentication key-chain [259–260](#)
- isis authentication-check {level-1 | level-2} [259–260](#)
- isis authentication-type {cleartext | md5} {level-1 | level-2} [259–260](#)
- isis circuit-type {level-1 | level-2 | level-1-2} [256–257](#)
- isis csnp-interval [275–276](#)
- isis hello-interval [275–276](#)
- isis hello-multiplier [275–276](#)
- isis hello-padding [263](#)
- isis lsp-interval [275, 277](#)
- isis mesh-group [261](#)
- isis metric [256–257](#)
- isis passive {level-1 | level-2 | level-1-2} [256–257](#)
- isis priority [261](#)
- isis shutdown [258](#)

K

- key [115–116](#)

L

- limitations [451](#)
 - RIPng [451](#)
- link-state protocols [10](#)
- load balancing [450](#)
- local-as [360–361](#)
- log-adjacency-changes [111, 165–166, 220–221, 253–254](#)
- log-neighbor-changes [391–392](#)
- log-neighbor-warnings [220–221](#)
- low-memory exempt [392](#)
- lsp-gen-interval [275](#)
- lsp-mtu [253–254](#)

M

- mac address [617–618](#)
- mac-address [581](#)
- match ip address prefix-list [135–136](#)
- match ip route-source [162](#)
- match ip route-source prefix-list [135–136, 162, 184–185](#)
- match ipv6 address [162](#)
- match ipv6 address prefix-list [162, 184–185](#)
- match ipv6 route-source [162](#)
- match route-type [135–136, 162, 184–185](#)
- match-address [613](#)
- max-lsp-lifetime [275–276](#)
- max-metric router-lsa [134](#)
- maxas-limit [360](#)
- maximum routes [512](#)
- maximum-paths [111, 142–143, 165–166, 191–192, 232, 253–254, 367, 433–434, 453–454, 480](#)
- maximum-peers [342](#)
- maximum-prefix [337–338](#)
- medium {broadcast | p2p} [256–257](#)
- message-digest-key [126, 128](#)
- metric direct 0 [441, 456–457](#)
- metric max-hops [236–237](#)
- metric weights [236–237](#)
- metric-style transition [275–276](#)
- metrics rib-scale [236](#)
- metrics version 64bit [236](#)

N

- name [586](#)
- neighbor [303–304, 335, 337–340, 343, 362–365, 372, 396–397, 422–423](#)
- neighbor-down fib-accelerate [351](#)
- net [253–254, 273–274](#)
- network [299](#)
- next-hop-self [348–349, 364](#)
- next-hop-third-party [349](#)
- nexthop route-map [350](#)
- nexthop suppress-default-resolution [350](#)
- no {ip | ipv6} route [466](#)

no adjacency-check [270–271](#)
 no adjacency-checkg [270](#)
 no fast-external-fallover [360](#)
 no preempt [608](#)
 no shutdown [577–580, 602–610](#)
 no track [629](#)
 nsf await-redis-proto-convergence [236–237](#)

O

object [630–634](#)
 ospfv3 cost [167–168](#)
 ospfv3 dead-interval [167–168](#)
 ospfv3 hello-interval [167–168](#)
 ospfv3 instance [167–168](#)
 ospfv3 mtu-ignore [167–168](#)
 ospfv3 network [167–168](#)
 ospfv3 passive-interface [167–168](#)
 ospfv3 priority [167–168](#)
 ospfv3 retransmit-interval [187–188](#)
 ospfv3 transmit-delay [187–188](#)

P

packet switching [4](#)
 passive-interface default [111–112, 165–166](#)
 password [334–335](#)
 path-attribute discard [388](#)
 path-attribute treat-as-withdraw [388](#)
 preempt [583, 585–586, 613–614](#)
 prefix-list [394](#)
 priority [583–584, 586, 604, 613–614](#)

R

redistribute [129, 179, 228, 230, 265, 267, 439, 442–443](#)
 redistribute {direct | {eigrp | isis | ospf | ospfv3 | rip}} [374](#)
 redistribute bgp [180–181](#)
 redistribute maximum-prefix [181, 230, 267](#)
 redistribute static route-map allow [386–387](#)
 reference-bandwidth [253, 255](#)
 related documents [49](#)
 IPv4 [49](#)
 reload [29–33, 74–77, 307](#)
 reload module [104, 160, 250](#)
 remove-private-as [330, 393](#)
 restart bgp [300](#)
 restart eigrp [222](#)
 restart isis [250, 255](#)
 restart ospf [104, 142](#)
 restart ospfv3 [160, 191](#)
 restart rip [435, 454](#)
 retransmit-interval [126, 128, 176–177](#)
 RIPng [449, 451–452, 460–461](#)
 configuration examples [461](#)

RIPng (*continued*)
 default settings [452](#)
 described [449](#)
 enabling [452](#)
 guidelines [451](#)
 high availability [451](#)
 limitations [451](#)
 tuning [460](#)
 verifying [461](#)
 virtualization support [451](#)
 RIPng instance [453–454](#)
 creating [453](#)
 restarting [454](#)
 RIPng statistics [461](#)
 displaying [461](#)
 route filtering [430, 450](#)
 route redistribution [431](#)
 route summarization [430](#)
 route-map [135–136, 184–185, 364–365, 531–532, 537](#)
 route-map allow permit [386](#)
 route-reflector-client [362–365](#)
 router bgp [298–299, 301, 303–304, 334–335, 337, 339–340, 343, 362, 364–365, 372, 374, 386, 396, 420, 422](#)
 router eigrp [220, 224, 228, 230–233, 239–240](#)
 router isis [253–254, 258, 263–265, 267, 270–273](#)
 router ospf [115, 119–121, 123, 126–127, 129, 132–135, 138, 140–143, 480](#)
 router ospfv3 [165, 169–171, 173, 176–177, 179–182, 184, 187, 189, 191–192](#)
 router rip [433–434, 439, 441–443, 453, 456–458](#)
 router-id [165, 298–299, 391](#)
 routing-context vrf [483](#)
 routing-context vrf default [483](#)

S

send-community [394](#)
 send-community extended [394](#)
 set distance [135–136, 184, 186](#)
 set ip next-hop peer-address [364](#)
 set ipv6 next-hop peer-address [364](#)
 set next-hop [364](#)
 set-attached-bit [262–263](#)
 set-overload-bit {always | on-startup} [262](#)
 show [471, 483, 509](#)
 show {ip | ipv6} [220–221, 468–469, 527, 529–530](#)
 show {ip | ipv6} adjacency [514](#)
 show {ip | ipv6} eigrp [240–241](#)
 show {ip | ipv6} eigrp route-map statistics redistribute [228–229](#)
 show {ip | ipv6} route [509, 514](#)
 show {ip | ipv6} routing [509](#)
 show {ip | ipv6} static-route [465–466, 469](#)
 show {ip | ipv6} static-route track-table [469](#)
 show {ipv4 | ipv6} bgp [313](#)
 show {ip | ipv6} mbgp [313](#)
 show {ipv4 | ipv6} bgp [425](#)
 show {ipv4 | ipv6} mbgp [425](#)

- show bgp [423](#)
- show bgp {ipv4 | ipv6 | vpnv4 | vpnv6} {unicast | multicast} [424](#)
- show bgp {ipv4 | ipv6} {unicast | multicast} [311, 313, 364–365, 423–425](#)
- show bgp {ipv4 | ipv6} {unicast | multicast} neighbors [362–363](#)
- show bgp {ipv4 | ipv6} unicast [354–356, 389](#)
- show bgp {ipv4 | ipv6} unicast injected-routes [425](#)
- show bgp {ipv4 | ipv6} unicast path-attribute discard [389](#)
- show bgp {ipv4 | ipv6} unicast path-attribute unknown [389](#)
- show bgp {ipv4|ipv6} {unicast|multicast} neighbors [301–304](#)
- show bgp {ipv4|ipv6} unicast neighbors [344, 425](#)
- show bgp all [299, 311, 423](#)
- show bgp convergence [311, 423](#)
- show bgp ipv4 multicast neighbors [372–373](#)
- show bgp ipv4 unicast neighbors [342, 372–373](#)
- show bgp ipv6 multicast neighbors [372–373](#)
- show bgp ipv6 unicast neighbors [372–373](#)
- show bgp neighbor [336–338, 341, 353–354](#)
- show bgp paths [312](#)
- show bgp peer-policy [313, 337–338, 424](#)
- show bgp peer-session [313, 335–336, 424](#)
- show bgp peer-template [313, 339, 341, 424](#)
- show bgp process [313, 425](#)
- show bgp sessions [313, 425](#)
- show bgp statistics [313, 425](#)
- show bgp vrf [311](#)
- show consistency-checker [510–511](#)
- show feature [108, 164, 219, 252–253, 298, 433, 452–453, 553–555](#)
- show fhrp [613–616, 619](#)
- show forwarding [510–511](#)
- show forwarding {ip | ipv4 | ipv6} route [514](#)
- show forwarding {ipv4 | ipv6} adjacency module [495](#)
- show forwarding {ipv4 | ipv6} route module [495](#)
- show forwarding adjacency [514](#)
- show forwarding distribution {clients | fib-state} [514](#)
- show forwarding interfaces module [514](#)
- show forwarding route summary [29–33, 73–77](#)
- show hosts [93–97](#)
- show hsrp [577–580, 582, 589](#)
- show hsrp delay interface [589](#)
- show hsrp group [589–590](#)
- show hsrp interface [583, 585, 589](#)
- show interface [619](#)
- show ip adjacency [48](#)
- show ip adjacency summary [48](#)
- show ip arp [48](#)
- show ip arp statistics [48](#)
- show ip arp summary [48](#)
- show ip bgp neighbors [344, 425](#)
- show ip community list [534](#)
- show ip community-list [535–536, 545](#)
- show ip eigrp neighbor detail [226](#)
- show ip ext community-list [545](#)
- show ip interface [28, 48](#)
- show ip load-sharing [496–497](#)
- show ip ospf [112–113, 115–117, 121, 123–124, 138–141](#)
- show ip ospf interface [114](#)
- show ip ospf neighbor [114](#)
- show ip ospf policy statistics area [119–120, 145](#)
- show ip ospf statistics [145](#)
- show ip ospf summary-address [132–133](#)
- show ip ospf traffic [145](#)
- show ip ospf virtual-link [126–127](#)
- show ip policy statistics redistribute [145](#)
- show ip rip [433–436, 442, 444, 446, 453–454](#)
- show ip rip instance [445](#)
- show ip rip route [439–440](#)
- show ip route [467](#)
- show ipv6 adjacency [89](#)
- show ipv6 interface [71–72, 89](#)
- show ipv6 ospfv3 [165, 167, 175, 189–190](#)
- show ipv6 ospfv3 memory [206](#)
- show ipv6 ospfv3 policy statistics area [169–170, 206](#)
- show ipv6 ospfv3 policy statistics redistribute [206](#)
- show ipv6 ospfv3 statistics [206](#)
- show ipv6 ospfv3 summary-address [182–183](#)
- show ipv6 ospfv3 traffic [206](#)
- show ipv6 ospfv3 virtual-link [176–177](#)
- show ipv6 rip [455, 458–459, 461](#)
- show ipv6 rip instance [461](#)
- show ipv6 routers interface [344, 425](#)
- show ipv6 static-route vrf [469](#)
- show isis [253–254, 256–257, 263–266, 273–274, 277–278](#)
- show platform fib [13](#)
- show platform forwarding [13](#)
- show policy [562](#)
- show prefix-list [545](#)
- show route-map [545, 562](#)
- show route-map brief [545](#)
- show routing [513–514](#)
- show routing hash [496–497](#)
- show running-config bgp [420–421](#)
- show running-config eigrp [230–231](#)
- show running-config isis [267–268, 270–272](#)
- show running-config ospfv3 [181](#)
- show running-config rip [441, 456–457](#)
- show running-configuration bgp [313, 425](#)
- show running-configuration eigrp [241](#)
- show running-configuration isis [278](#)
- show running-configuration rip [446, 461](#)
- show tech-support isis [278](#)
- show track [628–638](#)
- show vrf [477–479, 484](#)
- show vrrp [602–610, 619](#)
- show vrrp statistics [619](#)
- show vrrpv3 [613–616](#)
- show vrrpv3 statistics [620](#)
- show vrrs pathway [618](#)
- shutdown [223, 256, 300–302, 604–610, 613–616](#)
- snmp-server host [482](#)
- soft-reconfiguration inbound [348](#)
- spf-interval [level-1 | level-2] [275–276](#)

split horizon [450](#)
 split horizon with poison reverse [456](#)
 configuring [456](#)
 static routes [10](#)
 stub [226](#)
 stub routing [8](#)
 summary-address [132–133, 182–183, 263–264](#)
 suppress-fib-pending [330, 371](#)
 suppress-inactive [394](#)
 system pic enable [307](#)
 system pic-core [307](#)
 system routing max-mode host [29, 73–74](#)
 system routing max-mode l3 [32–33, 77](#)
 system routing mode hierarchical 64b-alm [31–32, 76](#)
 system routing non-hierarchical-routing [30, 74–75](#)
 system switchover [104, 159, 250](#)

T

table-map [135–136, 184–185](#)
 template peer [339–340](#)
 template peer-session [334–335, 337](#)
 test forwarding [510–511](#)
 threshold percentage up [632](#)
 threshold weight up [633–634](#)
 timers [301–302, 335, 339–341, 586](#)
 timers [bestpath-delay [391](#)
 timers active-time [236, 238](#)
 timers advertise [613–614](#)
 timers basic [445, 460](#)
 timers lsa-arrival [138, 187](#)
 timers lsa-group-pacing [138, 187](#)
 timers nsf converge [233–234](#)
 timers nsf route-hold [233–234](#)
 timers nsf signal [233–234](#)
 timers prefix-peer-timeout [342, 420](#)
 timers throttle lsa [138, 187](#)

timers throttle spf [138–139](#)
 track [583–584, 628–633, 635–637](#)
 track interface [609–610](#)
 transmit-delay [126, 128, 176–177](#)
 transport connection-mode passive [392](#)
 tuning [460](#)
 RIPng [460](#)

U

update-source [364–365, 393](#)

V

verifying [461](#)
 RIPng [461](#)
 virtualization [457](#)
 configuring [457](#)
 virtualization support [451](#)
 for RIPng [451](#)
 vrf [142–143, 191–192, 273, 422, 442–443, 458–459, 480](#)
 vrf context [95, 142–143, 191–192, 239, 273, 422, 442, 458, 468, 477–478, 482, 512](#)
 vrf member [142–143, 191–192, 239–240, 273–274, 442–443, 458–459, 479–481, 636–637](#)
 vrrp [602–610](#)
 vrrp2 [613–614](#)
 vrrpv3 [613, 615](#)
 vrrs leader [613–614](#)
 vrrs pathway [617–618](#)

W

weight [301–302](#)
 write erase [476](#)
 write erase boot [476](#)