



Cisco Nexus 3548 Switch NX-OS Unicast Routing Configuration Guide, Release 10.5(x)

First Published: 2024-07-26

Americas Headquarters

Cisco Systems, Inc.
170 West Tasman Drive
San Jose, CA 95134-1706
USA
<http://www.cisco.com>
Tel: 408 526-4000
800 553-NETS (6387)
Fax: 408 527-0883

THE SPECIFICATIONS AND INFORMATION REGARDING THE PRODUCTS REFERENCED IN THIS DOCUMENTATION ARE SUBJECT TO CHANGE WITHOUT NOTICE. EXCEPT AS MAY OTHERWISE BE AGREED BY CISCO IN WRITING, ALL STATEMENTS, INFORMATION, AND RECOMMENDATIONS IN THIS DOCUMENTATION ARE PRESENTED WITHOUT WARRANTY OF ANY KIND, EXPRESS OR IMPLIED.

The Cisco End User License Agreement and any supplemental license terms govern your use of any Cisco software, including this product documentation, and are located at <https://www.cisco.com/c/en/us/about/legal/cloud-and-software/software-terms.html>. Cisco product warranty information is available at <https://www.cisco.com/c/en/us/products/warranty-listing.html>. US Federal Communications Commission Notices are found here <https://www.cisco.com/c/en/us/products/us-fcc-notice.html>.

IN NO EVENT SHALL CISCO OR ITS SUPPLIERS BE LIABLE FOR ANY INDIRECT, SPECIAL, CONSEQUENTIAL, OR INCIDENTAL DAMAGES, INCLUDING, WITHOUT LIMITATION, LOST PROFITS OR LOSS OR DAMAGE TO DATA ARISING OUT OF THE USE OR INABILITY TO USE THIS MANUAL, EVEN IF CISCO OR ITS SUPPLIERS HAVE BEEN ADVISED OF THE POSSIBILITY OF SUCH DAMAGES.

Any products and features described herein as in development or available at a future date remain in varying stages of development and will be offered on a when-and if-available basis. Any such product or feature roadmaps are subject to change at the sole discretion of Cisco and Cisco will have no liability for delay in the delivery or failure to deliver any products or feature roadmap items that may be set forth in this document.

Any Internet Protocol (IP) addresses and phone numbers used in this document are not intended to be actual addresses and phone numbers. Any examples, command display output, network topology diagrams, and other figures included in the document are shown for illustrative purposes only. Any use of actual IP addresses or phone numbers in illustrative content is unintentional and coincidental.

The documentation set for this product strives to use bias-free language. For the purposes of this documentation set, bias-free is defined as language that does not imply discrimination based on age, disability, gender, racial identity, ethnic identity, sexual orientation, socioeconomic status, and intersectionality. Exceptions may be present in the documentation due to language that is hardcoded in the user interfaces of the product software, language used based on RFP documentation, or language that is used by a referenced third-party product.

Cisco and the Cisco logo are trademarks or registered trademarks of Cisco and/or its affiliates in the U.S. and other countries. To view a list of Cisco trademarks, go to this URL: <https://www.cisco.com/c/en/us/about/legal/trademarks.html>. Third-party trademarks mentioned are the property of their respective owners. The use of the word partner does not imply a partnership relationship between Cisco and any other company. (1721R)

© 2024 Cisco Systems, Inc. All rights reserved.



Preface

This preface describes the audience, organization, and conventions of the *Cisco Nexus 3548 Switch NX-OS Unicast Routing Configuration Guide*. It also provides information on how to obtain related documentation.

This chapter includes the following sections:

- [Audience, on page iii](#)
- [Document Conventions, on page iii](#)
- [Related Documentation for Nexus 3548 Switch NX-OS Software, on page iv](#)
- [Documentation Feedback, on page v](#)
- [Communications, Services, and Additional Information, on page v](#)

Audience

To use this guide, you must be familiar with IP and routing technology.

Document Conventions

Command descriptions use these conventions:

Convention	Description
boldface font	Commands and keywords are in boldface.
<i>italic font</i>	Arguments for which you supply values are in italics.
[]	Elements in square brackets are optional.
[x y z]	Optional alternative keywords are grouped in brackets and separated by vertical bars.
string	A nonquoted set of characters. Do not use quotation marks around the string or the string will include the quotation marks.

Screen examples use these conventions:

screen font	Terminal sessions and information that the switch displays are in screen font.
-------------	--

boldface screen font	Information you must enter is in boldface screen font.
<i>italic screen font</i>	Arguments for which you supply values are in italic screen font.
< >	Nonprinting characters, such as passwords, are in angle brackets.
[]	Default responses to system prompts are in square brackets.
!, #	An exclamation point (!) or a pound sign (#) at the beginning of a line of code indicates a comment line.

This document uses the following conventions:



Note Means reader *take note*. Notes contain helpful suggestions or references to material not covered in the manual.



Caution Means *reader be careful*. In this situation, you might do something that could result in equipment damage or loss of data



Tip Means the following information will help you solve a problem.

Related Documentation for Nexus 3548 Switch NX-OS Software

The entire Cisco Nexus 3548 switch software documentation set is available at the following URL:

http://www.cisco.com/en/US/products/ps11541/tsd_products_support_series_home.html

Release Notes

The release notes are available at the following URL:

http://www.cisco.com/en/US/products/ps11541/prod_release_notes_list.html

Installation and Upgrade Guides

The installation and upgrade guides are available at the following URL:

http://www.cisco.com/en/US/products/ps11541/prod_installation_guides_list.html

The documents in this category include:

- Cisco Nexus 5000 Series, Cisco Nexus 3000 Series, and Cisco Nexus 2000 Series Safety Information and Documentation
- Regulatory, Compliance, and Safety Information for the Cisco Nexus 5000 Series, Cisco Nexus 3000 Series, and Cisco Nexus 2000 Series
- Cisco Nexus 3000 Series Hardware Installation Guide

License Information

For information about feature licenses in NX-OS, see the Cisco NX-OS Licensing Guide, available at the following URL:

http://www.cisco.com/en/US/docs/switches/datacenter/sw/nx-os/licensing/guide/b_Cisco_NX-OS_Licensing_Guide.html

Configuration Guides

The configuration guides are available at the following URL:

http://www.cisco.com/en/US/products/ps11541/products_installation_and_configuration_guides_list.html

The documents in this category include:

- Fundamentals Configuration Guide
- Interfaces Configuration Guide
- Layer 2 Switching Configuration Guide
- Multicast Configuration Guide
- Quality of Service Configuration Guide
- Security Configuration Guide
- System Management Configuration Guide
- Unicast Routing Configuration Guide
- Verified Scalability Guide for Cisco NX-OS

Command References

The command references are available at the following URL:

<https://www.cisco.com/c/en/us/support/switches/nexus-3000-series-switches/products-command-reference-list.html>

Error and System Messages

The system message reference guide is available at the following URL:

http://www.cisco.com/en/US/products/ps11541/products_system_message_guides_list.html

Documentation Feedback

To provide technical feedback on this document, or to report an error or omission, please send your comments to nexus3k-docfeedback@cisco.com. We appreciate your feedback.

Communications, Services, and Additional Information

- To receive timely, relevant information from Cisco, sign up at [Cisco Profile Manager](#).
- To get the business impact you're looking for with the technologies that matter, visit [Cisco Services](#).
- To submit a service request, visit [Cisco Support](#).

- To discover and browse secure, validated enterprise-class apps, products, solutions and services, visit [Cisco DevNet](#).
- To obtain general networking, training, and certification titles, visit [Cisco Press](#).
- To find warranty information for a specific product or product family, access [Cisco Warranty Finder](#).

Cisco Bug Search Tool

[Cisco Bug Search Tool](#) (BST) is a web-based tool that acts as a gateway to the Cisco bug tracking system that maintains a comprehensive list of defects and vulnerabilities in Cisco products and software. BST provides you with detailed defect information about your products and software.



CHAPTER 1

New and Changed Information

- [New and Changed Information](#), on page 1

New and Changed Information

Table 1: New and Changed Features

Feature	Description	Changed in Release	Where Documented
NA	No new feature is added.	10.5(1)F	NA



CHAPTER 2

Overview

This chapter introduces the basic concepts for Layer 3 unicast routing protocols in Cisco NX-OS.

This chapter includes the following sections:

- [Licensing Requirements, on page 3](#)
- [Information About Layer 3 Unicast Routing, on page 3](#)
- [Router IDs, on page 6](#)
- [Autonomous Systems, on page 7](#)
- [Convergence, on page 7](#)
- [Load Balancing and Equal Cost Multipath, on page 8](#)
- [Route Redistribution, on page 8](#)
- [Administrative Distance, on page 8](#)
- [Stub Routing, on page 8](#)
- [Routing Algorithms, on page 9](#)
- [Cisco NX-OS Forwarding Architecture, on page 11](#)
- [Summary of Layer 3 Unicast Routing Features, on page 14](#)
- [First-Hop Redundancy Protocols, on page 15](#)
- [Object Tracking, on page 15](#)

Licensing Requirements

For a complete explanation of Cisco NX-OS licensing recommendations and how to obtain and apply licenses, see the [Cisco NX-OS Licensing Guide](#) and the [Cisco NX-OS Licensing Options Guide](#).

Information About Layer 3 Unicast Routing

Layer 3 unicast routing involves two basic activities: determining optimal routing paths and packet switching. You can use routing algorithms to calculate the optimal path from the router to a destination. This calculation depends on the algorithm selected, route metrics, and other considerations such as load balancing and alternate path discovery.

Routing Fundamentals

Routing protocols use a metric to evaluate the best path to the destination. A metric is a standard of measurement, such as a path bandwidth, that routing algorithms use to determine the optimal path to a destination. To aid path determination, routing algorithms initialize and maintain routing tables, that contain route information such as the IP destination address and the address of the next router or next hop. Destination and next-hop associations tell a router that an IP destination can be reached optimally by sending the packet to a particular router that represents the next hop on the way to the final destination. When a router receives an incoming packet, it checks the destination address and attempts to associate this address with the next hop. See the [Unicast RIB](#) section for more information about the route table.

Routing tables can contain other information such as the data about the desirability of a path. Routers compare metrics to determine optimal routes, and these metrics differ depending on the design of the routing algorithm used. See the [Routing Metrics](#) section.

Routers communicate with one another and maintain their routing tables by transmitting a variety of messages. The routing update message is one of these messages that consists of all or a portion of a routing table. By analyzing routing updates from all other routers, a router can build a detailed picture of the network topology. A link-state advertisement, which is another example of a message sent between routers, informs other routers of the link state of the sending router. You can also use link information to enable routers to determine optimal routes to network destinations. For more information, see the [Routing Algorithms](#) section.

Packet Switching

In packet switching, a host determines that it must send a packet to another host. Having acquired a router address by some means, the source host sends a packet addressed specifically to the router physical (Media Access Control [MAC]-layer) address but with the IP (network layer) address of the destination host.

The router examines the destination IP address and tries to find the IP address in the routing table. If the router does not know how to forward the packet, it typically drops the packet. If the router knows how to forward the packet, it changes the destination MAC address to the MAC address of the next hop router and transmits the packet.

The next hop might be the ultimate destination host or another router that executes the same switching decision process. As the packet moves through the internetwork, its physical address changes, but its protocol address remains constant (see the following figure).

Figure 1: Packet Header Updates Through a Network

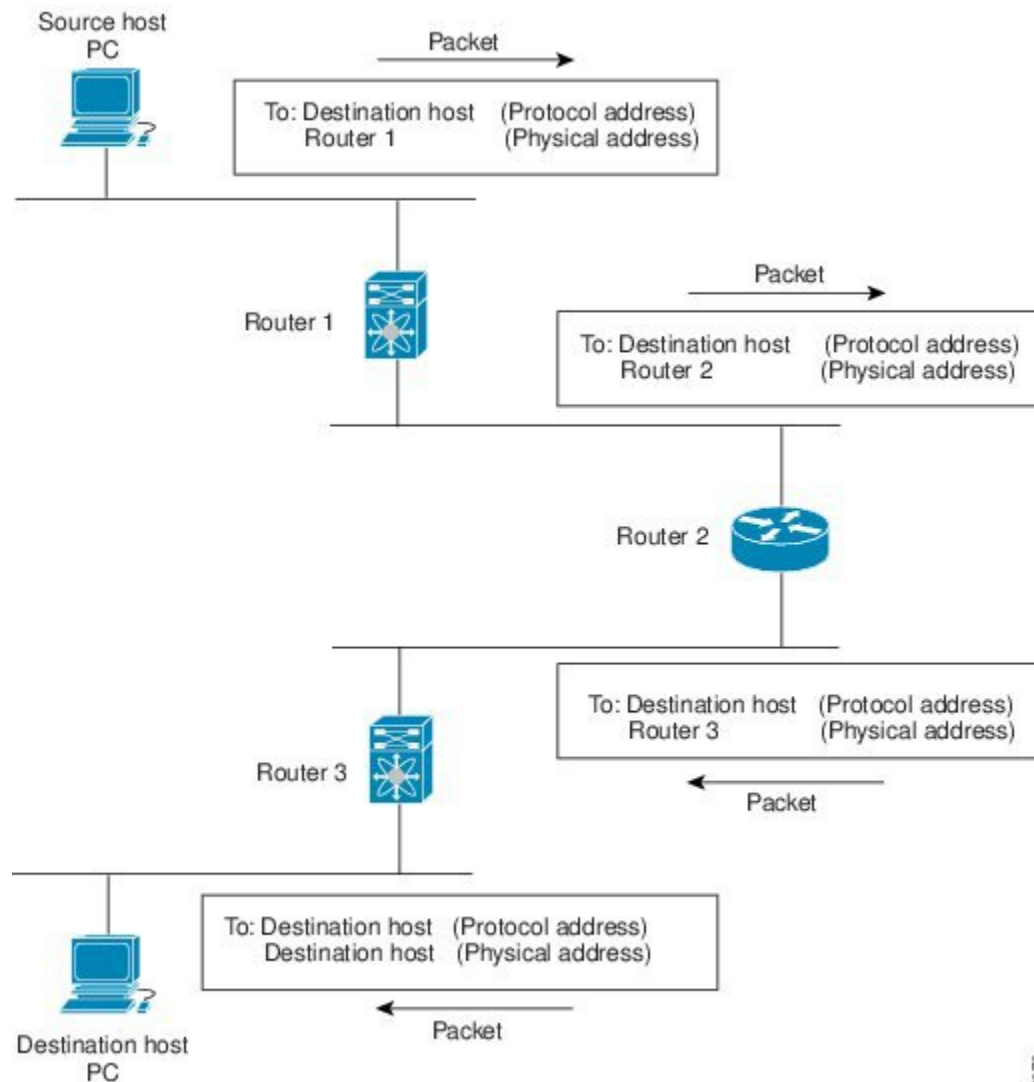

18-2978

Routing Metrics

Routing algorithms use many different metrics to determine the best route. Sophisticated routing algorithms can base route selection on multiple metrics.

Path Length

The path length is the most common routing metric. Some routing protocols allow you to assign arbitrary costs to each network link. In this case, the path length is the sum of the costs associated with each link traversed. Other routing protocols define hop count, a metric that specifies the number of passes through internetworking products, such as routers, that a packet must take from a source to a destination.

Reliability

The reliability, in the context of routing algorithms, is the dependability (in terms of the bit-error rate) of each network link. Some network links might go down more often than others. After a network fails, certain network links might be repaired more easily or more quickly than other links. The reliability factors that you can take into account when assigning the reliability rating are arbitrary numeric values that you usually assign to network links.

Routing Delay

The routing delay is the length of time required to move a packet from a source to a destination through the internetwork. The delay depends on many factors, including the bandwidth of intermediate network links, the port queues at each router along the way, the network congestion on all intermediate network links, and the physical distance that the packet needs to travel. Because the routing delay is a combination of several important variables, it is a common and useful metric.

Bandwidth

The bandwidth is the available traffic capacity of a link. For example, a 10-Gigabit Ethernet link would be preferable to a 1-Gigabit Ethernet link. Although the bandwidth is the maximum attainable throughput on a link, routes through links with greater bandwidth do not necessarily provide better routes than routes through slower links. For example, if a faster link is busier, the actual time required to send a packet to the destination could be greater.

Load

The load is the degree to which a network resource, such as a router, is busy. You can calculate the load in a variety of ways, including CPU utilization and packets processed per second. Monitoring these parameters on a continual basis can be resource intensive.

Communication Cost

The communication cost is a measure of the operating cost to route over a link. The communication cost is another important metric, especially if you do not care about performance as much as operating expenditures. For example, the line delay for a private line might be longer than a public line, but you can send packets over your private line rather than through the public lines that cost money for usage time.

Router IDs

Each routing process has an associated router ID. You can configure the router ID to any interface in the system. If you do not configure the router ID, Cisco NX-OS selects the router ID based on the following criteria:

- Cisco NX-OS prefers loopback0 over any other interface. If loopback0 does not exist, then Cisco NX-OS prefers the first loopback interface over any other interface type.
- If you have not configured any loopback interfaces, Cisco NX-OS uses the first interface in the configuration file as the router ID. If you configure any loopback interface after Cisco NX-OS selects the router ID, the loopback interface becomes the router ID. If the loopback interface is not loopback0 and you configure loopback0 later with an IP address, the router ID changes to the IP address of loopback0.

- If the interface that the router ID is based on changes, that new IP address becomes the router ID. If any other interface changes its IP address, there is no router ID change.

Autonomous Systems

An autonomous system (AS) is a network controlled by a single technical administration entity. Autonomous systems divide global external networks into individual routing domains, where local routing policies are applied. This organization simplifies routing domain administration and simplifies consistent policy configuration.

Each autonomous system can support multiple interior routing protocols that dynamically exchange routing information through route redistribution. The Regional Internet Registries assign a unique number to each public autonomous system that directly connects to the Internet. This autonomous system number (AS number) identifies both the routing process and the autonomous system.

Cisco NX-OS supports 4-byte AS numbers. Table below lists the AS number ranges.

Table 2: AS Numbers

2-Byte Numbers	4-Byte Numbers in AS.dot Notation	4-Byte Numbers in plaintext Notation	Purpose
1 to 64511	0.1 to 0.64511	1 to 64511	Public AS (assigned by RIR)
64512 to 65534	0.64512 to 0.65534	64512 to 65534	Private AS (assigned by local administrator)
65535	0.65535	65535	Reserved
N/A	1.0 to 65535.65535	65536 to 4294967295	Public AS (assigned by RIR)

Private autonomous system numbers are used for internal routing domains but must be translated by the router for traffic that is routed out to the Internet. You should not configure routing protocols to advertise private autonomous system numbers to external networks. By default, Cisco NX-OS does not remove private autonomous system numbers from routing updates.



Note The autonomous system number assignment for public and private networks is governed by the Internet Assigned Number Authority (IANA). For information about autonomous system numbers, including the reserved number assignment, or to apply to register an autonomous system number, refer to the following URL: <http://www.iana.org/>

Convergence

A key aspect to measure for any routing algorithm is how much time a router takes to react to network topology changes. When a part of the network changes for any reason, such as a link failure, the routing information in different routers might not match. Some routers will have updated information about the changed topology, other routers will still have the old information. The convergence is the amount of time before all routers in the network have updated, matching routing information. The convergence time varies depending on the

routing algorithm. Fast convergence minimizes the chance of lost packets caused by inaccurate routing information.

Load Balancing and Equal Cost Multipath

Routing protocols can use load balancing or equal cost multipath (ECMP) to share traffic across multiple paths. When a router learns multiple routes to a specific network, it installs the route with the lowest administrative distance in the routing table. If the router receives and installs multiple paths with the same administrative distance and cost to a destination, load balancing can occur. Load balancing distributes the traffic across all the paths, sharing the load. The number of paths used is limited by the number of entries that the routing protocol puts in the routing table. Cisco NX-OS supports up to 32 paths to a destination.

The Enhanced Interior Gateway Routing Protocol (EIGRP) also supports unequal cost load balancing. For more information, see [Configuring EIGRP](#).

Route Redistribution

If you have multiple routing protocols configured in your network, you can configure these protocols to share routing information by configuring route redistribution in each protocol. For example, you can configure Open Shortest Path First (OSPF) to advertise routes learned from the Border Gateway Protocol (BGP). You can also redistribute static routes into any dynamic routing protocol. The router that is redistributing routes from another protocol sets a fixed route metric for those redistributed routes. This process avoids the problem of incompatible route metrics between the different routing protocols. For example, routes redistributed from EIGRP into OSPF are assigned a fixed link cost metric that OSPF understands.

Route redistribution also uses an administrative distance (see the [Administrative Distance](#) section) to distinguish between routes learned from two different routing protocols. The preferred routing protocol is given a lower administrative distance so that its routes are chosen over routes from another protocol with a higher administrative distance assigned.

Administrative Distance

An administrative distance is a rating of the trustworthiness of a routing information source. The higher the value, the lower the trust rating. Typically, a route can be learned through more than one protocol. Administrative distance is used to discriminate between routes learned from more than one protocol. The route with the lowest administrative distance is installed in the IP routing table.

Stub Routing

You can use stub routing in a hub-and-spoke network topology, where one or more end (stub) networks are connected to a remote router (the spoke) that is connected to one or more distribution routers (the hub). The remote router is adjacent only to one or more distribution routers. The only route for IP traffic to follow into the remote router is through a distribution router. This type of configuration is commonly used in WAN topologies in which the distribution router is directly connected to a WAN. The distribution router can be connected to many more remote routers. Often, the distribution router is connected to 100 or more remote routers. In a hub-and-spoke topology, the remote router must forward all nonlocal traffic to a distribution

router, so it becomes unnecessary for the remote router to hold a complete routing table. Generally, the distribution router sends only a default route to the remote router.

Only specified routes are propagated from the remote (stub) router. The stub router responds to all queries for summaries, connected routes, redistributed static routes, external routes, and internal routes with the message “inaccessible.” A router that is configured as a stub sends a special peer information packet to all neighboring routers to report its status as a stub router.

Any neighbor that receives a packet informing it of the stub status does not query the stub router for any routes, and a router that has a stub peer does not query that peer. The stub router depends on the distribution router to send the proper updates to all peers. The following figure shows a simple hub-and-spoke configuration.

Figure 2: Simple Hub-and-Spoke Network

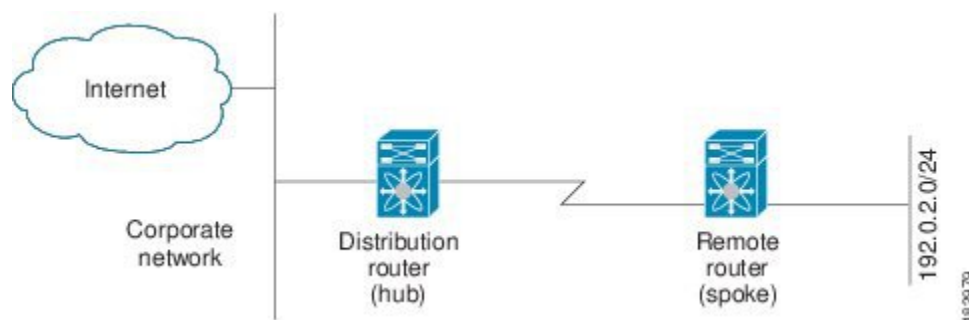

Stub routing does not prevent routes from being advertised to the remote router. Figure 1-2 shows that the remote router can access the corporate network and the Internet through the distribution router only. A full route table on the remote router, in this example, serves no functional purpose because the path to the corporate network and the Internet would always be through the distribution router. A larger route table would reduce only the amount of memory required by the remote router. The bandwidth and memory used can be lessened by summarizing and filtering routes in the distribution router. In this network topology, the remote router does not need to receive routes that have been learned from other networks because the remote router must send all nonlocal traffic, regardless of its destination, to the distribution router. To configure a true stub network, you should configure the distribution router to send only a default route to the remote router.

OSPF supports stub areas and EIGRP supports stub routers.



Note The EIGRP stub routing feature should be used only on stub devices. A stub device is defined as a device connected to the network core or distribution layer through which core transit traffic should not flow. The only route for IP traffic to follow into the remote router is through a distribution router. A stub device should not have any EIGRP neighbors other than distribution devices. Ignoring this restriction will cause undesirable behavior.

Routing Algorithms

Routing algorithms determine how a router gathers and reports reachability information, how it deals with topology changes, and how it determines the optimal route to a destination. Various types of routing algorithms exist, and each algorithm has a different impact on network and router resources. Routing algorithms use a variety of metrics that affect calculation of optimal routes. You can classify routing algorithms by type, such as static or dynamic, and interior or exterior.

Static Routes and Dynamic Routing Protocols

Static routes are route table entries that you manually configure. These static routes do not change unless you reconfigure them. Static routes are simple to design and work well in environments where network traffic is relatively predictable and where network design is relatively simple.

Because static routing systems cannot react to network changes, you should not use them for today's large, constantly changing networks. Most routing protocols today use dynamic routing algorithms, which adjust to changing network circumstances by analyzing incoming routing update messages. If the message indicates that a network change has occurred, the routing software recalculates routes and sends out new routing update messages. These messages permeate the network, triggering routers to rerun their algorithms and change their routing tables accordingly.

You can supplement dynamic routing algorithms with static routes where appropriate. For example, you should configure each subnetwork with a static route to the IP default gateway or router of last resort (a router to which all unroutable packets are sent).

Interior and Exterior Gateway Protocols

You can separate networks into unique routing domains or autonomous systems. An autonomous system is a portion of an internetwork under common administrative authority that is regulated by a particular set of administrative guidelines. Routing protocols that route between autonomous systems are called exterior gateway protocols or interdomain protocols. BGP is an example of an exterior gateway protocol. Routing protocols used within an autonomous system are called interior gateway protocols or intradomain protocols. EIGRP and OSPF are examples of interior gateway protocols.

Distance Vector Protocols

Distance vector protocols use distance vector algorithms (also known as Bellman-Ford algorithms) that call for each router to send all or some portion of its routing table to its neighbors. Distance vector algorithms define routes by distance (for example, the number of hops to the destination) and direction (for example, the next-hop router). These routes are then broadcast to the directly connected neighbor routers. Each router uses these updates to verify and update the routing tables.

To prevent routing loops, most distance vector algorithms use split horizon with poison reverse which means that the routes learned from an interface are set as unreachable and advertised back along the interface that they were learned on during the next periodic update. This feature prevents the router from seeing its own route updates coming back.

Distance vector algorithms send updates at fixed intervals but can also send updates in response to changes in route metric values. These triggered updates can speed up the route convergence time. The Routing Information Protocol (RIP) is a distance vector protocol.

Link-State Protocols

The link-state protocols, also known as shortest path first (SPF), share information with neighboring routers. Each router builds a link-state advertisement (LSA), which contains information about each link and directly connected neighbor router.

Each LSA has a sequence number. When a router receives an LSA and updates its link-state database, the LSA is flooded to all adjacent neighbors. If a router receives two LSAs with the same sequence number (from the same router), the router does not flood the last LSA received to its neighbors to prevent an LSA update

loop. Because the router floods the LSAs immediately after they receive them, convergence time for link-state protocols is minimized.

Discovering neighbors and establishing adjacency is an important part of a link state protocol. Neighbors are discovered using special Hello packets that also serve as keepalive notifications to each neighbor router. Adjacency is the establishment of a common set of operating parameters for the link-state protocol between neighbor routers.

The LSAs received by a router are added to its link-state database. Each entry consists of the following parameters:

- Router ID (for the router that originated the LSA)
- Neighbor ID
- Link cost
- Sequence number of the LSA
- Age of the LSA entry

The router runs the SPF algorithm on the link-state database, building the shortest path tree for that router. This SPF tree is used to populate the routing table.

In link-state algorithms, each router builds a picture of the entire network in its routing tables. The link-state algorithms send small updates everywhere, while distance vector algorithms send larger updates only to neighboring routers.

Because they converge more quickly, link-state algorithms are somewhat less prone to routing loops than distance vector algorithms. However, link-state algorithms require more CPU power and memory than distance vector algorithms. Link-state algorithms can be more expensive to implement and support. Link-state protocols are generally more scalable than distance vector protocols.

OSPF is an example of a link-state protocol.

Cisco NX-OS Forwarding Architecture

The Cisco NX-OS forwarding architecture is responsible for processing all routing updates and populating the forwarding information on the switch.

Unicast RIB

The Cisco NX-OS forwarding architecture consists of multiple components, as shown in the following figure.

Figure 3: Cisco NX-OS Forwarding Architecture

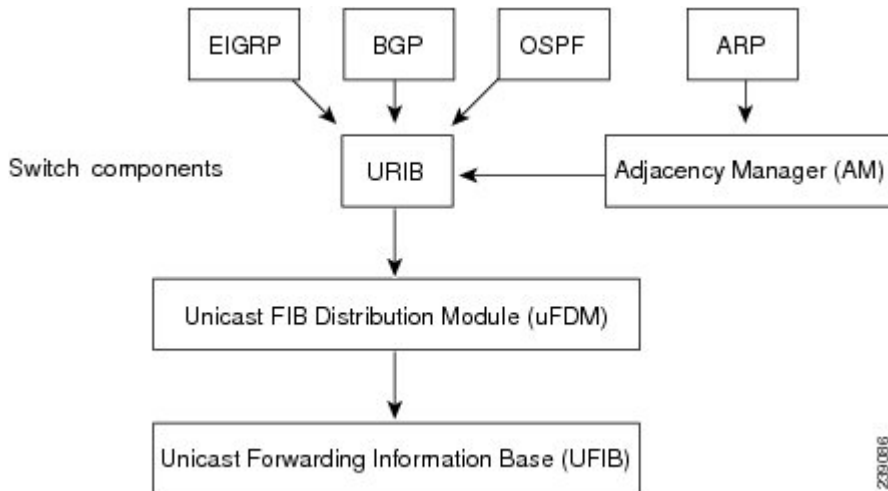

The unicast RIB maintains the routing table with directly connected routes, static routes, and routes learned from dynamic unicast routing protocols. The unicast RIB also collects adjacency information from sources such as the Address Resolution Protocol (ARP). The unicast RIB determines the best next hop for a given route and populates the unicast forwarding information base (FIB) by using the services of unicast FIB distribution module (FDM).

Each dynamic routing protocol must update the unicast RIB for any route that has timed out. The unicast RIB then deletes the route and recalculates the best next hop (if an alternate path is available).

Adjacency Manager

The adjacency manager maintains adjacency information for different protocols including ARP, Open Shortest Path First version 2 (OSPFv2), Neighbor Discovery Protocol (NDP), and static configuration. The most basic adjacency information is the Layer 3 to Layer 2 address mapping discovered by these protocols. Outgoing Layer 2 packets use the adjacency information to complete the Layer 2 header.

The adjacency manager can trigger ARP requests to find a particular Layer 3 to Layer 2 mapping. The new mapping becomes available when the corresponding ARP reply is received and processed.

Adjacency Table

On the Cisco Nexus 3548 switch, the adjacency table is shared with the Layer 2 MAC forwarding table.

For example, the maximum number of adjacency entries is equal to the maximum number of Layer 2 MAC entries, which is 64,000 entries.

The MAC or adjacency table is implemented as a hash table.

Unicast Forwarding Distribution Module

The unicast forwarding distribution module distributes the forwarding path information from the unicast RIB and other sources. The unicast RIB generates forwarding information which the unicast FIB programs into the hardware forwarding tables. The unicast forwarding distribution module also downloads the FIB information to newly inserted modules.

The unicast forwarding distribution module gathers adjacency information, rewrite information, and other platform-dependent information when updating routes in the unicast FIB. The adjacency and rewrite information consists of interface, next-hop, and Layer 3 to Layer 2 mapping information. The interface and next-hop information is received in route updates from the unicast RIB. The Layer 3 to Layer 2 mapping is received from the adjacency manager.

FIB

The unicast FIB builds the information used for the hardware forwarding engine. The unicast FIB receives route updates from the unicast forwarding distribution module and sends the information along to be programmed in the hardware forwarding engine. The unicast FIB controls the addition, deletion, and modification of routes, paths, and adjacencies.

The unicast FIBs are maintained on a per-VRF and per-address-family basis. Based on route update messages, the unicast FIB maintains a per-VRF prefix and next-hop adjacency information database. The next-hop adjacency data structure contains the next-hop IP address and the Layer 2 rewrite information. Multiple prefixes could share a next-hop adjacency information structure.

The unicast FIB also enables and disables unicast reverse path forwarding (RPF) checks per interface. The Cisco Nexus 3548 platform switch supports the following two RPF modes that can be configured on each ingress interface:

- RPF Strict Check—Packets that do not have a verifiable source address in the routers forwarding table or do not arrive on any of the return paths to the source are dropped.
- RPF Loose Check—Packets have a verifiable source address in the routers forwarding table and the source is reachable through a physical interface. The ingress interface that receives the packet need not match any of the interfaces in the FIB.

Hardware Forwarding

Cisco NX-OS supports distributed packet forwarding. The ingress port takes relevant information from the packet header and passes the information to the local switching engine. The local switching engine does the Layer 3 lookup and uses this information to rewrite the packet header. The ingress module forwards the packet to the egress port. If the egress port is on a different module, the packet is forwarded using the switch fabric to the egress module. The egress module does not participate in the Layer 3 forwarding decision.

You also can use the **show platform fib** or **show platform forwarding** commands to display details on hardware forwarding.

Software Forwarding

The software forwarding path in Cisco NX-OS is used mainly to handle features that are not supported in hardware or to handle errors encountered during hardware processing. Typically, packets with IP options or packets that need fragmentation are passed to the CPU. The unicast RIB and the adjacency manager make the forwarding decisions based on the packets that should be switched in software or terminated.

Software forwarding is controlled by control plane policies and rate limiters.

Summary of Layer 3 Unicast Routing Features

This section provides a brief introduction to the Layer 3 unicast features and protocols supported in Cisco NX-OS.

OSPF

The OSPF protocol is a link-state routing protocol used to exchange network reachability information within an autonomous system. Each OSPF router advertises information about its active links to its neighbor routers. Link information consists of the link type, the link metric, and the neighbor router connected to the link. The advertisements that contain this link information are called link-state advertisements. For more information, see [Configuring OSPFv2](#).

EIGRP

The EIGRP protocol is a unicast routing protocol that has the characteristics of both distance vector and link-state routing protocols. It is an improved version of IGRP, which is a Cisco proprietary routing protocol. EIGRP relies on its neighbors to provide the routes, typical to a distance vector routing protocol. It constructs the network topology from the routes advertised by its neighbors, similar to a link-state protocol, and uses this information to select loop-free paths to destinations. For more information, see [Configuring EIGRP](#).

BGP

The Border Gateway Protocol (BGP) is an inter-autonomous system routing protocol. A BGP router advertises network reachability information to other BGP routers using Transmission Control Protocol (TCP) as its reliable transport mechanism. The network reachability information includes the destination network prefix, a list of autonomous systems that needs to be traversed to reach the destination, and the next-hop router. Reachability information contains additional path attributes such as preference to a route, origin of the route, community and others. For more information, see [Configuring Basic BGP](#) and [Configuring Advanced BGP](#).

RIP

The Routing Information Protocol (RIP) is a distance-vector protocol that uses a hop count as its metric. RIP is widely used for routing traffic in the global Internet and is an Interior Gateway Protocol (IGP), which means that it performs routing within a single autonomous system. For more information, see [Configuring RIP, on page 208](#).

Static Routing

Static routing allows you to enter a fixed route to a destination. This feature is useful for small networks where the topology is simple. Static routing is also used with other routing protocols to control default routes and route distribution. For more information, see [Configuring Static Routing](#).

Route Policy Manager

The Route Policy Manager provides a route filtering capability in Cisco NX-OS. It uses route maps to filter routes distributed across various routing protocols and between different entities within a given routing protocol. Filtering is based on specific match criteria, which is similar to packet filtering by access control lists. For more information, see [Configuring Route Policy Manager](#).

First-Hop Redundancy Protocols

A first-hop redundancy protocol (FHRP) allows you to provide redundant connections to your hosts. If an active first-hop router fails, the FHRP automatically selects a standby router to take over. You do not need to update the hosts with new IP addresses because the address is virtual and shared between each router in the FHRP group. For more information on the Hot Standby Router Protocol (HSRP), see [Configuring HSRP](#). For more information on the Virtual Router Redundancy Protocol (VRRP), see [Configuring VRRP](#).

Object Tracking

Object tracking allows you to track specific objects on the network, such as the interface line protocol state, IP routing, and route reachability, and take action when the tracked object's state changes. This feature allows you to increase the availability of the network and shorten recovery time if an object state goes down. For more information.



CHAPTER 3

Configuring IPv4

This chapter describes how to configure Internet Protocol version 4 (IPv4), which includes addressing, Address Resolution Protocol (ARP), and Internet Control Message Protocol (ICMP), on the Cisco NX-OS switches.

This chapter includes the following sections:

- [Information About IPv4, on page 17](#)
- [Prerequisites for IPv4, on page 22](#)
- [Guidelines and Limitations for IPv4, on page 22](#)
- [Default Settings for IPv4, on page 22](#)
- [Configuring IPv4, on page 23](#)
- [Verifying the IPv4 Configuration, on page 35](#)
- [Configuration Examples for IPv4, on page 35](#)
- [Additional References, on page 35](#)

Information About IPv4

You can configure IP on the switch to assign IP addresses to network interfaces. When you assign IP addresses, you enable the interfaces and allow communication with the hosts on those interfaces.

You can configure an IP address as primary or secondary on a switch. An interface can have one primary IP address and multiple secondary addresses. All networking switches on an interface should share the same primary IP address because the packets that are generated by the switch always use the primary IPv4 address. Each IPv4 packet is based on the information from a source or destination IP address. See the [Multiple IPv4 Addresses](#) section.

You can use a subnet to mask the IP addresses. A mask is used to determine what subnet an IP address belongs to. An IP address contains the network address and the host address. A mask identifies the bits that denote the network number in an IP address. When you use the mask to subnet a network, the mask is then referred to as a subnet mask. Subnet masks are 32-bit values that allow the recipient of IP packets to distinguish the network ID portion of the IP address from the host ID portion of the IP address.

The IP feature in the Cisco NX-OS system is responsible for handling IPv4 packets, as well as the forwarding of IPv4 packets, which includes IPv4 unicast route lookup, reverse path forwarding (RPF) checks, and software access control list (ACL) forwarding. The IP feature also manages the network interface IP address configuration, duplicate address checks, static routes, and packet send and receive interface for IP clients.

Multiple IPv4 Addresses

The Cisco NX-OS system supports multiple IP addresses per interface. You can specify an unlimited number of secondary addresses for a variety of situations. The most common situations are as follows:

- When there are not enough host IP addresses for a particular network interface. For example, if your subnet allows up to 254 hosts per logical subnet, but on one physical subnet you must have 300 host addresses, then you can use secondary IP addresses on the routers or access servers to allow you to have two logical subnets using one physical subnet.
- Two subnets of a single network might otherwise be separated by another network. You can create a single network from subnets that are physically separated by another network by using a secondary address. In these instances, the first network is extended, or layered on top of the second network. A subnet cannot appear on more than one active interface of the router at a time.



Note If any switch on a network segment uses a secondary IPv4 address, all other switches on that same network interface must also use a secondary address from the same network or subnet. The inconsistent use of secondary addresses on a network segment can quickly cause routing loops.

Address Resolution Protocol

Networking switches and Layer 3 switches use Address Resolution Protocol (ARP) to map IP (network layer) addresses to (Media Access Control [MAC]-layer) addresses to enable IP packets to be sent across networks. Before a switch sends a packet to another switch, it looks in its own ARP cache to see if there is a MAC address and corresponding IP address for the destination switch. If there is no entry, the source switch sends a broadcast message to every switch on the network.

Each switch compares the IP address to its own. Only the switch with the matching IP address replies to the switch that sends the data with a packet that contains the MAC address for the switch. The source switch adds the destination switch MAC address to its ARP table for future reference, creates a data-link header and trailer that encapsulates the packet, and proceeds to transfer the data. The following figure shows the ARP broadcast and response process.

Figure 4: ARP Process



When the destination switch lies on a remote network which is beyond another switch, the process is the same except that the switch that sends the data sends an ARP request for the MAC address of the default gateway. After the address is resolved and the default gateway receives the packet, the default gateway broadcasts the destination IP address over the networks connected to it. The switch on the destination switch network uses ARP to obtain the MAC address of the destination switch and delivers the packet. ARP is enabled by default.

The default system-defined CoPP policy rate-limits ARP broadcast packets. The default system-defined CoPP policy prevents an ARP broadcast storm from affecting the control plane traffic but does not affect bridged packets.

ARP Caching

ARP caching minimizes broadcasts and limits wasteful use of network resources. The mapping of IP addresses to MAC addresses occurs at each hop (switch) on the network for every packet sent over an internetwork, which may affect network performance.

ARP caching stores network addresses and the associated data-link addresses in memory for a period of time, which minimizes the use of valuable network resources to broadcast for the same address each time a packet is sent. You must maintain the cache entries since the cache entries are set to expire periodically because the information might become outdated. Every switch on a network updates its tables as addresses are broadcast.

Static and Dynamic Entries in the ARP Cache

You must manually configure the IP addresses, subnet masks, gateways, and corresponding MAC addresses for each interface of each switch when using static routes. Static routing enables more control but requires more work to maintain the route table. You must update the table each time you add or change routes.

Dynamic routing uses protocols that enable the switches in a network to exchange routing table information with each other. Dynamic routing is more efficient than static routing because the route table is automatically updated unless you add a time limit to the cache. The default time limit is 25 minutes but you can modify the time limit if the network has many routes that are added and deleted from the cache.

Devices That Do Not Use ARP

When a network is divided into two segments, a bridge joins the segments and filters traffic to each segment based on MAC addresses. The bridge builds its own address table that uses MAC addresses only, as opposed to a switch, which has an ARP cache that contains both IP addresses and the corresponding MAC addresses.

Passive hubs are central-connection switches that physically connect other switches in a network. They send messages out on all their ports to the switches and operate at Layer 1 but do not maintain an address table.

Layer 2 switches determine which port is connected to a device to which the message is addressed and send only to that port, unlike a hub, which sends the message out all of its ports. However, Layer 3 switches are switches that build an ARP cache (table).

Reverse ARP

Reverse ARP (RARP) as defined by RFC 903 works the same way as ARP, except that the RARP request packet requests an IP address instead of a MAC address. RARP often is used by diskless workstations because this type of device has no way to store IP addresses to use when they boot. The only address that is known is the MAC address because it is burned into the hardware.

Use of RARP requires an RARP server on the same network segment as the router interface. The following figure illustrates how RARP works.

Figure 5: Reverse ARP

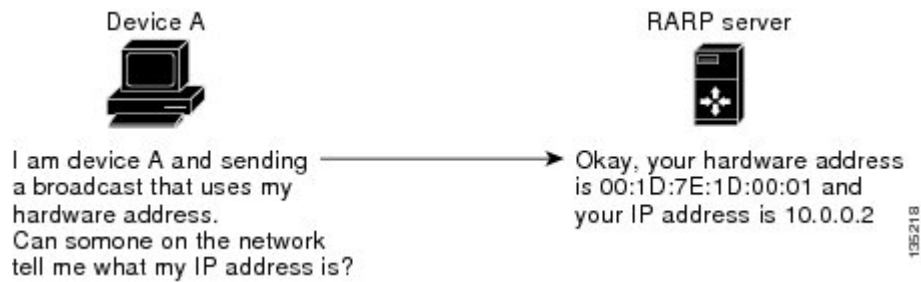

There are several limitations of RARP. Because of these limitations, most businesses use DHCP to assign IP addresses dynamically. DHCP is cost effective and requires less maintenance than RARP. The following are the most important limitations:

- Because RARP uses hardware addresses, if the internetwork is large with many physical networks, a RARP server must be on every segment with an additional server for redundancy. Maintaining two servers for every segment is costly.
- Each server must be configured with a table of static mappings between the hardware addresses and IP addresses. Maintenance of the IP addresses is difficult.
- RARP only provides IP addresses of the hosts and not subnet masks or default gateways.

Proxy ARP

Proxy ARP enables a switch that is physically located on one network appear to be logically part of a different physical network connected to the same switch or firewall. Proxy ARP allows you to hide a switch with a public IP address on a private network behind a router and still have the switch appear to be on the public network in front of the router. By hiding its identity, the router accepts responsibility for routing packets to the real destination. Proxy ARP can help switches on a subnet reach remote subnets without configuring routing or a default gateway.

When switches are not in the same data link layer network but in the same IP network, they try to transmit data to each other as if they are on the local network. However, the router that separates the switches does not send a broadcast message because routers do not pass hardware-layer broadcasts and the addresses cannot be resolved.

When you enable Proxy ARP on the switch and it receives an ARP request, it identifies the request as a request for a system that is not on the local LAN. The switch responds as if it is the remote destination for which the broadcast is addressed, with an ARP response that associates the MAC address of the switch with the IP address of the remote destination. The local switch believes that it is directly connected to the destination, while in reality its packets are being forwarded from the local subnetwork toward the destination subnetwork by their local switch. By default, Proxy ARP is disabled.

Local Proxy ARP

You can use local Proxy ARP to enable a switch to respond to ARP requests for IP addresses within a subnet where normally no routing is required. When you enable local Proxy ARP, ARP responds to all ARP requests for IP addresses within the subnet and forwards all traffic between hosts in the subnet. Use this feature only on subnets where hosts are intentionally prevented from communicating directly by the configuration on the switch to which they are connected.

Gratuitous ARP

Gratuitous ARP sends a request with identical source IP address and destination IP address to detect duplicate IP addresses. Cisco NX-OS supports enabling or disabling gratuitous ARP requests or ARP cache updates.

Glean Throttling

If the Address Resolution Protocol (ARP) request for the next hop is not resolved when incoming IP packets are forwarded in a line card, the line card forwards the packets to the supervisor (glean throttling). The supervisor resolves the MAC address for the next hop and programs the hardware.

When an ARP request is sent, the software adds a /32 drop adjacency in the hardware to prevent the packets to the same next-hop IP address to be forwarded to the supervisor. When the ARP is resolved, the hardware entry is updated with the correct MAC address. If the ARP entry is not resolved before a timeout period, the entry is removed from the hardware.



Note Glean throttling is supported for IPv4 and IPv6, but IPv6 link-local addresses are not supported.

ICMP

You can use ICMP to provide message packets that report errors and other information that is relevant to IP processing. ICMP generates error messages, such as ICMP destination unreachable messages, ICMP Echo Requests (which send a packet on a round trip between two hosts) and Echo Reply messages. ICMP also provides many diagnostic functions and can send and redirect error packets to the host. By default, ICMP is enabled.

Some of the ICMP message types are as follows:

- Network error messages
- Network congestion messages
- Troubleshooting information
- Timeout announcements



Note ICMP redirects are disabled on interfaces where the local proxy ARP feature is enabled.



Note In warp mode, the following features are not supported: IP redirects, Egress Routed Access Control Lists (RACLs), Port Access Control Lists (PACLs), and Equal-cost Multipathing (ECMP).

Virtualization Support

IPv4 supports Virtual Routing and Forwarding instances (VRFs). By default, Cisco NX-OS places you in the default VRF unless you specifically configure another VRF.

Prerequisites for IPv4

IPv4 has the following prerequisites:

- IPv4 can only be configured on Layer 3 interfaces.

Guidelines and Limitations for IPv4

IPv4 has the following configuration guidelines and limitations:

- You can configure a secondary IP address only after you configure the primary IP address.
- The Cisco Nexus 3548 switch does not support per-VLAN cam aging timers.
- Beginning with Cisco NX-OS Release 10.4(2)F, the **ip arp cache intf-limit** configuration is supported to limit the ARP cache entries per interface on Cisco NX-OS devices with the following capabilities:
 - Supported on global and interface modes. However, interface mode configuration takes the precedence over global mode.
 - Supported only on the following L3 interfaces:
 - SVI
 - SVI Unnumbered Interfaces
 - Not supported on the following L3 interfaces:
 - Ethernet
 - Subinterfaces
 - Port-channel
 - Unnumbered interfaces
- If the configuration is applied to non-supporting interfaces, this configuration will be applied to the global mode.

Default Settings for IPv4

Table below lists the default settings for IP parameters.

Table 3: Default IP Parameters

Parameters	Default
ARP timeout	1500 seconds
proxy ARP	disabled

Configuring IPv4



Note If you are familiar with the Cisco IOS CLI, be aware that the Cisco NX-OS commands for this feature might differ from the Cisco IOS commands that you would use.

Configuring IPv4 Addressing

You can assign a primary IP address for a network interface.

SUMMARY STEPS

1. **configure terminal**
2. **interface ethernet number**
3. **no switchport**
4. **ip address ip-address/length [secondary]**
5. (Optional) **show ip interface**
6. (Optional) **copy running-config startup-config**

DETAILED STEPS

Procedure

	Command or Action	Purpose
Step 1	configure terminal Example: <pre>switch# configure terminal switch(config)#</pre>	Enters configuration mode.
Step 2	interface ethernet number Example: <pre>switch(config)# interface ethernet 2/3 switch(config-if)#</pre>	Enters interface configuration mode.

	Command or Action	Purpose
Step 3	no switchport Example: switch(config-if)# no switchport	Configures the interface as a Layer 3 routed interface.
Step 4	ip address ip-address/length [secondary] Example: switch(config-if)# ip address 192.2.1.1 255.0.0.0	Specifies a primary or secondary IPv4 address for an interface. <ul style="list-style-type: none"> • The network mask can be a four-part dotted decimal address. For example, 255.0.0.0 indicates that each bit equal to 1 means the corresponding address bit belongs to the network address. • The network mask can be indicated as a slash (/) and a number - a prefix length. The prefix length is a decimal value that indicates how many of the high-order contiguous bits of the address comprise the prefix (the network portion of the address). A slash must precede the decimal value and there is no space between the IP address and the slash.
Step 5	(Optional) show ip interface Example: switch(config-if)# show ip interface	Displays interfaces configured for IPv4.
Step 6	(Optional) copy running-config startup-config Example: switch(config-if)# copy running-config startup-config	Saves this configuration change.

Example

This example shows how to assign an IPv4 address:

```
switch# configure terminal
switch(config)# interface ethernet 2/3
switch(config-if)# no switchport
switch(config-if)# ip address 192.2.1.1 255.0.0.0
switch(config-if)# copy running-config startup-config
```

Configuring Multiple IP Addresses

You can only add secondary IP addresses after you configure primary IP addresses.

SUMMARY STEPS

1. **configure terminal**
2. **interface ethernet number**
3. **no switchport**

4. **ip address ip-address/length [secondary]**
5. (Optional) **show ip interface**
6. (Optional) **copy running-config startup-config**

DETAILED STEPS

Procedure

	Command or Action	Purpose
Step 1	configure terminal Example: switch# configure terminal switch(config)#	Enters configuration mode.
Step 2	interface ethernet number Example: switch(config)# interface ethernet 2/3 switch(config-if)#	Enters interface configuration mode.
Step 3	no switchport Example: switch(config-if)# no switchport	Configures the interface as a Layer 3 routed interface.
Step 4	ip address ip-address/length [secondary] Example: switch(config-if)# ip address 192.2.1.1 255.0.0.0 secondary	Specifies the configured address as a secondary IPv4 address.
Step 5	(Optional) show ip interface Example: switch(config-if)# show ip interface	Displays interfaces configured for IPv4.
Step 6	(Optional) copy running-config startup-config Example: switch(config-if)# copy running-config startup-config	Saves this configuration change.

Configuring a Static ARP Entry

You can configure a static ARP entry on the switch to map IP addresses to MAC hardware addresses, including static multicast MAC addresses.

SUMMARY STEPS

1. **configure terminal**
2. **interface ethernet number**

3. **no switchport**
4. **ip arp ipaddr mac_addr**
5. (Optional) **copy running-config startup-config**

DETAILED STEPS

Procedure

	Command or Action	Purpose
Step 1	configure terminal Example: switch# configure terminal switch(config)#	Enters configuration mode.
Step 2	interface ethernet number Example: switch(config)# interface ethernet 2/3 switch(config-if)#	Enters interface configuration mode.
Step 3	no switchport Example: switch(config-if)# no switchport	Configures the interface as a Layer 3 routed interface.
Step 4	ip arp ipaddr mac_addr Example: switch(config-if)# ip arp 192.2.1.1 0019.076c.1a78	Associates an IP address with a MAC address as a static entry.
Step 5	(Optional) copy running-config startup-config Example: switch(config-if)# copy running-config startup-config	Saves this configuration change.

Example

This example shows how to configure a static ARP entry:

```
switch# configure terminal
switch(config)# interface ethernet 2/3
switch(config-if)# no switchport
switch(config-if)# ip arp 1 92.2.1.1 0019.076c.1a78
switch(config-if)# copy running-config startup-config
```

Configuring Proxy ARP

You can configure Proxy ARP on the switch to determine the media addresses of hosts on other networks or subnets.

SUMMARY STEPS

1. **configure terminal**
2. **interface ethernet number**
3. **no switchport**
4. **ip proxy-arp**
5. (Optional) **copy running-config startup-config**

DETAILED STEPS**Procedure**

	Command or Action	Purpose
Step 1	configure terminal Example: <pre>switch# configure terminal switch(config)#</pre>	Enters configuration mode.
Step 2	interface ethernet number Example: <pre>switch(config)# interface ethernet 2/3 switch(config-if)#</pre>	Enters interface configuration mode.
Step 3	no switchport Example: <pre>switch(config-if)# no switchport</pre>	Configures the interface as a Layer 3 routed interface.
Step 4	ip proxy-arp Example: <pre>switch(config-if)# ip proxy-arp</pre>	Enables Proxy ARP on the interface.
Step 5	(Optional) copy running-config startup-config Example: <pre>switch(config-if)# copy running-config startup-config</pre>	Saves this configuration change.

Example

This example shows how to configure Proxy ARP:

```
switch# configure terminal
switch(config)# interface ethernet 2/3
switch(config-if)# no switchport
switch(config-if)# ip proxy-arp
switch(config-if)# copy running-config startup-config
```

Configuring Local Proxy ARP

You can configure Local Proxy ARP on the switch.

SUMMARY STEPS

1. **configure terminal**
2. **interface ethernet number**
3. **no switchport**
4. **ip local-proxy-arp**
5. (Optional) **copy running-config startup-config**

DETAILED STEPS

Procedure

	Command or Action	Purpose
Step 1	configure terminal Example: <pre>switch# configure terminal switch(config)#</pre>	Enters configuration mode.
Step 2	interface ethernet number Example: <pre>switch(config)# interface ethernet 2/3 switch(config-if)#</pre>	Enters interface configuration mode.
Step 3	no switchport Example: <pre>switch(config-if)# no switchport</pre>	Configures the interface as a Layer 3 routed interface.
Step 4	ip local-proxy-arp Example: <pre>switch(config-if)# ip local-proxy-arp</pre>	Enables Local Proxy ARP on the interface.
Step 5	(Optional) copy running-config startup-config Example: <pre>switch(config-if)# copy running-config startup-config</pre>	Saves this configuration change.

Example

This example shows how to configure Local Proxy ARP:

```
switch# configure terminal
switch(config)# interface ethernet 2/3
switch(config-if)# no switchport
```

```
switch(config-if)# ip local-proxy-arp
switch(config-if)# copy running-config startup-config
```

Configuring Gratuitous ARP

You can configure gratuitous ARP on an interface.

SUMMARY STEPS

1. **configure terminal**
2. **interface ethernet number**
3. **no switchport**
4. **ip arp gratuitous { request | update }**
5. (Optional) **copy running-config startup-config**

DETAILED STEPS

Procedure

	Command or Action	Purpose
Step 1	configure terminal Example: switch# configure terminal switch(config)#	Enters configuration mode.
Step 2	interface ethernet number Example: switch(config)# interface ethernet 2/3 switch(config-if)#	Enters interface configuration mode.
Step 3	no switchport Example: switch(config-if)# no switchport	Configures the interface as a Layer 3 routed interface.
Step 4	ip arp gratuitous { request update } Example: switch(config-if)# ip arp gratuitous request	Enables gratuitous ARP on the interface. Default is enabled.
Step 5	(Optional) copy running-config startup-config Example: switch(config-if)# copy running-config startup-config	Saves this configuration change.

Example

This example shows how to disable gratuitous ARP requests:

```
switch# configure terminal
switch(config)# interface ethernet 2/3
switch(config-if)# no switchport
switch(config-if)# no ip arp gratuitous request
switch(config-if)# copy running-config startup-config
```

Configuring ARP Cache Limit Per SVI Interface

Beginning from Cisco NX-OS Release 10.4(2)F, you can set the number of maximum ARP cache entries to be allowed per SVI interface on the Cisco NX-OS devices. This configuration is supported on both global and interface modes.

SUMMARY STEPS

1. **configure terminal**
2. **interface vlan *vlan-id***
3. **[no] ip arp cache intf-limit *value***
4. (Optional) **copy running-config startup-config**

DETAILED STEPS

Procedure

	Command or Action	Purpose
Step 1	configure terminal Example: switch# configure terminal switch(config)#	Enters global configuration mode.
Step 2	interface vlan <i>vlan-id</i> Example: switch(config)# interface vlan 5 switch(config-if)#	Creates a VLAN interface and enters the configuration mode for the SVI.
Step 3	[no] ip arp cache intf-limit <i>value</i> Example: switch(config-if)# ip arp cache intf-limit 50000 switch(config-if)#	Configures the set limit of ARP cache entries for the SVI interface. Range of valid ARP entries is 1-128000. intf-limit: Specifies the number of valid dynamic ARP entries per interface. The no form of this command removes the configuration.
Step 4	(Optional) copy running-config startup-config Example: switch(config)# copy running-config startup-config	Saves this configuration change.

Configuring IP Directed Broadcasts

An IP directed broadcast is an IP packet whose destination address is a valid broadcast address for some IP subnet, but which originates from a node that is not itself part of that destination subnet.

A switch that is not directly connected to its destination subnet forwards an IP directed broadcast in the same way it would forward unicast IP packets destined to a host on that subnet. When a directed broadcast packet reaches a switch that is directly connected to its destination subnet, that packet is “exploded” as a broadcast on the destination subnet. The destination address in the IP header of the packet is rewritten to the configured IP broadcast address for the subnet, and the packet is sent as a link-layer broadcast.

If directed broadcast is enabled for an interface, incoming IP packets whose addresses identify them as directed broadcasts intended for the subnet to which that interface is attached will be exploded as broadcasts on that subnet.

To enable IP directed broadcasts, use the following command in interface configuration mode:

Command	Purpose
ip directed-broadcast	Enables the translation of a directed broadcast to physical broadcasts.

Configuring IP Glean Throttling

We recommend that you configure IP glean throttling to filter the unnecessary glean packets that are sent to the supervisor for ARP resolution for the next hops that are not reachable or do not exist. IP glean throttling boosts software performance and helps to manage traffic more efficiently.



Note Glean throttling is supported for IPv4 and IPv6, but IPv6 link-local addresses are not supported.

SUMMARY STEPS

1. **configure terminal**
2. **[no] hardware ip glean throttle**
3. (Optional) **copy running-config startup-config**

DETAILED STEPS

Procedure

	Command or Action	Purpose
Step 1	configure terminal Example: switch# configure terminal switch(config)#	Enters configuration mode.
Step 2	[no] hardware ip glean throttle Example:	Enables IP glean throttling.

	Command or Action	Purpose
	<code>switch(config) # hardware ip glean throttle</code>	
Step 3	(Optional) copy running-config startup-config Example: <code>switch(config) # copy running-config startup-config</code>	Saves this configuration change.

Configuring the Hardware IP Glean Throttle Maximum

You can limit the maximum number of drop adjacencies that are installed in the Forwarding Information Base (FIB).

SUMMARY STEPS

1. **configure terminal**
2. **hardware ip glean throttle maximum count**
3. **no hardware ip glean throttle maximum count**
4. (Optional) **copy running-config startup-config**

DETAILED STEPS

Procedure

	Command or Action	Purpose
Step 1	configure terminal Example: <code>switch# configure terminal</code> <code>switch(config) #</code>	Enters configuration mode.
Step 2	hardware ip glean throttle maximum count Example: <code>switch(config) # hardware ip glean throttle maximum 2134</code>	Configures the number of drop adjacencies that are installed in the FIB.
Step 3	no hardware ip glean throttle maximum count Example: <code>switch(config) # no hardware ip glean throttle maximum 2134</code>	Applies the default limits. The default value is 1000. The range is from 0 to 16,383 entries.
Step 4	(Optional) copy running-config startup-config Example: <code>switch(config) # copy running-config startup-config</code>	Saves this configuration change.

Example

This example shows how to limit the maximum number of drop adjacencies that are installed in the FIB:

```
switch# configure terminal
switch(config)# hardware ip glean throttle maximum 2134
switch(config-if)# copy running-config startup-config
```

Configuring a Hardware IP Glean Throttle Timeout

You can configure a timeout for the installed drop adjacencies to remain in the FIB

SUMMARY STEPS

1. **configure terminal**
2. **hardware ip glean throttle maximum timeout timeout-in-sec**
3. **no hardware ip glean throttle maximum timeout timeout-in-sec**
4. (Optional) **copy running-config startup-config**

DETAILED STEPS

Procedure

	Command or Action	Purpose
Step 1	configure terminal Example: <pre>switch# configure terminal switch(config)#</pre>	Enters configuration mode.
Step 2	hardware ip glean throttle maximum timeout timeout-in-sec Example: <pre>switch(config)# hardware ip glean throttle maximum timeout 300</pre>	Configures the timeout for the installed drop adjacencies to remain in the FIB.
Step 3	no hardware ip glean throttle maximum timeout timeout-in-sec Example: <pre>switch(config)# no hardware ip glean throttle maximum timeout 300</pre>	Applies the default limits. The timeout value is in seconds. The range is from 300 seconds (5 minutes) to 1800 seconds (30 minutes). Note After the timeout period is exceeded, the drop adjacencies are removed from the FIB.
Step 4	(Optional) copy running-config startup-config Example: <pre>switch(config)# copy running-config startup-config</pre>	Saves this configuration change.

Example

This example shows how to configure a timeout for the drop adjacencies that are installed.

```
switch# configure terminal
switch(config)# hardware ip glean throttle maximum timeout 300
switch(config-if)# copy running-config startup-config
```

Configuring the Hardware IP Glean Throttle Syslog

You can generate a syslog if the number of packets that get dropped for a specific flow exceeds the configured packet count.

SUMMARY STEPS

1. **configure terminal**
2. **hardware ip glean throttle syslog pck-count**
3. **no hardware ip glean throttle syslog pck-count**
4. (Optional) **copy running-config startup-config**

DETAILED STEPS**Procedure**

	Command or Action	Purpose
Step 1	configure terminal Example: <pre>switch# configure terminal switch(config)#</pre>	Enters configuration mode.
Step 2	hardware ip glean throttle syslog pck-count Example: <pre>switch(config)# hardware ip glean throttle syslog 1030</pre>	Generates a syslog if the number of packets that get dropped for a specific flow exceed the configured packet count.
Step 3	no hardware ip glean throttle syslog pck-count Example: <pre>switch(config)# no hardware ip glean throttle syslog 1030</pre>	Applies the default limits. The default is 10000 packets. The range is from 0 to 65535 packets. Note After the timeout period is exceeded, the drop adjacencies are removed from the FIB.
Step 4	(Optional) copy running-config startup-config Example: <pre>switch(config)# copy running-config startup-config</pre>	Saves this configuration change.

Example

This example shows how to generate a syslog if the number of packets that get dropped for a specific flow exceeds the configured packet count:

```
switch# configure terminal
switch(config)# hardware ip glean throttle syslog 1030
switch(config-if)# copy running-config startup-config
```

Verifying the IPv4 Configuration

To display the IPv4 configuration, perform one of the following tasks:

Command	Purpose
show hardware forwarding ip verify	Displays the IP packet verification configuration.
show ip adjacency	Displays the adjacency table.
show ip arp	Displays the ARP table.
show ip interface	Displays IP-related interface information.
show ip arp statistics [vrf vrf-name]	Displays the ARP statistics.
show ip adjacency summary	Displays the summary of number of throttle adjacencies.
show ip arp summary	Displays the summary of the number of throttle adjacencies.
show ip adjacency throttle statistics	Displays only the throttled adjacencies.

Configuration Examples for IPv4

This example shows how to configure an IPv4 address:

```
configure terminal
interface ethernet 1/2
no switchport
ip address 192.2.1.1/16
```

Additional References

For additional information related to implementing IP, see the following sections:

- [Related Documents](#)
- [Standards](#)

Related Documents

Related Topic	Document Title
IP CLI commands	Cisco Nexus 3000 Series Unicast Routing Command Reference

Standards

Standards	Title
No new or modified standards are supported by this feature, and support for existing standards has not been modified by this feature.	—



CHAPTER 4

Configuring OSPFv2

This chapter describes how to configure Open Shortest Path First version 2 (OSPFv2) for IPv4 networks on Cisco NX-OS switches.

This chapter includes the following sections:

- [Information About OSPFv2, on page 37](#)
- [Prerequisites for OSPFv2, on page 46](#)
- [Guidelines and Limitations for OSPFv2, on page 47](#)
- [Default Settings for OSPFv2, on page 47](#)
- [Configuring Basic OSPFv2, on page 48](#)
- [Configuring Advanced OSPFv2, on page 58](#)
- [Verifying the OSPFv2 Configuration, on page 77](#)
- [Displaying OSPFv2 Statistics, on page 78](#)
- [Configuration Examples for OSPFv2, on page 78](#)
- [Additional References, on page 78](#)

Information About OSPFv2

OSPFv2 is an IETF link-state protocol (see the [Link-State Protocols](#) section) for IPv4 networks. An OSPFv2 router sends a special message, called a hello packet, out each OSPF-enabled interface to discover other OSPFv2 neighbor routers. Once a neighbor is discovered, the two routers compare information in the hello packet to determine if the routers have compatible configurations. The neighbor routers attempt to establish adjacency, which means that the routers synchronize their link-state databases to ensure that they have identical OSPFv2 routing information. Adjacent routers share link-state advertisements (LSAs) that include information about the operational state of each link, the cost of the link, and any other neighbor information. The routers then flood these received LSAs out every OSPF-enabled interface so that all OSPFv2 routers eventually have identical link-state databases. When all OSPFv2 routers have identical link-state databases, the network is converged (see the [Convergence](#) section). Each router then uses Dijkstra's Shortest Path First (SPF) algorithm to build its route table.

You can divide OSPFv2 networks into areas. Routers send most LSAs only within one area, which reduces the CPU and memory requirements for an OSPF-enabled router.

OSPFv2 supports IPv4.

Hello Packet

OSPFv2 routers periodically send hello packets on every OSPF-enabled interface. The hello interval determines how frequently the router sends these hello packets and is configured per interface. OSPFv2 uses hello packets for the following tasks:

- Neighbor discovery
- Keepalives
- Designated router election (see the [Designated Routers](#) section)

The hello packet contains information about the originating OSPFv2 interface and router, including the assigned OSPFv2 cost of the link, the hello interval, and optional capabilities of the originating router. An OSPFv2 interface that receives these hello packets determines if the settings are compatible with the receiving interface settings. Compatible interfaces are considered neighbors and are added to the neighbor table (see the [Neighbors](#) section).

Hello packets also include a list of router IDs for the routers that the originating interface has communicated with. If the receiving interface sees its own router ID in this list, then bidirectional communication has been established between the two interfaces.

OSPFv2 uses hello packets as a keepalive message to determine if a neighbor is still communicating. If a router does not receive a hello packet by the configured dead interval (usually a multiple of the hello interval), then the neighbor is removed from the local neighbor table.

Neighbors

An OSPFv2 interface must have a compatible configuration with a remote interface before the two can be considered neighbors. The two OSPFv2 interfaces must match the following criteria:

- Hello interval
- Dead interval
- Area ID (see the [Areas](#) section)
- Authentication
- Optional capabilities

If there is a match, the following information is entered into the neighbor table:

- Neighbor ID—The router ID of the neighbor.
- Priority—Priority of the neighbor. The priority is used for designated router election (see the [Designated Routers](#) section).
- State—Indication of whether the neighbor has just been heard from, is in the process of setting up bidirectional communications, is sharing the link-state information, or has achieved full adjacency.
- Dead time—Indication of the time since the last Hello packet was received from this neighbor.
- IP Address—The IP address of the neighbor.
- Designated Router—Indication of whether the neighbor has been declared as the designated router or as the backup designated router (see the [Designated Routers](#) section).

- Local interface—The local interface that received the hello packet for this neighbor.

Adjacency

Not all neighbors establish adjacency. Depending on the network type and designated router establishment, some neighbors become fully adjacent and share LSAs with all their neighbors, while other neighbors do not. For more information, see the [Designated Routers](#) section.

Adjacency is established using Database Description packets, Link State Request packets, and Link State Update packets in OSPF. The Database Description packet includes only the LSA headers from the link-state database of the neighbor (see the [Link-State Database](#) section). The local router compares these headers with its own link-state database and determines which LSAs are new or updated. The local router sends a Link State Request packet for each LSA that it needs new or updated information on. The neighbor responds with a Link State Update packet. This exchange continues until both routers have the same link-state information.

Designated Routers

Networks with multiple routers present a unique situation for OSPF. If every router floods the network with LSAs, the same link-state information will be sent from multiple sources. Depending on the type of network, OSPFv2 might use a single router, the designated router (DR), to control the LSA floods and represent the network to the rest of the OSPFv2 area (see the [Areas](#) section). If the DR fails, OSPFv2 selects a backup designated router (BDR). If the DR fails, OSPFv2 uses the BDR.

Network types are as follows:

- Point-to-point—A network that exists only between two routers. All neighbors on a point-to-point network establish adjacency and there is no DR.
- Broadcast—A network with multiple routers that can communicate over a shared medium that allows broadcast traffic, such as Ethernet. OSPFv2 routers establish a DR and BDR that controls LSA flooding on the network. OSPFv2 uses a MAC address of 0100.5300.0005 to communicate with neighbors.

The DR and BDR are selected based on the information in the Hello packet. When an interface sends a Hello packet, it sets the priority field and the DR and BDR field if it knows who the DR and BDR are. The routers follow an election procedure based on which routers declare themselves in the DR and BDR fields and the priority field in the Hello packet. As a final tie breaker, OSPFv2 chooses the highest router IDs as the DR and BDR.

All other routers establish adjacency with the DR. The following figure shows this adjacency relationship between all routers and the DR.

DRs are based on a router interface. A router might be the DR for one network and not for another network on a different interface.

Figure 6: DR in Multi-Access Network

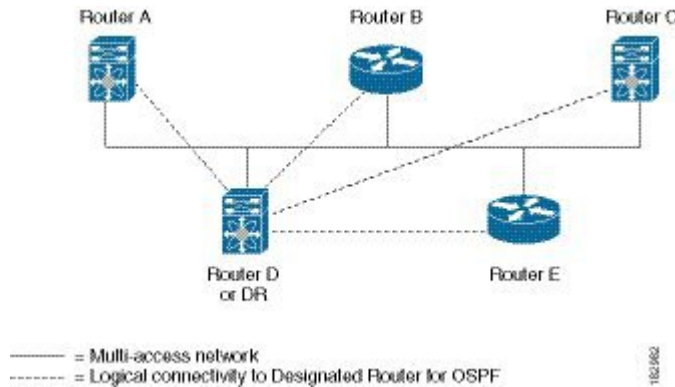

Areas

You can limit the CPU and memory requirements that OSPFv2 puts on the routers by dividing an OSPFv2 network into areas. An area is a logical division of routers and links within an OSPFv2 domain that creates separate subdomains. LSA flooding is contained within an area, and the link-state database is limited to links within the area. You can assign an area ID to the interfaces within the defined area. The Area ID is a 32-bit value that you can enter as a number or in dotted decimal notation, such as 10.2.3.1.

Cisco NX-OS always displays the area in dotted decimal notation.

If you define more than one area in an OSPFv2 network, you must also define the backbone area, which has the reserved area ID of 0. If you have more than one area, then one or more routers become area border routers (ABRs). An ABR connects to both the backbone area and at least one other defined area (see Figure below).

Figure 7: OSPFv2 Areas

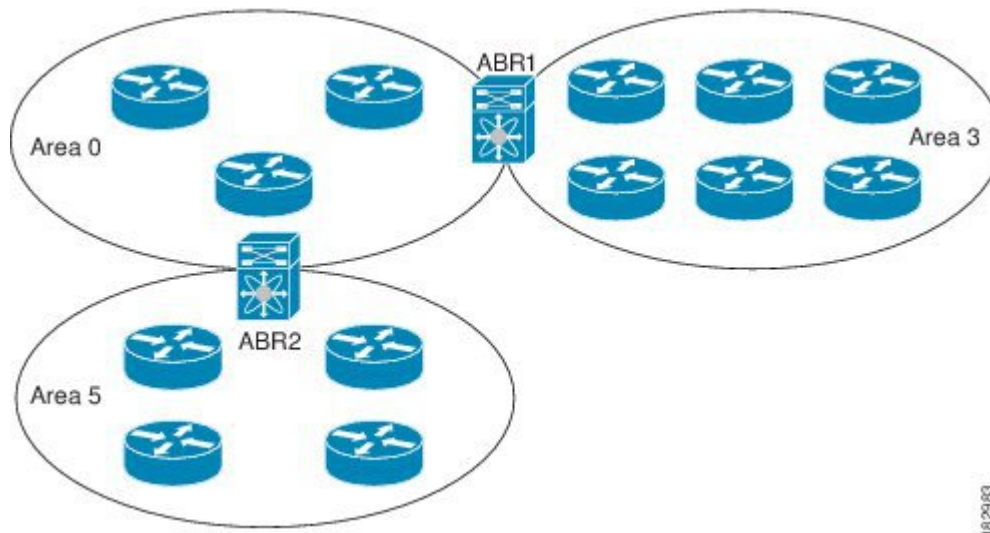

The ABR has a separate link-state database for each area to which it connects. The ABR sends Network Summary (type 3) LSAs (see the [Route Summarization](#) section) from one connected area to the backbone area. The backbone area sends summarized information about one area to another area. In the figure **OSPFv2 Areas**, Area 0 sends summarized information about Area 5 to Area 3.

OSPFv2 defines one other router type: the autonomous system boundary router (ASBR). This router connects an OSPFv2 area to another autonomous system. An autonomous system is a network controlled by a single technical administration entity. OSPFv2 can redistribute its routing information into another autonomous system or receive redistributed routes from another autonomous system. For more information, see the [Advanced Features](#) section).

Link-State Advertisements

OSPFv2 uses link-state advertisements (LSAs) to build its routing table.

LSA Types

Table below shows the LSA types supported by Cisco NX-OS.

Table 4: LSA Types

Type	Name	Description
1	Router LSA	LSA sent by every router. This LSA includes the state and the cost of all links and a list of all OSPFv2 neighbors on the link. Router LSAs trigger an SPF recalculation. Router LSAs are flooded to local OSPFv2 area.
2	Network LSA	LSA sent by the DR. This LSA lists all routers in the multi-access network. Network LSAs trigger an SPF recalculation. See the Designated Routers section.
3	Network Summary LSA	LSA sent by the area border router to an external area for each destination in the local area. This LSA includes the link cost from the area border router to the local destination. See the Areas section.
4	ASBR Summary LSA	LSA sent by the area border router to an external area. This LSA advertises the link cost to the ASBR only. See the Areas section.
5	AS External LSA	LSA generated by the ASBR. This LSA includes the link cost to an external autonomous system destination. AS External LSAs are flooded throughout the autonomous system. See the Areas section.
7	NSSA External LSA	LSA generated by the ASBR within a not-so-stubby area (NSSA). This LSA includes the link cost to an external autonomous system destination. NSSA External LSAs are flooded only within the local NSSA. See the Areas section.

Type	Name	Description
9–11	Opaque LSAs	LSA used to extend OSPF. See the Opaque LSAs section.

Link Cost

Each OSPFv2 interface is assigned a link cost. The cost is an arbitrary number. By default, Cisco NX-OS assigns a cost that is the configured reference bandwidth divided by the interface bandwidth. By default, the reference bandwidth is 40 Gb/s. The link cost is carried in the LSA updates for each link.

Flooding and LSA Group Pacing

When an OSPFv2 router receives an LSA, it forwards that LSA out every OSPF-enabled interface, flooding the OSPFv2 area with this information. This LSA flooding guarantees that all routers in the network have identical routing information. LSA flooding depends on the OSPFv2 area configuration (see the [Areas](#) section). The LSAs are flooded based on the link-state refresh time (every 30 minutes by default). Each LSA has its own link-state refresh time.

You can control the flooding rate of LSA updates in your network by using the LSA group pacing feature. LSA group pacing can reduce high CPU or buffer utilization. This feature groups LSAs with similar link-state refresh times to allow OSPFv2 to pack multiple LSAs into an OSPFv2 Update message.

By default, LSAs with link-state refresh times within four minutes of each other are grouped together. You should lower this value for large link-state databases or raise it for smaller databases to optimize the OSPFv2 load on your network.

Link-State Database

Each router maintains a link-state database for the OSPFv2 network. This database contains all the collected LSAs, and includes information on all the routes through the network. OSPFv2 uses this information to calculate the best path to each destination and populates the routing table with these best paths.

LSAs are removed from the link-state database if no LSA update has been received within a set interval, called the MaxAge. Routers flood a repeat of the LSA every 30 minutes to prevent accurate link-state information from being aged out. Cisco NX-OS supports the LSA grouping feature to prevent all LSAs from refreshing at the same time. For more information, see the [Flooding and LSA Group Pacing](#) section.

Opaque LSAs

Opaque LSAs allow you to extend OSPF functionality. Opaque LSAs consist of a standard LSA header followed by application-specific information. This information might be used by OSPFv2 or by other applications. Three Opaque LSA types are defined as follows:

- LSA type 9—Flooded to the local network.
- LSA type 10—Flooded to the local area.
- LSA type 11—Flooded to the local autonomous system.

OSPFv2 and the Unicast RIB

OSPFv2 runs the Dijkstra shortest path first algorithm on the link-state database. This algorithm selects the best path to each destination based on the sum of all the link costs for each link in the path. The resultant shortest path for each destination is then put in the OSPFv2 route table. When the OSPFv2 network is converged, this route table feeds into the unicast RIB. OSPFv2 communicates with the unicast RIB to do the following:

- Add or remove routes
- Handle route redistribution from other protocols
- Provide convergence updates to remove stale OSPFv2 routes and for stub router advertisements (see the [OSPFv2 Stub Router Advertisements](#) section).

OSPFv2 also runs a modified Dijkstra algorithm for fast recalculation for summary and external (type 3, 4, 5, and 7) LSA changes.

Authentication

You can configure authentication on OSPFv2 messages to prevent unauthorized or invalid routing updates in your network. Cisco NX-OS supports two authentication methods:

- Simple password authentication
- MD5 authentication digest

You can configure the OSPFv2 authentication for an OSPFv2 area or per interface.

Simple Password Authentication

Simple password authentication uses a simple clear-text password that is sent as part of the OSPFv2 message. The receiving OSPFv2 router must be configured with the same clear-text password to accept the OSPFv2 message as a valid route update. Because the password is in clear text, anyone who can watch traffic on the network can learn the password.

MD5 Authentication

You should use MD5 authentication to authenticate OSPFv2 messages. You configure a password that is shared at the local router and all remote OSPFv2 neighbors. For each OSPFv2 message, Cisco NX-OS creates an MD5 one-way message digest based on the message itself and the encrypted password. The interface sends this digest with the OSPFv2 message. The receiving OSPFv2 neighbor validates the digest using the same encrypted password. If the message has not changed, the digest calculation is identical and the OSPFv2 message is considered valid.

MD5 authentication includes a sequence number with each OSPFv2 message to ensure that no message is replayed in the network.

Advanced Features

Cisco NX-OS supports a number of advanced OSPFv2 features that enhance the usability and scalability of OSPFv2 in the network.

Stub Area

You can limit the amount of external routing information that floods an area by making it a stub area. A stub area is an area that does not allow AS External (type 5) LSAs (see the [Link-State Advertisements](#) section). These LSAs are usually flooded throughout the local autonomous system to propagate external route information. Stub areas have the following requirements:

- All routers in the stub area are stub routers. See the [Stub Routing](#) section.
- No ASBR routers exist in the stub area.
- You cannot configure virtual links in the stub area.

The following figure shows an example of an OSPFv2 autonomous system where all routers in area 0.0.0.10 have to go through the ABR to reach external autonomous systems. area 0.0.0.10 can be configured as a stub area.

Figure 8: Stub Area

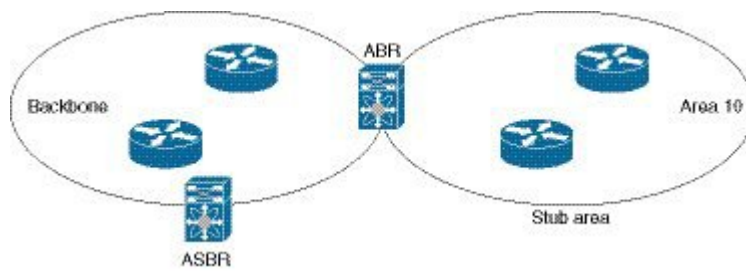

Stub areas use a default route for all traffic that needs to go through the backbone area to the external autonomous system. The default route is 0.0.0.0 for IPv4.

Not-So-Stubby Area

A Not-so-Stubby Area (NSSA) is similar to a stub area, except that an NSSA allows you to import autonomous system external routes within an NSSA using redistribution. The NSSA ASBR redistributes these routes and generates NSSA External (type 7) LSAs that it floods throughout the NSSA. You can optionally configure the ABR that connects the NSSA to other areas to translate this NSSA External LSA to AS External (type 5) LSAs. The area border router (ABR) then floods these AS External LSAs throughout the OSPFv2 autonomous system. Summarization and filtering are supported during the translation. See the [Link-State Advertisements](#) section for details on NSSA External LSAs.

You can, for example, use NSSA to simplify administration if you are connecting a central site using OSPFv2 to a remote site that is using a different routing protocol. Before NSSA, the connection between the corporate site border router and a remote router could not be run as an OSPFv2 stub area because routes for the remote site could not be redistributed into a stub area. With NSSA, you can extend OSPFv2 to cover the remote connection by defining the area between the corporate router and remote router as an NSSA (see the [Configuring NSSA](#) section).

The backbone Area 0 cannot be an NSSA.

Virtual Links

Virtual links allow you to connect an OSPFv2 area ABR to a backbone area ABR when a direct physical connection is not available. The following figure shows a virtual link that connects Area 3 to the backbone area through Area 5.

Figure 9: Virtual Links

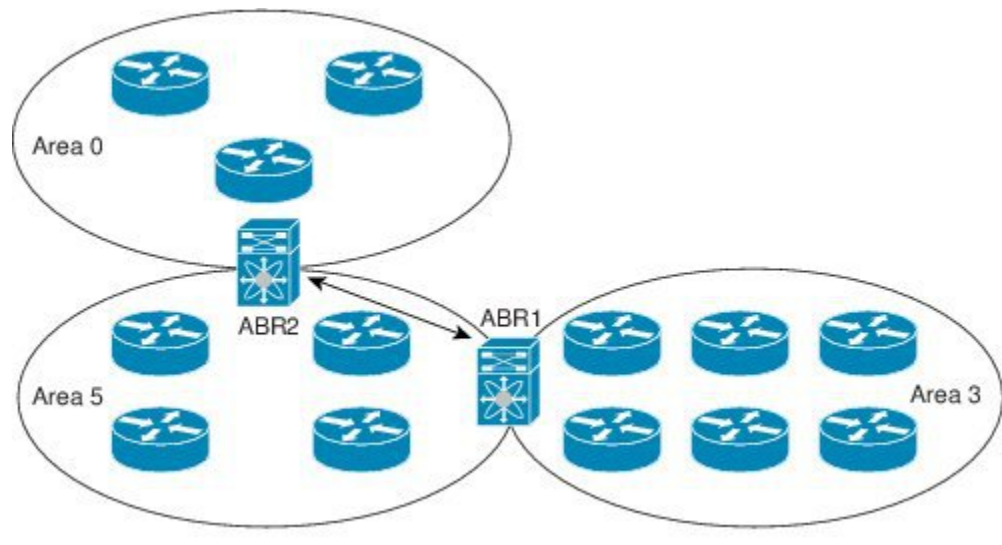

You can also use virtual links to temporarily recover from a partitioned area, which occurs when a link within the area fails, isolating part of the area from reaching the designated ABR to the backbone area.

Route Redistribution

OSPFv2 can learn routes from other routing protocols by using route redistribution. See the [Route Redistribution](#) section. You configure OSPFv2 to assign a link cost for these redistributed routes or a default link cost for all redistributed routes.

Route redistribution uses route maps to control which external routes are redistributed. See [Configuring Route Policy Manager](#), for details on configuring route maps. You can use route maps to modify parameters in the AS External (type 5) and NSSA External (type 7) LSAs before these external routes are advertised in the local OSPFv2 autonomous system.

Route Summarization

Because OSPFv2 shares all learned routes with every OSPF-enabled router, you might want to use route summarization to reduce the number of unique routes that are flooded to every OSPF-enabled router. Route summarization simplifies route tables by replacing more-specific addresses with an address that represents all the specific addresses. For example, you can replace 10.1.1.0/24, 10.1.2.0/24, and 10.1.3.0/24 with one summary address, 10.1.0.0/16.

Typically, you would summarize at the boundaries of area border routers (ABRs). Although you could configure summarization between any two areas, it is better to summarize in the direction of the backbone so that the backbone receives all the aggregate addresses and injects them, already summarized, into other areas. The two types of summarization are as follows:

- Inter-area route summarization
- External route summarization

You configure inter-area route summarization on ABRs, summarizing routes between areas in the autonomous system. To take advantage of summarization, you should assign network numbers in areas in a contiguous way to be able to lump these addresses into one range.

External route summarization is specific to external routes that are injected into OSPFv2 using route redistribution. You should make sure that external ranges that are being summarized are contiguous. Summarizing overlapping ranges from two different routers could cause packets to be sent to the wrong destination. Configure external route summarization on ASBRs that are redistributing routes into OSPF.

When you configure a summary address, Cisco NX-OS automatically configures a discard route for the summary address to prevent routing black holes and route loops.

OSPFv2 Stub Router Advertisements

You can configure an OSPFv2 interface to act as a stub router using the OSPFv2 stub router advertisements feature. Use this feature when you want to limit the OSPFv2 traffic through this router, such as when you want to introduce a new router to the network in a controlled manner or limit the load on a router that is already overloaded. You might also want to use this feature for various administrative or traffic engineering reasons.

OSPFv2 stub router advertisements do not remove the OSPFv2 router from the network topology, but they do prevent other OSPFv2 routers from using this router to route traffic to other parts of the network. Only the traffic that is destined for this router or directly connected to this router is sent.

OSPFv2 stub router advertisements mark all stub links (directly connected to the local router) to the cost of the local OSPFv2 interface. All remote links are marked with the maximum cost (0xFFFF).

Multiple OSPFv2 Instances

Cisco NX-OS supports multiple instances of the OSPFv2 protocol that run on the same node. You cannot configure multiple instances over the same interface. By default, every instance uses the same system router ID. You must manually configure the router ID for each instance if the instances are in the same OSPFv2 autonomous system.

SPF Optimization

Cisco NX-OS optimizes the SPF algorithm in the following ways:

- Partial SPF for Network (type 2) LSAs, Network Summary (type 3) LSAs, and AS External (type 5) LSAs—When there is a change on any of these LSAs, Cisco NX-OS performs a faster partial calculation rather than running the whole SPF calculation.
- SPF timers—You can configure different timers for controlling SPF calculations. These timers include exponential backoff for subsequent SPF calculations. The exponential backoff limits the CPU load of multiple SPF calculations.

Virtualization Support

OSPFv2 supports Virtual Routing and Forwarding (VRF) instances. By default, Cisco NX-OS places you in the default VRF unless you specifically configure another VRF. Each OSPFv2 instance can support multiple VRFs, up to the system limit.

Prerequisites for OSPFv2

OSPFv2 has the following prerequisites:

- You must be familiar with routing fundamentals to configure OSPF.

- You are logged on to the switch.
- You have configured at least one interface for IPv4 that is capable of communicating with a remote OSPFv2 neighbor.
- You have installed the LAN Base Services license.
- You have completed the OSPFv2 network strategy and planning for your network. For example, you must decide whether multiple areas are required.
- You have enabled the OSPF feature (see the [Enabling the OSPFv2 Feature](#) section).

Guidelines and Limitations for OSPFv2

OSPFv2 has the following configuration guidelines and limitations:

- Cisco NX-OS displays areas in dotted decimal notation regardless of whether you enter the area in decimal or dotted decimal notation.



Note If you are familiar with the Cisco IOS CLI, be aware that the Cisco NX-OS commands for this feature might differ from the Cisco IOS commands that you would use.

Default Settings for OSPFv2

Table below lists the default settings for OSPFv2 parameters.

Table 5: Default OSPFv2 Parameters

Parameters	Default
Hello interval	10 seconds
Dead interval	40 seconds
OSPFv2 feature	Disabled
Stub router advertisement announce time	600 seconds
Reference bandwidth for link cost calculation	40 Gb/s
LSA minimal arrival time	1000 milliseconds
LSA group pacing	240 seconds
SPF calculation initial delay time	200 milliseconds
SPF calculation minimum hold time	1000 milliseconds

Parameters	Default
SPF calculation maximum wait time	5000 milliseconds

Configuring Basic OSPFv2

Configure OSPFv2 after you have designed your OSPFv2 network.

Enabling the OSPFv2 Feature

You must enable the OSPFv2 feature before you can configure OSPFv2.

SUMMARY STEPS

1. **configure terminal**
2. **[no] feature ospf**
3. (Optional) **show feature**
4. (Optional) **copy running-config startup-config**

DETAILED STEPS

Procedure

	Command or Action	Purpose
Step 1	configure terminal Example: switch# configure terminal switch(config)#	Enters configuration mode.
Step 2	[no] feature ospf Example: switch(config)# feature ospf	Enables the OSPFv2 feature. Note Use the no version of this command to disable OSPFv2 and remove all associated configurations.
Step 3	(Optional) show feature Example: switch(config)# show feature	Displays enabled and disabled features.
Step 4	(Optional) copy running-config startup-config Example: switch(config)# copy running-config startup-config	Saves this configuration change.

Creating an OSPFv2 Instance

The first step in configuring OSPFv2 is to create an OSPFv2 instance. You assign a unique instance tag for this OSPFv2 instance. The instance tag can be any string.

For more information about OSPFv2 instance parameters, see the [Configuring Advanced OSPFv2](#) section.

Before you begin

Ensure that you have enabled the OSPF feature (see the [Enabling the OSPFv2 Feature](#) section).

Use the **show ip ospf instance-tag** command to verify that the instance tag is not in use.

OSPFv2 must be able to obtain a router identifier (for example, a configured loopback address) or you must configure the router ID option.

SUMMARY STEPS

1. **configure terminal**
2. **router ospf instance-tag**
3. (Optional) **router-id ip-address**
4. (Optional) **show ip ospf instance-tag**
5. (Optional) **copy running-config startup-config**

DETAILED STEPS

Procedure

	Command or Action	Purpose
Step 1	configure terminal Example: switch# configure terminal switch(config)#	Enters configuration mode.
Step 2	router ospf instance-tag Example: switch(config)# router ospf 201 switch(config-router)#	Creates a new OSPFv2 instance with the configured instance tag.
Step 3	(Optional) router-id ip-address Example: switch(config-router)# router-id 192.0.2.1	Configures the OSPFv2 router ID. This IP address identifies this OSPFv2 instance and must exist on a configured interface in the system.
Step 4	(Optional) show ip ospf instance-tag Example: switch(config-router)# show ip ospf 201	Displays OSPF information.
Step 5	(Optional) copy running-config startup-config Example:	Saves this configuration change.

Command or Action	Purpose
<code>switch(config)# copy running-config startup-config</code>	

Example

Use the **no router ospf** command to remove the OSPFv2 instance and all associated configurations.

Command	Purpose
no router ospf <i>instance-tag</i> Example: <code>switch(config)# no router ospf 201</code>	Deletes the OSPF instance and the associated configurations.



Note This command does not remove OSPF configuration in interface mode. You must manually remove any OSPFv2 commands configured in interface mode.

Configuring Optional Parameters on an OSPFv2 Instance

You can configure optional parameters for OSPF.

For more information about OSPFv2 instance parameters, see the [Configuring Advanced OSPFv2](#) section.

Before you begin

Ensure that you have enabled the OSPF feature. See the [Enabling the OSPFv2 Feature](#) section.

OSPFv2 must be able to obtain a router identifier (for example, a configured loopback address) or you must configure the router ID option.

SUMMARY STEPS

1. **distance** *number*
2. **log-adjacency-changes** [**detail**]
3. **maximum-paths** *path-number*

DETAILED STEPS

Procedure

Command or Action	Purpose
Step 1 distance <i>number</i> Example: <code>switch(config-router)# distance 25</code>	Configures the administrative distance for this OSPFv2 instance. The range is from 1 to 255. The default is 110.

	Command or Action	Purpose
Step 2	log-adjacency-changes [detail] Example: switch(config-router)# log-adjacency-changes	Generates a system message whenever a neighbor changes state.
Step 3	maximum-paths <i>path-number</i> Example: switch(config-router)# maximum-paths 4	Configures the maximum number of equal OSPFv2 paths to a destination in the route table. This command is used for load balancing. The range is from 1 to 32. The default is 8.

Example

This example shows how to create an OSPFv2 instance:

```
switch# configure terminal
switch(config)# router ospf 201
switch(config-router)# copy running-config startup-config
```

Configuring Networks in OSPFv2

You can configure a network to OSPFv2 by associating it through the interface that the router uses to connect to that network (see the [Neighbors](#) section). You can add all networks to the default backbone area (Area 0), or you can create new areas using any decimal number or an IP address.



Note All areas must connect to the backbone area either directly or through a virtual link.



Note OSPF is not enabled on an interface until you configure a valid IP address for that interface.

Before you begin

Ensure that you have enabled the OSPF feature (see the [Enabling the OSPFv2 Feature](#) section).

SUMMARY STEPS

1. **configure terminal**
2. **interface** *interface-type slot/port*
3. **no switchport**
4. **ip address** *ip-prefix/length*
5. **ip router ospf** *instance-tag area area-id* [**secondaries none**]
6. (Optional) **show ip ospf** *instance-tag interface interface-type slot/port*
7. (Optional) **copy running-config startup-config**

DETAILED STEPS

Procedure

	Command or Action	Purpose
Step 1	configure terminal Example: switch# configure terminal switch(config)#	Enters configuration mode.
Step 2	interface interface-type slot/port Example: switch(config)# interface ethernet 1/2 switch(config-if)#	Enters interface configuration mode.
Step 3	no switchport Example: switch(config-if)# no switchport	Configures the interface as a Layer 3 routed interface.
Step 4	ip address ip-prefix/length Example: switch(config-if)# ip address 192.0.2.1/16	Assigns an IP address and subnet mask to this interface.
Step 5	ip router ospf instance-tag area area-id [secondaries none] Example: switch(config-if)# ip router ospf 201 area 0.0.0.15	Adds the interface to the OSPFv2 instance and area.
Step 6	(Optional) show ip ospf instance-tag interface interface-type slot/port Example: switch(config-if)# show ip ospf 201 interface ethernet 1/2	Displays OSPF information.
Step 7	(Optional) copy running-config startup-config Example: switch(config)# copy running-config startup-config	Saves this configuration change.

Example

You can configure the following optional parameters for OSPFv2 in interface configuration mode:

Command	Purpose
ip ospf cost <i>number</i> Example: <pre>switch(config-if)# ip ospf cost 25</pre>	Configures the OSPFv2 cost metric for this interface. The default is to calculate cost metric, based on reference bandwidth and interface bandwidth. The range is from 1 to 65535.
ip ospf dead-interval <i>seconds</i> Example: <pre>switch(config-if)# ip ospf dead-interval 50</pre>	Configures the OSPFv2 dead interval, in seconds. The range is from 1 to 65535. The default is four times the hello interval, in seconds.
ip ospf hello-interval <i>seconds</i> Example: <pre>switch(config-if)# ip ospf hello-interval 25</pre>	Configures the OSPFv2 hello interval, in seconds. The range is from 1 to 65535. The default is 10 seconds.
ip ospf mtu-ignore Example: <pre>switch(config-if)# ip ospf mtu-ignore</pre>	Configures OSPFv2 to ignore any IP MTU mismatch with a neighbor. The default is to not establish adjacency if the neighbor MTU does not match the local interface MTU.
ip ospf passive-interface Example: <pre>switch(config-if)# ip ospf passive-interface</pre>	Suppresses routing updates on the interface.
ip ospf priority <i>number</i> Example: <pre>switch(config-if)# ip ospf priority 25</pre>	Configures the OSPFv2 priority, used to determine the DR for an area. The range is from 0 to 255. The default is 1. See the Designated Routers section.
ip ospf shutdown Example: <pre>switch(config-if)# ip ospf shutdown</pre>	Shuts down the OSPFv2 instance on this interface.

This example shows how to add a network area 0.0.0.10 in OSPFv2 instance 201:

```
switch# configure terminal
switch(config)# interface ethernet 1/2
switch(config-if)# no switchport
switch(config-if)# ip address 192.0.2.1/16
switch(config-if)# ip router ospf 201 area 0.0.0.10
switch(config-if)# copy running-config startup-config
```

Use the **show ip ospf interface** command to verify the interface configuration. Use the **show ip ospf neighbor** command to see the neighbors for this interface.

Configuring Authentication for an Area

You can configure authentication for all networks in an area or for individual interfaces in the area. Interface authentication configuration overrides area authentication.

Before you begin

Ensure that you have enabled the OSPF feature (see the [Enabling the OSPFv2 Feature](#) section).

Ensure that all neighbors on an interface share the same authentication configuration, including the shared authentication key.

Create the key chain for this authentication configuration. See the [Cisco Nexus 3548 Switch NX-OS Security Configuration Guide](#).

SUMMARY STEPS

1. **configure terminal**
2. **router ospf** *instance-tag*
3. **area** *area-id* **authentication** [**message-digest**]
4. **interface** *interface-type slot/port*
5. **no switchport**
- 6.
7. (Optional) **show ip ospf** *instance-tag* **interface** *interface-type slot/port*
8. (Optional) **copy running-config startup-config**

DETAILED STEPS

Procedure

	Command or Action	Purpose
Step 1	configure terminal Example: switch# configure terminal switch(config)#	Enters configuration mode.
Step 2	router ospf <i>instance-tag</i> Example: switch(config)# router ospf 201 switch(config-router)#	Creates a new OSPFv2 instance with the configured instance tag.
Step 3	area <i>area-id</i> authentication [message-digest] Example: switch(config-router)# area 0.0.0.10 authentication	Configures the authentication mode for an area.
Step 4	interface <i>interface-type slot/port</i> Example: switch(config-router)# interface ethernet 1/2 switch(config-if)#	Enters interface configuration mode.

	Command or Action	Purpose								
Step 5	no switchport Example: <pre>switch(config-if)# no switchport</pre>	Configures the interface as a Layer 3 routed interface.								
Step 6	<table border="1"> <thead> <tr> <th>Option</th> <th>Description</th> </tr> </thead> <tbody> <tr> <td>Command</td> <td>Description</td> </tr> <tr> <td> ip ospf authentication-key [0 3] key Example: <pre>switch(config-if)# ip ospf authentication-key 0 mypass</pre> </td> <td>Configures simple password authentication for this interface. Use this command if the authentication is not set to key-chain or message-digest. 0 configures the password in clear text. 3 configures the password as 3DES encrypted.</td> </tr> <tr> <td> ip ospf message-digest-key key-id md5 [0 3] key Example: <pre>switch(config-if)# ip ospf message-digest-key 21 md5 0 mypass</pre> </td> <td>Configures message digest authentication for this interface. Use this command if the authentication is set to message-digest. The key-id range is from 1 to 255. The MD5 option 0 configures the password in clear text and 3 configures the pass key as 3DES encrypted.</td> </tr> </tbody> </table>	Option	Description	Command	Description	ip ospf authentication-key [0 3] key Example: <pre>switch(config-if)# ip ospf authentication-key 0 mypass</pre>	Configures simple password authentication for this interface. Use this command if the authentication is not set to key-chain or message-digest. 0 configures the password in clear text. 3 configures the password as 3DES encrypted.	ip ospf message-digest-key key-id md5 [0 3] key Example: <pre>switch(config-if)# ip ospf message-digest-key 21 md5 0 mypass</pre>	Configures message digest authentication for this interface. Use this command if the authentication is set to message-digest. The key-id range is from 1 to 255. The MD5 option 0 configures the password in clear text and 3 configures the pass key as 3DES encrypted.	
Option	Description									
Command	Description									
ip ospf authentication-key [0 3] key Example: <pre>switch(config-if)# ip ospf authentication-key 0 mypass</pre>	Configures simple password authentication for this interface. Use this command if the authentication is not set to key-chain or message-digest. 0 configures the password in clear text. 3 configures the password as 3DES encrypted.									
ip ospf message-digest-key key-id md5 [0 3] key Example: <pre>switch(config-if)# ip ospf message-digest-key 21 md5 0 mypass</pre>	Configures message digest authentication for this interface. Use this command if the authentication is set to message-digest. The key-id range is from 1 to 255. The MD5 option 0 configures the password in clear text and 3 configures the pass key as 3DES encrypted.									
Step 7	(Optional) show ip ospf instance-tag interface interface-type slot/port Example: <pre>switch(config-if)# show ip ospf 201 interface ethernet 1/2</pre>	Displays OSPF information.								
Step 8	(Optional) copy running-config startup-config Example: <pre>switch(config)# copy running-config startup-config</pre>	Saves this configuration change.								

Configuring Authentication for an Interface

You can configure authentication for individual interfaces in the area. Interface authentication configuration overrides area authentication.

Before you begin

Ensure that you have enabled the OSPF feature (see the [Enabling the OSPFv2 Feature](#) section).

Ensure that all neighbors on an interface share the same authentication configuration, including the shared authentication key.

Create the key-chain for this authentication configuration. See the [Cisco Nexus 3548 Switch NX-OS Security Configuration Guide](#).

SUMMARY STEPS

1. **configure terminal**
2. **interface** *interface-type slot/port*
3. **no switchport**
4. **ip ospf authentication** [**message-digest**]
5. (Optional) **ip ospf authentication key-chain** *key-name*
6. (Optional) **ip ospf authentication-key** [**0 | 3 | 7**] *key*
7. (Optional) **ip ospf message-digest-key** *key-id md5* [**0 | 3 | 7**] *key*
8. (Optional) **show ip ospf instance-tag interface** *interface-type slot/port*
9. (Optional) **copy running-config startup-config**

DETAILED STEPS

Procedure

	Command or Action	Purpose
Step 1	configure terminal Example: switch# configure terminal switch(config)#	Enters configuration mode.
Step 2	interface <i>interface-type slot/port</i> Example: switch(config)# interface ethernet 1/2 switch(config-if)#	Enters interface configuration mode.
Step 3	no switchport Example: switch(config-if)# no switchport	Configures the interface as a Layer 3 routed interface.
Step 4	ip ospf authentication [message-digest] Example: switch(config-if)# ip ospf authentication	Enables interface authentication mode for OSPFv2 for either cleartext or message-digest type. Overrides area-based authentication for this interface. All neighbors must share this authentication type.
Step 5	(Optional) ip ospf authentication key-chain <i>key-name</i> Example: switch(config-if)# ip ospf authentication key-chain Test1	Configures interface authentication to use key chains for OSPFv2. See the Cisco Nexus 3548 Switch NX-OS Security Configuration Guide for details on key chains.

	Command or Action	Purpose
Step 6	(Optional) ip ospf authentication-key [0 3 7] key Example: <pre>switch(config-if)# ip ospf authentication-key 0 mypass</pre>	Configures simple password authentication for this interface. Use this command if the authentication is not set to key-chain or message-digest. The options are as follows: <ul style="list-style-type: none"> • 0—Configures the password in clear text. • 3—Configures the pass key as 3DES encrypted. • 7—Configures the key as Cisco type 7 encrypted.
Step 7	(Optional) ip ospf message-digest-key key-id md5 [0 3 7] key Example: <pre>switch(config-if)# ip ospf message-digest-key 21 md5 0 mypass</pre>	Configures message digest authentication for this interface. Use this command if the authentication is set to message-digest. The key-id range is from 1 to 255. The MD5 options are as follows: <ul style="list-style-type: none"> • 0—Configures the password in clear text. • 3—Configures the pass key as 3DES encrypted. • 7—Configures the key as Cisco type 7 encrypted.
Step 8	(Optional) show ip ospf instance-tag interface interface-type slot/port Example: <pre>switch(config-if)# show ip ospf 201 interface ethernet 1/2</pre>	Displays OSPF information.
Step 9	(Optional) copy running-config startup-config Example: <pre>switch(config)# copy running-config startup-config</pre>	Saves this configuration change.

Example

This example shows how to set an interface for simple, unencrypted passwords and set the password for Ethernet interface 1/2:

```
switch# configure terminal
switch(config)# router ospf 201
switch(config-router)# exit
switch(config)# interface ethernet 1/2
switch(config-if)# no switchport
switch(config-if)# ip router ospf 201 area 0.0.0.10
switch(config-if)# ip ospf authentication
switch(config-if)# ip ospf authentication-key 0 mypass
switch(config-if)# copy running-config startup-config
```

Configuring Advanced OSPFv2

Configure OSPFv2 after you have designed your OSPFv2 network.

Configuring Filter Lists for Border Routers

You can separate your OSPFv2 domain into a series of areas that contain related networks. All areas must connect to the backbone area through an area border router (ABR). OSPFv2 domains can connect to external domains through an autonomous system border router (ASBR). See the [Areas](#) section.

ABRs have the following optional configuration parameters:

- Area range—Configures route summarization between areas.
- Filter list—Filters the Network Summary (type 3) LSAs on an ABR that are allowed in from an external area.

ASBRs also support filter lists.

Before you begin

Ensure that you have enabled the OSPF feature (see the [Enabling the OSPFv2 Feature](#) section).

Create the route map that the filter list uses to filter IP prefixes in incoming or outgoing Network Summary (type 3) LSAs. See, [Configuring Route Policy Manager](#).

SUMMARY STEPS

1. configure terminal
2. **router ospf** *instance-tag*
3. **area** *area-id* **filter-list** **route-map** *map-name* { **in** | **out** }
4. (Optional) **show ip ospf policy statistics** *area id* **filter-list** { **in** | **out** }
5. (Optional) **copy running-config startup-config**

DETAILED STEPS

Procedure

	Command or Action	Purpose
Step 1	configure terminal Example: switch# configure terminal switch(config)#	Enters configuration mode.
Step 2	router ospf <i>instance-tag</i> Example: switch(config)# router ospf 201 switch(config-router)#	Creates a new OSPFv2 instance with the configured instance tag.

	Command or Action	Purpose
Step 3	area <i>area-id</i> filter-list route-map <i>map-name</i> { in out } Example: <pre>switch(config-router)# area 0.0.0.10 filter-list route-map FilterLSAs in</pre>	Filters incoming or outgoing Network Summary (type 3) LSAs on an ABR.
Step 4	(Optional) show ip ospf policy statistics area <i>id</i> filter-list { in out } Example: <pre>switch(config-if)# show ip ospf policy statistics area 0.0.0.10 filter-list in</pre>	Displays OSPF policy information.
Step 5	(Optional) copy running-config startup-config Example: <pre>switch(config)# copy running-config startup-config</pre>	Saves this configuration change.

Example

This example shows how to configure a filter list in area 0.0.0.10:

```
switch# configure terminal
switch(config)# router ospf 201
switch(config-router)# area 0.0.0.10 filter-list route-map FilterLSAs in
switch(config-router)# copy running-config startup-config
```

Configuring Stub Areas

You can configure a stub area for part of an OSPFv2 domain where external traffic is not necessary. Stub areas block AS External (type 5) LSAs, limiting unnecessary routing to and from selected networks. See the [Stub Area](#) section. You can optionally block all summary routes from going into the stub area.

Before you begin

Ensure that you have enabled the OSPF feature (see the [Enabling the OSPFv2 Feature](#) section).

Ensure that there are no virtual links or ASBRs in the proposed stub area.

SUMMARY STEPS

1. **configure terminal**
2. **router ospf** *instance-tag*
3. **area** *area-id* **stub**
4. (Optional) **area** *area-id* **default-cost** *cost*
5. (Optional) **show ip ospf** *instance-tag*
6. (Optional) **copy running-config startup-config**

DETAILED STEPS

Procedure

	Command or Action	Purpose
Step 1	configure terminal Example: switch# configure terminal switch(config)#	Enters configuration mode.
Step 2	router ospf instance-tag Example: switch(config)# router ospf 201 switch(config-router)#	Creates a new OSPFv2 instance with the configured instance tag.
Step 3	area area-id stub Example: switch(config-router)# area 0.0.0.10 stub	Creates this area as a stub area.
Step 4	(Optional) area area-id default-cost cost Example: switch(config-router)# area 0.0.0.10 default-cost 25	Sets the cost metric for the default summary route sent into this stub area. The range is from 0 to 16777215. The default is 1.
Step 5	(Optional) show ip ospf instance-tag Example: switch(config-if)# show ip ospf 201	Displays OSPF information.
Step 6	(Optional) copy running-config startup-config Example: switch(config)# copy running-config startup-config	Saves this configuration change.

Example

This example shows how to create a stub area:

```
switch# configure terminal
switch(config)# router ospf 201
switch(config-router)# area 0.0.0.10 stub
switch(config-router)# copy running-config startup-config
```

Configuring a Totally Stubby Area

You can create a totally stubby area and prevent all summary route updates from going into the stub area.

To create a totally stubby area, use the following command in router configuration mode:

Command	Purpose
area <i>area-id</i> stub no-summary Example: <pre>switch(config-router)# area 20 stub no-summary</pre>	Creates this area as a totally stubby area.

Configuring NSSA

You can configure an NSSA for part of an OSPFv2 domain where limited external traffic is required. See the Not-So-Stubby Area section. You can optionally translate this external traffic to an AS External (type 5) LSA and flood the OSPFv2 domain with this routing information. An NSSA can be configured with the following optional parameters:

- **No redistribution**—Redistributed routes bypass the NSSA and are redistributed to other areas in the OSPFv2 autonomous system. Use this option when the NSSA ASBR is also an ABR.
- **Default information originate**—Generates an NSSA External (type 7) LSA for a default route to the external autonomous system. Use this option on an NSSA ASBR if the ASBR contains the default route in the routing table. This option can be used on an NSSA ABR whether or not the ABR contains the default route in the routing table.
- **Route map**—Filters the external routes so that only those routes that you want are flooded throughout the NSSA and other areas.
- **Translate**—Translates NSSA External LSAs to AS External LSAs for areas outside the NSSA. Use this command on an NSSA ABR to flood the redistributed routes throughout the OSPFv2 autonomous system. You can optionally suppress the forwarding address in these AS External LSAs. If you choose this option, the forwarding address is set to 0.0.0.0.
- **No summary**—Blocks all summary routes from flooding the NSSA. Use this option on the NSSA ABR.

Before you begin

Ensure that you have enabled the OSPF feature (see the [Enabling the OSPFv2 Feature](#) section).

Ensure that there are no virtual links in the proposed NSSA and that it is not the backbone area.

SUMMARY STEPS

1. **configure terminal**
2. **router ospf** *instance-tag*
3. **area** *area-id* **nssa** [**no-redistribution**] [**default-information-originate**] [**route-map** *map-name*] [**no-summary**] [**translate type7** { **always** | **never** } [**suppress-fa**]]
4. (Optional) **area** *area-id* **default-cost** *cost*
5. (Optional) **show ip ospf** *instance-tag*
6. (Optional) **copy running-config startup-config**

DETAILED STEPS

Procedure

	Command or Action	Purpose
Step 1	configure terminal Example: switch# configure terminal switch(config)#	Enters configuration mode.
Step 2	router ospf instance-tag Example: switch(config)# router ospf 201 switch(config-router)#	Creates a new OSPFv2 instance with the configured instance tag.
Step 3	area area-id nssa [no-redistribution] [default-information-originate] [route-map map-name] [no-summary] [translate type7 { always never } [suppress-fa]] Example: switch(config-router)# area 0.0.0.10 nssa	Creates this area as an NSSA.
Step 4	(Optional) area area-id default-cost cost Example: switch(config-router)# area 0.0.0.10 default-cost 25	Sets the cost metric for the default summary route sent into this NSSA.
Step 5	(Optional) show ip ospf instance-tag Example: switch(config-if)# show ip ospf 201	Displays OSPF information.
Step 6	(Optional) copy running-config startup-config Example: switch(config)# copy running-config startup-config	Saves this configuration change.

Example

This example shows how to create an NSSA that blocks all summary route updates:

```
switch# configure terminal
switch(config)# router ospf 201
switch(config-router)# area 0.0.0.10 nssa no-summary
switch(config-router)# copy running-config startup-config
```

This example shows how to create an NSSA that generates a default route:

```
switch# configure terminal
switch(config)# router ospf 201
switch(config-router)# area 0.0.0.10 nssa default-info-originate
switch(config-router)# copy running-config startup-config
```

This example shows how to create an NSSA that filters external routes and blocks all summary route updates:

```
switch# configure terminal
switch(config)# router ospf 201
switch(config-router)# area 0.0.0.10 nssa route-map ExternalFilter no-summary
switch(config-router)# copy running-config startup-config
```

This example shows how to create an NSSA that always translates NSSA External (type 5) LSAs to AS External (type 7) LSAs:

```
switch# configure terminal
switch(config)# router ospf 201
switch(config-router)# area 0.0.0.10 nssa translate type 7 always
switch(config-router)# copy running-config startup-config
```

Configuring Virtual Links

A virtual link connects an isolated area to the backbone area through an intermediate area. See the [Virtual Links](#) section. You can configure the following optional parameters for a virtual link:

- Authentication—Sets a simple password or MD5 message digest authentication and associated keys.
- Dead interval—Sets the time that a neighbor waits for a Hello packet before declaring the local router as dead and tearing down adjacencies.
- Hello interval—Sets the time between successive Hello packets.
- Retransmit interval—Sets the estimated time between successive LSAs.
- Transmit delay—Sets the estimated time to transmit an LSA to a neighbor.



Note You must configure the virtual link on both routers involved before the link becomes active.

You cannot add a virtual link to a stub area.

Before you begin

Ensure that you have enabled the OSPF feature (see the [Enabling the OSPFv2 Feature](#) section).

SUMMARY STEPS

1. **configure terminal**
2. **router ospf** *instance-tag*
3. **area** *area-id* **virtual-link** *router-id*
4. (Optional) **show ip ospf virtual-link** [**brief**]
5. (Optional) **copy running-config startup-config**

DETAILED STEPS

Procedure

	Command or Action	Purpose
Step 1	configure terminal Example: switch# configure terminal switch(config)#	Enters configuration mode.
Step 2	router ospf instance-tag Example: switch(config)# router ospf 201 switch(config-router)#	Creates a new OSPFv2 instance with the configured instance tag.
Step 3	area area-id virtual-link router-id Example: switch(config-router)# area 0.0.0.10 virtual-link 10.1.2.3 switch(config-router-vlink)#	Creates one end of a virtual link to a remote router. You must create the virtual link on that remote router to complete the link.
Step 4	(Optional) show ip ospf virtual-link [brief] Example: switch(config-router-vlink)# show ip ospf virtual-link	Displays OSPF virtual link information.
Step 5	(Optional) copy running-config startup-config Example: switch(config-router-vlink)# copy running-config startup-config	Saves this configuration change.

Example

You can configure the following optional commands in virtual link configuration mode:

Commands	Purpose
authentication [key-chain key-id message-digest null] Example: switch(config-router-vlink)# authentication message-digest	Overrides area-based authentication for this virtual link.
authentication-key [0 3] key Example: switch(config-router-vlink)# authentication-key 0 mypass	Configures a simple password for this virtual link. Use this command if the authentication is not set to key-chain or message-digest. 0 configures the password in clear text. 3 configures the password as 3DES encrypted.

Commands	Purpose
dead-interval <i>seconds</i> Example : <pre>switch(config-router-vlink)# dead-interval 50</pre>	Configures the OSPFv2 dead interval, in seconds. The range is from 1 to 65535. The default is four times the hello interval, in seconds.
hello-interval <i>seconds</i> Example: <pre>switch(config-router-vlink)# hello-interval 25</pre>	Configures the OSPFv2 hello interval, in seconds. The range is from 1 to 65535. The default is 10 seconds.
message-digest-key <i>key-id md5 [0 3] key</i> Example: <pre>switch(config-router-vlink)# message-digest-key 21 md5 0 mypass</pre>	Configures message digest authentication for this virtual link. Use this command if the authentication is set to message-digest. 0 configures the password in cleartext. 3 configures the pass key as 3DES encrypted.
retransmit-interval <i>seconds</i> Example : <pre>switch(config-router-vlink)# retransmit-interval 50</pre>	Configures the OSPFv2 retransmit interval, in seconds. The range is from 1 to 65535. The default is 5.
transmit-delay <i>seconds</i> Example: <pre>switch(config-router-vlink)# transmit-delay 2</pre>	Configures the OSPFv2 transmit-delay, in seconds. The range is from 1 to 450. The default is 1

This example shows how to create a simple virtual link between two ABRs.

The configuration for ABR 1 (router ID 27.0.0.55) is as follows:

```
switch# configure terminal
switch(config)# router ospf 201
switch(config-router)# area 0.0.0.10 virtual-link 10.1.2.3
switch(config-router-vlink)# copy running-config startup-config
```

The configuration for ABR 2 (Router ID 10.1.2.3) is as follows:

```
switch# configure terminal
switch(config)# router ospf 101
switch(config-router)# area 0.0.0.10 virtual-link 27.0.0.55
switch(config-router-vlink)# copy running-config startup-config
```

Configuring Redistribution

You can redistribute routes learned from other routing protocols into an OSPFv2 autonomous system through the ASBR.

You can configure the following optional parameters for route redistribution in OSPF:

- Default information originate—Generates an AS External (type 5) LSA for a default route to the external autonomous system.



Note Default information originate ignores **match** statements in the optional route map.

- Default metric—Sets all redistributed routes to the same cost metric.



Note If you redistribute static routes, Cisco NX-OS requires the **default-information originate** command to successfully redistribute the default static route starting in 7.0(3)I7(6).

Before you begin

Ensure that you have enabled the OSPF feature (see the [Enabling the OSPFv2 Feature](#) section).

Create the necessary route maps used for redistribution.

SUMMARY STEPS

1. **configure terminal**
2. **router ospf** *instance-tag*
3. **redistribute** { **bgp** *id* | **direct** | **eigrp** *id* | **ospf** *id* | **rip** *id* | **static** } **route-map** *map-name*
4. **default-information originate** [**always**] [**route-map** *map-name*]
5. **default-metric** *cost*
6. (Optional) **copy running-config startup-config**

DETAILED STEPS

Procedure

	Command or Action	Purpose
Step 1	configure terminal Example: switch# configure terminal switch(config)#	Enters configuration mode.
Step 2	router ospf <i>instance-tag</i> Example: switch(config)# router ospf 201 switch(config-router)#	Creates a new OSPFv2 instance with the configured instance tag.
Step 3	redistribute { bgp <i>id</i> direct eigrp <i>id</i> ospf <i>id</i> rip <i>id</i> static } route-map <i>map-name</i> Example: switch(config-router)# redistribute bgp 64496 route-map FilterExternalBGP	Redistributes the selected protocol into OSPF through the configured route map. Note If you redistribute static routes, Cisco NX-OS requires the default-information originate command to successfully redistribute the default static route starting in 7.0(3)I7(6).

	Command or Action	Purpose
Step 4	default-information originate [always] [route-map map-name] Example: <pre>switch(config-router)# default-information-originate route-map DefaultRouteFilter</pre>	Creates a default route into this OSPF domain if the default route exists in the RIB. Use the following optional keywords: <ul style="list-style-type: none"> • always —Always generate the default route of 0.0.0.0, even if the route does not exist in the RIB. • route-map —Generate the default route if the route map returns true. This command ignores match statements in the route map.
Step 5	default-metric cost Example: <pre>switch(config-router)# default-metric 25</pre>	Sets the cost metric for the redistributed routes. This does not apply to directly connected routes. Use a route map to set the default metric for directly connected routes.
Step 6	(Optional) copy running-config startup-config Example: <pre>switch(config-router)# copy running-config startup-config</pre>	Saves this configuration change.

Example

This example shows how to redistribute the Border Gateway Protocol (BGP) into OSPF:

```
switch# configure terminal
switch(config)# router ospf 201
switch(config-router)# redistribute bgp route-map FilterExternalBGP
switch(config-router)# copy running-config startup-config
```

Limiting the Number of Redistributed Routes

Route redistribution can add many routes to the OSPFv2 route table. You can configure a maximum limit to the number of routes accepted from external protocols. OSPFv2 provides the following options to configure redistributed route limits:

- **Fixed limit**—Logs a message when OSPFv2 reaches the configured maximum. OSPFv2 does not accept any more redistributed routes. You can optionally configure a threshold percentage of the maximum where OSPFv2 will log a warning when that threshold is passed.
- **Warning only**—Logs a warning only when OSPFv2 reaches the maximum. OSPFv2 continues to accept redistributed routes.
- **Withdraw**—Starts the timeout period when OSPFv2 reaches the maximum. After the timeout period, OSPFv2 requests all redistributed routes if the current number of redistributed routes is less than the maximum limit. If the current number of redistributed routes is at the maximum limit, OSPFv2 withdraws all redistributed routes. You must clear this condition before OSPFv2 accepts more redistributed routes.

You can optionally configure the timeout period.

Before you begin

Ensure that you have enabled the OSPF feature (see the [Enabling the OSPFv2 Feature](#) section).

SUMMARY STEPS

1. **configure terminal**
2. **router ospf** *instance-tag*
3. **redistribute** { *bgp id* | **direct** | *eigrp id* | *ospf id* | *rip id* | **static** } **route-map** *map-name*
4. **redistribute maximum-prefix** *max* [*threshold*] [**warning-only** | **withdraw** [*num-retries* *timeout*]]
5. (Optional) **show running-config ospf**
6. (Optional) **copy running-config startup-config**

DETAILED STEPS**Procedure**

	Command or Action	Purpose
Step 1	configure terminal Example: <pre>switch# configure terminal switch(config)#</pre>	Enters configuration mode.
Step 2	router ospf <i>instance-tag</i> Example: <pre>switch(config)# router ospf 201 switch(config-router)#</pre>	Creates a new OSPFv2 instance with the configured instance tag.
Step 3	redistribute { <i>bgp id</i> direct <i>eigrp id</i> <i>ospf id</i> <i>rip id</i> static } route-map <i>map-name</i> Example: <pre>switch(config-router)# redistribute bgp 64496 route-map FilterExternalBGP</pre>	Redistributes the selected protocol into OSPF through the configured route map.
Step 4	redistribute maximum-prefix <i>max</i> [<i>threshold</i>] [warning-only withdraw [<i>num-retries</i> <i>timeout</i>]] Example: <pre>switch(config-router)# redistribute maximum-prefix 1000 75 warning-only</pre>	<p>Specifies a maximum number of prefixes that OSPFv2 will distribute. The range is from 0 to 65536. Optionally specifies the following:</p> <ul style="list-style-type: none"> • threshold —Percent of maximum prefixes that will trigger a warning message. • warning-only —Logs an warning message when the maximum number of prefixes is exceeded. • withdraw —Withdraws all redistributed routes. Optionally tries to retrieve the redistributed routes. The <i>num-retries</i> range is from 1 to 12. The <i>timeout</i> is 60 to 600 seconds. The default is 300 seconds. Use clear ip ospf redistribution if all routes are withdrawn.

	Command or Action	Purpose
Step 5	(Optional) show running-config ospf Example: switch(config-router)# show running-config ospf	Displays the OSPFv2 configuration.
Step 6	(Optional) copy running-config startup-config Example: switch(config-router)# copy running-config startup-config	Saves this configuration change.

Example

This example shows how to limit the number of redistributed routes into OSPF:

```
switch# configure terminal
switch(config)# router ospf 201
switch(config-router)# redistribute bgp route-map FilterExternalBGP
switch(config-router)# redistribute maximum-prefix 1000 7
```

Configuring Route Summarization

You can configure route summarization for inter-area routes by configuring an address range that is summarized. You can also configure route summarization for external, redistributed routes by configuring a summary address for those routes on an ASBR. See the [Route Summarization](#) section.

Before you begin

Ensure that you have enabled the OSPF feature (see the [Enabling the OSPFv2 Feature](#) section).

SUMMARY STEPS

1. **configure terminal**
2. **router ospf** *instance-tag*
3. **area** *area-id* **range** *ip-prefix/length* [**no-advertise**] [**cost** *cost*]
4. **summary-address** *ip-prefix/length* [**no-advertise** | **tag** *tag-id*]
5. (Optional) **show ip ospf summary-address**
6. (Optional) **copy running-config startup-config**

DETAILED STEPS

Procedure

	Command or Action	Purpose
Step 1	configure terminal Example:	Enters configuration mode.

	Command or Action	Purpose
	switch# configure terminal switch(config)#	
Step 2	router ospf instance-tag Example: switch(config)# router ospf 201 switch(config-router)#	Creates a new OSPFv2 instance with the configured instance tag.
Step 3	area area-id range ip-prefix/length [no-advertise] [cost cost] Example: switch(config-router)# area 0.0.0.10 range 10.3.0.0/16	Creates a summary address on an ABR for a range of addresses and optionally does not advertise this summary address in a Network Summary (type 3) LSA. The <i>cost</i> range is from 0 to 16777215.
Step 4	summary-address ip-prefix/length [no-advertise tag tag-id] Example: switch(config-router)# summary-address 10.5.0.0/16 tag 2	Creates a summary address on an ASBR for a range of addresses and optionally assigns a tag for this summary address that can be used for redistribution with route maps.
Step 5	(Optional) show ip ospf summary-address Example: switch(config-router)# show ip ospf summary-address	Displays information about OSPF summary addresses.
Step 6	(Optional) copy running-config startup-config Example: switch(config-router)# copy running-config startup-config	Saves this configuration change.

Example

This example shows how to create summary addresses between areas on an ABR:

```
switch# configure terminal
switch(config)# router ospf 201
switch(config-router)# area 0.0.0.10 range 10.3.0.0/16
switch(config-router)# copy running-config startup-config
```

This example shows how to create summary addresses on an ASBR:

```
switch# configure terminal
switch(config)# router ospf 201
switch(config-router)# summary-address 10.5.0.0/16
switch(config-router)# copy running-config startup-config
```

Configuring Stub Route Advertisements

Use stub route advertisements when you want to limit the OSPFv2 traffic through this router for a short time. See the [OSPFv2 Stub Router Advertisements](#) section.

Stub route advertisements can be configured with the following optional parameters:

- On startup—Sends stub route advertisements for the specified announce time.
- Wait for BGP—Sends stub router advertisements until BGP converges.

Before you begin

Ensure that you have enabled the OSPF feature (see the [Enabling the OSPFv2 Feature](#) section).

SUMMARY STEPS

1. **configure terminal**
2. **router ospf** *instance-tag*
3. **max-metric router-lsa** [**on-startup** [*announce-time*] [**wait-for bgp** *tag*]]
4. (Optional) **copy running-config startup-config**

DETAILED STEPS

Procedure

	Command or Action	Purpose
Step 1	configure terminal Example: <pre>switch# configure terminal switch(config)#</pre>	Enters configuration mode.
Step 2	router ospf <i>instance-tag</i> Example: <pre>switch(config)# router ospf 201 switch(config-router)#</pre>	Creates a new OSPFv2 instance with the configured instance tag.
Step 3	max-metric router-lsa [on-startup [<i>announce-time</i>] [wait-for bgp <i>tag</i>]] Example: <pre>switch(config-router)# max-metric router-lsa</pre>	Configures OSPFv2 stub route advertisements.
Step 4	(Optional) copy running-config startup-config Example: <pre>switch(config-router)# copy running-config startup-config</pre>	Saves this configuration change.

Example

This example shows how to enable the stub router advertisements feature on startup for the default 600 seconds:

```
switch# configure terminal
switch(config)# router ospf 201
switch(config-router)# max-metric router-lsa on-startup
switch(config-router)# copy running-config startup-config
```

Modifying the Default Timers

OSPFv2 includes a number of timers that control the behavior of protocol messages and shortest path first (SPF) calculations. OSPFv2 includes the following optional timer parameters:

- LSA arrival time—Sets the minimum interval allowed between LSAs arriving from a neighbor. LSAs that arrive faster than this time are dropped.
- Pacing LSAs—Set the interval at which LSAs are collected into a group and refreshed, checksummed, or aged. This timer controls how frequently LSA updates occur and optimizes how many are sent in an LSA update message (see the [Flooding and LSA Group Pacing](#) section).
- Throttle LSAs—Set rate limits for generating LSAs. This timer controls how frequently an LSA is generated if no topology change occurs.
- Throttle SPF calculation—Controls how frequently the SPF calculation is run.

At the interface level, you can also control the following timers:

- Retransmit interval—Sets the estimated time between successive LSAs.
- Transmit delay—Sets the estimated time to transmit an LSA to a neighbor.

See the [Configuring Networks in OSPFv2](#) section for information about the hello interval and dead timer.

Before you begin

Ensure that you have enabled the OSPF feature (see the [Enabling the OSPFv2 Feature](#) section).

SUMMARY STEPS

1. **configure terminal**
2. **router ospf *instance-tag***
3. **timers lsa-arrival *msec***
4. **timers lsa-group-pacing *seconds***
5. **timers throttle lsa *start-time hold-interval max-time***
6. **timers throttle spf *delay-time hold-time max-time***
7. **interface *type slot/port***
8. **no switchport**
9. **ip ospf hello-interval *seconds***
10. **ip ospf dead-interval *seconds***
11. **ip ospf retransmit-interval *seconds***
12. **ip ospf transmit-delay *seconds***
13. (Optional) **show ip ospf**
14. (Optional) **copy running-config startup-config**

DETAILED STEPS

Procedure

	Command or Action	Purpose
Step 1	configure terminal Example: <pre>switch# configure terminal switch(config)#</pre>	Enters configuration mode.
Step 2	router ospf instance-tag Example: <pre>switch(config)# router ospf 201 switch(config-router)#</pre>	Creates a new OSPFv2 instance with the configured instance tag.
Step 3	timers lsa-arrival msec Example: <pre>switch(config-router)# timers lsa-arrival 2000</pre>	Sets the LSA arrival time in milliseconds. The range is from 10 to 600000. The default is 1000 milliseconds.
Step 4	timers lsa-group-pacing seconds Example: <pre>switch(config-router)# timers lsa-group-pacing 1800</pre>	Sets the interval in seconds for grouping LSAs. The range is from 1 to 1800. The default is 240 seconds.
Step 5	timers throttle lsa start-time hold-interval max-time Example: <pre>switch(config-router)# timers throttle lsa 3000 6000 6000</pre>	Sets the rate limit in milliseconds for generating LSAs with the following timers: <i>start-time</i> —The range is from 50 to 5000 milliseconds. The default value is 50 milliseconds. <i>hold-interval</i> —The range is from 50 to 30,000 milliseconds. The default value is 5000 milliseconds. <i>max-time</i> —The range is from 50 to 30,000 milliseconds. The default value is 5000 milliseconds.
Step 6	timers throttle spf delay-time hold-time max-time Example: <pre>switch(config-router)# timers throttle spf 3000 2000 5000</pre>	Sets the SPF best-path schedule initial delay time, minimum hold time, and maximum wait time in milliseconds between SPF best-path calculations. The range is from 1 to 600000 milliseconds. The default values are a 200-ms delay time, 1000-ms hold time, and 5000-ms wait time.
Step 7	interface type slot/port Example: <pre>switch(config)# interface ethernet 1/2 switch(config-if)#</pre>	Enters interface configuration mode.
Step 8	no switchport Example:	Configures the interface as a Layer 3 routed interface.

	Command or Action	Purpose
	<code>switch(config-if)# no switchport</code>	
Step 9	ip ospf hello-interval <i>seconds</i> Example: <code>switch(config-if)# ip ospf retransmit-interval 30</code>	Sets the hello interval this interface. The range is from 1 to 65535. The default is 10.
Step 10	ip ospf dead-interval <i>seconds</i> Example: <code>switch(config-if)# ip ospf dead-interval 30</code>	Sets the dead interval for this interface. The range is from 1 to 65535.
Step 11	ip ospf retransmit-interval <i>seconds</i> Example: <code>switch(config-if)# ip ospf retransmit-interval 30</code>	Sets the estimated time in seconds between LSAs transmitted from this interface. The range is from 1 to 65535. The default is 5.
Step 12	ip ospf transmit-delay <i>seconds</i> Example: <code>switch(config-if)# ip ospf transmit-delay 450</code> <code>switch(config-if)#</code>	Sets the estimated time in seconds to transmit an LSA to a neighbor. The range is from 1 to 450. The default is 1.
Step 13	(Optional) show ip ospf Example: <code>switch(config-if)# show ip ospf</code>	Displays information about OSPF.
Step 14	(Optional) copy running-config startup-config Example: <code>switch(config-router)# copy running-config startup-config</code>	Saves this configuration change.

Example

This example shows how to control LSA flooding with the `lsa-group-pacing` option:

```
switch# configure terminal
switch(config)# router ospf 201
switch(config-router)# timers lsa-group-pacing 300
switch(config-router)# copy running-config startup-config
```

Restarting an OSPFv2 Instance

You can restart an OSPFv2 instance. This clears all neighbors for the instance.

To restart an OSPFv2 instance and remove all associated neighbors, use the following command:

Command	Purpose
restart ospf <i>instance-tag</i> Example: <pre>switch(config)# restart ospf 201</pre>	Restarts the OSPFv2 instance and removes all neighbors.

Configuring OSPFv2 with Virtualization

You can create multiple VRFs and use the same or multiple OSPFv2 instances in each VRF. You assign an OSPFv2 interface to a VRF.



Note Configure all other parameters for an interface after you configure the VRF for an interface. Configuring a VRF for an interface deletes all the configuration for that interface.

Before you begin

Ensure that you have enabled the OSPF feature. See the [Enabling the OSPFv2 Feature](#) section.

SUMMARY STEPS

1. **configure terminal**
2. **vrf context** *vrf-name*
3. **router ospf** *instance-tag*
4. **vrf** *vrf-name*
5. (Optional) **maximum-paths** *paths*
6. **interface** *interface-typeslot/port*
7. **no switchport**
8. **vrf member** *vrf-name*
9. **ip address** *ip-prefix/length*
10. **ip router ospf instance-tag area** *area-id*
11. (Optional) **copy running-config startup-config**

DETAILED STEPS

Procedure

	Command or Action	Purpose
Step 1	configure terminal Example: <pre>switch# configure terminal switch(config)#</pre>	Enters configuration mode.
Step 2	vrf context <i>vrf-name</i> Example:	Creates a new VRF and enters VRF configuration mode.

	Command or Action	Purpose
	<pre>switch(config)# vrf context RemoteOfficeVRF switch(config-vrf)#</pre>	
Step 3	router ospf instance-tag Example: <pre>switch(config-vrf)# router ospf 201 switch(config-router)#</pre>	Creates a new OSPFv2 instance with the configured instance tag.
Step 4	vrf vrf-name Example: <pre>switch(config-router)# vrf RemoteOfficeVRF switch(config-router-vrf)#</pre>	Enters VRF configuration mode.
Step 5	(Optional) maximum-paths paths Example: <pre>switch(config-router-vrf)# maximum-paths 4</pre>	Configures the maximum number of equal OSPFv2 paths to a destination in the route table for this VRF. Used for load balancing.
Step 6	interface interface-typeslot/port Example: <pre>switch(config-router-vrf)# interface ethernet 1/2 switch(config-if)#</pre>	Enters interface configuration mode.
Step 7	no switchport Example: <pre>switch(config-if)# no switchport</pre>	Configures the interface as a Layer 3 routed interface.
Step 8	vrf member vrf-name Example: <pre>switch(config-if)# vrf member RemoteOfficeVRF</pre>	Adds this interface to a VRF.
Step 9	ip address ip-prefix/length Example: <pre>switch(config-if)# ip address 192.0.2.1/16</pre>	Configures an IP address for this interface. You must do this step after you assign this interface to a VRF.
Step 10	ip router ospf instance-tag area area-id Example: <pre>switch(config-if)# ip router ospf 201 area 0</pre>	Assigns this interface to the OSPFv2 instance and area configured.
Step 11	(Optional) copy running-config startup-config Example: <pre>switch(config-router)# copy running-config startup-config</pre>	Saves this configuration change.

Example

This example shows how to create a VRF and add an interface to the VRF:

```

switch# configure terminal
switch(config)# vrf context NewVRF
switch(config)# router ospf 201
switch(config)# interface ethernet 1/2
switch(config-if)# no switchport
switch(config-if)# vrf member NewVRF
switch(config-if)# ip address 192.0.2.1/16
switch(config-if)# ip router ospf 201 area 0
switch(config)# copy running-config startup-config

```

Verifying the OSPFv2 Configuration

show ip ospf	Displays the OSPFv2 configuration.
show ip ospf border-routers [vrf { vrf-name all default management }]	Displays the OSPFv2 border router configuration.
show ip ospf database [vrf { vrf-name all default management }]	Displays the OSPFv2 link-state database summary.
show ip ospf interface number [vrf { vrf-name all default management }]	Displays the OSPFv2 interface configuration.
show ip ospf lsa-content-changed-list <i>interface - type number</i>	Displays the OSPFv2 LSAs that have changed.
show ip ospf neighbors [<i>neighbor-id</i>] [detail] [<i>interface - type number</i>] [vrf { vrf-name all default management }] [summary]	Displays the list of OSPFv2 neighbors.
show ip ospf request-list <i>neighbor-id</i> [<i>interface - type number</i>]	Displays the list of OSPFv2 link-state requests.
show ip ospf retransmission-list <i>neighbor-id</i> [<i>interface - type number</i>]	Displays the list of OSPFv2 link-state retransmissions.
show ip ospf route [<i>ospf-route</i>] [summary] [vrf { vrf-name all default management }]	Displays the internal OSPFv2 routes.
show ip ospf summary-address [vrf { vrf-name all default management }]	Displays information about the OSPFv2 summary addresses.
show ip ospf virtual-links [brief] [vrf { vrf-name all default management }]	Displays information about OSPFv2 virtual links.
show ip ospf vrf { vrf-name all default management }	Displays information about VRF-based OSPFv2 configuration.
show running-configuration ospf	Displays the current running OSPFv2 configuration.

Displaying OSPFv2 Statistics

To display OSPFv2 statistics, use the following commands:

Command	Purpose
<code>show ip ospf policy statistics area <i>area-id</i> filter-list { in out } [vrf { <i>vrf-name</i> all default management }]</code>	Displays the OSPFv2 route policy statistics for an area.
<code>show ip ospf policy statistics redistribute { bgp <i>id</i> direct eigrp <i>id</i> ospf <i>id</i> rip <i>id</i> static } vrf { <i>vrf-name</i> all default management }</code>	Displays the OSPFv2 route policy statistics.
<code>show ip ospf statistics [vrf { <i>vrf-name</i> all default management }]</code>	Displays the OSPFv2 event counters.
<code>show ip ospf traffic [<i>interface - type number</i>] [vrf { <i>vrf-name</i> all default management }]</code>	Displays the OSPFv2 packet counters.

Configuration Examples for OSPFv2

This example shows how to configure OSPFv2:

```
feature ospf
router ospf 201
router-id 290.0.2.1

interface ethernet 1/2
no switchport
ip router ospf 201 area 0.0.0.10
ip ospf authentication
ip ospf authentication-key 0 mypass
```

Additional References

For additional information related to implementing OSPF, see the following sections:

- [Related Documents](#)
- [MIBs](#)

Related Documents

Related Topic	Document Title
OSPFv2 CLI commands	Cisco Nexus 3000 Series Command Reference
Route maps	Configuring Route Policy Manager

MIBs

MIBs	MIBs Link
<ul style="list-style-type: none"><li data-bbox="423 352 565 380">• OSPF-MIB<li data-bbox="423 405 573 432">• OSPF-TRAPMIB	To locate and download MIBs, go to the following: MIB Locator .



CHAPTER 5

Configuring EIGRP

This chapter describes how to configure the Enhanced Interior Gateway Routing Protocol (EIGRP) on Cisco NX-OS switches.

This chapter includes the following sections:

- [Information About EIGRP, on page 81](#)
- [Prerequisites for EIGRP, on page 86](#)
- [Guidelines and Limitations for EIGRP, on page 87](#)
- [Default Settings for EIGRP, on page 87](#)
- [Configuring Basic EIGRP, on page 88](#)
- [Configuring Advanced EIGRP, on page 93](#)
- [Configuring Virtualization for EIGRP, on page 104](#)
- [Verifying the EIGRP Configuration, on page 106](#)
- [Displaying EIGRP Statistics, on page 106](#)
- [Configuration Examples for EIGRP, on page 107](#)
- [Related Topics, on page 107](#)
- [Additional References, on page 107](#)

Information About EIGRP

EIGRP combines the benefits of distance vector protocols with the features of link-state protocols. EIGRP sends out periodic hello messages for neighbor discovery. Once EIGRP learns a new neighbor, it sends a one-time update of all the local EIGRP routes and route metrics. The receiving EIGRP router calculates the route distance based on the received metrics and the locally assigned cost of the link to that neighbor. After this initial full route table update, EIGRP sends incremental updates to only those neighbors affected by the route change. This process speeds convergence and minimizes bandwidth.

EIGRP Components

EIGRP has the following basic components:

Reliable Transport Protocol

The Reliable Transport Protocol guarantees ordered delivery of EIGRP packets to all neighbors. (See the [Neighbor Discovery and Recovery](#) section.) The Reliable Transport Protocol supports the transmission of

unicast packets. This provision helps to ensure that the convergence time remains low for various speed links. See the [Configuring Advanced EIGRP](#) section for details about modifying the default timers that control the unicast packet transmissions.

The Reliable Transport Protocol includes the following message types:

- Hello—Used for neighbor discovery and recovery. By default, EIGRP sends a periodic multicast hello message on the local network at the configured hello interval. By default, the hello interval is 5 seconds.
- Acknowledgement—Verifies reliable reception of Updates, Queries, and Replies.
- Updates—Sends to affected neighbors when routing information changes. Updates include the route destination, address mask, and route metrics such as delay and bandwidth. The update information is stored in the EIGRP topology table.
- Queries and Replies—Sent as necessary as part of the Diffusing Update Algorithm used by EIGRP.

Neighbor Discovery and Recovery

EIGRP uses the hello messages from the Reliable Transport Protocol to discover neighboring EIGRP routers on directly attached networks. EIGRP adds neighbors to the neighbor table. The information in the neighbor table includes the neighbor address, the interface it was learned on, and the hold time, which indicates how long EIGRP should wait before declaring a neighbor unreachable. By default, the hold time is three times the hello interval or 15 seconds.

EIGRP sends a series of Update messages to new neighbors to share the local EIGRP routing information. This route information is stored in the EIGRP topology table. After this initial transmission of the full EIGRP route information, EIGRP sends Update messages only when a routing change occurs. These Update messages contain only the new or changed information and are sent only to the neighbors affected by the change. See the [EIGRP Route Updates](#) section.

EIGRP also uses the hello messages as a keepalive to its neighbors. As long as hello messages are received, Cisco NX-OS can determine that a neighbor is alive and functioning.

Diffusing Update Algorithm

The Diffusing Update Algorithm (DUAL) calculates the routing information based on the destination networks in the topology table. The topology table includes the following information:

- IPv4 address/mask—The network address and network mask for this destination.
- Successors—The IP address and local interface connection for all feasible successors or neighbors that advertise a shorter distance to the destination than the current feasible distance.
- Feasibility distance (FD)—The lowest calculated distance to the destination. The feasibility distance is the sum of the advertised distance from a neighbor plus the cost of the link to that neighbor.

DUAL uses the distance metric to select efficient, loop-free paths. DUAL selects routes to insert into the unicast Routing Information Base (RIB) based on feasible successors. When a topology change occurs, DUAL looks for feasible successors in the topology table. If there are feasible successors, DUAL selects the feasible successor with the lowest feasible distance and inserts that into the unicast RIB, avoiding unnecessary recomputation.

When there are no feasible successors but there are neighbors advertising the destination, DUAL transitions from the passive state to the active state and triggers a recomputation to determine a new successor or next-hop router to the destination. The amount of time required to recompute the route affects the convergence time.

EIGRP sends Query messages to all neighbors, searching for feasible successors. Neighbors that have a feasible successor send a Reply message with that information. Neighbors that do not have feasible successors trigger a DUAL recomputation.

EIGRP Route Updates

When a topology change occurs, EIGRP sends an Update message with only the changed routing information to affected neighbors. This Update message includes the distance information to the new or updated network destination.

The distance information in EIGRP is represented as a composite of available route metrics, including bandwidth, delay, load utilization, and link reliability. Each metric has an associated weight that determines if the metric is included in the distance calculation. You can configure these metric weights. You can fine-tune link characteristics to achieve optimal paths, but we recommend that you use the default settings for most configurable metrics.

Internal Route Metrics

Internal routes are routes that occur between neighbors within the same EIGRP autonomous system. These routes have the following metrics:

- Next hop—The IP address of the next-hop router.
- Delay—The sum of the delays configured on the interfaces that make up the route to the destination network. Configured in tens of microseconds.
- Bandwidth—The calculation from the lowest configured bandwidth on an interface that is part of the route to the destination.



Note We recommend that you use the default bandwidth value. This bandwidth parameter is also used by EIGRP.

- MTU—The smallest maximum transmission unit value along the route to the destination.
- Hop count—The number of hops or routers that the route passes through to the destination. This metric is not directly used in the DUAL computation.
- Reliability—An indication of the reliability of the links to the destination.
- Load—An indication of how much traffic is on the links to the destination.

By default, EIGRP uses the bandwidth and delay metrics to calculate the distance to the destination. You can modify the metric weights to include the other metrics in the calculation.

External Route Metrics

External routes are routes that occur between neighbors in different EIGRP autonomous systems. These routes have the following metrics:

- Next hop—The IP address of the next-hop router.
- Router ID—The router ID of the router that redistributed this route into EIGRP.
- AS Number—The autonomous system number of the destination.

- Protocol ID—A code that represents the routing protocol that learned the destination route.
- Tag—An arbitrary tag that can be used for route maps.
- Metric—The route metric for this route from the external routing protocol.

EIGRP and the Unicast RIB

EIGRP adds all learned routes to the EIGRP topology table and the unicast RIB. When a topology change occurs, EIGRP uses these routes to search for a feasible successor. EIGRP also listens for notifications from the unicast RIB for changes in any routes redistributed to EIGRP from another routing protocol.

Advanced EIGRP

You can use the advanced features of EIGRP to optimize your EIGRP configuration.

Address Families

EIGRP supports the IPv4 address family.

Address family configuration mode includes the following EIGRP features:

- Authentication
- AS number
- Default route
- Metrics
- Distance
- Graceful restart
- Logging
- Load balancing
- Redistribution
- Router ID
- Stub router
- Timers

You cannot configure the same feature in more than one configuration mode. For example, if you configure the default metric in router configuration mode, you cannot configure the default metric in address family mode

Authentication

You can configure authentication on EIGRP messages to prevent unauthorized or invalid routing updates in your network. EIGRP authentication supports MD5 authentication digest.

You can configure the EIGRP authentication per virtual routing and forwarding (VRF) instance or interface using key-chain management for the authentication keys. Key-chain management allows you to control changes

to the authentication keys used by MD5 authentication digest. See the [Cisco Nexus 3548 Switch NX-OS Security Configuration Guide](#) for more details about creating key-chains.

For MD5 authentication, you configure a password that is shared at the local router and all remote EIGRP neighbors. When an EIGRP message is created, Cisco NX-OS creates an MD5 one-way message digest based on the message itself and the encrypted password and sends this digest along with the EIGRP message. The receiving EIGRP neighbor validates the digest using the same encrypted password. If the message has not changed, the calculation is identical and the EIGRP message is considered valid.

MD5 authentication also includes a sequence number with each EIGRP message that is used to ensure that no message is replayed in the network.

Stub Routers

You can use the EIGRP stub routing feature to improve network stability, reduce resource usage, and simplify stub router configuration. Stub routers connect to the EIGRP network through a remote router. See the [Stub Routing](#) section.

When using EIGRP stub routing, you need to configure the distribution and remote routers to use EIGRP and configure only the remote router as a stub. EIGRP stub routing does not automatically enable summarization on the distribution router. In most cases, you need to configure summarization on the distribution routers.

Without EIGRP stub routing, even after the routes that are sent from the distribution router to the remote router have been filtered or summarized, a problem might occur. For example, if a route is lost somewhere in the corporate network, EIGRP could send a query to the distribution router. The distribution router could then send a query to the remote router even if routes are summarized. If a problem communicating over the WAN link between the distribution router and the remote router occurs, EIGRP could get stuck in active condition and cause instability elsewhere in the network. EIGRP stub routing allows you to prevent queries to the remote router.

Route Summarization

You can configure a summary aggregate address for a specified interface. Route summarization simplifies route tables by replacing a number of more-specific addresses with an address that represents all the specific addresses. For example, you can replace 10.1.1.0/24, 10.1.2.0/24, and 10.1.3.0/24 with one summary address, 10.1.0.0/16.

If more specific routes are in the routing table, EIGRP advertises the summary address from the interface with a metric equal to the minimum metric of the more specific routes.



Note EIGRP does not support automatic route summarization.

Route Redistribution

You can use EIGRP to redistribute direct routes, static routes, routes learned by other EIGRP autonomous systems, or routes from other protocols. You configure route map with the redistribution to control which routes are passed into EIGRP. A route map allows you to filter routes based on attributes such as the destination, origination protocol, route type, route tag, and so on. See [Configuring Route Policy Manager](#).

You also configure the default metric that is used for all imported routes into EIGRP.

Load Balancing

You can use load balancing to allow a router to distribute traffic over all the router network ports that are the same distance from the destination address. Load balancing increases the utilization of network segments, which increases effective network bandwidth.

Cisco NX-OS supports the Equal Cost Multiple Paths (ECMP) feature with up to 32 equal-cost paths in the EIGRP route table and the unicast RIB. You can configure EIGRP to load balance traffic across some or all of those paths.



Note EIGRP in Cisco NX-OS does not support unequal cost load balancing.



Note In the Cisco Nexus 3548 switch, ECMP is not supported on warp mode.

Split Horizon

You can use split horizon to ensure that EIGRP never advertises a route out of the interface where it was learned.

Split horizon is a method that controls the sending of EIGRP update and query packets. When you enable split horizon on an interface, Cisco NX-OS does not send update and query packets for destinations that were learned from this interface. Controlling update and query packets in this manner reduces the possibility of routing loops.

Split horizon with poison reverse configures EIGRP to advertise a learned route as unreachable back through that the interface that EIGRP learned the route from.

EIGRP uses split horizon or split horizon with poison reverse in the following scenarios:

- Exchanging topology tables for the first time between two routers in startup mode.
- Advertising a topology table change.
- Sending a query message.

By default, the split horizon feature is enabled on all interfaces.

Virtualization Support

Cisco NX-OS supports multiple instances of the EIGRP protocol that runs on the same system. EIGRP supports Virtual Routing and Forwarding instances (VRFs). By default, Cisco NX-OS places you in the default VRF unless you specifically configure another VRF.

By default, every instance uses the same system router ID. You can optionally configure a unique router ID for each instance.

Prerequisites for EIGRP

EIGRP has the following prerequisites:

- You must enable the EIGRP feature (see the [Enabling the EIGRP Feature](#) section).

Guidelines and Limitations for EIGRP

EIGRP has the following configuration guidelines and limitations:

- A metric configuration (either through the default-metric configuration option or through a route map) is required for redistribution from any other protocol, connected routes, or static routes (see [Configuring Route Policy Manager](#)).
- Cisco NX-OS EIGRP is compatible with EIGRP in the Cisco IOS software.
- Do not change the metric weights without a good reason. If you change the metric weights, you must apply the change to all EIGRP routers in the same autonomous system.
- Consider using stubs for larger networks.
- Avoid redistribution between different EIGRP autonomous systems because the EIGRP vector metric will not be preserved.
- The **no ip next-hop-self** command does not guarantee reachability of the next hop.
- The **ip passive-interface eigrp** command suppresses neighbors from forming.
- Cisco NX-OS does not support IGRP or connecting IGRP and EIGRP clouds.
- Autosummarization is not enabled by default.
- Cisco NX-OS supports only IP.



Note If you are familiar with the Cisco IOS CLI, be aware that the Cisco NX-OS commands for this feature might differ from the Cisco IOS commands that you would use.

Default Settings for EIGRP

Table below lists the default settings for EIGRP parameters.

Table 6: Default EIGRP Parameters

Parameters	Default
Administrative distance	<ul style="list-style-type: none"> • Internal routes—90 • External routes—170
Bandwidth percent	50 percent

Parameters	Default
Default metric for redistributed routes	<ul style="list-style-type: none"> • bandwidth—100000 Kb/s • delay—100 (10 microsecond units) • reliability—255 • loading—1 • MTU—1500
EIGRP feature	Disabled
Hello interval	5 seconds
Hold time	15 seconds
Equal-cost paths	8
Metric weights	1 0 1 0 0
Next-hop address advertised	IP address of local interface
Redistribution	Disabled
Split horizon	Enabled

Configuring Basic EIGRP

Enabling the EIGRP Feature

You must enable the EIGRP feature before you can configure EIGRP.

SUMMARY STEPS

1. **configure terminal**
2. **feature eigrp**
3. (Optional) **show feature**
4. (Optional) **copy running-config startup-config**

DETAILED STEPS

Procedure

	Command or Action	Purpose
Step 1	configure terminal Example:	Enters configuration mode.

	Command or Action	Purpose
	switch# configure terminal switch(config)#	
Step 2	feature eigrp Example: switch(config)# feature eigrp	Enables the EIGRP feature.
Step 3	(Optional) show feature Example: switch(config)# show feature	Displays information about enabled features.
Step 4	(Optional) copy running-config startup-config Example: switch(config)# copy running-config startup-config	Saves this configuration change.

Example

Use the **no feature eigrp** command to disable the EIGRP feature and remove all associated configuration.

Command	Purpose
no feature eigrp Example: switch(config)# no feature eigrp	Disables the EIGRP feature and removes all associated configuration.

Creating an EIGRP Instance

You can create an EIGRP instance and associate an interface with that instance. You assign a unique autonomous system number for this EIGRP process (see the [Autonomous Systems](#) section). Routes are not advertised or accepted from other autonomous systems unless you enable route redistribution.

Before you begin

Ensure that you have enabled the EIGRP feature (see the [Enabling the EIGRP Feature](#) section).

EIGRP must be able to obtain a router ID (for example, a configured loopback address) or you must configure the router ID option.

If you configure an instance tag that does not qualify as an AS number, you must configure the AS number explicitly or this EIGRP instance will remain in the shutdown state.

SUMMARY STEPS

1. **configure terminal**
2. **router eigrp** *instance-tag*
3. (Optional) **autonomous-system** *as-number*

4. (Optional) **log-adjacency-changes**
5. **log-neighbor-warnings** [*seconds*]
6. **interface** *interface-type slot/port*
7. **no switchport**
8. **ip router eigrp** *instance-tag*
9. (Optional) **copy running-config startup-config**

DETAILED STEPS

Procedure

	Command or Action	Purpose
Step 1	configure terminal Example: <pre>switch# configure terminal switch(config)#</pre>	Enters configuration mode.
Step 2	router eigrp <i>instance-tag</i> Example: <pre>switch(config)# router eigrp Test1 switch(config-router)#</pre>	<p>Creates a new EIGRP process with the configured instance tag. The instance tag can be any case-sensitive, alphanumeric string up to 20 characters.</p> <p>If you configure an <i>instance-tag</i> that does not qualify as an AS number, you must use the autonomous-system command to configure the AS number explicitly or this EIGRP instance will remain in the shutdown state.</p>
Step 3	(Optional) autonomous-system <i>as-number</i> Example: <pre>switch(config-router)# autonomous-system 33</pre>	Configures a unique AS number for this EIGRP instance. The range is from 1 to 65535.
Step 4	(Optional) log-adjacency-changes Example: <pre>switch(config-router)# log-adjacency-changes</pre>	Generates a system message whenever an adjacency changes state. This command is enabled by default.
Step 5	log-neighbor-warnings [<i>seconds</i>] Example: <pre>switch(config-router)# log-neighbor-warnings</pre>	Generates a system message whenever a neighbor warning occurs. You can configure the time between warning messages, from 1 to 65535, in seconds. The default is 10 seconds. This command is enabled by default.
Step 6	interface <i>interface-type slot/port</i> Example: <pre>switch(config-router)# interface ethernet 1/2 switch(config-if)#</pre>	Enters interface configuration mode. Use ? to determine the slot and port ranges.
Step 7	no switchport Example: <pre>switch(config-if)# no switchport</pre>	Configures the interface as a Layer 3 routed interface.

	Command or Action	Purpose
Step 8	ip router eigrp instance-tag Example: switch(config-if)# ip router eigrp Test1	Associates this interface with the configured EIGRP process. The instance tag can be any case-sensitive, alphanumeric string up to 20 characters.
Step 9	(Optional) copy running-config startup-config Example: switch(config)# copy running-config startup-config	Saves this configuration change.

Example

Use the **no router eigrp** command to remove the EIGRP process and the associated configuration.

Command	Purpose
no router eigrp instance-tag Example: switch(config)# no router eigrp Test1	Deletes the EIGRP process and all associated configuration.



Note You should also remove any EIGRP commands configured in interface mode if you remove the EIGRP process.

This example shows how to create an EIGRP process and configure an interface for EIGRP:

```
switch# configure terminal
switch(config)# router eigrp Test1
switch(config)# interface ethernet 1/2
switch(config-if)# no switchport
switch(config-if)# ip router eigrp Test1
switch(config-if)# no shutdown
switch(config-if)# copy running-config startup-config
```

For more information about other EIGRP parameters, see the [Configuring Advanced EIGRP](#) section.

Restarting an EIGRP Instance

You can restart an EIGRP instance. This clears all neighbors for the instance.

To restart an EIGRP instance and remove all associated neighbors, use the following commands:

Command	Purpose
flush-routes Example: switch(config)# flush-routes	Flushes all EIGRP routes in the unicast RIB when this EIGRP instance restarts.

Command	Purpose
restart eigrp <i>instance-tag</i> Example: <pre>switch(config)# restart eigrp Test1</pre>	Restarts the EIGRP instance and removes all neighbors. The instance tag can be any case-sensitive, alphanumeric string up to 20 characters.

Shutting Down an EIGRP Instance

You can gracefully shut down an EIGRP instance. This action moves all routes and adjacencies but preserves the EIGRP configuration.

To disable an EIGRP instance, use the following command in router configuration mode:

Command	Purpose
shutdown Example: <pre>switch(config-router)# shutdown</pre>	Disables this instance of EIGRP. The EIGRP router configuration remains.

Configuring a Passive Interface for EIGRP

You can configure a passive interface for EIGRP. A passive interface does not participate in EIGRP adjacency but the network address for the interface remains in the EIGRP topology table.

To configure a passive interface for EIGRP, use the following command in interface configuration mode:

Command	Purpose
ip passive-interface eigrp <i>instance-tag</i>	Suppresses EIGRP hellos, which prevents neighbors from forming and sending routing updates on an EIGRP interface. The instance tag can be any case-sensitive, alphanumeric string up to 20 characters.

Shutting Down EIGRP on an Interface

You can gracefully shut down EIGRP on an interface. This action removes all adjacencies and stops EIGRP traffic on this interface but preserves the EIGRP configuration.

To disable EIGRP on an interface, use the following command in interface configuration mode:

Command	Purpose
ip eigrp <i>instance-tag shutdown</i> Example: <pre>switch(config-router)# ip eigrp Test1 shutdown</pre>	Disables EIGRP on this interface. The EIGRP interface configuration remains. The instance tag can be any case-sensitive, alphanumeric string up to 20 characters.

Configuring Advanced EIGRP

This section includes the following topics:

Configuring Authentication in EIGRP

You can configure authentication between neighbors for EIGRP. See the [Authentication](#) section.

You can configure EIGRP authentication for the EIGRP process or for individual interfaces. Interface EIGRP authentication configuration overrides the EIGRP process-level authentication configuration.

Before you begin

Ensure that you have enabled the EIGRP feature (see the [Enabling the EIGRP Feature](#) section).

Ensure that all neighbors for an EIGRP process share the same authentication configuration, including the shared authentication key.

Create the key-chain for this authentication configuration. See the [Cisco Nexus 3548 Switch NX-OS Security Configuration Guide](#).

SUMMARY STEPS

1. **configure terminal**
2. **router eigrp** *instance-tag*
3. **address-family ipv4 unicast**
4. **authentication key-chain** *key-chain*
5. **authentication mode md5**
6. **interface** *interface-type slot/port*
7. **no switchport**
8. **ip router eigrp** *instance-tag*
9. **ip authentication key-chain eigrp** *instance-tag key-chain*
10. **ip authentication mode eigrp** *instance-tag md5*
11. (Optional) **copy running-config startup-config**

DETAILED STEPS

Procedure

	Command or Action	Purpose
Step 1	configure terminal Example: <pre>switch# configure terminal switch(config)#</pre>	Enters configuration mode.

	Command or Action	Purpose
Step 2	router eigrp <i>instance-tag</i> Example: <pre>switch(config)# router eigrp Test1 switch(config-router)#</pre>	<p>Creates a new EIGRP process with the configured instance tag. The instance tag can be any case-sensitive, alphanumeric string up to 20 characters.</p> <p>If you configure an <i>instance-tag</i> that does not qualify as an AS number, you must use the autonomous-system command to configure the AS number explicitly or this EIGRP instance will remain in the shutdown state.</p>
Step 3	address-family ipv4 unicast Example: <pre>switch(config-router)# address-family ipv4 unicast switch(config-router-af)#</pre>	<p>Enters the address-family configuration mode. This command is optional for IPv4.</p>
Step 4	authentication key-chain <i>key-chain</i> Example: <pre>switch(config-router-af)# authentication key-chain routeKeys</pre>	<p>Associates a key chain with this EIGRP process for this VRF. The key chain can be any case-sensitive, alphanumeric string up to 20 characters.</p>
Step 5	authentication mode md5 Example: <pre>switch(config-router-af)# authentication mode md5</pre>	<p>Configures MD5 message digest authentication mode for this VRF.</p>
Step 6	interface <i>interface-type slot/port</i> Example: <pre>switch(config-router-af) interface ethernet 1/2 switch(config-if)#</pre>	<p>Enters interface configuration mode. Use ? to find the supported interfaces.</p>
Step 7	no switchport Example: <pre>switch(config-if)# no switchport</pre>	<p>Configures the interface as a Layer 3 routed interface.</p>
Step 8	ip router eigrp <i>instance-tag</i> Example: <pre>switch(config-if)# ip router eigrp Test1</pre>	<p>Associates this interface with the configured EIGRP process. The instance tag can be any case-sensitive, alphanumeric string up to 20 characters.</p>
Step 9	ip authentication key-chain eigrp <i>instance-tag key-chain</i> Example: <pre>switch(config-if)# ip authentication key-chain eigrp Test1 routeKey</pre>	<p>Associates a key chain with this EIGRP process for this interface. This configuration overrides the authentication configuration set in the router VRF mode.</p> <p>The instance tag can be any case-sensitive, alphanumeric string up to 20 characters.</p>
Step 10	ip authentication mode eigrp <i>instance-tag md5</i> Example: <pre>switch(config-if)# ip authentication mode eigrp Test1 md5</pre>	<p>Configures the MD5 message digest authentication mode for this interface. This configuration overrides the authentication configuration set in the router VRF mode.</p> <p>The instance tag can be any case-sensitive, alphanumeric string up to 20 characters.</p>

	Command or Action	Purpose
Step 11	(Optional) copy running-config startup-config Example: switch(config)# copy running-config startup-config	Saves this configuration change.

Example

This example shows how to configure MD5 message digest authentication for EIGRP over Ethernet interface 1/2:

```
switch# configure terminal
switch(config)# router eigrp Test1
switch(config-router)# exit
switch(config)# interface ethernet 1/2
switch(config-if)# no switchport
switch(config-if)# ip router eigrp Test1
switch(config-if)# ip authentication key-chain eigrp Test1 routeKeys
switch(config-if)# ip authentication mode eigrp Test1 md5
switch(config-if)# copy running-config startup-config
```

Configuring EIGRP Stub Routing

To configure a router for EIGRP stub routing, use the following command in address-family configuration mode:

Command	Purpose
stub [direct receive-only redistributed [direct] leak-map <i>map-name</i>] Example: switch(config-router-af)# eigrp stub redistributed	Configures a remote router as an EIGRP stub router. The map name can be any case-sensitive, alphanumeric string up to 20 characters.

This example shows how to configure a stub router to advertise directly connected and redistributed routes:

```
switch# configure terminal
switch(config)# router eigrp Test1
switch(config-router)# address-family ipv4 unicast
switch(config-router-af)# stub direct redistributed
switch(config-router-af)# copy running-config startup-config
```

Use the `show ip eigrp neighbor detail` command to verify that a router has been configured as a stub router. The last line of the output shows the stub status of the remote or spoke router. This example shows the output from the `show ip eigrp neighbor detail` command:

```
Router# show ip eigrp neighbor detail
IP-EIGRP neighbors for process 201
H Address Interface Hold Uptime SRTT RTO Q Seq Type
(sec) (ms) Cnt Num
0 10.1.1.2 Se3/1 11 00:00:59 1 4500 0 7
Version 12.1/1.2, Retrans: 2, Retries: 0
Stub Peer Advertising ( CONNECTED SUMMARY) Routes
```

Configuring a Summary Address for EIGRP

You can configure a summary aggregate address for a specified interface. If any more specific routes are in the routing table, EIGRP will advertise the summary address out the interface with a metric equal to the minimum of all more specific routes. See the [Route Summarization](#) section.

To configure a summary aggregate address, use the following command in interface configuration mode:

Command	Purpose
ip summary-address eigrp <i>instance-tag</i> <i>ip-prefix/length</i> [<i>distance</i> leak-map <i>map-name</i>] Example: <pre>switch(config-if)# ip summary-address eigrp Test1 192.0.2.0/8</pre>	Configures a summary aggregate address as either an IP address and network mask, or an IP prefix/length. The instance tag and map name can be any case-sensitive, alphanumeric string up to 20 characters. You can optionally configure the administrative distance for this aggregate address. The default administrative distance is 5 for aggregate addresses.

This example causes EIGRP to summarize network 192.0.2.0 out Ethernet 1/2 only:

```
switch(config)# interface ethernet 1/2
switch(config-if)# no switchport
switch(config-if)# ip summary-address eigrp Test1 192.0.2.0 255.255.255.0
```

Redistributing Routes into EIGRP

Ensure that you have enabled the EIGRP feature (see the [Enabling the EIGRP Feature](#) section).

You must configure the metric (either through the default-metric configuration option or through a route map) for routes redistributed from any other protocol.

You must create a route map to control the types of routes that are redistributed into EIGRP. See [Configuring Route Policy Manager](#).

Before you begin

You can redistribute routes in EIGRP from other routing protocols.

SUMMARY STEPS

1. **configure terminal**
2. **router eigrp *instance-tag***
3. **address-family ipv4 unicast**
4. **redistribute { *bgp as* | { **eigrp** | **ospf** | **ospfv3** | **rip** } *instance-tag* | **direct** | **static** } **route-map** *name***
5. **default-metric *bandwidth delay reliability loading mtu***
6. **show ip eigrp route-map statistics redistribute**
7. (Optional) **copy running-config startup-config**

DETAILED STEPS

Procedure

	Command or Action	Purpose
Step 1	configure terminal Example: <pre>switch# configure terminal switch(config)#</pre>	Enters configuration mode.
Step 2	router eigrp <i>instance-tag</i> Example: <pre>switch(config)# router eigrp Test1 switch(config-router)#</pre>	<p>Creates a new EIGRP process with the configured instance tag. The instance tag can be any case-sensitive, alphanumeric string up to 20 characters.</p> <p>If you configure an <i>instance-tag</i> that does not qualify as an AS number, you must use the autonomous-system command to configure the AS number explicitly or this EIGRP instance will remain in the shutdown state.</p>
Step 3	address-family ipv4 unicast Example: <pre>switch(config-router)# address-family ipv4 unicast switch(config-router-af)#</pre>	Enters the address-family configuration mode. This command is optional for IPv4.
Step 4	redistribute { bgp <i>as</i> { eigrp ospf ospfv3 rip } <i>instance-tag</i> direct static } route-map <i>name</i> Example: <pre>switch(config-router-af)# redistribute bgp 100 route-map BGPFilter</pre>	Injects routes from one routing domain into EIGRP. The instance tag and map name can be any case-sensitive, alphanumeric string up to 20 characters.
Step 5	default-metric <i>bandwidth delay reliability loading mtu</i> Example: <pre>switch(config-router-af)# default-metric 500000 30 200 1 1500</pre>	<p>Sets the metrics assigned to routes learned through route redistribution. The default values are as follows:</p> <ul style="list-style-type: none"> bandwidth—100000 Kb/s delay—100 (10 microsecond units) reliability—255 loading—1 MTU—1492
Step 6	show ip eigrp route-map statistics redistribute Example: <pre>switch(config-router-af)# show ip eigrp route-map statistics redistribute bgp</pre>	Displays information about EIGRP route map statistics.
Step 7	(Optional) copy running-config startup-config Example:	Saves this configuration change.

Command or Action	Purpose
switch(config)# copy running-config startup-config	

Example

This example shows how to redistribute BGP into EIGRP for IPv4:

```
switch# configure terminal
switch(config)# router eigrp Test1
switch(config-router)# redistribute bgp 100 route-map BGPFilter
switch(config-router)# default-metric 500000 30 200 1 1500
switch(config-router)# copy running-config startup-config
```

Limiting the Number of Redistributed Routes

Route redistribution can add many routes to the EIGRP route table. You can configure a maximum limit to the number of routes accepted from external protocols. EIGRP provides the following options to configure redistributed route limits:

- **Fixed limit**—Logs a message when EIGRP reaches the configured maximum. EIGRP does not accept any more redistributed routes. You can optionally configure a threshold percentage of the maximum where EIGRP will log a warning when that threshold is passed.
- **Warning only**—Logs a warning only when EIGRP reaches the maximum. EIGRP continues to accept redistributed routes.
- **Withdraw**—Start the timeout period when EIGRP reaches the maximum. After the timeout period, EIGRP requests all redistributed routes if the current number of redistributed routes is less than the maximum limit. If the current number of redistributed routes is at the maximum limit, EIGRP withdraws all redistributed routes. You must clear this condition before EIGRP accepts more redistributed routes. You can optionally configure the timeout period.

Before you begin

Be sure the EIGRP feature is enabled (see the [Enabling the EIGRP Feature](#) section).

SUMMARY STEPS

1. **configure terminal**
2. **router eigrp** *instance-tag*
3. **redistribute** { *bgp id* | *direct* | *eigrp id* | *ospf id* | *rip id* | *static* } **route-map** *map-name*
4. **redistribute maximum-prefix** *max* [*threshold*] [**warning-only** | **withdraw** [*num-retries* *timeout*]]
5. (Optional) **show running-config eigrp**
6. (Optional) **copy running-config startup-config**

DETAILED STEPS

Procedure

	Command or Action	Purpose
Step 1	configure terminal Example: <pre>switch# configure terminal switch(config)#</pre>	Enters configuration mode.
Step 2	router eigrp instance-tag Example: <pre>switch(config)# router eigrp Test1 switch(config-router)#</pre>	Creates a new EIGRP process with the configured instance tag.
Step 3	redistribute { bgp id direct eigrp id ospf id rip id static } route-map map-name Example: <pre>switch(config-router)# redistribute bgp route-map FilterExternalBGP</pre>	Redistributes the selected protocol into EIGRP through the configured route map.
Step 4	redistribute maximum-prefix max [threshold] [warning-only withdraw [num-retries timeout]] Example: <pre>switch(config-router)# redistribute maximum-prefix 1000 75 warning-only</pre>	<p>Specifies a maximum number of prefixes that EIGRP will distribute. The range is from 0 to 65536. Optionally specifies the following:</p> <ul style="list-style-type: none"> • threshold —Percent of maximum prefixes that will trigger a warning message. • warning-only —Logs an warning message when the maximum number of prefixes is exceeded. • withdraw —Withdraws all redistributed routes. Optionally tries to retrieve the redistributed routes. The <i>num-retries</i> range is from 1 to 12. The <i>timeout</i> is from 60 to 600 seconds. The default is 300 seconds. Use clear ip eigrp redistribution if all routes are withdrawn.
Step 5	(Optional) show running-config eigrp Example: <pre>switch(config-router)# show running-config eigrp</pre>	Displays the EIGRP configuration.
Step 6	(Optional) copy running-config startup-config Example: <pre>switch(config)# copy running-config startup-config</pre>	Saves this configuration change.

Example

This example shows how to limit the number of redistributed routes into EIGRP:

```
switch# configure terminal
switch(config)# router eigrp Test1
switch(config-router)# redistribute bgp route-map FilterExternalBGP
switch(config-router)# redistribute maximum-prefix 1000 75
```

Configuring Load Balancing in EIGRP

You can configure load balancing in EIGRP. You can configure the number of Equal Cost Multiple Path (ECMP) routes using the maximum paths option.

Before you begin

Ensure that you have enabled the EIGRP feature. See the [Enabling the EIGRP Feature](#) section.

SUMMARY STEPS

1. **configure terminal**
2. **router eigrp** *instance-tag*
3. **address-family ipv4 unicast**
4. **maximum-paths** *num-paths*
5. (Optional) **copy running-config startup-config**

DETAILED STEPS**Procedure**

	Command or Action	Purpose
Step 1	configure terminal Example: <pre>switch# configure terminal switch(config)#</pre>	Enters configuration mode.
Step 2	router eigrp <i>instance-tag</i> Example: <pre>switch(config)# router eigrp Test1 switch(config-router)#</pre>	<p>Creates a new EIGRP process with the configured instance tag. The instance tag can be any case-sensitive, alphanumeric string up to 20 characters.</p> <p>If you configure an <i>instance-tag</i> that does not qualify as an autonomous system number, you must use the autonomous-system command to configure the autonomous system number explicitly or this EIGRP instance will remain in the shutdown state.</p>
Step 3	address-family ipv4 unicast Example:	Enters the address-family configuration mode. This command is optional for IPv4.

	Command or Action	Purpose
	<code>switch(config-router)# address-family ipv4 unicast</code> <code>switch(config-router-af)#</code>	
Step 4	maximum-paths <i>num-paths</i> Example: <code>switch(config-router-af)# maximum-paths 5</code>	Sets the number of equal cost paths that EIGRP will accept in the route table. The range is from 1 to 32. The default is 8.
Step 5	(Optional) copy running-config startup-config Example: <code>switch(config)# copy running-config startup-config</code>	Saves this configuration change.

Example

This example shows how to configure equal cost load balancing for EIGRP over IPv4 with a maximum of six equal cost paths:

```
switch# configure terminal
switch(config)# router eigrp Test1
switch(config-router)# maximum-paths 6
switch(config-router)# copy running-config startup-config
```

Adjusting the Interval Between Hello Packets and the Hold Time

You can adjust the interval between hello messages and the hold time.

By default, hello messages are sent every 5 seconds. The hold time is advertised in hello messages and indicates to neighbors the length of time that they should consider the sender valid. The default hold time is three times the hello interval, or 15 seconds.

To change the interval between hello packets, use the following command in interface configuration mode:

Command	Purpose
ip hello-interval eigrp <i>instance-tag seconds</i> Example: <code>switch(config-if)# ip hello-interval eigrp Test1 30</code>	Configures the hello interval for an EIGRP routing process. The instance tag can be any case-sensitive, alphanumeric string up to 20 characters. The range is from 1 to 65535 seconds. The default is 5.

On very congested and large networks, the default hold time might not be sufficient time for all routers to receive hello packets from their neighbors. In this case, you might want to increase the hold time.

To change the hold time, use the following command in interface configuration mode:

Command	Purpose
ip hold-time eigrp <i>instance-tag seconds</i> Example: <code>switch(config-if)# ip hold-time eigrp Test1 30</code>	Configures the hold time for an EIGRP routing process. The instance tag can be any case-sensitive, alphanumeric string up to 20 characters. The range is from 1 to 65535.

Use the **show ip eigrp interface detail** command to verify timer configuration.

Disabling Split Horizon

You can use split horizon to block route information from being advertised by a router out of any interface from which that information originated. Split horizon usually optimizes communications among multiple routing switches, particularly when links are broken.

By default, split horizon is enabled on all interfaces.

To disable split horizon, use the following command in interface configuration mode:

Command	Purpose
no ip split-horizon eigrp <i>instance-tag</i> Example: switch(config-if)# no ip split-horizon eigrp Test1	Disables split horizon.

Tuning EIGRP

You can configure optional parameters to tune EIGRP for your network.

You can configure the following optional parameters in address-family configuration mode:

Command	Purpose
default-information originate [always route-map <i>map-name</i>] Example: switch(config-router-af)# default-information originate always	Originates or accepts the default route with prefix 0.0.0.0/0. When a route map is supplied, the default route is originated only when the route map yields a true condition. The map name can be any case-sensitive, alphanumeric string up to 20 characters.
distance <i>internal external</i> Example : switch(config-router-af)# distance 25 100	Configures the administrative distance for this EIGRP process. The range is from 1 to 255. The internal value sets the distance for routes learned from within the same autonomous system (the default value is 90). The external value sets the distance for routes learned from an external autonomous system (the default value is 170).
metric maximum-hops <i>hop-count</i> Example: switch(config-router-af)# metric maximum-hops 70	Sets maximum allowed hops for an advertised route. Routes over this maximum are advertised as unreachable. The range is from 1 to 255. The default is 100.

Command	Purpose
<p>metric weights <i>tos k1 k2 k3 k4 k5</i></p> <p>Example:</p> <pre>switch(config-router-af)# metric weights 0 1 3 2 1 0</pre>	<p>Adjusts the EIGRP metric or K value. EIGRP uses the following formula to determine the total metric to the network:</p> $\text{metric} = [k1 * \text{bandwidth} + (k2 * \text{bandwidth}) / (256 - \text{load}) + k3 * \text{delay}] * [k5 / (\text{reliability} + k4)]$ <p>Default values and ranges are as follows:</p> <ul style="list-style-type: none"> • TOS—0. The range is from 0 to 8. • k1—1. The range is from 0 to 255. • k2—0. The range is from 0 to 255. • k3—1. The range is from 0 to 255. • k4—0. The range is from 0 to 255. • k5—0. The range is from 0 to 255.
<p>timers active-time { <i>time-limit</i> disabled }</p> <p>Example :</p> <pre>switch(config-router-af)# timers active-time 200</pre>	<p>Sets the time the router waits in minutes (after sending a query) before declaring the route to be stuck in the active (SIA) state. The range is from 1 to 65535. The default is 3.</p>

You can configure the following optional parameters in interface configuration mode:

Command	Purpose
<p>ip bandwidth eigrp <i>instance-tag bandwidth</i></p> <p>Example:</p> <pre>switch(config-if)# ip bandwidth eigrp Test1 30000</pre>	<p>Configures the bandwidth metric for EIGRP on an interface. The instance tag can be any case-sensitive, alphanumeric string up to 20 characters. The bandwidth range is from 1 to 2,560,000,000 Kb/s.</p>
<p>ip bandwidth-percent eigrp <i>instance-tag percent</i></p> <p>Example:</p> <pre>switch(config-if)# ip bandwidth-percent eigrp Test1 30</pre>	<p>Configures the percentage of bandwidth that EIGRP might use on an interface. The instance tag can be any case-sensitive, alphanumeric string up to 20 characters.</p> <p>The percent range is from 0 to 100. The default is 50.</p>
<p>no ip delay eigrp <i>instance-tag delay</i></p> <p>Example:</p> <pre>switch(config-if)# ip delay eigrp Test1 100</pre>	<p>Configures the delay metric for EIGRP on an interface. The instance tag can be any case-sensitive, alphanumeric string up to 20 characters. The delay range is from 1 to 16777215 (in tens of microseconds).</p>

Command	Purpose
<p>ip distribute-list eigrp <i>instance-tag</i> { prefix-list <i>name</i> route-map <i>name</i> } { in out }</p> <p>Example:</p> <pre>switch(config-if)# ip distribute-list eigrp Test1 route-map EigrpTest in</pre>	Configures the route filtering policy for EIGRP on this interface. The instance tag, prefix list name, and route map name can be any case-sensitive, alphanumeric string up to 20 characters.
<p>no ip next-hop-self eigrp <i>instance-tag</i></p> <p>Example:</p> <pre>switch(config-if)# ip next-hop-self eigrp Test1</pre>	Configures EIGRP to use the received next-hop address rather than the address for this interface. The default is to use the IP address of this interface for the next-hop address. The instance tag can be any case-sensitive, alphanumeric string up to 20 characters.
<p>ip offset-list eigrp <i>instance-tag</i> { prefix-list <i>name</i> route-map <i>name</i> } { in out } <i>offset</i></p> <p>Example:</p> <pre>switch(config-if)# ip offset-list eigrp Test1 prefix-list EigrpList in</pre>	Adds an offset to incoming and outgoing metrics to routes learned by EIGRP. The instance tag, prefix list name, and route map name can be any case-sensitive, alphanumeric string up to 20 characters.
<p>ip passive-interface eigrp <i>instance-tag</i></p> <p>Example:</p> <pre>switch(config-if)# ip passive-interface eigrp Test1</pre>	Suppresses EIGRP hellos, which prevents neighbors from forming and sending routing updates on an EIGRP interface. The instance tag can be any case-sensitive, alphanumeric string up to 20 characters.

Configuring Virtualization for EIGRP

You can create multiple VRFs and use the same or multiple EIGRP processes in each VRF. You assign an interface to a VRF.



Note Configure all other parameters for an interface after you configure the VRF for an interface. Configuring a VRF for an interface deletes all other configuration for that interface.

Before you begin

Ensure that you have enabled the EIGRP feature (see the [xrefEnabling the EIGRP Feature, on page 88](#) section).

SUMMARY STEPS

1. **configure terminal**
2. **vrf context** *vrf-name*
3. **router eigrp** *instance-tag*
4. **interface ethernet slot/port**
5. **no switchport**

6. **vrf member** *vrf-name*
7. **ip router eigrp** *instance-tag*
8. (Optional) **copy running-config startup-config**

DETAILED STEPS

Procedure

	Command or Action	Purpose
Step 1	configure terminal Example: <pre>switch# configure terminal switch(config)#</pre>	Enters configuration mode.
Step 2	vrf context <i>vrf-name</i> Example: <pre>switch(config)# vrf context RemoteOfficeVRF switch(config-vrf)#</pre>	Creates a new VRF and enters VRF configuration mode. The VRN name can be any case-sensitive, alphanumeric string up to 20 characters.
Step 3	router eigrp <i>instance-tag</i> Example: <pre>switch(config)# router eigrp Test1 switch(config-router)#</pre>	<p>Creates a new EIGRP process with the configured instance tag. The instance tag can be any case-sensitive, alphanumeric string up to 20 characters.</p> <p>If you configure an <i>instance-tag</i> that does not qualify as an AS number, you must use the autonomous-system command to configure the AS number explicitly or this EIGRP instance will remain in the shutdown state.</p>
Step 4	interface ethernet slot/port Example: <pre>switch(config)# interface ethernet 1/2 switch(config-if)#</pre>	Enters interface configuration mode. Use ? to find the slot and port ranges.
Step 5	no switchport Example: <pre>switch(config-if)# no switchport</pre>	Configures the interface as a Layer 3 routed interface.
Step 6	vrf member <i>vrf-name</i> Example: <pre>switch(config-if)# vrf member RemoteOfficeVRF</pre>	Adds this interface to a VRF. The VRF name can be any case-sensitive, alphanumeric string up to 20 characters.
Step 7	ip router eigrp <i>instance-tag</i> Example: <pre>switch(config-if)# ip router eigrp Test1</pre>	Adds this interface to the EIGRP process. The instance tag can be any case-sensitive, alphanumeric string up to 20 characters.
Step 8	(Optional) copy running-config startup-config Example:	Saves this configuration change.

Command or Action	Purpose
switch(config)# copy running-config startup-config	

Example

This example shows how to create a VRF and add an interface to the VRF:

```
switch# configure terminal
switch(config)# vrf context NewVRF
switch(config-vrf)# router eigrp Test1
switch(config-router)# i nterface ethernet 1/2
switch(config-if)# no switchport
switch(config-if)# ip router eigrp Test1
switch(config-if)# vrf member NewVRF
switch(config-if)# copy running-config startup-config
```

Verifying the EIGRP Configuration

To display the EIGRP configuration information, perform one of the following tasks:

Command	Purpose
show ip eigrp [<i>instance-tag</i>]	Displays a summary of the configured EIGRP processes.
show ip eigrp [<i>instance-tag</i>] interfaces [<i>type number</i>] [brief] [detail]	Displays information about all configured EIGRP interfaces.
show ip eigrp <i>instance-tag</i> neighbors [<i>type number</i>]	Displays information about all the EIGRP neighbors. Use this command to verify the EIGRP neighbor configuration.
show ip eigrp [<i>instance-tag</i>] route [<i>ip-prefix/length</i>] [active] [all-links] [detail-links] [pending] [summary] [zero-successors] [vrf <i>vrf-name</i>]	Displays information about all the EIGRP routes.
show ip eigrp [<i>instance-tag</i>] topology [<i>ip-prefix/length</i>] [active] [all-links] [detail-links] [pending] [summary] [zero-successors] [vrf <i>vrf-name</i>]	Displays information about the EIGRP topology table.
show running-configuration eigrp	Displays the current running EIGRP configuration.

Displaying EIGRP Statistics

To display EIGRP statistics, use the following commands:

Command	Purpose
show ip eigrp [<i>instance-tag</i>] accounting [vrf <i>vrf-name</i>]	Displays accounting statistics for EIGRP.

Command	Purpose
<code>show ip eigrp [instance-tag] route-map statistics redistribute</code>	Displays redistribution statistics for EIGRP.
<code>show ip eigrp [instance-tag] traffic [vrf vrf-name]</code>	Displays traffic statistics for EIGRP.

Configuration Examples for EIGRP

This example shows how to configure EIGRP:

```
feature eigrp
interface ethernet 1/2
no switchport
ip address 192.0.2.55/24
ip router eigrp Test1
no shutdown
router eigrp Test1
router-id 192.0.2.1
```

Related Topics

See [Configuring Route Policy Manager, on page 257](#) for more information on route maps.

Additional References

For additional information related to implementing EIGRP, see the following sections:

- [Related Documents](#)
- [MIBs](#)

Related Documents

Related Topic	Document Title
EIGRP CLI commands	Cisco Nexus 3000 Series Command Reference
https://www.cisco.com/c/en/us/support/docs/ip/enhanced-interior-gateway-routing-protocol-eigrp/16406-eigrp-toc.html?dtid=ossdc000283	Introduction to EIGRP Tech Note

Related Topic	Document Title
http://www.cisco.com/en/US/tech/tk365/technologies_q_and_a_item09186a008012dac4.shtml	EIGRP Frequently Asked Questions

MIBs

MIBs	MIBs Link
CISCO-EIGRP-MIB	To locate and download MIBs, go to the following: MIB Locator .



CHAPTER 6

Configuring Basic BGP

This chapter describes how to configure Border Gateway Protocol (BGP) on Cisco NX-OS switches.

This chapter includes the following sections:

- [Information About Basic BGP, on page 109](#)
- [Prerequisites for BGP, on page 115](#)
- [Guidelines and Limitations for BGP, on page 115](#)
- [CLI Configuration Modes, on page 116](#)
- [Default Settings for BGP, on page 117](#)
- [Configuring Basic BGP, on page 117](#)
- [Verifying the Basic BGP Configuration, on page 127](#)
- [Displaying BGP Statistics, on page 129](#)
- [Configuration Examples for Basic BGP, on page 129](#)
- [Related Topics, on page 130](#)
- [Where to Go Next, on page 130](#)
- [Additional References, on page 130](#)

Information About Basic BGP

Cisco NX-OS supports BGP version 4, which includes multiprotocol extensions that allow BGP to carry routing information for IP routes and multiple Layer 3 protocol address families. BGP uses TCP as a reliable transport protocol to create TCP sessions with other BGP-enabled switches.

BGP uses a path-vector routing algorithm to exchange routing information between BGP-enabled networking switches or BGP speakers. Based on this information, each BGP speaker determines a path to reach a particular destination while detecting and avoiding paths with routing loops. The routing information includes the actual route prefix for a destination, the path of autonomous systems to the destination, and additional path attributes.

BGP selects a single path, by default, as the best path to a destination host or network. Each path carries well-known mandatory, well-known discretionary, and optional transitive attributes that are used in BGP best-path analysis. You can influence BGP path selection by altering some of these attributes by configuring BGP policies. See the [Route Policies and Resetting BGP Sessions](#) section for more information.

BGP also supports load balancing or equal-cost multipath (ECMP). See the [Load Sharing and Multipath](#) section for more information.

BGP Autonomous Systems

An autonomous system (AS) is a network controlled by a single administration entity. An autonomous system forms a routing domain with one or more interior gateway protocols (IGPs) and a consistent set of routing policies. BGP supports 16-bit and 32-bit autonomous system numbers. For more information, see the [Autonomous Systems](#) section.

Separate BGP autonomous systems dynamically exchange routing information through external BGP (eBGP) peering sessions. BGP speakers within the same autonomous system can exchange routing information through internal BGP (iBGP) peering sessions.

4-Byte AS Number Support

BGP supports 2-byte or 4-byte AS numbers. Cisco NX-OS displays 4-byte AS numbers in plain-text notation (that is, as 32-bit integers). You can configure 4-byte AS numbers as either plain-text notation (for example, 1 to 4294967295), or AS.dot notation (for example, 1.0). For more information, see the [Autonomous Systems](#) section.

Administrative Distance

An administrative distance is a rating of the trustworthiness of a routing information source. By default, BGP uses the administrative distances shown in Table below.

Table 7: BGP Default Administrative Distances

Distance	Default Value	Function
External	20	Applied to routes learned from eBGP.
Internal	200	Applied to routes learned from iBGP.
Local	200	Applied to routes originated by the router.



Note The administrative distance does not influence the BGP path selection algorithm, but it does influence whether BGP-learned routes are installed in the IP routing table.

For more information, see the [Administrative Distance](#) section.

BGP Peers

A BGP speaker does not discover another BGP speaker automatically. You must configure the relationships between BGP speakers. A BGP peer is a BGP speaker that has an active TCP connection to another BGP speaker.

BGP Sessions

BGP uses TCP port 179 to create a TCP session with a peer. When a TCP connection is established between peers, each BGP peer initially exchanges all of its routes—the complete BGP routing table—with the other

peer. After this initial exchange, the BGP peers send only incremental updates when a topology change occurs in the network or when a routing policy change occurs. In the periods of inactivity between these updates, peers exchange special messages called keepalives. The hold time is the maximum time limit that can elapse between receiving consecutive BGP update or keepalive messages.

Cisco NX-OS supports the following peer configuration options:

- Individual IPv4—BGP establishes a session with the BGP speaker that matches the remote address and AS number.
- IPv4 prefix peers for a single AS number—BGP establishes sessions with BGP speakers that match the prefix and the AS number.
- Dynamic AS number prefix peers—BGP establishes sessions with BGP speakers that match the prefix and an AS number from a list of configured AS numbers.

Dynamic AS Numbers for Prefix Peers and Interface Peers

Cisco NX-OS accepts a range or list of AS numbers to establish BGP sessions. For example, if you configure BGP to use IPv4 prefix 192.0.2.0/8 and AS numbers 33, 66, and 99, BGP establishes a session with 192.0.2.1 with AS number 66 but rejects a session from 192.0.2.2 with AS number 50.

Beginning with Cisco NX-OS Release 9.3(6), support for dynamic AS numbers is extended to interface peers in addition to prefix peers. See [Configuring BGP Interface Peering via IPv6 Link-Local for IPv4 and IPv6 Address Families, on page 148](#).

Cisco NX-OS does not associate prefix peers with dynamic AS numbers as either interior BGP (iBGP) or external BGP (eBGP) sessions until after the session is established. See the chapter for more information on iBGP and eBGP.



Note The dynamic AS number prefix peer configuration overrides the individual AS number configuration that is inherited from a BGP template. For more information, see the chapter.

BGP Router Identifier

To establish BGP sessions between peers, BGP must have a router ID, which is sent to BGP peers in the OPEN message when a BGP session is established. The BGP router ID is a 32-bit value that is often represented by an IPv4 address. You can configure the router ID. By default, Cisco NX-OS sets the router ID to the IPv4 address of a loopback interface on the router. If no loopback interface is configured on the router, then the software chooses the highest IPv4 address configured to a physical interface on the router to represent the BGP router ID. The BGP router ID must be unique to the BGP peers in a network.

If BGP does not have a router ID, it cannot establish any peering sessions with BGP peers.

BGP Path Selection

Although BGP might receive advertisements for the same route from multiple sources, BGP selects only one path as the best path. BGP puts the selected path in the IP routing table and propagates the path to its peers.

The best-path algorithm runs each time that a path is added or withdrawn for a given network. The best-path algorithm also runs if you change the BGP configuration. BGP selects the best path from the set of valid paths available for a given network.

Cisco NX-OS implements the BGP best-path algorithm in the following steps:

1. **Step 1-** Compares two paths to determine which is better (see the [Step 1—Comparing Pairs of Paths](#) section).
2. **Step 2-** Iterates over all paths and determines in which order to compare the paths to select the overall best path (see the [Step 2—Determining the Order of Comparisons](#) section).
3. **Step 3-** Determines whether the old and new best paths differ enough so that the new best path should be used (see the [Step 3—Determining the Best-Path Change Suppression](#) section).



Note The order of comparison determined in Part 2 is important. Consider the case where you have three paths, A, B, and C. When Cisco NX-OS compares A and B, it chooses A. When Cisco NX-OS compares B and C, it chooses B. But when Cisco NX-OS compares A and C, it might not choose A because some BGP metrics apply only among paths from the same neighboring autonomous system and not among all paths.

The path selection uses the BGP AS-path attribute. The AS-path attribute includes the list of autonomous system numbers (AS numbers) traversed in the advertised path. If you subdivide your BGP autonomous system into a collection or confederation of autonomous systems, the AS path contains confederation segments that list these locally defined autonomous systems

Step 1—Comparing Pairs of Paths

This first step in the BGP best-path algorithm compares two paths to determine which path is better. The following sequence describes the basic steps that Cisco NX-OS uses to compare two paths to determine the better path:

1. Cisco NX-OS chooses a valid path for comparison. (For example, a path that has an unreachable next hop is not valid.)
2. Cisco NX-OS chooses the path with the highest weight.
3. Cisco NX-OS chooses the path with the highest local preference.
4. If one of the paths is locally originated, Cisco NX-OS chooses that path.
5. Cisco NX-OS chooses the path with the shorter AS path.



Note When calculating the length of the AS path, Cisco NX-OS ignores confederation segments, and counts AS sets as 1. See the [AS Confederations](#) section for more information.

6. Cisco NX-OS chooses the path with the lower origin. Interior Gateway Protocol (IGP) is considered lower than EGP.
7. Cisco NX-OS chooses the path with the lower multi- exit discriminator (MED).

You can configure a number of options that affect whether or not this step is performed. In general, Cisco NX-OS compares the MED of both paths if the paths were received from peers in the same autonomous system; otherwise, Cisco NX-OS skips the MED comparison.

You can configure Cisco NX-OS to always perform the best-path algorithm MED comparison, regardless of the peer autonomous system in the paths. See the [Tuning the Best-Path Algorithm](#) section for more

information. Otherwise, Cisco NX-OS will perform a MED comparison that depends on the AS-path attributes of the two paths being compared:

- a. If a path has no AS path or the AS path starts with an AS_SET, then the path is internal, and Cisco NX-OS compares the MED to other internal paths.
- b. If the AS path starts with an AS_SEQUENCE, then the peer autonomous system is the first AS number in the sequence, and Cisco NX-OS compares the MED to other paths that have the same peer autonomous system.
- c. If the AS path contains only confederation segments or starts with confederation segments followed by an AS_SET, the path is internal and Cisco NX-OS compares the MED to other internal paths.
- d. If the AS path starts with confederation segments followed by an AS_SEQUENCE, then the peer autonomous system is the first AS number in the AS_SEQUENCE, and Cisco NX-OS compares the MED to other paths that have the same peer autonomous system.



Note If Cisco NX-OS receives no MED attribute with the path, then Cisco NX-OS considers the MED to be 0 unless you configure the best-path algorithm to set a missing MED to the highest possible value. See the [Tuning the Best-Path Algorithm](#) section for more information.

- e. If the nondeterministic MED comparison feature is enabled, the best path algorithm uses the Cisco IOS style of MED comparison. See the [Tuning the Best-Path Algorithm](#) section for more information.
8. If one path is from an internal peer and the other path is from an external peer, then Cisco NX-OS chooses the path from the external peer.
 9. If the paths have different IGP metrics to their next-hop addresses, then Cisco NX-OS chooses the path with the lower IGP metric.
 10. Cisco NX-OS uses the path that was selected by the best-path algorithm the last time that it was run. If all path parameters in Step 1 through Step 9 are the same, then you can configure the best-path algorithm to compare the router IDs. See the [Tuning the Best-Path Algorithm](#) section for more information. If the path includes an originator attribute, then Cisco NX-OS uses that attribute as the router ID to compare to; otherwise, Cisco NX-OS uses the router ID of the peer that sent the path. If the paths have different router IDs, Cisco NX-OS chooses the path with the lower router ID.



Note When using the attribute originator as the router ID, it is possible that two paths have the same router ID. It is also possible to have two BGP sessions with the same peer router, and therefore you can receive two paths with the same router ID.

11. Cisco NX-OS selects the path with the shorter cluster length. If a path was not received with a cluster list attribute, the cluster length is 0.
12. Cisco NX-OS chooses the path received from the peer with the lower IP address. Locally generated paths (for example, redistributed paths) have a peer IP address of 0.



Note Paths that are equal after step 9 can be used for multipath if you configure multipath. See the [Load Sharing and Multipath](#) section for more information.

Step 2—Determining the Order of Comparisons

The second step of the BGP best-path algorithm implementation is to determine the order in which Cisco NX-OS compares the paths:

1. Cisco NX-OS partitions the paths into groups. Within each group Cisco NX-OS compares the MED among all paths. Cisco NX-OS uses the same rules as in the [Step 1—Comparing Pairs of Paths](#) section to determine whether MED can be compared between any two paths. Typically, this comparison results in one group being chosen for each neighbor autonomous system. If you configure the **bgp bestpath med always** command, then Cisco NX-OS chooses just one group that contains all the paths.
2. Cisco NX-OS determines the best path in each group by iterating through all paths in the group and keeping track of the best one so far. Cisco NX-OS compares each path with the temporary best path found so far and if the new path is better, it becomes the new temporary best path and Cisco NX-OS compares it with the next path in the group.
3. Cisco NX-OS forms a set of paths that contain the best path selected from each group in Step 2. Cisco NX-OS selects the overall best path from this set of paths by going through them as in Step 2.

Step 3—Determining the Best-Path Change Suppression

The next part of the implementation is to determine whether Cisco NX-OS will use the new best path or suppress the new best path. The router can continue to use the existing best path if the new one is identical to the old path (if the router ID is the same). Cisco NX-OS continues to use the existing best path to avoid route changes in the network.

You can turn off the suppression feature by configuring the best-path algorithm to compare the router IDs. See the [Tuning the Best-Path Algorithm](#) section for more information. If you configure this feature, the new best path is always preferred to the existing one.

You cannot suppress the best-path change if any of the following conditions occur:

- The existing best path is no longer valid.
- Either the existing or new best paths were received from internal (or confederation) peers or were locally generated (for example, by redistribution).
- The paths were received from the same peer (the paths have the same router ID).
- The paths have different weights, local preferences, origins, or IGP metrics to their next-hop addresses.
- The paths have different MEDs.

BGP and the Unicast RIB

BGP communicates with the unicast routing information base (unicast RIB) to store IPv4 routes in the unicast routing table. After selecting the best path, if BGP determines that the best path change needs to be reflected in the routing table, it sends a route update to the unicast RIB.

BGP receives route notifications regarding changes to its routes in the unicast RIB. It also receives route notifications about other protocol routes to support redistribution.

BGP also receives notifications from the unicast RIB regarding next-hop changes. BGP uses these notifications to keep track of the reachability and IGP metric to the next-hop addresses.

Whenever the next-hop reachability or IGP metrics in the unicast RIB change, BGP triggers a best-path recalculation for affected routes.

Prerequisites for BGP

BGP has the following prerequisites:

- You must enable the BGP feature (see the [Enabling the BGP Feature](#) section).
- You should have a valid router ID configured on the system.
- You must have an AS number, either assigned by a Regional Internet Registry (RIR) or locally administered.
- You must configure at least one IGP that is capable of recursive next-hop resolution.
- You must configure an address family under a neighbor for the BGP session establishment.

Guidelines and Limitations for BGP

BGP has the following configuration guidelines and limitations:

- The dynamic AS number prefix peer configuration overrides individual AS number configuration inherited from a BGP template.
- If you configure a dynamic AS number for prefix peers in an AS confederation, BGP establishes sessions with only the AS numbers in the local confederation.
- BGP sessions created through a dynamic AS number prefix peer ignore any configured eBGP multihop time-to-live (TTL) value or a disabled check for directly connected peers.
- You must configure a router ID for BGP to avoid automatic router ID changes and session flaps.
- You must use the maximum-prefix configuration option per peer to restrict the number of routes received and system resources used.
- You must configure the update-source to establish a session with BGP/eBGP multihop sessions.
- You must specify a BGP policy if you configure redistribution.
- You must define the BGP router ID within a VRF.
- If you decrease the keepalive and hold timer values, you might experience BGP session flaps.
- If you configure VRFs, enter the desired VRF.

CLI Configuration Modes

The following sections describe how to enter each of the CLI configuration modes for BGP. From a mode, you can enter the ? command to display the commands available in that mode.

Global Configuration Mode

Use global configuration mode to create a BGP process and configure advanced features such as AS confederation and route dampening. For more information, see [Configuring Advanced BGP](#).

This example shows how to enter router configuration mode:

```
switch# configuration
switch(config)# router bgp 64496
switch(config-router)#
```

BGP supports Virtual Routing and Forwarding (VRF). You can configure BGP within the appropriate VRF if you are using VRFs in your network. See the [Configuring Virtualization](#) section for more information.

This example shows how to enter VRF configuration mode:

```
switch(config)# router bgp 64497
switch(config-router)# vrf vrf_A
switch(config-router-vrf)#
```

Address Family Configuration Mode

You can optionally configure the address families that BGP supports. Use the **address-family** command in router configuration mode to configure features for an address family. Use the **address-family** command in neighbor configuration mode to configure the specific address family for the neighbor.

You must configure the address families if you are using route redistribution, address aggregation, load balancing, and other advanced features.

The following example shows how to enter address family configuration mode from the router configuration mode:

```
switch(config)# router bgp 64496
switch(config-router)# address-family ipv4 unicast
switch(config-router-af)#
```

The following example shows how to enter VRF address family configuration mode if you are using VRFs:

```
switch(config)# router bgp 64497
switch(config-router)# vrf vrf_A
switch(config-router-vrf)# address-family ipv4 unicast
switch(config-router-vrf-af)#
```

Neighbor Configuration Mode

Cisco NX-OS provides the neighbor configuration mode to configure BGP peers. You can use neighbor configuration mode to configure all parameters for a peer.

This example shows how to enter neighbor configuration mode:

```
switch(config)# router bgp 64496
switch(config-router)# neighbor 192.0.2.1
switch(config-router-neighbor)#
```

This example shows how to enter VRF neighbor configuration mode:

```
switch(config)# router bgp 64497
switch(config-router)# vrf vrf_A
switch(config-router-vrf)# neighbor 192.0.2.1
switch(config-router-vrf-neighbor)#
```

Neighbor Address Family Configuration Mode

An address family configuration submode inside the neighbor configuration submode is available for entering address family-specific neighbor configuration and enabling the address family for the neighbor. Use this mode for advanced features such as limiting the number of prefixes allowed for this neighbor and removing private AS numbers for eBGP.

This example shows how to enter neighbor address family configuration mode:

```
switch(config)# router bgp 64496
switch(config-router)# neighbor 192.0.2.1
switch(config-router-neighbor)# address-family ipv4 unicast
switch(config-router-neighbor-af)#
```

This example shows how to enter VRF neighbor address family configuration mode:

```
switch(config)# router bgp 64497
switch(config-router)# vrf vrf_A
switch(config-router-vrf)# neighbor 209.165.201.1
switch(config-router-vrf-neighbor)# address-family ipv4 unicast
switch(config-router-vrf-neighbor-af)#
```

Default Settings for BGP

Table below lists the default settings for BGP parameters.

Table 8: Default BGP Parameters

Parameters	Default
BGP feature	Disabled
keep alive interval	60 seconds
hold timer	180 seconds

Configuring Basic BGP

To configure a basic BGP, you need to enable BGP and configure a BGP peer. Configuring a basic BGP network consists of a few required tasks and many optional tasks. You must configure a BGP routing process and BGP peers.

Enabling the BGP Feature

Before you begin

You must enable the BGP feature before you can configure BGP.

SUMMARY STEPS

1. **configure terminal**
2. **feature bgp**
3. (Optional) **show feature**
4. (Optional) **copy running-config startup-config**

DETAILED STEPS

Procedure

	Command or Action	Purpose
Step 1	configure terminal Example: switch# configure terminal switch(config)#	Enters configuration mode.
Step 2	feature bgp Example: switch(config)# feature bgp	Enables the BGP feature.
Step 3	(Optional) show feature Example: switch(config)# show feature	Displays enabled and disabled features.
Step 4	(Optional) copy running-config startup-config Example: switch(config)# copy running-config startup-config	Saves this configuration change.

Example

Use the **no feature bgp** command to disable the BGP feature and remove all associated configuration.

Command	Purpose
no feature bgp Example: switch(config)# no feature bgp	Disables the BGP feature and removes all associated configuration.

Creating a BGP Instance

You can create a BGP instance and assign a router ID to the BGP instance. See the BGP Router Identifier section. Cisco NX-OS supports 2-byte or 4-byte autonomous system (AS) numbers in plain-text notation or as.dot notation. See the [4-Byte AS Number Support](#) section for more information.

Before you begin

Ensure that you have enabled the BGP feature (see the [Enabling the BGP Feature](#) section).

BGP must be able to obtain a router ID (for example, a configured loopback address).

SUMMARY STEPS

1. **configure terminal**
2. **router bgp** *autonomous-system-number*
3. (Optional) **router-id** *ip-address*
4. (Optional) **address-family ipv4 unicast**
5. (Optional) **network** *ip-prefix* [**route-map** *map-name*]
6. (Optional) **show bgp all**
7. (Optional) **copy running-config startup-config**

DETAILED STEPS

Procedure

	Command or Action	Purpose
Step 1	configure terminal Example: <pre>switch# configure terminal switch(config)#</pre>	Enters configuration mode.
Step 2	router bgp <i>autonomous-system-number</i> Example: <pre>switch(config)# router bgp 64496 switch(config-router)#</pre>	Enables BGP and assigns the AS number to the local BGP speaker. The AS number can be a 16-bit integer or a 32-bit integer in the form of a higher 16-bit decimal number and a lower 16-bit decimal number in xx.xx format.
Step 3	(Optional) router-id <i>ip-address</i> Example: <pre>switch(config-router)# router-id 192.0.2.255</pre>	Configures the BGP router ID. This IP address identifies this BGP speaker. This command triggers an automatic notification and session reset for the BGP neighbor sessions.
Step 4	(Optional) address-family ipv4 unicast Example: <pre>switch(config-router)# address-family ipv4 unicast switch(config-router-af)#</pre>	Enters global address family configuration mode for the specified address family. This command triggers an automatic notification and session reset for all BGP neighbors.
Step 5	(Optional) network <i>ip-prefix</i> [route-map <i>map-name</i>] Example:	Specifies a network as local to this autonomous system and adds it to the BGP routing table.

	Command or Action	Purpose
	<code>switch(config-router-af)# network 192.0.2.0</code>	For exterior protocols, the network command controls which networks are advertised. Interior protocols use the network command to determine where to send updates.
Step 6	(Optional) show bgp all Example: <code>switch(config-router-af)# show bgp all</code>	Displays information about all BGP address families.
Step 7	(Optional) copy running-config startup-config Example: <code>switch(config)# copy running-config startup-config</code>	Saves this configuration change.

Example

Use the **no router bgp** command to remove the BGP process and the associated configuration.

Command	Purpose
no router bgp <i>autonomous-system-number</i> Example: <code>switch(config)# no router bgp 201</code>	Deletes the BGP process and the associated configuration.

This example shows how to enable BGP with the IPv4 unicast address family and manually add one network to advertise:

```
switch# configure terminal
switch(config)# router bgp 64496
switch(config-router)# address-family ipv4 unicast
switch(config-router-af)# network 192.0.2.0
switch(config-router-af)# copy running-config startup-config
```

Restarting a BGP Instance

You can restart a BGP instance and clear all peer sessions for the instance.

To restart a BGP instance and remove all associated peers, use the following command:

Command	Purpose
restart bgp <i>instance-tag</i> Example: <code>switch(config)# restart bgp 201</code>	Restarts the BGP instance and resets or reestablishes all peering sessions.

Shutting Down BGP

You can shut down the BGP protocol and gracefully disable BGP and retain the configuration.

To shut down BGP, use the following command in router configuration mode:

Command	Purpose
shutdown Example: switch(config-router)# shutdown	Gracefully shuts down BGP.

Configuring BGP Peers

You can configure a BGP peer within a BGP process. Each BGP peer has an associated keepalive timer and hold timers. You can set these timers either globally or for each BGP peer. A peer configuration overrides a global configuration.



Note You must configure the address family under neighbor configuration mode for each peer.

Before you begin

Ensure that you have enabled the BGP feature (see the [Enabling the BGP Feature](#) section).

SUMMARY STEPS

1. **configure terminal**
2. **router bgp** *autonomous-system-number*
3. **neighbor** *ip-address* { **ipv4** } **remote-as** *as-number*
4. (Optional) **description** *text*
5. (Optional) **timers** *keepalive-time hold-time*
6. (Optional) **shutdown**
7. **address-family** **ipv4** **unicast**
8. (Optional) **show bgp ipv4 unicast neighbors**
9. (Optional) **copy running-config startup-config**

DETAILED STEPS

Procedure

	Command or Action	Purpose
Step 1	configure terminal Example: switch# configure terminal switch(config)#	Enters configuration mode.

	Command or Action	Purpose
Step 2	router bgp <i>autonomous-system-number</i> Example: <pre>switch(config)# router bgp 64496 switch(config-router)#</pre>	Enables BGP and assigns the AS number to the local BGP speaker. The AS number can be a 16-bit integer or a 32-bit integer in the form of a higher 16-bit decimal number and a lower 16-bit decimal number in xx.xx format.
Step 3	neighbor ip-address { ipv4 } remote-as as-number Example: <pre>switch(config-router)# neighbor 209.165.201.1 remote-as 64497 switch(config-router-neighbor)#</pre>	Configures the specified type and AS number for a remote BGP peer. The <i>ip-address</i> format is x.x.x.x.
Step 4	(Optional) description <i>text</i> Example: <pre>switch(config-router-neighbor)# description Peer Router B switch(config-router-neighbor)#</pre>	Adds a description for the neighbor. The description is an alphanumeric string up to 80 characters.
Step 5	(Optional) timers <i>keepalive-time hold-time</i> Example: <pre>switch(config-router-neighbor)# timers 30 90</pre>	Adds the keepalive and hold time BGP timer values for the neighbor. The range is from 0 to 3600 seconds. The default is 60 seconds for the keepalive time and 180 seconds for the hold time. Note BGP sessions with a hold-timer of 10 seconds or less are not effective until the BGP session has been up for 60 seconds or more. Once the session has been up for 60 seconds, the hold-timer will work as configured.
Step 6	(Optional) shutdown Example: <pre>switch(config-router-neighbor)# shutdown</pre>	Administratively shuts down this BGP neighbor. This command triggers an automatic notification and session reset for the BGP neighbor sessions.
Step 7	address-family ipv4 unicast Example: <pre>switch(config-router-neighbor)# address-family ipv4 unicast switch(config-router-neighbor-af)#</pre>	Enters neighbor address family configuration mode for the unicast specified address family.
Step 8	(Optional) show bgp ipv4 unicast neighbors Example: <pre>switch(config-router-neighbor-af)# show bgp ipv4 unicast neighbors</pre>	Displays information about BGP peers.
Step 9	(Optional) copy running-config startup-config Example: <pre>switch(config)# copy running-config startup-config</pre>	Saves this configuration change.

Example

This example shows how to configure a BGP peer:

```

switch# configure terminal
switch(config)# router bgp 64496
switch(config-router)# neighbor 192.0.2.1 remote-as 64497
switch(config-router-neighbor)# description Peer Router B
switch(config-router-neighbor)# address-family ipv4 unicast
switch(config-router-neighbor-af)# copy running-config startup-config

```

Configuring Dynamic AS Numbers for Prefix Peers

You can configure multiple BGP peers within a BGP process. You can limit BGP session establishment to a single AS number or multiple AS numbers in a route map.

BGP sessions configured through dynamic AS numbers for prefix peers ignore the **ebgp-multihop** command and the **disable-connected-check** command.

You can change the list of AS numbers in the route map, but you must use the **no neighbor** command to change the route-map name. Changes to the AS numbers in the configured route map affect only new sessions.

Before you begin

Ensure that you have enabled the BGP feature.

SUMMARY STEPS

1. **configure terminal**
2. **router bgp** *autonomous-system-number*
3. **neighbor** *prefix remote-as route-map map-name*
4. **show bgp ipv4 unicast neighbors**
5. (Optional) **copy running-config startup-config**

DETAILED STEPS

Procedure

	Command or Action	Purpose
Step 1	configure terminal Example: <pre> switch# configure terminal switch(config)# </pre>	Enters configuration mode.
Step 2	router bgp <i>autonomous-system-number</i> Example: <pre> switch(config)# router bgp 64496 switch(config-router)# </pre>	Enables BGP and assigns the AS number to the local BGP speaker. The AS number can be a 16-bit integer or a 32-bit integer in the form of a higher 16-bit decimal number and a lower 16-bit decimal number in xx.xx format.

	Command or Action	Purpose
Step 3	neighbor <i>prefix</i> remote-as route-map <i>map-name</i> Example: <pre>switch(config-router)# neighbor 192.0.2.0/8 remote-as routemap BGPPeers switch(config-router-neighbor)#</pre>	Configures the IPv4prefix and a route map for the list of accepted AS numbers for the remote BGP peers. The <i>map-name</i> can be any case-sensitive, alphanumeric string up to 63 characters.
Step 4	show bgp ipv4 unicast neighbors Example: <pre>switch(config-router-neighbor-af)# show bgp ipv4 unicast neighbors</pre>	Displays information about BGP peers.
Step 5	(Optional) copy running-config startup-config Example: <pre>switch(config)# copy running-config startup-confi</pre>	Saves this configuration change.

Example

This example shows how to configure dynamic AS numbers for a prefix peer:

```
switch# configure terminal
switch(config)# route-map BGPPeers
switch(config-route-map)# match as-number 64496, 64501-64510
switch(config-route-map)# match as-number as-path-list List1, List2
switch(config-route-map)# exit
switch(config)# router bgp 64496
switch(config-router)# neighbor 192.0.2.0/8 remote-as route-map BGPPeers
switch(config-router-neighbor)# description Peer Router B
switch(config-router-neighbor)# address-family ipv4 unicast
switch(config-router-neighbor-af)# copy running-config startup-config
```

Clearing BGP Information

To clear BGP information, use the following commands:

Command	Purpose
clear bgp all { <i>neighbor</i> * <i>as-number</i> peer-template <i>name</i> <i>prefix</i> } [vrf <i>vrf-name</i>]	<p>Clears one or more neighbors from all address families. * clears all neighbors in all address families. The arguments are as follows:</p> <ul style="list-style-type: none"> • <i>neighbor</i> —IPv4address of a neighbor. • <i>as-number</i> — Autonomous system number. The AS number can be a 16-bit integer or a 32-bit integer in the form of higher 16-bit decimal number and a lower 16-bit decimal number in xx.xx format. • <i>name</i> —Peer template name. The name can be any case-sensitive, alphanumeric string up to 64 characters. • <i>prefix</i> —IPv4prefix. All neighbors within that prefix are cleared. • <i>vrf-name</i> —VRF name. All neighbors in that VRF are cleared. The name can be any case-sensitive, alphanumeric string up to 64 characters.
clear bgp all dampening [vrf <i>vrf-name</i>]	Clears route flap dampening networks in all address families. The <i>vrf-name</i> can be any case-sensitive, alphanumeric string up to 64 characters.
clear bgp all flap-statistics [vrf <i>vrf-name</i>]	Clears route flap statistics in all address families. The <i>vrf-name</i> can be any case-sensitive, alphanumeric string up to 64 characters.
clear bgp unicast dampening [vrf <i>vrf-name</i>]	Clears route flap dampening networks in the selected address family. The <i>vrf-name</i> can be any case-sensitive, alphanumeric string up to 64 characters.
clear bgp unicast flap-statistics [vrf <i>vrf-name</i>]	Clears route flap statistics in the selected address family. The <i>vrf-name</i> can be any case-sensitive, alphanumeric string up to 64 characters.
clear bgp { ipv4 } unicast { <i>neighbor</i> * <i>as-number</i> peer-template <i>name</i> <i>prefix</i> } [vrf <i>vrf-name</i>]	<p>Clears one or more neighbors from all address families. * clears all neighbors in all address families. The arguments are as follows:</p> <ul style="list-style-type: none"> • <i>neighbor</i> —IPv4address of a neighbor. • <i>as-number</i> — Autonomous system number. The AS number can be a 16-bit integer or a 32-bit integer in the form of higher 16-bit decimal number and a lower 16-bit decimal number in xx.xx format. • <i>name</i> —Peer template name. The name can be any case-sensitive, alphanumeric string up to 64 characters. • <i>prefix</i> —IPv4prefix. All neighbors within that prefix are cleared. • <i>vrf-name</i> —VRF name. All neighbors in that VRF are cleared. The name can be any case-sensitive, alphanumeric string up to 64 characters.

Command	Purpose
<pre>clear bgp { ip { unicast } { neighbor * as-number peer-template <i>name</i> <i>prefix</i> } [vrf <i>vrf-name</i>]</pre>	<p>Clears one or more neighbors from all address families. * clears all neighbors in all address families. The arguments are as follows:</p> <ul style="list-style-type: none"> • <i>neighbor</i> —IPv4address of a neighbor. • <i>as-number</i> — Autonomous system number. The AS number can be a 16-bit integer or a 32-bit integer in the form of higher 16-bit decimal number and a lower 16-bit decimal number in xx.xx format. • <i>name</i> —Peer template name. The name can be any case-sensitive, alphanumeric string up to 64 characters. • <i>prefix</i> —IPv4prefix. All neighbors within that prefix are cleared. • <i>vrf-name</i> —VRF name. All neighbors in that VRF are cleared. The name can be any case-sensitive, alphanumeric string up to 64 characters.
<pre>clear ip bgp dampening [<i>ip-neighbor</i> <i>ip-prefix</i>] [vrf <i>vrf-name</i>]</pre>	<p>Clears route flap dampening in one or more networks. The arguments are as follows:</p> <ul style="list-style-type: none"> • <i>ip-neighbor</i> —IPv4 address of a neighbor. • <i>ip-prefix</i> —IPv4. All neighbors within that prefix are cleared. • <i>vrf-name</i> —VRF name. All neighbors in that VRF are cleared. The name can be any case-sensitive, alphanumeric string up to 64 characters.
<pre>clear ip bgp flap-statistics [<i>ip-neighbor</i> <i>ip-prefix</i>] [vrf <i>vrf-name</i>]</pre>	<p>Clears route flap statistics in one or more networks. The arguments are as follows:</p> <ul style="list-style-type: none"> • <i>ip-neighbor</i> —IPv4 address of a neighbor. • <i>ip-prefix</i> —IPv4. All neighbors within that prefix are cleared. • <i>vrf-name</i> —VRF name. All neighbors in that VRF are cleared. The name can be any case-sensitive, alphanumeric string up to 64 characters.

Command	Purpose
clear ip mbgp { ip {unicast } { <i>neighbor</i> * <i>as-number</i> peer-template <i>name</i> <i>prefix</i> } [vrf <i>vrf-name</i>]	Clears one or more neighbors from all address families. * clears all neighbors in all address families. The arguments are as follows: <ul style="list-style-type: none"> • <i>neighbor</i> —IPv4address of a neighbor. • <i>as-number</i> — Autonomous system number. The AS number can be a 16-bit integer or a 32-bit integer in the form of higher 16-bit decimal number and a lower 16-bit decimal number in xx.xx format. • <i>name</i> —Peer template name. The name can be any case-sensitive, alphanumeric string up to 64 characters. • <i>prefix</i> —IPv4prefix. All neighbors within that prefix are cleared. • <i>vrf-name</i> —VRF name. All neighbors in that VRF are cleared. The name can be any case-sensitive, alphanumeric string up to 64 characters.
clear ip mbgp dampening [<i>ip-neighbor</i> <i>ip-prefix</i>] [vrf <i>vrf-name</i>]	Clears route flap dampening in one or more networks. The arguments are as follows: <ul style="list-style-type: none"> • <i>ip-neighbor</i> —IPv4 address of a neighbor. • <i>ip-prefix</i> —IPv4. All neighbors within that prefix are cleared. • <i>vrf-name</i> —VRF name. All neighbors in that VRF are cleared. The name can be any case-sensitive, alphanumeric string up to 64 characters.
clear ip mbgp flap statistics [<i>ip-neighbor</i> <i>ip-prefix</i>] [vrf <i>vrf-name</i>]	Clears route flap statistics one or more networks. The arguments are as follows: <ul style="list-style-type: none"> • <i>ip-neighbor</i> —IPv4 address of a neighbor. • <i>ip-prefix</i> —IPv4. All neighbors within that prefix are cleared. • <i>vrf-name</i> —VRF name. All neighbors in that VRF are cleared. The name can be any case-sensitive, alphanumeric string up to 64 characters.

Verifying the Basic BGP Configuration

To display the BGP configuration information, perform one of the following tasks:

Command	Purpose
show bgp all [summary] [vrf <i>vrf-name</i>]	Displays the BGP information for all address families.
show bgp convergence [vrf <i>vrf-name</i>]	Displays the BGP information for all address families.

Command	Purpose
show bgp { ipv4 { unicast } [ip-address] community { regex expression [community] [no-advertise] [no-export] [no-export-subconfed] } [vrf vrf-name]	Displays the BGP routes that match a BGP community.
show bgp [vrf vrf-name] { ip } { unicast } [ip-address] community-list list-name [vrf vrf-name]	Displays the BGP routes that match a BGP community list.
show bgp ip { unicast } [ip-address] extcommunity { regex expression generic [non-transitive transitive] aa4:nn [exact-match] } [vrf vrf-name]	Displays the BGP routes that match a BGP extended community.
show bgp ip { unicast } [ip-address] extcommunity-list list-name [exact-match] [vrf vrf-name]	Displays the BGP routes that match a BGP extended community list.
show bgp ip { unicast } [ip-address] { dampening dampened-paths [regex expression] } [vrf vrf-name]	Displays the information for BGP route dampening. Use the clear bgp dampening command to clear the route flap dampening information.
show bgp ip { unicast } [ip-address] history-paths [regex expression] [vrf vrf-name]	Displays the BGP route history paths.
show bgp ip { unicast } [ip-address] filter-list list-name [vrf vrf-name]	Displays the information for the BGP filter list.
show bgp ip { unicast } [ip-address] neighbors [ip-address] [vrf vrf-name]	Displays the information for BGP peers. Use the clear bgp neighbors command to clear these neighbors.
show bgp ip { unicast } [ip-address] { nexthop nexthop-database } [vrf vrf-name]	Displays the information for the BGP route next hop.
show bgp paths	Displays the BGP path information.
show bgp ip { unicast } [ip-address] policy name [vrf vrf-name]	Displays the BGP policy information. Use the clear bgp policy command to clear the policy information.
show bgp ip { unicast } [ip-address] prefix-list list-name [vrf vrf-name]	Displays the BGP routes that match the prefix list.
show bgp ip { unicast } [ip-address] received-paths [vrf vrf-name]	Displays the BGP paths stored for soft reconfiguration.
show bgp ip { unicast } [ip-address] regex expression [vrf vrf-name]	Displays the BGP routes that match the AS_path regular expression.
show bgp ip { unicast } [ip-address] route-map map-name [vrf vrf-name]	Displays the BGP routes that match the route map.
show bgp peer-policy name [vrf vrf-name]	Displays the information about BGP peer policies.
show bgp peer-session name [vrf vrf-name]	Displays the information about BGP peer sessions.

Command	Purpose
show bgp peer-template name [vrf vrf-name]	Displays the information about BGP peer templates. Use the clear bgp peer-template command to clear all neighbors in a peer template.
show bgp process	Displays the BGP process information.
show ip bgp options	Displays the BGP status and configuration information. This command has multiple options. See the Cisco Nexus 3000 Series Command Reference for more information.
show ip mbgp options	Displays the BGP status and configuration information. This command has multiple options. See the Cisco Nexus 3000 Series Command Reference for more information.
show running-configuration bgp	Displays the current running BGP configuration.

Displaying BGP Statistics

To display BGP statistics, use the following commands:

Command	Purpose
show bgp ip {unicast} [ip-address] flap-statistics [vrf vrf-name]	Displays the BGP route flap statistics. Use the clear bgp flap-statistics command to clear these statistics.
show bgp sessions [vrf vrf-name]	Displays the BGP sessions for all peers. Use the clear bgp sessions command to clear these statistics.
show bgp sessions [vrf vrf-name]	Displays the BGP sessions for all peers. Use the clear bgp sessions command to clear these statistics.
show bgp statistics	Displays the BGP statistics.

Configuration Examples for Basic BGP

This example shows a basic BGP configuration:

```
feature bgp
router bgp 64496
neighbor 192.0.2.1 remote-as 64496
address-family ipv4 unicast
next-hop-self
```

Related Topics

The following topics relate to BGP:

- [Configuring Route Policy Manager](#)

Where to Go Next

See [Configuring Advanced BGP](#) for details on the following features:

- Peer templates
- Route redistribution
- Route maps

Additional References

For additional information related to implementing BGP, see the following sections:

- [Related Documents](#)
- [MIBs](#)

Related Documents

Related Topic	Document Title
BGP CLI commands	Cisco Nexus 3000 Series Command Reference

MIBs

MIBs	MIBs Link
BGP4-MIB CISCO-BGP4-MIB	To locate and download MIBs, go to the following: MIB Locator .



CHAPTER 7

Configuring Advanced BGP

This chapter describes how to configure advanced features of the Border Gateway Protocol (BGP) on Cisco NX-OS switches.

This chapter includes the following sections:

- [Information About Advanced BGP, on page 131](#)
- [Prerequisites for BGP, on page 138](#)
- [Guidelines and Limitations for Advanced BGP, on page 139](#)
- [Default Settings for BGP, on page 140](#)
- [Configuring Advanced BGP, on page 140](#)
- [Configuring an Autonomous System Path Containing Your Own Autonomous System, on page 162](#)
- [BGP Graceful Shutdown, on page 177](#)
- [Verifying the Advanced BGP Configuration, on page 189](#)
- [Displaying BGP Statistics, on page 190](#)
- [Related Topics, on page 191](#)
- [Additional References, on page 191](#)

Information About Advanced BGP

BGP is an interdomain routing protocol that provides loop-free routing between organizations or autonomous systems. Cisco NX-OS supports BGP version 4. BGP version 4 includes multiprotocol extensions that allow BGP to carry routing information for IP routes and multiple Layer 3 protocol address families. BGP uses TCP as a reliable transport protocol to create TCP sessions with other BGP-enabled switches called BGP peers. When connecting to an external organization, the router creates external BGP (eBGP) peering sessions. BGP peers within the same organization exchange routing information through internal BGP (iBGP) peering sessions.

Peer Templates

BGP peer templates allow you to create blocks of common configurations that you can reuse across similar BGP peers. Each block allows you to define a set of attributes that a peer then inherits. You can choose to override some of the inherited attributes as well, making it a very flexible scheme for simplifying the repetitive nature of BGP configurations.

Cisco NX-OS implements three types of peer templates:

- The **peer-session** template defines BGP peer session attributes, such as the transport details, remote autonomous system number of the peer, and session timers. A peer-session template can also inherit attributes from another peer-session template (with locally defined attributes that override the attributes from an inherited peer-session).
- A **peer-policy** template defines the address-family dependent policy aspects for a peer including the inbound and outbound policy, filter-lists, and prefix-lists. A peer-policy template can inherit from a set of peer-policy templates. Cisco NX-OS evaluates these peer-policy templates in the order specified by the preference value in the inherit configuration. The lowest number is preferred over higher numbers.
- The **peer** template can inherit the peer-session and peer-policy templates to allow for simplified peer definitions. It is not mandatory to use a peer template but it can simplify the BGP configuration by providing reusable blocks of configuration.

Authentication

You can configure authentication for a BGP neighbor session. This authentication method adds an MD5 authentication digest to each TCP segment sent to the neighbor to protect BGP against unauthorized messages and TCP security attacks.



Note The MD5 password must be identical between BGP peers.

Route Policies and Resetting BGP Sessions

You can associate a route policy to a BGP peer. Route policies use route maps to control or modify the routes that BGP recognizes. You can configure a route policy for inbound or outbound route updates. The route policies can match on different criteria, such as a prefix or AS_path attribute, and selectively accept or deny the routes. Route policies can also modify the path attributes.

When you change a route policy applied to a BGP peer, you must reset the BGP sessions for that peer. Cisco NX-OS supports the following three mechanisms to reset BGP peering sessions:

- **Hard reset**—A hard reset tears down the specified peering sessions, including the TCP connection, and deletes routes coming from the specified peer. This option interrupts packet flow through the BGP network. Hard reset is disabled by default.
- **Soft reconfiguration inbound**—A soft reconfiguration inbound triggers routing updates for the specified peer without resetting the session. You can use this option if you change an inbound route policy. Soft reconfiguration inbound saves a copy of all routes received from the peer before processing the routes through the inbound route policy. If you change the inbound route policy, Cisco NX-OS passes these stored routes through the modified inbound route policy to update the route table without tearing down existing peering sessions. Soft reconfiguration inbound can use significant memory resources to store the unfiltered BGP routes. Soft reconfiguration inbound is disabled by default.
- **Route Refresh**—A route refresh updates the inbound routing tables dynamically by sending route refresh requests to supporting peers when you change an inbound route policy. The remote BGP peer responds with a new copy of its routes that the local BGP speaker processes with the modified route policy. Cisco NX-OS automatically sends an outbound route refresh of prefixes to the peer.

- BGP peers advertise the route refresh capability as part of the BGP capability negotiation when establishing the BGP peer session. Route refresh is the preferred option and enabled by default.



Note BGP also uses route maps for route redistribution, route aggregation, route dampening, and other features.

eBGP

External BGP (eBGP) allows you to connect BGP peers from different autonomous systems to exchange routing updates. Connecting to external networks enables traffic from your network to be forwarded to other networks and across the Internet.

You should use loopback interfaces for establishing eBGP peering sessions because loopback interfaces are less susceptible to interface flapping. An interface flap occurs when the interface is administratively brought up or down because of a failure or maintenance issue. See the [Configuring eBGP](#) section for information on multihop, fast external failovers, and limiting the size of the AS-path attribute

iBGP

Internal BGP (iBGP) allows you to connect BGP peers within the same autonomous system. You can use iBGP for multihomed BGP networks (networks that have more than one connection to the same external autonomous system).

The following figure shows an iBGP network within a larger BGP network.

Figure 10: iBGP Network

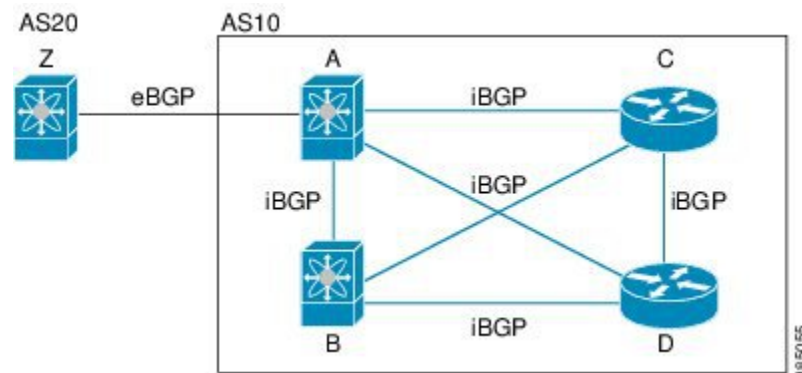

iBGP networks are fully meshed. Each iBGP peer has a direct connection to all other iBGP peers to prevent network loops.



Note You should configure a separate interior gateway protocol in the iBGP network.

AS Confederations

A fully meshed iBGP network becomes complex as the number of iBGP peers grows. You can reduce the iBGP mesh by dividing the autonomous system into multiple subautonomous systems and grouping them into a single confederation. A confederation is a group of iBGP peers that use the same autonomous system number to communicate to external networks. Each subautonomous system is fully meshed within itself and has a few connections to other subautonomous systems in the same confederation.

The following figure shows the BGP network from Figure below, split into two subautonomous systems and one confederation.

Figure 11: AS Confederation

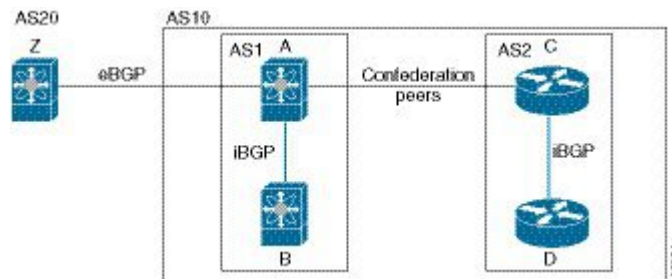

In this example, AS10 is split into two subautonomous systems, AS1 and AS2. Each subautonomous system is fully meshed, but there is only one link between the subautonomous systems. By using AS confederations, you can reduce the number of links compared to the fully meshed autonomous system in Figure 1.

Route Reflector

You can alternately reduce the iBGP mesh by using a route reflector configuration. Route reflectors pass learned routes to neighbors so that all iBGP peers do not need to be fully meshed.

Figure 1 shows a simple iBGP configuration with four meshed iBGP speakers (router A, B, C, and D). Without route reflectors, when router A receives a route from an external neighbor, it advertises the route to all three iBGP neighbors.

When you configure an iBGP peer to be a route reflector, it becomes responsible for passing iBGP learned routes to a set of iBGP neighbors.

In the following figure, router B is the route reflector. When the route reflector receives routes advertised from router A, it advertises (reflects) the routes to routers C and D. Router A no longer has to advertise to both routers C and D.

Figure 12: Route Reflector

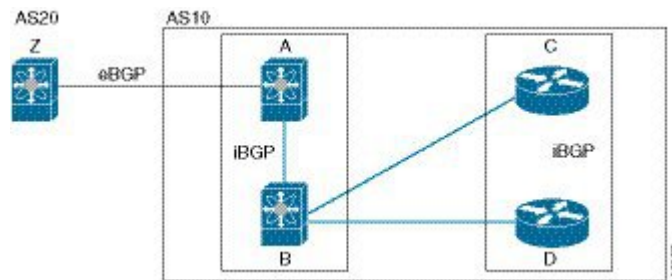

The route reflector and its client peers form a cluster. You do not have to configure all iBGP peers to act as client peers of the route reflector. You must configure any nonclient peer as fully meshed to guarantee that complete BGP updates reach all peers.

Capabilities Negotiation

A BGP speaker can learn about BGP extensions supported by a peer by using the capabilities negotiation feature. Capabilities negotiation allows BGP to use only the set of features supported by both BGP peers on a link.

If a BGP peer does not support capabilities negotiation, Cisco NX-OS will attempt a new session to the peer without capabilities negotiation if you have configured the address family as IPv4.

Route Dampening

Route dampening is a BGP feature that minimizes the propagation of flapping routes across an internetwork. A route flaps when it alternates between the available and unavailable states in rapid succession.

For example, consider a network with three BGP autonomous systems: AS1, AS2, and AS3. Suppose that a route in AS1 flaps (it becomes unavailable). Without route dampening, AS1 sends a withdraw message to AS2. AS2 propagates the withdrawal message to AS3. When the flapping route reappears, AS1 sends an advertisement message to AS2, which sends the advertisement to AS3. If the route repeatedly becomes unavailable, and then available, AS1 sends many withdrawal and advertisement messages that propagate through the other autonomous systems.

Route dampening can minimize flapping. Suppose that the route flaps. AS2 (in which route dampening is enabled) assigns the route a penalty of 1000. AS2 continues to advertise the status of the route to neighbors. Each time that the route flaps, AS2 adds to the penalty value. When the route flaps so often that the penalty exceeds a configurable suppression limit, AS2 stops advertising the route, regardless of how many times that it flaps. The route is now dampened.

The penalty placed on the route decays until the reuse limit is reached. At that time, AS2 advertises the route again. When the reuse limit is at 50 percent, AS2 removes the dampening information for the route.



Note The router does not apply a penalty to a resetting BGP peer when route dampening is enabled, even though the peer reset withdraws the route.

Load Sharing and Multipath

BGP can install multiple equal-cost eBGP or iBGP paths into the routing table to reach the same destination prefix. Traffic to the destination prefix is then shared across all the installed paths.

The BGP best-path algorithm considers the paths as equal-cost paths if the following attributes are identical:

- Weight
- Local preference
- AS_path
- Origin code

- Multi-exit discriminator (MED)
- IGP cost to the BGP next hop

BGP selects only one of these multiple paths as the best path and advertises the path to the BGP peers.



Note Paths received from different AS confederations are considered as equal-cost paths if the external AS_path values and the other attributes are identical.



Note When you configure a route reflector for iBGP multipath, and the route reflector advertises the selected best path to its peers, the next hop for the path is not modified.

Route Aggregation

You can configure aggregate addresses. Route aggregation simplifies route tables by replacing a number of more specific addresses with an address that represents all the specific addresses. For example, you can replace these three more specific addresses, 10.1.1.0/24, 10.1.2.0/24, and 10.1.3.0/24 with one aggregate address, 10.1.0.0/16.

Aggregate prefixes are present in the BGP route table so that fewer routes are advertised.



Note Cisco NX-OS does not support automatic route aggregation.

Route aggregation can lead to forwarding loops. To avoid this problem, when BGP generates an advertisement for an aggregate address, it automatically installs a summary discard route for that aggregate address in the local routing table. BGP sets the administrative distance of the summary discard to 220 and sets the route type to discard. BGP does not use discard routes for next-hop resolution.

BGP Conditional Advertisement

BGP conditional advertisement allows you to configure BGP to advertise or withdraw a route based on whether or not a prefix exists in the BGP table. This feature is useful, for example, in multihomed networks, in which you want BGP to advertise some prefixes to one of the providers only if information from the other provider is not present.

Consider an example network with three BGP autonomous systems: AS1, AS2, and AS3, where AS1 and AS3 connect to the Internet and to AS2. Without conditional advertisement, AS2 propagates all routes to both AS1 and AS3. With conditional advertisement, you can configure AS2 to advertise certain routes to AS3 only if routes from AS1 do not exist (if for example, the link to AS1 fails).

BGP conditional advertisement adds an exist or not-exist test to each route that matches the configured route map. See the [Configuring BGP Conditional Advertisement](#) section for more information.

BGP Next-Hop Address Tracking

BGP monitors the next-hop address of installed routes to verify next-hop reachability and to select, install, and validate the BGP best path. BGP next-hop address tracking speeds up this next-hop reachability test by triggering the verification process when routes change in the RIB that may affect BGP next-hop reachability.

BGP receives notifications from the RIB when next-hop information changes (event-driven notifications). BGP is notified when any of the following events occurs:

- Next hop becomes unreachable.
- Next hop becomes reachable.
- Fully recursed IGP metric to the next hop changes.
- First hop IP address or first hop interface changes.
- Next hop becomes connected.
- Next hop becomes unconnected.
- Next hop becomes a local address.
- Next hop becomes a nonlocal address.



Note Reachability and recursed metric events trigger a best-path recalculation.

Event notifications from the RIB are classified as critical and noncritical. Notifications for critical and noncritical events are sent in separate batches. However, a noncritical event is sent with the critical events if the noncritical event is pending and there is a request to read the critical events.

- Critical events are related to the reachability (reachable and unreachable), connectivity (connected and unconnected), and locality (local and nonlocal) of the next hops. Notifications for these events are not delayed.
- Noncritical events include only the IGP metric changes.

See the [Configuring BGP Next-Hop Address Tracking](#) section for more information.

Route Redistribution

You can configure BGP to redistribute static routes or routes from other protocols. You configure a route policy with the redistribution to control which routes are passed into BGP. A route policy allows you to filter routes based on attributes such as the destination, origination protocol, route type, route tag, and so on. See [Configuring Route Policy Manager](#), for more information.

Tuning BGP

You can modify the default behavior of BGP through BGP timers and by adjusting the best-path algorithm.

BGP Timers

BGP uses different types of timers for neighbor session and global protocol events. Each established session has a minimum of two timers for sending periodic keepalive messages and for timing out sessions when peer keepalives do not arrive within the expected time. In addition, there are other timers for handling specific features. Typically, you configure these timers in seconds. The timers include a random adjustment so that the same timers on different BGP peers trigger at different times.

Tuning the Best-Path Algorithm

You can modify the default behavior of the best-path algorithm through optional configuration parameters, including changing how the algorithm handles the MED attribute and the router ID.

Multiprotocol BGP

BGP on Cisco NX-OS supports multiple address families. Multiprotocol BGP (MP-BGP) carries different sets of routes depending on the address family. For example, BGP can carry one set of routes for IPv4 unicast routing. You can use MP-BGP for reverse-path forwarding (RPF) checks in IP multicast networks.



Note Because Multicast BGP does not propagate multicast state information, you need a multicast protocol, such as Protocol Independent Multicast (PIM).

Use the router address-family and neighbor address-family configuration modes to support multiprotocol BGP configurations. MP-BGP maintains separate RIBs for each configured address family, such as a unicast RIB and a multicast RIB for BGP.

A multiprotocol BGP network is backward compatible but BGP peers that do not support multiprotocol extensions cannot forward routing information, such as address family identifier information, that the multiprotocol extensions carry.

Prerequisites for BGP

BGP has the following prerequisites:

- You must enable the BGP feature (see the [Enabling the BGP Feature](#) section).
- You should have a valid router ID configured on the system.
- You must have an AS number, either assigned by a Regional Internet Registry (RIR) or locally administered.
- You must have reachability (such as an interior gateway protocol (IGP), a static route, or a direct connection) to the peer that you are trying to make a neighbor relationship with.
- You must explicitly configure an address family under a neighbor for the BGP session establishment.

Guidelines and Limitations for Advanced BGP

BGP has the following configuration guidelines and limitations:

- Prefix peering operates only in passive TCP mode. It accepts incoming connections from remote peers if the peer address falls within the prefix.
- The dynamic autonomous system number prefix peer configuration overrides the individual autonomous system number configuration that is inherited from a BGP template.
- If you configure a dynamic autonomous system number for prefix peers in an autonomous system confederation, BGP establishes sessions with only the autonomous system numbers in the local confederation.
- BGP sessions that are created through a dynamic autonomous system number prefix peer ignore any configured eBGP multihop time-to-live (TTL) value or a disabled check for directly connected peers.
- Configure a router ID for BGP to avoid automatic router ID changes and session flaps.
- Use the maximum-prefix configuration option per peer to restrict the number of routes that are received and system resources used.
- Configure the update-source to establish a session with eBGP multihop sessions.
- Specify a BGP route map if you configure redistribution.
- Configure the BGP router ID within a VRF.
- If you decrease the keepalive and hold timer values, the network might experience session flaps.
- Beginning with Cisco NX-OS Release 9.3(3), BFD for BGP is supported for BGP IPv4 and IPv6 prefix peers.
- Beginning with Cisco NX-OS Release 9.3(3), BGP prefix peers support graceful restarts. You can use the **timers prefix-peer-timeout** command in router configuration mode to configure the timeout value (in seconds) for BGP prefix peers. The default value is 90 seconds.
- The following guidelines and limitations apply to BGP Interface Peering via IPv6 Link-Local for IPv4 and IPv6 Address Families:
 - This feature does not support having the same link-local address configured across multiple interfaces.
 - This feature is not supported on logical interfaces (loopback). Only Ethernet interfaces, port-channel interfaces, subinterfaces, and breakout interfaces are supported.
 - Beginning with Cisco NX-OS Release 9.3(6), VLAN interfaces are supported.
 - This feature is supported only for IPv6-enabled interfaces with link-local addresses.
 - This feature is not supported when the configured prefix peer and interface have the same remote peer.
 - The following commands are not supported in neighbor interface configuration mode:
 - **disable-connected-check**
 - **maximum-peers**

- **update-source**
 - **ebgp-multihop**
- BFD multihop and the following commands are not supported for BGP Interface Peering via IPv6 Link-Local for IPv4 and IPv6 Address Families:
- **bfd-multihop**
 - **bfd multihop interval**
 - **bfd multihop authentication**
- BGP requires faster convergence time for route advertisements. To speed up detection of the Route Advertisement (RA) link-level protocol, enter the following commands on each IPv6-enabled interface that is using BGP Interface Peering via IPv6 Link-Local for IPv4 and IPv6 Address Families:

```
interface Ethernet port/slot
ipv6 nd ra-interval 4 min 3
ipv6 nd ra-lifetime 10
```

Default Settings for BGP

Table below lists the default settings for BGP parameters.

Table 9: Default BGP Parameters

Parameters	Default
BGP feature	disabled
keep alive interval	60 seconds
hold timer	180 seconds

Configuring Advanced BGP



Note If you are familiar with the Cisco IOS CLI, be aware that the Cisco NX-OS commands for this feature might differ from the Cisco IOS commands that you would use.

Configuring BGP Session Templates

You can use BGP session templates to simplify BGP configuration for multiple BGP peers with similar configuration needs. BGP templates allow you to reuse common configuration blocks. You configure BGP templates first, and then apply these templates to BGP peers.

With BGP session templates, you can configure session attributes such as inheritance, passwords, timers, and security.

A peer-session template can inherit from one other peer-session template. You can configure the second template to inherit from a third template. The first template also inherits this third template. This indirect inheritance can continue for up to seven peer-session templates.

Any attributes configured for the neighbor take priority over any attributes inherited by that neighbor from a BGP template.

Before you begin

Ensure that you have enabled the BGP feature (see the [Enabling the BGP Feature](#) section).

SUMMARY STEPS

1. **configure terminal**
2. **router bgp** *autonomous-system-number*
3. **template peer-session** *template-name*
4. (Optional) **password** *number password*
5. (Optional) **timers** *keepalive hold*
6. **exit**
7. **neighbor** *ip-address remote-as as-number*
8. **inherit peer-session** *template-name*
9. (Optional) **description** *text*
10. (Optional) **show bgp peer-session** *template-name*
11. (Optional) **copy running-config startup-config**

DETAILED STEPS

Procedure

	Command or Action	Purpose
Step 1	configure terminal Example: <pre>switch# configure terminal switch(config)#</pre>	Enters configuration mode.
Step 2	router bgp <i>autonomous-system-number</i> Example: <pre>switch(config)# router bgp 65536 switch(config-router)#</pre>	Enables BGP and assigns the autonomous system number to the local BGP speaker.

	Command or Action	Purpose
Step 3	template peer-session <i>template-name</i> Example: <pre>switch(config-router)# template peer-session BaseSession switch(config-router-stmp)#</pre>	Enters peer-session template configuration mode.
Step 4	(Optional) password <i>number password</i> Example: <pre>switch(config-router-stmp)# password 0 test</pre>	Adds the clear text password <i>test</i> to the neighbor. The password is stored and displayed in type 3 encrypted form (3DES).
Step 5	(Optional) timers <i>keepalive hold</i> Example: <pre>switch(config-router-stmp)# timers 30 90</pre>	Adds the BGP keepalive and holdtimer values to the peer-session template. The default keepalive interval is 60. The default hold time is 180.
Step 6	exit Example: <pre>switch(config-router-stmp)# exit switch(config-router)#</pre>	Exits peer-session template configuration mode.
Step 7	neighbor <i>ip-address remote-as as-number</i> Example: <pre>switch(config-router)# neighbor 192.168.1.2 remote-as 65536 switch(config-router-neighbor)#</pre>	Places the router in the neighbor configuration mode for BGP routing and configures the neighbor IP address.
Step 8	inherit peer-session <i>template-name</i> Example: <pre>switch(config-router-neighbor)# inherit peer-session BaseSession switch(config-router-neighbor)</pre>	Applies a peer-session template to the peer.
Step 9	(Optional) description <i>text</i> Example: <pre>switch(config-router-neighbor)# description Peer Router A switch(config-router-neighbor)</pre>	Adds a description for the neighbor.
Step 10	(Optional) show bgp peer-session <i>template-name</i> Example: <pre>switch(config-router-neighbor)# show bgp peer-session BaseSession</pre>	Displays the peer-policy template.
Step 11	(Optional) copy running-config startup-config Example: <pre>switch(config-router-neighbor)# copy running-config startup-config</pre>	Saves this configuration change.

Example

Use the **show bgp neighbor** command to see the template applied. See the [Cisco Nexus 3000 Series Command Reference](#) for details on all commands available in the template.

This example shows how to configure a BGP peer-session template and apply it to a BGP peer:

```
switch# configure terminal
switch(config)# router bgp 65536
switch(config-router)# template peer-session BaseSession
switch(config-router-stmp)# timers 30 90
switch(config-router-stmp)# exit
switch(config-router)# neighbor 192.168.1.2 remote-as 65536
switch(config-router-neighbor)# inherit peer-session BaseSession
switch(config-router-neighbor)# description Peer Router A
switch(config-router-neighbor)# address-family ipv4 unicast
switch(config-router-neighbor)# copy running-config startup-config
```

Configuring BGP Peer-Policy Templates

You can configure a peer-policy template to define attributes for a particular address family. You assign a preference to each peer-policy template and these templates are inherited in the order specified, for up to five peer-policy templates in a neighbor address family.

Cisco NX-OS evaluates multiple peer policies for an address family using the preference value. The lowest preference value is evaluated first. Any attributes configured for the neighbor take priority over any attributes inherited by that neighbor from a BGP template.

Peer-policy templates can configure address family-specific attributes such as AS-path filter lists, prefix lists, route reflection, and soft reconfiguration.

Before you begin

Ensure that you have enabled the BGP feature (see the [Enabling the BGP Feature](#) section).

SUMMARY STEPS

1. **configure terminal**
2. **router bgp** *autonomous-system-number*
3. **template peer-policy** *template-name*
4. (Optional) **advertise-active-only**
5. (Optional) **maximum-prefix** *number*
6. **exit**
7. **neighbor** *ip-address* **remote-as** *as-number*
8. **address-family** **ipv4 unicast**
9. **inherit peer-policy** *template-name preference*
10. (Optional) **show bgp peer-policy** *template-name*
11. (Optional) **copy running-config startup-config**

DETAILED STEPS

Procedure

	Command or Action	Purpose
Step 1	configure terminal Example: switch# configure terminal switch(config)#	Enters configuration mode.
Step 2	router bgp <i>autonomous-system-number</i> Example: switch(config)# router bgp 65536 switch(config-router)#	Enables BGP and assigns the autonomous system number to the local BGP speaker.
Step 3	template peer-policy <i>template-name</i> Example: switch(config-router)# template peer-policy BasePolicy switch(config-router-ptmp)#	Creates a peer-policy template.
Step 4	(Optional) advertise-active-only Example: switch(config-router-ptmp)# advertise-active-only	Advertises only active routes to the peer.
Step 5	(Optional) maximum-prefix <i>number</i> Example: switch(config-router-ptmp)# maximum-prefix 20	Sets the maximum number of prefixes allowed from this peer.
Step 6	exit Example: switch(config-router-ptmp)# exit switch(config-router)#	Exits peer-policy template configuration mode.
Step 7	neighbor <i>ip-address</i> remote-as <i>as-number</i> Example: switch(config-router)# neighbor 192.168.1.2 remote-as 65536 switch(config-router-neighbor)#	Places the router in neighbor configuration mode for BGP routing and configures the neighbor IP address.
Step 8	address-family ipv4 unicast Example: switch(config-router-neighbor)# address-family ipv4 unicast switch(config-router-neighbor-af)#	Enters global address family configuration mode for the specified address family.

	Command or Action	Purpose
Step 9	inherit peer-policy <i>template-name preference</i> Example: <pre>switch(config-router-neighbor-af)# inherit peer-policy BasePolicy 1</pre>	Applies a peer-policy template to the peer address family configuration and assigns the preference value for this peer policy.
Step 10	(Optional) show bgp peer-policy <i>template-name</i> Example: <pre>switch(config-router-neighbor-af)# show bgp peer-policy BasePolicy</pre>	Displays the peer-policy template.
Step 11	(Optional) copy running-config startup-config Example: <pre>switch(config-router-neighbor)# copy running-config startup-config</pre>	Saves this configuration change.

Example

Use the **show bgp neighbor** command to see the template applied. See the [Cisco Nexus 3000 Series Command Reference](#) for details on all commands available in the template.

This example shows how to configure a BGP peer-session template and apply it to a BGP peer:

```
switch# configure terminal
switch(config)# router bgp 65536
switch(config-router)# template peer-session BasePolicy
switch(config-router-ptmp)# maximum-prefix 20
switch(config-router-ptmp)# exit
switch(config-router)# neighbor 192.168.1.1 remote-as 65536
switch(config-router-neighbor)# address-family ipv4 unicast
switch(config-router-neighbor-af)# inherit peer-policy BasePolicy
switch(config-router-neighbor-af)# copy running-config startup-config
```

Configuring BGP Peer Templates

You can configure BGP peer templates to combine session and policy attributes in one reusable configuration block. Peer templates can also inherit peer-session or peer-policy templates. Any attributes configured for the neighbor take priority over any attributes inherited by that neighbor from a BGP template. You configure only one peer template for a neighbor, but that peer template can inherit peer-session and peer-policy templates.

Peer templates support session and address family attributes, such as eBGP multihop time-to-live, maximum prefix, next-hop self, and timers.

Before you begin

Ensure that you have enabled the BGP feature (see the [Enabling the BGP Feature](#) section).

SUMMARY STEPS

1. **configure terminal**
2. **router bgp *autonomous-system-number***

3. **template peer-session** *template-name*
4. (Optional) **inherit peer-session** *template-name*
5. **address-family ipv4 unicast**
6. (Optional) **inherit peer** *template-name*
7. **exit**
8. (Optional) **timers** *keepalive hold*
9. **exit**
10. **neighbor** *ip-address* **remote-as** *as-number*
11. **inherit peer** *template-name*
12. (Optional) **timers** *keepalive hold*
13. (Optional) **show bgp peer-template** *template-name*
14. (Optional) **copy running-config startup-config**

DETAILED STEPS

Procedure

	Command or Action	Purpose
Step 1	configure terminal Example: switch# configure terminal switch(config)#	Enters configuration mode.
Step 2	router bgp <i>autonomous-system-number</i> Example: switch(config)# router bgp 65536 switch(config-router)#	Enables BGP and assigns the autonomous system number to the local BGP speaker.
Step 3	template peer-session <i>template-name</i> Example: switch(config-router)# template peer-session BaseSession switch(config-router-stmp)#	Enters peer-session template configuration mode.
Step 4	(Optional) inherit peer-session <i>template-name</i> Example: switch(config-router-neighbor)# inherit peer-session BaseSession	Inherits a peer-session template in the peer template.
Step 5	address-family ipv4 unicast Example: switch(config-router-neighbor)# address-family ipv4 unicast switch(config-router-neighbor-af)#	Configures the global address family configuration mode for the specified address family.
Step 6	(Optional) inherit peer <i>template-name</i> Example:	Applies a peer template to the neighbor address family configuration.

	Command or Action	Purpose
	<code>switch(config-router-neighbor-af)# inherit peer BasePolicy</code>	
Step 7	exit Example: <code>switch(config-router-neighbor-af)# exit</code> <code>switch(config-router-neighbor)#</code>	Exits BGP neighbor address family configuration mode.
Step 8	(Optional) timers <i>keepalive hold</i> Example: <code>switch(config-router-neighbor)# timers 45 100</code>	Adds the BGP timer values to the peer. These values override the timer values in the peer-session template, BaseSession.
Step 9	exit Example: <code>switch(config-router-stmp)# exit</code> <code>switch(config-router)#</code>	Exits BGP peer template configuration mode.
Step 10	neighbor <i>ip-address remote-as as-number</i> Example: <code>switch(config-router)# neighbor 192.168.1.2</code> <code>remote-as 65536</code> <code>switch(config-router-neighbor)#</code>	Places the router in the neighbor configuration mode for BGP routing and configures the neighbor IP address.
Step 11	inherit peer <i>template-name</i> Example: <code>switch(config-router-neighbor)# inherit peer BasePeer</code>	Inherits the peer template.
Step 12	(Optional) timers <i>keepalive hold</i> Example: <code>switch(config-router-neighbor)# timers 60 120</code>	Adds the BGP timer values to this neighbor. These values override the timer values in the peer template and the peer-session template.
Step 13	(Optional) show bgp peer-template <i>template-name</i> Example: <code>switch(config-router-neighbor-af)# show bgp</code> <code>peer-template BasePeer</code>	Displays the peer template.
Step 14	(Optional) copy running-config startup-config Example: <code>switch(config-router-neighbor)# copy</code> <code>running-config startup-config</code>	Saves this configuration change.

Example

Use the **show bgp neighbor** command to see the template applied. See the [Cisco Nexus 3000 Series Command Reference](#) for details on all commands available in the template.

This example shows how to configure a BGP peer template and apply it to a BGP peer:

```
switch# configure terminal
switch(config)# router bgp 65536
switch(config-router)# template peer BasePeer
switch(config-router-neighbor)# inherit peer-session BaseSession
switch(config-router-neighbor)# address-family ipv4 unicast
switch(config-router-neighbor-af)# inherit peer-policy BasePolicy 1
switch(config-router-neighbor-af)# exit
switch(config-router-neighbor)# exit
switch(config-router)# neighbor 192.168.1.2 remote-as 65536
switch(config-router-neighbor)# inherit peer BasePeer
switch(config-router-neighbor)# copy running-config startup-config
```

Configuring BGP Interface Peering via IPv6 Link-Local for IPv4 and IPv6 Address Families

You can configure BGP Interface Peering via IPv6 Link-Local for IPv4 and IPv6 Address Families for automatic BGP neighbor discovery using unnumbered interfaces. Doing so allows you to set up BGP sessions using an interface name as a BGP peer (rather than interface-scoped addresses). This feature relies on ICMPv6 neighbor discovery (ND) route advertisement (RA) for automatic neighbor discovery and on RFC 5549 for sending IPv4 routes with IPv6 next hop.

Before you begin

You must enable BGP.

SUMMARY STEPS

1. **configure terminal**
2. **router bgp** *autonomous-system-number*
3. **neighbor** *interface-name* **remote-as** {*as-number* | **route-map** *map-name*}
4. **inherit peer** *template-name*
5. (Optional) **maximum-peers** *value*
6. **address-family** {**ipv4** | **ipv6**} **unicast**
7. (Optional) **show bgp** {**ipv4** | **ipv6**} **unicast neighbors** *interface*
8. (Optional) **show ip bgp neighbors** *interface-name*
9. (Optional) **show ipv6 routers** [**interface** *interface*]
10. (Optional) **copy running-config startup-config**

DETAILED STEPS

Procedure

	Command or Action	Purpose
Step 1	configure terminal Example: switch# configure terminal	Enters configuration mode.

	Command or Action	Purpose
Step 2	router bgp <i>autonomous-system-number</i> Example: <pre>switch(config)# router bgp 65535 switch(config-router)#</pre>	Enables BGP and assigns the autonomous system number to the local BGP speaker. The AS number can be a 16-bit integer or a 32-bit integer in the form of a higher 16-bit decimal number and a lower 16-bit decimal number in xx.xx format.
Step 3	neighbor <i>interface-name</i> remote-as { <i>as-number</i> route-map <i>map-name</i> } Example: <pre>switch(config-router)# neighbor Ethernet1/1 remote-as route-map Testmap switch(config-router-neighbor)#</pre>	Places the router in the neighbor configuration mode for BGP routing and configures the interface for BGP peering. Note You can specify only Ethernet interfaces, port-channel interfaces, subinterfaces, and breakout interfaces. Beginning with Cisco NX-OS Release 9.3(6), you can specify a route map, which can contain AS lists and ranges. See Dynamic AS Numbers for Prefix Peers and Interface Peers, on page 111 for more information about using dynamic AS numbers. <i>interface-name</i> can be a range if the configuration needs to be applied to more than one interface.
Step 4	inherit peer <i>template-name</i> Example: <pre>switch(config-router-neighbor)# inherit peer PEER</pre>	Inherits the peer template.
Step 5	(Optional) maximum-peers <i>value</i> Example: <pre>switch(config-router-neighbor)# maximum-peers 120</pre>	Configures the maximum number of peers for this prefix peering in neighbor configuration mode. The range is from 1 to 1000. Note The default number of sessions that can be brought up by a single interface-peer is 1.
Step 6	address-family { <i>ipv4</i> <i>ipv6</i> } unicast Example: <pre>switch(config-router-neighbor)# address-family ipv4 unicast switch(config-router-neighbor-af)#</pre>	Enters global address family configuration mode for the address family specified.
Step 7	(Optional) show bgp { <i>ipv4</i> <i>ipv6</i> } unicast neighbors <i>interface</i> Example: <pre>switch(config-router-neighbor-af)# show bgp ipv4 unicast neighbors e1/25</pre> Example: <pre>switch(config-router-neighbor-af)# show bgp ipv6 unicast neighbors 3FFE:700:20:1::11</pre>	Displays information about BGP peers.

	Command or Action	Purpose
Step 8	(Optional) show ip bgp neighbors interface-name Example: switch(config-router-neighbor-af)# show ip bgp neighbors Ethernet1/1	Displays the interface used as a BGP peer.
Step 9	(Optional) show ipv6 routers [interface interface] Example: switch(config-router-neighbor-af)# show ipv6 routers interface Ethernet1/1	Displays the link-local address of remote IPv6 routers, which is learned through IPv6 ICMP router advertisement.
Step 10	(Optional) copy running-config startup-config Example: switch(config-router-neighbor-af)# copy running-config startup-config	Saves this configuration change.

Example

This example shows how to configure BGP Interface Peering via IPv6 Link-Local for IPv4 and IPv6 Address Families using a route map:

iBGP Interface Peering Configuration for Leaf 1:

```
switch# configure terminal
switch(config)# route-map Testmap permit 10
switch(config-route-map)# match as-number 100-200, 300, 400
switch(config-route-map)# exit
switch(config)# router bgp 65000
switch(config-router)# neighbor Ethernet1/1 remote-as route-map Testmap
switch(config-router-neighbor)# inherit peer PEER
switch(config-router-neighbor)# address-family ipv4 unicast
switch(config-router-neighbor)# address-family ipv6 unicast
switch(config-router-neighbor-af)# copy running-config startup-config
```

This example shows sample output for BGP Interface Peering via IPv6 Link-Local for IPv4 and IPv6 Address Families:

```
switch(config-router-neighbor)# show bgp ipv4 unicast neighbors e1/15.1
BGP neighbor is fe80::2, remote AS 100, ibgp link, Peer index 4
Peer is an instance of interface peering Ethernet1/15.1
BGP version 4, remote router ID 5.5.5.5
Neighbor previous state = OpenConfirm
BGP state = Established, up for 2d16h
Neighbor vrf: default
Peer is directly attached, interface Ethernet1/15.1
Last read 00:00:54, hold time = 180, keepalive interval is 60 seconds
Last written 00:00:08, keepalive timer expiry due 00:00:51
Received 3869 messages, 0 notifications, 0 bytes in queue
Sent 3871 messages, 0 notifications, 0(0) bytes in queue
Enhanced error processing: On
0 discarded attributes
Connections established 2, dropped 1
Last reset by peer 2d16h, due to session closed
Last error length received: 0
Reset error value received 0
```

```
Reset error received major: 104 minor: 0
Notification data received:
Last reset by us never, due to No error
Last error length sent: 0
Reset error value sent: 0
Reset error sent major: 0 minor: 0
--More--
```

Interface Configuration:

IPv6 needs to be enabled on the corresponding interface using one of the following commands:

- **ipv6 address** *ipv6-address*
- **ipv6 address use-link-local-only**
- **ipv6 link-local** *link-local-address*

```
switch# configure terminal
switch(config)# interface Ethernet1/1
switch(config-if)# ipv6 address use-link-local-only
```



Note If an IPv4 address is not configured on the interface, the **ip forward** command must be configured on the interface to enable IPv4 forwarding.



Note IPv6 ND timers can be tuned to speed up neighbor discovery and for BGP faster route convergence.

```
switch(config-if)# ipv6 nd ra-interval 4 min 3
switch(config-if)# ipv6 nd ra-lifetime 10
```



Note Beginning with Cisco NX-OS Release 9.3(6), for customer deployments with parallel links, the following command must be added in interface mode:

```
switch(config-if)# ipv6 link-local use-bia
```

The command makes IPv6 LLA unique across different interfaces.

Configuring BGP Authentication

You can configure BGP to authenticate route updates from peers using MD5 digests.

To configure BGP to use MD5 authentication, use the following command in neighbor configuration mode:

Command	Purpose
<p>password [0 3 7] <i>string</i></p> <p>Example :</p> <pre>switch(config-router-neighbor)# password BGPpassword</pre>	<p>Configures an MD5 password for BGP neighbor sessions.</p>

Resetting a BGP Session

If you modify a route policy for BGP, you must reset the associated BGP peer sessions. If the BGP peers do not support route refresh, you can configure a soft reconfiguration for inbound policy changes. Cisco NX-OS automatically attempts a soft reset for the session.

To configure soft reconfiguration inbound, use the following command in neighbor address-family configuration mode:

Command	Purpose
soft-reconfiguration inbound Example : <pre>switch(config-router-neighbor-af) # soft-reconfiguration inbound</pre>	Enables soft reconfiguration to store the inbound BGP route updates. This command triggers an automatic soft clear or refresh of BGP neighbor sessions.

To reset a BGP neighbor session, use the following command in any mode:

Command	Purpose
clear bgp ip { unicast } ip-address soft { in out } Example : <pre>switch# clear bgp ip unicast 192.0.2.1 soft in</pre>	Resets the BGP session without tearing down the TCP session.

Modifying the Next-Hop Address

You can modify the next-hop address used in a route advertisement in the following ways:

- Disable the next-hop calculation and use the local BGP speaker address as the next-hop address.
- Set the next-hop address as a third-party address. Use this feature in situations where the original next-hop address is on the same subnet as the peer that the route is being sent to. Using this feature saves an extra hop during forwarding.

To modify the next-hop address, use the following parameters in commands address-family configuration mode:

Command	Purpose
next-hop-self Example : <pre>switch(config-router-neighbor-af) # next-hop-self</pre>	Uses the local BGP speaker address as the next-hop address in route updates. This command triggers an automatic soft clear or refresh of BGP neighbor sessions.
next-hop-third-party Example : <pre>switch(config-router-neighbor-af) # next-hop-third-party</pre>	Sets the next-hop address as a third-party address. Use this command for single-hop EBGP peers that do not have next-hop-self configured.

Configuring BGP Next-Hop Address Tracking

BGP next-hop address tracking is enabled by default and cannot be disabled.

You can modify the delay interval between RIB checks to increase the performance of BGP next-hop tracking. You can configure the critical timer for routes that affect BGP next-hop reachability, and you can configure the noncritical timer for all other routes in the BGP table.

To modify the BGP next-hop address tracking, use the following commands address-family configuration mode:

Command	Purpose
nexthop trigger-delay {critical non-critical} <i>milliseconds</i> Example : <pre>switch(config-router-af)# nexthop trigger-delay critical 5000</pre>	Specifies the next-hop address tracking delay timer for critical next-hop reachability routes and for noncritical routes. The range is from 1 to 4294967295 milliseconds. The critical timer default is 3000. The noncritical timer default is 10000.
nexthop route-map <i>name</i> Example : <pre>switch(config-router-af)# nexthop route-map nextHopLimits</pre>	Specifies a route map to match the BGP next-hop addresses to. The name can be any case-sensitive, alphanumeric string up to 63 characters.

Configuring Next-Hop Filtering

BGP next-hop filtering allows you to specify that when a next-hop address is checked with the RIB, the underlying route for that next-hop address is passed through the route map. If the route map rejects the route, the next-hop address is treated as unreachable.

BGP marks all next hops that are rejected by the route policy as invalid and does not calculate the best path for the routes that use the invalid next-hop address.

To configure BGP next-hop filtering, use the following command in address-family configuration mode:

Command	Purpose
nexthop route-map <i>name</i> Example : <pre>switch(config-router-af)# nexthop route-map nextHopLimits</pre>	Specifies a route map to match the BGP next-hop route to. The name can be any case-sensitive, alphanumeric string up to 63 characters.

Controlling Reflected Routes Through Next-Hop-Self

NX-OS enables controlling the iBGP routes being sent to a specific peer through the **next-hop-self** [all] arguments. By using these arguments, you can selectively change the next-hop of routes even if the route is reflected.

Command	Purpose
next-hop-self [all] Example: <pre>switch(config-router-af)# next-hop-self all</pre>	Uses the local BGP speaker address as the next-hop address in route updates. The all keyword is optional. If you specify all, all routes are sent to the peer with next-hop-self. If you do not specify all, the next hops of reflected routes are not changed.

Disabling Capabilities Negotiation

You can disable capabilities negotiations to interoperate with older BGP peers that do not support capabilities negotiation.

To disable capabilities negotiation, use the following command in neighbor configuration mode:

Command	Purpose
dont-capability-negotiate Example : <pre>switch(config-router-neighbor)# dont-capability-negotiate</pre>	Disables capabilities negotiation. You must manually reset the BGP sessions after configuring this command.

Configuring eBGP

This section includes the following topics:

Disabling eBGP Single-Hop Checking

You can configure eBGP to disable checking whether a single-hop eBGP peer is directly connected to the local router. Use this option for configuring a single-hop loopback eBGP session between directly connected switches.

To disable checking whether or not a single-hop eBGP peer is directly connected, use the following command in neighbor configuration mode:

Command	Purpose
disable-connected-check Example : <pre>switch(config-router-neighbor)# disable-connected-check</pre>	Disables checking whether or not a single-hop eBGP peer is directly connected. You must manually reset the BGP sessions after using this command.

Configuring eBGP Multihop

You can configure the eBGP time-to-live (TTL) value to support eBGP multihop. In some situations, an eBGP peer is not directly connected to another eBGP peer and requires multiple hops to reach the remote eBGP peer. You can configure the eBGP TTL value for a neighbor session to allow these multihop sessions.

To configure eBGP multihop, use the following command in neighbor configuration mode:

Command	Purpose
ebgp-multihop <i>ttl-value</i> Example : <pre>switch(config-router-neighbor) # ebgp-multihop 5</pre>	Configures the eBGP TTL value for eBGP multihop. The range is from 2 to 255. You must manually reset the BGP sessions after using this command.

Disabling a Fast External Failover

Typically, when a BGP router loses connectivity to a directly connected eBGP peer, BGP triggers a fast external failover by resetting the eBGP session to the peer. You can disable this fast external failover to limit the instability caused by link flaps.

To disable fast external failover, use the following command in router configuration mode:

Command	Purpose
no fast-external-failover Example : <pre>switch(config-router) # no fast-external-failover</pre>	Disables a fast external failover for eBGP peers. This command is enabled by default.

Limiting the AS-path Attribute

You can configure eBGP to discard routes that have a high number of AS numbers in the AS-path attribute.

To discard routes that have a high number of AS numbers in the AS-path attribute, use the following command in router configuration mode:

Command	Purpose
maxas-limit <i>number</i> Example : <pre>switch(config-router) # maxas-limit 50</pre>	Discards eBGP routes that have a number of AS-path segments that exceed the specified limit. The range is from 1 to 2000.

Configuring Local AS Support

The local AS feature allows a router to appear to be a member of a second autonomous system (AS), in addition to its real AS. Local AS allows two ISPs to merge without modifying peering arrangements. Routers in the merged ISP become members of the new autonomous system but continue to use their old AS numbers for their customers.

Local AS can only be used for true eBGP peers. You cannot use this feature for two peers that are members of different confederation subautonomous systems.

To configure eBGP local AS support, use the following command in neighbor configuration mode:

Command	Purpose
<p>local-as <i>number</i> [no-prepend [replace-as [dual-as]]]</p> <p>Example :</p> <pre>switch(config-router-neighbor) # local-as 1.1</pre>	<p>Configures eBGP to prepend the local AS <i>number</i> to the AS_PATH attribute.</p> <p>The local AS <i>number</i> can be a 16-bit integer or a 32-bit integer in the form of a higher 16-bit decimal number and a lower 16-bit decimal number in xx.xx format.</p> <p>The no-prepend keyword ensures that the local AS <i>number</i> is not prepended to any downstream BGP neighbors except for the partner who is peering with the local AS <i>number</i>.</p> <p>The replace-as keyword ensures that only the local AS <i>number</i> of the peering session is prepended to the AS_PATH attribute. The autonomous-system number from the local BGP routing process is not prepended.</p> <p>The dual-as keyword configures the eBGP neighbor to establish a peering session using the real autonomous-system number (from the local BGP routing process) or by using the autonomous-system number configured as the Local AS).</p>

Configuring Unnumbered BGP with IPv6 Link-Local Peering (5549) for eBGP

You can configure unnumbered BGP with IPv6 link-local peering (5549) for eBGP for automatic BGP neighbor discovery using unnumbered interfaces. Doing so allows you to set up BGP sessions using an interface name as a BGP peer (rather than interface-scoped addresses). This feature relies on ICMPv6 neighbor discovery (ND) route advertisement (RA) for automatic neighbor discovery and on RFC 5549 for sending IPv4 routes with IPv6 next hop.

Before you begin

You must enable BGP.

SUMMARY STEPS

1. **configure terminal**
2. **router bgp** *autonomous-system-number*
3. **neighbor** *interface-name* **remote-as** *as-number*
4. **inherit peer** *template-name*
5. **address-family** {**ipv4** | **ipv6**} **unicast**
6. (Optional) **show bgp** {**ipv4** | **ipv6**} **unicast neighbors** *interface*
7. (Optional) **show ip bgp neighbors** *interface-name*
8. (Optional) **show ipv6 routers** [**interface** *interface*]
9. (Optional) **copy running-config startup-config**

DETAILED STEPS

Procedure

	Command or Action	Purpose
Step 1	configure terminal Example: switch# configure terminal	Enters configuration mode.
Step 2	router bgp <i>autonomous-system-number</i> Example: switch(config)# router bgp 65535 switch(config-router)#	Enables BGP and assigns the autonomous system number to the local BGP speaker. The AS number can be a 16-bit integer or a 32-bit integer in the form of a higher 16-bit decimal number and a lower 16-bit decimal number in xx.xx format.
Step 3	neighbor <i>interface-name</i> remote-as <i>as-number</i> Example: switch(config-router)# neighbor Ethernet1/1 remote-as 65535 switch(config-router-neighbor)#	Places the router in the neighbor configuration mode for BGP routing and configures the interface for BGP peering. Note You can specify only Ethernet interfaces, port-channel interfaces, subinterfaces, and breakout interfaces.
Step 4	inherit peer <i>template-name</i> Example: switch(config-router-neighbor)# inherit peer PEER	Inherits the peer template.
Step 5	address-family {<i>ipv4</i> <i>ipv6</i>} unicast Example: switch(config-router-neighbor)# address-family ipv4 unicast switch(config-router-neighbor-af)#	Enters global address family configuration mode for the address family specified.
Step 6	(Optional) show bgp {<i>ipv4</i> <i>ipv6</i>} unicast neighbors <i>interface</i> Example: switch(config-router-neighbor-af)# show bgp ipv4 unicast neighbors e1/25 Example: switch(config-router-neighbor-af)# show bgp ipv6 unicast neighbors 3FFE:700:20:1::11	Displays information about BGP peers.
Step 7	(Optional) show ip bgp neighbors <i>interface-name</i> Example: switch(config-router-neighbor-af)# show ip bgp neighbors Ethernet1/1	Displays the interface used as a BGP peer.
Step 8	(Optional) show ipv6 routers [<i>interface interface</i>] Example:	Displays the link-local address of remote IPv6 routers, which is learned through IPv6 ICMP router advertisement.

	Command or Action	Purpose
	switch(config-router-neighbor-af)# show ipv6 routers interface Ethernet1/1	
Step 9	(Optional) copy running-config startup-config Example: switch(config-router-neighbor-af)# copy running-config startup-config	Saves this configuration change.

Example

This example shows how to configure unnumbered BGP with IPv6 link-local peering (5549) for eBGP.

iBGP Interface Peering Configuration for Leaf 1:

```
switch# configure terminal
switch(config)# router bgp 65000
switch(config-router)# neighbor Ethernet1/1 remote-as 65000
switch(config-router-neighbor)# inherit peer PEER
switch(config-router-neighbor)# address-family ipv4 unicast
switch(config-router-neighbor)# address-family ipv6 unicast
switch(config-router-neighbor-af)# copy running-config startup-config
```

This example shows sample output for unnumbered BGP with IPv6 link-local peering (5549) for eBGP.

```
switch(config-router-neighbor)# show bgp ipv4 unicast neighbors e1/15.1
BGP neighbor is fe80::2, remote AS 100, ibgp link, Peer index 4
Peer is an instance of interface peering Ethernet1/15.1
BGP version 4, remote router ID 5.5.5.5
Neighbor previous state = OpenConfirm
BGP state = Established, up for 2d16h
Neighbor vrf: default
Peer is directly attached, interface Ethernet1/15.1
Last read 00:00:54, hold time = 180, keepalive interval is 60 seconds
Last written 00:00:08, keepalive timer expiry due 00:00:51
Received 3869 messages, 0 notifications, 0 bytes in queue
Sent 3871 messages, 0 notifications, 0(0) bytes in queue
Enhanced error processing: On
0 discarded attributes
Connections established 2, dropped 1
Last reset by peer 2d16h, due to session closed
Last error length received: 0
Reset error value received 0
Reset error received major: 104 minor: 0
Notification data received:
Last reset by us never, due to No error
Last error length sent: 0
Reset error value sent: 0
Reset error sent major: 0 minor: 0
--More--
```

Interface Configuration:

IPv6 needs to be enabled on the corresponding interface using one of the following commands:

- **ipv6 address ipv6-address**

- **ipv6 address use-link-local-only**
- **ipv6 link-local** *link-local-address*

```
switch# configure terminal
switch(config)# interface Ethernet1/1
switch(config-if)# ipv6 address use-link-local-only
switch(config-if)# ipv6 nd ra-interval 4 min 3
switch(config-if)# ipv6 nd ra-lifetime 10
```



Note If an IPv4 address is not configured on the interface, the **ip forward** command must be configured on the interface to enable IPv4 forwarding.



Note IPv6 ND timers can be tuned to speed up neighbor discovery and for BGP faster route convergence.

Configuring BGP Attribute Filtering and Error Handling

Beginning with Cisco NX-OS Release 9.3(3), you can configure BGP attribute filtering and error handling to provide an increased level of security. The following features are available and implemented in the following order:

- **Path attribute treat-as-withdraw:** Allows you to treat-as-withdraw a BGP update from a specific neighbor if the update contains a specified attribute type. The prefixes contained in the update are removed from the routing table.
- **Path attribute discard:** Allows you to remove specific path attributes in a BGP update from a specific neighbor.
- **Enhanced attribute error handling:** Prevents peer sessions from flapping due to a malformed update.

Attribute types 1, 2, 3, 4, 5, 8, 14, 15, and 16 cannot be configured for path attribute treat-as-withdraw and path attribute discard. Attribute type 9 (Originator) and type 10 (Cluster-id) can be configured for eBGP neighbors only.

Treating as Withdraw Path Attributes from a BGP Update Message

To "treat-as-withdraw" BGP updates that contain specific path attributes, use the following command in router neighbor configuration mode:

Procedure

	Command or Action	Purpose
Step 1	[no] path-attribute treat-as-withdraw [<i>value</i> range start end] in Example:	Treats as withdraw any incoming BGP update messages that contain the specified path attribute or range of path attributes and triggers an inbound route refresh to ensure that the routing table is up to date. Any prefixes in a BGP

Discarding Path Attributes from a BGP Update Message

	Command or Action	Purpose
	<pre>switch#(config-router)# neighbor 10.20.30.40 switch(config-router-neighbor)# path-attribute treat-as-withdraw 100 in</pre> <p>Example:</p> <pre>switch#(config-router)# neighbor 10.20.30.40 switch(config-router-neighbor)# path-attribute treat-as-withdraw range 21 255 in</pre>	<p>update that are treat-as-withdraw are removed from the BGP routing table.</p> <p>This command is also supported for BGP template peers and BGP template peer sessions.</p>

Discarding Path Attributes from a BGP Update Message

To discard BGP updates that contain specific path attributes, use the following command in router neighbor configuration mode:

Procedure

	Command or Action	Purpose
Step 1	<p>[no] path-attribute discard [value range start end] in</p> <p>Example:</p> <pre>switch#(config-router)# neighbor 10.20.30.40 switch(config-router-neighbor)# path-attribute discard 100 in</pre> <p>Example:</p> <pre>switch#(config-router)# neighbor 10.20.30.40 switch(config-router-neighbor)# path-attribute discard range 100 255 in</pre>	<p>Drops specified path attributes in BGP update messages for the specified neighbor and triggers an inbound route refresh to ensure that the routing table is up to date. You can configure a specific attribute or an entire range of unwanted attributes.</p> <p>This command is also supported for BGP template peers and BGP template peer sessions.</p> <p>Note When the same path attribute is configured for both discard and treat-as-withdraw, treat-as-withdraw has a higher priority.</p>

Enabling or Disabling Enhanced Attribute Error Handling

BGP enhanced attribute error handling is enabled by default but can be disabled. This feature, which complies with RFC 7606, prevents peer sessions from flapping due to a malformed update. The default behavior applies to both eBGP and iBGP peers.

To disable or reenable enhanced error handling, use the following command in router configuration mode:

Procedure

	Command or Action	Purpose
Step 1	<p>[no] enhanced-error</p> <p>Example:</p> <pre>switch(config)# router bgp 1000 switch(config-router)# enhanced-error</pre>	Enables or disables BGP enhanced attribute error handling.

Displaying Discarded or Unknown Path Attributes

To display information about discarded or unknown path attributes, perform one of the following tasks:

Command	Purpose
<code>show bgp {ipv4 ipv6} unicast path-attribute discard]</code>	Displays all prefixes for which an attribute has been discarded.
<code>show bgp {ipv4 ipv6} unicast path-attribute unknown]</code>	Displays all prefixes that have an unknown attribute.
<code>show bgp {ipv4 ipv6} unicast ip-address</code>	Displays the unknown attributes and discarded attributes associated with a prefix.

The following example shows the prefixes for which an attribute has been discarded:

```
switch# show bgp ipv4 unicast path-attribute discard
Network      Next Hop
1.1.1.1/32   20.1.1.1
1.1.1.2/32   20.1.1.1
1.1.1.3/32   20.1.1.1
```

The following example shows the prefixes that have an unknown attribute:

```
switch# show bgp ipv4 unicast path-attribute unknown
Network      Next Hop
2.2.2.2/32   20.1.1.1
2.2.2.3/32   20.1.1.1
```

The following example shows the unknown attributes and discarded attributes associated with a prefix:

```
switch# show bgp ipv4 unicast 2.2.2.2
BGP routing table entry for 2.2.2.2/32, version 6241
Paths: (1 available, best #1, table default)
  Not advertised to any peer
  Refresh Epoch 1
  1000
  20.1.1.1 from 20.1.1.1 (20.1.1.1)
    Origin IGP, localpref 100, valid, external, best
    unknown transitive attribute: flag 0xE0 type 0x62 length 0x64
      value 0000 0000 0100 0000 0200 0000 0300 0000
            0400 0000 0500 0000 0600 0000 0700 0000
            0800 0000 0900 0000 0A00 0000 0B00 0000
            0C00 0000 0D00 0000 0E00 0000 0F00 0000
            1000 0000 1100 0000 1200 0000 1300 0000
            1400 0000 1500 0000 1600 0000 1700 0000
            1800 0000
    rx pathid: 0, tx pathid: 0x0
    Updated on Jul 20 2019 07:50:43 PST
```

Configuring AS Confederations

To configure an AS confederation, you must specify a confederation identifier. The group of autonomous systems within the AS confederation looks like a single autonomous system with the confederation identifier as the autonomous system number.

To configure a BGP confederation identifier, use the following command in router configuration mode:

Command	Purpose
confederation identifier <i>as-number</i> Example : <pre>switch(config-router)# confederation identifier 64512</pre>	Configures a confederation identifier for an AS confederation. Each confederation has a different sub-AS number, usually a private one (from 64512 to 65534). This command triggers an automatic notification and session reset for the BGP neighbor sessions.

To configure the autonomous systems that belong to the AS confederation, use the following command in router configuration mode:

Command	Purpose
bgp confederation peers <i>as-number</i> [<i>as-number2...</i>] Example : <pre>switch(config-router)# bgp confederation peers 5 33 44</pre>	Specifies a list of autonomous systems that belong to the confederation. This command triggers an automatic notification and session reset for the BGP neighbor sessions.

Configuring an Autonomous System Path Containing Your Own Autonomous System

Enable the feature for BGP to accept the autonomous system (AS) path that contains your own AS.

Before you begin

Ensure that you have enabled the BGP feature (see the [Enabling the BGP Feature](#) section).

SUMMARY STEPS

1. **configure terminal**
2. **router bgp** *as-number*
3. **neighbor** *ip-address* **remote-as** *as-number*
4. **address-family ipv4 unicast**
5. [**no** | **default**] **allowas-in** [*allowas-in-cnt*]
6. **end**
7. (Optional) **show running-config bgp**
8. (Optional) **copy running-config startup-config**

DETAILED STEPS

Procedure

	Command or Action	Purpose
Step 1	configure terminal Example: switch# configure terminal switch(config)#	Enters configuration mode.
Step 2	router bgp <i>as-number</i> Example: switch(config)# router bgp <i>as-number</i>	Enters BGP mode and assigns the autonomous system number to the local BGP speaker. The <i>as-number</i> value range is from 1 to 65535.
Step 3	neighbor <i>ip-address</i> remote-as <i>as-number</i> Example: switch(config-router)# neighbor 192.168.1.2 remote-as 65536 switch(config-router-neighbor)#	Places the router in neighbor configuration mode for BGP routing and configures the neighbor IP address.
Step 4	address-family ipv4 unicast Example: switch(config-router-neighbor)# address-family ipv4 unicast switch(config-router-neighbor-af)#	Enters router address family configuration for the specified address family.
Step 5	[no default] allowas-in [<i>allowas-in-cnt</i>] Example: switch(config-router-neighbor-af)# allowas-in 5	Enables the allowas-in feature for BGP and configures the number of occurrences of the AS number. For <i>allowas-in-cnt</i> , enter an integer between 1 and 10. By default, the number of occurrences of the AS number is set to 3.
Step 6	end Example: switch(config-router-neighbor-af)# end	Exits router address family configuration mode.
Step 7	(Optional) show running-config bgp Example: switch# show running-config bgp	Displays the BGP configuration.
Step 8	(Optional) copy running-config startup-config Example: switch(config-router-neighbor)# copy running-config startup-config	Saves this configuration change.

Example

This example shows how to configure the `allowas-in` feature for BGP and configure it for a unicast IPv4 address family:

```
switch# configure terminal
switch(config)# router bgp 77
switch(config-router)# neighbor 6.20.1.1 remote-as 66
switch(config-router-neighbor)# address-family ipv4 unicast
switch(config-router-neighbor-af)# allowas-in 5
switch(config-router-neighbor-af)# end
```

Configuring Route Reflector

You can configure iBGP peers as route reflector clients to the local BGP speaker, which acts as the route reflector. Together, a route reflector and its clients form a cluster. A cluster of clients usually has a single route reflector. In such instances, the cluster is identified by the router ID of the route reflector. To increase redundancy and avoid a single point of failure in the network, you can configure a cluster with more than one route reflector. You must configure all route reflectors in the cluster with the same 4-byte cluster ID so that a route reflector can recognize updates from route reflectors in the same cluster.

Before you begin

Ensure that you have enabled the BGP feature (see the [Enabling the BGP Feature](#) section).

SUMMARY STEPS

1. **configure terminal**
2. **router bgp** *as-number*
3. **cluster-id** *cluster-id*
4. **address-family ipv4 unicast**
5. (Optional) **client-to-client reflection**
6. **exit**
7. **neighbor** *ip-address* **remote-as** *as-number*
8. **address-family ipv4 unicast**
9. **route-reflector-client**
10. **show bgp ip unicast neighbors**
11. (Optional) **copy running-config startup-config**

DETAILED STEPS

Procedure

	Command or Action	Purpose
Step 1	configure terminal Example: <pre>switch# configure terminal switch(config)#</pre>	Enters configuration mode.

	Command or Action	Purpose
Step 2	router bgp <i>as-number</i> Example: <pre>switch(config)# router bgp 65536 switch(config-router)#</pre>	Enables BGP and assigns the autonomous system number to the local BGP speaker.
Step 3	cluster-id <i>cluster-id</i> Example: <pre>switch(config-router)# cluster-id 192.0.2.1</pre>	Configures the local router as one of the route reflectors that serve the cluster. You specify a cluster ID to identify the cluster. This command triggers an automatic soft clear or refresh of BGP neighbor sessions.
Step 4	address-family ipv4 unicast Example: <pre>switch(config-router-neighbor)# address-family ipv4 unicast switch(config-router-neighbor-af)#</pre>	Enters router address family configuration mode for the specified address family.
Step 5	(Optional) client-to-client reflection Example: <pre>switch(config-router-af)# client-to-client reflection</pre>	Configures client-to-client route reflection. This feature is enabled by default. This command triggers an automatic soft clear or refresh of BGP neighbor sessions.
Step 6	exit Example: <pre>switch(config-router-neighbor-af)# exit switch(config-router-neighbor)#</pre>	Exits router address configuration mode.
Step 7	neighbor ip-address remote-as <i>as-number</i> Example: <pre>switch(config-router)# neighbor 192.168.1.2 remote-as 65536 switch(config-router-neighbor)#</pre>	Configures the IP address and AS number for a remote BGP peer.
Step 8	address-family ipv4 unicast Example: <pre>switch(config-router-neighbor)# address-family ipv4 unicast switch(config-router-neighbor-af)#</pre>	Enters neighbor address family configuration mode for the specified address family.
Step 9	route-reflector-client Example: <pre>switch(config-router-neighbor-af)# route-reflector-client</pre>	Configures the switch as a BGP route reflector and configures the neighbor as its client. This command triggers an automatic notification and session reset for the BGP neighbor sessions.
Step 10	show bgp ip unicast neighbors Example: <pre>switch(config-router-neighbor-af)# show bgp ip unicast neighbors</pre>	Displays the BGP peers.

	Command or Action	Purpose
Step 11	(Optional) copy running-config startup-config Example: <pre>switch(config-router-neighbor)# copy running-config startup-config</pre>	Saves this configuration change.

Example

This example shows how to configure the router as a route reflector and add one neighbor as a client:

```
switch(config)# router bgp 65536
switch(config-router)# neighbor 192.0.2.10 remote-as 65536
switch(config-router-neighbor)# address-family ip unicast
switch(config-router-neighbor-af)# route-reflector-client
switch(config-router-neighbor-af)# copy running-config startup-config
```

Configuring Route Dampening

You can configure route dampening to minimize route flaps propagating through your iBGP network.

To configure route dampening, use the following command in address-family or VRF address family configuration mode:

Command	Purpose
dampening [{ <i>half-life reuse-limit</i> <i>suppress-limit max-suppress-time</i> route-map <i>map-name</i> }] Example : <pre>switch(config-router-af)# dampening route-map bgpDamp</pre>	Disables capabilities negotiation. The parameter values are as follows: <ul style="list-style-type: none"> • <i>half-life</i>—The range is from 1 to 45. • <i>reuse-limit</i>—The range is from 1 to 20000. • <i>suppress-limit</i>—The range is from 1 to 20000 • <i>max-suppress-time</i>—The range is from 1 to 255.

Configuring Load Sharing and ECMP

You can configure the maximum number of paths that BGP adds to the route table for equal-cost multipath load balancing.



Note ECMP is not supported on warp mode.

To configure the maximum number of paths, use the following command in router address-family configuration mode:

Command	Purpose
maximum-paths [<i>ibgp</i>] <i>maxpaths</i> Example : <pre>switch(config-router-af) # maximum-paths 12</pre>	Configures the maximum number of equal-cost paths for load sharing. The range is from 1 to 32. The default is 1. Note It is recommended you set the maximum-path to 1 in warp mode to prevent ECMP configuration.

Configuring Maximum Prefixes

You can configure the maximum number of prefixes that BGP can receive from a BGP peer. If the number of prefixes exceeds this value, you can optionally configure BGP to generate a warning message or tear down the BGP session to the peer.

To configure the maximum allowed prefixes for a BGP peer, use the following command in neighbor address-family configuration mode:

Command	Purpose
maximum-prefix <i>maximum</i> [<i>threshold</i>] [<i>restart time</i> <i>warming-only</i>] Example : <pre>switch(config-router-neighbor-af) # maximum-prefix 12</pre>	Configures the maximum number of prefixes from a peer. The parameter ranges are as follows: <ul style="list-style-type: none"> • <i>maximum</i> —The range is from 1 to 300000 • <i>Threshold</i> —The range is from 1 to 100 percent. The default is 75 percent. • <i>time</i> —The range is from 1 to 65535 minutes. This command triggers an automatic notification and session reset for the BGP neighbor sessions if the prefix limit is exceeded.

Configuring Dynamic Capability

You can configure dynamic capability for a BGP peer.

To configure dynamic capability, use the following command in neighbor configuration mode:

Command	Purpose
dynamic-capability Example : <pre>switch(config-router-neighbor) # dynamic-capability</pre>	Enables dynamic capability. This command triggers an automatic notification and session reset for the BGP neighbor sessions. This command is disabled by default.

Configuring Aggregate Addresses

You can configure aggregate address entries in the BGP route table.

To configure an aggregate address, use the following command in router address-family configuration mode:

Command	Purpose
<p>aggregate-address <i>ip-prefix/length</i> [as-set] [summary-only] [advertise-map <i>map-name</i>] [attribute-map <i>map-name</i>] [suppress-map <i>map-name</i>]</p> <p>Example :</p> <pre>switch(config-router-af)# aggregate-address 192.0.2.0/8 as-set</pre>	<p>Creates an aggregate address. The path advertised for this route is an autonomous system set that consists of all elements contained in all paths that are being summarized:</p> <ul style="list-style-type: none"> • The as-set keyword generates autonomous system set path information and community information from contributing paths. • The summary-only keyword filters all more specific routes from updates. • The advertise-map keyword and argument specify the route map used to select attribute information from selected routes. • The attribute-map keyword and argument specify the route map used to select attribute information from the aggregate. • The suppress-map keyword and argument conditionally filters more specific routes.

Configuring BGP Conditional Advertisement

You can configure BGP conditional advertisement to limit the routes that BGP propagates. You define the following two route maps:

- **Advertise map**—Specifies the conditions that the route must match before BGP considers the conditional advertisement. This route map can contain any appropriate match statements.
- **Exist map or nonexist map**—Defines the prefix that must exist in the BGP table before BGP propagates a route that matches the advertise map. The nonexist map defines the prefix that must not exist in the BGP table before BGP propagates a route that matches the advertise map. BGP processes only the permit statements in the prefix list match statements in these route maps.

If the route does not pass the condition, BGP withdraws the route if it exists in the BGP table.

Before you begin

Ensure that you have enabled the BGP feature (see the [Enabling the BGP Feature](#) section).

SUMMARY STEPS

1. **configure terminal**
2. **router bgp** *as-number*
3. **neighbor** *ip-address* **remote-as** *as-number*
4. **address-family ipv4 unicast**
5. **advertise-map** *adv-map* { **exist-map** *exist-rmap* | **non-exist-map** *nonexist-rmap* }
6. (Optional) **show ip bgp neighbor**
7. (Optional) **copy running-config startup-config**

DETAILED STEPS

Procedure

	Command or Action	Purpose
Step 1	<p>configure terminal</p> <p>Example:</p> <pre>switch# configure terminal switch(config)#</pre>	Enters configuration mode.
Step 2	<p>router bgp <i>as-number</i></p> <p>Example:</p> <pre>switch(config)# router bgp 65536 switch(config-router)#</pre>	Enters BGP mode and assigns the autonomous system number to the local BGP speaker.
Step 3	<p>neighbor <i>ip-address</i> remote-as <i>as-number</i></p> <p>Example:</p> <pre>switch(config-router)# neighbor 192.168.1.2 remote-as 65537 switch(config-router-neighbor)#</pre>	Places the router in neighbor configuration mode for BGP routing and configures the neighbor IP address.
Step 4	<p>address-family ipv4 unicast</p> <p>Example:</p> <pre>switch(config-router-neighbor)# address-family ipv4 unicast switch(config-router-neighbor-af)#</pre>	Enters address family configuration mode.
Step 5	<p>advertise-map <i>adv-map</i> { exist-map <i>exist-rmap</i> non-exist-map <i>nonexist-rmap</i> }</p> <p>Example:</p> <pre>switch(config-router-neighbor-af)# advertise-map advertise exist-map exist</pre>	<p>Configures BGP to conditionally advertise routes based on the two configured route maps:</p> <ul style="list-style-type: none"> • <i>adv-map</i>—Specifies a route map with match statements that the route must pass before BGP passes the route to the next route map. The <i>adv-map</i> is a case-sensitive, alphanumeric string up to 63 characters. • <i>exist-rmap</i>—Specifies a route map with match statements for a prefix list. A prefix in the BGP table must match a prefix in the prefix list before BGP will advertise the route. The <i>exist-rmap</i> is a case-sensitive, alphanumeric string up to 63 characters. • <i>nonexist-rmap</i>—Specifies a route map with match statements for a prefix list. A prefix in the BGP table must not match a prefix in the prefix list before BGP will advertise the route. The <i>nonexist-rmap</i> is a case-sensitive, alphanumeric string up to 63 characters.
Step 6	<p>(Optional) show ip bgp neighbor</p> <p>Example:</p>	Displays information about BGP and the configured conditional advertisement route maps.

	Command or Action	Purpose
	switch(config-router-neighbor-af)# show ip bgp neighbor	
Step 7	(Optional) copy running-config startup-config Example: switch(config-router-neighbor)# copy running-config startup-config	Saves this configuration change.

Example

This example shows how to configure BGP conditional advertisement:

```
switch# configure terminal
switch(config)# router bgp 65536
switch(config-router)# neighbor 192.0.2.2 remote-as 65537
switch(config-router-neighbor)# address-family ipv4 unicast
switch(config-router-neighbor-af)# advertise-map advertise exist-map exist
switch(config-router-neighbor-af)# exit
switch(config-router-neighbor)# exit
switch(config-router)# exit
switch(config)# route-map advertise
switch(config-route-map)# match as-path pathList
switch(config-route-map)# exit
switch(config)# route-map exit
switch(config-route-map)# match ip address prefix-list plist
switch(config-route-map)# exit
switch(config)# ip prefix-list plist permit 209.165.201.0/27
```

Configuring Route Redistribution

You can configure BGP to accept routing information from another routing protocol and redistribute that information through the BGP network. Optionally, you can assign a default route for redistributed routes.

Before you begin

Ensure that you have enabled the BGP feature (see the [Enabling the BGP Feature](#) section).

SUMMARY STEPS

1. **configure terminal**
2. **router bgp** *as-number*
3. **address-family ipv4 unicast**
4. **redistribute** { **direct** | { **eigrp** | **ospf** | **ospfv3** | **rip** } *instance-tag* | **static** } **route-map** *map-name*
5. (Optional) **default-metric** *value*
6. (Optional) **copy running-config startup-config**

DETAILED STEPS

Procedure

	Command or Action	Purpose
Step 1	configure terminal Example: switch# configure terminal switch(config)#	Enters configuration mode.
Step 2	router bgp <i>as-number</i> Example: switch(config)# router bgp 65536 switch(config-router)#	Enters BGP mode and assigns the autonomous system number to the local BGP speaker.
Step 3	address-family ipv4 unicast Example: switch(config-router-neighbor)# address-family ipv4 unicast switch(config-router-neighbor-af)#	Enters address family configuration mode.
Step 4	redistribute { direct { eigrp ospf ospfv3 rip } instance-tag static } route-map <i>map-name</i> Example: switch(config-router-af)# redistribute eigrp 201 route-map Eigrpmap	Redistributes routes from other protocols into BGP. See the Configuring Route Maps section for more information about route maps.
Step 5	(Optional) default-metric <i>value</i> Example: switch(config-router-af)# default-metric 33	Generates a default route into BGP.
Step 6	(Optional) copy running-config startup-config Example: switch(config-router-neighbor)# copy running-config startup-config	Saves this configuration change.

Example

This example shows how to redistribute EIGRP into BGP:

```
switch# configure terminal
switch(config)# router bgp 65536
switch(config-router)# address-family ipv4 unicast
switch(config-router-af)# redistribute eigrp 201 route-map Eigrpmap
switch(config-router-af)# copy running-config startup-config
```

Configuring Multiprotocol BGP

You can configure MP-BGP to support multiple address families, including IPv4 unicast routes.

Before you begin

Ensure that you have enabled the BGP feature (see the [Enabling the BGP Feature](#) section).

SUMMARY STEPS

1. **configure terminal**
2. **router bgp *as-number***
3. **neighbor *ip-address* remote-as *as-number***
4. **address-family ipv4 unicast**
5. (Optional) **copy running-config startup-config**

DETAILED STEPS

Procedure

	Command or Action	Purpose
Step 1	configure terminal Example: switch# configure terminal switch(config)#	Enters configuration mode.
Step 2	router bgp <i>as-number</i> Example: switch(config)# router bgp 65536 switch(config-router)#	Enters BGP mode and assigns the autonomous system number to the local BGP speaker.
Step 3	neighbor <i>ip-address</i> remote-as <i>as-number</i> Example: switch(config-router)# neighbor 192.168.1.2 remote-as 65537 switch(config-router-neighbor)#	Places the router in neighbor configuration mode for BGP routing and configures the neighbor IP address.
Step 4	address-family ipv4 unicast Example: switch(config-router-neighbor)# address-family ipv4 unicast switch(config-router-neighbor-af)#	Enters address family configuration mode.
Step 5	(Optional) copy running-config startup-config Example: switch(config-router-neighbor)# copy running-config startup-config	Saves this configuration change.

Tuning BGP

You can tune BGP characteristics through a series of optional parameters.

To tune BGP, use the following optional commands in router configuration mode:

Command	Purpose
<p>bestpath [always-compare-med compare-routerid igp-metric ignore med { missing-as-worst non-deterministic } as-path multipath-relax]</p> <p>Example :</p> <pre>switch(config-router)# bestpath always-compare-med switch(config-router)# bestpath as-path multipath-relax</pre>	<p>Modifies the best-path algorithm. The optional parameters are as follows:</p> <ul style="list-style-type: none"> • always-compare-med—Compares MED on paths from different autonomous systems. • compare-routerid—Compares the router IDs for identical eBGP paths. • igp-metric ignore—Ignores the Interior Gateway Protocol (IGP) metric for next hop during best-path selection. This option is supported beginning with Cisco NX-OS Release 9.2(2). • med missing-as-worst—Handles a missing MED as the highest MED. • med non-deterministic—Does not always select the best MED path from among the paths from the same autonomous systems. • as-path multipath-relax—Allows the switch to handle the paths received from different autonomous systems for multipath, if their AS-path lengths are the same and other multipath conditions are met.
<p>enforce-first-as</p> <p>Example:</p> <pre>switch(config-router)# enforce-first-as</pre>	<p>Enforces the neighbor autonomous system to be the first AS number listed in the AS_path attribute for eBGP.</p>
<p>log-neighbor-changes</p> <p>Example :</p> <pre>switch(config-router)# log-neighbor-changes</pre>	<p>Generates a system message when a neighbor changes state.</p>
<p>router-id <i>id</i></p> <p>Example :</p> <pre>switch(config-router)# router-id 209.165.20.1</pre>	<p>Manually configures the router ID for this BGP speaker.</p>

Command	Purpose
timers [bestpath-delay <i>delay</i> bgp <i>keepalive holdtime</i> prefix-peer-timeout <i>timeout</i>] Example : <pre>switch(config-router)# timers bgp 90 270</pre>	Sets the BGP timer values. The optional parameters are as follows: You must manually reset the BGP sessions after configuring this command.

To tune BGP, use the following optional command in router address-family configuration mode:

Command	Purpose
distance <i>ebgp-distance</i> <i>ibgp distance</i> <i>local-distance</i> Example : <pre>switch(config-router-af)# distance 20 100 200</pre>	Sets the administrative distance for BGP. The range is from 1 to 255. The defaults are as follows:

To tune BGP, use the following optional commands in neighbor configuration mode:

Command	Purpose
description <i>string</i> Example : <pre>switch(config-router-neighbor)# description main site</pre>	Sets a descriptive string for this BGP peer. The string can be up to 80 alphanumeric characters.
low-memory exempt Example : <pre>switch(config-router-neighbor)# low-memory exempt</pre>	Exempts this BGP neighbor from a possible shutdown due to a low memory condition.
transport connection-mode passive Example: <pre>switch(config-router-neighbor)# transport connection-mode passive</pre>	Allows a passive connection setup only. This BGP speaker does not initiate a TCP connection to a BGP peer. You must manually reset the BGP sessions after configuring this command.
remove-private-as Example : <pre>switch(config-router-neighbor)# remove-private-as</pre>	Removes private AS numbers from outbound route updates to an eBGP peer. This command triggers an automatic soft clear or refresh of BGP neighbor sessions.
update-source <i>interface-type number</i> Example : <pre>switch(config-router-neighbor)# update-source ethernet 2/1</pre>	Configures the BGP speaker to use the source IP address of the configured interface for BGP sessions to the peer. This command triggers an automatic notification and session reset for the BGP neighbor sessions.

To tune BGP, use the following optional commands in neighbor address-family configuration mode:

Command	Purpose
<p>suppress-inactive</p> <p>Example :</p> <pre>switch(config-router-neighbor-af) # suppress-inactive</pre>	<p>Advertises the best (active) routes only to the BGP peer. This command triggers an automatic soft clear or refresh of BGP neighbor sessions.</p>
<p>default-originate [route-map map-name]</p> <p>Example :</p> <pre>switch(config-router-neighbor-af)# default-originate</pre>	<p>Generates a default route to the BGP peer.</p>
<p>filter-list list-name { in out }</p> <p>Example:</p> <pre>switch(config-router-neighbor-af) # filter-list BGPFilter in</pre>	<p>Applies an AS_path filter list to this BGP peer for inbound or outbound route updates. This command triggers an automatic soft clear or refresh of BGP neighbor sessions.</p>
<p>prefix-list list-name { in out }</p> <p>Example:</p> <pre>switch(config-router-neighbor-af) # prefix-list PrefixFilter in</pre>	<p>Applies a prefix list to this BGP peer for inbound or outbound route updates. This command triggers an automatic soft clear or refresh of BGP neighbor sessions.</p>
<p>send-community</p> <p>Example :</p> <pre>switch(config-router-neighbor-af) # send-community</pre>	<p>Sends the community attribute to this BGP peer. This command triggers an automatic soft clear or refresh of BGP neighbor sessions.</p>
<p>send-extcommunity</p> <p>Example :</p> <pre>switch(config-router-neighbor-af) # send-extcommunity</pre>	<p>Sends the extended community attribute to this BGP peer. This command triggers an automatic soft clear or refresh of BGP neighbor sessions.</p>

Configuring Virtualization

Before you begin

Ensure that you have enabled the BGP feature (see the Enabling the BGP Feature section).

SUMMARY STEPS

1. **configure terminal**
2. **vrf context vrf-name**
3. **exit**
4. **router bgp as-number**
5. **vrf vrf-name**
6. **neighbor ip-address remote-as as-number**

7. (Optional) **bestpath as-path multipath-relax**
8. (Optional) **copy running-config startup-config**

DETAILED STEPS

Procedure

	Command or Action	Purpose
Step 1	configure terminal Example: switch# configure terminal switch(config)#	Enters configuration mode.
Step 2	vrf context <i>vrf-name</i> Example: switch(config)# vrf context RemoteOfficeVRF switch(config-vrf)#	Creates a new VRF and enters VRF configuration mode.
Step 3	exit Example: switch(config-vrf)# exit switch(config)#	Exits VRF configuration mode.
Step 4	router bgp <i>as-number</i> Example: switch(config)# router bgp 65536 switch(config-router)#	Creates a new BGP process with the configured autonomous system number.
Step 5	vrf <i>vrf-name</i> Example: switch(config-router)# vrf RemoteOfficeVRF switch(config-router-vrf)#	Enters the router VRF configuration mode and associates this BGP instance with a VRF.
Step 6	neighbor <i>ip-address</i> remote-as <i>as-number</i> Example: switch(config-router-vrf)# neighbor 209.165.201.1 remote-as 65536 switch(config-router--vrf-neighbor)#	Configures the IP address and AS number for a remote BGP peer.
Step 7	(Optional) bestpath as-path multipath-relax Example: switch(config-router-vrf)# bestpath as-path multipath-relax	Allows the switch to treat paths received from different autonomous systems for multipath, if their autonomous path lengths are the same and other multipath conditions are met.
Step 8	(Optional) copy running-config startup-config Example: switch(config-router-neighbor)# copy running-config startup-config	Saves this configuration change.

Example

This example shows how to create a VRF and configure the router ID in the VRF:

```
switch# configure terminal
switch(config)# vrf context NewVRF
switch(config-vrf)# exit
switch(config)# router bgp 65536
switch(config-router)# vrf NewVRF
switch(config-router-vrf)# neighbor 209.165.201.1 remote-as 65536
switch(config-router-vrf-neighbor)# copy running-config startup-config
```

BGP Graceful Shutdown

About BGP Graceful Shutdown

Beginning with release 9.3(1), BGP supports the graceful shutdown feature. This BGP feature works with the BGP **shutdown** command. Despite the name, BGP graceful shutdown does not actually cause a shutdown. Instead, it alerts connected routers that a router or link will be going down soon.

- Dramatically decrease the network convergence time when a router or link is taken offline.
- Reduce or eliminate dropped packets that are in transit when a router or link is taken offline.

The graceful shutdown feature uses the GRACEFUL_SHUTDOWN well-known community (0xFFFF0000 or 65535:0), which is identified by IANA and the IETF through RFC 8326. This well-known community can be attached to any routes, and it is processed like any other attribute of a route.

Because this feature announces that a router or link will be going down, the feature is useful in preparation of maintenance windows or planned outages. Use this feature before shutting down BGP to limit the impact on traffic.

Graceful Shutdown Aware and Activate

BGP routers can control the preference of all routes with the GRACEFUL_SHUTDOWN community through the concept of GRACEFUL_SHUTDOWN awareness. Graceful shutdown awareness is enabled by default, which enables the receiving peers to deprefer incoming routes carrying the GRACEFUL_SHUTDOWN community. Although not a typical use case, you can disable and reenabling graceful shutdown awareness through the **graceful-shutdown aware** command.

Graceful shutdown aware is applicable only at the BGP global context. For information about contexts, see [Graceful Shutdown Contexts, on page 178](#). The aware option operates with another option, the **activate** option, which you can assign to a route map for more granular control over graceful shutdown routes.

Interaction of the Graceful Shutdown Aware and Activate Options

When a graceful shutdown is activated, the GRACEFUL_SHUTDOWN community is appended to route updates only when you specify the **activate** keyword. At this point, new route updates that contain the community are generated and transmitted. When the **graceful-shutdown aware** command is configured, all routers that receive the community then deprefer (lower the route preference of) the routes in the update.

Without the **graceful-shutdown aware** command, BGP does not deprefer routes with the GRACEFUL_SHUTDOWN community.

After the feature is activated and the routers are aware of graceful shutdown, BGP still considers the routes with the GRACEFUL_SHUTDOWN community as valid. However, those routes are given the lowest priority in the best-path calculation. If alternate paths are available, new best paths are chosen, and convergence occurs to accommodate the router or link that will soon go down.

Graceful Shutdown Contexts

BGP graceful shutdown feature has two contexts that determine what the feature affects and what functionality is available.

Context	Affects	Commands
Global	The entire switch and all routes processed by it. For example, readvertise all routes with the GRACEFUL_SHUTDOWN community.	graceful-shutdown activate [route-map route-map] graceful-shutdown aware
Peer	A BGP peer or a link between neighbors. For example, advertise only one link between peers with GRACEFUL_SHUTDOWN community.	graceful-shutdown activate [route-map route-map]

Graceful Shutdown with Route Maps

Graceful shutdown works with the route policy manager (RPM) feature to control how the switch's BGP router transmits and receives routes with the GRACEFUL_SHUTDOWN community. Route maps can process route updates with the community in the inbound and outbound directions. Typically, route maps are not required. However, if needed, you can use them to customize the control of graceful shutdown routes.

Normal Inbound Route Maps

Normal inbound route maps affect routes that are incoming to the BGP router. Normal inbound route maps are not commonly used with the graceful shutdown feature because routers are aware of graceful shutdown by default.

Cisco Nexus switches running Cisco NX-OS Release 9.3(1) and later do not require an inbound route map for the graceful shutdown feature. Cisco NX-OS Release 9.3(1) and later have implicit inbound route maps that automatically deprefer any routes that have the GRACEFUL_SHUTDOWN community if the BGP router is graceful shutdown aware.

Normal inbound route maps can be configured to match against the well-known GRACEFUL_SHUTDOWN community. Although these inbound route maps are not common, there are some cases where they are used:

- If switches are running a Cisco NX-OS release earlier than 9.3(1), they do not have the implicit inbound route map present in NX-OS 9.3(1). To use the graceful shutdown feature on these switches, you must create a graceful shutdown inbound route map. The route map must match inbound routes with the well-known GRACEFUL_SHUTDOWN community, permit them, and deprefer them. If an inbound

route map is needed, create it on the BGP peer that is running a version of NX-OS earlier than 9.3(1) and is receiving the graceful shutdown routes.

- If you want to disable graceful shutdown aware, but still want the router to act on incoming routes with GRACEFUL_SHUTDOWN community from some BGP neighbors, you can configure an inbound route map under the respective peers.

Normal Outbound Route Maps

Normal outbound route maps control forwarding the routes that a BGP router sends. Normal outbound route maps can affect the graceful shutdown feature. For example, you can configure an outbound route map to match on the GRACEFUL_SHUTDOWN community and set attributes, and it takes precedence over any graceful shutdown outbound route maps.

Graceful Shutdown Outbound Route Maps

Outbound Graceful shutdown route maps are specific type of outbound route map for the graceful shutdown feature. They are optional, but they are useful when you already have a community list that is associated with a route map. The typical graceful shutdown outbound route map contains only `set` clauses to set or modify certain attributes.

You can use outbound route maps in the following ways:

- For customers that already have existing outbound route maps, you can add a new entry with a higher sequence number, match on the GRACEFUL_SHUTDOWN well-known community, and add any attributes that you want.
- You can also use a graceful shutdown outbound route map with the **graceful-shutdown activate route-map** *name* option. This is the typical use case.

This route map requires no match clauses, so the route map matches on all routes being sent to the neighbor.

Route Map Precedence

When multiple route maps are present on the same router, the following order of precedence is applied to determine how routes with the community are processed: Consider the following example. Assume you have a standard outbound route map name Red that sets a local-preference of 60. Also, assume you have a peer graceful-shutdown route map that is named Blue that sets local-pref to 30. When the route update is processed, the local preference will be set to 60 because Red overwrites Blue.

- Normal outbound route maps take precedence over peer graceful shutdown maps.
- Peer graceful shutdown maps take precedence over global graceful shutdown maps.

Guidelines and Limitations

The following are limitations and guidelines for BGP global shutdown:

- Graceful shutdown feature can only help avoid traffic loss when alternative routes exist in the network for the affected routers. If the router has no alternate routes, routes carrying the GRACEFUL_SHUTDOWN community are the only ones available, and therefore, are used in the best-path calculation. This situation defeats the purpose of the feature.

- Configuring a BGP send community is required to send the GRACEFUL_SHUTDOWN community.
- For route maps:
 - When global route maps and neighbor route maps are configured, the per-neighbor route maps take precedence.
 - Outbound route maps take precedence over any global route maps configured for graceful shutdown.
 - Outbound route maps take precedence over any peer route maps configured for graceful shutdown.
 - To add the graceful shutdown functionality to legacy (existing) inbound route maps, follow this order:
 1. Add the graceful shutdown match clause to the top of the route map by setting a low sequence number for the clause (for example, sequence number 0).
 2. Add a continue statement after the graceful shutdown clause. If you omit the continue statement, route-map processing stops when it matches the graceful shutdown clause, any other clauses with higher sequence numbers (for example, 1 and higher) are not processed.

Graceful Shutdown Task Overview

To use the graceful shutdown feature, you typically enable graceful-shutdown aware on all Cisco Nexus switches and leave the feature enabled. When a BGP router must be taken offline, you configure graceful-shutdown activate on it.

The following details document the best practice for using the graceful shutdown feature.

To bring the router or link down:

1. Configure the Graceful Shutdown feature.
2. Watch the neighbor for the best path.
3. When the best path is recalculated, issue the **shutdown** command to disable BGP.
4. Perform the work that required you to shut down the router or link.

To bring the router or link back online:

1. When you finish the work that required the shutdown, reenable BGP (**no shutdown**).
2. Disable the graceful shutdown feature (**no graceful-shutdown activate** in config router mode).

Configuring Graceful Shutdown on a Link

This task enables you to configure graceful shutdown on a specific link between two BGP routers.

Before you begin

If you have not already enabled BGP, enable it now (**feature bgp**).

SUMMARY STEPS

1. **config terminal**

2. **router bgp** *autonomous-system-number*
3. **neighbor** { *ipv4-address|ipv6-address* } **remote-as** *as-number*
4. **graceful-shutdown activate** [**route-map** *map-name*]

DETAILED STEPS

Procedure

	Command or Action	Purpose
Step 1	config terminal Example: <pre>switch-1# configure terminal switch-1(config)#</pre>	Enters global configuration mode.
Step 2	router bgp <i>autonomous-system-number</i> Example: <pre>switch-1(config)# router bgp 110 switch-1(config-router)#</pre>	Enters router configuration mode to create or configure a BGP routing process.
Step 3	neighbor { <i>ipv4-address ipv6-address</i> } remote-as <i>as-number</i> Example: <pre>switch-1(config-router)# neighbor 10.0.0.3 remote-as 200 switch-1(config-router-neighbor)#</pre>	Configures the autonomous system (AS) to which the neighbor belongs.
Step 4	graceful-shutdown activate [route-map <i>map-name</i>] Example: <pre>switch-1(config-router-neighbor)# graceful-shutdown activate route-map gshutPeer switch-1(config-router-neighbor)#</pre>	<p>Configures graceful shutdown on the link to the neighbor. Also, advertises the routes with the well-known GRACEFUL_SHUTDOWN community and applies the route map to the outbound route updates.</p> <p>The routes are advertised with the graceful-shutdown community by default. In this example, routes are advertised to the neighbor with the Graceful-shutdown community with a route-map named gshutPeer.</p> <p>The devices receiving the gshut community look at the communities of the route and optionally use the communities to apply routing policy.</p>

Filtering BGP Routes and Setting Local Preference Based On GRACEFUL_SHUTDOWN Communities

Switches that are not yet running 9.3(1) do not have an inbound route map that matches against the GRACEFUL_SHUTDOWN community name. Therefore, they have no way of identifying and depreffering the correct routes.

For switches running a release of NX-OS that is earlier than 9.3(1), you must configure an inbound route map that matches on the community value for graceful shutdown (65535:0) and depreffers routes.

If your switch is running 9.3(1) or later, you do not need to configure an inbound route map.

SUMMARY STEPS

1. **configure terminal**
2. **ip community list standard** *community-list-name seq sequence-number { permit | deny } value*
3. **route map** *map-tag {deny | permit} sequence-number*
4. **match community** *community-list-name*
5. **set local-preference** *local-pref-value*
6. **exit**
7. **router bgp** *community-list-name*
8. **neighbor** { *ipv4-address|ipv6-address* }
9. **address-family** { *address-family sub family* }
10. **send community**
11. **route map** *map-tag in*

DETAILED STEPS

Procedure

	Command or Action	Purpose
Step 1	configure terminal Example: switch-1# configure terminal switch-1(config)#	Enters global configuration mode.
Step 2	ip community list standard <i>community-list-name seq sequence-number { permit deny } value</i> Example: switch-1(config)# ip community-list standard GSHUT seq 10 permit 65535:0 switch-1(config)#	Configures a community list and permits or denies routes that have the well-known graceful shutdown community value.
Step 3	route map <i>map-tag {deny permit} sequence-number</i> Example: switch-1(config)# route-map RM_GSHUT permit 10 switch-1(config-route-map)#	Configures a route map as sequence 10 and permits routes that have the GRACEFUL_SHUTDOWN community.
Step 4	match community <i>community-list-name</i> Example: switch-1(config-route-map)# match community GSHUT switch-1(config-route-map)#	Configures that routes that match the IP community list GSHUT are processed by Route Policy Manager (RPM).
Step 5	set local-preference <i>local-pref-value</i> Example:	Configures that the routes that match the IP community list GSHUT will be given a specified local preference.

	Command or Action	Purpose
	<pre>switch-1(config-route-map)# set local-preference 10 switch-1(config-route-map)#</pre>	
Step 6	<p>exit</p> <p>Example:</p> <pre>switch-1(config-route-map)# exit switch-1(config)#</pre>	Leaves route map configuration and returns to global configuration mode.
Step 7	<p>router bgp <i>community-list-name</i></p> <p>Example:</p> <pre>switch-1(config)# router bgp 100 switch-1(config-router)#</pre>	Enters router configuration mode and creates a BGP instance.
Step 8	<p>neighbor { <i>ipv4-address ipv6-address</i> }</p> <p>Example:</p> <pre>switch-1(config-router)# neighbor 10.0.0.3 switch-1(config-router-neighbor)#</pre>	Enters route BGP neighbor mode for a specified neighbor.
Step 9	<p>address-family { <i>address-family sub family</i> }</p> <p>Example:</p> <pre>nxosv2(config-router-neighbor)# address-family ipv4 unicast nxosv2(config-router-neighbor-af)#</pre>	Puts the neighbor into address family (AF) configuration mode.
Step 10	<p>send community</p> <p>Example:</p> <pre>nxosv2(config-router-neighbor-af)# send-community nxosv2(config-router-neighbor-af)#</pre>	Enables BGP community exchange with the neighbor.
Step 11	<p>route map <i>map-tag in</i></p> <p>Example:</p> <pre>nxosv2(config-router-neighbor-af)# route-map RM_GSHUT in nxosv2(config-router-neighbor-af)#</pre>	Applies the route map to incoming routes from the neighbor. In this example, the route map that is named RM_GSHUT permits routes with the GRACEFUL_SHUTDOWN community from the neighbor.

Configuring Graceful Shutdown for All BGP Neighbors

You can manually apply the GRACEFUL_SHUTDOWN well-known community to all the neighbors of a graceful shutdown initiator.

You can configure graceful shutdown at the global level for all BGP neighbors.

Before you begin

If you have not already enabled BGP, enable it now (**feature bgp**).

SUMMARY STEPS

1. **configure terminal**
2. **router bgp** *autonomous-system-number*
3. **graceful-shutdown activate** [**route-map** *map-name*]

DETAILED STEPS**Procedure**

	Command or Action	Purpose
Step 1	configure terminal Example: <pre>switch-1# configure terminal switch-1(config)#</pre>	Enters global configuration mode.
Step 2	router bgp <i>autonomous-system-number</i> Example: <pre>switch-1(config)# router bgp 110 switch-1(config-router)#</pre>	Enters router configuration mode to create or configure a BGP routing process.
Step 3	graceful-shutdown activate [route-map <i>map-name</i>] Example: <pre>switch-1(config-router-neighbor)# graceful-shutdown activate route-map gshutPeer switch-1(config-router-neighbor)#</pre>	<p>Configures graceful shutdown route map for the links to all neighbors. Also, advertises all routes with the well-known GRACEFUL_SHUTDOWN community and applies the route map to the outbound route updates.</p> <p>The routes are advertised with the GRACEFUL_SHUTDOWN community by default. In this example, routes are advertised to all neighbors with the community with a route-map named gshutPeer. The route map should contain only set clauses.</p> <p>The devices receiving the GRACEFUL_SHUTDOWN community look at the communities of the route and optionally use the communities to apply routing policy.</p>

Controlling the Preference for All Routes with the GRACEFUL_SHUTDOWN Community

Cisco NX-OS enables lowering the preference of incoming routes that have the GRACEFUL_SHUTDOWN community. When **graceful shutdown aware** is enabled, BGP considers routes carrying the community as the lowest preference during best path calculation. By default, lowering the preference is enabled, but you can selectively disable this option.

Whenever you enable or disable this option, you trigger a BGP best-path calculation. This option gives you the flexibility to control the behavior of the BGP best-path calculation for the graceful shutdown well-known community.

Before you begin

If you have not enabled BGP, enable it now (**feature bgp**).

SUMMARY STEPS

1. **configure terminal**
2. **router bgp** *autonomous-system*
3. (Optional) **no graceful-shutdown aware**

DETAILED STEPS**Procedure**

	Command or Action	Purpose
Step 1	configure terminal Example: <pre>switch-1(config)# config terminal switch-1(config)#</pre>	Enters global configuration mode.
Step 2	router bgp <i>autonomous-system</i> Example: <pre>switch-1(config)# router bgp 100 switch-1(config-router)#</pre>	Enters router configuration mode and configures a BGP routing process.
Step 3	(Optional) no graceful-shutdown aware Example: <pre>switch-1(config-router)# no graceful-shutdown aware switch-1(config-router)#</pre>	For this BGP router, do not give lower preference for all routes that have the GRACEFUL_SHUTDOWN community. The default action is to deprefer routes when the graceful shutdown aware feature is disabled, so using the no form of the command is optional for not deprefering graceful shutdown routes.

Preventing Sending the GRACEFUL_SHUTDOWN Community to a Peer

If you no longer need the GRACEFUL_SHUTDOWN community that is appended as a route attribute to outbound route updates, you can remove the community, which no longer sends it to a specified neighbor. One use case would be when a router is at an autonomous system boundary, and you do not want the graceful shutdown functionality to propagate outside of an autonomous system boundary.

To prevent sending the GRACEFUL_SHUTDOWN to a peer, you can disable the send community option or strip the community from the outbound route map.

Choose either of the following methods:

- Disable the send-community in the running config.

Example:

```
nxosv2(config-router-neighbor-af)# no send-community standard
nxosv2(config-router-neighbor-af)#
```

If you use this option, the GRACEFUL_SHUTDOWN community is still received by the switch, but it is not sent to the downstream neighbor through the outbound route map. All standard communities are not sent either.

- Delete the GRACEFUL_SHUTDOWN community through an outbound route map by following these steps:
 1. Create an IP community list matches the GRACEFUL_SHUTDOWN community.
 2. Create an outbound route map to match against the GRACEFUL_SHUTDOWN community.
 3. Use a **set community-list delete** clause to strip GRACEFUL_SHUTDOWN community.

If you use this option, the community list matches and permits the GRACEFUL_SHUTDOWN community, then the outbound route map matches against the community and then deletes it from the outbound route map. All other communities pass through the outbound route map without issue.

Displaying Graceful Shutdown Information

Information about the graceful shutdown feature is available through the following **show** commands.

Command	Action
show ip bgp community-list graceful-shutdown	Shows all entries in the BGP routing table that have the GRACEFUL_SHUTDOWN community.
show running-config bgp	Shows the running BGP configuration.
show running-config bgp all	Shows all information for the running BGP configuration including information about the graceful shutdown feature.
show bgp <i>address-family</i> neighbors <i>neighbor-address</i>	When the feature is configured for the peer, shows the following: <ul style="list-style-type: none"> • The state of the graceful-shutdown-activate feature for the specified neighbor • The name of any graceful shutdown route map configured for the specified neighbor

Command	Action
<code>show bgp process</code>	<p>Shows different information depending on the context.</p> <p>When the graceful-shutdown-activate option is configured in peer context, shows the enabled or disabled state for the feature through <code>graceful-shutdown-active</code>.</p> <p>When the graceful-shutdown-activate option is configured in global context and has a graceful-shutdown route map, shows the enabled state of the feature through the following:</p> <ul style="list-style-type: none"> • <code>graceful-shutdown-active</code> • <code>graceful-shutdown-aware</code> • <code>graceful-shutdown route-map</code>
<code>show ip bgp address</code>	<p>For the specified address, shows the BGP routing table information, including the following:</p> <ul style="list-style-type: none"> • The state of the specified address as the best path • Whether the specified address is part of the GRACEFUL_SHUTDOWN community

Graceful Shutdown Configuration Examples

These examples show some configurations for using the graceful shutdown feature.

Configuring Graceful Shutdown for a BGP Link

The following example shows how to configure graceful shutdown while setting a local preference and a community:

- Configuring graceful shutdown activate for the link to the specified neighbor
- Adding the GRACEFUL_SHUTDOWN community to the routes
- Setting a route map named `gshutPeer` with only set clauses for outbound routes with the community.

```

router bgp 100
  neighbor 20.0.0.3 remote-as 200
    graceful-shutdown activate route-map gshutPeer
    address-family ipv4 unicast
      send-community

route-map gshutPeer permit 10
  set local-preference 0
  set community 200:30

```

Configuring Graceful Shutdown for All-Neighbor BGP Links

The following example shows:

- Configuring graceful shutdown activate for all the links connecting the local router and all its neighbors.
- Adding the GRACEFUL_SHUTDOWN community to the routes.
- Setting a route map that is named gshutAall with only set clauses for all outbound routes.

```

router bgp 200
  graceful-shutdown activate route-map gshutAll

route-map gshutAll permit 10
  set as-path prepend 10 100 110
  set community 100:80

route-map Red permit 10
  set local-pref 20

router bgp 100
  graceful-shutdown activate route-map gshutAll
  router-id 2.2.2.2
  address-family ipv4 unicast
  network 2.2.2.2/32
  neighbor 1.1.1.1 remote-as 100
  update-source loopback0
  address-family ipv4 unicast
  send-community
  neighbor 20.0.0.3 remote-as 200
  address-family ipv4 unicast
  send-community
  route-map Red out

```

In this example, the `gshutAll` route-map takes effect for neighbor 1.1.1.1, but not neighbor 20.0.0.3, because the outbound route-map `Red` configured under neighbor 20.0.0.3 takes precedence instead.

Configuring Graceful Shutdown Under a Peer-Template

This example configures the graceful shutdown feature under a peer-session template, which is inherited by a neighbor.

```

router bgp 200
  template peer-session p1
  graceful-shutdown activate route-map gshut_out
  neighbor 1.1.1.1 remote-as 100
  inherit peer-session p1
  address-family ipv4 unicast
  send-community

```

Filtering BGP Routes and Setting Local Preference Based on GRACEFUL_SHUTDOWN Community Using and Inbound Route Map

This example shows how to use a community list to filter the incoming routes that have the GRACEFUL_SHUTDOWN community. This configuration is useful for legacy switches that are not running Cisco NX-OS 9.3(1) as a minimum version.

The following example shows:

- An IP Community List that permits routes that have the GRACEFUL_SHUTDOWN community.
- A route map that is named `RM_GSHUT` that permits routes based on a standard community list named `GSHUT`.

- The route map also sets the preference for the routes it processes to 0 so that those routes are given lower preference for best path calculation when the router goes offline. The route map is applied to incoming IPv4 routes from the neighbor (20.0.0.2).

```
ip community-list standard GSHUT permit 65535:0

route-map RM_GSHUT permit 10
  match community GSHUT
  set local-preference 0

router bgp 200
  neighbor 20.0.0.2 remote-as 100
  address-family ipv4 unicast
    send-community
  route-map RM_GSHUT in
```

Verifying the Advanced BGP Configuration

To display the BGP configuration information, perform one of the following tasks:

Command	Purpose
show bgp all [summary] [vrf vrf-name]	Displays the BGP information for all address families.
show bgp convergence [vrf vrf-name]	Displays the BGP information for all address families.
show bgp ip {unicast} [ip-address] community {regexp expression [community] [no-advertise] [no-export] [no-export-subconfed]} [vrf vrf-name]	Displays the BGP routes that match a BGP community.
show bgp [vrf vrf-name] ip {unicast} [ip-address] community-list list-name [vrf vrf-name]	Displays the BGP routes that match a BGP community list.
show bgp ip {unicast} [ip-address] extcommunity {regexp expression generic [non-transitive transitive] aa4:nn [exact-match]} [vrf vrf-name]	Displays the BGP routes that match a BGP extended community.
show bgp ip {unicast} [ip-address] extcommunity-list list-name [exact-match] [vrf vrf-name]	Displays the BGP routes that match a BGP extended community list.
show bgp ip {unicast} [ip-address] {dampening dampened-paths [regexp expression]} [vrf vrf-name]	Displays the information for BGP route dampening. Use the clear bgp dampening command to clear the route flap dampening information.
show bgp ip {unicast} [ip-address] history-paths [regexp expression] [vrf vrf-name]	Displays the BGP route history paths.
show bgp ip {unicast} [ip-address] filter-list list-name [vrf vrf-name]	Displays the information for the BGP filter list.
show bgp ip {unicast} [ip-address] neighbors [ip-address] [vrf vrf-name]	Displays the information for BGP peers. Use the clear bgp neighbors command to clear these neighbors.

Command	Purpose
show bgp ip {unicast} [ip-address] {nexthop nexthop-database} [vrf vrf-name]	Displays the information for the BGP route next hop.
show bgp paths	Displays the BGP path information.
show bgp ip {unicast} [ip-address] policy name [vrf vrf-name]	Displays the BGP policy information. Use the clear bgp policy command to clear the policy information.
show bgp ip {unicast} [ip-address] prefix-list list-name [vrf vrf-name]	Displays the BGP routes that match the prefix list.
show bgp ip {unicast} [ip-address] received-paths [vrf vrf-name]	Displays the BGP paths stored for soft reconfiguration.
show bgp ip {unicast} [ip-address] regex expression [vrf vrf-name]	Displays the BGP routes that match the AS_path regular expression.
show bgp ip {unicast} [ip-address] route-map map-name [vrf vrf-name]	Displays the BGP routes that match the route map.
show bgp peer-policy name [vrf vrf-name]	Displays the information about BGP peer policies.
show bgp peer-session name [vrf vrf-name]	Displays the information about BGP peer sessions.
show bgp peer-template name [vrf vrf-name]	Displays the information about BGP peer templates. Use the clear bgp peer-template command to clear all neighbors in a peer template.
show bgp process	Displays the BGP process information.
show ip bgp options	Displays the BGP status and configuration information. This command has multiple options. See the Cisco Nexus 3000 Series Command Reference for more information.
show ip mbgp options	Displays the BGP status and configuration information. This command has multiple options. See the Cisco Nexus 3000 Series Command Reference for more information.
show running-configuration bgp	Displays the current running BGP configuration.

Displaying BGP Statistics

To display BGP statistics, use the following commands:

Command	Purpose
show bgp ip {unicast} [ip-address] flap-statistics [vrf vrf-name]	Displays the BGP route flap statistics. Use the clear bgp flap-statistics command to clear these statistics.

Command	Purpose
<code>show bgp sessions [vrf vrf-name]</code>	Displays the BGP sessions for all peers. Use the clear bgp sessions command to clear these statistics.
<code>show bgp sessions [vrf vrf-name]</code>	Displays the BGP sessions for all peers. Use the clear bgp sessions command to clear these statistics.
<code>show bgp statistics</code>	Displays the BGP statistics.

Related Topics

The following topics can give more information on BGP:

- [Configuring Basic BGP](#)
- [Configuring Route Policy Manager](#)

Additional References

For additional information related to implementing BGP, see the following sections:

- [Related Documents](#)
- [MIBs](#)

Related Documents

Related Topic	Document Title
BGP CLI commands	Cisco Nexus 3000 Series Command Reference

MIBs

MIBs	MIBs Link
BGP4-MIB CISCO-BGP4-MIB	To locate and download MIBs, go to the following: MIB Locator .



CHAPTER 8

Configuring BGP Additional Paths

This chapter describes how to configure the BGP Additional Paths allowing the advertisement of multiple paths through the same peering session for the same prefix without the new paths implicitly replacing any previous paths. This behavior promotes path diversity and reduces multi-exit discriminator (MED) oscillations.

This chapter includes the following sections:

- [Information About BGP Additional Paths, on page 193](#)
- [How to Configure BGP Additional Paths, on page 196](#)
- [Verifying the BGP Additional Paths Configuration, on page 202](#)
- [Feature History for BGP Additional Paths, on page 202](#)

Information About BGP Additional Paths

This section includes the following topics:

Problem That Additional Paths Can Solve

BGP routers and route reflectors (RRs) propagate only their best path over their sessions. The advertisement of a prefix replaces the previous announcement of that prefix (this behavior is known as an implicit withdraw). The implicit withdraw can achieve better scaling, but at the cost of path diversity.

Path hiding can prevent efficient use of BGP multipath, prevent hitless planned maintenance, and can lead to MED oscillations and suboptimal hot-potato routing. Upon nexthop failures, path hiding also inhibits fast and local recovery because the network has to wait for BGP control plane convergence to restore traffic. The BGP Additional Paths feature provides a generic way of offering path diversity; the Best External or Best Internal features offer path diversity only in limited scenarios.

The BGP Additional Paths feature provides a way for multiple paths for the same prefix to be advertised without the new paths implicitly replacing the previous paths. Thus, path diversity is achieved instead of path hiding.

Path-Hiding Scenario

This section describes in more detail how path hiding can occur. In the following figure, we have prefix p with paths p1 and p2 advertised from BR1 and BR4 to RR1. RR1 selects the bestpath of the two and then advertises to PE only p1.

Figure 13: RR Hiding an Additional Path

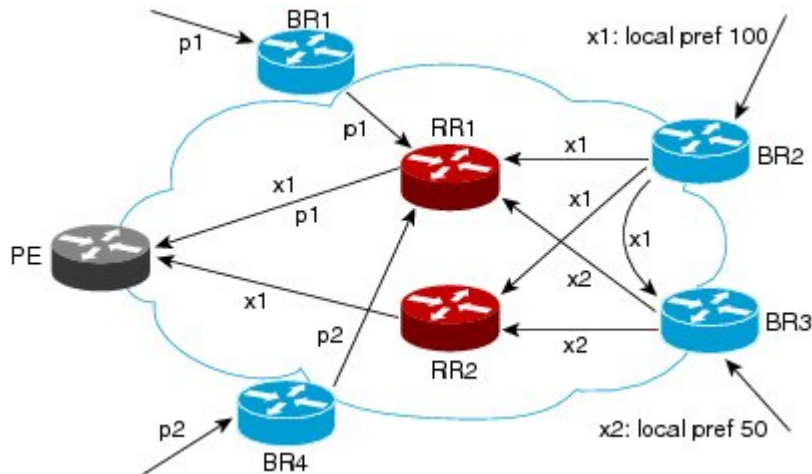

In the figure **RR Hiding an Additional Path**, we also see prefix x with path x1 being advertised from BR2 to BR3 (which has path x2) with local preference 100. BR3 also has path x2, but due to routing policy, BR3 will advertise to the RRs x1 (not shown) instead of x2, and x2 will be suppressed. A user could turn on the advertisement of best external on BR3 and thereby advertise x2 to the RRs, but, again, the RRs advertise only the best path.

Suboptimal Hot-Potato Routing Scenario

In order to minimize internal transport costs, transit ISPs try to forward packets to the closest exit point (according to IGP cost). This behavior is known as hot-potato routing. In the distributed RR cluster model of the following figure, assume traffic coming from LA must go to Mexico. All links have the same IGP cost. If there are two exit points toward Mexico—one toward Austin and one toward Atlanta—the border router will try to send traffic to Austin based on the lower IGP cost from LA toward Austin than toward Atlanta. In a centralized RR model where the central RR resides where RR3 is (and RR1, RR2, RR4, and RR5 do not exist), the closest exit point toward Mexico, as seen from RR3, might be Atlanta. Sending the traffic from LA toward the Atlanta BR and thus resulting in suboptimal hot-potato routing is not desirable.

Figure 14: Distributed RR Cluster

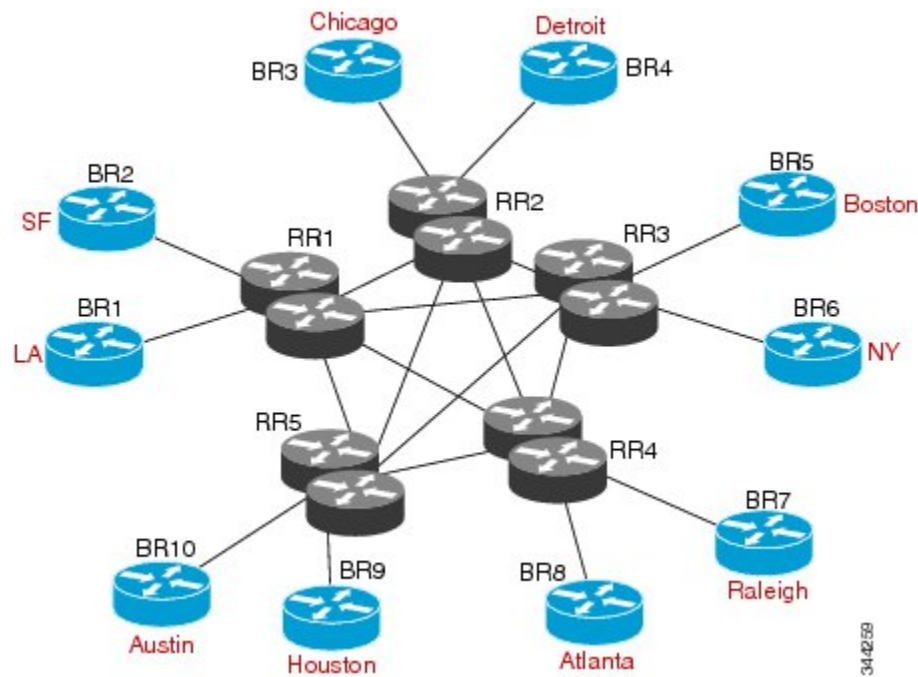

34-4259

Benefits of Additional BGP Paths

BGP routers and route reflectors (RR) propagate only their best path over their sessions. The advertisement of a prefix replaces the previous announcement of that prefix (this is known as an implicit withdraw).

While this behavior may achieve better scaling, it can prevent path diversity, which tends to be poor or completely lost. The behavior in turn prevents efficient use of BGP multipath, prevents hitless planned maintenance, and can lead to multi-exit discriminator (MED) oscillations and suboptimal hot-potato routing. It also inhibits fast and local recovery upon nexthop failures, because the network has to wait for BGP control plane convergence to restore traffic.

The BGP Additional Paths feature is a BGP extension that allows the advertisement of multiple paths for the same prefix without the new paths implicitly replacing any previous paths. This behavior promotes path diversity and reduces MED oscillations.

BGP Additional Paths Functionality

The BGP Additional Paths feature is implemented by adding a path identifier to each path in the NLRI. The path identifier (ID) can be considered as something similar to a route distinguisher (RD) in VPNs, except that a path ID can apply to any address family. Path IDs are unique to a peering session and are generated for each network. The path identifier is used to prevent a route announcement from implicitly withdrawing the previous one. The Additional Paths feature allows the advertisement of more paths, in addition to the bestpath. The Additional Paths feature allows the advertisement of multiple paths for the same prefix, without the new paths implicitly replacing any previous paths.

The BGP Additional Paths feature requires you to take three general steps:

1. Specify whether the device can send, receive, or send and receive additional paths. This is done at the address family level or the neighbor level. During session establishment, two BGP neighbors negotiate the additional path capabilities (whether they can send and/or receive) between them.
2. Select a set or sets of candidate paths for advertisement by specifying selection criteria.
3. Advertise for a neighbor a set or sets of additional paths from the candidate paths marked.

To send or receive additional paths, the additional path capability must be negotiated. If it is not negotiated, even if the selection criteria are such that more than the bestpath is marked and the neighbor is configured to advertise the marked paths, the selections would be useless because without the capability negotiated, only the bestpath can be sent.

Configuring BGP to send or receive additional paths triggers negotiation of additional path capability with the device's peers. Neighbors that have negotiated the capability will be grouped together in an update group (if other update group policies allow), and in a separate update group from those peers that have not negotiated the capability. Therefore, additional path capability causes the neighbor's update group membership to be recalculated.

Additional Path Selection

Only the best-path is advertised to peers unless you configure the **set path-selection all advertise** command which advertises all BGP paths as additional paths to peers if the receive capability is enabled.

Advertise a Subset of the Paths Selected

Take care when you select a set of paths but want to advertise a different set of paths. If the set of paths you want to advertise is not a subset of the selected paths, then you will not advertise the paths you want advertised.

Guidelines and Limitations

Configuring BGP Additional Paths has the following guidelines and limitations:

- BGP add-path is not supported as dynamic capability. It is included in OPEN but not in CAPABILITY message. The configuration will take effect upon the next session establishment and does not cause established sessions to get torn down.

How to Configure BGP Additional Paths

This section includes the following topics:

Configuring BGP Additional Paths per Address Family

Perform the following steps to specify whether the device can send and receive additional paths to and from all neighbors within an address family.

Before you begin

Ensure that you have enabled the BGP feature.

SUMMARY STEPS

1. **configure terminal**
2. **router bgp *as-number***
3. **address-family ipv4 unicast**
4. (Optional) **additional-paths receive**
5. (Optional) **additional-paths send**
6. (Optional) **additional-paths selection route-map**
7. (Optional) **end**

DETAILED STEPS

Procedure

	Command or Action	Purpose
Step 1	configure terminal Example: <pre>switch# configure terminal switch(config)#</pre>	Enters configuration mode.
Step 2	router bgp <i>as-number</i> Example: <pre>switch(config)# router bgp 65000 switch(config-router)#</pre>	Enables BGP and assigns the autonomous system number to the local BGP speaker.
Step 3	address-family ipv4 unicast Example: <pre>switch(config-router)# address family ipv4 unicast</pre>	Enters address family configuration mode.
Step 4	(Optionally) additional-paths receive Example: <pre>switch(config-router-af)# additional-paths receive</pre>	Enables BGP additional paths for a prefix to be received from a capable peer. Note This capability applies to all neighbors under the specified address family unless the capability is explicitly disabled with the neighbor <code>additional-paths receive disable</code> command, which overrides the configuration for the address family.
Step 5	(Optionally) additional-paths send Example: <pre>switch(config-router-af)# additional-paths send</pre>	Enables BGP additional paths for a prefix to be sent to a capable peer. Note This capability applies to all neighbors under the specified address family unless the capability is explicitly disabled with the neighbor <code>additional-paths send disable</code> command, which overrides the configuration for the address family.

	Command or Action	Purpose
Step 6	(Optional) additional-paths selection route-map Example: switch(config-router-stmp)# exit switch(config-router)#	Configures additional paths selection capability for a prefix.
Step 7	(Optional) end Example: switch(config-router-af)# end	Exits to privileged EXEC mode.

Configuring BGP Additional Paths per Neighbor

Perform the following steps to configure whether a particular neighbor can send or receive additional paths.

Before you begin

Ensure that you have enabled the BGP feature (see the [Enabling the BGP Feature](#) section).

SUMMARY STEPS

1. **configure terminal**
2. **router bgp** *as-number*
3. **neighbor** { *ipv4-address* | *ipv4-prefix/length* } [**remote-as** { *as-num* } [*as-num*]]
4. **address-family ipv4 unicast**
5. (Optional) **capability additional-paths receive** [disable]
6. (Optional) **capability additional-paths send** [disable]
7. (Optional) **end**

DETAILED STEPS

Procedure

	Command or Action	Purpose
Step 1	configure terminal Example: switch# configure terminal switch(config)#	Enters configuration mode.
Step 2	router bgp <i>as-number</i> Example: switch(config)# router bgp 65000 switch(config-router)#	Enables BGP and assigns the autonomous system number to the local BGP speaker.
Step 3	neighbor { <i>ipv4-address</i> <i>ipv4-prefix/length</i> } [remote-as { <i>as-num</i> } [<i>as-num</i>]]	Configures a BGP neighbor (router, VRF) and enters the neighbor configuration mode.

	Command or Action	Purpose
Step 4	address-family ipv4 unicast Example: switch(config-router)# address family ipv4 unicast	Enters address family configuration mode.
Step 5	(Optional) capability additional-paths receive [disable] Example: switch(config-router-af)# capability additional-paths receive	Configures the receive additional paths capability for the specified neighbor. Note This command overrides any send or receive capability that is configured at the address-family level.
Step 6	(Optional) capability additional-paths send [disable] Example: switch(config-router-af)# capability additional-paths send	Configures the send additional paths capability for the specified neighbor. Note This command overrides any send or receive capability that is configured at the address-family level.
Step 7	(Optional) end Example: switch(config-router-af)# end	Exits to privileged EXEC mode.

Configuring Additional Paths Using a Peer Policy Template

In this configuration task, the capability to send and receive additional paths and the selection criteria are configured for the address family, and then the template is configured.

Before you begin

Ensure that you have enabled the BGP feature (see the [Enabling the BGP Feature](#) section).

SUMMARY STEPS

1. **configure terminal**
2. **router bgp** *as-number*
3. **template peer-policy** *template-name*
4. (Optional) **capability additional-paths receive [disable]**
5. (Optional) **capability additional-paths send [disable]**
6. **exit**
7. **neighbor** { *ipv4-address* | *ipv4-prefix/length* } [**remote-as** { *as-num* } [*as-num*]]
8. (Optional) **address-family ipv4 unicast**
9. **inherit peer-policy** *template-name sequence-number*
10. (Optional) **end**

DETAILED STEPS

Procedure

	Command or Action	Purpose
Step 1	configure terminal Example: switch# configure terminal switch(config)#	Enters configuration mode.
Step 2	router bgp <i>as-number</i> Example: switch(config)# router bgp 65000 switch(config-router)#	Enables BGP and assigns the autonomous system number to the local BGP speaker.
Step 3	template peer-policy <i>template-name</i> Example: switch(config-router)# template peer-policy rr-client-ptl #	Enters policy-template configuration mode and creates a peer policy template.
Step 4	(Optional) capability additional-paths receive [disable] Example: switch(config-router-af)# capability additional-paths receive	Configures the receive additional paths capability for the specified neighbor. Note This command overrides any send or receive capability that is configured at the address-family level.
Step 5	(Optional) capability additional-paths send [disable] Example: switch(config-router-af)# capability additional-paths send	Configures the send additional paths capability for the specified neighbor. Note This command overrides any send or receive capability that is configured at the address-family level.
Step 6	exit Example: switch(config-router-ptmp)# exit	Exits policy-template configuration mode and returns to router configuration mode.
Step 7	neighbor { <i>ipv4-address</i> <i>ipv4-prefix/length</i> } [remote-as { <i>as-num</i> } [. <i>as-num</i>]]	Configures a BGP neighbor (router, VRF) and enters the neighbor configuration mode.
Step 8	(Optional) address-family ipv4 unicast Example: switch(config-router)# address family ipv4 unicast	Enters address family configuration mode.
Step 9	inherit peer-policy <i>template-name sequence-number</i> Example: switch(config-router-neighbor-af)# inherit peer-policy rr-client-ptl 10	Sends a peer policy template to a neighbor so that the neighbor can inherit the configuration.

	Command or Action	Purpose
Step 10	(Optional) end Example: <code>switch(config-router-af)# end</code>	Exits to privileged EXEC mode.

Filtering and Setting Actions for Additional Paths

You can optionally use a route map to filter the paths to be advertised by matching on the prefix of additional paths that are candidates to be advertised. (These prefixes are configured with the **additional-paths selection** command.)

You can also optionally set one or more actions to take for those paths that pass through the route map. This task happens to use the **set metric** command. Other **set** commands are available that are not shown in this task.

SUMMARY STEPS

1. **configure terminal**
2. **route-map** *map-name* [**deny** | **permit**] [*sequence-number*]
3. **set path-selection all advertise**
4. **set metric** *metric-value*
5. (Optional) **end**

DETAILED STEPS

Procedure

	Command or Action	Purpose
Step 1	configure terminal Example: <code>switch# configure terminal</code> <code>switch(config)#</code>	Enters configuration mode.
Step 2	route-map <i>map-name</i> [deny permit] [<i>sequence-number</i>] Example: <code>switch(config)# route-map add_path4 permit 10</code>	Defines a route map and the conditions for redistributing routes from one routing protocol into another.
Step 3	set path-selection all advertise Example: <code>switch(config-route-map)# set path-selection all advertise</code>	Advertises all BGP paths as additional paths to peers if the receive capability is enabled.
Step 4	set metric <i>metric-value</i> Example:	Sets the metric of the additional paths that pass the match criteria.

	Command or Action	Purpose
	<code>switch(config-route-map)# set metric 500</code>	<ul style="list-style-type: none"> Note that other set commands can be used to take action on the paths that pass the route map.
Step 5	(Optional) <code>end</code> Example: <code>switch(config-router-af)# end</code>	Exits to privileged EXEC mode.

Verifying the BGP Additional Paths Configuration

To display information about the BGP additional paths configuration, use the following commands:

Command	Purpose
<code>show ip bgp [ip-address]</code>	Displays entries in the BGP table.
<code>show ip bgp neighbors [ip-address [advertise-routes]]</code>	Displays the configured neighbors and the other information specific to individual neighbor.

Feature History for BGP Additional Paths

Table below lists the release history for this feature.

Table 10: Feature History for BGP

Feature Name	Releases	Feature Information
BGP Additional Paths	6.0(2)U1(1)	<p>The BGP Additional Paths feature allows the advertisement of multiple paths for the same prefix without the new paths implicitly replacing any previous paths.</p> <p>The following commands were introduced:</p> <ul style="list-style-type: none"> • additional-paths receive • additional-paths selection • additional-paths send • capability additional-paths receive • capability additional-paths send • set path-selection all advertise <p>The following commands were modified:</p> <ul style="list-style-type: none"> • show ip bgp • show ip bgp neighbors



CHAPTER 9

Configuring RIP

This chapter describes how to configure the Routing Information Protocol (RIP) on Cisco NX-OS switches.

This chapter includes the following sections:

- [Information About RIP, on page 205](#)
- [Prerequisites for RIP, on page 207](#)
- [Guidelines and Limitations for RIP, on page 207](#)
- [Default Settings for RIP, on page 208](#)
- [Configuring RIP, on page 208](#)
- [Verifying the RIP Configuration, on page 221](#)
- [Displaying RIP Statistics, on page 222](#)
- [Configuration Examples for RIP, on page 222](#)
- [Related Topics, on page 223](#)
- [Additional References, on page 223](#)

Information About RIP

This section includes the following topics:

RIP Overview

RIP uses User Datagram Protocol (UDP) data packets to exchange routing information in small internetworks. RIPv2 supports IPv4. RIPv2 uses an optional authentication feature supported by the RIPv2 protocol (see the [RIPv2 Authentication](#) section).

RIP uses the following two message types:

- **Request**—Sent to the multicast address 224.0.0.9 to request route updates from other RIP-enabled routers.
- **Response**—Sent every 30 seconds by default (see the [Verifying the RIP Configuration](#) section). The router also sends response messages after it receives a Request message. The response message contains the entire RIP route table. RIP sends multiple response packets for a request if the RIP routing table cannot fit in one response packet.

RIP uses a hop count for the routing metric. The hop count is the number of routers that a packet can traverse before reaching its destination. A directly connected network has a metric of 1; an unreachable network has a metric of 16. This small range of metrics makes RIP an unsuitable routing protocol for large networks.

RIPv2 Authentication

You can configure authentication on RIP messages to prevent unauthorized or invalid routing updates in your network. Cisco NX-OS supports a simple password or an MD5 authentication digest.

You can configure the RIP authentication per interface by using key-chain management for the authentication keys. Key-chain management allows you to control changes to the authentication keys used by an MD5 authentication digest or simple text password authentication. See the [Cisco Nexus 3548 Switch NX-OS Security Configuration Guide](#) for more details about creating key-chains.

To use an MD5 authentication digest, you configure a password that is shared at the local router and all remote RIP neighbors. Cisco NX-OS creates an MD5 one-way message digest based on the message itself and the encrypted password and sends this digest with the RIP message (Request or Response). The receiving RIP neighbor validates the digest by using the same encrypted password. If the message has not changed, the calculation is identical and the RIP message is considered valid.

An MD5 authentication digest also includes a sequence number with each RIP message to ensure that no message is replayed in the network.

Split Horizon

You can use split horizon to ensure that RIP never advertises a route out of the interface where it was learned.

Split horizon is a method that controls the sending of RIP update and query packets. When you enable split horizon on an interface, Cisco NX-OS does not send update packets for destinations that were learned from this interface. Controlling update packets in this manner reduces the possibility of routing loops.

You can use split horizon with poison reverse to configure an interface to advertise routes learned by RIP as unreachable over the interface that learned the routes. Figure below shows a sample RIP network with split horizon with poison reverse enabled.

Figure 15: RIP with Split Horizon Poison Reverse

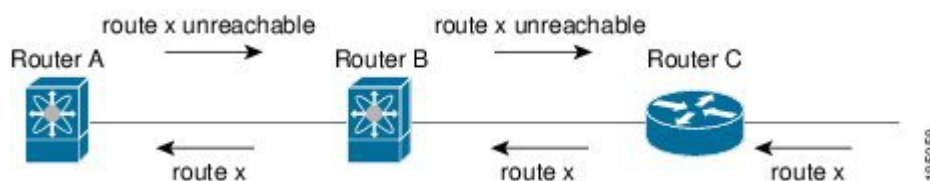

Router C learns about route X and advertises that route to router B. Router B in turn advertises route X to router A, but sends a route X unreachable update back to router C.

By default, split horizon is enabled on all interfaces.

Route Filtering

You can configure a route policy on a RIP-enabled interface to filter the RIP updates. Cisco NX-OS updates the route table with only those routes that the route policy allows.

Route Summarization

You can configure multiple summary aggregate addresses for a specified interface. Route summarization simplifies route tables by replacing a number of more-specific addresses with an address that represents all

the specific addresses. For example, you can replace 10.1.1.0/24, 10.1.2.0/24, and 10.1.3.0/24 with one summary address, 10.1.0.0/16.

If more specific routes are in the routing table, RIP advertises the summary address from the interface with a metric equal to the maximum metric of the more specific routes.



Note Cisco NX-OS does not support automatic route summarization.

Route Redistribution

You can use RIP to redistribute static routes or routes from other protocols. When you configure redistribution use a route policy to control which routes are passed into RIP. A route policy allows you to filter routes based on attributes such as the destination, origination protocol, route type, route tag, and so on. For more information, see [Configuring Route Policy Manager](#).

Whenever you redistribute routes into a RIP routing domain, by default Cisco NX-OS does not redistribute the default route into the RIP routing domain. You can generate a default route into RIP, which can be controlled by a route policy.

You also configure the default metric that is used for all imported routes into RIP.

Load Balancing

You can use load balancing to allow a router to distribute traffic over all the router network ports that are the same distance from the destination address. Load balancing increases the utilization of network segments and increases effective network bandwidth.

Cisco NX-OS supports the Equal Cost Multiple Paths (ECMP) feature with up to 32 equal-cost paths in the RIP route table and the unicast RIB. You can configure RIP to load balance traffic across some or all of those paths.

Virtualization Support

Cisco NX-OS supports multiple instances of the RIP protocol that runs on the same system. RIP supports Virtual Routing and Forwarding instances (VRFs).

By default, Cisco NX-OS places you in the default VRF unless you specifically configure another VRF.

Prerequisites for RIP

RIP has the following prerequisites:

- You must enable the RIP feature (see the [Enabling the RIP Feature](#) section).

Guidelines and Limitations for RIP

RIP has the following configuration guidelines and limitations:

- Cisco NX-OS does not support RIPv1. If Cisco NX-OS receives a RIPv1 packet, it logs a message and drops the packet.
- Cisco NX-OS does not establish adjacencies with RIPv1 routers.

Default Settings for RIP

The following table lists the default settings for RIP parameters.

Table 11: Default RIP Parameters

Parameters	Default
Maximum paths for load balancing	16
RIP feature	Disabled
Split horizon	Enabled

Configuring RIP



Note If you are familiar with the Cisco IOS CLI, be aware that the Cisco NX-OS commands for this feature might differ from the Cisco IOS commands that you would use.

Enabling the RIP Feature

You must enable the RIP feature before you can configure RIP.

SUMMARY STEPS

1. **configure terminal**
2. **feature rip**
3. (Optional) **show feature**
4. (Optional) **copy running-config startup-config**

DETAILED STEPS

Procedure

	Command or Action	Purpose
Step 1	configure terminal Example:	Enters configuration mode.

	Command or Action	Purpose
	switch# configure terminal switch(config)#	
Step 2	feature rip Example: switch(config)# feature rip	Enables the RIP feature.
Step 3	(Optional) show feature Example: switch(config)# show feature	Displays enabled and disabled features.
Step 4	(Optional) copy running-config startup-config Example: switch(config)# copy running-config startup-config	Saves this configuration change.

Example

Use the **no feature rip** command to disable the RIP feature and remove all associated configuration.

Command	Purpose
no feature rip Example: switch(config)# no feature rip	Disables the RIP feature and removes all associated configuration.

Creating a RIP Instance

You can create a RIP instance and configure the address family for that instance.

Before you begin

Ensure that you have enabled the RIP feature. See the [Enabling the RIP Feature](#) section.

SUMMARY STEPS

1. **configure terminal**
2. **router rip** *instance-tag*
3. **address-family ipv4 unicast**
4. (Optional) **show ip rip** [**instance** *instance-tag*] [**vrf** *vrf-name*]
5. (Optional) **copy running-config startup-config**

DETAILED STEPS

Procedure

	Command or Action	Purpose
Step 1	configure terminal Example: switch# configure terminal switch(config)#	Enters configuration mode.
Step 2	router rip <i>instance-tag</i> Example: switch(config)# router RIP Enterprise switch(config-router)#	Creates a new RIP instance with the configured <i>instance-tag</i> value.
Step 3	address-family ipv4 unicast Example: switch(config-router)# address-family ipv4 unicast switch(config-router-af)#	Configures the address family for this RIP instance and enters address-family configuration mode.
Step 4	(Optional) show ip rip [instance <i>instance-tag</i>] [vrf <i>vrf-name</i>] Example: switch(config-router-af)# show ip rip	Displays a summary of RIP information for all RIP instances.
Step 5	(Optional) copy running-config startup-config Example: switch(config)# copy running-config startup-config	Saves this configuration change.

Example

Use the **no router rip** command to remove the RIP instance and the associated configuration.

Command	Purpose
no router rip <i>instance-tag</i> Example: switch(config)# no router rip Enterprise	Deletes the RIP instance and all associated configuration.



Note You must also remove any RIP commands that are configured in interface mode.

You can configure the following optional parameters for RIP in address-family configuration mode:

Command	Purpose
distance <i>value</i> Example: <pre>switch(config-router-af)# distance 30</pre>	Sets the administrative distance for RIP. The range is from 1 to 255. The default is 120. See the Administrative Distance section.
maximum-paths <i>number</i> Example: <pre>switch(config-router-af)# maximum-paths 6</pre>	Configures the maximum number of equal-cost paths that RIP maintains in the route table. The range is from 1 to 32. The default is 16.

This example shows how to create a RIP instance for IPv4 and set the number of equal-cost paths for load balancing:

```
switch# configure terminal
switch(config)# router rip Enterprise
switch(config-router)# address-family ipv4 unicast
switch(config-router-af)# max-paths 10
switch(config-router-af)# copy running-config startup-config
```

Restarting a RIP Instance

You can restart a RIP instance. This clears all neighbors for the instance.

To restart a RIP instance and remove all associated neighbors, use the following command:

Command	Purpose
restart rip <i>instance-tag</i> Example: <pre>switch(config)# restart rip Enterprise</pre>	Restarts the RIP instance and removes all neighbors.

Configuring RIP on an Interface

You can add an interface to a RIP instance.

Before you begin

Ensure that you have enabled the RIP feature (see the [Enabling the RIP Feature](#) section).

SUMMARY STEPS

1. **configure terminal**
2. **interface** *interface-type slot/port*
3. **no switchport**
4. **ip router rip** *instance-tag*
5. (Optional) **show ip rip** [**instance** *instance-tag*] **interface** [*interface-type slot/port*] [**vrf** *vrf-name*] [**detail**]
6. (Optional) **copy running-config startup-config**

DETAILED STEPS

Procedure

	Command or Action	Purpose
Step 1	configure terminal Example: <pre>switch# configure terminal switch(config)#</pre>	Enters configuration mode.
Step 2	interface <i>interface-type slot/port</i> Example: <pre>switch(config)# interface ethernet 1/2 switch(config-if)#</pre>	Enters interface configuration mode.
Step 3	no switchport Example: <pre>switch(config-if)# no switchport</pre>	Configures the interface as a Layer 3 routed interface.
Step 4	ip router rip <i>instance-tag</i> Example: <pre>switch(config-if)# ip router rip Enterprise</pre>	Associates this interface with a RIP instance
Step 5	(Optional) show ip rip [<i>instance instance-tag</i>] interface [<i>interface-type slot/port</i>] [<i>vrf vrf-name</i>] [detail]	Displays RIP information for an interface.
	Example: <pre>switch(config-if)# show ip rip Enterprise tethernet 1/2</pre>	
Step 6	(Optional) copy running-config startup-config Example: <pre>switch(config)# copy running-config startup-config</pre>	Saves this configuration change.

Example

This example shows how to add the Ethernet 1/2 interface to a RIP instance:

```
switch# configure terminal
switch(config)# interface ethernet 1/2
switch(config-if)# no switchport
switch(config-if)# ip router rip Enterprise
switch(config)# copy running-config startup-config
```

Restarting a RIP Instance

You can restart a RIP instance. This clears all neighbors for the instance.

To restart a RIP instance and remove all associated neighbors, use the following command:

Command	Purpose
restart rip <i>instance-tag</i> Example: switch(config)# restart rip Enterprise	Restarts the RIP instance and removes all neighbors.

Configuring RIP on an Interface

You can add an interface to a RIP instance.

Before you begin

Ensure that you have enabled the RIP feature (see the [Enabling the RIP Feature](#) section).

SUMMARY STEPS

1. **configure terminal**
2. **interface** *interface-type slot/port*
3. **no switchport**
4. **ip router rip** *instance-tag*
5. (Optional) **show ip rip** [**instance** *instance-tag*] **interface** [*interface-type slot/port*] [**vrf** *vrf-name*] [**detail**]
6. (Optional) **copy running-config startup-config**

DETAILED STEPS

Procedure

	Command or Action	Purpose
Step 1	configure terminal Example: switch# configure terminal switch(config)#	Enters configuration mode.
Step 2	interface <i>interface-type slot/port</i> Example: switch(config)# interface ethernet 1/2 switch(config-if)#	Enters interface configuration mode.
Step 3	no switchport Example: switch(config-if)# no switchport	Configures the interface as a Layer 3 routed interface.
Step 4	ip router rip <i>instance-tag</i> Example: switch(config-if)# ip router rip Enterprise	Associates this interface with a RIP instance

	Command or Action	Purpose
Step 5	(Optional) show ip rip [instance <i>instance-tag</i>] interface [<i>interface-type slot/port</i>] [vrf <i>vrf-name</i>] [detail] Example: switch(config-if)# show ip rip Enterprise tethernet 1/2	Displays RIP information for an interface.
Step 6	(Optional) copy running-config startup-config Example: switch(config)# copy running-config startup-config	Saves this configuration change.

Example

This example shows how to add the Ethernet 1/2 interface to a RIP instance:

```
switch# configure terminal
switch(config)# interface ethernet 1/2
switch(config-if)# no switchport
switch(config-if)# ip router rip Enterprise
switch(config)# copy running-config startup-config
```

Configuring RIP Authentication

Before you begin

Ensure that you have enabled the RIP feature (see the [Enabling the RIP Feature](#) section).

Configure a key chain if necessary before enabling authentication. See the [Cisco Nexus 3548 Switch NX-OS Security Configuration Guide](#) for details on implementing key chains.

SUMMARY STEPS

1. **configure terminal**
2. **interface** *interface-type slot/port*
3. **no switchport**
4. **ip rip authentication mode** { **text** | **md5** }
5. **ip rip authentication key-chain** *key*
6. (Optional) **copy running-config startup-config**

DETAILED STEPS**Procedure**

	Command or Action	Purpose
Step 1	configure terminal Example:	Enters configuration mode.

	Command or Action	Purpose
	switch# configure terminal switch(config)#	
Step 2	interface <i>interface-type slot/port</i> Example: switch(config)# interface ethernet 1/2 switch(config-if)#	Enters interface configuration mode.
Step 3	no switchport Example: switch(config-if)# no switchport	Configures the interface as a Layer 3 routed interface.
Step 4	ip rip authentication mode { text md5 } Example: switch(config-if)# ip rip authentication mode md5	Sets the authentication type for RIP on this interface as cleartext or MD5 authentication digest.
Step 5	ip rip authentication key-chain <i>key</i> Example: switch(config-if)# ip rip authentication keychain RIPKey	Configures the authentication key used for RIP on this interface.
Step 6	(Optional) copy running-config startup-config Example: switch(config)# copy running-config startup-config	Saves this configuration change.

Example

This example shows how to create a key chain and configure MD5 authentication on a RIP interface:

```
switch# configure terminal
switch(config)# key chain RIPKey
switch(config)# key-string myrip
switch(config)# accept-lifetime 00:00:00 Jan 01 2000 infinite
switch(config)# send-lifetime 00:00:00 Jan 01 2000 infinite
switch(config)# interface ethernet 1/2
switch(config-if)# no switchport
switch(config-if)# ip rip authentication mode md5
switch(config-if)# ip rip authentication keychain RIPKey
switch(config-if)# copy running-config startup-config
```

Configuring a Passive Interface

You can configure a RIP interface to receive routes but not send route updates by setting the interface to passive mode.

To configure a RIP interface in passive mode, use the following command in interface configuration mode:

Command	Purpose
ip rip passive-interface Example : <pre>switch(config-if)# ip rip passive-interface</pre>	Sets the interface into passive mode.

Configuring Split Horizon with Poison Reverse

You can configure an interface to advertise routes learned by RIP as unreachable over the interface that learned the routes by enabling poison reverse.

To configure split horizon with poison reverse on an interface, use the following command in interface configuration mode:

Command	Purpose
ip rip poison-reverse Example : <pre>switch(config-if)# ip rip poison-reverse</pre>	Enables split horizon with poison reverse. Split horizon with poison reverse is disabled by default.

Configuring Route Summarization

You can create aggregate addresses that are represented in the routing table by a summary address. Cisco NX-OS advertises the summary address metric that is the smallest metric of all the more-specific routes.

To configure a summary address on an interface, use the following command in interface configuration mode:

Command	Purpose
ip rip summary-address <i>ip-prefix/mask-len</i> Example : <pre>switch(config-if)# ip router rip summary-address 192.0.2.0/24</pre>	Configures a summary address for RIP for IPv4 addresses.

Configuring Route Redistribution

You can configure RIP to accept routing information from another routing protocol and redistribute that information through the RIP network. Redistributed routes can optionally be assigned a default route.

Before you begin

Ensure that you have enabled the RIP feature (see the [Enabling the RIP Feature](#) section).

Configure a route map before configuring redistribution. See the [Configuring Route Maps](#) section for details on configuring route maps.

SUMMARY STEPS

1. **configure terminal**
2. **router rip** *instance-tag*
3. **address-family ipv4 unicast**
4. **redistribute** { **bgp** *as* | **direct** | **eigrp** | **ospf** | **ospfv3** | **rip** } *instance-tag* | **static** } **route-map** *map-name*
5. (Optional) **default-information originate** [**always**] [**route-map** *map-name*]
6. (Optional) **default-metric** *value*
7. (Optional) **show ip rip route** [*ip-prefix* [**longer-prefixes** | **shorter-prefixes**] [**vrf** *vrf-name*] [*summary*]
8. (Optional) **copy running-config startup-config**

DETAILED STEPS

Procedure

	Command or Action	Purpose
Step 1	configure terminal Example: switch# configure terminal switch(config)#	Enters configuration mode.
Step 2	router rip <i>instance-tag</i> Example: switch(config)# router RIP Enterprise switch(config-router)#	Creates a new RIP instance with the configured <i>instance-tag</i> <i>value</i> .
Step 3	address-family ipv4 unicast Example: switch(config-router)# address-family ipv4 unicast switch(config-router-af)#	Configures the address family for this RIP instance and enters address-family configuration mode.
Step 4	redistribute { bgp <i>as</i> direct eigrp ospf ospfv3 rip } <i>instance-tag</i> static } route-map <i>map-name</i> Example: switch(config-router-af)# redistribute eigrp 201 route-map RIPmap	Redistributes routes from other protocols into RIP. See the Configuring Route Maps section for more information about route maps.
Step 5	(Optional) default-information originate [always] [route-map <i>map-name</i>] Example: switch(config-router-af)# default-information originate always	Generates a default route into RIP, optionally controlled by a route map.
Step 6	(Optional) default-metric <i>value</i> Example: switch(config-router-af)# default-metric 10	Sets the default metric for all redistributed routes. The range is from 1 to 15. The default is 1.

	Command or Action	Purpose
Step 7	(Optional) <code>show ip rip route [ip-prefix [longer-prefixes shorter-prefixes] [vrf vrf-name] [summary]</code> Example: <code>switch(config-router-af)# show ip rip route</code>	Shows the routes in RIP.
Step 8	(Optional) <code>copy running-config startup-config</code> Example: <code>switch(config)# copy running-config startup-config</code>	Saves this configuration change.

Example

This example shows how to redistribute EIGRP into RIP:

```
switch# configure terminal
switch(config)# router rip Enterprise
switch(config-router)# address-family ipv4 unicast
switch(config-router-af)# redistribute eigrp 201 route-map RIPmap
switch(config-router-af)# copy running-config startup-config
```

Configuring Virtualization

You can create multiple VRFs and use the same or multiple RIP instances in each VRF. You assign a RIP interface to a VRF.



Note Configure all other parameters for an interface after you configure the VRF for an interface. Configuring a VRF for an interface deletes all the configuration for that interface.

Before you begin

Ensure that you have enabled the RIP feature (see the [Enabling the RIP Feature](#) section).

SUMMARY STEPS

1. `configure terminal`
2. `vrf vrf-name`
3. `exit`
4. `router rip instance-tag`
5. `vrf context vrf-name`
6. (Optional) `address-family ipv4 unicast`
7. (Optional) `redistribute { bgp as | direct | eigrp | ospf | ospfv3 | rip } instance-tag [static] route-map map-name`
8. `interface ethernet slot/port`
9. `no switchport`
10. `vrf member vrf-name`

11. **ip address** *ip-prefix/length*
12. **ip router rip** *instance-tag*
13. (Optional) **show ip rip route** [*ip-prefix* [**longer-prefixes** | **shorter-prefixes**] [**vrf vrf-name**] [*summary*]
14. (Optional) **copy running-config startup-config**

DETAILED STEPS

Procedure

	Command or Action	Purpose
Step 1	configure terminal Example: switch# configure terminal switch(config)#	Enters configuration mode.
Step 2	vrf vrf-name Example: switch(config)# vrf RemoteOfficeVRF switch(config-vrf)#	Creates a new VRF.
Step 3	exit Example: switch(config-vrf)# exit switch(config)#	Exits VRF configuration mode.
Step 4	router rip instance-tag Example: switch(config)# router RIP Enterprise switch(config-router)#	Creates a new RIP instance with the configured <i>instance-tag</i> value.
Step 5	vrf context vrf-name Example: switch(config)# vrf context RemoteOfficeVRF switch(config-vrf)#	Creates a new VRF and enters VRF configuration mode.
Step 6	(Optional) address-family ipv4 unicast Example: switch(config-router)# address-family ipv4 unicast switch(config-router-af)#	Configures the VRF address family for this RIP instance.
Step 7	(Optional) redistribute { bgp as direct eigrp ospf ospfv3 rip } instance-tag static } route-map map-name Example: switch(config-router-af)# redistribute eigrp 201 route-map RIPmap	Redistributes routes from other protocols into RIP. See the Configuring Route Maps section for more information about route maps.

	Command or Action	Purpose
Step 8	interface <i>ethernet slot/port</i> Example: switch(config-router-vrf-af)# interface ethernet 1/2 switch(config-if)#	Enters interface configuration mode.
Step 9	no switchport Example: switch(config-if)# no switchport	Configures the interface as a Layer 3 routed interface.
Step 10	vrf member <i>vrf-name</i> Example: switch(config-if)# vrf member RemoteOfficeVRF	Adds this interface to a VRF.
Step 11	ip address <i>ip-prefix/length</i> Example: switch(config-if)# ip address 192.0.2.1/16	Configures an IP address for this interface. You must do this step after you assign this interface to a VRF.
Step 12	ip router rip <i>instance-tag</i> Example: switch(config-if)# ip router rip Enterprise	Associates this interface with a RIP instance.
Step 13	(Optional) show ip rip route [<i>ip-prefix</i> [longer-prefixes shorter-prefixes] [<i>vrf vrf-name</i>] [<i>summary</i>] Example: switch(config-router-af)# show ip rip route	Shows the routes in RIP.
Step 14	(Optional) copy running-config startup-config Example: switch(config)# copy running-config startup-config	Saves this configuration change.

Example

This example shows how to create a VRF and add an interface to the VRF:

```
switch# configure terminal
switch(config)# vrf context RemoteOfficeVRF
switch(config-vrf)# exit
switch(config)# router rip Enterprise
switch(config-router)# vrf RemoteOfficeVRF
switch(config-router-vrf)# address-family ipv4 unicast
switch(config-router-vrf-af)# redistribute eigrp 201 route-map RIPmap
switch(config-router-vrf-af)# interface ethernet 1/2
switch(config-if)# no switchport
switch(config-if)# vrf member RemoteOfficeVRF
switch(config-if)# ip address 192.0.2.1/16
switch(config-if)# ip router rip Enterprise
switch(config-if)# copy running-config startup-config
```

Tuning RIP

You can tune RIP to match your network requirements. RIP uses several timers that determine the frequency of routing updates, the length of time before a route becomes invalid, and other parameters. You can adjust these timers to tune routing protocol performance to better suit your internetwork needs.



Note You must configure the same values for the RIP timers on all RIP-enabled routers in your network.

You can use the following optional commands in address-family configuration mode to tune RIP:

Command	Purpose
<p>timers basic <i>update timeout holddown garbage-collection</i></p> <p>Example:</p> <pre>switch(config-router-af)# timers basic 40 120 120 100</pre>	<p>Sets the RIP timers in seconds. The parameters are as follows:</p> <ul style="list-style-type: none"> • update—The range is from 5 to any positive integer. The default is 30. • timeout—The time that Cisco NX-OS waits before declaring a route as invalid. If Cisco NX-OS does not receive route update information for this route before the timeout interval ends, Cisco NX-OS declares the route as invalid. The range is from 1 to any positive integer. The default is 180. • holddown—The time during which Cisco NX-OS ignores better route information for an invalid route. The range is from 0 to any positive integer. The default is 180. • garbage-collection—The time from when Cisco NX-OS marks a route as invalid until Cisco NX-OS removes the route from the routing table. The range is from 1 to any positive integer. The default is 120.

You can use the following optional commands in interface configuration mode to tune RIP:

Command	Purpose
<p>ip rip metric-offset <i>value</i></p> <p>Example :</p> <pre>switch(config-if)# ip rip metric-offset 10</pre>	<p>Adds a value to the metric for every router received on this interface. The range is from 1 to 15. The default is 1.</p>
<p>ip rip route-filter {prefix-list <i>list-name</i> route-map <i>map-name</i> [in out]}</p> <p>Example :</p> <pre>switch(config-if)# ip rip route-filter route-map InputMap in</pre>	<p>Specifies a route map to filter incoming or outgoing RIP updates.</p>

Verifying the RIP Configuration

To display the RIP configuration information, perform one of the following tasks:

Command	Purpose
<code>show ip rip instance [instance-tag] [vrf vrf-name]</code>	Displays the status for an instance of RIP.
<code>show ip rip [instance instance-tag] interface slot/port detail [vrf vrf-name]</code>	Displays the RIP status for an interface.
<code>show ip rip [instance instance-tag] neighbor [interface-type number] [vrf vrf-name]</code>	Displays the RIP neighbor table.
<code>show ip rip [instance instance-tag] route [ip-prefix/length [longer-prefixes shorter--prefixes]] [summary] [vrf vrf-name]</code>	Displays the RIP route table.
<code>show running-configuration rip</code>	Displays the current running RIP configuration.

Displaying RIP Statistics

To display the RIP statistics, use the following commands:

Command	Purpose
<code>show ip rip [instance instance-tag] policy statistics redistribute { bgp as direct { eigrp ospf ospfv3 rip } instance-tag static } [vrf vrf-name]</code>	Displays the RIP policy status.
<code>show ip rip [instance instance-tag] statistics interface-type number [vrf vrf-name]</code>	Displays the RIP statistics.

Use the `clear ip rip policy` command to clear policy statistics.

Use the `clear ip rip statistics` command to clear RIP statistics.

Configuration Examples for RIP

This example creates the Enterprise RIP instance in a VRF and adds Ethernet interface 1/2 to this RIP instance. The example also configures authentication for Ethernet interface 1/2 and redistributes EIGRP into this RIP domain.

```
vrf context NewVRF
!
feature rip
router rip Enterprise
vrf NewVRF
address-family ip unicast
redistribute eigrp 201 route-map RIPmap
```

```

max-paths 10

!

interface ethernet 1/2

no switchport

vrf NewVRF

ip address 192.0.2.1/16

ip router rip Enterprise

ip rip authentication mode md5

ip rip authentication keychain RIPKey

```

Related Topics

See [Configuring Route Policy Manager](#) for more information on route maps.

Additional References

For additional information related to implementing RIP, see the following sections:

- [Related Documents](#)
- [Standards](#)

Related Documents

Related Topic	Document Title
RIP CLI commands	Cisco Nexus 3000 Series Command Reference

Standards

Standards	Title
No new or modified standards are supported by this feature, and support for existing standards has not been modified by this feature.	—



CHAPTER 10

Configuring Static Routing

This chapter describes how to configure static route on the router.

This chapter includes the following sections:

- [Information About Static Routing, on page 225](#)
- [Prerequisites for Static Routing, on page 227](#)
- [Guidelines and Limitations for Static Routing, on page 227](#)
- [Default Settings for Static Routing, on page 227](#)
- [Configuring Static Routing, on page 227](#)
- [Verifying the Static Routing Configuration, on page 229](#)
- [Configuration Examples for Static Routing, on page 230](#)
- [Additional References, on page 230](#)

Information About Static Routing

Routers forward packets using either route information from route table entries that you manually configure or the route information that is calculated using dynamic routing algorithms.

Static routes, which define explicit paths between two routers, cannot be automatically updated; you must manually reconfigure static routes when network changes occur. Static routes use less bandwidth than dynamic routes. No CPU cycles are used to calculate and analyze routing updates.

You can supplement dynamic routes with static routes where appropriate. You can redistribute static routes into dynamic routing algorithms but you cannot redistribute routing information calculated by dynamic routing algorithms into the static routing table.

You should use static routes in environments where network traffic is predictable and where the network design is simple. You should not use static routes in large, constantly changing networks because static routes cannot react to network changes. Most networks use dynamic routes to communicate between routers but may have one or two static routes configured for special cases. Static routes are also useful for specifying a gateway of last resort (a default router to which all unroutable packets are sent).

Administrative Distance

An administrative distance is the metric used by routers to choose the best path when there are two or more routes to the same destination from two different routing protocols. An administrative distance guides the selection of one routing protocol (or static route) over another, when more than one protocol adds the same

route to the unicast routing table. Each routing protocol is prioritized in order of most to least reliable using an administrative distance value.

Static routes have a default administrative distance of 1. A router prefers a static route to a dynamic route because the router considers a route with a low number to be the shortest. If you want a dynamic route to override a static route, you can specify an administrative distance for the static route. For example, if you have two dynamic routes with an administrative distance of 120, you would specify an administrative distance that is greater than 120 for the static route if you want the dynamic route to override the static route.

Directly Connected Static Routes

You need to specify only the output interface (the interface on which all packets are sent to the destination network) in a directly connected static route. The router assumes the destination is directly attached to the output interface and the packet destination is used as the next hop address. The next-hop can be an interface, only for point-to-point interfaces. For broadcast interfaces, the next-hop must be an IPv4 address.

Floating Static Routes

A floating static route is a static route that the router uses to back up a dynamic route. You must configure a floating static route with a higher administrative distance than the dynamic route that it backs up. In this instance, the router prefers a dynamic route to a floating static route. You can use a floating static route as a replacement if the dynamic route is lost.



Note By default, a router prefers a static route to a dynamic route because a static route has a smaller administrative distance than a dynamic route.

Fully Specified Static Routes

You must specify either the output interface (the interface on which all packets are sent to the destination network) or the next hop address in a fully specified static route. You can use a fully specified static route when the output interface is a multi-access interface and you need to identify the next-hop address. The next-hop address must be directly attached to the specified output interface.

Remote Next Hops for Static Routes

You can specify the next-hop address of a neighboring router that is not directly connected to the router for static routes with remote (non directly attached) next hops. If a static route has remote next hops during data forwarding, the next hops are recursively used in the unicast routing table to identify the corresponding directly attached next hops that have reachability to the remote next hops.

Virtualization Support

Static routes support Virtual Routing and Forwarding instances (VRFs). By default, Cisco NX-OS places you in the default VRF unless you specifically configure another VRF.

Prerequisites for Static Routing

Static routing has the following prerequisites:

- The next-hop address for a static route must be reachable or the static route will not be added to the unicast routing table.

Guidelines and Limitations for Static Routing

Static routing has the following configuration guidelines and limitations:

- You can specify an interface as the next-hop address for a static route only for point-to-point interfaces such as GRE tunnels.

Default Settings for Static Routing

Table below lists the default settings for static routing parameters.

Table 12: Default Static Routing Parameters

Parameters	Default
administrative distance	1
RIP feature	disabled

Configuring Static Routing



Note If you are familiar with the Cisco IOS CLI, be aware that the Cisco NX-OS commands for this feature might differ from the Cisco IOS commands that you would use.

Configuring a Static Route

You can configure a static route on the router.

SUMMARY STEPS

1. **configure terminal**
2. **ip route** { *ip-prefix* | *ip-addr ip-mask* } { [*next-hop* | *nh-prefix*] | [*interface next-hop* | *nh-prefix*] } [**tag** *tag-value* [*pref*]
3. (Optional) **show ip static-route**

4. (Optional) copy running-config startup-config

DETAILED STEPS

Procedure

	Command or Action	Purpose
Step 1	configure terminal Example: <pre>switch# configure terminal switch(config)#</pre>	Enters configuration mode.
Step 2	ip route { <i>ip-prefix</i> <i>ip-addr ip-mask</i> } { [<i>next-hop</i> <i>nh-prefix</i>] } [[<i>interface next-hop</i> <i>nh-prefix</i>]] [tag <i>tag-value</i> [<i>pref</i>]] Example: <pre>switch(config)# ip route 192.0.2.0/8 ethernet 1/2 192.0.2.4</pre>	Configures a static route and the interface for this static route. You can optionally configure the next-hop address. The <i>pref</i> value sets the administrative distance. The range is from 1 to 255. The default is 1.
Step 3	(Optional) show ip static-route Example: <pre>switch(config)# show ip static-route</pre>	Displays information about static routes.
Step 4	(Optional) copy running-config startup-config Example: <pre>switch(config)# copy running-config startup-config</pre>	Saves this configuration change.

Example

This example shows how to configure a static route:

```
switch# configure terminal
switch(config)# ip route 192.0.2.0/8 192.0.2.10
switch(config)# copy running-config startup-config
```

Use the **no ip static-route** command to remove the static route.

Configuring Virtualization

You can configure a static route in a VRF.

SUMMARY STEPS

1. **configure terminal**
2. **vrf context** *vrf-name*
3. **ip route** { *ip-prefix* | *ip-addr ip-mask* } { [*next-hop* | *nh-prefix*] } [[*interface next-hop* | *nh-prefix*]] [**tag** *tag-value* [*pref*]]

4. (Optional) **show ip static-route vrf vrf-name**
5. (Optional) **copy running-config startup-config**

DETAILED STEPS

Procedure

	Command or Action	Purpose
Step 1	configure terminal Example: switch# configure terminal switch(config)#	Enters configuration mode.
Step 2	vrf context vrf-name Example: switch(config)# vrf context StaticVrf	Creates a VRF and enters VRF configuration mode.
Step 3	ip route { ip-prefix ip-addr ip-mask } {[next-hop nh-prefix] [interface next-hop nh-prefix]} [tag tag-value [pref] Example: switch(config)# ip route 192.0.2.0/8 ethernet 1/2 192.0.2.4	Configures a static route and the interface for this static route. You can optionally configure the next-hop address. The <i>pref</i> value sets the administrative distance. The range is from 1 to 255. The default is 1.
Step 4	(Optional) show ip static-route vrf vrf-name Example: switch(config)# show ip static-route	Displays information about static routes.
Step 5	(Optional) copy running-config startup-config Example: switch(config)# copy running-config startup-config	Saves this configuration change.

Example

This example shows how to configure a static route:

```
switch# configure terminal
switch(config)# vrf context StaticVrf
switch(config-vrf)# ip route 192.0.2.0/8 192.0.2.10
switch(config-vrf)# copy running-config startup-config
```

Verifying the Static Routing Configuration

To display the static routing configuration information, use this command:

Command	Purpose
<code>show ip static-route</code>	Displays the configured static routes.

Configuration Examples for Static Routing

This example shows how to configure static routing:

```
configure terminal
ip route 192.0.2.0/8 192.0.2.10
copy running-config startup-config
```

Additional References

For additional information related to implementing static routing, see the following sections:

- [Related Documents](#)

Related Documents

Related Topic	Document Title
Static Routing CLI	Cisco Nexus 3000 Series Command Reference



CHAPTER 11

Configuring Layer 3 Virtualization

This chapter describes how to configure Layer 3 virtualization.

This chapter includes the following sections:

- [Layer 3 Virtualization, on page 231](#)
- [Guidelines and Limitations for VRF, on page 234](#)
- [Guidelines and Limitations for VRF-Lite, on page 235](#)
- [Guidelines and Limitations for VRF Route Leaking, on page 235](#)
- [Default Settings, on page 235](#)
- [Configuring VRFs, on page 236](#)
- [Verifying the VRF Configuration, on page 242](#)
- [Configuration Examples for VRFs, on page 242](#)
- [Related Topics, on page 245](#)
- [Additional References, on page 245](#)
- [Feature History for VRF, on page 245](#)

Layer 3 Virtualization

This section includes the following topics:

Overview of Layer 3 Virtualization

Cisco NX-OS supports virtual routing and forwarding instances (VRFs). Each VRF contains a separate address space with unicast route tables for IPv4 and makes routing decisions independent of any other VRF.

Each router has a default VRF and a management VRF. All Layer 3 interfaces and routing protocols exist in the default VRF until you assign them to another VRF. The mgmt0 interface exists in the management VRF. With the VRF-lite feature, the switch supports multiple VRFs in customer edge (CE) switches. VRF-lite allows a service provider to support two or more Virtual Private Networks (VPNs) with overlapping IP addresses using one interface.



Note The switch does not use Multiprotocol Label Switching (MPLS) to support VPNs.

VRF and Routing

All unicast and multicast routing protocols support VRFs. When you configure a routing protocol in a VRF, you set routing parameters for the VRF that are independent of routing parameters in another VRF for the same routing protocol instance.

You can assign interfaces and route protocols to a VRF to create virtual Layer 3 networks. An interface exists in only one VRF. The following figure shows one physical network split into two virtual networks with two VRFs. Routers Z, A, and B exist in VRF Red and form one address domain. These routers share route updates that do not include router C because router C is configured in a different VRF.

Figure 16: VRFs in a Network

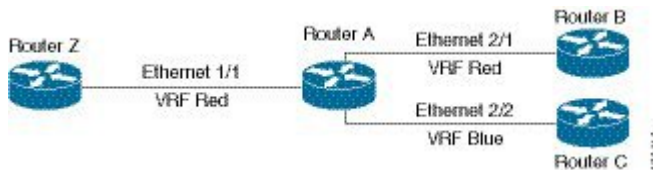

By default, Cisco NX-OS uses the VRF of the incoming interface to select which routing table to use for a route lookup. You can configure a route policy to modify this behavior and set the VRF that Cisco NX-OS uses for incoming packets.

VRF supports route leaking (import or export) between VRFs. Certain limitations apply to route leaking in VRF-Lite. For more information, see [Guidelines and Limitations for VRF Route Leaking](#).

VRF-Lite

VRF-lite is a feature that enables a service provider to support two or more VPNs, where IP addresses can be overlapped among the VPNs. VRF-lite uses input interfaces to distinguish routes for different VPNs and forms virtual packet-forwarding tables by associating one or more Layer 3 interfaces with each VRF. Interfaces in a VRF can be either physical, such as Ethernet ports, or logical, such as VLAN SVIs, but a Layer 3 interface cannot belong to more than one VRF at any time.



Note Multiprotocol Label Switching (MPLS) and MPLS control plane are not supported in the VRF-lite implementation.



Note VRF-lite interfaces must be Layer 3 interfaces.

VRF-Aware Services

A fundamental feature of the Cisco NX-OS architecture is that every IP-based feature is VRF aware.

The following VRF-aware services can select a particular VRF to reach a remote server or to filter information based on the selected VRF:

- AAA—See the Cisco Nexus 3548 Switch NX-OS Security Configuration Guide for more information.

- Call Home—See the Cisco Nexus 3548 Switch NX-OS System Management Configuration Guide for more information.
- HSRP—See the "Configuring HSRP" chapter for more information.
- HTTP—See the Cisco Nexus 3548 Switch NX-OS Fundamentals Configuration Guide for more information.
- Licensing—See the [Cisco NX-OS Licensing Guide](#) for more information.
- NTP—See the Cisco Nexus 3548 Switch NX-OS System Management Configuration Guide for more information.
- RADIUS—See the Cisco Nexus 3548 Switch NX-OS Security Configuration Guide for more information.
- Ping and Traceroute —See the Cisco Nexus 3548 Switch NX-OS Fundamentals Configuration Guide for more information.
- SSH—See the Cisco Nexus 3548 Switch Fundamentals Configuration Guide for more information.
- SNMP—See the Cisco Nexus 3548 Switch NX-OS System Management Configuration Guide for more information.
- Syslog—See the Cisco Nexus 3548 Switch NX-OS System Management Configuration Guide for more information.
- TACACS+—See the Cisco Nexus 3548 Switch NX-OS Security Configuration Guide for more information.
- TFTP—See the Cisco Nexus 3548 Switch NX-OS Fundamentals Configuration Guide for more information.
- VRRP—See the "Configuring VRRP" chapter for more information.

See the appropriate [Cisco Nexus 3548 Switch Configuration Guide](#) for each service for more information on configuring VRF support in that service.

Reachability

Reachability indicates which VRF contains the routing information necessary to get to the server providing the service. For example, you can configure an SNMP server that is reachable on the management VRF. When you configure that server address on the router, you also configure which VRF that Cisco NX-OS must use to reach the server.

The following figure shows an SNMP server that is reachable over the management VRF. You configure router A to use the management VRF for SNMP server host 192.0.2.1.

Figure 17: Service VRF Reachability

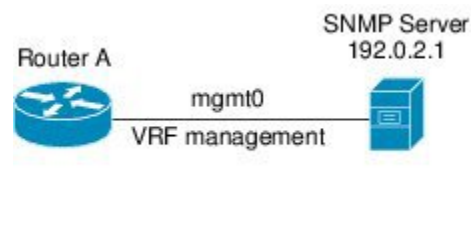

Filtering

Filtering allows you to limit the type of information that goes to a VRF-aware service based on the VRF. For example, you can configure a syslog server to support a particular VRF. The following figure shows two syslog servers with each server supporting one VRF. Syslog server A is configured in VRF Red, so Cisco NX-OS sends only system messages generated in VRF Red to syslog server A.

Figure 18: Service VRF Filtering

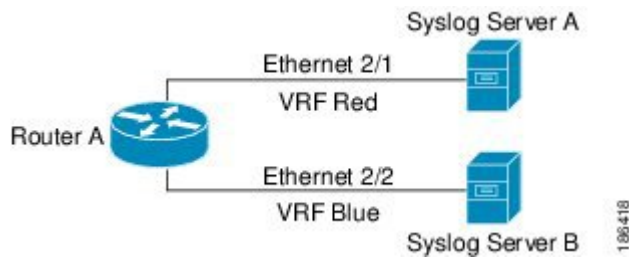

Combining Reachability and Filtering

You can combine reachability and filtering for VRF-aware services. You configure the VRF that Cisco NX-OS uses to connect to that service as well as the VRF that the service supports. If you configure a service in the default VRF, you can optionally configure the service to support all VRFs.

The following figure shows an SNMP server that is reachable on the management VRF. You can configure the SNMP server to support only the SNMP notifications from VRF Red, for example.

Figure 19: Service VRF Reachability Filtering

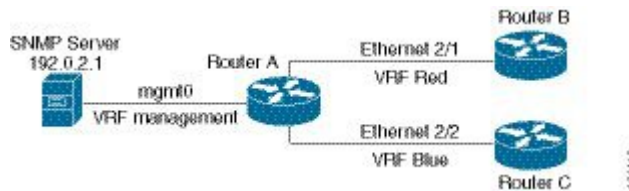

Guidelines and Limitations for VRF

VRFs have the following configuration guidelines and limitations in a VRF-lite scenario:

- When you make an interface a member of an existing VRF, Cisco NX-OS removes all Layer 3 configuration. You should configure all Layer 3 parameters after adding an interface to a VRF.
- You should add the mgmt0 interface to the management VRF and configure the mgmt0 IP address and other parameters after you add it to the management VRF.
- If you configure an interface for a VRF before the VRF exists, the interface is operationally down until you create the VRF.
- Cisco NX-OS creates the default and management VRFs by default. You should make the mgmt0 interface a member of the management VRF.
- The **write erase boot** command does not remove the management VRF configuration. You must use the **write erase command** and then the **write erase boot** command.

Guidelines and Limitations for VRF-Lite

VRF-lite has the following guidelines and limitations:

- A switch with VRF-lite has a separate IP routing table for each VRF, which is separate from the global routing table.
- Because VRF-lite uses different VRF tables, the same IP addresses can be reused. Overlapped IP addresses are allowed in different VPNs.
- VRF-lite does not support all MPLS-VRF functionality; it does not support label exchange, LDP adjacency, or labeled packets.
- Multiple virtual Layer 3 interfaces can be connected to a VRF-lite switch.
- The switch supports configuring a VRF by using physical ports, VLAN SVIs, or a combination of both. The SVIs can be connected through an access port or a trunk port.
- The Layer 3 TCAM resource is shared between all VRFs. To ensure that any one VRF has sufficient CAM space, use the maximum routes command.
- The total number of routes supported by all the VRF's is limited by the size of the TCAM.
- VRF-lite supports BGP, RIP, and static routing.
- VRF-lite does not support EIGRP.
- VRF-lite does not affect the packet switching rate.
- Multicast cannot be configured on the same Layer 3 interface at the same time.

Guidelines and Limitations for VRF Route Leaking

VRF route leaking has the following guidelines and limitations:

- Route leaking is supported between any two non-default VRFs. It is also supported between the default VRF and any other VRF.
- Route leaking to the default VRF is not allowed because it is the global VRF.
- You can restrict route leaking to specific routes using route map filters to match designated IP addresses.
- By default, the maximum number of IP prefixes that can be leaked is set to 1000 routes. This number can be configured to any value from 0 to 1000.
- VRF route leaking requires an Enterprise license, and BGP must be enabled.

Default Settings

Table below lists the default settings for VRF parameters.

Table 13: Default VRF Parameters

Parameters	Default
Configured VRFs	default, management
routing context	default VRF

Configuring VRFs



Note If you are familiar with the Cisco IOS CLI, be aware that the Cisco NX-OS commands for this feature might differ from the Cisco IOS commands that you would use.

Creating a VRF

You can create a VRF in a switch.

SUMMARY STEPS

1. **configure terminal**
2. **vrf context** *name*
3. **ip route** { *ip-prefix* | *ip-addr ip-mask* } {[*next-hop* | *nh-prefix*] | [*interface next-hop* | *nh-prefix*]} [**tag** *tag-value* [*pref*]
4. (Optional) **show vrf** [*vrf-name*]
5. (Optional) **copy running-config startup-config**

DETAILED STEPS

Procedure

	Command or Action	Purpose
Step 1	configure terminal Example: <pre>switch# configure terminal switch(config)#</pre>	Enters configuration mode.
Step 2	vrf context <i>name</i> Example: <pre>switch(config)# vrf definition Enterprise switch(config-vrf)#</pre>	Creates a new VRF and enters VRF configuration mode. The <i>name</i> can be any case-sensitive, alphanumeric string up to 32 characters.

	Command or Action	Purpose
Step 3	<p>ip route { <i>ip-prefix</i> <i>ip-addr ip-mask</i> } { [<i>next-hop</i> <i>nh-prefix</i>] [<i>interface next-hop</i> <i>nh-prefix</i>] } [tag <i>tag-value</i> [<i>pref</i>]</p> <p>Example:</p> <pre>switch(config-vrf)# ip route 192.0.2.0/8 ethernet 1/2 192.0.2.4</pre>	Configures a static route and the interface for this static route. You can optionally configure the next-hop address. The <i>preference</i> value sets the administrative distance. The range is from 1 to 255. The default is 1.
Step 4	<p>(Optional) show vrf [<i>vrf-name</i>]</p> <p>Example:</p> <pre>switch(config-vrf)# show vrf Enterprise</pre>	Displays VRF information.
Step 5	<p>(Optional) copy running-config startup-config</p> <p>Example:</p> <pre>switch(config)# copy running-config startup-config</pre>	Saves this configuration change.

Example

Use the **no vrf context** command to delete the VRF and the associated configuration:

Command	Purpose
<p>no vrf context <i>name</i></p> <p>Example:</p> <pre>switch(config)# no vrf context Enterprise</pre>	Deletes the VRF and all associated configuration.

Any commands available in global configuration mode are also available in VRF configuration mode.

This example shows how to create a VRF and add a static route to the VRF:

```
switch# configure terminal
switch(config)# vrf context Enterprise
switch(config-vrf)# ip route 192.0.2.0/8 ethernet 1/2
switch(config-vrf)# exit
switch(config)# copy running-config startup-config
```

Assigning VRF Membership to an Interface

You can make an interface a member of a VRF.

Before you begin

Assign the IP address for an interface after you have configured the interface for a VRF.

SUMMARY STEPS

1. **configure terminal**
2. **interface** *interface-type slot/port*
3. **vrf member** *vrf-name*

4. **ip address** *ip-prefix/length*
5. **show vrf vrf-name interface interface-type number**
6. (Optional) **copy running-config startup-config**

DETAILED STEPS

Procedure

	Command or Action	Purpose
Step 1	configure terminal Example: switch# configure terminal switch(config)#	Enters configuration mode.
Step 2	interface interface-type slot/port Example: switch(config)# interface ethernet 1/2 switch(config-if)#	Enters interface configuration mode.
Step 3	vrf member vrf-name Example: switch(config-if)# vrf member RemoteOfficeVRF	Adds this interface to a VRF.
Step 4	ip address ip-prefix/length Example: switch(config-if)# ip address 192.0.2.1/16	Configures an IP address for this interface. You must do this step after you assign this interface to a VRF.
Step 5	show vrf vrf-name interface interface-type number Example: switch(config-vrf)# show vrf Enterprise interface ethernet 1/2	Displays VRF information.
Step 6	(Optional) copy running-config startup-config Example: switch(config)# copy running-config startup-config	Saves this configuration change.

Example

This example shows how to add an interface to the VRF:

```
switch# configure terminal
switch(config)# interface ethernet 1/2
switch(config-if)# vrf member RemoteOfficeVRF
switch(config-if)# ip address 192.0.2.1/16
switch(config-if)# copy running-config startup-config
```

Configuring VRF Parameters for a Routing Protocol

You can associate a routing protocol with one or more VRFs. See the appropriate chapter for information on how to configure VRFs for the routing protocol. This section uses OSPFv2 as an example protocol for the detailed configuration steps.

SUMMARY STEPS

1. **configure terminal**
2. **router ospf** *instance-tag*
3. **vrf** *vrf-name*
4. (Optional) **maximum-paths** *paths*
5. **interface** *interface-typeslot/port*
6. **vrf member** *vrf-name*
7. **ip address** *ip-prefix/length*
8. **ip router ospf** *instance-tag area area-id*
9. (Optional) **copy running-config startup-config**

DETAILED STEPS

Procedure

	Command or Action	Purpose
Step 1	configure terminal Example: <pre>switch# configure terminal switch(config)#</pre>	Enters configuration mode.
Step 2	router ospf <i>instance-tag</i> Example: <pre>switch(config-vrf)# router ospf 201 switch(config-router)#</pre>	Creates a new OSPFv2 instance with the configured instance tag.
Step 3	vrf <i>vrf-name</i> Example: <pre>switch(config-router)# vrf RemoteOfficeVRF switch(config-router-vrf)#</pre>	Enters VRF configuration mode.
Step 4	(Optional) maximum-paths <i>paths</i> Example: <pre>switch(config-router-vrf)# maximum-paths 4</pre>	Configures the maximum number of equal OSPFv2 paths to a destination in the route table for this VRF. Used for load balancing.
Step 5	interface <i>interface-typeslot/port</i> Example: <pre>switch(config)# interface ethernet 1/2 switch(config-if)#</pre>	Enters interface configuration mode.

	Command or Action	Purpose
Step 6	vrf member <i>vrf-name</i> Example: switch(config-if)# vrf member RemoteOfficeVRF	Adds this interface to a VRF.
Step 7	ip address <i>ip-prefix/length</i> Example: switch(config-if)# ip address 192.0.2.1/16	Configures an IP address for this interface. You must do this step after you assign this interface to a VRF.
Step 8	ip router ospf <i>instance-tag area area-id</i> Example: switch(config-if)# ip router ospf 201 area 0	Assigns this interface to the OSPFv2 instance and area configured.
Step 9	(Optional) copy running-config startup-config Example: switch(config)# copy running-config startup-config	Saves this configuration change.

Example

This example shows how to create a VRF and add an interface to the VRF:

```
switch# configure terminal
switch(config)# vrf context RemoteOfficeVRF
switch(config-vrf)# exit
switch(config)# router ospf 201
switch(config-router)# vrf RemoteOfficeVRF
switch(config-router-vrf)# maximum-paths 4
switch(config-router-vrf)# interface ethernet 1/2
switch(config-if)# vrf member RemoteOfficeVRF
switch(config-if)# ip address 192.0.2.1/16
switch(config-if)# ip router ospf 201 area 0
switch(config-if)# exit
switch(config)# copy running-config startup-config
```

Configuring a VRF-Aware Service

You can configure a VRF-aware service for reachability and filtering. See the [VRF-Aware Services](#) section for links to the appropriate chapter or configuration guide for information on how to configure the service for VRFs. This section uses SNMP and IP domain lists as example services for the detailed configuration steps.

SUMMARY STEPS

1. **configure terminal**
2. **snmp-server host** *ip-address* [**filter_vrf** *vrf-name*] [**use-vrf** *vrf-name*]
3. **vrf context** *vrf-name*
4. **ip domain-list** *domain-name* [**all-vrfs**] [**use-vrf** *vrf-name*]
5. (Optional) **copy running-config startup-config**

DETAILED STEPS

Procedure

	Command or Action	Purpose
Step 1	configure terminal Example: <pre>switch# configure terminal switch(config)#</pre>	Enters configuration mode.
Step 2	snmp-server host <i>ip-address</i> [filter_vrf <i>vrf-name</i>] [use-vrf <i>vrf-name</i>] Example: <pre>switch(config)# snmp-server host 192.0.2.1 use-vrf Red switch(config-vrf)#</pre>	Configures a global SNMP server and configures the VRF that Cisco NX-OS uses to reach the service. Use the filter-vrf keyword to filter information from the selected VRF to this server.
Step 3	vrf context <i>vrf-name</i> Example: <pre>switch(config)# vrf context Blue switch(config-vrf)#</pre>	Creates a new VRF.
Step 4	ip domain-list <i>domain-name</i> [all-vrfs][use-vrf <i>vrf-name</i>] Example: <pre>switch(config-vrf)# ip domain-list List all-vrfs use-vrf Blue switch(config-vrf)#</pre>	Configures the domain list in the VRF and optionally configures the VRF that Cisco NX-OS uses to reach the domain name listed.
Step 5	(Optional) copy running-config startup-config Example: <pre>switch(config)# copy running-config startup-config</pre>	Saves this configuration change.

Example

This example shows how to send SNMP information for all VRFs to SNMP host 192.0.2.1, reachable on VRF Red:

```
switch# configure terminal
switch(config)# snmp-server host 192.0.2.1 for-all-vrfs use-vrf Red
switch(config)# copy running-config startup-config
```

This example shows how to Filter SNMP information for VRF Blue to SNMP host 192.0.2.12, reachable on VRF Red:

```
switch# configure terminal
switch(config)# vrf definition Blue
switch(config-vrf)# snmp-server host 192.0.2.12 use-vrf Red
switch(config)# copy running-config startup-config
```

Setting the VRF Scope

You can set the VRF scope for all EXEC commands (for example, **show** commands). This automatically restricts the scope of the output of EXEC commands to the configured VRF. You can override this scope by using the VRF keywords available for some EXEC commands.

To set the VRF scope, use the following command in EXEC mode:

Command	Purpose
routing-context vrf <i>vrf-name</i> Example: <pre>switch# routing-context vrf red switch%red#</pre>	Sets the routing context for all EXEC commands. Default routing context is the default VRF.

To return to the default VRF scope, use the following command in EXEC mode:

Command	Purpose
routing-context vrf default Example: <pre>switch%red# routing-context vrf default switch#</pre>	Sets the default routing context.

Verifying the VRF Configuration

To display the VRF configuration information, perform one of the following tasks:

Command	Purpose
show vrf [<i>vrf-name</i>]	Displays the information for all or one VRF.
show vrf [<i>vrf-name</i>] detail	Displays detailed information for all or one VRF.
show vrf [<i>vrf-name</i>] [interface <i>interface-type slot/port</i>]	Displays the VRF status for an interface.

Configuration Examples for VRFs

This example shows how to configure VRF Red, add an SNMP server to that VRF, and add an instance of OSPF to VRF Red:

```
vrf context Red
  snmp-server host 192.0.2.12 use-vrf Red
  router ospf 201
  interface ethernet 1/2
  vrf member Red
```



```

ip address 192.0.2.1/16
ip router ospf 201 area 0

```

This example shows how to configure VRF Red and Blue, add an instance of OSPF to each VRF, and create an SNMP context for each OSPF instance in each VRF:

```

vrf context Red
vrf context Blue

feature ospf
  router ospf Lab
  vrf Red
  router ospf Production
  vrf Blue

interface ethernet 1/2
  vrf member Red
  ip address 192.0.2.1/16
  ip router ospf Lab area 0
  no shutdown

interface ethernet 10/2
  vrf member Blue
  ip address 192.0.2.1/16
  ip router ospf Production area 0
  no shutdown

snmp-server user admin network-admin auth md5 nbv-12345
  snmp-server community public ro

snmp-server context lab instance Lab vrf Red
  snmp-server context production instance Production vrf Blue
  Use the SNMP context lab to access the OSPF-MIB values for the OSPF instance Lab in VRF
  Red in the previous example.

```

This example shows how to configure route leaking between two non-default VRF's, and from the default VRF to a non-default VRF:

```

feature bgp
  vrf context Green
  ip route 33.33.33.33/32 35.35.1.254
  address-family ipv4 unicast
  route-target import 3:3
  route-target export 2:2
  export map test
  import map test
  import vrf default map test
  interface Ethernet1/7
  vrf member Green
  ip address 35.35.1.2/24
  vrf context Shared

ip route 44.44.44.44/32 45.45.1.254
  address-family ipv4 unicast
  route-target import 1:1
  route-target import 2:2
  route-target export 3:3
  export map test
  import map test
  import vrf default map test
  interface Ethernet1/11
  vrf member Shared
  ip address 45.45.1.2/24
  router bgp 100

```

```

address-family ipv4 unicast
redistribute static route-map test
vrf Green
address-family ipv4 unicast
redistribute static route-map test
vrf Shared
address-family ipv4 unicast
redistribute static route-map test

ip prefix-list test seq 5 permit 0.0.0.0/0 le 32
route-map test permit 10
match ip address prefix-list test
ip route 100.100.100.100/32 55.55.55.1

nexus# show ip route vrf all
IP Route Table for VRF "default"
 '*' denotes best ucast next-hop
 '**' denotes best mcast next-hop
 '[x/y]' denotes [preference/metric]
 '%<string>' in via output denotes VRF <string>
55.55.55.0/24, ubest/mbest: 1/0, attached
 *via 55.55.55.5, Lo0, [0/0], 00:07:59, direct
55.55.55.5/32, ubest/mbest: 1/0, attached
 *via 55.55.55.5, Lo0, [0/0], 00:07:59, local
100.100.100.100/32, ubest/mbest: 1/0
 *via 55.55.55.1, [1/0], 00:07:42, static

IP Route Table for VRF "management"
 '*' denotes best ucast next-hop
 '**' denotes best mcast next-hop
 '[x/y]' denotes [preference/metric]
 '%<string>' in via output denotes VRF <string>
0.0.0.0/0, ubest/mbest: 1/0
 *via 10.29.176.1, [1/0], 12:53:54, static
10.29.176.0/24, ubest/mbest: 1/0, attached
 *via 10.29.176.233, mgmt0, [0/0], 13:11:57, direct
10.29.176.233/32, ubest/mbest: 1/0, attached
 *via 10.29.176.233, mgmt0, [0/0], 13:11:57, local

IP Route Table for VRF "Green"
 '*' denotes best ucast next-hop
 '**' denotes best mcast next-hop
 '[x/y]' denotes [preference/metric]
 '%<string>' in via output denotes VRF <string>
33.33.33.33/32, ubest/mbest: 1/0
 *via 35.35.1.254, [1/0], 00:23:44, static
35.35.1.0/24, ubest/mbest: 1/0, attached
 *via 35.35.1.2, Eth1/7, [0/0], 00:26:46, direct
35.35.1.2/32, ubest/mbest: 1/0, attached
 *via 35.35.1.2, Eth1/7, [0/0], 00:26:46, local
44.44.44.44/32, ubest/mbest: 1/0
 *via 45.45.1.254%Shared, [20/0], 00:12:08, bgp-100, external, tag 100
100.100.100.100/32, ubest/mbest: 1/0
 *via 55.55.55.1%default, [20/0], 00:07:41, bgp-100, external, tag 100

IP Route Table for VRF "Shared"
 '*' denotes best ucast next-hop
 '**' denotes best mcast next-hop
 '[x/y]' denotes [preference/metric]
 '%<string>' in via output denotes VRF <string>
33.33.33.33/32, ubest/mbest: 1/0
 *via 35.35.1.254%Green, [20/0], 00:12:34, bgp-100, external, tag 100
44.44.44.44/32, ubest/mbest: 1/0
 *via 45.45.1.254, [1/0], 00:23:16, static

```

```

45.45.1.0/24, ubest/mbest: 1/0, attached
*via 45.45.1.2, Eth1/11, [0/0], 00:25:53, direct
45.45.1.2/32, ubest/mbest: 1/0, attached
*via 45.45.1.2, Eth1/11, [0/0], 00:25:53, local
100.100.100.100/32, ubest/mbest: 1/0
*via 55.55.55.1%default, [20/0], 00:07:41, bgp-100, external, tag 100
nexus(config)#

```

Related Topics

The following topics can give more information on VRFs:

- [Cisco Nexus 3548 Switch NX-OS Fundamentals Configuration Guide](#)
- [Cisco Nexus 3548 Switch NX-OS System Management Configuration Guide](#)

Additional References

For additional information related to implementing virtualization, see the following sections:

- [Related Documents](#)
- [Standards](#)

Related Documents

Related Topic	Document Title
VRF CLI	Cisco Nexus 3000 Series Command Reference

Standards

Standards	Title
No new or modified standards are supported by this feature, and support for existing standards has not been modified by this feature.	—

Feature History for VRF

Table below lists the release history for this feature.

Table 14: VRF Feature History

Feature Name	Releases	Feature Information
VRF	5.0(3)A1(1)	This feature was introduced.
VRF Route Leaking	6.0(2)A1(1)	This feature was introduced.



CHAPTER 12

Configuring the Unicast RIB and FIB

This chapter describes how to configure and manage routes in the unicast Routing Information Base (RIB) and the Forwarding Information Base (FIB) on Cisco NX-OS switches.

This chapter includes the following sections:

- [Information About the Unicast RIB and FIB, on page 247](#)
- [Managing the Unicast RIB and FIB, on page 249](#)
- [Verifying the Unicast RIB and FIB Configuration, on page 254](#)
- [Additional References, on page 255](#)

Information About the Unicast RIB and FIB

The unicast RIB (IPv4 RIB) and FIB are part of the Cisco NX-OS forwarding architecture, as shown below.

Figure 20: Cisco NX-OS Forwarding Architecture

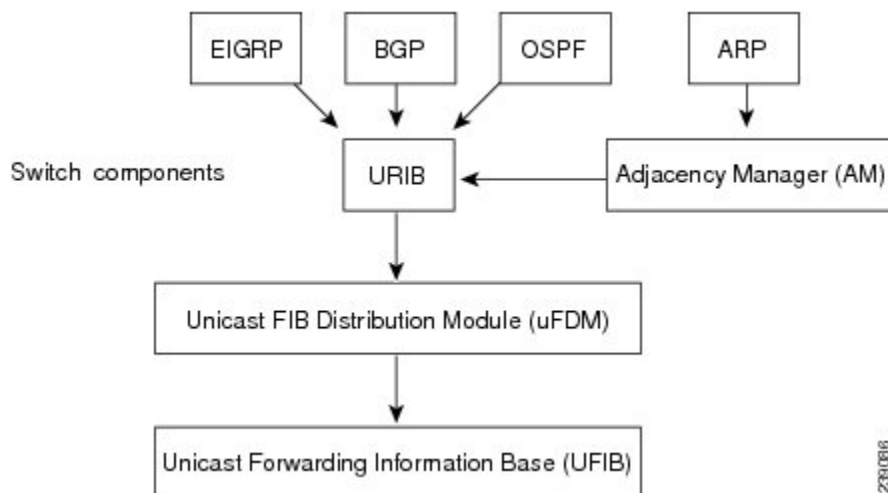

The unicast RIB maintains the routing table with directly connected routes, static routes, and routes learned from dynamic unicast routing protocols. The unicast RIB also collects adjacency information from sources such as the Address Resolution Protocol (ARP). The unicast RIB determines the best next hop for a given route and populates the unicast forwarding information base (FIBs) by using the services of the unicast FIB distribution module (FDM).

Each dynamic routing protocol must update the unicast RIB for any route that has timed out. The unicast RIB then deletes that route and recalculates the best next hop for that route (if an alternate path is available).

Layer 3 Consistency Checker

In rare instances, an inconsistency can occur between the unicast RIB and the FIB on each module. Cisco NX-OS supports the Layer 3 consistency checker. This feature detects inconsistencies between the unicast IPv4 RIB and the FIB on each interface module. Inconsistencies include the following:

- Missing prefix
- Extra prefix
- Wrong next-hop address
- Incorrect Layer 2 rewrite string in the ARP or neighbor discovery (ND) cache

The Layer 3 consistency checker compares the FIB entries to the latest adjacency information from the Adjacency Manager (AM) and logs any inconsistencies. The consistency checker then compares the unicast RIB prefixes to the module FIB and logs any inconsistencies. See the [Triggering the Layer 3 Consistency Checker](#) section.

You can then manually clear any inconsistencies. See the [Clearing Forwarding Information in the FIB](#) section.

When the consistency checker is run before there is no consistency, consistency passes. But when more routes are learned exceeding the hardware limit of 4K and the **show consistency-checker forwarding ipv4** command is run, consistency passes. The same is true when it is transitioning from an inconsistent state to a consistent state. It still shows failure routes. Until and unless the **test forwarding ipv4 inconsistency route** command is run again, it doesn't leave this state. This is an expected behavior.

FIB Tables

The following are the unicast routing table capacities for the Cisco Nexus 3548 switch when the switch is configured in the normal forwarding mode:

- Unicast Routing Host table = 64,000 hash table entries
- Unicast Routing LPM table = 16,000 TCAM entries
- ECMP members Table size: 16,000 entries

The following are the unicast routing table capacities for the Cisco Nexus 3548 switch when the switch is configured in the warp mode:

- L3 Unicast Host table = 8000 TCAM entries
- L3 Unicast LPM table = 4000 TCAM entries



Note ECMP is not supported on warp mode.



Note In warp mode, when two equal cost paths are received in RIB, one of the paths is installed in the hardware. It is recommended to configure the maximum-path to one under the routing protocol configuration.

Virtualization Support

The Unicast RIB and FIB support Virtual Routing and Forwarding instances (VRFs).

Managing the Unicast RIB and FIB



Note If you are familiar with the Cisco IOS CLI, be aware that the Cisco NX-OS commands for this feature might differ from the Cisco IOS commands that you would use.

Displaying Module FIB Information

You can display the FIB information on a switch.

DETAILED STEPS

To display the FIB information on a switch, use the following commands in any mode:

Command	Purpose
show ip fib adjacency Example: <pre>switch# show ip fib adjacency</pre>	Displays the adjacency information for FIB.
show forwarding ipv4 adjacency Example: <pre>switch# show forwarding ipv4 adjacency</pre>	Displays the adjacency information for IPv4.
show ip fib interfaces Example: <pre>switch# show ip fib interfaces</pre>	Displays the FIB interface information for IPv4.
show ip fib route Example: <pre>switch# show ip fib route</pre>	Displays the route table for IPv4.
show forwarding ipv4 route Example: <pre>switch# show forwarding ipv4 route</pre>	Displays the route table for IPv4.

This example shows the FIB contents on a switch:

```
switch# show ip fib route

IPv4 routes for table default/base

-----+-----+-----
Prefix | Next-hop | Interface
-----+-----+-----
0.0.0.0/32 Drop Null0
255.255.255.255/32 Receive sup-eth1
```

Configuring Load Sharing in the Unicast FIB

Dynamic routing protocols, such as Open Shortest Path First (OSPF), support load balancing with equal-cost multipath (ECMP). The routing protocol determines its best routes based on the metrics configured for the protocol and installs up to the protocol-configured maximum paths in the unicast RIB. The unicast RIB compares the administrative distances of all routing protocol paths in the RIB and selects a best path set from all of the path sets installed by the routing protocols. The unicast RIB installs this best path set into the FIB for use by the forwarding plane.

The forwarding plane uses a load-sharing algorithm to select one of the installed paths in the FIB to use for a given data packet.

You can globally configure the following load-sharing settings:

- **load-share mode**—Selects the best path based on the destination address and port or the source and the destination address and port.
- **Universal ID**—Sets the random seed for the hash algorithm. You do not need to configure the Universal ID. Cisco NX-OS chooses the Universal ID if you do not configure it.

Load sharing uses the same path for all packets in a given flow. A flow is defined by the load-sharing method that you configure. For example, if you configure source-destination load sharing, then all packets with the same source IP address and destination IP address pair follow the same path.

To configure the unicast FIB load-sharing algorithm, use the following command in global configuration mode:

Command	Purpose
ip load-sharing address { destination port <i>destination</i> source-destination [port source-destination] } [universal-id <i>seed</i>] Example: <pre>switch(config)# ip load-sharing address source-destination</pre>	Configures the unicast FIB load-sharing algorithm for data traffic. The <i>universal-id</i> range is from 1 to 4294967295.

To display the unicast FIB load-sharing algorithm, use the following command in any mode:

Command	Purpose
show ip load-sharing Example: <pre>switch(config)# show ip load-sharing</pre>	Displays the unicast FIB load-sharing algorithm for data traffic.

To display the route that the unicast RIB and FIB use for a particular source address and destination address, use the following command in any mode:

Command	Purpose
show routing hash source-addr dest-addr [source-port dest-port] [vrf vrf-name] Example: <pre>switch# show routing hash 192.0.2.1 10.0.0.1</pre>	Displays the route that the unicast RIB FIB use for a source and destination address pair. The source address and destination address format is x.x.x.x. The source port and destination port range is from 1 to 65535. The VRF name can be any case-sensitive, alphanumeric string up to 64 characters.

This example shows the route selected for a source/destination pair:

```
switch# show routing hash 10.0.0.5 30.0.0.2
Load-share parameters used for software forwarding:
load-share mode: address source-destination port source-destination
Universal-id seed: 0xe05e2e85
Hash for VRF "default"
Hashing to path *20.0.0.2 (hash: 0x0e), for route:
```

Displaying Routing and Adjacency Information

ou can display the routing and adjacency information.

To display the routing and adjacency information, use the following commands in any mode:

Command	Purpose
show ip route [route-type interface int-type number next-hop] Example: <pre>switch# show ip route</pre>	Displays the unicast route table. The <i>route-type</i> argument can be a single route prefix, direct, static, or a dynamic route protocol. Use the ? keyword to see the supported interfaces.
show ip adjacency [prefix interface number [summary] non-best] [detail] [vrf vrf-id] Example: <pre>switch# show ip adjacency</pre>	Displays the adjacency table. The argument ranges are as follows: <ul style="list-style-type: none"> • <i>prefix</i> —Any IPv4prefix address. • <i>interface-type number</i> —Use the ? keyword to see the supported interfaces. • <i>vrf-id</i> —Any case-sensitive, alphanumeric string up to 32 characters.
show ip routing [route-type interface int-type number next-hop recursive-next-hop summary updated { since until } time] Example: <pre>switch# show routing summary</pre>	Displays the unicast route table. The <i>route-type</i> argument can be a single route prefix, direct, static, or a dynamic route protocol. Use the ? keyword to see the supported interfaces.

This example displays the unicast route table:

```
switch# show ip route
IP Route Table for VRF "default"
```

```
'*' denotes best ucast next-hop
'***' denotes best mcast next-hop
'[x/y]' denotes [preference/metric]

192.168.0.2/24, ubest/mbest: 1/0, attached
*via 192.168.0.32, Eth1/5, [0/0], 22:34:09, direct
192.168.0.32/32, ubest/mbest: 1/0, attached
*via 192.168.0.32, Eth1/5, [0/0], 22:34:09, local
```

This example shows the adjacency information:

```
switch# show ip adjacency

IP Adjacency Table for VRF default
Total number of entries: 2
Address Age MAC Address Pref Source Interface Best
10.1.1.1 02:20:54 00e0.b06a.71eb 50 arp mgmt0 Yes
10.1.1.253 00:06:27 0014.5e0b.81d1 50 arp mgmt0 Yes
```

Triggering the Layer 3 Consistency Checker

You can manually trigger the Layer 3 consistency checker.

To manually trigger the Layer 3 consistency checker, use the following commands in global configuration mode:

Command	Purpose
test [ipv4] [unicast] forwarding inconsistency [vrf vrf-name] [module { slot all }] Example: switch(config)# test forwarding inconsistency	Starts a Layer 3 consistency check. The <i>vrf-name</i> can be any case-sensitive, alphanumeric string up to 32 characters. The <i>slot</i> range is from 1 to 10.

To stop the Layer 3 consistency checker, use the following commands in global configuration mode:

Command	Purpose
test forwarding [ipv4] [unicast] inconsistency [vrf vrf-name] [module { slot all }] stop Example: switch(config)# test forwarding inconsistency stop	Stops a Layer 3 consistency check. The <i>vrf-name</i> can be any case-sensitive, alphanumeric string up to 64 characters. The <i>slot</i> range is from 1 to 10.

To display the Layer 3 inconsistencies, use the following commands in any mode:

Command	Purpose
show forwarding [ipv4] inconsistency [vrf vrf-name] [module { slot all }] Example: switch(config)# show forwarding inconsistency	Displays the results of a Layer 3 consistency check. The <i>vrf-name</i> can be any case-sensitive, alphanumeric string up to 32 characters. The <i>slot</i> range is from 1 to 10.

Clearing Forwarding Information in the FIB

You can clear one or more entries in the FIB.



Note The **clear forwarding** command disrupts forwarding on the switch.

To clear an entry in the FIB, including a Layer 3 inconsistency, use the following command in any mode:

Command	Purpose
clear forwarding { ipv4 } route { * <i>prefix</i> } [vrf <i>vrf-name</i>] [module { <i>slot</i> all }] Example: <pre>switch(config)# clear forwarding ipv4 route *</pre>	Clears one or more entries from the FIB. The route options are as follows: <ul style="list-style-type: none"> • *—All routes. • <i>prefix</i> —Any IPprefix. The <i>vrf-name</i> can be any case-sensitive, alphanumeric string up to 32 characters. The slot range is from 1 to 10.



Note Ensure you clear the RIB entry after you clear the FIB entry.

Estimating Memory Requirements for Routes

You can estimate the memory that a number of routes and next-hop addresses will use.

To estimate the memory requirements for routes, use the following command in any mode:

Command	Purpose
show routing memory estimate routes <i>num-routes</i> next-hops <i>num-nexthops</i> Example: <pre>switch# show routing memory estimate routes 1000 next-hops 1</pre>	Displays the memory requirements for routes. The <i>num-routes</i> range is from 1000 to 1000000. The <i>num-nexthops</i> range is from 1 to 16.

Clearing Routes in the Unicast RIB

You can clear one or more routes from the unicast RIB.



Caution The * keyword is severely disruptive to routing.

To clear one or more entries in the unicast RIB, use the following commands in any mode:

Command	Purpose
<p>clear iproute <i>{* { route prefix/length } [next-hop interface]} [vrf vrf-name]</i></p> <p>Example:</p> <pre>switch(config)# clear ip route 10.2.2.2</pre>	<p>Clears one or more routes from both the unicast RIB and all the module FIBs. The route options are as follows:</p> <ul style="list-style-type: none"> • <i>*</i>—All routes. • <i>route</i> —An individual IProute. • <i>prefix/length</i> —Any IPprefix. • <i>next-hop</i> —The next-hop address • <i>interface</i> —The interface to reach the next-hop address. <p>The <i>vrf-name</i> can be any case-sensitive, alphanumeric string up to 32 characters.</p>
<p>clear routing unicast [<i>ip ipv4</i>] <i>{* { route prefix/length } [next-hop interface]} [vrf vrf-name]</i></p> <p>Example:</p> <pre>switch(config)# clear routing ip 10.2.2.2</pre>	<p>Clears one or more routes from the unicast RIB. The route options are as follows:</p> <ul style="list-style-type: none"> • <i>*</i>—All routes. • <i>route</i> —An individual IProute. • <i>prefix/length</i> —Any IPprefix. • <i>next-hop</i> —The next-hop address • <i>interface</i> —The interface to reach the next-hop address. <p>The <i>vrf-name</i> can be any case-sensitive, alphanumeric string up to 32 characters.</p>

Verifying the Unicast RIB and FIB Configuration

To display the unicast RIB and FIB configuration information, perform one of the following tasks:

Command	Purpose
show forwarding adjacency	Displays the adjacency table on a module.
show forwarding distribution { <i>clients fib-state</i> }	Displays the FIB distribution information.
show forwarding interfaces module <i>slot</i>	Displays the FIB information for a module.
show forwarding ipv4route	Displays routes in the FIB.
show ip adjacency	Displays the adjacency table.
show ip route	Displays IPv4 routes from the unicast RIB.
show routing	Displays routes from the unicast RIB.

Additional References

For additional information related to managing unicast RIB and FIB, see the following sections:

- [Related Documents](#)

Related Documents

Related Topic	Document Title
Unicast RIB and FIB CLI commands	Cisco Nexus 3000 Series Command Reference



CHAPTER 13

Configuring Route Policy Manager

This chapter describes how to configure the Route Policy Manager on Cisco NX-OS switches.

This chapter includes the following sections:

- [Information About Route Policy Manager, on page 257](#)
- [Guidelines and Limitations for Route Policy Manager, on page 261](#)
- [Default Settings for Route Policy Manager, on page 262](#)
- [Configuring Route Policy Manager, on page 262](#)
- [Verifying the Route Policy Manager Configuration, on page 277](#)
- [Configuration Examples for Route Policy Manager, on page 278](#)
- [Related Topics, on page 278](#)
- [Additional References, on page 278](#)

Information About Route Policy Manager

Route Policy Manager supports route maps and IP prefix lists. These features are used for route redistribution. A prefix list contains one or more IPv4 network prefixes and the associated prefix length values. You can use a prefix list by itself in features such as Border Gateway Protocol (BGP) templates, route filtering, or redistribution of routes that are exchanged between routing domains.

Route maps can apply to both routes and IP packets. Route filtering and redistribution pass a route through a route map.

Prefix Lists

You can use prefix lists to permit or deny an address or range of addresses. Filtering by a prefix list involves matching the prefixes of routes or packets with the prefixes listed in the prefix list. An implicit deny is assumed if a given prefix does not match any entries in a prefix list.

You can configure multiple entries in a prefix list and permit or deny the prefixes that match the entry. Each entry has an associated sequence number that you can configure. If you do not configure a sequence number, Cisco NX-OS assigns a sequence number automatically. Cisco NX-OS evaluates prefix lists starting with the lowest sequence number. Cisco NX-OS processes the first successful match for a given prefix. Once a match occurs, Cisco NX-OS processes the permit or deny statement and does not evaluate the rest of the prefix list.



Note An empty prefix list permits all routes.

MAC Lists

You can use MAC lists to permit or deny MAC address or range of addresses. A MAC list consists of a list of MAC addresses and optional MAC masks. A MAC mask is a wild-card mask that is logically AND-ed with the MAC address when the route map matches on the MAC list entry. Filtering by a MAC list involves matching the MAC address of packets with the MAC addresses listed in the MAC list. An implicit deny is assumed if a given MAC address does not match any entries in a MAC list.

You can configure multiple entries in a MAC list and permit or deny the MAC addresses that match the entry. Each entry has an associated sequence number that you can configure. If you do not configure a sequence number, Cisco NX-OS assigns a sequence number automatically. Cisco NX-OS evaluates MAC lists starting with the lowest sequence number. Cisco NX-OS processes the first successful match for a given MAC address. Once a match occurs, Cisco NX-OS processes the permit or deny statement and does not evaluate the rest of the MAC list.

Route Maps

You can use route maps for route redistribution. Route map entries consist of a list of match and set criteria. The match criteria specify match conditions for incoming routes or packets, and the set criteria specify the action taken if the match criteria are met.

You can configure multiple entries in the same route map. These entries contain the same route map name and are differentiated by a sequence number.

You create a route map with one or more route map entries arranged by the sequence number under a unique route map name. The route map entry has the following parameters:

- Sequence number
- Permission—permit or deny
- Match criteria
- Set changes

By default, a route map processes routes or IP packets in a linear fashion, that is, starting from the lowest sequence number. You can configure the route map to process in a different order using the **continue** statement, which allows you to determine which route map entry to process next.

Match Criteria

You can use a variety of criteria to match a route or IP packet in a route map. Some criteria, such as BGP community lists, are applicable only to a specific routing protocol, while other criteria, such as the IP source or the destination address, can be used for any route or IP packet.

When Cisco NX-OS processes a route or packet through a route map, it compares the route or packet to each of the match statements configured. If the route or packet matches the configured criteria, Cisco NX-OS processes it based on the permit or deny configuration for that match entry in the route map and any set criteria configured.

The match categories and parameters are as follows:

- BGP parameters—Match based on AS numbers, AS-path, community attributes, or extended community attributes.
- Prefix lists—Match based on an address or range of addresses.
- Multicast parameters—Match based on rendezvous point, groups, or sources.
- Other parameters—Match based on IP next-hop address or packet length.

Set Changes

Once a route or packet matches an entry in a route map, the route or packet can be changed based on one or more configured set statements.

The set changes are as follows:

- BGP parameters—Change the AS-path, tag, community, extended community, dampening, local preference, origin, or weight attributes.
- Metrics—Change the route-metric, the route-tag, or the route-type.
- Other parameters—Change the forwarding address or the IP next-hop address.

Access Lists

IP access lists can match the packet to a number of IP packet fields such as the following:

- Source or destination IPv4 address
- Protocol
- Precedence
- ToS

See the [Cisco Nexus 3548 Switch NX-OS Security Configuration Guide](#) for more information on ACLs.

AS Numbers for BGP

You can configure a list of AS numbers to match against BGP peers. If a BGP peer matches an AS number in the list and matches the other BGP peer configuration, BGP creates a session. If the BGP peer does not match an AS number in the list, BGP ignores the peer. You can configure the AS numbers as a list, a range of AS numbers, or you can use an AS-path list to compare the AS numbers against a regular expression.

AS-path Lists for BGP

You can configure an AS-path list to filter inbound or outbound BGP route updates. If the route update contains an AS-path attribute that matches an entry in the AS-path list, the router processes the route based on the permit or deny condition configured. You can configure AS-path lists within a route map.

You can configure multiple AS-path entries in an AS-path list by using the same AS-path list name. The router processes the first entry that matches.

Community Lists for BGP

You can filter BGP route updates based on the BGP community attribute by using community lists in a route map. You can match the community attribute based on a community list, and you can set the community attribute using a route map.

A community list contains one or more community attributes. If you configure more than one community attribute in the same community list entry, then the BGP route must match all community attributes listed to be considered a match.

You can also configure multiple community attributes as individual entries in the community list by using the same community list name. In this case, the router processes the first community attribute that matches the BGP route, using the permit or deny configuration for that entry.

You can configure community attributes in the community list in one of the following formats:

- A named community attribute, such as **internet** or **no-export**.
- In **aa:nn** format, where the first two bytes represent the two-byte AS number and the last two bytes represent a user-defined network number.
- A regular expression.

Extended Community Lists for BGP

Extended community lists support 4-byte AS numbers. You can configure community attributes in the extended community list in one of the following formats:

- In **aa4:nn** format, where the first four bytes represent the four-byte AS number and the last two bytes represent a user-defined network number.
- A regular expression.

Cisco NX-OS supports generic-specific extended community lists, which provide similar functionality to regular community lists for four-byte AS numbers. You can configure generic-specific extended community lists with the following properties:

- Transitive—BGP propagates the community attributes across autonomous systems.
- Nontransitive—BGP removes community attributes before propagating the route to another autonomous system.

Route Redistribution and Route Maps

You can use route maps to control the redistribution of routes between routing domains. Route maps match on the attributes of the routes to redistribute only those routes that pass the match criteria. The route map can also modify the route attributes during this redistribution using the set changes.

The router matches redistributed routes against each route map entry. If there are multiple match statements, the route must pass all of the match criteria. If a route passes the match criteria defined in a route map entry, the actions defined in the entry are executed. If the route does not match the criteria, the router compares the route against subsequent route map entries. Route processing continues until a match is made or the route is processed by all entries in the route map with no match. If the router processes the route against all entries in a route map with no match, the router accepts the route (inbound route maps) or forwards the route (outbound route maps).

Guidelines and Limitations for Route Policy Manager

Route Policy Manager has the following configuration guidelines and limitations:

- Although CLI allows **set** or **match** on **route-tag**, it is not supported and will cause unintended behavior for that particular route-map sequence.
- Names in the prefix-list are case-insensitive. We recommend using unique names. Do not use the same name by modifying upper-case and lower-case characters. For example, CTCPrimaryNetworks and CtcPrimaryNetworks are two different entries.
- If no route map exists, all routes are denied.
- If no prefix list exists, all routes are permitted.
- Without any match statement in a route-map entry, the permission (permit or deny) of the route-map entry decides the result for all the routes or packets.
- If referred policies (for example, prefix lists) within a match statement of a route-map entry return either a no-match or a deny-match, Cisco NX-OS fails the match statement and processes the next route-map entry.
- When you change a route map, Cisco NX-OS holds all the changes until you exit from the route-map configuration submode. Cisco NX-OS then sends all the changes to the protocol clients to take effect.
- Cisco recommends that you do not have both IPv4 and IPv6 match statements in the same route-map sequence. If both are required, they should be specified in different sequences in the same route-map.
- Because you can use a route map before you define it, verify that all your route maps exist when you finish a configuration change.
- You can view the route-map usage for redistribution and filtering. Each individual routing protocol provides a way to display these statistics.
- When you redistribute BGP to IGP, iBGP is redistributed as well. To override this behavior, you must insert an additional deny statement into the route map.
- Route Policy Manager does not support MAC lists.
- The maximum number of characters for ACL names in the ip access-list name command is 64. However, ACL names that are associated with RPM commands (such as ip prefix-list and match ip address) accept a maximum of only 63 characters.
- BGP supports only specific **match** commands. For details, see the **match** commands table in the [Configuring Route Maps, on page 272](#) section.
- If you create an ACL named "prefix-list," it cannot be associated with a route map that is created using the match ip address command. The RPM command match ip address prefix-list makes the previous command (with the "prefix-list" ACL name) ambiguous.
- You can configure only one ACL when using the match ip address command.

Default Settings for Route Policy Manager

Table below lists the default settings for Route Policy Manager.

Table 15: Default Route Policy Manager Parameters

Parameters	Default
Route Policy Manager	Enabled

Configuring Route Policy Manager



Note If you are familiar with the Cisco IOS CLI, be aware that the Cisco NX-OS commands for this feature might differ from the Cisco IOS commands that you would use.

Configuring IP Prefix Lists

IP prefix lists match the IP packet or route against a list of prefixes and prefix lengths. You can create an IP prefix list for IPv4.

You can configure the prefix list entry to match the prefix length exactly, or to match any prefix with a length that matches the configured range of prefix lengths.

Use the **ge** and **lt** keywords to create a range of possible prefix lengths. The incoming packet or route matches the prefix list if the prefix matches and if the prefix length is greater than or equal to the **ge** keyword value (if configured) and less than or equal to the **lt** keyword value (if configured). When using the **eq** keyword, the value you set must be greater than the mask length for the prefix.

SUMMARY STEPS

1. **configure terminal**
2. (Optional) **ip prefix-list** *name* **description** *string*
3. **ip prefix-list** *name* [**seq** *number*] [{ **permit** | **deny** } *prefix* [{ **eq** *prefix-length* } | [**ge** *prefix-length*] [**le** *prefix-length*]}]
4. (Optional) **show ip prefix-list** *name*
5. (Optional) **copy running-config startup-config**

DETAILED STEPS

Procedure

	Command or Action	Purpose
Step 1	configure terminal Example: switch# configure terminal switch(config)#	Enters configuration mode.
Step 2	(Optional) ip prefix-list name description string Example: switch(config)# ip prefix-list AllowPrefix description allows engineering server	Adds an information string about the prefix list.
Step 3	ip prefix-list name [seq number] [{ permit deny } prefix { [eq prefix-length] [ge prefix-length] [le prefix-length] } Example: switch(config)# ip prefix-list AllowPrefix seq 10 permit 192.0.2.0 eq 24	Creates an IPv4 prefix list or adds a prefix to an existing prefix list. The prefix length is matched as follows: <ul style="list-style-type: none"> • eq—Matches the exact <i>prefix length</i>. This value must be greater than the mask length. • ge—Matches a prefix length that is equal to or greater than the configured <i>prefix length</i>. • le—Matches a prefix length that is equal to or less than the configured <i>prefix length</i>.
Step 4	(Optional) show ip prefix-list name Example: switch(config)# show ip prefix-list AllowPrefix	Displays information about prefix lists.
Step 5	(Optional) copy running-config startup-config Example: switch# copy running-config startup-config	Saves this configuration change.

Example

This example shows how to create an IPv4 prefix list with two entries and apply the prefix list to a BGP neighbor:

```
switch# configure terminal
switch(config)# ip prefix-list allowprefix seq 10 permit 192.0.2.0/23 eq 24
switch(config)# ip prefix-list allowprefix seq 20 permit 209.165.201.0/27 eq 28
switch(config)# router bgp 65536:20
switch(config-router)# neighbor 192.0.2.1/16 remote-as 65535:20
switch(config-router-neighbor)# address-family ipv4 unicast
switch(config-router-neighbor-af)# prefix-list allowprefix in
```

Configuring MAC Lists

You can configure a MAC list to permit or deny a range of MAC addresses.

SUMMARY STEPS

1. **configure terminal**
2. **mac-list name [seq number] { permit | deny } mac-address { mac-mask }**
3. (Optional) **show mac-list name**
4. (Optional) **show ip prefix-list name**

DETAILED STEPS

Procedure

	Command or Action	Purpose
Step 1	configure terminal Example: switch# configure terminal switch(config)#	Enters configuration mode.
Step 2	mac-list name [seq number] { permit deny } mac-address { mac-mask } Example: switch(config)# mac-list AllowMac seq 1 permit 0022.5579.a4c1 ffff.ffff.0000	Creates a MAC list or adds a MAC address to an existing MAC list. The <i>seq</i> range is from 1 to 4294967294. The <i>mac-mask</i> specifies the portion of the MAC address to match against and is in MAC address format.
Step 3	(Optional) show mac-list name Example: switch(config)# show mac-list AllowMac	Displays information about MAC lists.
Step 4	(Optional) show ip prefix-list name Example: switch(config)# show ip prefix-list AllowPrefix	Displays information about prefix lists.

Configuring AS-path Lists

You can specify an AS-path list filter on both inbound and outbound BGP routes. Each filter is an access list based on regular expressions. If the regular expression matches the representation of the AS-path attribute of the route as an ASCII string, then the permit or deny condition applies.

SUMMARY STEPS

1. **configure terminal**
2. **ip as-path access-list name { deny | permit } expression**
3. (Optional) **show ip as-path-access-list name**
4. (Optional) **show ip prefix-list name**

DETAILED STEPS

Procedure

	Command or Action	Purpose
Step 1	configure terminal Example: <pre>switch# configure terminal switch(config)#</pre>	Enters configuration mode.
Step 2	ip as-path access-list name { deny permit } expression Example: <pre>switch(config)# ip as-path access-list Allow40 permit 40</pre>	
Step 3	(Optional) show ip as-path-access-list name Example: <pre>switch(config)# show ip as-path-access-list Allow40</pre>	Displays information about as-path access lists.
Step 4	(Optional) show ip prefix-list name Example: <pre>switch(config)# show ip prefix-list AllowPrefix</pre>	Displays information about prefix lists.

Example

This example shows how to create an AS-path list with two entries and apply the AS path list to a BGP neighbor:

```
switch# configure terminal
switch(config)# ip as-path access-list AllowAS permit 64510
switch(config)# ip as-path access-list AllowAS permit 64496
switch(config)# copy running-config startup-config
switch(config)# router bgp 65536:20
switch(config-router)# neighbor 192.0.2.1/16 remote-as 65535:20
switch(config-router-neighbor)# address-family ipv4 unicast
switch(config-router-neighbor-af)# filter-list AllowAS in
```

Replacing BGP AS-path Attribute

The following procedures allow you to manipulate the BGP routing policy by modifying the BGP as-path attribute in inbound and outbound route maps.

Consider the following guidelines when replacing the BGP as-path attribute:

- This feature is applicable to only eBGP neighbors on a per address family identifier (AFI) basis. If you attempt to configure the feature on iBGP neighbors, the configuration is ignored.
- A route map with this feature can be applied to both the inbound and outbound sides of a BGP neighbor.

- This feature supports any combination of AS_SET, AS_SEQUENCE, CONFED_SET, and CONFED_SEQUENCE.
- When interacting with a BGP speaker that supports only a 2-byte AS, the 4-byte AS number is replaced by the reserved 2-byte AS number 23456.
- If a confederation identifier is configured, consider using the confederation identifier as the local ASN in the CLI when interacting with a peer that is outside the confederation. When interacting with a peer belonging to the same confederation, consider using the process ASN in the **router bgp asn** command.
- When the BGP **local-as** feature is configured, the configured local-as will be considered as local ASN in the CLI.
- For outbound route-maps, the local ASN will always be prepended to the resulting as_path from the CLI.
- A maximum of 32 AS numbers can be configured in a **set as-path** or **set as-path replace** command.
- Only one of these options can be configured under one route-map sequence: **set as-path**, **set as-path prepend**, and **set as-path replace**.
- If **remove-private-as** is configured, it will be applied before applying the new route-map commands on the outbound side.
- If **as-override** is configured, it will be applied after applying the new route-map commands on the outbound side.
- AS_PATH loop checks will execute on the original AS_PATH before the new route-map commands are applied on both inbound and outbound sides. These checks can be relaxed by using **allow-as in** on the inbound side and **disable-peer-as-check** on the outbound side.

Replacing the Complete AS-path

Use this procedure to modify the AS-path in an incoming or outgoing BGP update to a custom AS-path. You can also remove the AS-path completely.

Procedure

	Command or Action	Purpose
Step 1	configure terminal Example: <pre>switch# configure terminal switch(config)#</pre>	Enters global configuration mode.
Step 2	route-map map-name [permit deny] [seq] Example: <pre>switch(config)# route-map Testmap permit 10 switch(config-route-map)#</pre>	Creates a route map or enters route-map configuration mode for an existing route map. Use <i>seq</i> to order the entries in a route map.
Step 3	[no] set as-path { none {as-number remote-as local-as}+ } Example:	Replaces AS_PATH with a list of custom ASNs or clears the AS_PATH. The command options are: <ul style="list-style-type: none"> • <i>as-number</i>: The specified AS number.

	Command or Action	Purpose
	<pre>switch(config-route-map)# set as-path 11 local-as remote-as 13</pre>	<ul style="list-style-type: none"> • remote-as: The AS number of the BGP peer. • local-as: The local AS number. <p>The none keyword removes the AS-path completely.</p>

Example

In the following examples, these values are assumed:

- The original AS_PATH is **10 20 30 40 50 60**.
- The local-as is **100**.
- The remote-as is **200**.

This example shows how to specify a custom AS-path. This command will change the AS-path to **11 100 200 13 200 10.10 65535**.

```
switch# configure terminal
switch(config)# route-map Testmap permit 10
switch(config-route-map)# set as-path 11 local-as remote-as 13 remote-as 10.10 65535
```

This example shows how to clear the AS-path. This command will cause the AS-path to be empty.

```
switch# configure terminal
switch(config)# route-map Testmap permit 10
switch(config-route-map)# set as-path none
```

Replacing Selected AS Numbers in the AS-path

Use this procedure to replace specific AS numbers in the AS-path and replace them with custom AS numbers in an incoming or outgoing BGP update. You can also specify **private-as** as a match keyword. In this case, any instance of a private-as is matched and can be replaced or removed.

Procedure

	Command or Action	Purpose
Step 1	<p>configure terminal</p> <p>Example:</p> <pre>switch# configure terminal switch(config)#</pre>	Enters global configuration mode.
Step 2	<p>route-map map-name [permit deny] [seq]</p> <p>Example:</p> <pre>switch(config)# route-map Testmap permit 10 switch(config-route-map)#</pre>	Creates a route map or enters route-map configuration mode for an existing route map. Use <i>seq</i> to order the entries in a route map.

	Command or Action	Purpose
Step 3	<p>[no] set as-path replace {<i>asn_list</i> private-as} [with {<i>as-number</i> remote-as none}]</p> <p>Example:</p> <pre>switch(config-route-map)# set as-path replace 1, 2, private-as with remote-as</pre>	<p>If the with keyword is not specified, substitute the local-as for any instance of an ASN mentioned in the comma separated <i>asn_list</i>, or for any private-as if the private-as keyword is specified.</p> <p>If the with keyword is specified, substitute the value after the with keyword for any matched ASN, or any private-as if the private-as keyword is specified.</p> <p>The command options following the with keyword are:</p> <ul style="list-style-type: none"> • <i>as-number</i>: The matched values are replaced by the specified AS number. • remote-as: The matched values are replaced by the AS number of the BGP peer. • none: The matched values are removed from the AS-path.

Example

In the following examples, these values are assumed:

- The original AS_PATH is **1 5 2 10.10 65534 20**.
- The local-as is **100**.
- The remote-as is **200**.

This example shows how to replace two specific ASNs and a private-as with the local-as. This command will change the AS-path to **100 5 100 10.10 100 20**.

```
switch# configure terminal
switch(config)# route-map Testmap permit 10
switch(config-route-map)# set as-path replace 1, 2, private-as
```

This example shows how to replace two specific ASNs and a private-as with the neighbor's ASN (remote-as). This command will change the AS-path to **200 5 200 10.10 200 20**.

```
switch# configure terminal
switch(config)# route-map Testmap permit 10
switch(config-route-map)# set as-path replace 1, 2, private-as with remote-as
```

This example shows how to remove two specific ASNs and a private-as. This command will change the AS-path to **5 10.10 20**.

```
switch# configure terminal
switch(config)# route-map Testmap permit 10
switch(config-route-map)# set as-path replace 1, 2, private-as with none
```

Configuring Community Lists

You can use community lists to filter BGP routes based on the community attribute. The community number consists of a 4-byte value in the *aa:nn* format. The first two bytes represent the autonomous system number, and the last two bytes represent a user-defined network number.

When you configure multiple values in the same community list statement, all community values must match to satisfy the community list filter. When you configure multiple values in separate community list statements, the first list that matches a condition is processed.

Use community lists in a match statement to filter BGP routes based on the community attribute.

SUMMARY STEPS

1. **configure terminal**
- 2.
3. (Optional) show ip community-list *name*
4. (Optional) **copy running-config startup-config**

DETAILED STEPS

Procedure

	Command or Action	Purpose								
Step 1	configure terminal Example: <pre>switch# configure terminal switch(config)#</pre>	Enters configuration mode.								
Step 2	<table border="1"> <thead> <tr> <th>Option</th> <th>Description</th> </tr> </thead> <tbody> <tr> <td>Command</td> <td>Purpose</td> </tr> <tr> <td> ip community-list standard <i>list-name</i> { deny permit } [<i>community-list</i>] [internet] [local-AS] [no-advertise] [no-export] Example: <pre>switch(config)# ip community-list standard BGPCcommunity permit no-advertise 65536:20</pre> </td> <td>Creates a standard BGP community list. The <i>list-name</i> can be any case-sensitive, alphanumeric string up to 63 characters. The <i>community-list</i> can be one or more communities in the <i>aa:nn</i> format.</td> </tr> <tr> <td> ip community-list expanded <i>list-name</i> { deny permit } <i>expression</i> Example: <pre>switch(config)# ip community-list expanded</pre> </td> <td>Creates an expanded BGP community list using a regular expression.</td> </tr> </tbody> </table>	Option	Description	Command	Purpose	ip community-list standard <i>list-name</i> { deny permit } [<i>community-list</i>] [internet] [local-AS] [no-advertise] [no-export] Example: <pre>switch(config)# ip community-list standard BGPCcommunity permit no-advertise 65536:20</pre>	Creates a standard BGP community list. The <i>list-name</i> can be any case-sensitive, alphanumeric string up to 63 characters. The <i>community-list</i> can be one or more communities in the <i>aa:nn</i> format.	ip community-list expanded <i>list-name</i> { deny permit } <i>expression</i> Example: <pre>switch(config)# ip community-list expanded</pre>	Creates an expanded BGP community list using a regular expression.	
Option	Description									
Command	Purpose									
ip community-list standard <i>list-name</i> { deny permit } [<i>community-list</i>] [internet] [local-AS] [no-advertise] [no-export] Example: <pre>switch(config)# ip community-list standard BGPCcommunity permit no-advertise 65536:20</pre>	Creates a standard BGP community list. The <i>list-name</i> can be any case-sensitive, alphanumeric string up to 63 characters. The <i>community-list</i> can be one or more communities in the <i>aa:nn</i> format.									
ip community-list expanded <i>list-name</i> { deny permit } <i>expression</i> Example: <pre>switch(config)# ip community-list expanded</pre>	Creates an expanded BGP community list using a regular expression.									

	Command or Action		Purpose
	Option	Description	
	BGPComplex deny 50000:[0-9][0-9]_		
Step 3	(Optional) show ip community-list <i>name</i> Example: switch(config)# show ip community-list BGPCommunity		Displays information about community lists.
Step 4	(Optional) copy running-config startup-config Example: switch# copy running-config startup-config		Saves this configuration change.

Example

This example shows how to create a community list with two entries:

```
switch# configure terminal
switch(config)# ip community-list standard BGPCommunity permit no-advertise 65536:20
switch(config)# ip community-list standard BGPCommunity permit local-AS no-export
switch(config)# copy running-config startup-config
```

Configuring Extended Community Lists

You can use extended community lists to filter BGP routes based on the community attribute. The community number consists of a 6-byte value in the *aa4:nn* format. The first four bytes represent the autonomous system number, and the last two bytes represent a user-defined network number.

When you configure multiple values in the same extended community list statement, all extended community values must match to satisfy the extended community list filter. When you configure multiple values in separate extended community list statements, the first list that matches a condition is processed.

Use extended community lists in a match statement to filter BGP routes based on the extended community attribute.

SUMMARY STEPS

1. **configure terminal**
- 2.
3. (Optional) show ip community-list *name*
4. (Optional) **copy running-config startup-config**

DETAILED STEPS

Procedure

	Command or Action	Purpose								
Step 1	configure terminal Example: <pre>switch# configure terminal switch(config)#</pre>	Enters configuration mode.								
Step 2	<table border="1"> <thead> <tr> <th>Option</th> <th>Description</th> </tr> </thead> <tbody> <tr> <td>Command</td> <td>Purpose</td> </tr> <tr> <td> ip community-list standard <i>list-name</i> { deny permit } 4bytegeneric { transitive non-transitive } community1 [community2] Example: <pre>switch(config)# ip extcommunity-list standard BGPExtCommunity permit 4bytegeneric transitive 65536:20</pre> </td> <td>Creates a standard BGP community list. The <i>community-list</i> can be one or more extended communities in the <i>aa:nn</i> format.</td> </tr> <tr> <td> ip extcommunity-list expanded <i>list-name</i> { deny permit } <i>expression</i> Example: <pre>switch(config)# ip community-list expanded BGPComplex deny 50000:[0-9][0-9]_</pre> </td> <td>Creates an expanded BGP community list using a regular expression.</td> </tr> </tbody> </table>	Option	Description	Command	Purpose	ip community-list standard <i>list-name</i> { deny permit } 4bytegeneric { transitive non-transitive } community1 [community2] Example: <pre>switch(config)# ip extcommunity-list standard BGPExtCommunity permit 4bytegeneric transitive 65536:20</pre>	Creates a standard BGP community list. The <i>community-list</i> can be one or more extended communities in the <i>aa:nn</i> format.	ip extcommunity-list expanded <i>list-name</i> { deny permit } <i>expression</i> Example: <pre>switch(config)# ip community-list expanded BGPComplex deny 50000:[0-9][0-9]_</pre>	Creates an expanded BGP community list using a regular expression.	
	Option	Description								
	Command	Purpose								
ip community-list standard <i>list-name</i> { deny permit } 4bytegeneric { transitive non-transitive } community1 [community2] Example: <pre>switch(config)# ip extcommunity-list standard BGPExtCommunity permit 4bytegeneric transitive 65536:20</pre>	Creates a standard BGP community list. The <i>community-list</i> can be one or more extended communities in the <i>aa:nn</i> format.									
ip extcommunity-list expanded <i>list-name</i> { deny permit } <i>expression</i> Example: <pre>switch(config)# ip community-list expanded BGPComplex deny 50000:[0-9][0-9]_</pre>	Creates an expanded BGP community list using a regular expression.									
Step 3	(Optional) show ip community-list <i>name</i> Example: <pre>switch(config)# show ip community-list BGPCommunity</pre>	Displays information about community lists.								
Step 4	(Optional) copy running-config startup-config Example: <pre>switch# copy running-config startup-config</pre>	Saves this configuration change.								

Example

This example shows how to create a generic-specific extended community list:

```
switch# configure terminal
switch(config)# ip extcommunity-list standard test1 permit 4bytegeneric transitive 65536:40
65536:60
switch(config)# copy running-config startup-config
```

Configuring Route Maps

Before you begin

You can use route maps for route redistribution or route filtering. Route maps can contain multiple match criteria and multiple set criteria.

Configuring a route map for BGP triggers an automatic soft clear or refresh of BGP neighbor sessions.

SUMMARY STEPS

1. **configure terminal**
2. **configure terminal**
3. (Optional) **continue seq**
4. (Optional) **exit**
5. (Optional) **copy running-config startup-config**

DETAILED STEPS

Procedure

	Command or Action	Purpose
Step 1	configure terminal Example: switch# configure terminal switch(config)#	Enters configuration mode.
Step 2	configure terminal Example: switch# configure terminal switch(config)#	Enters configuration mode.
Step 3	(Optional) continue seq Example: switch(config-route-map)# continue 10	Determines what sequence statement to process next in the route map. Used only for filtering and redistribution.
Step 4	(Optional) exit Example: switch(config-route-map)# continue 10	Determines what sequence statement to process next in the route map. Used only for filtering and redistribution.
Step 5	(Optional) copy running-config startup-config Example:	Saves this configuration change.

Command or Action	Purpose
switch# copy running-config startup-config	

Example

You can configure the following optional match parameters for route maps in route-map configuration mode:



Note The **default-information originate** command ignores **match** statements in the optional route map.

Command	Purpose
<p>match as-path <i>name</i> [<i>name...</i>]</p> <p>Example:</p> <pre>switch(config-route-map)# match as-path Allow40</pre>	Matches against one or more AS-path lists. Create the AS-path list with the ip as-path access-list command.
<p>match as-number { <i>number</i> [,<i>number...</i>] as-path-list <i>name</i> [<i>name...</i>] }</p> <p>Example:</p> <pre>switch(config-route-map)# match as-number 33,50-60</pre>	Matches against one or more AS numbers or AS-path lists. Create the AS-path list with the ip as-path access-list command. The number range is from 1 to 65535. The AS-path list name can be any case-sensitive, alphanumeric string up to 63 characters.
<p>match community <i>name</i> [<i>name...</i>] [exact-match]</p> <p>Example:</p> <pre>switch(config-route-map)# match community BGPCommunity</pre>	Matches against one or more community lists. Create the community list with the ip community-list command.
<p>match extcommunity <i>name</i> [<i>name...</i>] [exact-match]</p> <p>Example:</p> <pre>switch(config-route-map)# match extcommunity BGPextCommunity</pre>	Matches against one or more extended community lists. Create the community list with the ip extcommunity-list command.
<p>match interface <i>interface-type number</i> [<i>interface-type number...</i>]</p> <p>Example:</p> <pre>switch(config-route-map)# match interface e 1/2</pre>	Matches any routes that have their next hop out one of the configured interfaces. Use ? to find a list of supported interface types.
<p>match ip address prefix-list <i>name</i> [<i>name...</i>]</p> <p>Example:</p> <pre>switch(config-route-map)# match ip address prefix-list AllowPrefix</pre>	Matches against one or more IPv4 prefix lists. Use the ip prefix-list command to create the prefix list.

Command	Purpose
<p>match ip next-hop prefix-list <i>name</i> [<i>name ...</i>]</p> <p>Example:</p> <pre>switch(config-route-map)# match ip next-hop prefix-list AllowPrefix</pre>	Matches the IPv4 next-hop address of a route to one or more IP prefix lists. Use the <i>ip prefix-list</i> command to create the prefix list.
<p>match ip route-source prefix-list <i>name</i> [<i>name ...</i>]</p> <p>Example:</p> <pre>switch(config-route-map)# match ip route-source prefix-list AllowPrefix</pre>	Matches the IPv4 route source address of a route to one or more IP prefix lists. Use the ip prefix-list command to create the prefix list.
<p>match mac-list <i>name</i> [<i>name...</i>]</p> <p>Example:</p> <pre>switch(config-route-map)# match mac-list AllowMAC</pre>	Matches against one or more MAC lists. Use the mac-list command to create the MAC list.
<p>match metric <i>value</i> [<i>+deviation</i>] [<i>value..</i>]</p> <p>Example:</p> <pre>switch(config-route-map)# match mac-list AllowMAC</pre>	Matches the route metric against one or more metric values or value ranges. Use + deviation argument to set a metric range. The route map matches any route metric that falls the range: <i>value - deviation</i> to <i>value + deviation</i> .
<p>match route-type <i>route-type</i></p> <p>Example:</p> <pre>switch(config-route-map)# match route-type level 1 level 2</pre>	Matches against a type of route. The <i>route-type</i> can be one or more of the following: <ul style="list-style-type: none"> • external • internal • level-1 • level-2 • local • nssa-external • type-1 • type-2
<p>match tag <i>tagid</i> [<i>tagid...</i>]</p> <p>Example:</p> <pre>switch(config-route-map)# match tag 2</pre>	Matches a route against one or more tags for filtering or redistribution.
<p>match vlan <i>vlan-id</i> [<i>vlan-range</i>]</p> <p>Example:</p> <pre>switch(config-route-map)# match vlan 3, 5-10</pre>	Matches against a VLAN.

You can configure the following optional set parameters for route maps in route-map configuration mode:

Command	Purpose
<p>set as-path { tag prepend { last-as number as-1 [as-2...]}}</p> <p>Example:</p> <pre>switch(config-route-map)# set as-path prepend 10 100 110</pre>	<p>Modifies an AS-path attribute for a BGP route. You can prepend the configured <i>number</i> of last AS numbers or a string of particular AS-path values (<i>as-1 as-2...as-n</i>).</p>
<p>set comm-list name delete</p> <p>Example:</p> <pre>switch(config-route-map)# set comm-list BGPCommunity delete</pre>	<p>Removes communities from the community attribute of an inbound or outbound BGP route update. Use the ip community-list command to create the community list.</p>
<p>set community { none additive local-AS no-advertise no-export community-1 [community-2...]}</p> <p>Example:</p> <pre>switch(config-route-map)# set community local-AS</pre>	<p>Sets the community attribute for a BGP route update.</p> <p>Note When you use both the set community and set comm-list delete commands in the same sequence of a route map attribute, the deletion operation is performed before the set operation.</p> <p>Note Use the send-community command in BGP neighbor address family configuration mode to propagate BGP community attributes to BGP peers.</p>
<p>set dampening halflife reuse suppress duration</p> <p>Example:</p> <pre>switch(config-route-map)# set dampening 30 1500 10000 120</pre>	<p>Sets the following BGP route dampening parameters:</p> <ul style="list-style-type: none"> • <i>halflife</i> —The range is from 1 to 45 minutes. The default is 15. • <i>reuse</i> —The range is from is 1 to 20000 seconds. The default is 750. • <i>suppress</i> —The range is from is 1 to 20000. The default is 2000. • <i>duration</i> —The range is from is 1 to 255 minutes. The default is 60.
<p>set extcomm-list name delete</p> <p>Example:</p> <pre>switch(config-route-map)# set extcomm-list BGPextCommunity delete</pre>	<p>Removes communities from the extended community attribute of an inbound or outbound BGP route update. Use the ip extcommunity-list command to create the extended community list.</p>

Command	Purpose
<p>set extcommunity generic { transitive nontransitive } { none additive } <i>community-1</i> [<i>community-2...</i>]</p> <p>Example:</p> <pre>switch(config-route-map)# set extcommunity generic transitive 1.0:30</pre>	<p>Sets the extended community attribute for a BGP route update.</p> <p>Note When you use both the set extcommunity and set extcomm-list delete commands in the same sequence of a route map attribute, the deletion operation is performed before the set operation.</p> <p>Note Use the send-community command in BGP neighbor address family configuration mode to propagate BGP extended community attributes to BGP peers.</p>
<p>set forwarding-address</p> <p>Example:</p> <pre>switch(config-route-map)# set forwarding-address</pre>	<p>Sets the forwarding address for OSPF.</p>
<p>set level { backbone level-1 level-1-2 level-2 }</p> <p>Example:</p> <pre>switch(config-route-map)# set level backbone</pre>	<p>Sets what area to import routes to for IS-IS. The options for IS-IS are level-1, level-1-2, or level-2. The default is level-1.</p>
<p>set local-preference <i>value</i></p> <p>Example:</p> <pre>switch(config-route-map)# set local-preference 4000</pre>	<p>Sets the BGP local preference value. The range is from 0 to 4294967295.</p>
<p>set metric [+ -] <i>bandwidth-metric</i></p> <p>Example :</p> <pre>switch(config-route-map)# set metric +100</pre>	<p>Adds or subtracts from the existing metric value. The metric is in Kb/s. The range is from 0 to 4294967295.</p>
<p>set metric <i>bandwidth</i> [<i>delay</i> <i>reliability</i> <i>load</i> <i>mtu</i>]</p> <p>Example :</p> <pre>switch(config-route-map)# set metric 33 44 100 200 1500</pre>	<p>Sets the route metric values.</p> <p>Metrics are as follows:</p> <ul style="list-style-type: none"> • <i>metric0</i> —Bandwidth in Kb/s. The range is from 0 to 4294967295. • <i>metric1</i> —Delay in 10-microsecond units. • <i>metric2</i> —Reliability. The range is from 0 to 255 (100 percent reliable). • <i>metric3</i> —Loading. The range is from 1 to 200 (100 percent loaded). • <i>metric4</i> —MTU of the path. The range is from 1 to 4294967295.

Command	Purpose
set metric-type { external internal type-1 type-2 } Example: <pre>switch(config-route-map)# set metric-type internal</pre>	Sets the metric type for the destination routing protocol. The options are as follows: external—IS-IS external metric internal— IGP metric as the MED for BGP type-1—OSPF external type 1 metric type-2—OSPF external type 2 metric
set origin { egp <i>as-number</i> igp incomplete } Example: <pre>switch(config-route-map)# set origin incomplete</pre>	Sets the BGP origin attribute. The EGP <i>as-number</i> range is from 0 to 65535.
set tag <i>name</i> Example: <pre>switch(config-route-map)# set tag 33</pre>	Sets the tag value for the destination routing protocol. The <i>name</i> parameter is an unsigned integer.
set weight <i>count</i> Example: <pre>switch(config-route-map)# set weight 33</pre>	Sets the weight for the BGP route. The range is from 0 to 65535.

The **set metric-type internal** command affects an outgoing policy and an eBGP neighbor only. If you configure both the **metric** and **metric-type internal** commands in the same BGP peer outgoing policy, then Cisco NX-OS ignores the **metric-type internal** command.

Verifying the Route Policy Manager Configuration

To display the route policy manager configuration information, perform one of the following tasks:

Command	Purpose
show ip community-list [<i>name</i>]	Displays information about a community list.
show ip ext community-list [<i>name</i>]	Displays information about an extended community list.
show [ip] prefix-list [<i>name</i>]	Displays information about an IPv4 prefix list.
show route-map [<i>name</i>]	Displays information about a route map.

Configuration Examples for Route Policy Manager

This example shows how to use an address family to configure Route Policy Manager so that any unicast and multicast routes from neighbor 172.16.0.1 are accepted if they match prefix-list AllowPrefix:

```
router bgp 64496

neighbor 172.16.0.1 remote-as 64497
  address-family ipv4 unicast
    route-map filterBGP in

route-map filterBGP
  match ip address prefix-list AllowPrefix

ip prefix-list AllowPrefix 10 permit 192.0.2.0/24
ip prefix-list AllowPrefix 20 permit 172.16.201.0/27
```

Related Topics

The following topics can give more information on Route Policy Manager:

- [Configuring Basic BGP](#)

Additional References

For additional information related to implementing IP, see the following sections:

- [Related Documents](#)
- [Standards](#)

Related Documents

Related Topic	Document Title
Route Policy Manager CLI commands	Cisco Nexus 3000 Series Command Reference

Standards

Standards	Title
No new or modified standards are supported by this feature, and support for existing standards has not been modified by this feature.	—



CHAPTER 14

Configuring Bidirectional Forwarding Detection

This chapter describes how to configure Bidirectional Forwarding Detection (BFD).

This chapter includes the following sections:

- [Information About BFD, on page 279](#)
- [Prerequisites for BFD, on page 281](#)
- [Guidelines and Limitations, on page 281](#)
- [Default Settings, on page 283](#)
- [Configuring BFD, on page 283](#)
- [Verifying the BFD Configuration, on page 296](#)
- [Monitoring BFD, on page 297](#)

Information About BFD

BFD is a detection protocol designed to provide fast forwarding-path failure detection times for media types, encapsulations, topologies, and routing protocols. You can use BFD to detect forwarding path failures at a uniform rate, rather than the variable rates for different protocol hello mechanisms. BFD makes network profiling and planning easier and reconvergence time consistent and predictable.

BFD provides subsecond failure detection between two adjacent devices.

Asynchronous Mode

Cisco NX-OS supports the BFD asynchronous mode, which sends BFD control packets between two adjacent devices to activate and maintain BFD neighbor sessions between the devices. You configure BFD on both devices (or BFD neighbors). Once BFD has been enabled on the appropriate protocols, Cisco NX-OS creates a BFD session, negotiates BFD session parameters, and begins to send BFD control packets to each BFD neighbor at the negotiated interval. The BFD session parameters include the following:

- **Desired minimum transmit interval**—The interval at which this device wants to send BFD hello messages.
- **Required minimum receive interval**—The minimum interval at which this device can accept BFD hello messages from another BFD device.
- **Detect multiplier**—The number of missing BFD hello messages from another BFD device before this local device detects a fault in the forwarding path.

BFD Detection of Failures

Once a BFD session has been established and timer negotiations are complete, BFD neighbors send BFD control packets that act in the same manner as an IGP hello protocol to detect liveness, except at a more accelerated rate. BFD detects a failure, but the protocol must take action to bypass a failed peer.

BFD sends a failure detection notice to the BFD-enabled protocols when it detects a failure in the forwarding path. The local device can then initiate the protocol recalculation process and reduce the overall network convergence time.

When a failure occurs in the network, the following occurs:

1. The BFD neighbor session with the BFD neighbor router is torn down.
2. BFD notifies the local BFD process that the BFD neighbor is no longer reachable.
3. The local BFD process tears down the BFD neighbor relationship.
4. If an alternative path is available, the routers immediately start converging on it.



Note The BFD failure detection occurs in less than a second.

BFD Echo Function

The BFD echo function sends echo packets from the forwarding engine to the remote BFD neighbor. The BFD neighbor forwards the echo packet back along the same path in order to perform detection; the BFD neighbor does not participate in the actual forwarding of the echo packets. The echo function and the forwarding engine are responsible for the detection process. BFD can use the slow timer to slow down the asynchronous session when the echo function is enabled and reduce the number of BFD control packets that are sent between two BFD neighbors. Also, the forwarding engine tests the forwarding path on the remote (neighbor) system without involving the remote system, so there is less interpacket delay variability and faster failure detection times.

The echo function is asymmetrical when both BFD neighbors are running echo function.

Security

Cisco NX-OS uses the packet Time to Live (TTL) value to verify that the BFD packets came from an adjacent BFD peer. For all asynchronous and echo request packets, the BFD neighbor sets the TTL value to 255 and the local BFD process verifies the TTL value as 255 before processing the incoming packet. For the echo response packet, BFD sets the TTL value to 254.

Virtualization Support

BFD supports virtual routing and forwarding instances (VRFs).

Prerequisites for BFD

BFD has the following prerequisites:

- You must enable the BFD feature (see the [Enabling the BFD Feature](#) section).
- For any client protocols that you want to enable BFD on, you enable BFD in that client protocol.
- Disable Internet Control Message Protocol (ICMP) redirect messages on a BFD-enabled interfaces.
- See other detailed prerequisites that are listed with the configuration tasks.
- Beginning with Cisco NX-OS Release 6.0(2)A4(1), BFD for BGP and PIM are supported.

Guidelines and Limitations

BFD has the following configuration guidelines and limitations:

- BFD supports BFD version 1.
- BFD supports IPv4, BGPv4, PIM and static routes.
- BFD supports single-hop BFD.
- BFD for BGP supports single-hop eBGP and iBGP with an update source.
- BFD supports the following Layer 3 interfaces—physical interfaces, port channels, subinterfaces, and VLAN interfaces (SVI).
- BFD does not support authentication for BFD or per-link BFD sessions on a port channel.
- BFD depends on a Layer 3 adjacency information to discover topology changes, including Layer 2 topology changes. A BFD session on a VLAN interface (SVI) may not be up after the convergence of the Layer 2 topology if there is no Layer 3 adjacency information available.
- Port channel configuration limitations:
 - For Layer 3 port channels used by BFD, you must enable the Link Aggregation Control Protocol (LACP) on the port channel.
 - For Layer 2 port channels used by SVI sessions, you must enable LACP on the port channel.
- SVI limitations:
 - An ASIC reset causes traffic disruption for other ports and it can cause the SVI sessions on the other ports to flap. For example, if the carrier interface is a virtual port channel (vPC), BFD is not supported over the SVI interface and it could cause a trigger for an ASIC reset. When a BFD session is over SVI using virtual port channel (vPC) Peer-Link, the BFD echo function is not supported. You must disable the BFD echo function for all sessions over SVI between vPC peer nodes.

An SVI on the Cisco Nexus series switches should not be configured to establish a BFD neighbor adjacency with a device connected to it via a vPC. This is because the BFD keepalives from the neighbor, if sent over the vPC member link connected to the vPC peer-switch, do not reach this SVI causing the BFD adjacency to fail.

- When you change the topology (for example, add or delete a link into a VLAN, delete a member from a Layer 2 port channel, and so on), the SVI session could be affected. It may go down first and then come up after the topology discovery is finished.
- BFD over FEX HIF interfaces is not supported.
- When a BFD session is over SVI using virtual port-channel (vPC) Peer-Link (either BCM or GEM based ports), the BFD echo function is not supported. You must disable the BFD echo function for all sessions over SVI between vPC peer nodes using the `no bfd echo` command at the SVI configuration level.



Tip If you do not want the SVI sessions to flap and you need to change the topology, you can disable the BFD feature before making the changes and reenables BFD after the changes have been made. You can also configure the BFD timer to be a large value (for example, 5 seconds), and change it back to a fast timer after the above events complete.

- Cisco NX-OS does not distribute the BFD operation to compatible modules to offload the CPU for BFD packet processing.
- BFD does not support stateless restarts and in-service software upgrades (ISSUs).
- If you want to enable BFD for a peer reachable through a port channel, you must configure LACP on the port channel.
- Cisco Nexus 3548 cannot be an intermediate switch to forward BFD echo packets.
- Port channel configuration notes:
 - When the BFD per-link mode is configured, the BFD echo function is not supported. You must disable the BFD echo function using the `no bfd echo` command before configuring the `bfd per-link` command.
 - Before configuring BFD per-link, make sure there is no BFD session running on the port-channel. If there is any BFD session running already, remove it and then proceed with `bfd per-link` configuration.
 - Configuring BFD per-link with link-local is not supported.
 - The BFD per-link is supported on Cisco Nexus 3548 Series platform switches.
 - Beginning with Cisco NX-OS Release 9.3(7), BFD is supported on unnumbered interfaces.



Note BFD over Unnumbered Switched Virtual Interfaces (SVIs) are not supported.

Downgrade compatibility for BFD on unnumbered interface support cannot be verified using `show incompatibility nxos bootflash:filename` command. The compatibility will be checked during `install all` command.

Default Settings

Table below lists the default settings for BFD parameters.

Table 16: Default BFD Parameters

Parameters	Default
BFD feature	Disabled
Required minimum receive interval	250 milliseconds
Desired minimum transmit interval	250 milliseconds
Detect multiplier	3
Echo function	Enabled
Mode	Asynchronous
Port channel	Logical mode (one session per source-destination pair address)
Slow timer	2000 milliseconds
Subinterface optimization	Disabled

Configuring BFD

This section includes the following topics:

Configuration Hierarchy

You can configure BFD at the global level, VRF level, at the interface or port channel level, or at the subinterface level (for physical interfaces and port channels). The VRF configuration overrides global configuration. The interface or port channel configuration overrides VRF or global configuration. On supported interfaces, the subinterface-level configuration overrides the interface or port channel configuration unless subinterface optimization is enabled. See the [Optimizing BFD on Subinterfaces](#) section for more information.

For physical ports that are members of a port channel, the member port inherits the primary port channel BFD configuration. The member port subinterfaces can override the primary port channel BFD configuration, unless subinterface optimization is enabled.

Task Flow for Configuring BFD

Follow these steps to configure BFD:

Procedure

-
- Step 1** [Enabling the BFD Feature.](#)
- Step 2** [Configuring Global BFD Parameters](#) or [Configuring BFD on an Interface.](#)
- Step 3** [Configuring BFD on BGP.](#)
-

Enabling the BFD Feature

You must enable the BFD feature before you can configure BFD on an interface and protocol.

SUMMARY STEPS

1. **configure terminal**
2. **feature bfd**
3. (Optional) **copy running-config startup-config**

DETAILED STEPS**Procedure**

	Command or Action	Purpose
Step 1	configure terminal Example: <pre>switch# configure terminal switch(config)#</pre>	Enters global configuration mode.
Step 2	feature bfd Example: <pre>switch(config)# feature bfd</pre>	Enables the BFD feature.
Step 3	(Optional) copy running-config startup-config Example: <pre>switch(config)# copy running-config startup-config</pre>	Saves this configuration change.

Configuring Global BFD Parameters

You can configure the BFD session parameters for all BFD sessions on the device. The BFD session parameters are negotiated between the BFD peers in a three-way handshake.

See the [Configuring BFD on an Interface](#) section to override these global session parameters on an interface.

Before you begin

Enable the BFD feature. See the [Enabling the BFD Feature](#) section.

SUMMARY STEPS

1. **configure terminal**
2. **bfd interval** *mintx min_rx msec multiplier value*
3. **bfd slow-timer** [*interval*]
4. **exit**
5. (Optional) **show running-config bfd**
6. (Optional) **copy running-config startup-config**

DETAILED STEPS**Procedure**

	Command or Action	Purpose
Step 1	configure terminal Example: <pre>switch# configure terminal switch(config)#</pre>	Enters global configuration mode.
Step 2	bfd interval <i>mintx min_rx msec multiplier value</i> Example: <pre>switch(config)# bfd interval 250 min_rx 250 multiplier 3</pre>	Configures the BFD session parameters for all BFD sessions on the device. You can override these values by configuring the BFD session parameters on an interface. The <i>mintx</i> and <i>msec</i> range is from 250 to 999 milliseconds and the default is 250. The multiplier range is from 3 to 50. The multiplier default is 3. To return to the default settings, use the no bfd interval command.
Step 3	bfd slow-timer [<i>interval</i>] Example: <pre>switch(config)# bfd slow-timer 2000</pre>	Configures the slow timer. This value determines how fast BFD starts up a new session and is used to slow down the asynchronous sessions when the BFD echo function is enabled. The range is from 1000 to 30000 milliseconds. The default is 2000. To return to the default settings, use the no bfd slow-timer command.
Step 4	exit Example: <pre>switch(config)# exit switch#</pre>	Returns to EXEC mode.
Step 5	(Optional) show running-config bfd Example: <pre>switch# show running-config bfd</pre>	Displays the BFD running configuration.

	Command or Action	Purpose
Step 6	(Optional) copy running-config startup-config Example: switch# copy running-config startup-config	Saves this configuration change.

Configuring BFD on an Interface

Enable the BFD feature. See the [Enabling the BFD Feature](#) section.

Before you begin

You can configure the BFD session parameters for all BFD sessions on an interface. The BFD session parameters are negotiated between the BFD peers in a three-way handshake.

This configuration overrides the global session parameters for the configured interface.

SUMMARY STEPS

1. **configure terminal**
2. **interface *int-if***
3. **bfd interval *mintx* min_rx *msec* multiplier *value***
4. **exit**
5. **exit**
6. (Optional) **show running-config bfd**
7. (Optional) **copy running-config startup-config**

DETAILED STEPS

Procedure

	Command or Action	Purpose
Step 1	configure terminal Example: switch# configure terminal switch(config)#	Enters global configuration mode.
Step 2	interface <i>int-if</i> Example: switch(config)# interface ethernet 2/1 switch(config-if)#	Enters interface configuration mode. Use the ? keyword to display the supported interfaces.
Step 3	bfd interval <i>mintx</i> min_rx <i>msec</i> multiplier <i>value</i> Example: switch(config-if)# bfd interval 250 min_rx 250 multiplier 3	Configures the BFD session parameters for all BFD sessions on the interface. This command overrides the global BFD session parameters. The <i>mintx</i> and <i>msec</i> range is from 250 to 999 milliseconds and the default is 250. The multiplier range is from 3 to 50. The multiplier default is 3.

	Command or Action	Purpose
		To return to the default settings, use the no bfd interval command.
Step 4	exit Example: <pre>switch(config-if)# exit switch (config)#</pre>	Exits interface configuration mode.
Step 5	exit Example: <pre>switch (config)# exit switch#</pre>	Exits configuration mode and returns to EXEC mode.
Step 6	(Optional) show running-config bfd Example: <pre>switch# show running-config bfd</pre>	Displays the BFD running configuration.
Step 7	(Optional) copy running-config startup-config Example: <pre>switch# copy running-config startup-config</pre>	Saves this configuration change.

Configuring BFD on a Port Channel

You can configure the BFD session parameters for all BFD sessions on a port channel. For example, if the BFD session for one link on a port channel is up, BFD informs client protocols, such as BGP, that the port channel is up. The BFD session parameters are negotiated between the BFD peers in a three-way handshake.

This configuration overrides the global session parameters for the configured port channel. The member ports of the port channel inherit the port channel BFD session parameters, unless you configure subinterface-level BFD parameters on a member port. In that case, the member port subinterface uses the subinterface BFD configuration if subinterface optimization is not enabled. See the [Optimizing BFD on Subinterfaces](#) section for more information.

Before you begin

Ensure that you enable LACP on the port channel before you enable BFD.

Enable the BFD feature. See the [Enabling the BFD Feature](#) section.

SUMMARY STEPS

1. **configure terminal**
2. **interface port-channel** *number*
3. **bfd per-link**
4. (Optional) **bfd interval** *mintx min_rx msec multiplier value*
5. **exit**
6. **exit**
7. (Optional) **show running-config bfd**

8. (Optional) copy running-config startup-config

DETAILED STEPS

Procedure

	Command or Action	Purpose
Step 1	configure terminal Example: switch# configure terminal switch(config)#	Enters global configuration mode.
Step 2	interface port-channel <i>number</i> Example: switch(config)# interface port-channel 2 switch(config-if)#	Enters port channel configuration mode. Use the ? keyword to display the supported number range.
Step 3	bfd per-link Example: switch(config-if)# bfd per-link	Configures the BFD sessions for each link in the port channel.
Step 4	(Optional) bfd interval <i>mintx min_rx msec multiplier value</i> Example: switch(config-if)# bfd interval 250 min_rx 250 multiplier 3	Configures the BFD session parameters for all BFD sessions on the interface. This command overrides the global BFD session parameters. The <i>mintx</i> and <i>msec</i> range is from 250 to 999 milliseconds and the default is 250. The multiplier range is from 3 to 50. The multiplier default is 3. To return to the default settings, use the no bfd interval command.
Step 5	exit Example: switch(config-if)# exit switch (config)#	Exits interface configuration mode.
Step 6	exit Example: switch (config)# exit switch#	Exits configuration mode and returns to EXEC mode.
Step 7	(Optional) show running-config bfd Example: switch# show running-config bfd	Displays the BFD running configuration.
Step 8	(Optional) copy running-config startup-config Example: switch# copy running-config startup-config	Saves this configuration change.

Configuring the BFD Echo Function

You can configure the BFD echo function on one or both ends of a BFD-monitored link. The echo function slows down the required minimum receive interval, based on the configured slow timer. The RequiredMinEchoRx BFD session parameter is set to zero if the echo function is disabled. The slow timer becomes the required minimum receive interval if the echo function is enabled.

Before you begin

Enable the BFD feature. See the [Enabling the BFD Feature](#) section.

Configure the BFD session parameters. See the [Configuring Global BFD Parameters](#) section or the [Configuring BFD on an Interface](#) section.

Ensure that Internet Control Message Protocol (ICMP) redirect messages are disabled on BFD-enabled interfaces. Use the **no ip redirects** command on the interface.

SUMMARY STEPS

1. **configure terminal**
2. **bfd slow-timer** *echo-interval*
3. **interface** *int-if*
4. **bfd echo**
5. **exit**
6. **exit**
7. (Optional) **show running-config bfd**
8. (Optional) **copy running-config startup-config**

DETAILED STEPS

Procedure

	Command or Action	Purpose
Step 1	configure terminal Example: <pre>switch# configure terminal switch(config)#</pre>	Enters global configuration mode.
Step 2	bfd slow-timer <i>echo-interval</i> Example: <pre>switch(config)# bfd slow-timer 2000</pre>	Configures the slow timer used in the echo function. This value determines how fast BFD starts up a new session and is used to slow down the asynchronous sessions when the BFD echo function is enabled. This value overwrites the required minimum receive interval when the echo function is enabled. The range is from 1000 to 30000 milliseconds. The default is 2000. To return to the default settings, use the <code>no bfd slow-timer</code> command.

	Command or Action	Purpose
Step 3	interface <i>int-if</i> Example: switch(config)# interface ethernet 2/1 switch(config-if)#	Enters interface configuration mode. Use the ? keyword to display the supported interfaces.
Step 4	bfd echo Example: switch(config-if)# bfd echo	Enables the echo function. The default is enabled. To disable the echo function, use the no bfd echo command.
Step 5	exit Example: switch(config-if)# exit switch (config)#	Exits interface configuration mode.
Step 6	exit Example: switch (config)# exit switch#	Exits configuration mode and returns to EXEC mode.
Step 7	(Optional) show running-config bfd Example: switch# show running-config bfd	Displays the BFD running configuration.
Step 8	(Optional) copy running-config startup-config Example: switch# copy running-config startup-config	Saves this configuration change.

Optimizing BFD on Subinterfaces

You can optimize BFD on subinterfaces. BFD creates sessions for all configured subinterfaces. BFD sets the subinterface with the lowest configured VLAN ID as the primary subinterface and that subinterface uses the BFD session parameters of the parent interface. The remaining subinterfaces use the slow timer. If the optimized subinterface session detects an error, BFD marks all subinterfaces on that physical interface as down.

Before you begin

Enable the BFD feature. See the [Enabling the BFD Feature](#) section.

Configure the BFD session parameters. See the [Configuring Global BFD Parameters](#) section or the [Configuring BFD on an Interface](#) section.

Ensure that these subinterfaces connect to another Cisco NX-OS device. This feature is supported on Cisco NX-OS only.

SUMMARY STEPS

1. **configure terminal**

2. **interface** *int-if*
3. **bfd optimize subinterface**
4. **exit**
5. **exit**
6. (Optional) **show running-config bfd**
7. (Optional) **copy running-config startup-config**

DETAILED STEPS

Procedure

	Command or Action	Purpose
Step 1	configure terminal Example: <pre>switch# configure terminal switch(config)#</pre>	Enters global configuration mode.
Step 2	interface <i>int-if</i> Example: <pre>switch(config)# interface ethernet 2/1 switch(config-if)#</pre>	Enters interface configuration mode. Use the ? keyword to display the supported interfaces.
Step 3	bfd optimize subinterface Example: <pre>switch(config-if)# bfd optimize subinterface</pre>	Optimizes subinterfaces on a BFD-enabled interface. The default is disabled. To disable optimized subinterfaces, use the no bfd optimize subinterfaces command.
Step 4	exit Example: <pre>switch(config-if)# exit switch (config)#</pre>	Exits interface configuration mode.
Step 5	exit Example: <pre>switch (config)# exit switch#</pre>	Exits configuration mode and returns to EXEC mode.
Step 6	(Optional) show running-config bfd Example: <pre>switch# show running-config bfd</pre>	Displays the BFD running configuration.
Step 7	(Optional) copy running-config startup-config Example: <pre>switch# copy running-config startup-config</pre>	Saves this configuration change.

Configuring BFD on BGP

You can configure BFD for the Border Gateway Protocol (BGP).

Before you begin

Enable the BFD feature. See the [Enabling the BFD Feature](#) section.

Configure the BFD session parameters. See the [Configuring Global BFD Parameters](#) section or the [Configuring BFD on an Interface](#) section.

SUMMARY STEPS

1. **configure terminal**
2. **router bgp *as-number***
3. **neighbor { *ip-address* } remote-as *as-number***
4. **bfd**
5. (Optional) **show running-config bfd**
6. (Optional) **copy running-config startup-config**

DETAILED STEPS

Procedure

	Command or Action	Purpose
Step 1	configure terminal Example: switch# configure terminal switch(config)#	Enters global configuration mode.
Step 2	router bgp <i>as-number</i> Example: switch(config)# router bgp 64496 switch(config-router)#	Enables BGP and assigns the AS number to the local BGP speaker. The AS number can be a 16-bit integer or a 32-bit integer in the form of a higher 16-bit decimal number and a lower 16-bit decimal number in xx.xx format.
Step 3	neighbor { <i>ip-address</i> } remote-as <i>as-number</i> Example: switch(config-router)# neighbor 209.165.201.1 remote-as 64497 switch(config-router-neighbor)#	Configures the IPv4 and AS number for a remote BGP peer. The <i>ip-address</i> format is x.x.x.x.
Step 4	bfd Example: switch(config-router-neighbor)# bfd	Enables BFD for this BGP peer.
Step 5	(Optional) show running-config bfd Example: switch# show running-config bfd	Displays the BFD running configuration.

	Command or Action	Purpose
Step 6	(Optional) copy running-config startup-config Example: switch# copy running-config startup-config	Saves this configuration change.

Configuring BFD on PIM

You can configure BFD for the Protocol Independent Multicast (PIM) protocol.

Before you begin

Enable the BFD feature. See the [Enabling the BFD Feature](#) section.

Enable the PIM feature. See the Cisco Nexus 3548 Switch NX-OS Multicast Routing Configuration Guide for more information.

SUMMARY STEPS

1. **configure terminal**
2. **ip pim bfd**
3. **interface** *type slot/port*
4. (Optional) **ip pim bfd-instance** [**disable**]
5. (Optional) **show running-config pim**
6. (Optional) **copy running-config startup-config**

DETAILED STEPS

Procedure

	Command or Action	Purpose
Step 1	configure terminal Example: switch# configure terminal switch(config)#	Enters global configuration mode.
Step 2	ip pim bfd Example: switch(config)# ip pim bfd	Enables BFD for PIM.
Step 3	interface <i>type slot/port</i> Example: switch(config)# interface ethernet 2/1 switch(config-if)#	Enters interface configuration mode. Use the ? keyword to display the supported interfaces.
Step 4	(Optional) ip pim bfd-instance [disable] Example:	Enables or disables BFD on a PIM interface. The default is disabled.

	Command or Action	Purpose
	<code>switch(config-if)# ip pim bfd-instance</code>	
Step 5	(Optional) show running-config pim Example: <code>switch(config)# show running-config pim</code>	Displays the PIM running configuration.
Step 6	(Optional) copy running-config startup-config Example: <code>switch# copy running-config startup-config</code>	Saves this configuration change.

Configuring BFD on OSPFv2

You can configure BFD for the Open Shortest Path First Protocol (OSPFv2).

Before you begin

Enable the BFD feature.

Configure the BFD session parameters, globally or for a specific interface.

Enable the OSPFv2 feature.

SUMMARY STEPS

1. **configure terminal**
2. **router ospf** *process-id*
3. **bfd**
4. **interface** *int-if*
5. (Optional) **[no] ip ospf bfd disable**
6. (Optional) **show running-config ospf**
7. (Optional) **copy running-config startup-config**

DETAILED STEPS

Procedure

	Command or Action	Purpose
Step 1	configure terminal Example: <code>switch# configure terminal</code> <code>switch(config)#</code>	Enters global configuration mode.
Step 2	router ospf <i>process-id</i> Example: <code>switch(config)# router ospf 64496</code> <code>switch(config-router)#</code>	Creates a new OSPFv2 process with a configured id.

	Command or Action	Purpose
Step 3	bfd Example: switch(config-router)# bfd	Enables BFD for this OSPFv2 peer. The default value is disabled.
Step 4	interface int-if Example: switch(config-router)# interface ethernet 1/2 switch (config-if)#	Enters interface configuration mode. Use the ? keyword to display the supported interfaces.
Step 5	(Optional) [no] ip ospf bfd disable Example: switch(config-if)# ip ospf bfd disable	Disables BFD on a OSPFv2 interface. The default value is enabled.
Step 6	(Optional) show running-config ospf Example: switch(config)# show running-config ospf	Displays the OSPFv2 running configuration.
Step 7	(Optional) copy running-config startup-config Example: switch# copy running-config startup-config	Saves this configuration change.

Configuring BFD for Static Routes

You can configure BFD for static routes on an interface. You can optionally configure BFD on a static route within a virtual routing and forwarding (VRF) instance.

Before you begin

Enable the BFD feature. See the [Enabling the BFD Feature](#) section.

SUMMARY STEPS

1. **configure terminal**
2. (Optional) **vrf context** *vrf-name*
3. **ip route** *route interface { nh-address | nh-prefix }*
4. **ip route static bfd** *interface { nh-address | nh-prefix }*
5. (Optional) **show ip route static** [*vrf vrf-name*]
6. (Optional) **copy running-config startup-config**

DETAILED STEPS

Procedure

	Command or Action	Purpose
Step 1	configure terminal Example: switch# configure terminal switch(config)#	Enters global configuration mode.
Step 2	(Optional) vrf context <i>vrf-name</i> Example: switch(config)# vrf context Red switch(config-vrf)#	Enters VRF configuration mode.
Step 3	ip route <i>route interface { nh-address nh-prefix }</i> Example: switch(config-vrf)# ip route 192.0.2.1 ethernet 2/1 192.0.2.4	Creates a static route. Use the ? keyword to display the supported interfaces.
Step 4	ip route static bfd <i>interface { nh-address nh-prefix }</i> Example: switch(config-vrf)# ip route static bfd ethernet 2/1 192.0.2.4	Enables BFD for all static routes on an interface. Use the ? keyword to display the supported interfaces.
Step 5	(Optional) show ip route static [<i>vrf vrf-name</i>] Example: switch(config-vrf)# show ip route static vrf Red	Displays the static routes.
Step 6	(Optional) copy running-config startup-config Example: switch# copy running-config startup-config	Saves this configuration change.

Verifying the BFD Configuration

To display BFD configuration information, perform one of the following tasks:

Command	Purpose
show running-config bfd	Displays the running BFD configuration.
show startup-config bfd	Displays the BFD configuration that will be applied on the next system startup.

For detailed information about the fields in the output from these commands, see the [Cisco Nexus 3548 Switch NX-OS Interfaces Command Reference, Release 6.x](#).

Monitoring BFD

Use the following commands to display BFD:

Command	Purpose
<code>show bfd neighbors [application name] [details]</code>	Displays information about BFD for a supported application, such as BGP.
<code>show bfd neighbors [interface int-if] [details]</code>	Displays information about BGP sessions on an interface.
<code>show bfd neighbors [dest-ip ip-address] [src-ip ip-address] [details]</code>	Displays information about the specified BGP session on an interface.
<code>show bfd neighbors [vrf vrf-name] [details]</code>	Displays information about BFD for a VRF.

For detailed information about the fields in the output from these commands, see the [Cisco Nexus 3548 Switch Command Reference](#).



CHAPTER 15

Configuring Policy-Based Routing

This chapter describes how to configure policy based routing on the Cisco NX-OS device.

This chapter includes the following sections:

- [Information About Policy-Based Routing, on page 299](#)
- [Prerequisites for Policy-Based Routing, on page 300](#)
- [Guidelines and Limitations for Policy-Based Routing, on page 301](#)
- [Default Settings, on page 301](#)
- [Configuring Policy-Based Routing, on page 301](#)
- [Verifying the Policy-Based Routing Configuration, on page 304](#)
- [Displaying Policy-Based Routing Statistics, on page 304](#)
- [Clearing Policy-Based Routing Statistics, on page 305](#)
- [Configuration Examples for Policy Based-Routing, on page 305](#)
- [Related Topics, on page 305](#)
- [Additional References, on page 306](#)
- [Feature History for Policy-Based Routing, on page 306](#)

Information About Policy-Based Routing

Policy-based routing allows you to configure a defined policy for IPv4 traffic flows, lessening reliance on routes derived from routing protocols. All packets received on an interface with policy-based routing enabled are passed through enhanced packet filters or *route maps*. The route maps dictate the policy, determining where to forward packets.

Route maps are composed of match and set statements that you can mark as permit or deny. You can interpret the statements as follows:

- If the packets match any route map statements, all the set statements are applied. One of these actions involves choosing the next-hop.
- If the statement is marked as permit and the packets do not match any route-map statements, the packets are sent back through the normal forwarding channels and destination-based routing is performed.

For more information, see the [Route Maps](#) section.

Policy-based routing includes the following features:

- Source-based routing—Routes traffic that originates from different sets of users through different connections across the policy routers.
- Load sharing—Distributes traffic among multiple paths based on the traffic characteristics.

Policy Route Maps

Route-Maps are used to filter routes that are distributed across various routing protocols and between different entities in a given routing protocol. Each entry in a route map contains a combination of match and set statements. The match statements define the criteria for whether appropriate packets meet the particular policy (that is, the conditions to be met). The set clauses explain how the packets should be routed once they have met the match criteria.

You can mark the route-map statements as permit or deny. If the statement is marked as a deny, the packets that meet the match criteria are sent back through the normal forwarding channels (destination-based routing is performed). If the statement is marked as permit and the packets meet the match criteria, all the set clauses are applied. If the statement is marked as permit and the packets do not meet the match criteria, those packets are also forwarded through the normal routing channel.



Note Policy routing is specified on the interface that receives the packets, not on the interface from which the packets are sent.

Set Criteria for Policy-Based Routing

The set criteria in a route map is evaluated in the order listed in the route map. Set criteria specific to route maps used for policy-based routing are as follows:

1. List of specified IP addresses—The IP address can specify the adjacent next-hop router in the path toward the destination to which the packets should be forwarded. The first IP address associated with a currently up connected interface is used to route the packets.



Note You can optionally configure the set criteria for next-hop addresses to load balance traffic across up to 16 IP addresses. In this case, Cisco NX-OS sends all traffic for each IP flow to a particular IP next-hop address.

2. NULL interface—Traffic that matches the match statement is dropped if you use the set null interface.

If the packets do not meet any of the defined match criteria, those packets are routed through the normal destination-based routing process

Prerequisites for Policy-Based Routing

Policy-based routing has the following prerequisites:

- Install the correct license.
- You must enable policy-based routing (see the [Enabling the Policy-Based Routing Feature](#) section).

- Assign an IP address on the interface and bring the interface up before you apply a route map on the interface for policy-based routing.

Guidelines and Limitations for Policy-Based Routing

Policy-based routing has the following configuration guidelines and limitations:

- A match command cannot refer to more than one ACL in a route map used for policy-based routing.
- An ACL used in a policy-based routing route map cannot include a deny statement.
- The same route map can be shared among different interfaces for policy-based routing as long as the interfaces belong to the same virtual routing and forwarding (VRF) instance.

Default Settings

Table below lists the default settings for policy-based routing parameters.

Table 17: Default Policy-based Routing Parameters

Parameters	Default
Policy-based routing	Disabled

Configuring Policy-Based Routing



Note If you are familiar with the Cisco IOS CLI, be aware that the Cisco NX-OS commands for this feature might differ from the Cisco IOS commands that you would use.

Enabling the Policy-Based Routing Feature

You must enable the policy-based routing feature before you can configure a route policy.

SUMMARY STEPS

1. **configure terminal**
2. **feature pbr**
3. (Optional) **show feature**
4. (Optional) **copy running-config startup-config**

DETAILED STEPS

Procedure

	Command or Action	Purpose
Step 1	configure terminal Example: switch# configure terminal switch(config)#	Enters global configuration mode.
Step 2	feature pbr Example: switch(config)# feature pbr	Enables the policy-based routing feature.
Step 3	(Optional) show feature Example: switch(config)# show feature	Displays enabled and disabled features.
Step 4	(Optional) copy running-config startup-config Example: switch(config)# copy running-config startup-config	Saves this configuration change.

Example

Use the **no feature pbr** command to disable the policy-based routing feature and remove all associated configuration.

Command	Purpose
no feature pbr Example: switch(config)# no feature pbr	Disables policy-based routing and removes all associated configuration.

Configuring a Route Policy

You can use route maps in policy-based routing to assign routing policies to the inbound interface. See the [Configuring Route Maps](#) section.

SUMMARY STEPS

1. **configure terminal**
2. **interface** *type slot/port*
3. **ip policy route-map** *map-name*

4. (Optional) **exit**
5. (Optional) **exit**
6. (Optional) **copy running-config startup-config**

DETAILED STEPS

Procedure

	Command or Action	Purpose
Step 1	configure terminal Example: switch# configure terminal switch(config)#	Enters global configuration mode.
Step 2	interface type slot/port Example: switch(config)# interface ethernet 1/2 switch(config-if)#	Enters interface configuration mode.
Step 3	ip policy route-map map-name Example: switch(config-if)# ip policy route-map Testmap	Assigns a route map for IPv4 policy-based routing to the interface.
Step 4	(Optional) exit Example: switch(config-route-map)# exit	Exits route-map configuration mode.
Step 5	(Optional) exit Example: switch(config)# exit	Exits global configuration mode.
Step 6	(Optional) copy running-config startup-config Example: switch(config)# copy running-config startup-config	Saves this configuration change.

Example

This example shows how to add a route map to an interface:

```
switch# configure terminal
switch(config)# interface ethernet 1/2
switch(config-if)# ip policy route-map Testmap
switch(config)# exit
switch(config)# copy running-config startup-config
```

You can configure the following optional match parameters for route maps in route-map configuration mode:

Command	Purpose
match ip address access-list-name <i>name</i> [<i>name...</i>] Example: <pre>switch(config-route-map)# match ip address access-list-name ACL1</pre>	Matches an IPv4 address against one or more IP access control lists (ACLs). This command is used for policy-based routing and is ignored by route filtering or redistribution.

You can configure the following optional set parameters for route maps in route-map configuration mode:

Command	Purpose
set ip next-hop <i>address1</i> [<i>address2...</i>] { load-share } Example: <pre>switch(config-route-map)# set ip next-hop 192.0.2.1</pre>	Sets the IPv4 next-hop address for policy-based routing. This command uses the first valid next-hop address if multiple addresses are configured. Use the optional load-share keyword to load balance traffic across a maximum of 16 next-hop addresses.
set ip default next-hop <i>address1</i> [<i>address2...</i>] { load-share } Example: <pre>switch(config-route-map)# set ip default next-hop 192.0.2.2</pre>	Sets the IPv4 next-hop address for policy-based routing when there is no explicit route to a destination. This command uses the first valid next-hop address if multiple addresses are configured. Use the optional load-share keyword to load balance traffic across a maximum of 16 next-hop addresses.

Cisco NX-OS routes the packet as soon as it finds a next-hop and an interface.

Verifying the Policy-Based Routing Configuration

To display policy-based routing configuration information, perform one of the following tasks:

Command	Purpose
show ip policy [<i>name</i>]	Displays information about an IPv4 policy.
show route-map [<i>name</i>] <i>pbr-statistics</i>	Displays policy statistics.

Use the **route-map** *map-name* **pbr-statistics** to enable policy statistics. Use the **clear route-map** *map-name* **pbr-statistics** to clear these policy statistics.

Displaying Policy-Based Routing Statistics

Use the **show route-map** *rmap-name* **pbr-statistics** command to display the statistics for policy-based routing. The statistics are maintained for each route-map sequence. It shows the number of packets that are policy-routed

based on the match condition in a given route-map sequence. All other packets that are routed using the default routing table (could be due to unreachable next-hops in the set command) are also displayed. The PBR statistics collection must be turned on before any statistics can be shown.

This example shows how to display PBR statistics:

```
switch(config)# show route-map pbr-sample pbr-statistics
```

Clearing Policy-Based Routing Statistics

Use the **clear route-map *rmap-name* pbr-statistics** command to clear the counters maintained for PBR statistics of a route-map.

This example shows how to clear PBR statistics:

```
switch(config)# clear route-map pbr-sample pbr-statistics
```

Configuration Examples for Policy Based-Routing

This example shows how to configure a simple route policy on an interface:

```
feature pbr
ip access-list pbr-sample
permit tcp host 10.1.1.1 host 192.168.2.1 eq 80
!
route-map pbr-sample
match ip address pbr-sample
set ip next-hop 192.168.1.1
!
route-map pbr-sample pbr-statistics

interface ethernet 1/2
ip policy route-map pbr-sample
```

The following output verifies this configuration:

```
n3000# show route-map pbr-sample

route-map pbr-sample, permit, sequence 10
Match clauses:
ip address (access-lists): pbr-sample
Set clauses:
ip next-hop 192.168.1.1

n3000# show route-map pbr-sample pbr-statistics

route-map pbr-sample, permit, sequence 10
Policy routing matches: 84 packets
```

Related Topics

The following topics can give more information on Policy Based Routing:

- [Configuring Route Policy Manager](#)

Additional References

For additional information related to implementing IP, see the following sections:

- [Related Documents](#)
- [Standards](#)

Related Documents

Related Topic	Document Title
Policy-based routing CLI commands	Cisco Nexus 3000 Series NX-OS Unicast Routing Command Reference

Standards

Standards	Title
No new or modified standards are supported by this feature, and support for existing standards has not been modified by this feature.	—

Feature History for Policy-Based Routing

Table below lists the release history for this feature.

Table 18: Feature History for Policy-Based Routing

Feature Name	Releases	Feature Information
Policy-based routing	6.0(2)A7(1)	This feature was introduced.



CHAPTER 16

Configuring HSRP

This chapter describes how to configure the Hot Standby Router Protocol (HSRP) on Cisco NX-OS switches.

This chapter includes the following sections:

- [Information About HSRP, on page 307](#)
- [Prerequisites for HSRP, on page 311](#)
- [Guidelines and Limitations for HSRP, on page 311](#)
- [Default Settings for HSRP, on page 311](#)
- [Configuring HSRP, on page 312](#)
- [Verifying the HSRP Configuration, on page 321](#)
- [Configuration Examples for HSRP, on page 322](#)
- [Additional References, on page 322](#)

Information About HSRP

HSRP is a first-hop redundancy protocol (FHRP) that allows a transparent failover of the first-hop IP router. HSRP provides first-hop routing redundancy for IP hosts on Ethernet networks configured with a default router IP address. You use HSRP in a group of routers for selecting an active router and a standby router. In a group of routers, the active router is the router that routes packets; the standby router is the router that takes over when the active router fails or when preset conditions are met.

Many host implementations do not support any dynamic router discovery mechanisms but can be configured with a default router. Running a dynamic router discovery mechanism on every host is not feasible for a number of reasons, including administrative overhead, processing overhead, and security issues. HSRP provides failover services to these hosts.

HSRP Overview

When you use HSRP, you configure the HSRP virtual IP address as the host's default router (instead of the IP address of the actual router). The virtual IP address is an IPv4 address that is shared among a group of routers that run HSRP.

When you configure HSRP on a network segment, you provide a virtual MAC address and a virtual IP address for the HSRP group. You configure the same virtual address on each HSRP-enabled interface in the group. You also configure a unique IP address and MAC address on each interface that acts as the real address. HSRP selects one of these interfaces to be the active router. The active router receives and routes packets destined for the virtual MAC address of the group.

HSRP detects when the designated active router fails. At that point, a selected standby router assumes control of the virtual MAC and IP addresses of the HSRP group. HSRP also selects a new standby router at that time.

HSRP uses a priority mechanism to determine which HSRP-configured interface becomes the default active router. To configure an interface as the active router, you assign it with a priority that is higher than the priority of all the other HSRP-configured interfaces in the group. The default priority is 100, so if you configure just one interface with a higher priority, that interface becomes the default active router.

Interfaces that run HSRP send and receive multicast User Datagram Protocol (UDP)-based hello messages to detect a failure and to designate active and standby routers. When the active router fails to send a hello message within a configurable period of time, the standby router with the highest priority becomes the active router. The transition of packet forwarding functions between the active and standby router is completely transparent to all hosts on the network.

You can configure multiple HSRP groups on an interface.

The following figure shows a network configured for HSRP. By sharing a virtual MAC address and a virtual IP address, two or more interfaces can act as a single virtual router.

Figure 21: HSRP Topology with Two Enabled Routers

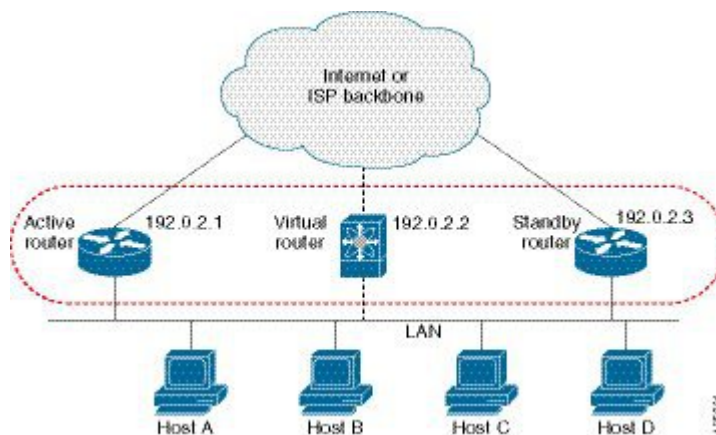

The virtual router does not physically exist but represents the common default router for interfaces that are configured to provide backup to each other. You do not need to configure the hosts on the LAN with the IP address of the active router. Instead, you configure them with the IP address (virtual IP address) of the virtual router as their default router. If the active router fails to send a hello message within the configurable period of time, the standby router takes over, responds to the virtual addresses, and becomes the active router, assuming the active router duties. From the host perspective, the virtual router remains the same.



Note Packets received on a routed port destined for the HSRP virtual IP address will terminate on the local router, regardless of whether that router is the active HSRP router or the standby HSRP router. This includes ping and Telnet traffic. Packets received on a Layer 2 (VLAN) interface destined for the HSRP virtual IP address will terminate on the active router.

HSRP for IPv4

HSRP routers communicate with each other by exchanging HSRP hello packets. These packets are sent to the destination IP multicast address 224.0.0.2 (reserved multicast address used to communicate to all routers)

on UDP port 1985. The active router sources hello packets from its configured IP address and the HSRP virtual MAC address while the standby router sources hellos from its configured IP address and the interface MAC address, which may or may not be the burned-in address (BIA). The BIA is the last six bytes of the MAC address that is assigned by the manufacturer of the network interface card (NIC).

Because hosts are configured with their default router as the HSRP virtual IP address, hosts must communicate with the MAC address associated with the HSRP virtual IP address. This MAC address is a virtual MAC address, 0000.0C07.ACxy, where xy is the HSRP group number in hexadecimal based on the respective interface. For example, HSRP group 1 uses the HSRP virtual MAC address of 0000.0C07.AC01. Hosts on the adjoining LAN segment use the normal Address Resolution Protocol (ARP) process to resolve the associated MAC addresses.

HSRP version 2 uses the new IP multicast address 224.0.0.102 to send hello packets instead of the multicast address of 224.0.0.2, which is used by version 1. HSRP version 2 permits an expanded group number range of 0 to 4095 and uses a new MAC address range of 0000.0C9F.F000 to 0000.0C9F.FFFF.

HSRP Versions

Cisco NX-OS supports HSRP version 1 by default. You can configure an interface to use HSRP version 2.

HSRP version 2 has the following enhancements to HSRP version 1:

- Expands the group number range. HSRP version 1 supports group numbers from 0 to 255. HSRP version 2 supports group numbers from 0 to 4095.
- For IPv4, uses the IPv4 multicast address 224.0.0.102 to send hello packets instead of the multicast address of 224.0.0.2, which is used by HSRP version 1.
- Uses the MAC address range from 0000.0C9F.F000 to 0000.0C9F.FFFF. HSRP version 1 uses the MAC address range 0000.0C07.AC00 to 0000.0C07.ACFE.
- Adds support for MD5 authentication.

When you change the HSRP version, Cisco NX-OS reinitializes the group because it now has a new virtual MAC address.

HSRP version 2 has a different packet format than HSRP version 1. The packet format uses a type-length-value (TLV) format. HSRP version 2 packets received by an HSRP version 1 router are ignored.

HSRP Authentication

HSRP message digest 5 (MD5) algorithm authentication protects against HSRP-spoofing software and uses the industry-standard MD5 algorithm for improved reliability and security. HSRP includes the IPv4 address in the authentication TLVs.

HSRP Messages

Routers that are configured with HSRP exchange the following three types of multicast messages:

- Hello—The hello message conveys the HSRP priority and state information of the router to other HSRP routers.
- Coup—When a standby router wants to assume the function of the active router, it sends a coup message.

- Resign—The active router sends this message when it no longer wants to function as the active router.

HSRP Load Sharing

HSRP allows you to configure multiple groups on an interface. You can configure two overlapping IPv4 HSRP groups to load share traffic from the connected hosts while providing the default router redundancy expected from HSRP. Figure below shows an example of a load-sharing HSRP IPv4 configuration.

Figure 22: HSRP Load Sharing

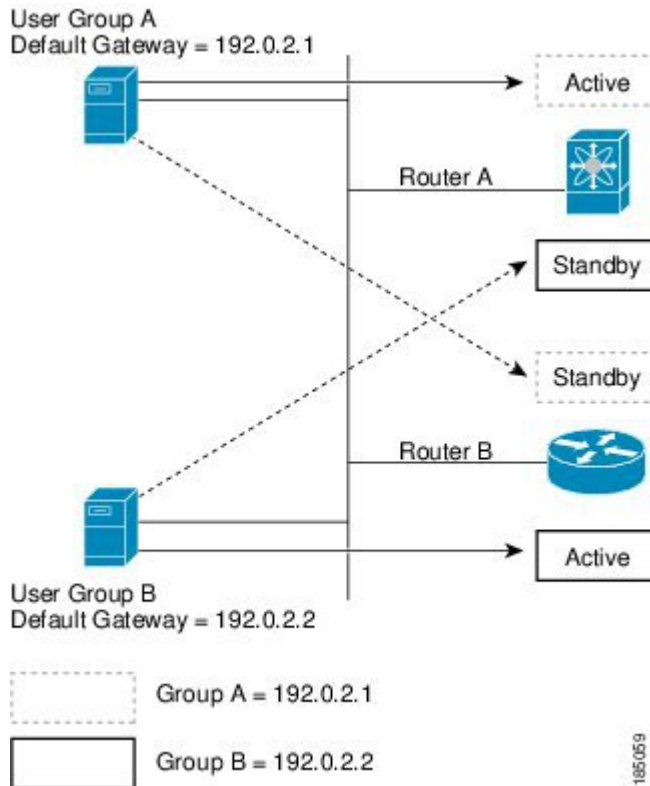

Figure **HSRP Load Sharing** shows two routers (A and B) and two HSRP groups. Router A is the active router for group A but is the standby router for group B. Similarly, router B is the active router for group B and the standby router for group A. If both routers remain active, HSRP load balances the traffic from the hosts across both routers. If either router fails, the remaining router continues to process traffic for both hosts.

Object Tracking and HSRP

You can use object tracking to modify the priority of an HSRP interface based on the operational state of another interface. Object tracking allows you to route to a standby router if the interface to the main network fails.

Two objects that you can track are the line protocol state of an interface or the reachability of an IP route. If the specified object goes down, Cisco NX-OS reduces the HSRP priority by the configured amount. For more information, see the [Configuring HSRP Object Tracking](#) section.

Prerequisites for HSRP

HSRP has the following prerequisites:

- You must enable the HSRP feature in a switch before you can configure and enable any HSRP groups.

Guidelines and Limitations for HSRP

HSRP has the following configuration guidelines and limitations:

- The minimum hello timer value is 250 milliseconds.
- The minimum hold timer value is 750 milliseconds.
- You must configure an IP address for the interface that you configure HSRP on and enable that interface before HSRP becomes active.
- For IPv4, the virtual IP address must be in the same subnet as the interface IP address.
- We recommend that you do not configure more than one first-hop redundancy protocol on the same interface.
- HSRP version 2 does not interoperate with HSRP version 1. An interface cannot operate both version 1 and version 2 because both versions are mutually exclusive. However, the different versions can be run on different physical interfaces of the same router.
- You cannot change from version 2 to version 1 if you have configured groups above the group number range allowed for version 1 (0 to 255).
- Cisco NX-OS removes all Layer 3 configuration on an interface when you change the interface VRF membership, port channel membership, or when you change the port mode to Layer 2.
- HSRP localization with PACL filtering and 4-way configuration of HSRP is not supported.

Default Settings for HSRP

Table below lists the default settings for HSRP parameters.

Table 19: Default HSRP Parameters

Parameters	Default
HSRP	Disabled
Authentication	Enabled as text for version 1, with cisco as the password
HSRP version	Version 1
Preemption	disabled
Priority	100

Parameters	Default
virtual MAC address	Derived from HSRP group number

Configuring HSRP



Note If you are familiar with the Cisco IOS CLI, be aware that the Cisco NX-OS commands for this feature might differ from the Cisco IOS commands that you would use.

Enabling the HSRP Feature

You must globally enable the HSRP feature before you can configure and enable any HSRP groups.

DETAILED STEPS

To enable the HSRP feature, use the following command in global configuration mode:

Command	Purpose
feature hsrp Example : switch(config)# feature hsrp	Enables HSRP.

To disable the HSRP feature and remove all associated configuration, use the following command in global configuration mode:

Command	Purpose
no feature hsrp Example : switch(config)# no feature hsrp	Disables HSRP.

Configuring the HSRP Version

You can configure the HSRP version. If you change the version for existing groups, Cisco NX-OS reinitializes HSRP for those groups because the virtual MAC address changes. The HSRP version applies to all groups on the interface.

To configure the HSRP version, use the following command in interface configuration mode:

Command	Purpose
hsrp version { 1 2 } Example : <pre>switch(config-if)# hsrp version 2</pre>	Configures the HSRP version. Version 1 is the default.

Configuring an HSRP Group for IPv4

You can configure an HSRP group on an IPv4 interface and configure the virtual IP address and virtual MAC address for the HSRP group.

Before you begin

Ensure that you have enabled the HSRP feature (see the [Enabling the HSRP Feature](#) section).

Cisco NX-OS enables an HSRP group once you configure the virtual IP address on any member interface in the group. You should configure HSRP attributes such as authentication, timers, and priority before you enable the HSRP group.

SUMMARY STEPS

1. **configure terminal**
2. **interface** *type number*
3. **no switchport**
4. **ip address** *ip-address/length*
5. **hsrp group-number** [**ipv4**]
6. **ip** [*ip-address* [**secondary**]]
7. **exit**
8. **no shutdown**
9. (Optional) **show hsrp** [**group** *group-number*] [**ipv4**]
10. (Optional) **copy running-config startup-config**

DETAILED STEPS

Procedure

	Command or Action	Purpose
Step 1	configure terminal Example: <pre>switch# configure terminal switch(config)#</pre>	Enters configuration mode.
Step 2	interface <i>type number</i> Example: <pre>switch(config)# interface ethernet 1/2 switch(config-if)#</pre>	Enters interface configuration mode.

	Command or Action	Purpose
Step 3	no switchport Example: switch(config-if)# no switchport	Configures the interface as a Layer 3 routed interface.
Step 4	ip address ip-address/length Example: switch(config-if)# ip address 192.0.2.2/8	Configures the IPv4 address of the interface.
Step 5	hsrp group-number [ipv4] Example: switch(config-if)# hsrp 2 switch(config-if-hsrp)	Creates an HSRP group and enters hsrp configuration mode. The range for HSRP version 1 is from 0 to 255. The range is for HSRP version 2 is from 0 to 4095. The default value is 0.
Step 6	ip [ip-address [secondary]] Example: switch(config-if-hsrp)# ip 192.0.2.1	Configures the virtual IP address for the HSRP group and enables the group. This address should be in the same subnet as the IPv4 address of the interface.
Step 7	exit Example: switch(config-if-hsrp)# exit	Exits HSRP configuration mode.
Step 8	no shutdown Example: switch(config-if)# no shutdown	Enables the interface.
Step 9	(Optional) show hsrp [group group-number] [ipv4] Example: switch(config-if)# show hsrp group 2	Displays HSRP information.
Step 10	(Optional) copy running-config startup-config Example: switch(config-if)# copy running-config startup-config	Saves this configuration change.

Example



Note You should use the **no shutdown** command to enable the interface after you finish the configuration.

This example shows how to configure an HSRP group on Ethernet 1/2:

```
switch# configure terminal
switch(config)# interface ethernet 1/2
switch(config-if)# no switchport
switch(config-if)# ip 192.0.2.2/8
```



```
switch(config-if)# hsrp 2
switch(config-if-hsrp)# ip 192.0.2.1
switch(config-if-hsrp)# exit
switch(config-if)# no shutdown
switch(config-if)# copy running-config startup-config
```

Configuring the HSRP Virtual MAC Address

You can override the default virtual MAC address that HSRP derives from the configured group number.

To manually configure the virtual MAC address for an HSRP group, use the following command in hsrp configuration mode:

Command	Purpose
mac-address <i>string</i> Example : <pre>switch(config-if-hsrp)# mac-address 5000.1000.1060</pre>	Configures the virtual MAC address for an HSRP group. The string uses the standard MAC address format (xxxx.xxxx.xxxx).

To configure HSRP to use the burned-in MAC address of the interface for the virtual MAC address, use the following command in interface configuration mode:

Command	Purpose
hsrp use-bia [scope interface] Example : <pre>switch(config-if)# hsrp use-bia</pre>	Configures HSRP to use the burned-in MAC address of the interface for the HSRP virtual MAC address. You can optionally configure HSRP to use the burned-in MAC address for all groups on this interface by using the scope interface keywords.

Authenticating HSRP

You can configure HSRP to authenticate the protocol using cleartext or MD5 digest authentication. MD5 authentication uses a key chain (see the [Cisco Nexus 3548 Switch NX-OS Security Configuration Guide](#)).

Before you begin

Ensure that you have enabled the HSRP feature (see the [Enabling the HSRP Feature](#) section).

You must configure the same authentication and keys on all members of the HSRP group.

Ensure that you have created the key chain if you are using MD5 authentication.

SUMMARY STEPS

1. **configure terminal**
2. **interface** *interface type slot/port*
3. **no switchport**
4. **hsrp group-number** [**ipv4**]
- 5.
6. (Optional) **show hsrp** [**group group-number**]

7. (Optional) copy running-config startup-config

DETAILED STEPS

Procedure

	Command or Action	Purpose								
Step 1	configure terminal Example: <pre>switch# configure terminal switch(config)#</pre>	Enters configuration mode.								
Step 2	interface <i>interface type slot/port</i> Example: <pre>switch(config)# interface ethernet 1/2 switch(config-if)#</pre>	Enters interface configuration mode..								
Step 3	no switchport Example: <pre>switch(config-if)# no switchport</pre>	Configures the interface as a Layer 3 routed interface.								
Step 4	hsrp <i>group-number</i> [<i>ipv4</i>] Example: <pre>switch(config-if)# hsrp 2 switch(config-if-hsrp)</pre>	Creates an HSRP group and enters HSRP configuration mode.								
Step 5	<table border="1"> <thead> <tr> <th>Option</th> <th>Description</th> </tr> </thead> <tbody> <tr> <td>Command</td> <td>Purpose</td> </tr> <tr> <td> authentication text <i>string</i> Example: <pre>switch(config-if-hsrp)# authentication text mypassword</pre> </td> <td>Configures cleartext authentication for HSRP on this interface.</td> </tr> <tr> <td> authentication md5 { key-chain <i>key-chain</i> key-string { <i>0</i> <i>7</i> } text [<i>text</i>] timeout <i>seconds</i> } Example: <pre>switch(config-if-hsrp)# authentication md5 key-chain hsrp-keys</pre> </td> <td>Configures MD5 authentication for HSRP on this interface. You can use a key chain or key string. If you use a key string, you can optionally set the timeout for when HSRP will only accept a new key. The range is from 0 to 32767 seconds.</td> </tr> </tbody> </table>	Option	Description	Command	Purpose	authentication text <i>string</i> Example: <pre>switch(config-if-hsrp)# authentication text mypassword</pre>	Configures cleartext authentication for HSRP on this interface.	authentication md5 { key-chain <i>key-chain</i> key-string { <i>0</i> <i>7</i> } text [<i>text</i>] timeout <i>seconds</i> } Example: <pre>switch(config-if-hsrp)# authentication md5 key-chain hsrp-keys</pre>	Configures MD5 authentication for HSRP on this interface. You can use a key chain or key string. If you use a key string, you can optionally set the timeout for when HSRP will only accept a new key. The range is from 0 to 32767 seconds.	
Option	Description									
Command	Purpose									
authentication text <i>string</i> Example: <pre>switch(config-if-hsrp)# authentication text mypassword</pre>	Configures cleartext authentication for HSRP on this interface.									
authentication md5 { key-chain <i>key-chain</i> key-string { <i>0</i> <i>7</i> } text [<i>text</i>] timeout <i>seconds</i> } Example: <pre>switch(config-if-hsrp)# authentication md5 key-chain hsrp-keys</pre>	Configures MD5 authentication for HSRP on this interface. You can use a key chain or key string. If you use a key string, you can optionally set the timeout for when HSRP will only accept a new key. The range is from 0 to 32767 seconds.									
Step 6	(Optional) show hsrp [group <i>group-number</i>] Example:	Displays HSRP information.								

	Command or Action	Purpose
	<code>switch(config-if-hsrp)# show hsrp group 2</code>	
Step 7	<p>(Optional) copy running-config startup-config</p> <p>Example:</p> <pre>switch(config-if-hsrp)# copy running-config startup-config</pre>	Saves this configuration change.

Example

This example shows how to configure MD5 authentication for HSRP on Ethernet 1/2 after creating the key chain:

```
switch# configure terminal
switch(config)# key chain hsrp-keys
switch(config-keychain)# key 0
switch(config-keychain-key)# key-string 7 zqdest
switch(config-keychain-key) accept-lifetime 00:00:00 Jun 01 2008 23:59:59 Sep 12 2008
switch(config-keychain-key) send-lifetime 00:00:00 Jun 01 2008 23:59:59 Aug 12 2008
switch(config-keychain-key) key 1
switch(config-keychain-key) key-string 7 uaeqdyito
switch(config-keychain-key) accept-lifetime 00:00:00 Aug 12 2008 23:59:59 Dec 12 2008
switch(config-keychain-key) send-lifetime 00:00:00 Sep 12 2008 23:59:59 Nov 12 2008
switch(config-keychain-key)# interface ethernet 1/2
switch(config-if)# no switchport
switch(config-if)# hsrp 2
switch(config-if-hsrp)# authenticate md5 key-chain hsrp-keys
switch(config-if-hsrp)# copy running-config startup-config
```

Configuring HSRP Object Tracking

You can configure an HSRP group to adjust its priority based on the availability of other interfaces or routes. The priority of a switch can change dynamically if it has been configured for object tracking and the object that is being tracked goes down. The tracking process periodically polls the tracked objects and notes any value change. The value change triggers HSRP to recalculate the priority. The HSRP interface with the higher priority becomes the active router if you configure the HSRP interface for preemption.

HSRP supports tracked objects and track lists. See [Configuring Object Tracking](#) for more information on track lists.

Before you begin

Ensure that you have enabled the HSRP feature (see the [Enabling the HSRP Feature](#) section).

SUMMARY STEPS

1. **configure terminal**
- 2.
3. **interface** *interface-type slot/port*
4. **no switchport**
5. **hsrp** *group-number* [**ipv4**]
6. **priority** [*value*]

7. **track** *object-number* [**decrement** *value*]
8. **preempt** [**delay** [**minimum** *seconds*] [**reload** *seconds*] [**sync** *seconds*]]
9. (Optional) **show** **hsrp interface** *interface-type number*
10. (Optional) **copy** **running-config** **startup-config**

DETAILED STEPS

Procedure

	Command or Action	Purpose								
Step 1	configure terminal Example: <pre>switch# configure terminal switch(config)#</pre>	Enters configuration mode.								
Step 2	<table border="1"> <thead> <tr> <th>Option</th> <th>Description</th> </tr> </thead> <tbody> <tr> <td>Command</td> <td>Purpose</td> </tr> <tr> <td> track <i>object-id</i> interface <i>interface-type number</i> { ip routing line-protocol } Example: <pre>switch(config)# track 1 interface ethernet 2/2 line-protocol switch(config-track#</pre> </td> <td> Configures the interface that this HSRP interface tracks. Changes in the state of the interface affect the priority of this HSRP interface as follows: <ul style="list-style-type: none"> • You configure the interface and corresponding object number that you use with the track command in hsrp configuration mode. • The line-protocol keyword tracks whether the interface is up. The ip keyword also checks that IP routing is enabled on the interface and an IP address is configured. </td> </tr> <tr> <td> track <i>object-id</i> ip route <i>ip-prefix/length</i> reachability Example: <pre>switch(config)# track 2 ip route 192.0.2.0/8 reachability switch(config-track#</pre> </td> <td>Creates a tracked object for a route and enters tracking configuration mode. The object-id range is from 1 to 500.</td> </tr> </tbody> </table>	Option	Description	Command	Purpose	track <i>object-id</i> interface <i>interface-type number</i> { ip routing line-protocol } Example: <pre>switch(config)# track 1 interface ethernet 2/2 line-protocol switch(config-track#</pre>	Configures the interface that this HSRP interface tracks. Changes in the state of the interface affect the priority of this HSRP interface as follows: <ul style="list-style-type: none"> • You configure the interface and corresponding object number that you use with the track command in hsrp configuration mode. • The line-protocol keyword tracks whether the interface is up. The ip keyword also checks that IP routing is enabled on the interface and an IP address is configured. 	track <i>object-id</i> ip route <i>ip-prefix/length</i> reachability Example: <pre>switch(config)# track 2 ip route 192.0.2.0/8 reachability switch(config-track#</pre>	Creates a tracked object for a route and enters tracking configuration mode. The object-id range is from 1 to 500.	
Option	Description									
Command	Purpose									
track <i>object-id</i> interface <i>interface-type number</i> { ip routing line-protocol } Example: <pre>switch(config)# track 1 interface ethernet 2/2 line-protocol switch(config-track#</pre>	Configures the interface that this HSRP interface tracks. Changes in the state of the interface affect the priority of this HSRP interface as follows: <ul style="list-style-type: none"> • You configure the interface and corresponding object number that you use with the track command in hsrp configuration mode. • The line-protocol keyword tracks whether the interface is up. The ip keyword also checks that IP routing is enabled on the interface and an IP address is configured. 									
track <i>object-id</i> ip route <i>ip-prefix/length</i> reachability Example: <pre>switch(config)# track 2 ip route 192.0.2.0/8 reachability switch(config-track#</pre>	Creates a tracked object for a route and enters tracking configuration mode. The object-id range is from 1 to 500.									

	Command or Action	Purpose
Step 3	interface <i>interface-type slot/port</i> Example: switch(config)# interface ethernet 1/2 switch(config-if)#	Enters interface configuration mode.
Step 4	no switchport Example: switch(config-if)# no switchport	Configures the interface as a Layer 3 routed interface.
Step 5	hsrp group-number [ipv4] Example: switch(config-if)# hsrp 2 switch(config-if-hsrp)#	Creates an HSRP group and enters hsrp configuration mode.
Step 6	priority [<i>value</i>] Example: switch(config-if-hsrp)# priority 254	Sets the priority level used to select the active router in an HSRP group. The range is from 0 to 255. The default is 100.
Step 7	track object-number [decrement value] Example: switch(config-if-hsrp)# track 1 decrement 20	Specifies an object to be tracked that affects the weighting of an HSRP interface. The <i>value</i> argument specifies a reduction in the priority of an HSRP interface when a tracked object fails. The range is from 1 to 255. The default is 10.
Step 8	preempt [delay [minimum seconds] [reload seconds] [sync seconds]] Example: switch(config-if-hsrp)# preempt delay minimum 60	Configures the router to take over as the active router for an HSRP group if it has a higher priority than the current active router. This command is disabled by default. The range is from 0 to 3600 seconds.
Step 9	(Optional) show hsrp interface interface-type number Example: switch(config-if-hsrp)# show hsrp interface ethernet 1/2	Displays HSRP information for an interface.
Step 10	(Optional) copy running-config startup-config Example: switch(config-if)# copy running-config startup-config	Saves this configuration change.

Example

This example shows how to configure HSRP object tracking on Ethernet 1/2:

```
switch# configure terminal
switch(config)# track 1 interface ethernet 2/2 line-protocol
switch(config)# interface ethernet 1/2
switch(config-if)# no switchport
```

```
switch(config-if)# hsrp 2
switch(config-if-hsrp)# track 1 decrement 20
switch(config-if-hsrp)# copy running-config startup-config
```

Configuring the HSRP Priority

You can configure the HSRP priority on an interface. HSRP uses the priority to determine which HSRP group member acts as the active router.

To configure the HSRP priority, use the following command in interface configuration mode:

Command	Purpose
<p>priority <i>level</i> [forwarding-threshold lower <i>lower-value</i> upper <i>upper-value</i>]</p> <p>Example:</p> <pre>switch(config-if-hsrp)# priority 60 forwarding-threshold lower 40 upper 50</pre>	<p>Sets the priority level used to select the active router in an HSRP group. The <i>level</i> range is from 0 to 255. The default is 100.</p>

Customizing HSRP

You can optionally customize the behavior of HSRP. Be aware that as soon as you enable an HSRP group by configuring a virtual IP address, that group is now operational. If you first enable an HSRP group before customizing HSRP, the router could take control over the group and become the active router before you finish customizing the feature. If you plan to customize HSRP, you should do so before you enable the HSRP group.

To customize HSRP, use the following commands in hsrp configuration mode:

Command	Purpose
<p>name <i>string</i></p> <p>Example:</p> <pre>switch(config-if-hsrp)# name HSRP-1</pre>	<p>Specifies the IP redundancy name for an HSRP group. The <i>string</i> is from 1 to 255 characters. The default string has the following format: hsrp-interface-short-name-group-id</p> <p>For example,</p> <pre>hsrp-Eth2/1-1</pre>
<p>preempt [delay [minimum <i>seconds</i>] [reload <i>seconds</i>] [sync <i>seconds</i>]]</p> <p>Example:</p> <pre>switch(config-if-hsrp)# preempt delay minimum 60</pre>	<p>Configures the router to take over as an active router for an HSRP group if it has a higher priority than the current active router. This command is disabled by default. The range is from 0 to 3600 seconds.</p>

Command	Purpose
timers [msec] <i>hellotime</i> [msec] <i>holdtime</i> Example: <pre>switch(config-if-hsrp)# timers 5 18</pre>	Configures the hello and hold time for this HSRP member as follows: The optional <i>msec</i> keyword specifies that the argument is expressed in milliseconds, instead of the default seconds. The timer ranges for milliseconds are as follows: <ul style="list-style-type: none"> • <i>hellotime</i> —The interval between successive hello packets sent. The range is from 255 to 999 milliseconds. • <i>holdtime</i> —The interval before the information in the hello packet is considered invalid. The range is from 750 to 3000 milliseconds.

To customize HSRP, use the following commands in interface configuration mode:

Command or Action	Purpose
hsrp delay minimum <i>seconds</i> Example: <pre>switch(config-if)# hsrp delay minimum 30</pre>	Specifies the minimum amount of time that HSRP waits after a group is enabled before participating in the group. The range is from 0 to 10000 seconds. The default is 0.
hsrp delay reload <i>seconds</i> Example: <pre>switch(config-if)# hsrp delay reload 30</pre>	Specifies the minimum amount of time that HSRP waits after reload before participating in the group. The range is from 0 to 10000 seconds. The default is 0.

Verifying the HSRP Configuration

To display the HSRP configuration information, perform one of the following tasks:

Command	Purpose
show hsrp [group <i>group-number</i>]	Displays the HSRP status for all groups or one group.
show hsrp delay [interface <i>interface-type slot/port</i>]	Displays the HSRP delay value for all interfaces or one interface.
show hsrp [interface <i>interface-type slot/port</i>]	Displays the HSRP status for an interface.
show hsrp [group <i>group-number</i>] [interface <i>interface-type slot/port</i>] [active] [all] [init] [learn] [listen] [speak] [standby]	Displays the HSRP status for a group or interface for virtual forwarders in the active, init, learn, listen, or standby state. Use the all keyword to see all states, including disabled.
show hsrp [group <i>group-number</i>] [interface <i>interface-type slot/port</i>] active] [all] [init] [learn] [listen] [speak] [standby] brief	Displays a brief summary of the HSRP status for a group or interface for virtual forwarders in the active, init, learn, listen, or standby state. Use the all keyword to see all states, including disabled.

Configuration Examples for HSRP

This example shows how to enable HSRP on an interface with MD5 authentication and interface tracking:

```
key chain hsrp-keys
key 0
key-string 7 zqdest
accept-lifetime 00:00:00 Jun 01 2008 23:59:59 Sep 12 2008
send-lifetime 00:00:00 Jun 01 2008 23:59:59 Aug 12 2008
key 1
key-string 7 uaegdyito
accept-lifetime 00:00:00 Aug 12 2008 23:59:59 Dec 12 2008
send-lifetime 00:00:00 Sep 12 2008 23:59:59 Nov 12 2008
feature hsrp
track 2 interface ethernet 2/2 ip
interface ethernet 1/2
no switchport
ip address 192.0.2.2/8
hsrp 1
authenticate md5 key-chain hsrp-keys
priority 90
track 2 decrement 20
ip-address 192.0.2.10
no shutdown
```

Additional References

For additional information related to implementing HSRP, see the following sections:

- [Related Documents](#)
- [MIBs](#)

Related Documents

Related Topic	Document Title
Configuring the Virtual Router Redundancy Protocol	Configuring VRRP
HSRP CLI commands	Cisco Nexus 3000 Series Command Reference

MIBs

MIBs	MIBs Link
CISCO-HSRP-MIB	To locate and download MIBs, go to the following: MIB Locator .



CHAPTER 17

Configuring VRRP

This chapter describes how to configure the Virtual Router Redundancy Protocol (VRRP) on Cisco NX-OS switches.

This chapter includes the following sections:

- [Information About VRRP, on page 323](#)
- [Guidelines and Limitations for VRRP, on page 328](#)
- [Default Settings for VRRP, on page 328](#)
- [Configuring VRRP, on page 328](#)
- [Verifying the VRRP Configuration, on page 339](#)
- [Displaying VRRP Statistics, on page 339](#)
- [Configuration Examples for VRRP, on page 339](#)
- [Additional References, on page 340](#)

Information About VRRP

VRRP allows for transparent failover at the first-hop IP router, by configuring a group of routers to share a virtual IP address. VRRP selects a primary router in that group to handle all packets for the virtual IP address. The remaining routers are in standby and take over if the primary router fails.

VRRP Operation

A LAN client can determine which router should be the first hop to a particular remote destination by using a dynamic process or static configuration. Examples of dynamic router discovery are as follows:

- Proxy ARP—The client uses Address Resolution Protocol (ARP) to get the destination it wants to reach, and a router will respond to the ARP request with its own MAC address.
- Routing protocol—The client listens to dynamic routing protocol updates (for example, from Routing Information Protocol [RIP]) and forms its own routing table.
- ICMP Router Discovery Protocol (IRDP) client—The client runs an Internet Control Message Protocol (ICMP) router discovery client.

The disadvantage to dynamic discovery protocols is that they incur some configuration and processing overhead on the LAN client. Also, if a router fails, the process of switching to another router can be slow.

An alternative to dynamic discovery protocols is to statically configure a default router on the client. Although this approach simplifies client configuration and processing, it creates a single point of failure. If the default gateway fails, the LAN client is limited to communicating only on the local IP network segment and is cut off from the rest of the network.

VRRP can solve the static configuration problem by enabling a group of routers (a VRRP group) to share a single virtual IP address. You can then configure the LAN clients with the virtual IP address as their default gateway.

The following figure shows a basic VLAN topology. In this example, Routers A, B, and C form a VRRP group. The IP address of the group is the same address that was configured for the Ethernet interface of Router A (10.0.0.1).

Figure 23: Basic VRRP Topology

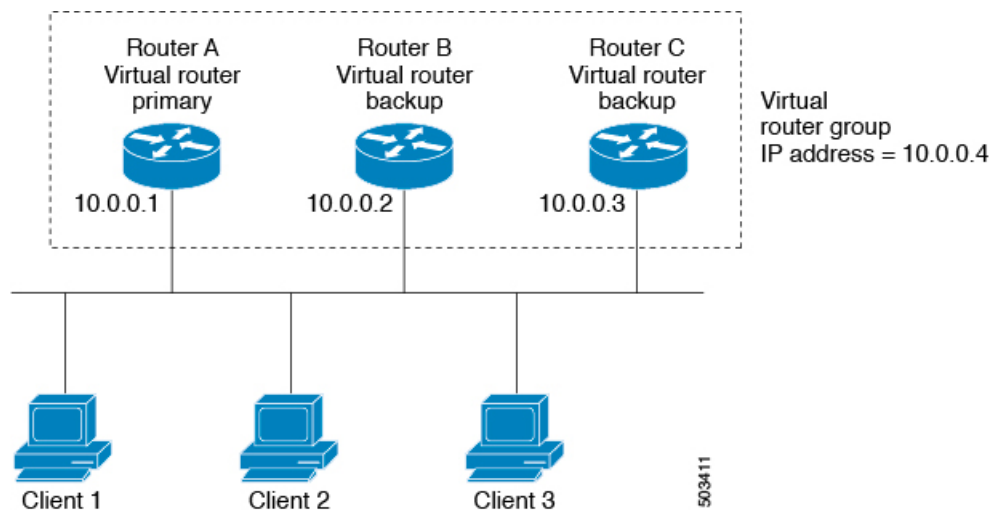

Because the virtual IP address uses the IP address of the physical Ethernet interface of Router A, Router A is the primary (also known as the IP address owner). As the primary, Router A owns the virtual IP address of the VRRP group router and forwards packets that are sent to this IP address. Clients 1—3 are configured with the default gateway IP address of 10.0.0.1.

Routers B and C function as backups. If the primary fails, the backup router with the highest priority becomes the primary and takes over the virtual IP address to provide uninterrupted service for the LAN hosts. When router A recovers, it becomes the router primary again. For more information, see the “VRRP Router Priority and Preemption” section.



Note Packets that are received on a routed port destined for the VRRP virtual IP address terminate on the local router, regardless of whether that router is the primary VRRP router or a backup VRRP router. This includes ping and telnet traffic. Packets received on a Layer 2 (VLAN) interface destined for the VRRP virtual IP address terminate on the primary router.

VRRP Benefits

The benefits of VRRP are as follows:

- **Redundance**—Enables you to configure multiple routers as the default gateway router, which reduces the possibility of a single point of failure in a network.
- **Load Sharing**—Allows traffic to and from LAN clients to be shared by multiple routers. The traffic load is shared more equitably among available routers.
- **Multiple VRRP groups**—Supports up to 255 VRRP groups on a router physical interface if the platform supports multiple MAC addresses. Multiple VRRP groups enable you to implement redundancy and load sharing in your LAN topology.
- **Multiple IP Addresses**—Allows you to manage multiple IP addresses, including secondary IP addresses. If you have multiple subnets that are configured on an Ethernet interface, you can configure VRRP on each subnet.
- **Preemption**—Enables you to preempt a backup router that has taken over for a failing primary with a higher priority backup router that has become available.
- **Advertisement Protocol**—Uses a dedicated Internet Assigned Numbers Authority (IANA) standard multicast address (224.0.0.18) for VRRP advertisements. This addressing scheme minimizes the number of routers that must service the multicasts and allows test equipment to accurately identify VRRP packets on a segment. IANA has assigned the IP protocol number 112 to VRRP.
- **VRRP Tracking**—Ensures that the best VRRP router is the primary for the group by altering VRRP priorities based on interface states.

Multiple VRRP Groups

You can configure up to 255 VRRP groups on a physical interface. The actual number of VRRP groups that a router interface can support depends on the following factors:

- Router processing capability
- Router memory capability

In a topology where multiple VRRP groups are configured on a router interface, the interface can act as a primary for one VRRP group and as a backup for one or more other VRRP groups.

The following figure shows a LAN topology in which VRRP is configured so that Routers A and B share the traffic to and from clients 1—4. Routers A and B act as backups to each other if either router fails.

Figure 24: Load Sharing and Redundancy VRRP Topology

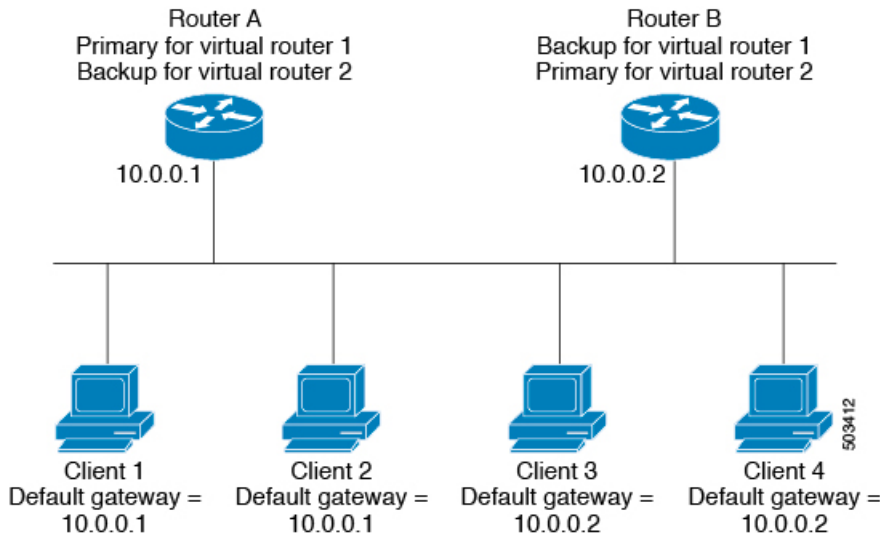

This topology contains two virtual IP addresses for two VRRP groups that overlap. For VRRP group 1, Router A is the owner of IP address 10.0.0.1 and is the primary. Router B is the backup to router A. Clients 1 and 2 are configured with the default gateway IP address of 10.0.0.1.

For VRRP group 2, Router B is the owner of IP address 10.0.0.2 and is the primary. Router A is the backup to router B. Clients 3 and 4 are configured with the default gateway IP address of 10.0.0.2.

VRRP Router Priority and Preemption

An important aspect of the VRRP redundancy scheme is the VRRP router priority because the priority determines the role that each VRRP router plays and what happens if the primary router fails.

If a VRRP router owns the virtual IP address and the IP address of the physical interface, this router functions as the primary. The priority of the primary is 255.

Priority also determines if a VRRP router functions as a backup router and the order of ascendancy to becoming a primary if the primary fails.

For example, if router A, the primary in a LAN topology fails, VRRP must determine if backups B or C should take over. If you configure router B with priority 101 and router C with the default priority of 100, VRRP selects router B to become the primary because it has the higher priority. If you configure routers B and C with the default priority of 100, VRRP selects the backup with the higher IP address to become the primary.

VRRP uses preemption to determine what happens after a VRRP backup router becomes the primary. With preemption enabled by default, VRRP switches to a backup if that backup comes online with a priority higher than the new primary. For example, if Router A is the primary and fails, VRRP selects Router B (next in order of priority). If Router C comes online with a higher priority than Router B, VRRP selects Router C as the new primary, although Router B has not failed.

If you disable preemption, VRRP will only switch if the original primary recovers or the new primary fails.

VRRP Advertisements

The VRRP primary sends VRRP advertisements to other VRRP routers in the same group. The advertisements communicate the priority and state of the primary. Cisco NX-OS encapsulates the VRRP advertisements in IP packets and sends them to the IP multicast address assigned to the VRRP group. Cisco NX-OS sends the advertisements once every second by default, but you can configure a different advertisement interval.

VRRP Authentication

VRRP supports the following authentication mechanisms:

- No authentication
- Plain text authentication

VRRP rejects packets in any of the following cases:

- The authentication schemes differ on the router and in the incoming packet.
- Text authentication strings differ on the router and in the incoming packet.

VRRP Tracking

VRRP supports the following two options for tracking:

- Native interface tracking—Tracks the state of an interface and uses that state to determine the priority of the VRRP router in a VRRP group. The tracked state is down if the interface is down or if the interface does not have a primary IP address.
- Object tracking—Tracks the state of a configured object and uses that state to determine the priority of the VRRP router in a VRRP group. See [Configuring Object Tracking](#) for more information on object tracking.

If the tracked state (interface or object) goes down, VRRP updates the priority based on what you configure the new priority to be for the tracked state. When the tracked state comes up, VRRP restores the original priority for the virtual router group.

For example, you may want to lower the priority of a VRRP group member if its uplink to the network goes down so another group member can take over as primary for the VRRP group. See the [Configuring VRRP Interface State Tracking](#) section for more information.



Note VRRP does not support Layer 2 interface tracking.

Virtualization Support

VRRP supports Virtual Routing and Forwarding instances (VRFs). By default, Cisco NX-OS places you in the default VRF unless you specifically configure another VRF.

If you change the VRF membership of an interface, Cisco NX-OS removes all Layer 3 configuration, including VRRP.

Guidelines and Limitations for VRRP

VRRP has the following configuration guidelines and limitations:

- You cannot configure VRRP on the management interface.
- When VRRP is enabled, you should replicate the VRRP configuration across switches in your network.
- We recommend that you do not configure more than one first-hop redundancy protocol on the same interface.
- You must configure an IP address for the interface that you configure VRRP on and enable that interface before VRRP becomes active.
- Cisco NX-OS removes all Layer 3 configurations on an interface when you change the interface VRF membership, port channel membership, or when you change the port mode to Layer 2.
- When you configure VRRP to track a Layer 2 interface, you must shut down the Layer 2 interface and reenble the interface to update the VRRP priority to reflect the state of the Layer 2 interface.

Default Settings for VRRP

Table below lists the default settings for VRRP parameters.

Table 20: Default VRRP Parameters

Parameters	Default
advertisement interval	1 seconds
authentication	no authentication
preemption	enabled
priority	100
VRRP feature	disabled

Configuring VRRP



Note If you are familiar with the Cisco IOS CLI, be aware that the Cisco NX-OS commands for this feature might differ from the Cisco IOS commands that you would use.

Enabling the VRRP Feature

You must globally enable the VRRP feature before you can configure and enable any VRRP groups.

To enable the VRRP feature, use the following command in global configuration mode:

Command	Purpose
feature vrrp Example : switch(config)# feature vrrp	Enables VRRP.

To disable the VRRP feature and remove all associated configuration, use the following command in global configuration mode:

Command	Purpose
no feature vrrp Example : switch(config)# no feature vrrp	Disables the VRRP feature.

Configuring VRRP Groups

You can create a VRRP group, assign the virtual IP address, and enable the group.

You can configure one virtual IPv4 address for a VRRP group. By default, the primary VRRP router drops the packets addressed directly to the virtual IP address because the VRRP primary is only intended as a next-hop router to forward packets. Some applications require that Cisco NX-OS accept packets that are addressed to the virtual router IP. Use the secondary option to the virtual IP address to accept these packets when the local router is the VRRP primary.

Once you have configured the VRRP group, you must explicitly enable the group before it becomes active.

Before you begin

Ensure that you configure an IP address on the interface (see the [Configuring IPv4 Addressing](#) section).

SUMMARY STEPS

1. **configure terminal**
2. **interface** *interface -type slot/port*
3. **no switchport**
4. **vrrp** *number*
5. **address** *ip-address* [**secondary**]
6. **no shutdown**
7. (Optional) **show vrrp**
8. (Optional) **copy running-config startup-config**

DETAILED STEPS

Procedure

	Command or Action	Purpose
Step 1	configure terminal Example: switch# configure terminal switch(config)#	Enters configuration mode.
Step 2	interface interface -type slot/port Example: switch(config)# switch(config-if)# interface ethernet 2/1	Enters interface configuration mode.
Step 3	no switchport Example: switch(config-if)# no switchport	Configures the interface as a Layer 3 routed interface.
Step 4	vrrp number Example: switch(config-if)# vrrp 250 switch(config-if-vrrp)#	Creates a virtual router group. The range is from 1—255.
Step 5	address ip-address [secondary] Example: switch(config-if-vrrp)# address 192.0.2.8	Configures the virtual IPv4 address for the specified VRRP group. This address should be in the same subnet as the IPv4 address of the interface. Use the secondary option only if applications require that VRRP routers accept the packets sent to the virtual router's IP address and deliver to applications.
Step 6	no shutdown Example: switch(config-if-vrrp)# no shutdown switch(config-if-vrrp)#	Enables the VRRP group. Disabled by default.
Step 7	(Optional) show vrrp Example: switch(config-if-vrrp)# show vrrp	Displays VRRP information.
Step 8	(Optional) copy running-config startup-config Example: switch(config-if-vrrp)# copy running-config startup-config	Saves this configuration change.

Configuring VRRP Priority

The valid priority range for a virtual router is 1–254 (1 is the lowest priority and 254 is the highest). The default priority value for backups is 100. For switches whose interface IP address is the same as the primary virtual IP address (the primary), the default value is 255.

Before you begin

Ensure that you have enabled the VRRP feature (see the [Configuring VRRP](#) section).

Ensure that you have configured an IP address on the interface (see the [Configuring IPv4 Addressing](#) section).

SUMMARY STEPS

1. **configure terminal**
2. **interface** *interface -type slot/port*
3. **no switchport**
4. **vrrp** *number*
5. **shutdown**
6. **priority** *level* [**forwarding-threshold** *lower lower-value upper upper-value*]
7. **no shutdown**
8. (Optional) **show vrrp**
9. (Optional) **copy running-config startup-config**

DETAILED STEPS

Procedure

	Command or Action	Purpose
Step 1	configure terminal Example: <pre>switch# configure terminal switch(config)#</pre>	Enters configuration mode.
Step 2	interface <i>interface -type slot/port</i> Example: <pre>switch(config)# switch(config-if)# interface ethernet 2/1</pre>	Enters interface configuration mode.
Step 3	no switchport Example: <pre>switch(config-if)# no switchport</pre>	Configures the interface as a Layer 3 routed interface.
Step 4	vrrp <i>number</i> Example: <pre>switch(config-if)# vrrp 250 switch(config-if-vrrp)#</pre>	Creates a virtual router group. The range is 1–255.

	Command or Action	Purpose
Step 5	shutdown Example: switch(config-if-vrrp)# shutdown switch(config-if-vrrp)#	Disables the VRRP group. Disabled by default.
Step 6	priority level [forwarding-threshold lower lower-value upper upper-value] Example: switch(config-if-vrrp)# priority 60 forwarding-threshold lower 40 upper 50	Sets the priority level used to select the active router in a VRRP group. The <i>level</i> range is 1–254. The default is 100 for backups and 255 for a primary that has an interface IP address equal to the virtual IP address.
Step 7	no shutdown Example: switch(config-if-vrrp)# no shutdown switch(config-if-vrrp)#	Enables the VRRP group. Disabled by default.
Step 8	(Optional) show vrrp Example: switch(config-if-vrrp)# show vrrp	Displays VRRP information.
Step 9	(Optional) copy running-config startup-config Example: switch(config-if-vrrp)# copy running-config startup-config	Saves this configuration change.

Configuring VRRP Authentication

You can configure simple text authentication for a VRRP group.

Before you begin

Ensure that the authentication configuration is identical for all VRRP switches in the network.

Ensure that you have enabled the VRRP feature (see the [Configuring VRRP](#) section).

Ensure that you have configured an IP address on the interface (see the [Configuring IPv4 Addressing](#) section).

SUMMARY STEPS

1. **configure terminal**
2. **interface** *interface -type slot/port*
3. **no switchport**
4. **vrrp** *number*
5. **shutdown**
6. **authentication text** *password*
7. **no shutdown**
8. (Optional) **show vrrp**

9. (Optional) copy running-config startup-config

DETAILED STEPS

Procedure

	Command or Action	Purpose
Step 1	configure terminal Example: switch# configure terminal switch(config)#	Enters configuration mode.
Step 2	interface interface -type slot/port Example: switch(config)# switch(config-if)# interface ethernet 2/1	Enters interface configuration mode.
Step 3	no switchport Example: switch(config-if)# no switchport	Configures the interface as a Layer 3 routed interface.
Step 4	vrrp number Example: switch(config-if)# vrrp 250 switch(config-if-vrrp)#	Creates a virtual router group. The range is from 1 to 255.
Step 5	shutdown Example: switch(config-if-vrrp)# shutdown switch(config-if-vrrp)#	Disables the VRRP group. Disabled by default.
Step 6	authentication text password Example: switch(config-if-vrrp)# authentication text cisco123	Assigns the simple text authentication option and specifies the keyname password. The keyname range is from 1 to 255 characters. We recommend that you use at least 16 characters. The text password is up to eight alphanumeric characters.
Step 7	no shutdown Example: switch(config-if-vrrp)# no shutdown switch(config-if-vrrp)#	Enables the VRRP group. Disabled by default.
Step 8	(Optional) show vrrp Example: switch(config-if-vrrp)# show vrrp	Displays VRRP information.
Step 9	(Optional) copy running-config startup-config Example:	Saves this configuration change.

	Command or Action	Purpose
	<code>switch(config-if-vrrp)# copy running-config startup-config</code>	

Example

Configuring Time Intervals for Advertisement Packets

You can configure the time intervals for advertisement packets.

Before you begin

Ensure that you have enabled the VRRP feature (see the [Configuring VRRP](#) section).

Ensure that you have configured an IP address on the interface (see the [Configuring IPv4 Addressing](#) section).

SUMMARY STEPS

1. **configure terminal**
2. **interface** *interface -type slot/port*
3. **no switchport**
4. **vrrp** *number*
5. **shutdown**
6. **advertisement-interval** *seconds*
7. **no shutdown**
8. (Optional) **show vrrp**
9. (Optional) **copy running-config startup-config**

DETAILED STEPS

Procedure

	Command or Action	Purpose
Step 1	configure terminal Example: <code>switch# configure terminal</code> <code>switch(config)#</code>	Enters configuration mode.
Step 2	interface <i>interface -type slot/port</i> Example: <code>switch(config)#</code> <code>switch(config-if)# interface ethernet 2/1</code>	Enters interface configuration mode.
Step 3	no switchport Example: <code>switch(config-if)# no switchport</code>	Configures the interface as a Layer 3 routed interface.

	Command or Action	Purpose
Step 4	vrrp number Example: switch(config-if)# vrrp 250 switch(config-if-vrrp)#	Creates a virtual router group. The range is from 1 to 255.
Step 5	shutdown Example: switch(config-if-vrrp)# shutdown switch(config-if-vrrp)#	Disables the VRRP group. Disabled by default.
Step 6	advertisement-interval seconds Example: switch(config-if-vrrp)# advertisement-interval 15	Sets the interval time in seconds between sending advertisement frames. The range is from 1 to 254. The default is 1 second.
Step 7	no shutdown Example: switch(config-if-vrrp)# no shutdown switch(config-if-vrrp)#	Enables the VRRP group. Disabled by default.
Step 8	(Optional) show vrrp Example: switch(config-if-vrrp)# show vrrp	Displays VRRP information.
Step 9	(Optional) copy running-config startup-config Example: switch(config-if-vrrp)# copy running-config startup-config	Saves this configuration change.

Example

Disabling Preemption

You can disable preemption for a VRRP group member. If you disable preemption, a higher-priority backup router will not take over for a lower-priority primary router. Preemption is enabled by default.

Before you begin

Ensure that you have enabled the VRRP feature (see the [Configuring VRRP](#) section).

Ensure that you have configured an IP address on the interface (see the [Configuring IPv4 Addressing](#) section).

SUMMARY STEPS

1. **configure terminal**
2. **interface interface -type slot/port**

3. **no switchport**
4. **vrrp number**
5. **shutdown**
6. **no preempt**
7. **no shutdown**
8. (Optional) **show vrrp**
9. (Optional) **copy running-config startup-config**

DETAILED STEPS

Procedure

	Command or Action	Purpose
Step 1	configure terminal Example: <pre>switch# configure terminal switch(config)#</pre>	Enters configuration mode.
Step 2	interface interface -type slot/port Example: <pre>switch(config)# switch(config-if)# interface ethernet 2/1</pre>	Enters interface configuration mode.
Step 3	no switchport Example: <pre>switch(config-if)# no switchport</pre>	Configures the interface as a Layer 3 routed interface.
Step 4	vrrp number Example: <pre>switch(config-if)# vrrp 250 switch(config-if-vrrp)#</pre>	Creates a virtual router group. The range is 1–255.
Step 5	shutdown Example: <pre>switch(config-if-vrrp)# shutdown switch(config-if-vrrp)#</pre>	Disables the VRRP group. Disabled by default.
Step 6	no preempt Example: <pre>switch(config-if-vrrp)# no preempt</pre>	Disables the preempt option and allows the primary to remain when a higher-priority backup appears.
Step 7	no shutdown Example: <pre>switch(config-if-vrrp)# no shutdown switch(config-if-vrrp)#</pre>	Enables the VRRP group. Disabled by default.

	Command or Action	Purpose
Step 8	(Optional) show vrrp Example: switch(config-if-vrrp)# show vrrp	Displays VRRP information.
Step 9	(Optional) copy running-config startup-config Example: switch(config-if-vrrp)# copy running-config startup-config	Saves this configuration change.

Configuring VRRP Interface State Tracking

Interface state tracking changes the priority of the virtual router based on the state of another interface in the switch. When the tracked interface goes down or the IP address is removed, Cisco NX-OS assigns the tracking priority value to the virtual router. When the tracked interface comes up and an IP address is configured on this interface, Cisco NX-OS restores the configured priority to the virtual router (see the [Configuring VRRP Priority](#) section).



Note For interface state tracking to function, you must enable preemption on the interface.



Note VRRP does not support Layer 2 interface tracking.

Before you begin

Ensure that you have enabled the VRRP feature (see the [Configuring VRRP](#) section).

Ensure that you have configured an IP address on the interface (see the [Configuring IPv4 Addressing](#) section).

Be sure the virtual router is enabled (see the [Configuring VRRP Groups](#) section).

SUMMARY STEPS

1. **configure terminal**
2. **interface** *interface -type slot/port*
3. **no switchport**
4. **vrrp** *number*
5. **shutdown**
6. **track interface type** *number priority value*
7. **no shutdown**
8. (Optional) **show vrrp**
9. (Optional) **copy running-config startup-config**

DETAILED STEPS

Procedure

	Command or Action	Purpose
Step 1	configure terminal Example: switch# configure terminal switch(config)#	Enters configuration mode.
Step 2	interface interface -type slot/port Example: switch(config)# switch(config-if)# interface ethernet 2/1	Enters interface configuration mode.
Step 3	no switchport Example: switch(config-if)# no switchport	Configures the interface as a Layer 3 routed interface.
Step 4	vrrp number Example: switch(config-if)# vrrp 250 switch(config-if-vrrp)#	Creates a virtual router group. The range is from 1 to 255.
Step 5	shutdown Example: switch(config-if-vrrp)# shutdown switch(config-if-vrrp)#	Disables the VRRP group. Disabled by default.
Step 6	track interface type number priority value Example: switch(config-if-vrrp)# track interface ethernet 2/10 priority 254	Enables interface priority tracking for a VRRP group. The priority range is from 1 to 254.
Step 7	no shutdown Example: switch(config-if-vrrp)# no shutdown switch(config-if-vrrp)#	Enables the VRRP group. Disabled by default.
Step 8	(Optional) show vrrp Example: switch(config-if-vrrp)# show vrrp	Displays VRRP information.
Step 9	(Optional) copy running-config startup-config Example: switch(config-if-vrrp)# copy running-config startup-config	Saves this configuration change.

Verifying the VRRP Configuration

To display the VRRP configuration information, perform one of the following tasks:

Command	Purpose
show vrrp	Displays the VRRP status for all groups.
<i>show vrrp vr group-number</i>	Displays the VRRP status for a VRRP group.
show vrrp interface <i>interface-type port vr number</i>	Displays the virtual router configuration for an interface.

Displaying VRRP Statistics

To display VRRP statistics, use the following commands:

Command	Purpose
show vrrp statistics interface <i>interface-type port vr number</i>	Displays the virtual router information.
show vrrp statistics	Displays the VRRP statistics.

Use the **clear vrrp vr** command to clear the IPv4 VRRP statistics for a specified interface.

Configuration Examples for VRRP

In this example, Router A and Router B each belong to three VRRP groups. In the configuration, each group has the following properties:

- Group 1:
 - Virtual IP address is 10.1.0.10.
 - Router A will become the primary for this group with priority 120.
 - Advertising interval is 3 seconds.
 - Preemption is enabled.
- Group 5:
 - Router B will become the primary for this group with priority 200.
 - Advertising interval is 30 seconds.
 - Preemption is enabled.
- Group 100:
 - Router A will become the primary for this group first because it has a higher IP address (10.1.0.2).

- Advertising interval is the default 1 second.
- Preemption is disabled.

Router A

```
interface ethernet 1/0
no switchport

ip address 10.1.0.2/16
no shutdown
vrrp 1
priority 120
authentication text cisco
advertisement-interval 3
address 10.1.0.10
no shutdown
vrrp 5
priority 100
advertisement-interval 30
address 10.1.0.50
no shutdown
vrrp 100
no preempt
address 10.1.0.100
no shutdown
```

Router B

```
interface ethernet 1/0
no switchport

ip address 10.2.0.1/2
no shutdown
vrrp 1
priority 100
authentication text cisco
advertisement-interval 3
address 10.2.0.10
no shutdown

vrrp 5
priority 200
advertisement-interval 30
address 10.2.0.50
no shutdown
vrrp 100
no preempt
address 10.2.0.100
no shutdown
```

Additional References

For additional information related to implementing VRRP, see the following sections:

- [Related Documents](#)

Related Documents

Related Topic	Document Title
Configuring the Hot Standby Routing Protocol	Configuring HSRP
VRRP CLI commands	Cisco Nexus 3000 Series Command Reference



CHAPTER 18

Configuring Object Tracking

This chapter describes how to configure object tracking on Cisco NX-OS switches.

This chapter includes the following sections:

- [Information About Object Tracking, on page 343](#)
- [Guidelines and Limitations for Object Tracking, on page 344](#)
- [Default Settings for Object Tracking, on page 345](#)
- [Configuring Object Tracking, on page 345](#)
- [Verifying the Object Tracking Configuration, on page 355](#)
- [Configuration Examples for Object Tracking, on page 355](#)
- [Additional References, on page 355](#)

Information About Object Tracking

Object tracking allows you to track specific objects on the switch, such as the interface line protocol state, IP routing, and route reachability, and to take action when the tracked object's state changes. This feature allows you to increase the availability of the network and shorten recovery time if an object state goes down.

Object Tracking Overview

The object tracking feature allows you to create a tracked object that multiple clients can use to modify the client behavior when a tracked object changes. Several clients register their interest with the tracking process, track the same object, and take different actions when the object state changes.

Clients include the following features:

- Hot Standby Redundancy Protocol (HSRP)
- Virtual Router Redundancy Protocol (VRRP)
- Embedded Event Manager (EEM)

The object tracking monitors the status of the tracked objects and communicates any changes made to interested clients. Each tracked object is identified by a unique number that clients can use to configure the action to take when a tracked object changes state.

Cisco NX-OS tracks the following object types:

- Interface line protocol state—Tracks whether the line protocol state is up or down.

- Interface IP routing state—Tracks whether the interface has an IPv4 address and if IPv4 routing is enabled and active.
- IP route reachability—Tracks whether an IPv4 route exists and is reachable from the local switch.

For example, you can configure HSRP to track the line protocol of the interface that connects one of the redundant routers to the rest of the network. If that link protocol goes down, you can modify the priority of the affected HSRP router.

Object Track List

An object track list allows you to track the combined states of multiple objects. Object track lists support the following capabilities:

- Boolean "and" function—Each object defined within the track list must be in an up state so that the track list object can become up.
- Boolean "or" function—At least one object defined within the track list must be in an up state so that the tracked object can become up.
- Threshold percentage—The percentage of up objects in the tracked list must be greater than the configured up threshold for the tracked list to be in the up state. If the percentage of down objects in the tracked list is above the configured track list down threshold, the tracked list is marked as down.
- Threshold weight—Assign a weight value to each object in the tracked list, and a weight threshold for the track list. If the combined weights of all up objects exceeds the track list weight up threshold, the track list is in an up state. If the combined weights of all the down objects exceeds the track list weight down threshold, the track list is in the down state.

See the [Configuring an Object Track List with a Boolean Expression](#) section for more information on track lists.

Virtualization Support

Object tracking supports Virtual Routing and Forwarding (VRF) instances. By default, Cisco NX-OS places you in the default VRF unless you specifically configure another VRF. By default, Cisco NX-OS tracks the route reachability state of objects in the default VRF. If you want to track objects in another VRF, you must configure the object to be a member of that VRF (see the [Configuring Object Tracking for a Nondefault VRF](#) section).

Guidelines and Limitations for Object Tracking

Object tracking has the following configuration guidelines and limitations:

- Supports up to 500 tracked objects.
- Supports Ethernet, subinterfaces, tunnels, port channels, loopback interfaces, and VLAN interfaces.
- Supports one tracked object per HSRP group.

Default Settings for Object Tracking

Table below lists the default settings for object tracking parameters.

Table 21: Default Object Tracking Parameters

Parameters	Default
Tracked Object VRF	Member of default VRF

Configuring Object Tracking



Note If you are familiar with the Cisco IOS CLI, be aware that the Cisco NX-OS commands for this feature might differ from the Cisco IOS commands that you would use.

Configuring Object Tracking for an Interface

You can configure Cisco NX-OS to track the line protocol or IPv4 routing state of an interface.

SUMMARY STEPS

1. **configure terminal**
2. **track *object-id* interface *interface-type number* { ip routing | line-protocol }**
3. (Optional) **show track [*object-id*]**
4. (Optional) **copy running-config startup-config**

DETAILED STEPS

Procedure

	Command or Action	Purpose
Step 1	configure terminal Example: <pre>switch# configure terminal switch(config)#</pre>	Enters configuration mode.
Step 2	track <i>object-id</i> interface <i>interface-type number</i> { ip routing line-protocol } Example: <pre>switch(config)# track 1 interface ethernet 1/2 line-protocol switch(config-track#</pre>	Creates a tracked object for an interface and enters tracking configuration mode. The <i>object-id</i> range is from 1 to 500.

	Command or Action	Purpose
Step 3	(Optional) show track [<i>object-id</i>] Example: switch(config-track)# show track 1	Displays object tracking information
Step 4	(Optional) copy running-config startup-config Example: switch(config-track)# copy running-config startup-config	Saves this configuration change.

Example

This example shows how to configure object tracking for the line protocol state on Ethernet 1/2:

```
switch# configure terminal
switch(config)# track 1 interface ethernet 1/2 line-protocol
switch(config-track)# copy running-config startup-config
```

This example shows how to configure object tracking for the IPv4 routing state on Ethernet 1/2:

```
switch# configure terminal
switch(config)# track 2 interface ethernet 1/2 ip routing
switch(config-track)# copy running-config startup-config
```

Configuring Object Tracking for Route Reachability

You can configure Cisco NX-OS to track the existence and reachability of an IP route.

SUMMARY STEPS

1. **configure terminal**
2. **track** *object-id* **ip route** *prefix/length* **reachability**
3. (Optional) **show track** [*object-id*]
4. (Optional) **copy running-config startup-config**

DETAILED STEPS**Procedure**

	Command or Action	Purpose
Step 1	configure terminal Example: switch# configure terminal switch(config)#	Enters configuration mode.
Step 2	track <i>object-id</i> ip route <i>prefix/length</i> reachability Example:	Creates a tracked object for a route and enters tracking configuration mode. The <i>object-id</i> range is from 1 to 500.

	Command or Action	Purpose
	<pre>switch(config)# track 2 ip route 192.0.2.0/8 reachability switch(config-track)#</pre>	The prefix format for IP is A.B.C.D/length, where the length range is from 1 to 32.
Step 3	(Optional) show track [<i>object-id</i>] Example: <pre>switch(config-track)# show track 1</pre>	Displays object tracking information
Step 4	(Optional) copy running-config startup-config Example: <pre>switch(config-track)# copy running-config startup-config</pre>	Saves this configuration change.

Example

This example shows how to configure object tracking for an IPv4 route in the default VRF:

```
switch# configure terminal
switch(config)# track 4 ip route 192.0.2.0/8 reachability
switch(config-track)# copy running-config startup-config
```

Configuring an Object Track List with a Boolean Expression

You can configure an object track list that contains multiple tracked objects. A tracked list contains one or more objects. The Boolean expression enables two types of calculation by using either "and" or "or" operators. For example, when tracking two interfaces using the "and" operator, up means that both interfaces are up, and down means that either interface is down.

SUMMARY STEPS

1. **configure terminal**
2. **track** *track-number* **list boolean** { **and** | **or** }
3. **object** *object-id* [**not**]
4. (Optional) **show track**
5. (Optional) **copy running-config startup-config**

DETAILED STEPS

Procedure

	Command or Action	Purpose
Step 1	configure terminal Example: <pre>switch# configure terminal switch(config)#</pre>	Enters configuration mode.

	Command or Action	Purpose
Step 2	<p>track <i>track-number</i> list boolean { and or }</p> <p>Example:</p> <pre>switch(config)# track 1 list boolean and switch(config-track)#</pre>	<p>Configures a tracked list object and enters tracking configuration mode. Specifies that the state of the tracked list is based on a Boolean calculation. The keywords are as follows:</p> <ul style="list-style-type: none"> • and —Specifies that the list is up if all objects are up, or down if one or more objects are down. For example, when tracking two interfaces, up means that both interfaces are up, and down means that either interface is down. • or —Specifies that the list is up if at least one object is up. For example, when tracking two interfaces, up means that either interface is up, and down means that both interfaces are down. <p>The <i>track-number</i> range is from 1 to 500.</p>
Step 3	<p>object <i>object-id</i> [not]</p> <p>Example:</p> <pre>switch(config-track)# object 10</pre>	<p>Adds a tracked object to the track list. The <i>object-id</i> range is from 1 to 500. The not keyword optionally negates the tracked object state.</p> <p>Note The example means that when object 10 is up, the tracked list detects object 10 as down.</p>
Step 4	<p>(Optional) show track</p> <p>Example:</p> <pre>switch(config-track)# show track</pre>	Displays object tracking information
Step 5	<p>(Optional) copy running-config startup-config</p> <p>Example:</p> <pre>switch(config-track)# copy running-config startup-config</pre>	Saves this configuration change.

Example

This example shows how to configure a track list with multiple objects as a Boolean “and”:

```
switch# configure terminal
switch(config)# track 1 list boolean and
switch(config-track)# object 10
switch(config-track)# object 20 not
```

Configuring an Object Track List with a Percentage Threshold

You can configure an object track list that contains a percentage threshold. A tracked list contains one or more objects. The percentage of up objects must exceed the configured track list up percent threshold before the track list is in an up state. For example, if the tracked list has three objects, and you configure an up threshold

of 60 percent, two of the objects must be in the up state (66 percent of all objects) for the track list to be in the up state.

SUMMARY STEPS

1. **configure terminal**
2. **track *track-number* list threshold percentage**
3. **threshold percentage up *up-value* down *down-value***
4. (Optional) **object [*object-id*]**
5. (Optional) **show track**
6. (Optional) **copy running-config startup-config**

DETAILED STEPS

Procedure

	Command or Action	Purpose
Step 1	configure terminal Example: switch# configure terminal switch(config)#	Enters configuration mode.
Step 2	track <i>track-number</i> list threshold percentage Example: switch(config)# track 1 list threshold percentage switch(config-track)#	Configures a tracked list object and enters tracking configuration mode. Specifies that the state of the tracked list is based on a configured threshold percent. The <i>track-number</i> range is from 1 to 500.
Step 3	threshold percentage up <i>up-value</i> down <i>down-value</i> Example: switch(config-track)# threshold percentage up 70 down 30	Configures the threshold percent for the tracked list. The range from 0 to 100 percent.
Step 4	(Optional) object [<i>object-id</i>] Example: switch(config-track)# object 10	Adds a tracked object to the track list. The <i>object-id</i> range is from 1 to 500.
Step 5	(Optional) show track Example: switch(config-track)# show track	Displays object tracking information
Step 6	(Optional) copy running-config startup-config Example: switch(config-track)# copy running-config startup-config	Saves this configuration change.

Example

This example shows how to configure a track list with an up threshold of 70 percent and a down threshold of 30 percent:

```
switch# configure terminal
switch(config)# track 1 list threshold percentage
switch(config-track)# threshold percentage up 70 down 30
switch(config-track)# object 10
switch(config-track)# object 20
switch(config-track)# object 30
```

Configuring an Object Track List with a Weight Threshold

You can configure an object track list that contains a weight threshold. A tracked list contains one or more objects. The combined weight of up objects must exceed the configured track list up weight threshold before the track list is in an up state. For example, if the tracked list has three objects with the default weight of 10 each, and you configure an up threshold of 15, two of the objects must be in the up state (combined weight of 20) for the track list to be in the up state.

SUMMARY STEPS

1. **configure terminal**
2. **track *track-number* list threshold weight**
3. **threshold weight up *up-value* down *down-value***
4. **object *object-id* weight *value***
5. (Optional) **show track**
6. (Optional) **copy running-config startup-config**

DETAILED STEPS**Procedure**

	Command or Action	Purpose
Step 1	configure terminal Example: <pre>switch# configure terminal switch(config)#</pre>	Enters configuration mode.
Step 2	track <i>track-number</i> list threshold weight Example: <pre>switch(config)# track 1 list threshold weight switch(config-track#</pre>	Configures a tracked list object and enters tracking configuration mode. Specifies that the state of the tracked list is based on a configured threshold weight. The <i>track-number</i> range is from 1 to 500.
Step 3	threshold weight up <i>up-value</i> down <i>down-value</i> Example: <pre>switch(config-track)# threshold weight up 30 down 10</pre>	Configures the threshold weight for the tracked list. The range from 1 to 255.

	Command or Action	Purpose
Step 4	object <i>object-id</i> weight <i>value</i> Example: <pre>switch(config-track)# object 10 weight 15</pre>	Adds a tracked object to the track list. The <i>object-id</i> range is from 1 to 500. The <i>value</i> range is from 1 to 255. The default weight value is 10.
Step 5	(Optional) show track Example: <pre>switch(config-track)# show track</pre>	Displays object tracking information
Step 6	(Optional) copy running-config startup-config Example: <pre>switch(config-track)# copy running-config startup-config</pre>	Saves this configuration change.

Example

This example shows how to configure a track list with an up weight threshold of 30 and a down threshold of 10:

```
switch# configure terminal
switch(config)# track 1 list threshold weight
switch(config-track)# threshold weight up 30 down 10
switch(config-track)# object 10 weight 15
switch(config-track)# object 20 weight 15
switch(config-track)# object 30
```

In this example, the track list is up if object 10 and object 20 are up, and the track list goes to the down state if all three objects are down.

Configuring an Object Tracking Delay

You can configure a delay for a tracked object or an object track list that delays when the object or list triggers a stage change. The tracked object or track list starts the delay timer when a state change occurs but does not recognize a state change until the delay timer expires. At that point, Cisco NX-OS checks the object state again and records a state change only if the object or list currently has a changed state. Object tracking ignores any intermediate state changes before the delay timer expires.

For example, for an interface line-protocol tracked object that is in the up state with a 20-second down delay, the delay timer starts when the line protocol goes down. The object is not in the down state unless the line protocol is down 20 seconds later.

You can configure independent up delay and down delay for a tracked object or track list. When you delete the delay, object tracking deletes both the up and down delay.

You can change the delay at any point. If the object or list is already counting down the delay timer from a triggered event, the new delay is computed as the following:

- If the new configuration value is less than the old configuration value, the timer starts with the new value

- If the new configuration value is more than the old configuration value, the timer is calculated as the new configuration value minus the current timer countdown minus the old configuration value.

SUMMARY STEPS

1. **configure terminal**
2. `track object- id { parameters }`
3. **track track-number list** { parameters }
4. **delay** { **up** up-time [**down** down-time] | **down** down-time [**up** up-time] }
5. (Optional) **show track**
6. (Optional) **copy running-config startup-config**

DETAILED STEPS

Procedure

	Command or Action	Purpose
Step 1	configure terminal Example: switch# configure terminal switch(config)#	Enters configuration mode.
Step 2	<code>track object- id { parameters }</code> Example: switch(config)# track 2 ip route 192.0.2.0/8 reachability switch(config-track)#	Creates a tracked object for a route and enters tracking configuration mode. The <i>object-id</i> range is from 1 to 500. The prefix format for IP is A.B.C.D/length, where the length range is from 1 to 32.
Step 3	<code>track track-number list { parameters }</code> Example: switch(config)# track 1 list threshold weight switch(config-track)#	Configures a tracked list object and enters tracking configuration mode. Specifies that the state of the tracked list is based on a configured threshold weight. The <i>track-number</i> range is from 1 to 500.
Step 4	delay { up up-time [down down-time] down down-time [up up-time] } Example: switch(config-track)# delay up 20 down 30	Configures the object delay timers. The range is from 0 to 180 seconds.
Step 5	(Optional) show track Example: switch(config-track)# show track	Displays object tracking information
Step 6	(Optional) copy running-config startup-config Example: switch(config-track)# copy running-config startup-config	Saves this configuration change.

Example

This example shows how to configure object tracking for a route and use delay timers:

```
switch# configure terminal
switch(config)# track 2 ip route 209.165.201.0/8 reachability
switch(config-track)# delay up 20 down 30
switch(config-track)# copy running-config startup-config
```

This example shows how to configure a track list with an up weight threshold of 30 and a down threshold of 10 with delay timers:

```
switch# configure terminal
switch(config)# track 1 list threshold weight
switch(config-track)# threshold weight up 30 down 10
switch(config-track)# object 10 weight 15
switch(config-track)# object 20 weight 15
switch(config-track)# object 30
switch(config-track)# delay up 20 down 30
```

This example shows the delay timer in the show track command output before and after an interface is shut down:

```
switch(config-track)# show track
Track 1
Interface loopback1 Line Protocol
Line Protocol is UP
1 changes, last change 00:00:13
Delay down 10 secs

switch(config-track)# interface loopback 1
switch(config-if)# shutdown
switch(config-if)# show track
Track 1
Interface loopback1 Line Protocol
Line Protocol is delayed DOWN (8 secs remaining)<----- delay timer counting down
1 changes, last change 00:00:22
Delay down 10 secs
```

Configuring Object Tracking for a Nondefault VRF

You can configure Cisco NX-OS to track an object in a specific VRF.

SUMMARY STEPS

1. **configure terminal**
2. **track object-id ip route *prefix/length* reachability**
3. **vrf member *vrf-name***
4. (Optional) **show track [*object-id*]**
5. (Optional) **copy running-config startup-config**

DETAILED STEPS

Procedure

	Command or Action	Purpose
Step 1	configure terminal Example: <pre>switch# configure terminal switch(config)#</pre>	Enters configuration mode.
Step 2	track object-id ip route <i>prefix/length</i> reachability Example: <pre>switch(config)# track 2 ip route 192.0.2.0/8 reachability switch(config-track)#</pre>	Creates a tracked object for a route and enters tracking configuration mode. The <i>object-id</i> range is from 1 to 500. The prefix format for IP is A.B.C.D/length, where the length range is from 1 to 32.
Step 3	vrf member <i>vrf-name</i> Example: <pre>switch(config-track)# vrf member Red</pre>	Configures the VRF to use for tracking the configured object.
Step 4	(Optional) show track [<i>object-id</i>] Example: <pre>switch(config-track)# show track 3</pre>	Displays object tracking information
Step 5	(Optional) copy running-config startup-config Example: <pre>switch(config-track)# copy running-config startup-config</pre>	Saves this configuration change.

Example

This example shows how to configure object tracking for a route and use VRF Red to look up reachability information for this object:

```
switch# configure terminal
switch(config)# track 2 ip route 209.165.201.0/8 reachability
switch(config-track)# vrf member Red
switch(config-track)# copy running-config startup-config
```

This example shows how to modify tracked object 2 to use VRF Blue instead of VRF Red to look up reachability information for this object:

```
switch# configure terminal
switch(config)# track 2
switch(config-track)# vrf member Blue
switch(config-track)# copy running-config startup-config
```

Verifying the Object Tracking Configuration

To display the object tracking configuration information, perform one of the following tasks:

Command	Purpose
<code>show track [<i>object-id</i>] [brief]</code>	Displays the object tracking information for one or more objects.
<code>show track [<i>object-id</i>] interface [brief]</code>	Displays the interface-based object tracking information.
<code>show track [<i>object-id</i>] ip-route [brief]</code>	Displays the IPv4 route-based object tracking information.

Configuration Examples for Object Tracking

This example shows how to configure object tracking for route reachability and use VRF Red to look up reachability information for this route:

```
switch# configure terminal
switch(config)# track 2 ip route 209.165.201.0/8 reachability
switch(config-track)# vrf member Red
switch(config-track)# copy running-config startup-config
```

Additional References

For additional information related to implementing object tracking, see the following sections:

- [Related Documents](#)
- [Standards](#)

Related Documents

Related Topic	Document Title
Object Tracking CLI commands	Cisco Nexus 3000 Series Command Reference
Configuring the Embedded Event Manager	Cisco Nexus 3548 Switch NX-OS System Management Configuration Guide

Standards

Standards	Title
No new or modified standards are supported by this feature, and support for existing standards has not been modified by this feature.	—



APPENDIX **A**

IETF RFCs

This appendix lists the supported IETF RFCs.

- [IETF RFCs, on page 357](#)

IETF RFCs

BGP RFCs

RFCs	Title
RFC 1997	<i>BGP Communities Attribute</i>
RFC 2385	<i>Protection of BGP Sessions via the TCP MD5 Signature Option</i>
RFC 2439	<i>BGP Route Flap Damping</i>
RFC 2519	<i>A Framework for Inter-Domain Route Aggregation</i>
RFC 2858	<i>Multiprotocol Extensions for BGP-4</i>
RFC 3065	<i>Autonomous System Confederations for BGP</i>
RFC 3392	<i>Capabilities Advertisement with BGP-4</i>
RFC 4271	<i>A Border Gateway Protocol 4 (BGP-4)</i>
RFC 4273	<i>Definitions of Managed Objects for BGP-4</i>
RFC 4456	<i>BGP Route Reflection: An Alternative to Full Mesh Internal BGP (IBGP)</i>
RFC 4486	<i>Subcodes for BGP Cease Notification Message</i>
RFC 4893	<i>BGP Support for Four-octet AS Number Space</i>
RFC 5004	<i>Avoid BGP Best Path Transitions from One External to Another</i>
RFC 5549	<i>Advertising IPv4 Network Layer Reachability Information with an IPv6 Next Hop</i>
RFC 7606	<i>Revised Error Handling for BGP Update Messages</i>

RFCs	Title
draft-ietf-idr-bgp4-mib-15.txt	<i>BGP4-MIB</i>

First-Hop Redundancy Protocols RFCs

RFCs	Title
RFC 2281	<i>Hot Standby Redundancy Protocol</i>
RFC 3768	<i>Virtual Router Redundancy Protocol</i>

IP Services RFCs

RFCs	Title
RFC 786	<i>UDP</i>
RFC 791	<i>IP</i>
RFC 792	<i>ICMP</i>
RFC 793	<i>TCP</i>
RFC 826	<i>ARP</i>
RFC 1027	<i>Proxy ARP</i>
RFC 1591	<i>DNS Client</i>
RFC 1812	<i>IPv4 routers</i>

OSPF RFCs

RFCs	Title
RFC 2328	<i>OSPF Version 2</i>
RFC 3101	<i>The OSPF Not-So-Stubby Area (NSSA) Option</i>
RFC 2370	<i>The OSPF Opaque LSA Option</i>
RFC 3137	<i>OSPF Stub Router Advertisement</i>

RIP RFCs

RFCs	Title
RFC 2453	<i>RIP Version 2</i>
RFC 2082	<i>RIP-2 MD5 Authentication</i>

