

Cisco Catalyst SD-WAN and Skyhigh Security Service Edge Integration User Guide

April 2024

Contents

Overview	3
Cisco Catalyst SD-WAN SSE Integration with Skyhigh for Secure Internet Access	4
Sample topology diagram with SD-WAN and Skyhigh network	4
Overview of Configuration Steps	6
Deployment models	20
Skyhigh Web Gateway Configuration Modification Procedure	23
Cisco Catalyst SD-WAN Manager Configuration Modification Procedure	24
For more information	27

Overview

The integration of Cisco Catalyst™ SD-WAN with Skyhigh Security Service Edge (SSE) cloud empowers customers to bolster the security of their branch internet traffic through seamless redirection. By harnessing Cisco® Catalyst SD-WAN Secure Internet Gateway (SIG) templates, the implementation process becomes efficient and straightforward. These templates offer an intuitive workflow for comprehensive end-to-end configuration, encompassing critical features such as Point of Presence (POP) availability, application health checks, weighted load balancing, and data policy enforcement. With this integration, users can effortlessly specify the desired redirection of branch traffic to the Skyhigh SSE. It's worth noting that the integration has undergone rigorous testing and validation within Cisco, ensuring seamless compatibility and reliable performance.

This document serves as a technical and configuration guide for successfully integrating Skyhigh SSE and Cisco Catalyst SD-WAN, utilizing the capabilities provided by Cisco Catalyst SD-WAN Manager Release 20.9 and Cisco IOS® XE SD-WAN WAN Edge Release 17.9. It includes practical examples demonstrating how to provision a new service to integrate Skyhigh SSE and Cisco Catalyst SD-WAN IPsec tunnel using the SIG feature template implementation. IPsec primary and secondary tunnels are established to Skyhigh SSE for Direct Internet Traffic (DIA).

The following Cisco Catalyst SD-WAN and Skyhigh SSE use cases are covered within this document:

- Dual WAN Edge design with one active tunnel per WAN Edge
- Dual WAN Edge design with one active/standby tunnel per WAN Edge
- Dual WAN Edge design with two active/active Equal-Cost Multi-Path Routing (ECMP) tunnel deployment per WAN Edge
- Utilization of centralized data policy for traffic redirection

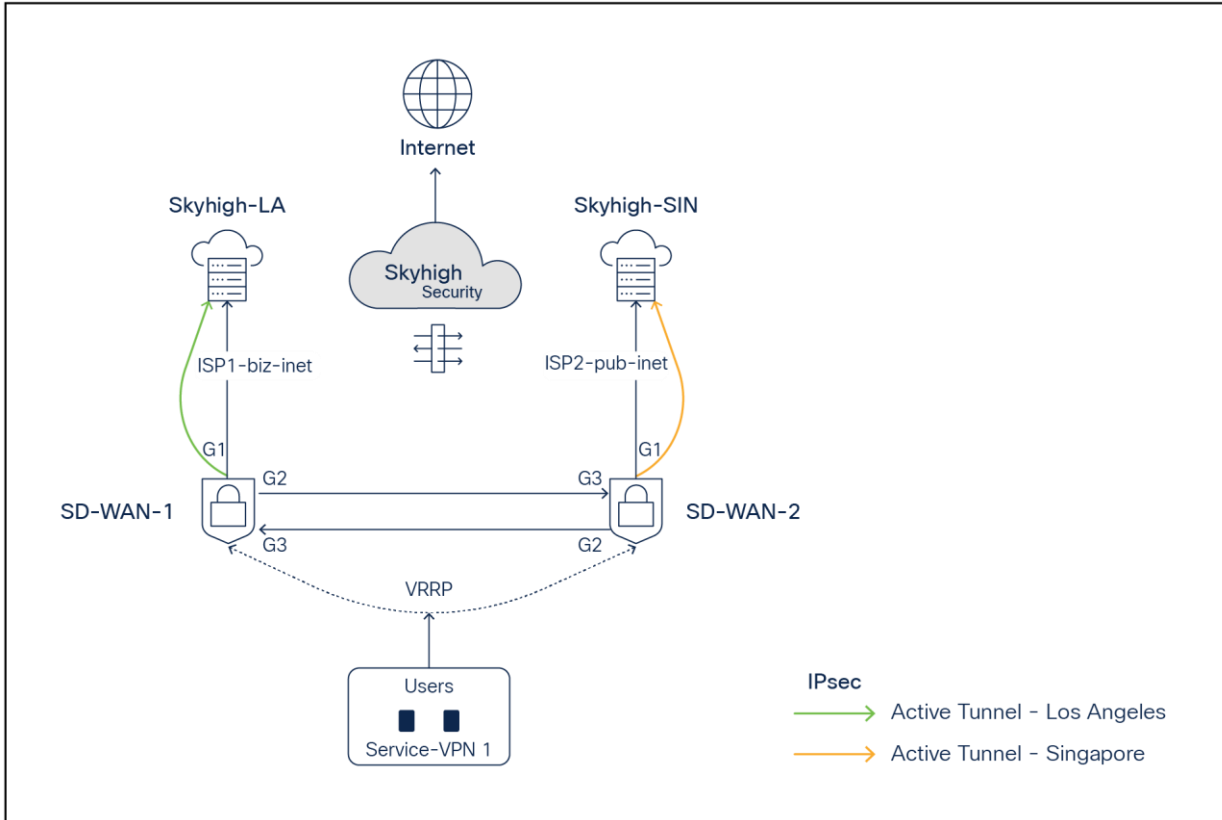

Figure 1.
Cisco Catalyst SD-WAN - Skyhigh network topology with active backup tunnels to Skyhigh POPs

Cisco Catalyst SD-WAN SSE Integration with Skyhigh for Secure Internet Access

Use case

This integration guide serves as a reference for customers who run the Skyhigh SSE solution alongside the Cisco Catalyst SD-WAN solution. It is designed for scenarios where branch users require internet or SaaS application access that needs to be inspected and secured by the Skyhigh SSE solution.

Pre-requisites and Validated Environment

- Skyhigh Security Cloud Version 6.4.2
- Cisco Catalyst SD-WAN Manager Release 20.9, Cisco Catalyst SD-WAN Validator Release 20.9, Cisco Catalyst SD-WAN Controller Release 20.9, Cisco Catalyst SD-WAN C8kv Edge Release 17.9
- Knowledge of Cisco Catalyst SD-WAN configuration and features

Supported Hardware

- ISR 4461, 4451, 4431, 4351, 4331, 4321, 4221X, 4221, CSR, ISRv, and ISR 1K
- Catalyst® 8500L, 8300, 8200, and 8000V

Sample topology diagram with SD-WAN and Skyhigh network

The following tests have been conducted with an emphasis on ensuring redundancy.

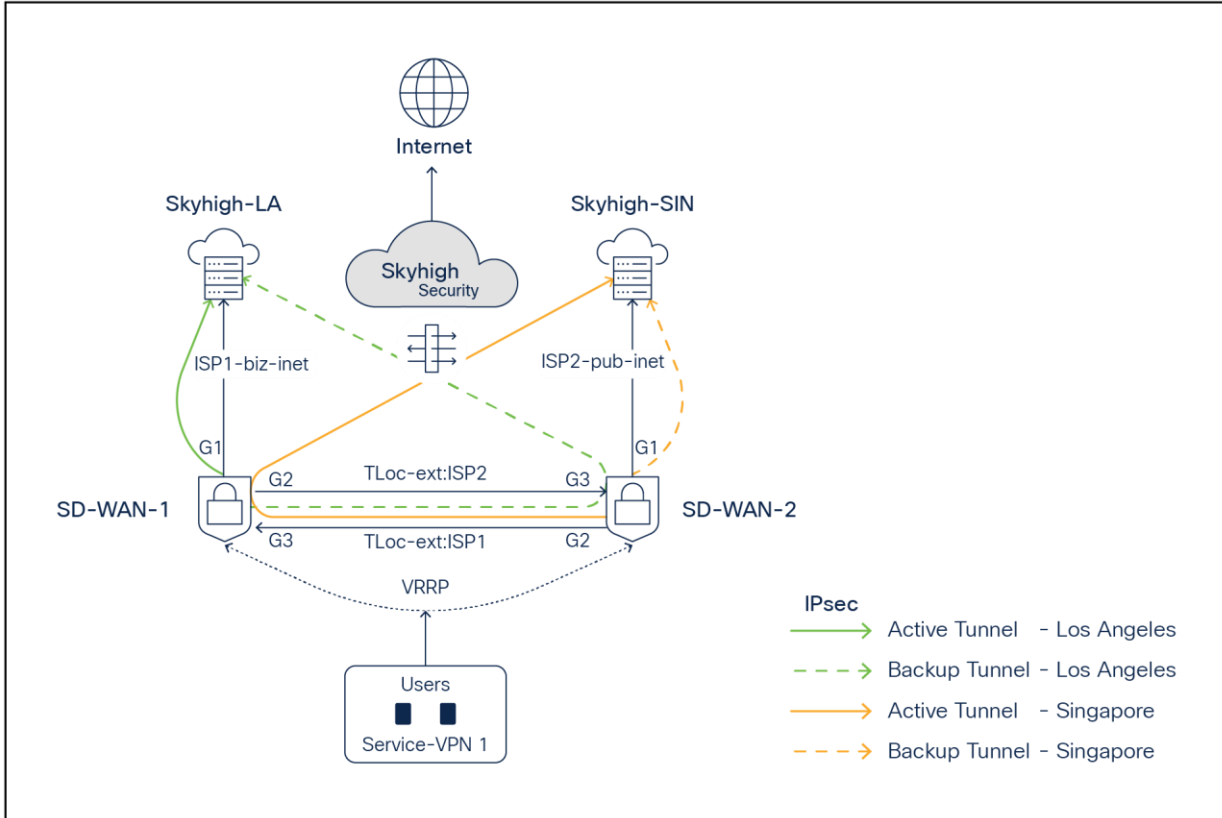

Figure 2.
SD-WAN - Skyhigh network topology with active backup tunnels to Skyhigh POPs

In the above topology, two branch routers, SD-WAN-1 and SD-WAN-2, are connected to Skyhigh SSE Datacenter locations (Los Angeles and Singapore) using redundant ISPs (Biz-internet and public-internet colors). The Transport Locator (TLOC) extension feature has been used to provide cross-ISP connectivity from both routers. The Service VPN can be redundantly configured using Layer 2 protocols including Virtual Router Redundancy Protocol (VRRP) or Layer 3 routing protocols such as Border Gateway Protocol (BGP) or any other supported protocols. The architecture provides redundancy at the tunnel, data center, ISP, and router levels.

Redundancy Connectivity Matrix

In the above diagram, ISP1 is tied with the LA location, and ISP2 is tied with the Singapore location.

Router	ISP-Color	Skyhigh SSE POP
SD-WAN-1	Biz-internet (Gig1)	LA (Active Tunnel)
SD-WAN-1	Public-internet (Gig2) using TLOC extension from SDWAN2	LA (Backup Tunnel)
SD-WAN-2	Pub-internet (Gig1)	Singapore (Backup Tunnel)
SD-WAN-2	Biz-internet (Gig2) using TLOC extension from SD-WAN1	Singapore (Active Tunnel)

Note: The TLOC extension feature enables a WAN Edge router to communicate over the WAN transport connected to the adjacent WAN Edge router through a TLOC extension interface, allowing for redundancy on the transport side.

Overview of Configuration Steps

Step 1: Set up locations on the Skyhigh SSE cloud platform under web-gateway

Step 2: Set up tunnels on Cisco Catalyst SD-WAN Manager platform using SIG templates

Step 3: On SD-WAN Manager, set up policy to route traffic to Skyhigh SSE

Step 4: Verify tunnel operation on Cisco Catalyst SD-WAN Manager and CLI

Step 5: Verify web traffic on the Skyhigh SSE cloud platform

Configuration Process in Detail

Step 1: Skyhigh location setup

Navigate to Setup > Infrastructure > Web Gateway setup.

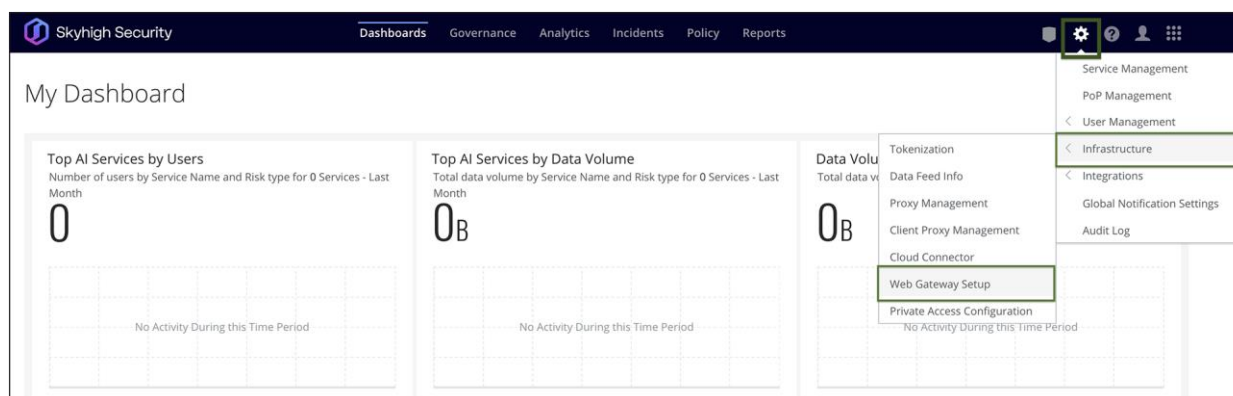

Figure 3.
Skyhigh Dashboard

IPsec Tunnel Setup:

Under Secure Web Gateway Setup, go to Configure Locations > New Location.

Skyhigh Security Dashboards Governance Analytics Incidents Policy Reports

Secure Web Gateway Setup

- Configure SCP**
 1 of 4 steps completed. Skyhigh Client Proxy (SCP) is client software that is installed on your endpoints using standard software deployment tools. SCP forwards internet traffic from the endpoints to the gateways defined in its policy settings. SCP also authenticates users and endpoints when it forwards traffic. Skyhigh Security's gateways can use this information when applying the policy to the forwarded traffic.
 Get Started
Get SCP
- Skyhigh Mobile Cloud Security**
 Skyhigh Mobile Cloud Security (MCS) extends protection to mobile endpoints by redirecting cloud traffic through Skyhigh Secure Web Gateway for Cloud for policy enforcement. Update root CA information, test device certificates, and use the specified steps to configure MDM solutions to enable traffic redirection to Skyhigh Secure Web Gateway for Cloud.
 Configure
- Managing Certificate Authorities for HTTPS Scanning**
 Skyhigh provides a default certificate authority for SAML authentication and a custom certificate authority for HTTPS scanning. We recommend that you download the default CA [here](#) and deploy it on your endpoints. We also recommend that you replace the custom CA with a CA of your own. You can manage the custom CA on the HTTPS Scanning feature configuration page.
- Setup SAML**
 Configure SAML authentication to use your own Identity Provider (IdP) service to authenticate users.
 New SAML
- Enable Active Directory User Group Lookup**
 Enable a lookup of your user group or groups in an Active Directory (AD) when this information cannot be provided by Secure Client Proxy (SCP). User group information is required to select the appropriate web policy when you are logging on to Secure Web Gateway (SWG).
 Configure
- Configure Locations**
 Configure locations to use a different authentication method for each region.
 New Location

tme-cisco-br... | tme-cisco-b...

Figure 4.
Skyhigh Web Gateway Setup

Configure Location attributes:

Configure Location

Name
tme-cisco-branch1-1

Settings

To configure advanced SAML settings, such as adding exceptions, use the configuration in Web Policy. [Learn more](#)

Select SAML Configuration: None

Log Data Residency: Default

Define at least one location mapping.

IP Range Mapping [IPSec Mapping](#) GRE Tunnel Mapping

Provide your identity settings

Client ID Type: Use a User FQDN

Client ID: tme@cisco.com

Client Address: 20.157.25.81

Pre-Shared Key: C1 _____ 10

Define subnets to protect Any subnet

Cancel Save

Figure 5.
Skyhigh location configuration

Location Mapping: IPsec Mapping (in this phase, only IPsec is validated)

Note: Skyhigh supports both IPsec and Generic Routing Encapsulation (GRE).

Client ID Type: Can be based on IPs, Fully Qualified Domain Names (FQDNs) or emails and can be behind Network Address Translation (NAT)

The Client ID should be provided with the corresponding Client ID type. Follow the [article](#) for reference.

Client ID = email (in this case)

Client address = ISP outgoing IP used to build tunnels

Note: Each Skyhigh location requires a unique client address to create location, meaning each location is tied to the ISP's outgoing IP.

Pre-shared key= Use any secure key

Choose Any subnet or Define protected subnets that need to be secured on the branch side.

<input checked="" type="radio"/> Define subnets to protect <input type="radio"/> Any subnet	
Subnet	Comment
192.168.100.1/32	Tracker
172.16.0.0/16	LAN

Using a similar process, add the Second Skyhigh location:

Configure Location

Name

Settings

To configure advanced SAML settings, such as adding exceptions, use the configuration in Web Policy. [Learn more](#)

Select SAML Configuration

Log Data Residency

Define at least one location mapping.

IP Range Mapping IPSec Mapping GRE Tunnel Mapping

Provide your identity settings

Client ID Type

Client ID

Client Address

Pre-Shared Key

Define subnets to protect Any subnet

Figure 6.
Skyhigh location configuration

Configure the rules on Skyhigh as required for Web policy:

Refer to the Skyhigh web policy [page](#) for further details.

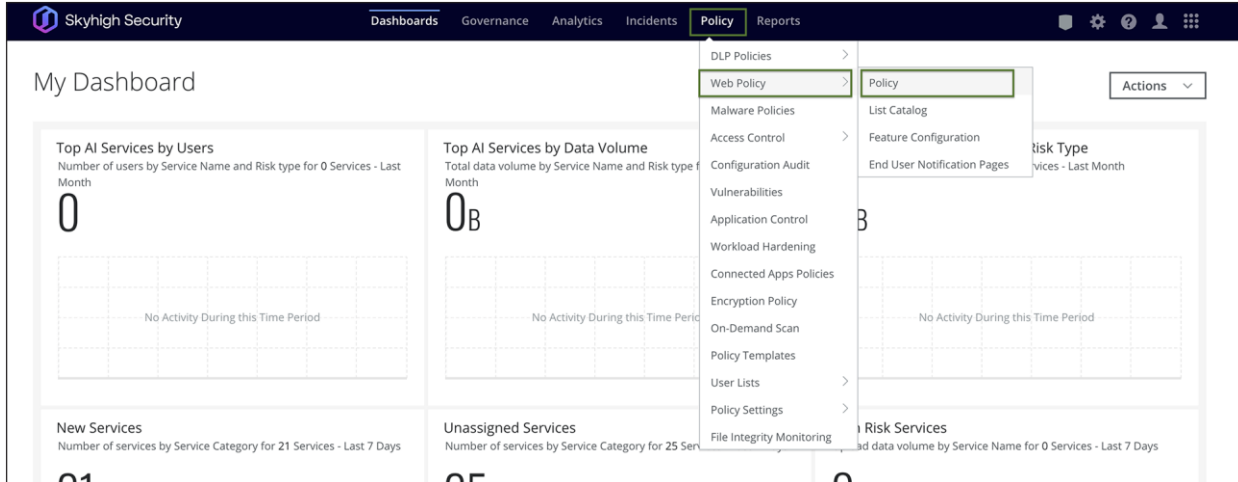

Figure 7.
Skyhigh Web Policy setup

Step 2: Catalyst SD-WAN Manager IPsec tunnel setup

SIG Templates are used for connectivity, providing multiplexing capability to carry multiple Service VPN (VRF) traffic within the same set of tunnels. They are recommended by Cisco for any SIG connectivity.

To set up tunnels using SIG templates, navigate to the Catalyst SD-WAN Manager Dashboard, select Configuration > Templates > Feature Template, and create a SIG template.

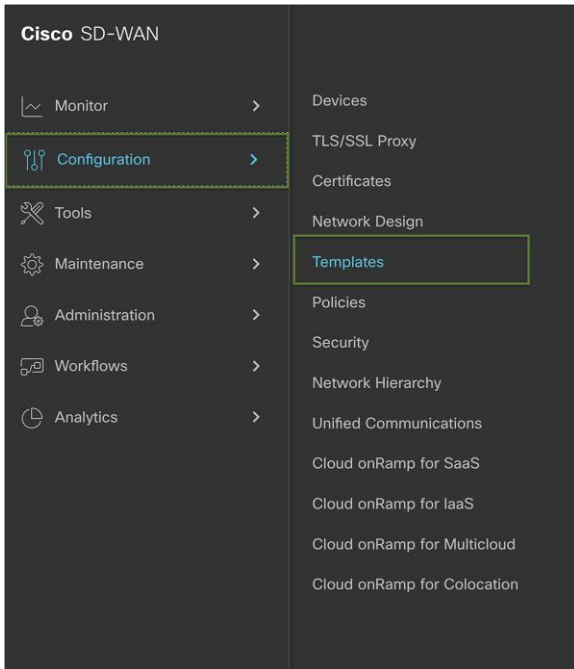

Figure 8.
Cisco SD-WAN Manager Dashboard

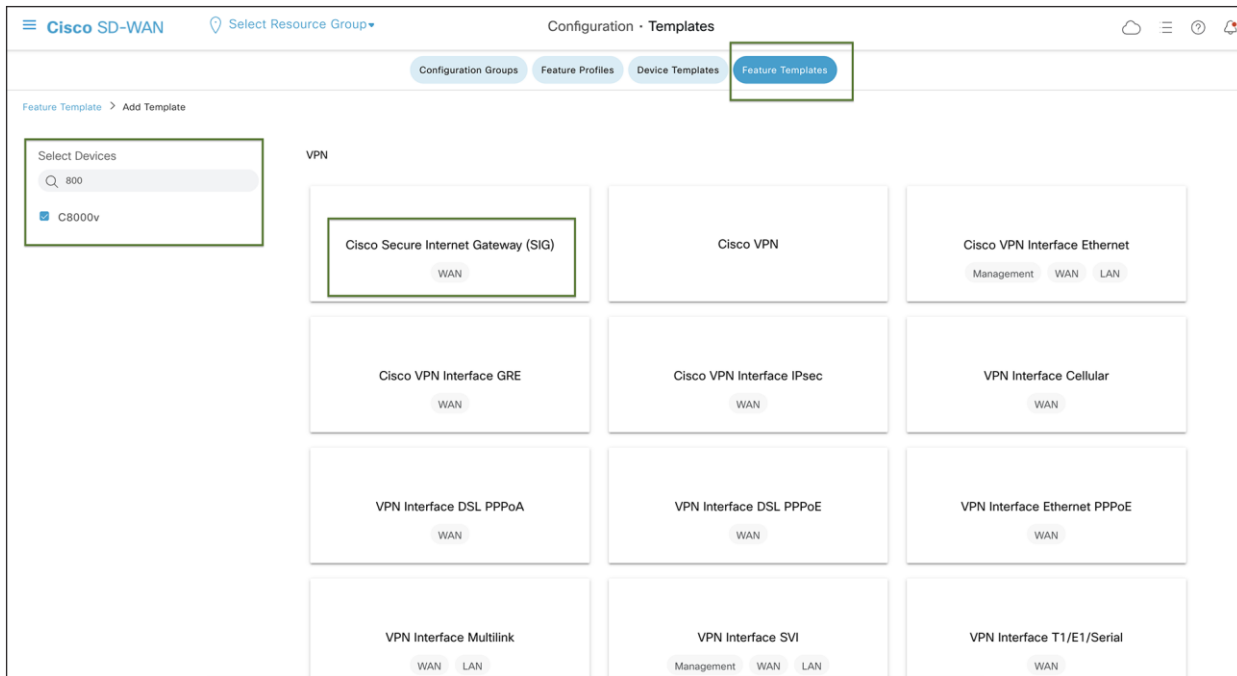

Figure 9.
Cisco SD-WAN SIG Feature Template configuration

SIG Provider:

In the SIG Template, select the Generic Tunnel option.

(Only template-based tunnel is supported at this point)

Configuring Layer 7 Health Checks to Monitor Tunnels:

Create a tracker to ensure the health of the tunnel. In this example, "cisco.com" is used as the endpoint address, but any internet HTTP destination can be used. Please note that HTTPS destinations are not supported. RFC 1918 IP is supported as a tracker source.

Note: Layer 7 Health Checks are used to monitor the health of tunnels toward the SIG using trackers attached to the tunnels. These trackers facilitate automatic failover to back up tunnels based on tunnel health. Failover occurs when SLA parameters are not met or when the SIG tunnel is down.

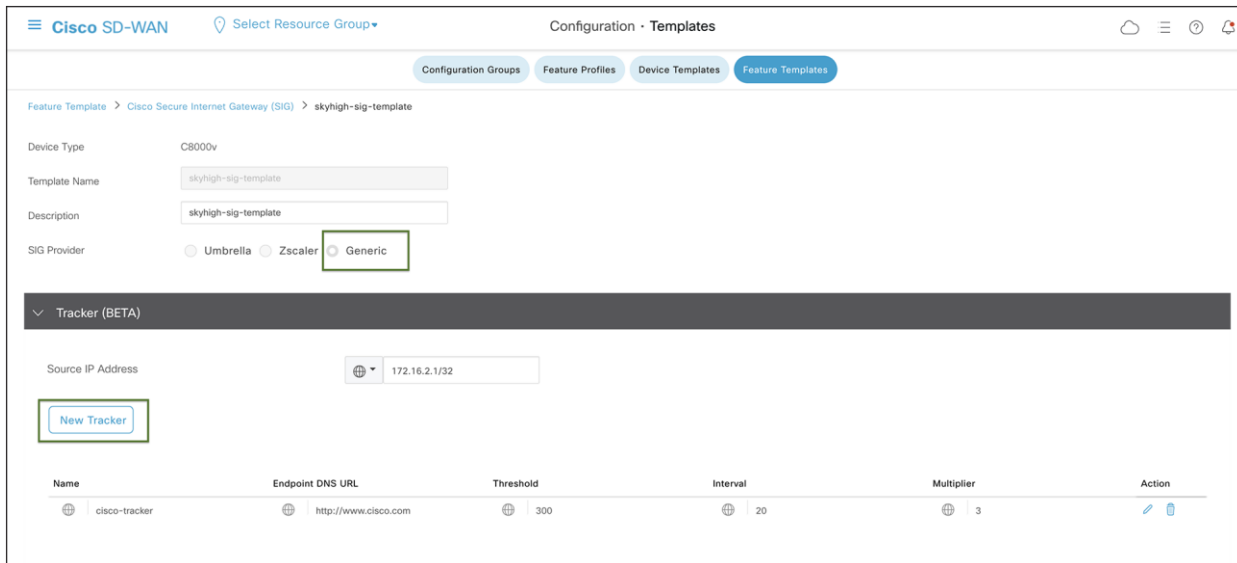

Figure 10.
Cisco SD-WAN tracker configuration in SIG template

Add IPsec Tunnel:

During the tunnel creation, select tunnel type IPsec. Then from the dropdown menu, select the tracker created in the previous step from the dropdown menu.

Select IPsec source interface.

Tunnel destinations can be found using nslookup. Refer to this [article](#) by Skyhigh.

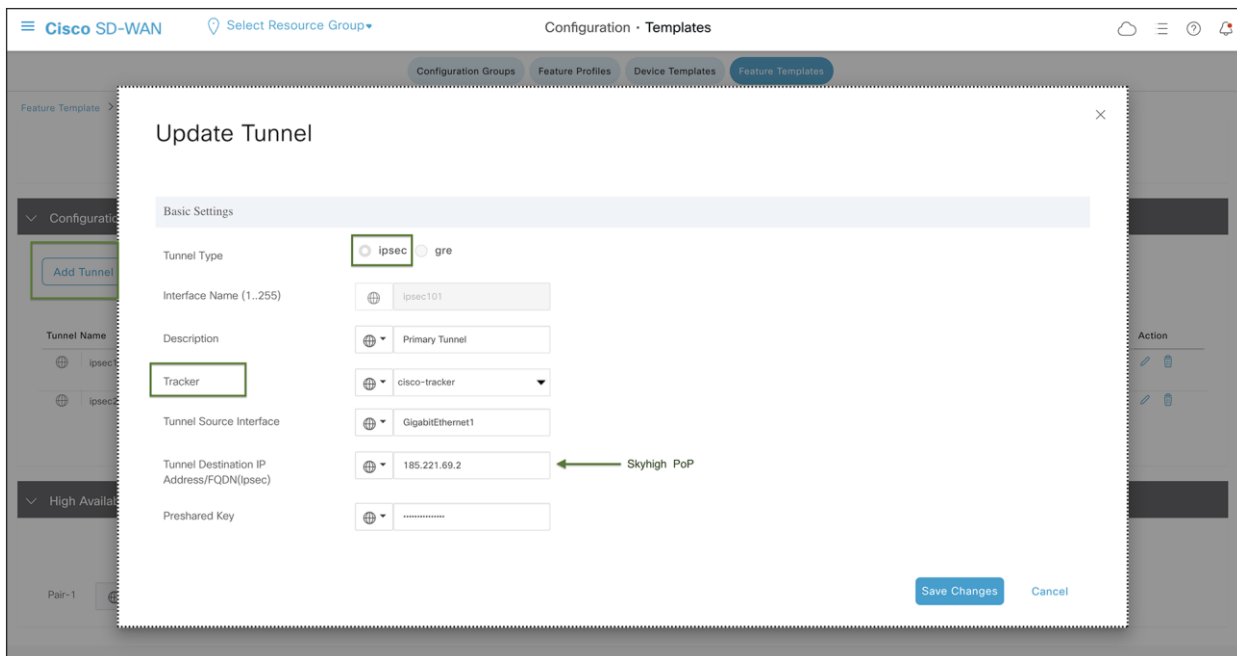

Figure 11.
Cisco SD-WAN IPsec tunnel configuration in SIG template

Advanced options:

In the IKE ID for the local end point, use the Client ID specified in step 1 during the Skyhigh location creation.

Ensure that the IKE and IPsec cipher suites are part of supported ciphers by Skyhigh.

Please refer to this Skyhigh article for [Skyhigh IKE/IPsec settings](#).

Note: In the advanced options for tunnel creation, the default is NULL SHA1. Change it to AES 256.

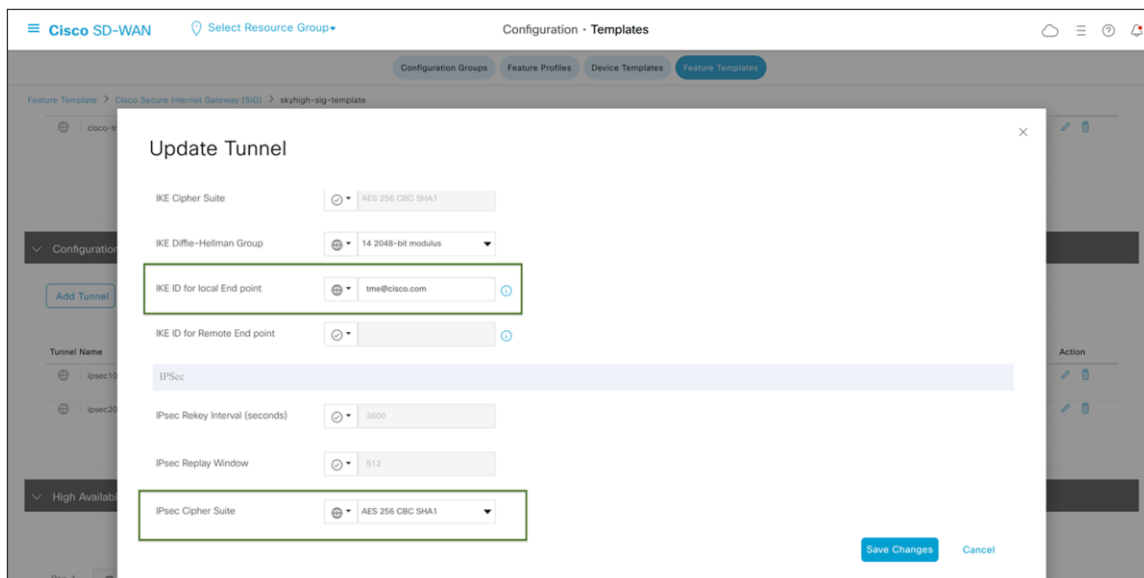

Figure 12. Cisco SD-WAN IPsec tunnel advanced options configuration

Secondary Tunnel:

Following the same steps as above, create the secondary tunnel and utilize the IP address of the other Skyhigh POP.

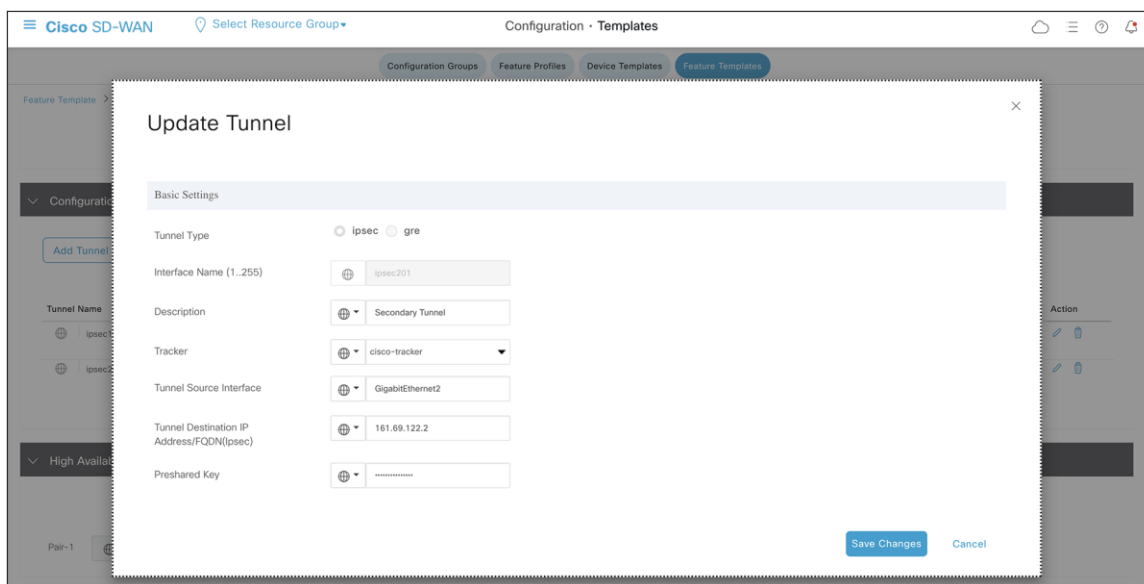

Figure 13. Cisco SD-WAN IPsec tunnel configuration for backup tunnel

HA Configuration:

Once the two tunnels are created as shown below, proceed to HA configuration using these two tunnels. This step ensures that traffic automatically fails over to the secondary tunnel if the primary tunnel goes down.

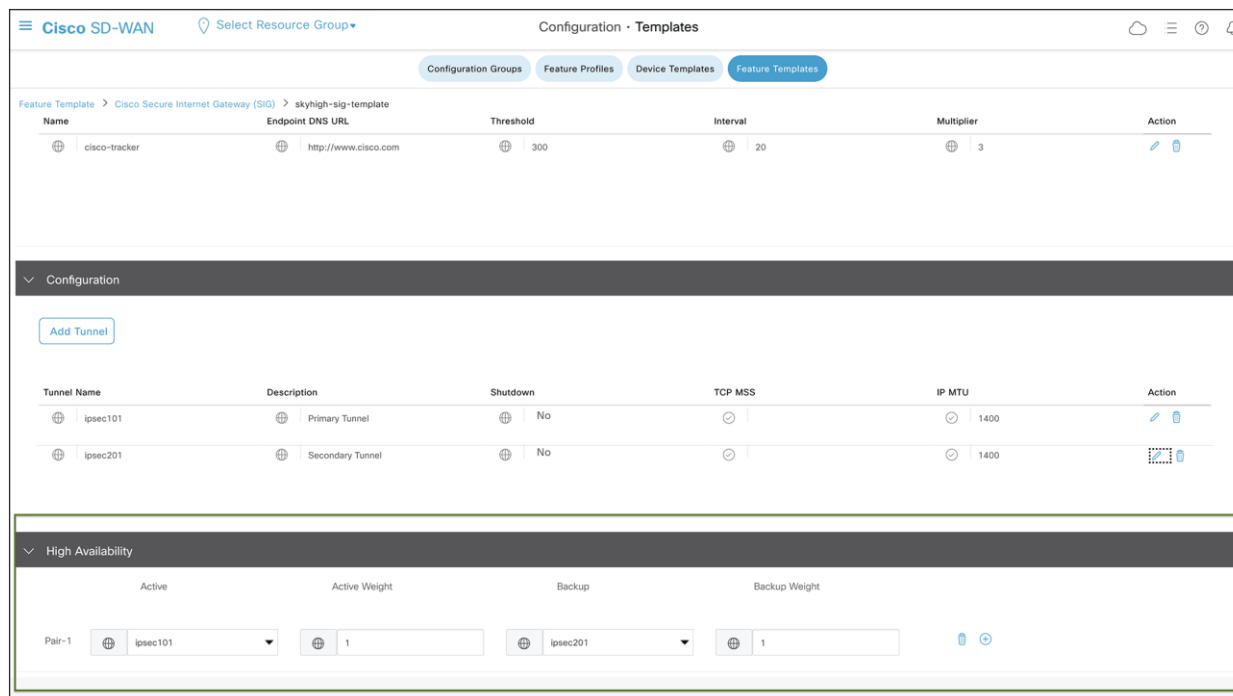

Figure 14.
Cisco SD-WAN active/backup high-availability configuration

ECMP Tunnels:

To configure ECMP tunnels, choose “None” under the backup of Pair-1, and configure Pair-2 with secondary tunnel as the active tunnel, as shown in figure 14 below.

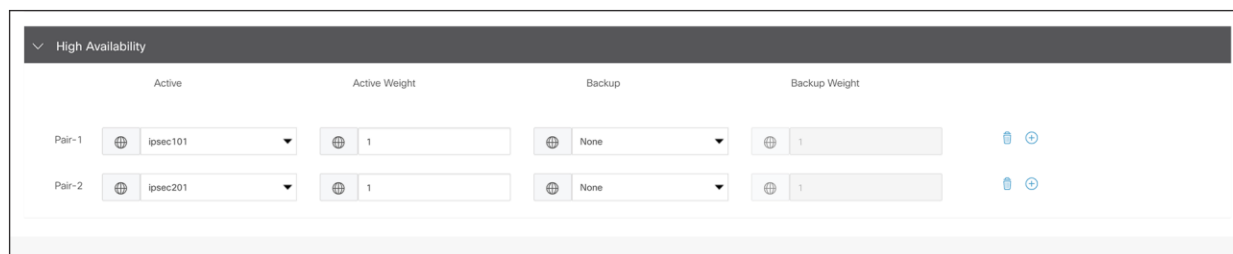

Figure 15.
Cisco SD-WAN IPsec ECMP configuration

Note: The Cisco solution offers a capability of four ECMP active and four backup tunnels, which can be configured using loopbacks with same outgoing ISP IP and location combination. However, to have multiple ECMP tunnels, multiple locations must be configured using unique public IP on the Skyhigh portal. So, four unique public IP addresses are required for configuring four ECMP active tunnels.

Add SIG Feature Template to the Device Template:

Navigate to the Catalyst SD-WAN Manager Dashboard, select Configuration > Templates > Device Templates, and edit the device template.

Add Cisco Secure Internet Gateway template from right end, as shown in figure 15.

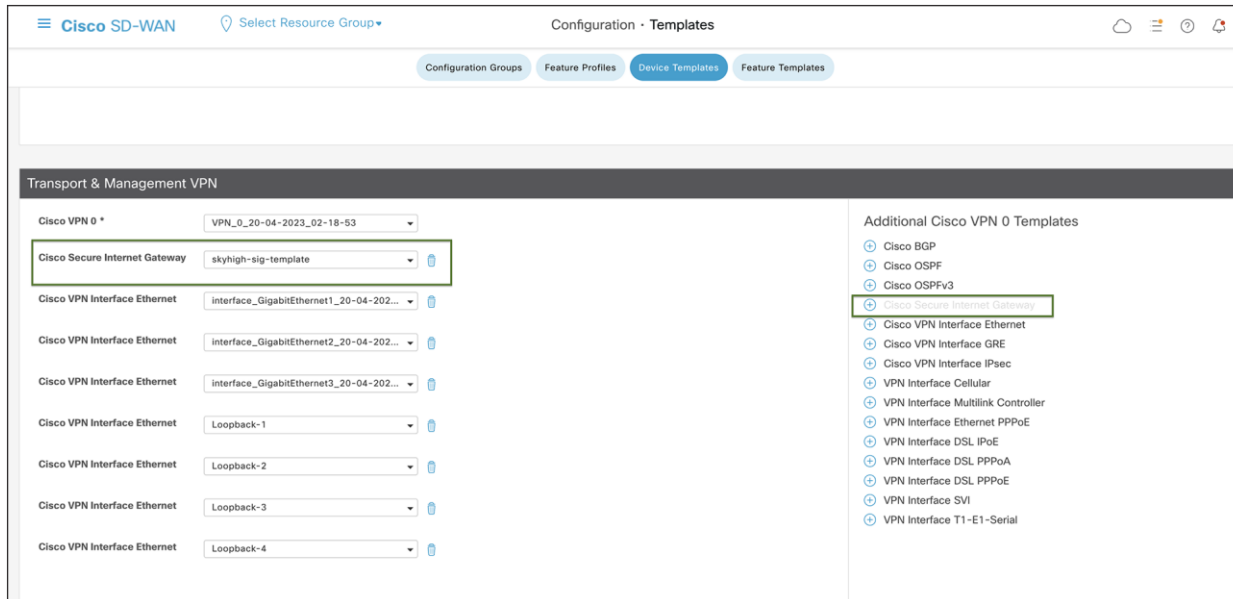

Figure 16.
Cisco SD-WAN device template configuration

No variables need to be defined, so click Update>“Next” after this step, then proceed to “Configure Devices.” Catalyst SD-WAN Manager should return a success message once the configuration process is complete.

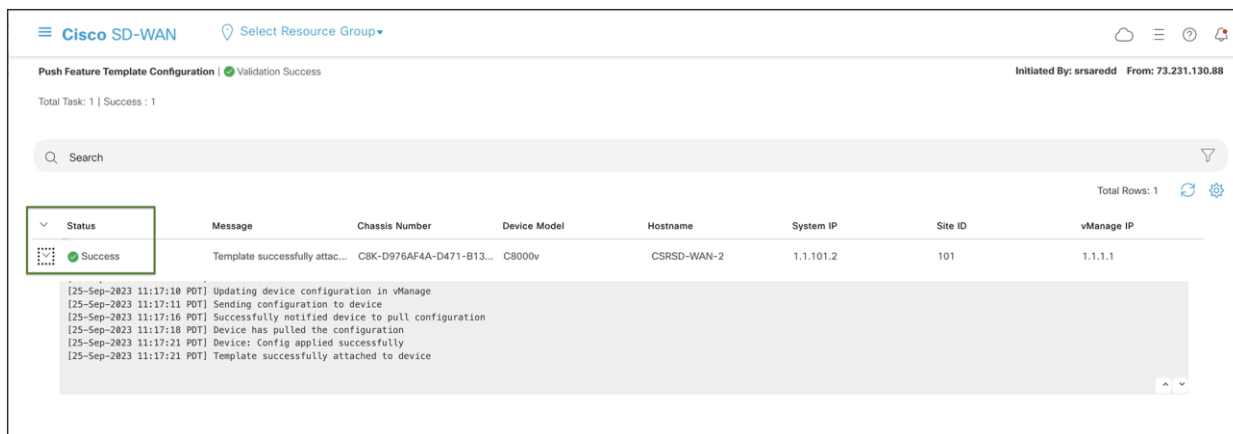

Figure 17.
Cisco SD-WAN configuration status

Step 3: Setup policy-based traffic redirection

Traffic to SIG

The traffic from the service VPN can be redirected to SIG tunnels in two ways.

- Using a static default route to the service SIG
- Using centralized data policy to redirect to the service SIG, in case specific applications or traffic need to be redirected for secure internet/SAAS access

For further information on the SIG template and redirection policy, refer to this [guide](#).

Note: Skyhigh SSE (web gateway) can only process secure web (http(s)) traffic. Therefore, Internet Control Message Protocol (ICMP), and Domain Name System (DNS) traffic should not be sent through the tunnels toward Skyhigh SSE. In this case, data policy can be used to redirect web traffic to Skyhigh.

Navigate to the Catalyst SD-WAN Manager Dashboard, select Configuration > Policies > Centralized Policy.

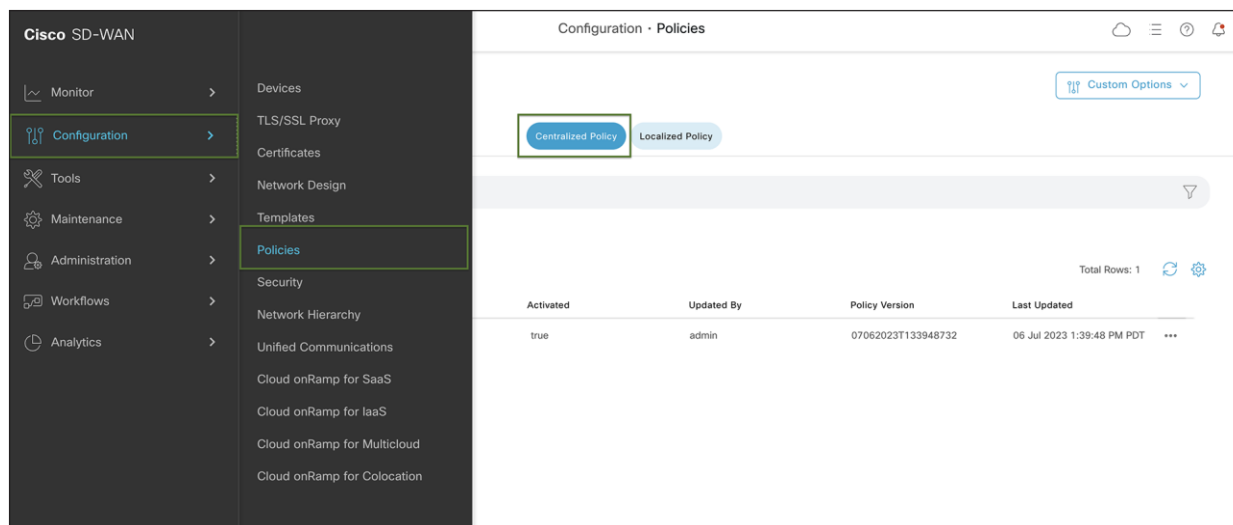

Figure 18.

Cisco SD-WAN policy configuration

Navigate to Centralized Policy and configure a traffic data policy to match on ports 80 and 443. Redirect all web to Skyhigh SSE using the tunnels configured above. Apply the policy to the Service VPN and to sites configured with tunnels.

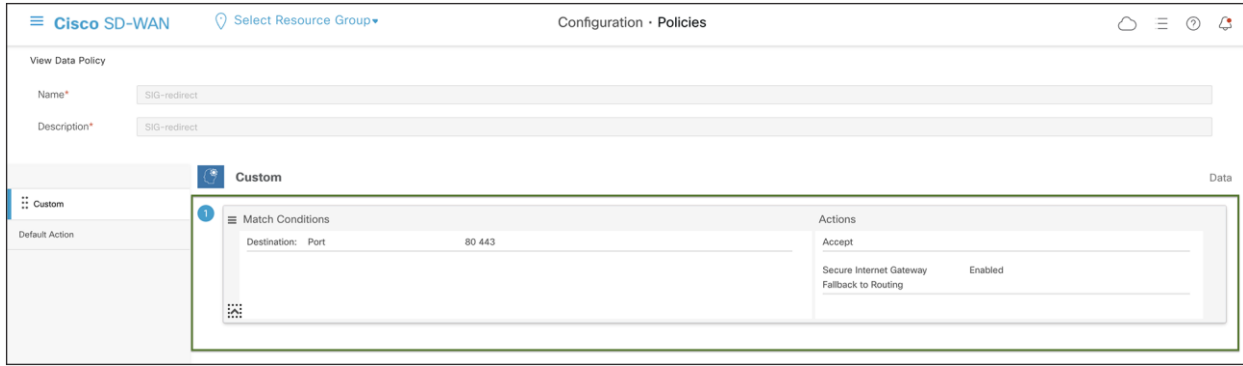

Figure 19.
Cisco SD-WAN custom data policy configuration

Note: The default action is drop for traffic data policy, so change that to Accept.

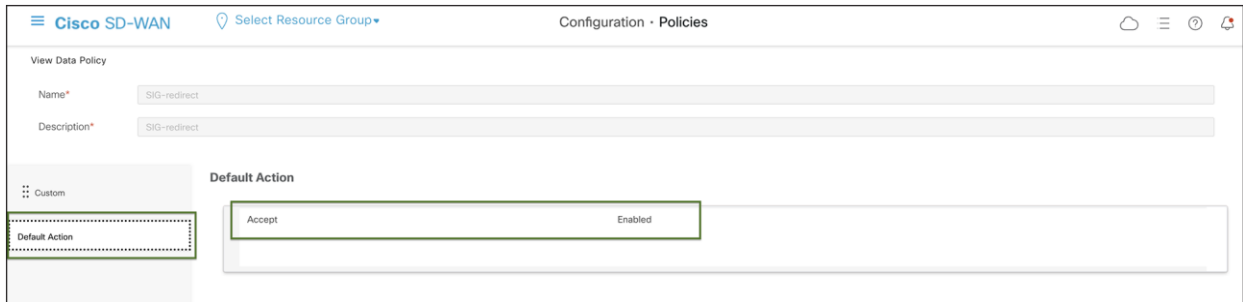

Figure 20.
Cisco SD-WAN default data policy configuration

Step 4: Verify Tunnel operation on Cisco Catalyst SD-WAN Manager and CLI

In the SD-WAN Manager GUI:

Under Monitor navigate to Devices -> WAN Edge router ellipsis -> Real Time

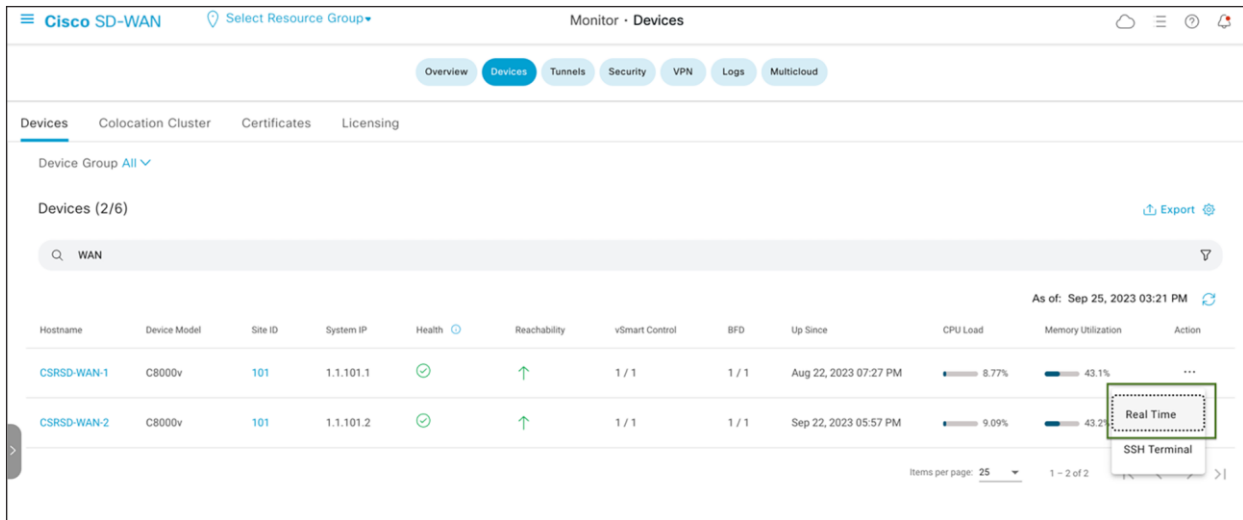

Figure 21.
Cisco SD-WAN device monitoring

Under Applications > Interface, click Real Time at the top right of the chart.

Then, select the interface on the right-hand side of the chart to view specific interface activity.

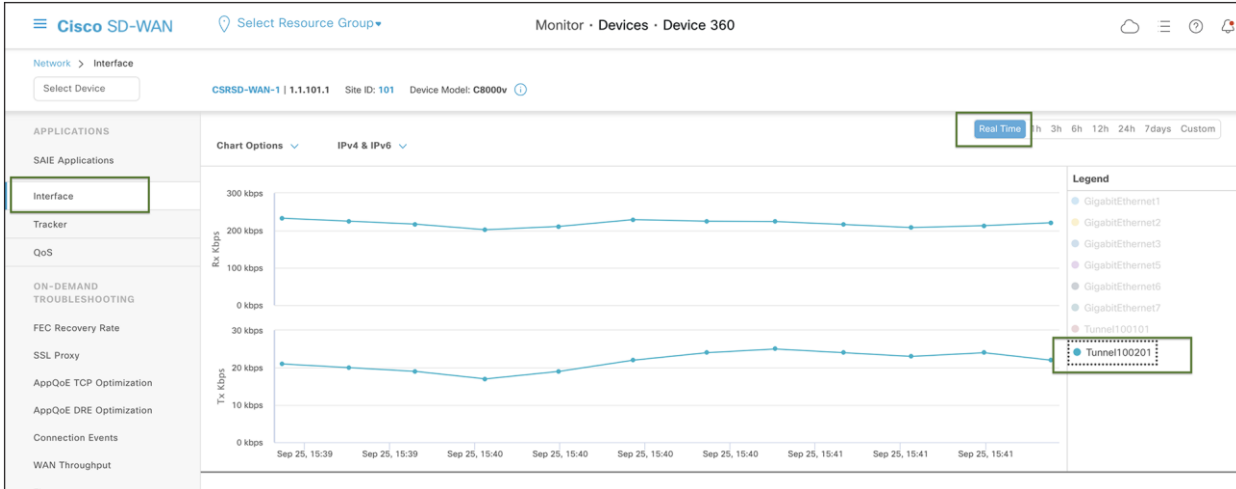

Figure 22.
Cisco SD-WAN device 360 Real Time Monitor

If the interface is missing from the graph, scroll down past the chart to see the complete list of interfaces. Click the checkbox on the left for the interface to display on the chart. You can view the state and statistics of all device interfaces from this list.

VPN (VRF)	Interface Name	Interface description	Physical Address	IPv4 Address	IPv4 Subnet Mask	Admin Status	Oper Status	Interface Typ
<input checked="" type="checkbox"/>	Tunnel100201	Secondary Tunnel	00:00:00:00:00:00	192.168.1.1	255.255.255.252	↑	↑	iana-iftype-
<input checked="" type="checkbox"/>	Tunnel100101	Primary Tunnel	00:00:00:00:00:00	10.2.1.5	255.255.255.0	↑	↑	iana-iftype-

Figure 23.
Cisco SD-WAN Real Time device interface monitoring

Verify Tunnel Operation Using CLI:

Use the `show sdwan secure-internet-gateway tunnels` command to view SIG tunnel status to Skyhigh SSE

```
Device# show sdwan secure-internet-gateway tunnels
```

TUNNEL IF NAME	TUNNEL ID	TUNNEL NAME	HA PAIR	DEVICE STATE	SIG STATE	TRACKED STATE
Tunnel100001	52615809	site1820851800sys172x16x255x15ifTunnel100001	Active	Up	NA	Enabled
Tunnel100002	52615814	site1820851800sys172x16x255x15ifTunnel100002	Backup	Up	NA	Enabled

Figure 24.
Cisco Edge device CLI output

Step 5: Verify web traffic on Skyhigh SSE cloud platform

Navigate to Analytics > Web > Web Traffic on the Skyhigh dashboard.

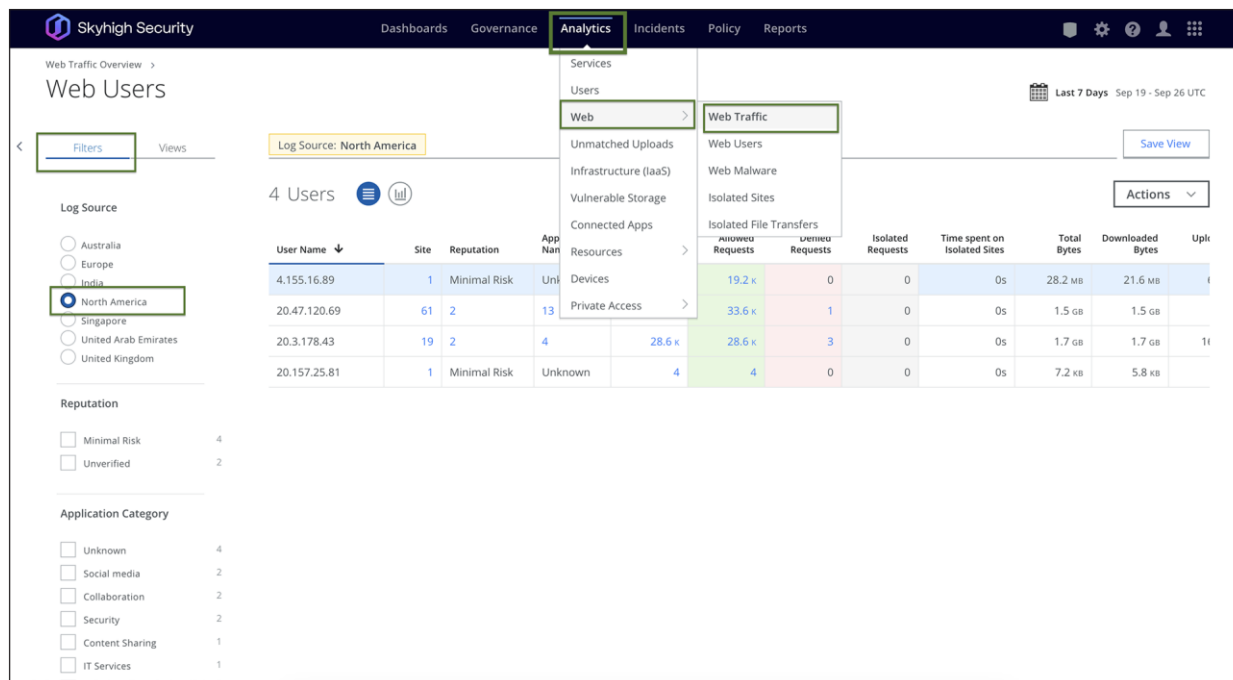

Figure 25.
Skyhigh Web Traffic analytics

The Web Traffic page offers an overview of organization's traffic data, which can be used for analysis or reporting. It includes aggregated data on visits, website and application names, requests (hits), access status (allowed or denied), and data transfer (bytes uploaded and downloaded). For more details on filtering and sorting web traffic refer to this [article](#).

Deployment models

Below are a few deployment models in the case of two SD-WAN edge devices, two ISPs, and two Skyhigh locations.

Deployment model 1: One active IPsec tunnel per WAN Edge

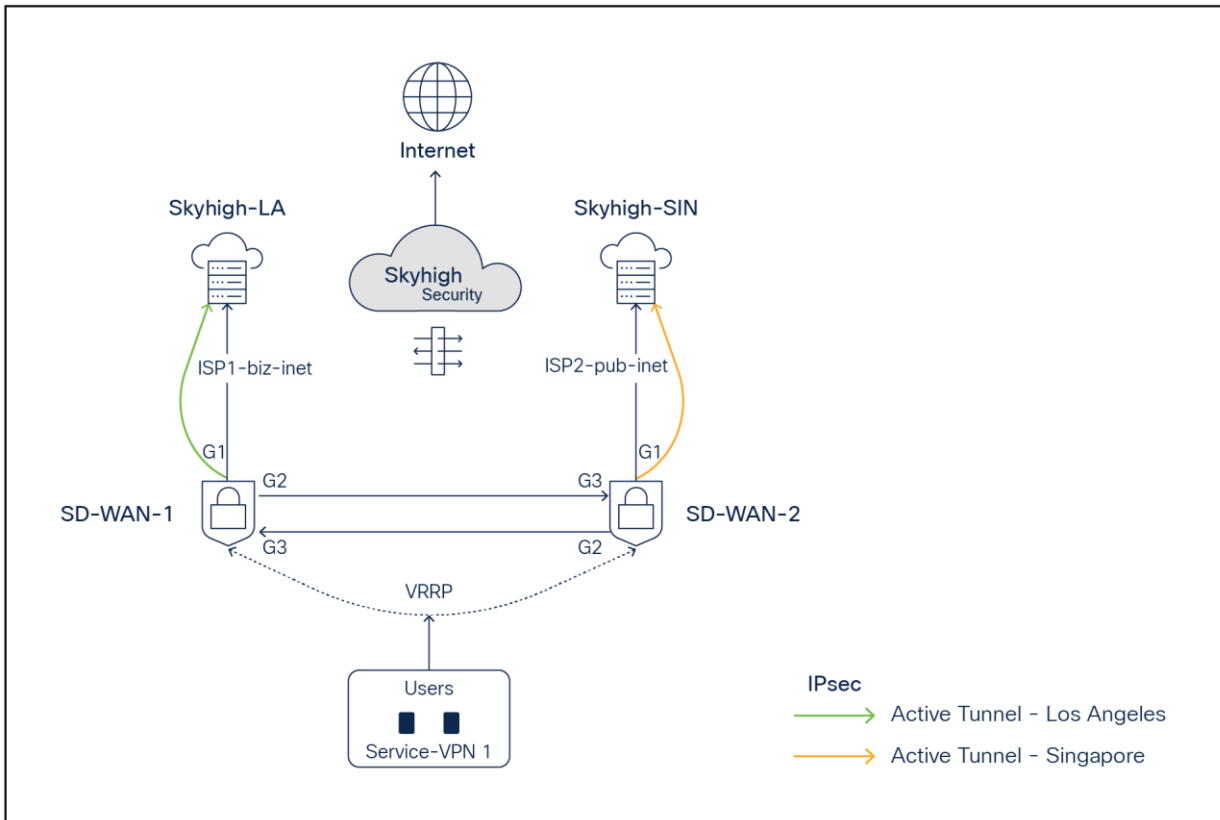

Figure 26.
SD-WAN and Skyhigh topology diagram with one active IPsec tunnel per Edge

- SD-WAN-1 is connected to the Skyhigh SSE Datacenter location LA using ISP1
- SD-WAN-2 is connected to the Skyhigh SSE Datacenter location SIN using ISP2
- Active IPsec tunnels are established from SD-WAN-1 and SD-WAN-2 to LA and SIN, respectively
- Service VPN is redundantly configured with VRRP

Deployment model 2: One active/backup IPsec tunnel per WAN Edge

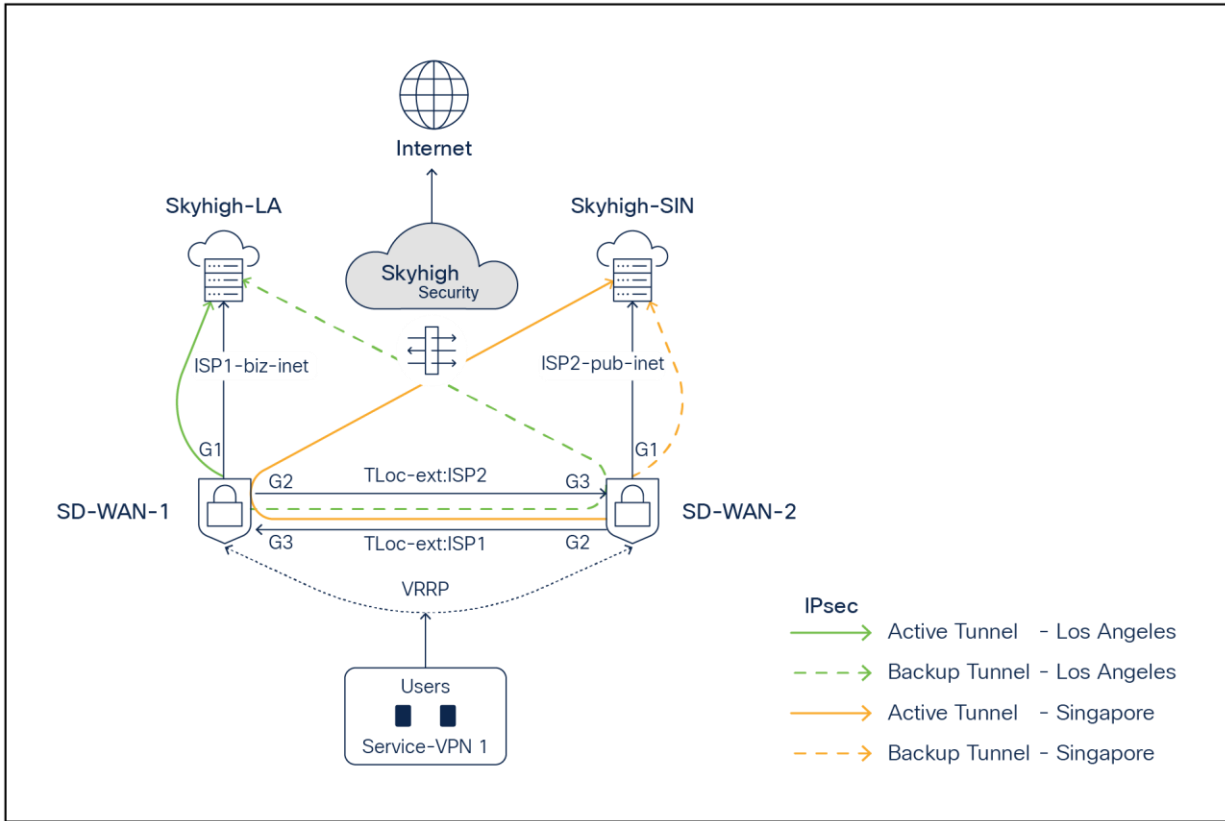

Figure 27. SD-WAN and Skyhigh topology diagram with one active - one backup IPsec tunnel per Edge

- SD-WAN-1 is connected to the Skyhigh SSE Datacenter location LA using ISP1 and ISP2 (TLOC extension)
- SD-WAN-2 is connected to the Skyhigh SSE Datacenter location SIN using ISP1 (TLOC extension) and ISP2
- Active/Backup IPsec tunnels are established from SD-WAN1 router to LA and from SD-WAN-2 to SIN
- Service VPN is redundantly configured with VRRP

Deployment model 3: Two active/active ECMP IPsec tunnels per WAN Edge

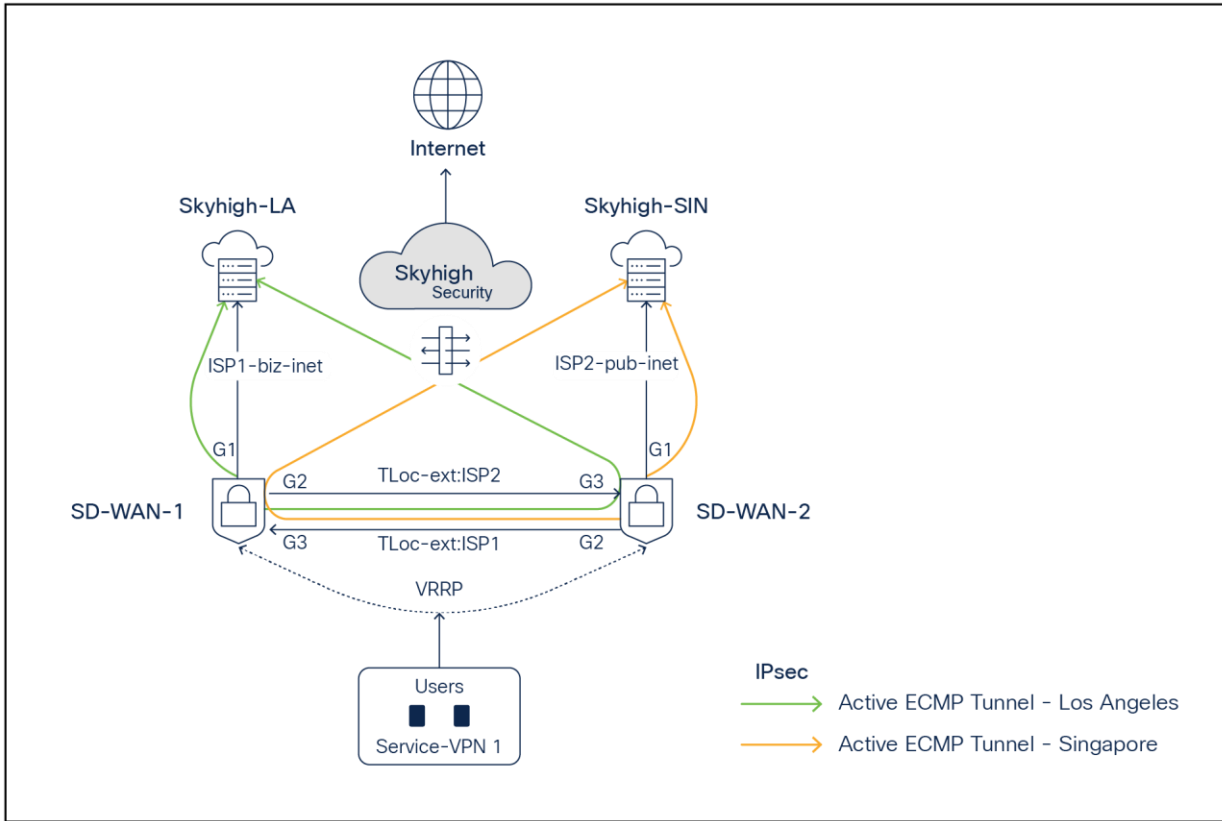

Figure 28. SD-WAN and Skyhigh topology diagram with two active ECMP IPsec tunnels per Edge

- SD-WAN-1 is connected to the Skyhigh SSE Datacenter location LA using ISP1 and ISP2 (TLOC extension)
- SD-WAN-2 is connected to the Skyhigh SSE Datacenter location SIN using ISP1 and ISP2 (TLOC extension)
- Active/Active ECMP IPsec tunnels are established from SD-WAN 1 to LA and from SD-WAN 2 to Singapore
- Service VPN is redundantly configured with VRRP

Skyhigh Web Gateway Configuration Modification Procedure

Once changes are made on the web gateway, save, and publish the changes.

Note: To make changes to configurations on Skyhigh UI, it is recommended to first shut down tunnels on the SD-WAN edge device and then perform the changes. Once changes are completed on the Skyhigh UI, enable the tunnels on the SD-WAN Edge. This will provide immediate implementation of any changes.

Configure Location

Name
tme-cisco-branch1-1

Settings
To configure advanced SAML settings, such as adding exceptions, use the configuration in Web Policy. [Learn more](#)

Select SAML Configuration: None
Log Data Residency: Default

Define at least one location mapping.
IP Range Mapping | IPSec Mapping | GRE Tunnel Mapping

Provide your identity settings

Client ID Type: Use a User FQDN
Client ID: tme2@cisco.com
Client Address: 20.157.25.81
Pre-Shared Key: C1sco1234567890

Cancel Save

Skyhigh Security | Dashboards | Governance | Analytics | Incidents | Policy | Reports

Changes to the policy need to be published.
Publish Discard Keep Working

Managing Certificate Authorities for HTTPS Scanning
Skyhigh provides a default certificate authority for SAML authentication and a custom certificate authority for HTTPS scanning. We recommend you replace the custom CA with a CA of your own. You can manage the custom CA on the HTTPS Scanning feature configuration page.

Setup SAML
Configure SAML authentication to use your own Identity Provider (IdP) service to authenticate users. [New SAML](#)

Enable Active Directory User Group Lookup
Enable a lookup of your user group or groups in an Active Directory (AD) when this information cannot be provided by Secure Client Proxy (SCP). User group information is required to select the appropriate web policy when you are logging on to Secure Web Gateway (SWG). [Configure](#)

Figure 29. Skyhigh location configuration changes

Cisco Catalyst SD-WAN Manager Configuration Modification Procedure

Example: To change IKE ID on IPsec tunnel101

Go to Configuration > Templates > Feature Template. Click on the ellipsis icon to edit the template.

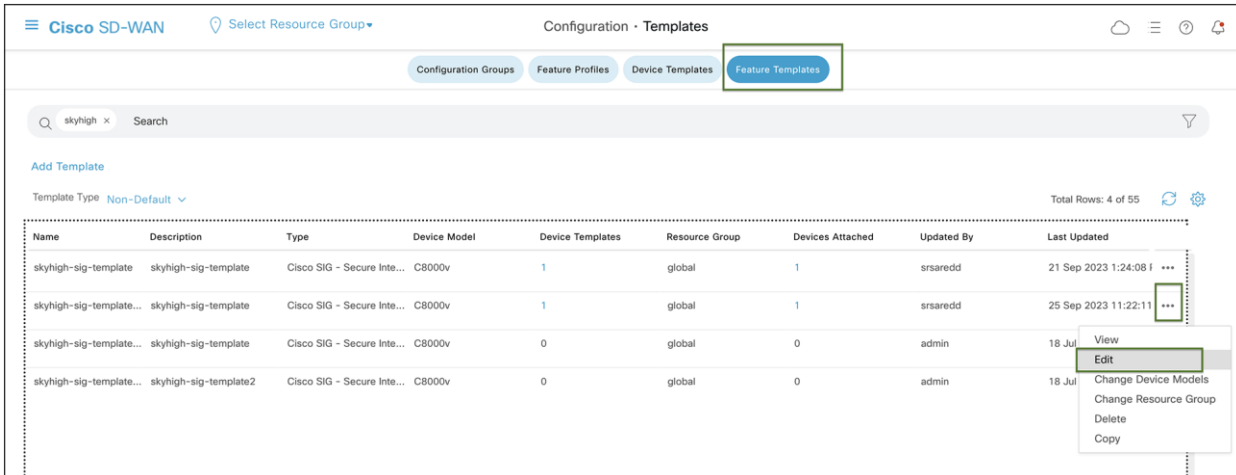

Edit the tunnel configuration, and save it as shown in figures 29 and 30 below by clicking Update and Save Changes.

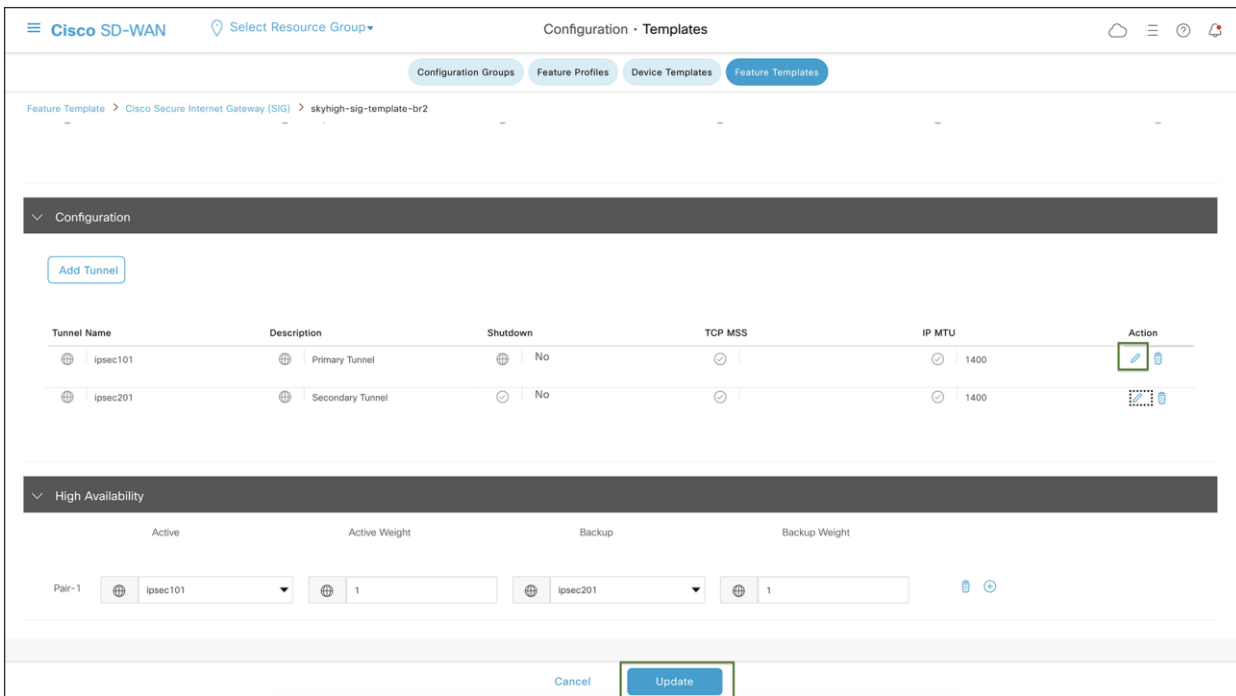

Figure 30.
Cisco SD-WAN device template configuration changes

Update Tunnel

IKE

IKE Rekey Interval (seconds)

IKE Cipher Suite

IKE Diffie-Hellman Group

IKE ID for local End point

IKE ID for Remote End point

IPSec

Figure 31.
Cisco SD-WAN IPsec tunnel advanced configuration changes

Update and click Next.

Cisco SD-WAN | Select Resource Group | Configuration · Templates

Device Template | 5d02cae9-5d71-43f3-90e5-db5650dabca6

Search

Total Rows: 1

S...	Chassis Number	System IP	Hostname	Interface Name(GigabitEthernet4)	IPv4 Address/ prefix-length(172.101.1.2/24)	Prefix(0.0.0.0/0)	Address(1)
✓	CBK-D976AF4A-D471-B137-CBE9-F0E6...	1.1.101.2	CSRS-D-WAN-2	GigabitEthernet4	172.16.1.2/24	0.0.0.0/0	192.168.1.1 ***

Figure 32.
Cisco SD-WAN device provisioning with changes

Config preview and config differences can be viewed on this page.

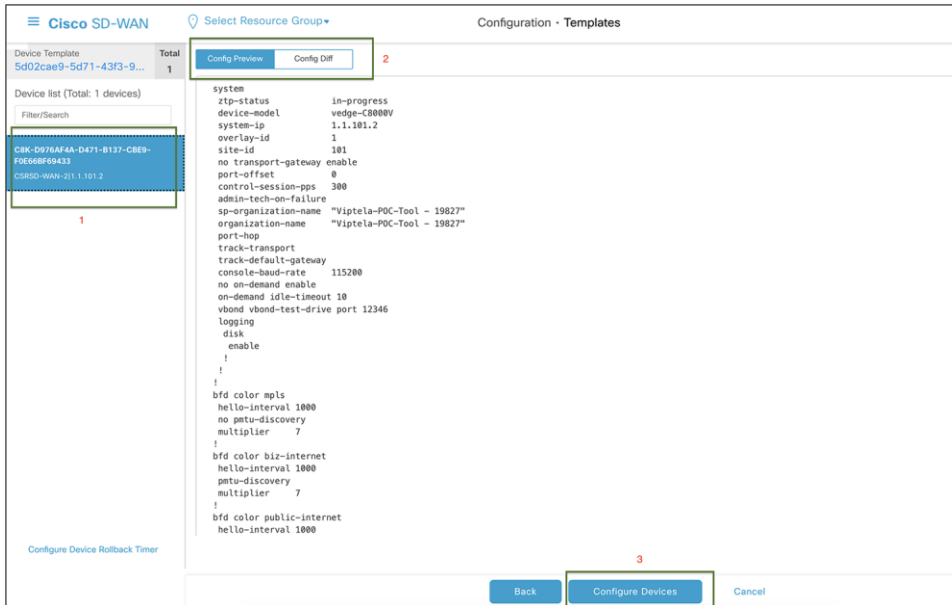

Figure 33.
Cisco SD-WAN config preview

Config difference can be viewed in two ways: side by side or inline.

This is an inline view with changes highlighted in red and green. Once validated, click Configure Devices.

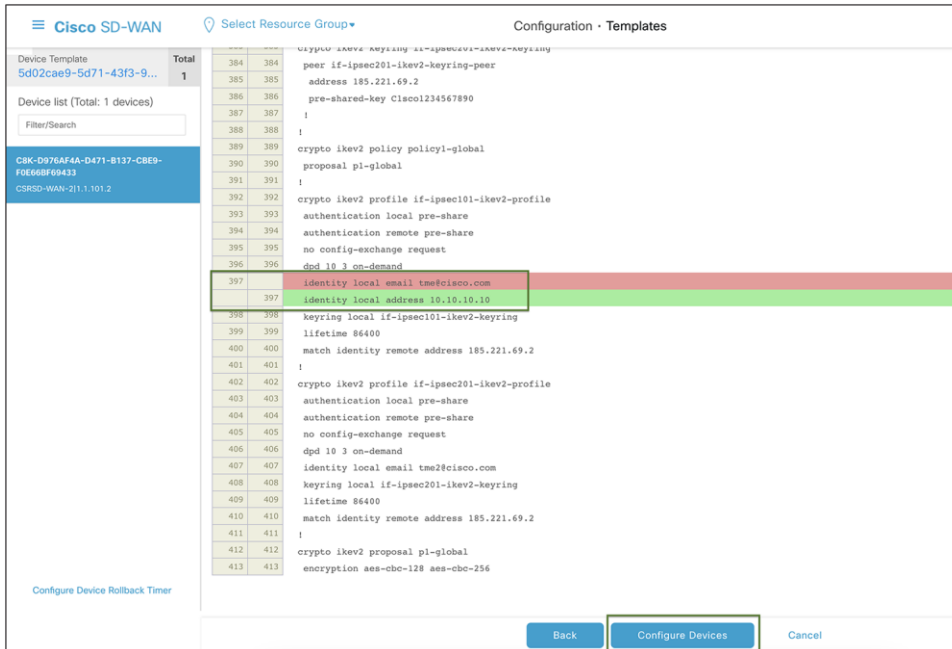

Figure 34.
Cisco SD-WAN config difference

Once the Configuration is deployed to SD-WAN Edge, the status returns as Success.

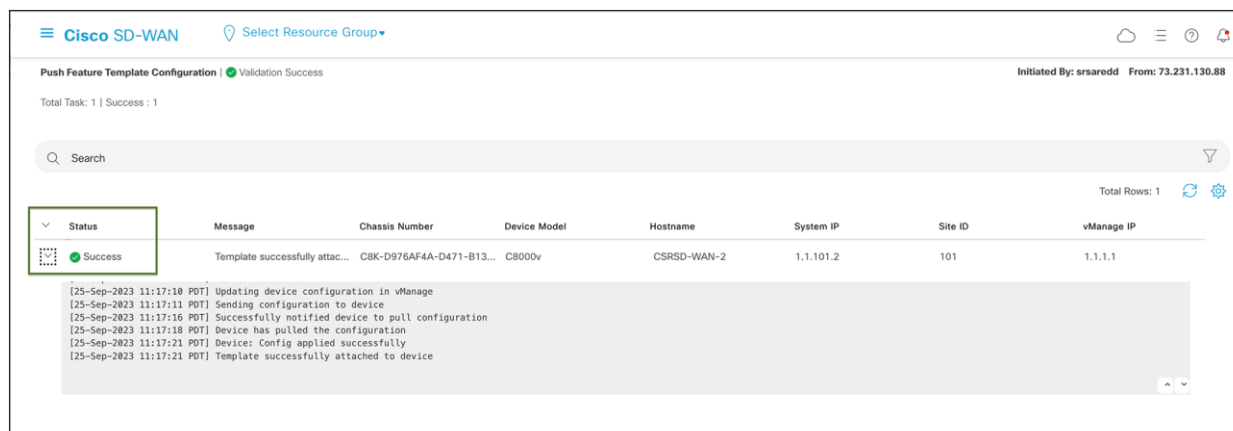

Figure 35.
Cisco SD-WAN configuration status

In conclusion, the integration of Cisco Catalyst SD-WAN with Skyhigh SSE offers an efficient and secure solution for branch internet traffic. The seamless redirection and comprehensive features enhance network performance while ensuring robust cybersecurity measures. This validated guide serves as a valuable reference for customers implementing the Skyhigh Secure Service Edge solution alongside Cisco Catalyst SD-WAN, providing flexibility and reliable performance.

Try it now

Take the first step in modernizing your WAN architecture. Contact us for a free consultation on integrating your Cisco Catalyst SD-WAN with Skyhigh Security.

- SDWAN@cisco.com

For more information

Please visit:

- [Cisco SD-WAN Security](#)
- [Cisco SASE](#)

Americas Headquarters
Cisco Systems, Inc.
San Jose, CA

Asia Pacific Headquarters
Cisco Systems (USA) Pte. Ltd.
Singapore

Europe Headquarters
Cisco Systems International BV Amsterdam,
The Netherlands

Cisco has more than 200 offices worldwide. Addresses, phone numbers, and fax numbers are listed on the Cisco Website at <https://www.cisco.com/go/offices>.

Cisco and the Cisco logo are trademarks or registered trademarks of Cisco and/or its affiliates in the U.S. and other countries. To view a list of Cisco trademarks, go to this URL: <https://www.cisco.com/go/trademarks>. Third-party trademarks mentioned are the property of their respective owners. The use of the word partner does not imply a partnership relationship between Cisco and any other company. (1110R)