

Cisco Unified Computing System Express

Simplifying Branch-Office Infrastructure

The Cisco Unified Computing System™ Express (UCS Express) is a converged computing, virtualization, and networking platform for hosting essential infrastructure services and mission-critical business applications in the lean branch office.

It consists of the following:

- Cisco® Services-Ready Engine (SRE) x86 blade server computing platform (Figure 1)
- Cisco Services-Ready Engine Virtualization (SRE-V) server virtualization platform powered by VMware vSphere Hypervisor (ESXi)
- Cisco Integrated Services Routers Generation 2 (ISR G2) networking platform with Multigigabit Fabric (MGF) backplane switch
- Cisco Integrated Management Controller Express (IMC Express) blade management system

Cisco UCS Express is best suited for multisite organizations with centralized IT infrastructure that need to host applications locally in the branch office because of performance, availability, or compliance reasons. It enables multiple virtual instances of Microsoft Windows Server and Linux to run on dedicated general-purpose x86 blades directly in the Cisco ISR G2 chassis. With Cisco UCS Express, multisite organizations can increase IT agility, lower total cost of ownership (TCO), and get more value out of their branch-office infrastructure.

Figure 1. Cisco Services-Ready Engine x86 Blade Servers with Cisco 3945 Integrated Services Router



Main Features	Main Benefits
<ul style="list-style-type: none"> • Compact, all-in-one computing, virtualization, and networking system • Easy-to-provision general-purpose x86 blade servers • Enterprise- and production-class bare-metal hypervisor from VMware • Management with separated network and server access control • Certified for Microsoft Windows Server 	<ul style="list-style-type: none"> • Simplify branch-office infrastructure and reduce TCO • Accelerate and reduce skill level for physical server deployment • Consolidate physical servers and improve application time to market • Converge infrastructure but maintain separate functional domains • Provide right-size platform for essential branch-office applications

Infrastructure Challenges at the Branch Office

Organizations today are turning to centralization of branch-office applications to reduce the cost and complexity of their remote IT systems. As a result, branch-office infrastructure - servers, storage devices, and infrastructure software - is being displaced by much more optimized infrastructure in the data center.

Although full application centralization is the ideal scenario for all organizations, in practice it is often difficult to achieve. Typically, the WAN separates the end user in the branch office from the application processing environment in the data center. However, the WAN has several inherent limitations that affect the quality of the user's experience with remote applications. Moreover, applications may not be able to store data outside the branch office because of privacy or access-control concerns. Therefore, some applications still cannot leave the branch office for one or a combination of the following reasons:

- **Performance:** Applications that cannot tolerate the latency and bandwidth limitations of a WAN link because they require fast response times may need local processing to meet their performance targets.
- **Availability:** Applications that cannot tolerate the reliability and congestion limitations of a WAN link because they require maximum uptime may need local survivability to meet their availability targets.
- **Compliance:** Applications that cannot store their data outside the branch office because they must meet user privacy, regulatory, or internal policy requirements may require local presence to comply.

The following are examples of applications that have defied most centralization efforts and continue to be deployed locally at the edge of the network:

- **Core Microsoft Windows services:** Microsoft Active Directory Domain Services (AD DS) and Microsoft Windows print services, Dynamic Host Configuration Protocol (DHCP) server, Domain Name System (DNS) server, file services, and others.
- **Mission-critical business applications:** Point-of-sale (POS) systems, bank teller in-office control points (IOCP), electronic-medical-record (EMR) systems, inventory management systems, and others.
- **Client management services:** Configuration and operations management, monitoring services, update and patching services, backup and recovery services, terminal server gateways, and others.

Most of these mission-critical WAN edge services require modest hardware resources. Therefore, the now-leaner branch office typically requires a small number of physical servers for hosting all local applications. Moreover, centrally hosted applications can now perform with LAN-like speed over the WAN by taking advantage of WAN optimization and application acceleration. All these factors have contributed to the emergence of the lean branch-office architecture.

The Lean Branch Office

The reduction of branch-office applications to the essential minimum, modest local hardware requirements, and WAN optimization technologies reduce the branch-office infrastructure footprint, equipment and operating costs, and management complexity. The resulting lean branch office provides a balance between a fully centralized serverless architecture with its dependence on a slow and unreliable WAN link and a distributed full-service architecture with its high cost and management complexity, as shown in Table 1.

Table 1. Comparison of Branch-Office Architectures

Attribute	Serverless	Lean	Full-Service
Performance	Limited by WAN link bandwidth and latency	Optimized	High
Availability	Limited by WAN reliability and congestion	Optimized for mission-critical applications	High
Equipment cost	Minimal	Low	High
Operating cost	Minimal	Low	High
Management	Simple	Varies	Complex
Infrastructure utilization	High	Varies	Low
Application time to deployment	Fast	Varies	Slow

The lean branch office:

- Fully relies on the WAN link to deliver most applications from the data center
- Locally hosts essential infrastructure services and mission-critical business applications
- Typically needs a small number of physical servers for local applications and services
- Provides low cost and simplicity for the applications that can be centralized into the data center
- Offers performance and availability guarantees for the applications that are critical to the business

Today you have many options for building and operating a lean branch-office infrastructure. However, most of these options lead to unnecessary complexity and costs. The following sections summarize the top challenges stemming from the use of typical infrastructure building blocks available today.

Physical Servers

A typical lean branch office runs five or six of the previously mentioned services and applications. They can be provisioned in several ways:

- Dedicated physical server for each application: This setup isolates applications from each other for organizational, security, performance, or application availability reasons. However, it increases equipment and operating costs.
- Multiple applications share one physical server: This setup reduces costs, but it creates access control, organizational coordination, application availability, and time-to-deployment complexity.

Converting physical servers to virtual servers and running them on top of a virtualized platform offers the best of both scenarios while reducing costs. Each application is assigned to a dedicated virtual server, and all virtual servers are hosted on one or two physical servers.

Server Form Factors

A typical lean branch office has several server form-factor options, including:

- Tower servers: This setup provides a general-purpose platform for a wide variety of applications, but it creates complex, hardwired infrastructure that is costly to build and modify. Short product lifecycles require frequent replacements that often result in overprovisioned and underused systems.
- WAN optimization appliances: Dedicated partitions on WAN optimization devices host lightweight virtualized applications, but the small amount of available hardware resources limits the scalability and the type of branch-office applications that can be hosted.

Using the x86 blade server computing platform provides the best of both scenarios while reducing costs. Blade servers provide a general-purpose platform, share common components, are energy efficient, and offer easy hardware provisioning with remote management.

Device Sprawl

Today branch-office infrastructure is divided between networking devices and servers. This setup leads to redundancies and device sprawl, and it creates several challenges, including:

- Proliferation of wires and components: Maintaining unconsolidated infrastructure leads to excess wires, ports, and cooling; extra physical space; and other redundancies, ultimately leading to a higher TCO.
- High-touch, hardwired infrastructure: Physical cabling creates an infrastructure in the remote office that requires modification through costly onsite visits.

Housing all network devices and servers in a single chassis and using a network platform to connect and integrate the various elements replaces a physically wired infrastructure with one that is soft-wired and remotely manageable.

Cisco UCS Express addresses all these lean branch-office challenges by providing a converged computing, virtualization, and networking platform.

Product Description

Cisco UCS Express is a platform for hosting essential infrastructure services and mission-critical business applications in the lean branch office. It consists of three platforms:

- Network platform: Servers and network devices can be housed under one chassis - the Cisco ISR G2. A multigigabit backplane switch directly connects the different components together without any need for physical wires.
- Computing platform: The x86 blade server - the form factor favored in data centers - is available to small and medium-sized branch offices and can be housed in the most widely deployed branch-office device, the Cisco Integrated Services Router (ISR).
- Virtualization platform: A joint Cisco and VMware solution that provides a bare-metal hypervisor for the branch office enables consolidation of physical servers.

Although the physical infrastructure has been converged, the management of each platform has not. The same familiar tools used to manage the different functional domains - servers, virtualization, and network with their separated access control - are used to manage Cisco UCS Express.

Cisco UCS Express consists of several components, shown in Figure 2.

Figure 2. Cisco UCS Express Components

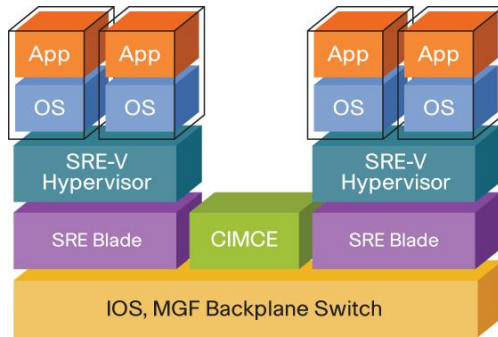

Integrated Network Platform

Cisco ISR G2 functions as a blade-server enclosure for Cisco UCS Express. The Cisco ISR is one of the most widely deployed branch-office devices, and it already has slots for various networking modules, as shown in Figure 3. Now you can reuse the same slots for x86 blade servers. Moreover, the Cisco ISR G2 provides a comprehensive portfolio of branch-office services: network connectivity, security, wireless mobility, WAN optimization, unified communications, and application integration. Combined with Cisco UCS Express, the Cisco ISR G2 is the only networking platform on the market that provides all branch-office services integrated into a single device.

Figure 3. Cisco 2900 and 3900 Series ISRs



The MGF backplane switch connects the virtual network across multiple hypervisors and allows direct access to the LAN either through the Cisco EtherSwitch[®] enhanced high-speed WAN interface cards (EHWICs) or Cisco EtherSwitch service modules, shown in Figure 4, without sending the traffic through the router CPU. The Cisco EtherSwitch modules are not required for Cisco UCS Express; however, they simplify configuration and improve performance. Cisco IOS[®] Software provides Inter-VLAN routing and other Layer 3 features to hypervisor networks. Figure 5 shows possible MGF use cases.

Figure 4. Cisco EtherSwitch EHWICs and Service Modules

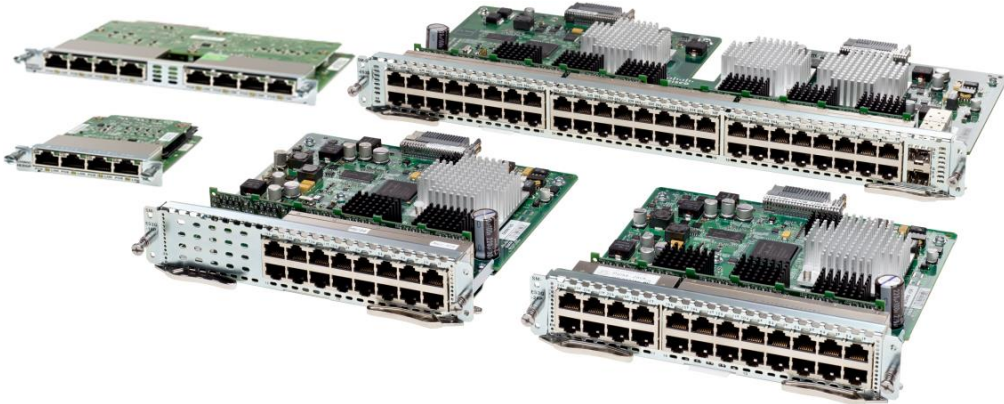
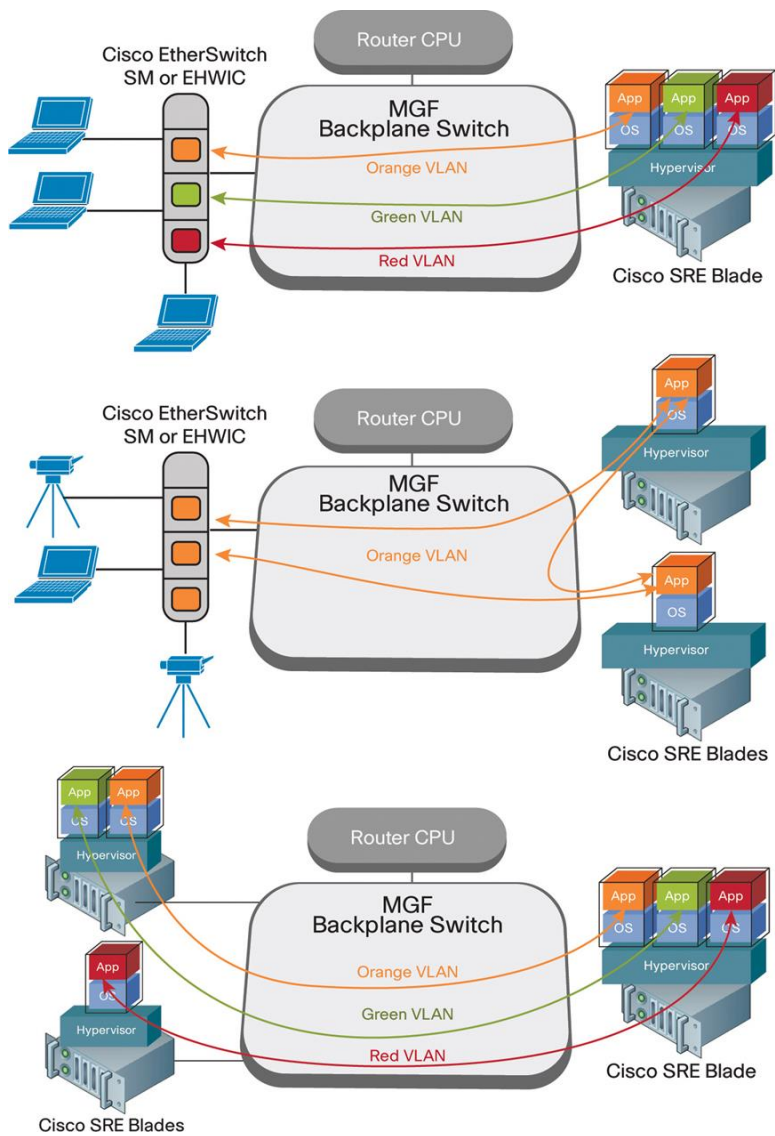

Figure 5. Cisco UCS Express MGF Backplane Switch Use Cases



x86 Blade Server Computing Platform

Cisco UCS Express takes advantage of x86 server features offered by the SRE blades (Figure 6). Cisco SRE blades have their own processors, storage, network interfaces, and memory that operate independently of the host router resources, helping ensure optimal concurrent routing and application performance. The blades have lower energy consumption, shipping weight, physical size, wiring, and cabling than typical tower servers. Cisco SRE blades provide simple and fast hardware provisioning that nontechnical branch-office employees can perform. In addition, Cisco SRE provides on-demand application deployment with the capability to remotely provision the Cisco SRE virtualization platform on the blade at any time.

Figure 6. Cisco SRE x86 Blade Server

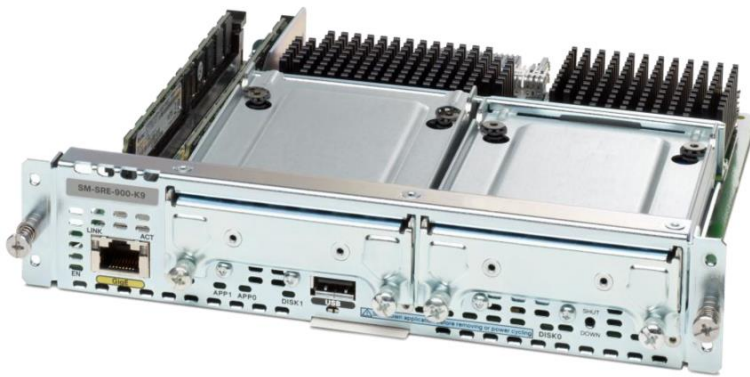

Cisco ISR G2 routers provide the Cisco SRE blades with power, cooling, and backplane switch integration as in a typical blade-server chassis. Each Cisco SRE blade is connected to the router by two Gigabit Ethernet interfaces, as shown in Figure 7. One is a Layer 2 interface that connects the blade directly to the MGF backplane switch; it is used for virtual server traffic. The other is a Layer 3 interface that connects the blade to the Cisco ISR G2 route engine; it is used for management traffic. The third external Gigabit Ethernet port is provided for redundancy and other uses.

Figure 7. Cisco SRE 910 ISR G2 Architecture

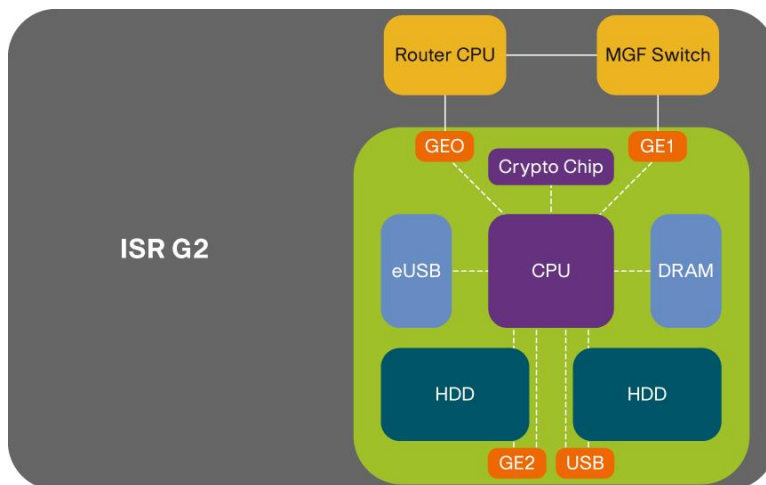

Bare-Metal Hypervisor Virtualization Platform

Cisco has joined with VMware to create the Cisco SRE Virtualization (SRE-V) platform - the VMware vSphere Hypervisor (ESXi) optimized for the SRE blades. Cisco SRE-V is a bare-metal hypervisor that runs directly on the SRE hardware. The hypervisor provides virtual hardware containers for hosting applications and operating systems (virtual servers), as shown in Figure 8. Virtual servers can be provisioned more quickly than their physical counterparts; require less space, power, and cooling than multiple physical servers; and provide better crash protection and faster crash recovery than physical systems.

Figure 8. Cisco SRE-V Architecture

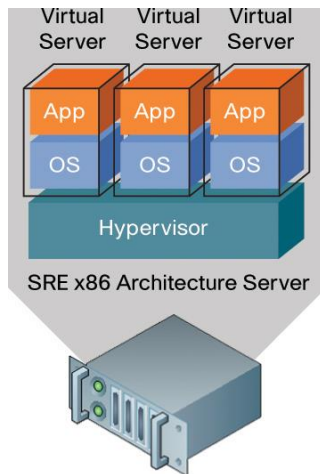

A hypervisor imposes the following set of attributes on virtual servers that traditional x86 servers lack:

- Isolation: A virtual server is confined to one container and is unaware of other virtual servers.
- Multiplicity: A virtual server shares hardware concurrently with other virtual servers.
- Abstraction: A virtual server is hardware-independent and can run on various platforms.
- Encapsulation: A virtual server stores its complete point-in-time execution state in a file.

These fundamental attributes are the building blocks of the higher-level virtualization capabilities (Figure 9).

Figure 9. Fundamental Properties of a Virtualization Platform

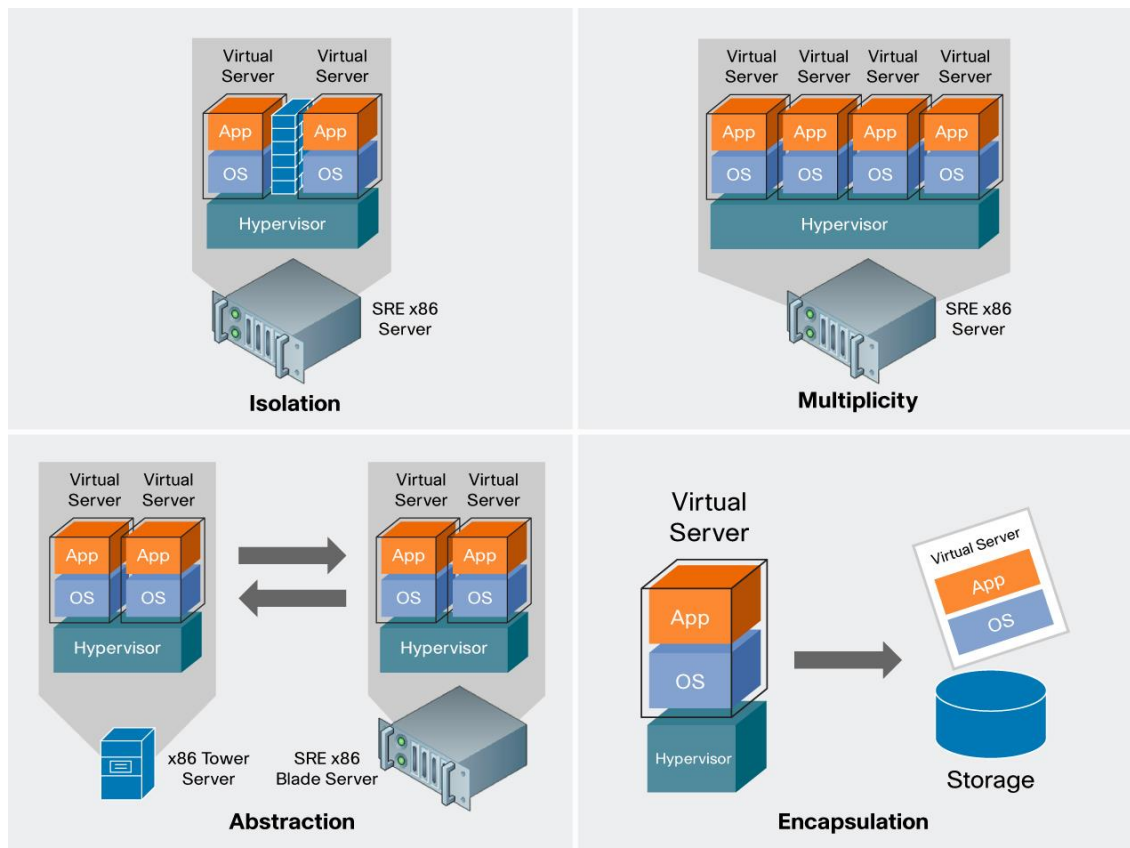

VMware vSphere Hypervisor (ESXi) is a high-performance, enterprise- and production-class hypervisor. It has been optimized for the Cisco SRE blade to provide features such as serial console access. The initial version of Cisco SRE-V is equivalent to Version 4.1 of the VMware vSphere Hypervisor.

Microsoft Windows Server Platform

Cisco UCS Express has undergone the Microsoft certification process for Microsoft Windows Server. The Cisco SRE blade hardware has passed Microsoft Windows Hardware Quality Lab (WHQL) testing and has been certified for compatibility with Microsoft Windows Server 2003 and 2008. The Cisco SRE-V platform has passed Microsoft Server Virtualization Validation Program (SVVP) testing and has been certified for supportability with Microsoft Windows Server 2003 and 2008. Table 2 summarizes the certified Microsoft Windows operating systems.



Table 2. Microsoft Windows Operating Systems Certified for Cisco UCS Express

Operating System	Certifications
Microsoft Windows Server 2003 SP2 Standard (32- and 64-bit)	WHQL and SVVP
Microsoft Windows Server 2003 SP2 Enterprise (32- and 64-bit)	WHQL and SVVP
Microsoft Windows Server 2008 R2 Standard	WHQL and SVVP
Microsoft Windows Server 2008 R2 Enterprise	WHQL and SVVP

VMware vSphere Hypervisor (ESXi) supports a large number of operating systems, which should function as expected. Most distributions of enterprise-class Linux operating systems, including Red Hat Enterprise Linux, Novell SUSE Linux Enterprise Server, and Oracle Linux, have been verified to work on top of the Cisco SRE-V platform.

Integrated Blade Management

Cisco UCS Express provides lights-out management for SRE blades through Cisco IMC Express. Cisco IMC Express performs the function of a baseboard management controller for all Cisco SRE blades present in the Cisco ISR G2 chassis, as shown in Figure 10. With Cisco IMC Express, you can provision the hypervisor on the Cisco SRE blades, configure interfaces, monitor hardware status, and manage power for the blades. Cisco UCS Express is embedded in the Cisco ISR G2 motherboard, runs on dedicated hardware resources, and operates independently of the Cisco IOS Software process.

Figure 10. Cisco IMC Express Architecture for Cisco 3945 ISR

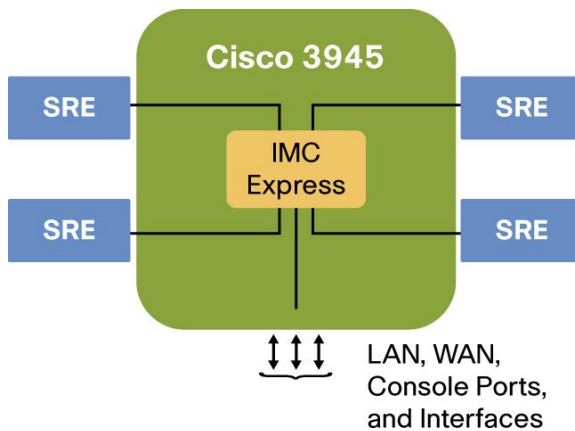

Cisco IMC Express offers command-line interface (CLI) and GUI management consoles, as shown in Figure 11. Both have the same user interface as Cisco IMC for Cisco UCS C-Series Rack-Mount Servers, providing management consistency between Cisco data center and branch-office servers.

Figure 11. Cisco IMC Express User Interfaces

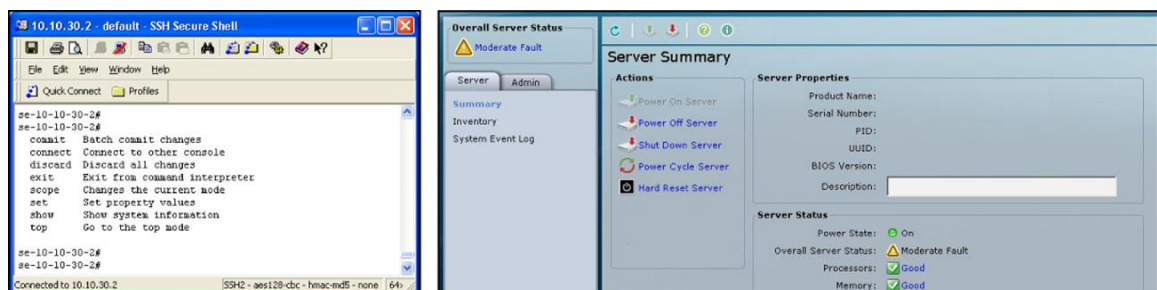

Domain-Based Management

Cisco UCS Express offers domain-based separation of management functions. The system is designed to provide convergence of networking, computing, and virtualization platforms; however, management was explicitly designed to maintain the traditional access-control boundaries between networking and computing teams. Access to network management tools is controlled and enforced by the Cisco IOS Software. The user accounts created to manage the router cannot access the virtualization or computing management tools. Access to virtualization management tools is controlled and enforced by Cisco SRE-V Software or VMware vCenter Server. The user accounts created to manage the hypervisor cannot access the networking or compute management tools. Access to the computing management tools is controlled by Cisco IMC Express. The user accounts created to manage the Cisco SRE blades cannot access the networking or virtualization management tools. Cisco UCS Express uses familiar management tools to manage the platform (Table 3).

Table 3. Management Tools for Cisco UCS Express

Platform	Management Tool
Cisco ISR G2 with MGF switch	Cisco Configuration Professional, CiscoWorks LAN Management Solution (LMS), and CLI
Cisco SRE-V	VMware vSphere Client and vCenter Server
Cisco SRE blades	Cisco IMC Express

Cisco UCS Express Advantage

Cisco UCS Express provides lower TCO than alternative solutions. It offers the following cost savings in comparison to tower servers with virtualization:

- Hardware support included in Cisco SMARTnet[®] Services support for router
- Virtualization support included in Cisco SMARTnet Services support for router
- Reduced device and cooling power consumption
- Fewer onsite visits and lower shipping costs
- No wires or ports plus reduced physical space

Figure 12 compares the 3-year TCO of an equally priced Cisco UCS Express system and a tower server with VMware vSphere Hypervisor. In this example, the TCO of Cisco UCS Express is approximately 50 percent lower than that of the tower server.

Figure 12. Three-Year TCO for Cisco UCS Express Compared to That of Equivalent Tower Server with Virtualization

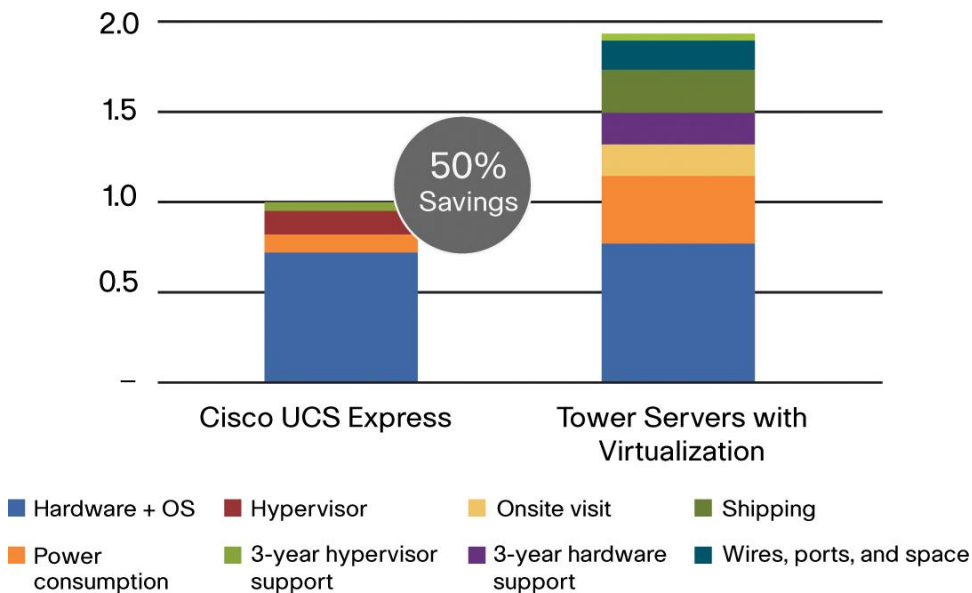
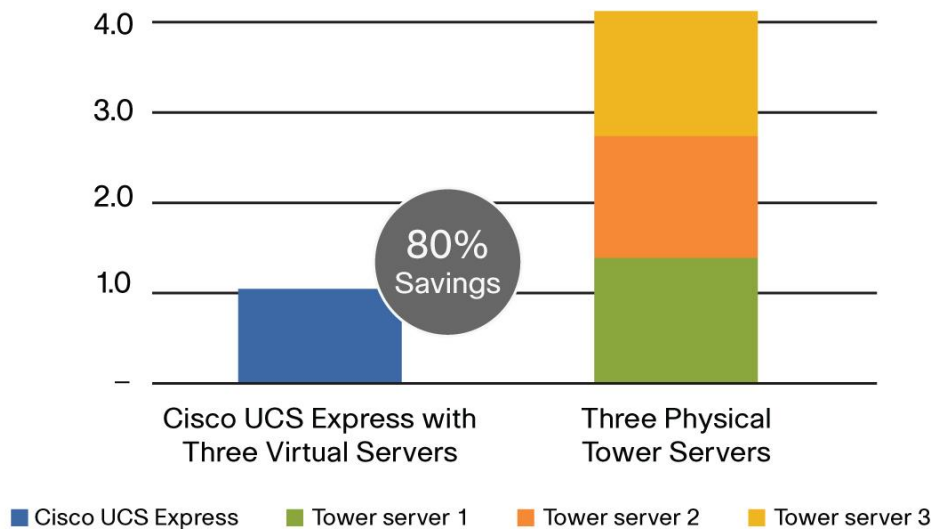

Figure 13 compares the cost savings achieved by converting three physical servers to virtual servers and consolidating them on a single Cisco UCS Express SRE blade server. In this example, the TCO for Cisco UCS Express is approximately 75 percent lower than that for the three physical servers.

Figure 13. Cost Savings for Cisco UCS Server with 3:1 Consolidation Ratio Compared to Three Physical Servers



Features and Benefits

Table 4 lists the features and benefits of Cisco UCS Express.

Table 4. Cisco UCS Express Features and Benefits

Features	Benefits
Cisco ISR G2 Networking Platform	
Blade-server enclosure	<p>Compact and energy-efficient form factor:</p> <ul style="list-style-type: none"> • Two-rack-unit (2RU) and 3RU height and 12- and 19-in.(30- and 50-cm) width options • Typical consumption of 100 to 200 watts of power with one Cisco SRE blade • Options for 1, 2, and 4 Cisco SRE blades depending on the Cisco ISR G2 model <p>Long service life and high reliability:</p> <ul style="list-style-type: none"> • Designed for long service life: typically 5 to 6 years • Designed for high reliability: up to 300,000 hours mean time between failures (MTBF) • Redundant-power-supply options on Cisco 3900 Series ISRs
All-in-one device integration	<p>Platform for all branch-office services:</p> <ul style="list-style-type: none"> • Network connectivity (routing, switching, IP addressing, and quality of service [QoS]) • Wireless mobility (wireless WAN [WWAN] interfaces and wireless LAN [WLAN] controllers) • Security (VPN; intrusion prevention system [IPS]; firewall; authentication, authorization, and accounting [AAA]; and more) • Unified communications (voice gateways, call processing, voicemail, and others) • WAN optimization and application acceleration • Applications (Cisco UCS Express computing and virtualization platform)
MGF backplane switch	<p>Router CPU offload:</p> <ul style="list-style-type: none"> • Direct connection of Cisco SRE blade to Cisco SRE blade • Access to branch-office LAN at gigabit speeds <p>Layer 2 and 3 features for hypervisor networks:</p> <ul style="list-style-type: none"> • Capability to join VLANs across hypervisors or external switches • Inter-VLAN Routing (IVR) for hypervisor virtual networks • Capability to apply Cisco IOS Software features to hypervisor networks
Cisco SRE x86 Blade Server Computing Platform	
Blade-server form factor	<p>Easy and fast hardware provisioning:</p> <ul style="list-style-type: none"> • Little skill required to provision the server • Wire- and cable-free integration into network <p>Compact and energy-efficient form factor:</p> <ul style="list-style-type: none"> • Consumes a maximum of 50 watts (W) of power • Takes up no additional physical space • Has low shipping weight
Right-size hardware profile	<p>Designed for lean branch-office services and applications:</p> <ul style="list-style-type: none"> • Core Microsoft Windows services • Mission-critical business applications • Client management services <p>General-purpose server hardware configuration:</p> <ul style="list-style-type: none"> • x86 64-bit single- or multicore processor options • Up to 1 terabyte (TB) of hard-disk storage capacity • Up to 8 GB of dynamic random access memory (DRAM) • Field-replaceable disks • Hardware-assisted virtualization • Three Gigabit Ethernet ports
On-demand deployment	<p>Multipurpose Cisco SRE blades and on-demand deployment:</p> <ul style="list-style-type: none"> • Deploy Cisco SRE blade today and postpone Cisco SRE-V deployment until needed • Provision Cisco SRE-V software remotely without onsite visit • Replace existing Cisco SRE applications with Cisco SRE-V software

Features	Benefits
Cisco SRE-V Virtualization Platform	
Virtual server platform	Consolidate physical servers: <ul style="list-style-type: none"> • Reduce number of physical servers • Save on power and cooling costs • Increase utilization of available hardware
Improved application service levels	Isolate applications as individual virtual servers: <ul style="list-style-type: none"> • Prevent a faulty application from crashing other applications • Patch, update, or upgrade transparently to other applications • Power one application on and off without taking others offline
Faster application deployment	Isolate applications as individual virtual servers: <ul style="list-style-type: none"> • Faster implementation of changes for existing applications • Less coordination, planning, and testing needed to deploy new applications
Management	
Blade management	Lights-out hardware management: <ul style="list-style-type: none"> • Provision, configure, and monitor Cisco SRE blades • Manage multiple blades from a single pane • Intuitive CLI and GUI management consoles Power management: <ul style="list-style-type: none"> • Manually power cycle blades remotely • Schedulable on and off times for power savings
Domain-based management	Consolidate platforms and maintain functional separation: <ul style="list-style-type: none"> • Dedicated user management and access control for networking • Dedicated user management and access control for blade server • Dedicated user management and access control for virtualization

Supported Platforms

Table 5 lists the supported Cisco SRE platforms, and Table 6 lists the Cisco EtherSwitch modules that support the Cisco ISR G2 MGF. Cisco IMC Express runs on the Cisco ISR G2 motherboard and requires additional memory and two compact flash cards, as shown in Table 7.

Table 5. Supported Cisco SRE Platforms

Feature	Cisco SRE 700 and SRE 710 Service Module	Cisco SRE 900 and SRE 910 Service Module
CPU	Intel Core 2, 1.86-GHz (single core)	Intel Core 2 Duo 1.,86-GHz (dual core)
DRAM	4 GB (two 2-GB dual inline memory modules [DIMMs])	4 GB (default) and 8 GB (two 4-GB DIMMs)
Hard-disk drive (HDD)	One 500-GB Serial Advanced Technology Attachment (SATA) drive <ul style="list-style-type: none"> • 5400 rpm (SRE 700) • 7200 rpm (SRE 710) 	Two 500-GB SATA <ul style="list-style-type: none"> • 5400 rpm (SRE 900) • 7200 rpm (SRE 910)
Redundant Array of Independent Disks (RAID) options	None	Non-RAID, RAID 0, and RAID 1 (Software RAID controller in Cisco SRE-V)
Network interface card (NIC)	Three Gigabit Ethernet ports	Three Gigabit Ethernet ports
I/O	One external USB port	One external USB port
Supported ISRs	Cisco 2911, 2921, 2951, 3925, 3925E, 3945, and 3945E	Cisco 2911, 2921, 2951, 3925, 3925E, 3945, and 3945E

Table 6. Cisco ISR G2 MGF Supported Cisco EtherSwitch Modules

Cisco EtherSwitch EHWIC	Cisco EtherSwitch Service Module
EHWIC-D-8ESG-P=, EHWIC-D-8ESG-P, EHWIC-D-8ESG=, EHWIC-D-8ESG, EHWIC-4ESG-P=, EHWIC-4ESG-P, EHWIC-4ESG=, and EHWIC-4ESG	SM-D-ES3G-48-P, SM-D-ES3-48-P, SM-D-ES2-48, SM-ES3G-24-P, SM-ES3-24-P, SM-ES2-24-P, SM-ES2-24, SM-ES3G-16-P, SM-ES3-16-P, and SM-ES2-16-P

Table 7. Cisco IMC Express Memory and Compact Flash Requirements for ISRs

Cisco ISR G2	Minimum ISR DRAM	Minimum ISR Compact Flash Memory
Cisco 2911	1 GB	512 and 256 MB
Cisco 2921	1 GB	512 and 256 MB
Cisco 2951	1.5 GB	512 and 256 MB
Cisco 3925	2 GB	512 and 256 MB
Cisco 3925E	Does not support Cisco IMC Express	Does not support Cisco IMC Express
Cisco 3945	2 GB	512 and 256 MB
Cisco 3945E	Does not support Cisco IMC Express	Does not support Cisco IMC Express

Older enhanced network modules (NMEs) and HWIC Cisco EtherSwitch modules will work with Cisco UCS Express but cannot take advantage of the MGF backplane switch.

Licensing

Cisco UCS Express provides license-based activation for the Cisco SRE-V software. Table 8 lists the permanent Cisco UCS Express licenses. By default, the Cisco SRE-V Software comes with a one-time evaluation license. When you order Cisco SRE and SRE-V without a permanent license, or when you download Cisco SRE-V software from Cisco.com and install it on the Cisco SRE, the evaluation license will enable full Cisco SRE-V functions for 60 days. The built-in evaluation license gives you an opportunity to try the product before making a purchase decision. To activate the permanent license past the evaluation period, you must purchase a spare product authorization key and redeem it for a permanent Cisco SRE-V license key online at the VMware website.

Table 8. Cisco UCS Express Licenses

License Part Number	Description
FL-SRE-V-HOST	License to permanently activate Cisco SRE-V. Paper delivery. Installed and activated by user.
FL-SRE-V-HOST=	Product authorization key to permanently activate Cisco SRE-V license. Paper delivery. Installed and activated by user.
L-FL-SRE-V-HOST=	Product authorization key to permanently activate Cisco SRE-V license. Electronic delivery. Installed and activated by user.
FL-SRE-V-HOSTVC	License to permanently activate Cisco SRE-V with VMware vCenter Server management agent. Paper delivery. Installed and activated by user.
FL-SRE-V-HOSTVC=	Product authorization key to permanently activate Cisco SRE-V with VMware vCenter Server management agent. Paper delivery. Installed and activated by user.
L-FL-SRE-V-HOSTVC=	Product authorization key to permanently activate Cisco SRE-V with VMware vCenter Server management agent. Electronic delivery. Installed and activated by user.
FL-SRE-V-VC-UPG=	Product authorization key to permanently activate VMware vCenter Server management agent on existing Cisco SRE-V host. Paper delivery. Installed and activated by user.
L-FL-SRE-V-VC-UPG=	Product authorization key to permanently activate VMware vCenter Server management agent on existing Cisco SRE-V host. Electronic delivery. Installed and activated by user.

Product Specifications

Cisco UCS Express integrates and consolidates several existing hardware products. Detailed specifications are available at the locations listed in Table 9.

Table 9. Product Specifications

Product	Data Sheet
Cisco 2900 Series	http://www.cisco.com/en/US/prod/collateral/routers/ps10537/data_sheet_c78_553896.html
Cisco 3900 Series	http://www.cisco.com/en/US/prod/collateral/routers/ps10536/data_sheet_c78_553924.html
Cisco SRE	http://www.cisco.com/en/US/prod/collateral/modules/ps10598/data_sheet_c78-553913.html
Cisco EtherSwitch EHWIC	http://www-europe.cisco.com/en/US/prod/collateral/routers/ps10536/data_sheet_c78-612808.html
Cisco EtherSwitch service module	http://www.cisco.com/en/US/prod/collateral/routers/ps10536/data_sheet_c78-553980.html

System Requirements

For the Cisco MGF backplane switch and Cisco IMC Express to function, Cisco UCS Express requires Cisco IOS Software Release 15.1(4)M for Cisco 2911, 2921, 2951, 3925, 3925E, 3945, and 3945E ISRs.

Warranty Information

Cisco SRE blades are covered by a 90-day warranty. Find warranty information on Cisco.com at the [Product Warranties](#) page.

Ordering Information

To place an order, visit the [Cisco Ordering homepage](#) and refer to Table 10. To download software, visit the [Cisco Software Center](#). The Cisco SRE-V software is available only from Cisco, not VMware.

Table 10. Ordering Information

Part Number	Product Description
SM-SRE-700-K9 SM-SRE-710-K9	Cisco SRE 700/710 service module, with 4GB DRAM, 500 GB HDD, Intel® Core™ 2 Uno 1.86 GHz (single core).
SM-SRE-900-K9 SM-SRE-910-K9	Cisco SRE 900/910 service module, with 4GB DRAM, two 500 GB HDDs, Intel Core2 Duo 1.86 GHz (dual core).
SM-MEM-VLP-4GB	4GB DRAM factory ¹ upgrade option for SRE 900 and SRE 910.
SM-DSK-SATA-500GB=	Spare 500GB HDD for field-replacement for SRE 700 and SRE 900.
SM-HDD-SATA-500GB=	Spare 500GB HDD for field-replacement for SRE 710 and SRE 910.
FL-SRE-V-HOST	License to permanently activate Cisco SRE-V. Paper delivery. Installed and activated by user.
FL-SRE-V-HOST=	Product authorization key to permanently activate Cisco SRE-V license. Paper delivery. Installed and activated by user.
L-FL-SRE-V-HOST=	Product authorization key to permanently activate Cisco SRE-V license. Electronic delivery. Installed and activated by user.
FL-SRE-V-HOSTVC	License to permanently activate Cisco SRE-V with VMware vCenter Server management agent. Paper delivery. Installed and activated by user.
FL-SRE-V-HOSTVC=	Product authorization key to permanently activate Cisco SRE-V with VMware vCenter Server management agent. Paper delivery. Installed and activated by user.
L-FL-SRE-V-HOSTVC=	Product authorization key to permanently activate Cisco SRE-V with VMware vCenter Server management agent. Electronic delivery. Installed and activated by user.
FL-SRE-V-VC-UPG=	Product authorization key to permanently activate VMware vCenter Server management agent on existing Cisco SRE-V host. Paper delivery. Installed and activated by user.

Part Number	Product Description
L-FL-SRE-V-VC-UPG=	Product authorization key to permanently activate VMware vCenter Server management agent on existing Cisco SRE-V host. Electronic delivery. Installed and activated by user.
MSWS-08R2ST-X86-K9	Microsoft Windows Server 2008 R2 Standard.
DISK-MODE-RAID-1 DISK-MODE-RAID-0	Factory configuration options for RAID 1 (mirroring) and RAID 0 (striping) settings.

¹The Cisco SRE 900 and SRE 910 service module memory is not field upgradable.

Several bundle offers are available for Cisco UCS Express to simplify ordering and provide additional savings on multiproduct solutions, as shown in Table 11. All Cisco UCS Express bundles come with the Cisco SRE 900 or SRE 910, Cisco SRE-V hypervisor software, maximum Cisco ISR DRAM, Cisco IMC Express software, and additional Compact Flash memory for the Cisco IMC Express. You can optionally purchase VMware vCenter Server management agent with any of the Cisco UCS Express bundles.

Table 11. Cisco UCS Express Bundles

Part Number	Description
C3945-UCSE/K9	Cisco 3945 UCSE Bundle, SRE 900 or SRE 910,SRE-V License, 4 GB ISR DRAM, 768 MB ISR Compact Flash, IMC Express
C3925-UCSE/K9	Cisco 3925 UCSE Bundle, SRE 900 or SRE 910,SRE-V License, 4 GB ISR DRAM, 768 MB ISR Compact Flash, IMC Express
C2951-UCSE/K9	Cisco 2951 UCSE Bundle, SRE 900 or SRE 910,SRE-V License, 4 GB ISR DRAM, 768 MB ISR Compact Flash, IMC Express
C2921-UCSE/K9	Cisco 2921 UCSE Bundle, SRE 900 or SRE 910,SRE-V License, 2.5 GB ISR DRAM, 768 MB ISR Compact Flash, IMC Express
C2911-UCSE/K9	Cisco 2911 UCSE Bundle, SRE 900 or SRE 910,SRE-V License, 2.5 GB ISR DRAM, 768 MB ISR Compact Flash, IMC Express
C3945-ES24-UCSE/K9	Cisco 3945 ES24 UCSE Bundle, SRE 900 or SRE 910,SRE-V License, 24 port Layer 3 PoE EtherSwitch SM, PoE Power Supply, 4 GB ISR DRAM, 768 MB Compact Flash, IMC Express
C3925-ES24-UCSE/K9	Cisco 3925 ES24 UCSE Bundle, SRE 900 or SRE 910,SRE-V License, 24 port Layer 2 PoE EtherSwitch SM, PoE Power Supply, 4 GB ISR DRAM, 768 MB ISR Compact Flash, IMC Express
C2951-ES24-UCSE/K9	Cisco 2951 ES24 UCSE Bundle, SRE 900 or SRE 910,SRE-V License, 24 port Layer 2 EtherSwitch SM, 4 GB ISR DRAM, 768 MB ISR Compact Flash, IMC Express
C3945-WAAS-UCSE/K9	Cisco 3945 UCSE Bundle, two SRE 900 or SRE 910,SRE-V License, WAAS Enterprise Medium License, 4 GB ISR DRAM, 768 MB ISR Compact Flash, IMC Express
C3925-WAAS-UCSE/K9	Cisco 3925 UCSE Bundle, two SRE 900 or SRE 910,SRE-V License, WAAS Enterprise Medium License, 4 GB ISR DRAM, 768 MB ISR Compact Flash, IMC Express
C2951-WAAS-UCSE/K9	Cisco 2951 UCSE Bundle, two SRE 900 or SRE 910,SRE-V License, WAAS Enterprise Medium License, 4 GB ISR DRAM, 768 MB ISR Compact Flash, IMC Express

Services and Support Information

Cisco SRE hardware and Cisco SRE-V software service and support are covered by the Cisco SMARTnet contract for the router in which the module will reside, as shown in Figure 14. The support for Cisco SRE-V is provided by the Cisco Technical Assistance Center (TAC), not VMware. Cisco SMARTnet technical support is available on a one-time or annual contract basis. Support options range from help-desk assistance to proactive, onsite consultation.

All support contracts include:

- Major Cisco IOS Software updates for protocol, security, bandwidth, and feature improvements
- Full access rights to Cisco.com technical libraries for technical assistance, electronic commerce, and product information
- Access to the industry's largest dedicated technical support staff 24 hours a day

For more information about Cisco services, refer to [Cisco Technical Support Services](#) or [Cisco Advanced Services](#).

Figure 14. Cisco UCS Express Support Model

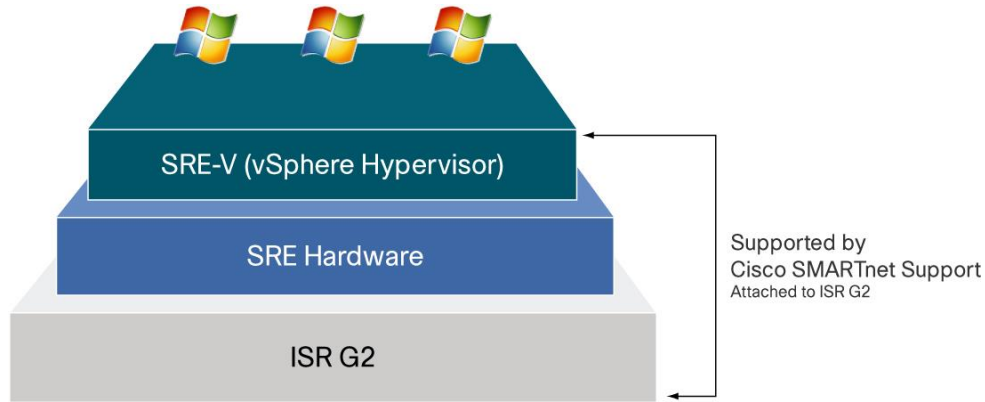

The Cisco UCS Express bundles have specific Cisco SMARTnet technical services contracts, as shown in Table 12. The Cisco UCS Express and Cisco Wide Area Application Services (WAAS) bundles include the Cisco WAAS Software Application Support and Upgrade (SASU) contract.

Table 12. Cisco SMARTnet Support for Cisco UCS Express Bundles

Bundle Part Number	Technical Services (Cisco SMARTnet 8 Hours a Day, 5 Days a Week, Next-Business Day [8x5xNBD] Service)*
C3945-UCSE/K9	CON-SNT-3945UCSE
C3925-UCSE/K9	CON-SNT-3925UCSE
C2951-UCSE/K9	CON-SNT-UCSEK9
C2921-UCSE/K9	CON-SNT-CUCSEK9
C2911-UCSE/K9	CON-SNT-2911UCSE
C3945-ES24-UCSE/K9	CON-SNT-3945ES24
C3925-ES24-UCSE/K9	CON-SNT-3925ES24
C2951-ES24-UCSE/K9	CON-SNT- ES24UCSE
C3945-WAAS-UCSE/K9	CON-SNT-3945WAUC
C3925-WAAS-UCSE/K9	CON-SNT-3925WAUC
C2951-WAAS-UCSE/K9	CON-SNT-WAASUCSE

* Cisco offers several technical services options. The 8x5xNBD service is listed here as an example. Please refer to the Cisco price list for other technical services options.

Cisco and Partner Services for the Branch Office

Services from Cisco and our certified partners can help you transform the branch-office experience and accelerate business innovation and growth in Cisco Borderless Networks. We have the depth and breadth of expertise to create a clear, replicable, optimized branch-office footprint across technologies. Planning and design services align technology with business goals and can increase the accuracy, speed, and efficiency of deployment. Technical services help improve operational efficiency, save money, and mitigate risk. Optimization services are designed to continuously improve performance and help your team succeed with new technologies. For more information, visit <http://www.cisco.com/go/services>.

For More Information

For more information about Cisco UCS Express, visit <http://www.cisco.com/go/ucse/> or contact your local Cisco account representative.

For more information about Cisco products, contact:

- United States and Canada: 800 553 NETS (6387)
- Europe: 32 2 778 4242
- Australia: 612 9935 4107
- Other: 408 526 7209



Americas Headquarters
Cisco Systems, Inc.
San Jose, CA

Asia Pacific Headquarters
Cisco Systems (USA) Pte. Ltd.
Singapore

Europe Headquarters
Cisco Systems International BV Amsterdam,
The Netherlands

Cisco has more than 200 offices worldwide. Addresses, phone numbers, and fax numbers are listed on the Cisco Website at www.cisco.com/go/offices.

Cisco and the Cisco Logo are trademarks of Cisco Systems, Inc. and/or its affiliates in the U.S. and other countries. A listing of Cisco's trademarks can be found at www.cisco.com/go/trademarks. Third party trademarks mentioned are the property of their respective owners. The use of the word partner does not imply a partnership relationship between Cisco and any other company. (1005R)