

Cisco Catalyst 8300/8200 Series Edge Platforms

August 2024

The gateway to your intent-based WAN network is here

The Cisco® Catalyst® 8300 and 8200 Series Edge Platforms lay the foundation for the next generation of software-defined WAN infrastructure. They are purpose-built for SD-WAN, 5G, Cloud native agility with superior performance, higher WAN port density and redundant power supplies (C8300 only), combined with Cisco's advanced SD-WAN capabilities, now delivered through a single, unified operating system.

The Cisco Catalyst 8300 Series Edge Platforms consist of four variants and support most of the widely deployed Network Interface Modules (NIMs) and Service Modules (SMs) used in the Cisco 4000 Series Integrated Services Routers (ISR). All four Catalyst 8300 models also ship with default dual redundant power supplies.

The Cisco Catalyst 8200 Series Edge Platforms support a single Network Interface Module (NIMs) and ships with a single power supply and doesn't support any of the Service Modules (SMs).



Contents

The gateway to your intent-based WAN network is here

Ordering Cisco Catalyst 8300 and 8200 Series Edge Platforms with Cisco DNA subscriptions

Cisco DNA subscription applicability matrix for Catalyst 8300 and 8200 edge platforms

Catalyst Routing Essentials for Cisco Catalyst 8300 and 8200 Series Edge Platforms

Ordering C8200 Catalyst Routing Essentials

Ordering C8300 Catalyst Routing Essentials

Catalyst Routing Essential Sample BoM explained

Services

Cisco Smart Licensing

Warranty

Cisco Capital

Ordering information

For more information

Table 1. Product IDs of Cisco Catalyst 8300 and 8200 Series Edge Platforms

Product ID	Description
C8300-2N2S-4T2X	Cisco Catalyst 8300 Edge platform with 2 SM, 2 NIM, and 1 Pluggable Interface Module (PIM) slots 2x10GigE SFP+, 4x1GigE RJ45, 8GB DRAM, and 16 GB M.2 SSD storage (C8300 2RU with 10G WAN)
C8300-2N2S-6T	Cisco Catalyst 8300 Edge platform with 2 SM, 2 NIM, and 1 PIM slots 2x1GigE SFP, 4x1GigE RJ45, 8 GB DRAM, and 16 GB M.2 SSD storage (C8300 2RU with 1G WAN)
C8300-1N1S-4T2X	Cisco Catalyst 8300 Edge platform with 1 SM, 1 NIM, and 1 PIM slots 2x10GigE SFP+, 4x1GigE RJ45, 8 GB DRAM, and 16 GB M.2 SSD storage (C8300 1RU with 10G WAN)
C8300-1N1S-6T	Cisco Catalyst 8300 Edge platform with 1 SM, 1 NIM, and 1 PIM slots 2x1GigE SFP, 4x1GigE RJ45, 8 GB DRAM, and 16 GB M.2 SSD storage (C8300 1RU with 1G WAN)
C8200-1N-4T	Cisco Catalyst 8200 Edge platform with 1 NIM and 1 PIM slots 2x1GigE SFP, 2x1GigE RJ45, 8 GB DRAM and 16 GB M.2 SSD storage (C8200 1RU with 1G WAN)

Contents

The gateway to your intent-based WAN network is here

Ordering Cisco Catalyst 8300 and 8200 Series Edge Platforms with Cisco DNA subscriptions

Cisco DNA subscription applicability matrix for Catalyst 8300 and 8200 edge platforms

Catalyst Routing Essentials for Cisco Catalyst 8300 and 8200 Series Edge Platforms

Ordering C8200 Catalyst Routing Essentials

Ordering C8300 Catalyst Routing Essentials

Catalyst Routing Essential Sample BoM explained

Services

Cisco Smart Licensing

Warranty

Cisco Capital

Ordering information

For more information

Product ID	Description
C8200L-1N-4T	Cisco Catalyst 8200 Edge platform with 1 NIM and 1 PIM slots 2x1GigE SFP, 2x1GigE RJ45, 4 GB DRAM and 16 GB M.2 SSD storage (C8200 1RU with 500Mbps WAN)
C8200L-1N-4T	Cisco Catalyst 8200L Edge platform with 1 NIM and 1 PIM slots 2x1GigE SFP, 2x1GigE RJ45, 4 GB DRAM (C8200 1RU with 1G WAN)

The Cisco Catalyst 8300 and 8200 Series Edge Platforms must be ordered with a mandatory Cisco DNA subscription license or Catalyst Routing Essentials license along with the chassis for SD-WAN, SD-Routing or Traditional Routing deployments.

This ordering guide will take you through the steps of ordering the hardware platforms and the Cisco DNA subscriptions.

Ordering Cisco Catalyst 8300 and 8200 Series Edge Platforms with Cisco DNA subscriptions

Ordering Catalyst 8300 and 8200 Edge platforms with mandatory Cisco DNA subscriptions can be done in two ways:

Option 1: This is the easiest and the recommended way to order the Cisco Catalyst 8300 and 8200 Series Edge platforms. Order the Cisco DNA subscription along with hardware through the respective top-level platform SKUs mentioned in Table 1. Upon ordering Cisco DNA subscription along with the hardware, the subscription start-date will sync with the hardware shipment date, or you may select up to a 90-day offset.

Contents

The gateway to your intent-based WAN network is here

Ordering Cisco Catalyst 8300 and 8200 Series Edge Platforms with Cisco DNA subscriptions

Cisco DNA subscription applicability matrix for Catalyst 8300 and 8200 edge platforms

Catalyst Routing Essentials for Cisco Catalyst 8300 and 8200 Series Edge Platforms

Ordering C8200 Catalyst Routing Essentials

Ordering C8300 Catalyst Routing Essentials

Catalyst Routing Essential Sample BoM explained

Services

Cisco Smart Licensing

Warranty

Cisco Capital

Ordering information

For more information

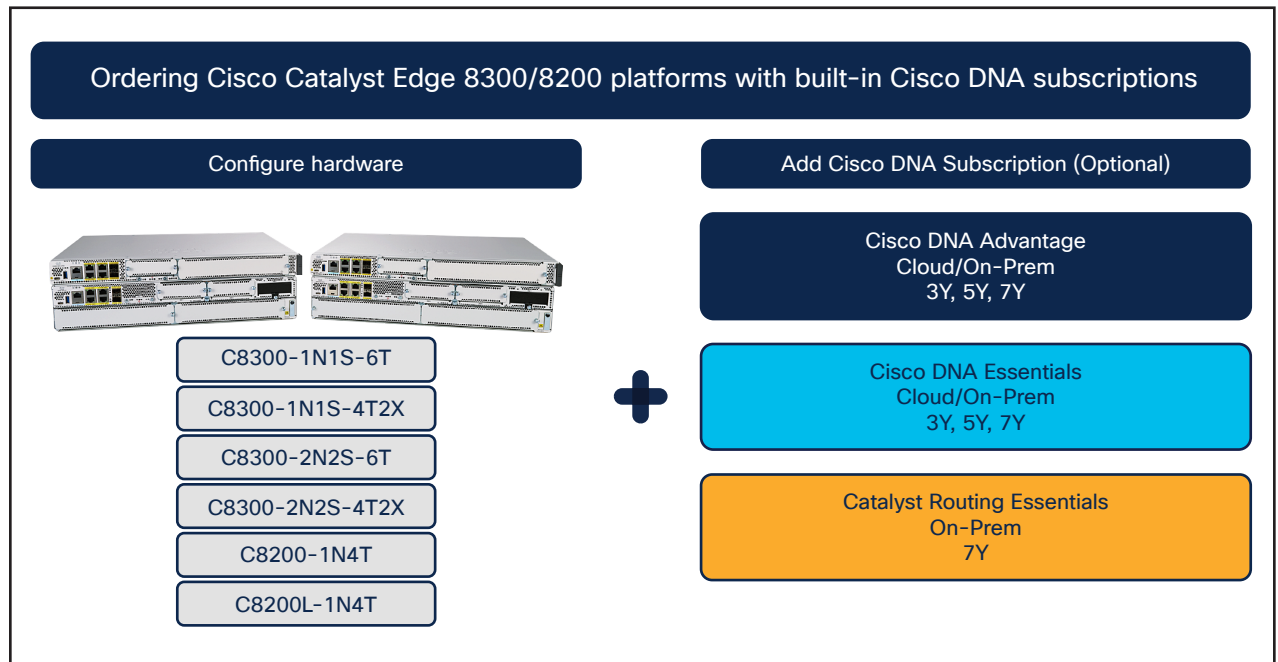

Figure 1. Overview of ordering Cisco DNA subscriptions along with hardware

Option 2: Order both the hardware and Cisco DNA subscription separately. Order Cisco Catalyst 8300 and 8200 Edge Platform hardware through respective Platform SKUs (Table 1) and subscription licenses through L-DNA-C8300 or L-DNA-C8200. Cisco DNA subscriptions ordered separately from hardware can have a maximum of 90 days offset for delaying the subscription start-date.

Contents

The gateway to your intent-based WAN network is here

Ordering Cisco Catalyst 8300 and 8200 Series Edge Platforms with Cisco DNA subscriptions

Cisco DNA subscription applicability matrix for Catalyst 8300 and 8200 edge platforms

Catalyst Routing Essentials for Cisco Catalyst 8300 and 8200 Series Edge Platforms

Ordering C8200 Catalyst Routing Essentials

Ordering C8300 Catalyst Routing Essentials

Catalyst Routing Essential Sample BoM explained

Services

Cisco Smart Licensing

Warranty

Cisco Capital

Ordering information

For more information

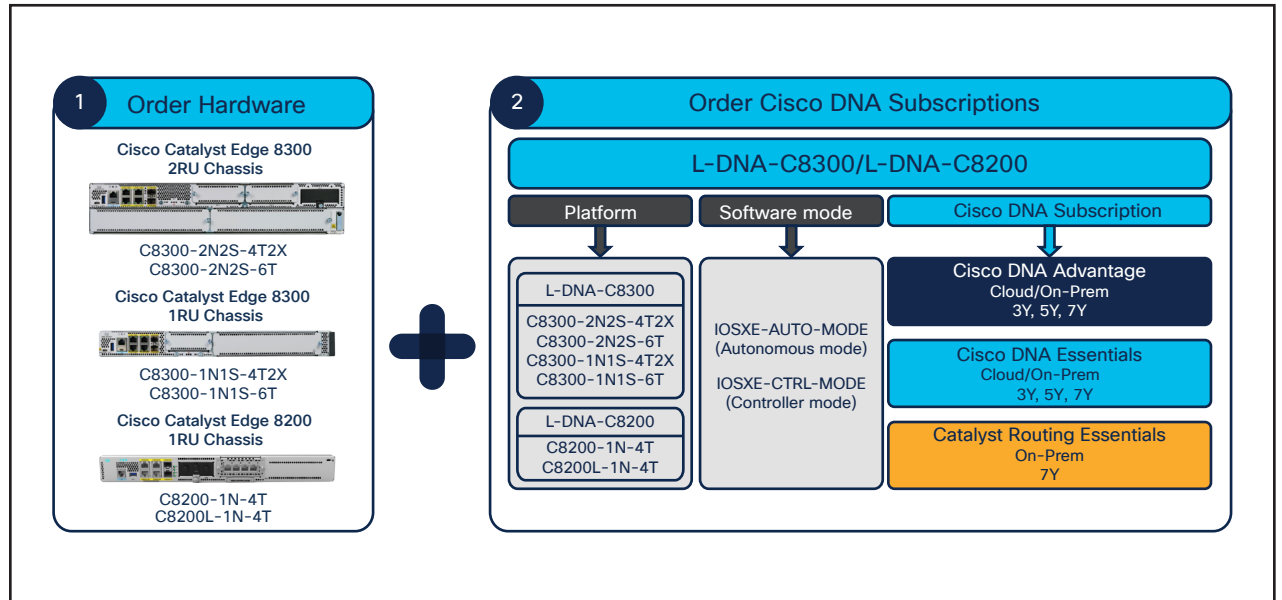

Figure 2. Overview of ordering hardware and subscription separately

Option 1: Order Cisco DNA subscription along with hardware system

The Cisco Catalyst 8300 series consists of four chassis variants (see Table 1) that differ primarily in performance capabilities, the number of NIMs/SMs slots and the 10G/1G WAN ports supported. The Cisco Catalyst 8200 series consists of two variants (see Table 1). Search and add the respective hardware platform SKU to the BOM. Use the following guidelines to configure the hardware chassis as necessary.

A. Choose the software operating system

All Catalyst 8300 platforms include a Cisco unified IOS XE Software image, which supports Cisco IOS XE based traditional deployments and IOS XE SD-WAN deployments in a single binary image. The minimum version supported for all the Catalyst 8300 edge platforms is Cisco Unified IOS XE Release 17.3.2.

Contents

The gateway to your intent-based WAN network is here

Ordering Cisco Catalyst 8300 and 8200 Series Edge Platforms with Cisco DNA subscriptions

Cisco DNA subscription applicability matrix for Catalyst 8300 and 8200 edge platforms

Catalyst Routing Essentials for Cisco Catalyst 8300 and 8200 Series Edge Platforms

Ordering C8200 Catalyst Routing Essentials

Ordering C8300 Catalyst Routing Essentials

Catalyst Routing Essential Sample BoM explained

Services

Cisco Smart Licensing

Warranty

Cisco Capital

Ordering information

For more information

The minimum version supported for Catalyst C8200-1N-4T is Cisco Unified IOS XE Release 17.4.1 whereas for C8200L-1N-4T it is Cisco Unified IOS XE Release 17.5.1. The software image Product ID (PID) nomenclature, explained in Figure 3, can help you understand what to order based on your requirements.

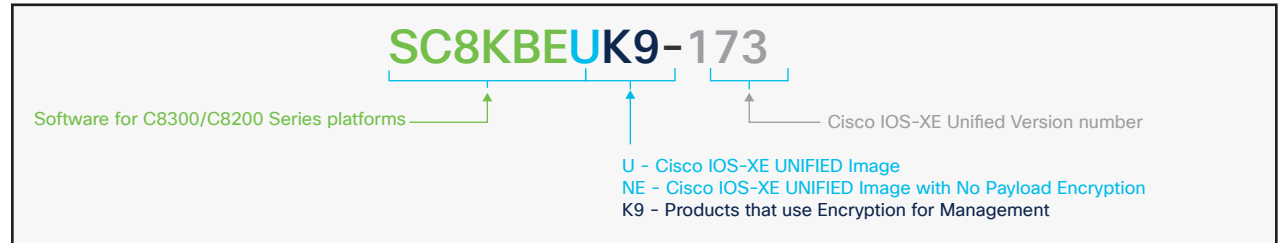

Figure 3. Catalyst 8300 and 8200 PID nomenclature

Figure 4 shows a screen capture of what it looks like to select the software operating system in Cisco Commerce Workspace (CCW).

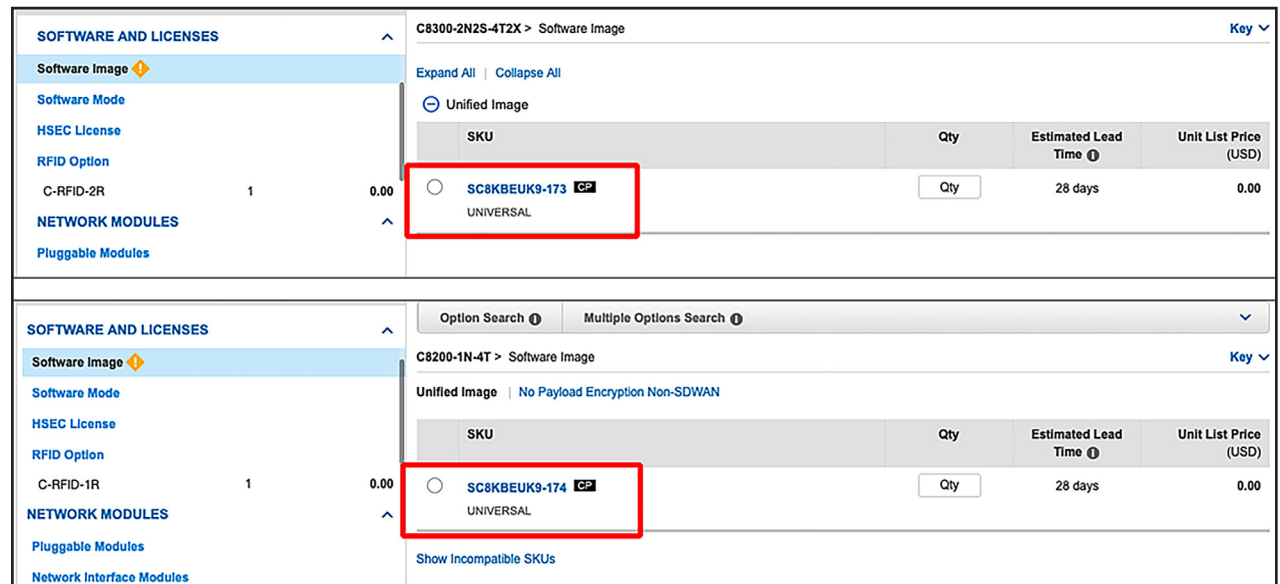

Figure 4. Software image ordering in CCW

Contents

The gateway to your intent-based WAN network is here

Ordering Cisco Catalyst 8300 and 8200 Series Edge Platforms with Cisco DNA subscriptions

Cisco DNA subscription applicability matrix for Catalyst 8300 and 8200 edge platforms

Catalyst Routing Essentials for Cisco Catalyst 8300 and 8200 Series Edge Platforms

Ordering C8200 Catalyst Routing Essentials

Ordering C8300 Catalyst Routing Essentials

Catalyst Routing Essential Sample BoM explained

Services

Cisco Smart Licensing

Warranty

Cisco Capital

Ordering information

For more information

B. Choose the software mode

The Cisco IOS XE Unified image supports two modes in a single binary image:

- **Autonomous mode** – This mode is for traditional routing (Cisco IOS XE) deployments managed via the Command-Line Interface (CLI) or a Cisco DNA Center appliance.
- **Controller mode** – This mode is for Cisco Catalyst SD-WAN (IOS XE SD-WAN) deployments managed by a Cisco Catalyst SD-WAN Manager controller.

You can choose to switch between the two modes at any point in the network based on your deployment needs and preferences. However, at the time of ordering, the default mode is autonomous mode, unless you select controller mode.

Table 2 outlines the part numbers and their descriptions when selecting a software mode.

Table 2. Part numbers for selecting the Cisco IOS-XE unified software mode.

Part number	Description
IOSXE-AUTO-MODE	Cisco IOS XE autonomous mode (default mode)
IOSXE-CTRL-MODE	Cisco IOS XE controller mode

Note: For more information on the Cisco unified image and the boot modes, refer [here](#).

Contents

The gateway to your intent-based WAN network is here

Ordering Cisco Catalyst 8300 and 8200 Series Edge Platforms with Cisco DNA subscriptions

Cisco DNA subscription applicability matrix for Catalyst 8300 and 8200 edge platforms

Catalyst Routing Essentials for Cisco Catalyst 8300 and 8200 Series Edge Platforms

Ordering C8200 Catalyst Routing Essentials

Ordering C8300 Catalyst Routing Essentials

Catalyst Routing Essential Sample BoM explained

Services

Cisco Smart Licensing

Warranty

Cisco Capital

Ordering information

For more information

C. Choose the system memory and storage

DRAM and Flash – All Catalyst 8300 and 8200 edge platforms ship with a default 8 GB DRAM, with an option to upgrade to 16 GB or 32 GB on a single DIMM slot except for the 8200L which ships with default 4GB DRAM. Likewise, all the Catalyst 8300 and 8200 platforms ship with a default of 8 GB Flash soldered onto the motherboard and it is not upgradeable.

M.2 Storage – All Catalyst 8300 and 8200 platforms (except C8200L) ship with a default of 16 GB M.2 USB storage, with an option to upgrade to 32 GB. Optionally, you can choose a 600 GB M.2 Non-Volatile Memory Express (NVMe) SSD for storage. Storage options can be either M.2 USB or M.2 NVMe SSD.

Table 3 outlines the various DRAM and M.2 options available at the time of ordering as well as the spare part numbers.

Table 3. Part numbers for selecting DRAM and M.2 USB/SSD storage options

DRAM part numbers	SPARE DRAM part numbers	M.2 storage part numbers	SPARE M.2 storage part numbers
MEM-C8300-8GB	MEM-C8300-8GB=	M2USB-16G (default)	M2USB-16G=
MEM-C8200-8GB (default)	MEM-C8200-8GB=		
MEM-C8200-4GB (default for C8200L)	MEM-C8200-4GB=		
MEM-C8300-16GB	MEM-C8300-16GB=	M2USB-32G	M2USB-32G=
MEM-C8200-16GB	MEM-C8200-16GB=		
MEM-C8300-32GB	MEM-C8300-32GB=	SSD-M2NVME-600G	SSD-M2NVME-600G=
MEM-C8200-32GB	MEM-C8200-32GB=		

Contents

The gateway to your intent-based WAN network is here

Ordering Cisco Catalyst 8300 and 8200 Series Edge Platforms with Cisco DNA subscriptions

Cisco DNA subscription applicability matrix for Catalyst 8300 and 8200 edge platforms

Catalyst Routing Essentials for Cisco Catalyst 8300 and 8200 Series Edge Platforms

Ordering C8200 Catalyst Routing Essentials

Ordering C8300 Catalyst Routing Essentials

Catalyst Routing Essential Sample BoM explained

Services

Cisco Smart Licensing

Warranty

Cisco Capital

Ordering information

For more information

D. Choose the network modules

All Catalyst 8300 edge platforms maintain backward compatibility for most of the widely deployed data and voice Network Interface Modules (NIMs) and Service Modules (SM) of the Cisco 4000 Series Integrated Services Routers (ISR).

Cisco Catalyst 8200 edge platforms maintain backward compatibility for most of the widely deployed data and voice NIMs, and doesn't support Service Modules. Catalyst 8200 edge platform only support 1 NIM and 1 PIM.

Additionally, architectural improvements have been done to increase the network module densities on Catalyst 8300 edge platforms. The introduction of C-SM-NIM-ADPTR allows two NIMs to be housed together in one single-wide SM slot. The default and maximum NIM, SM, and Pluggable Interface Module (PIM) slots are outlined in the Table 4.

Table 4. SM, NIM and PIM slots for Catalyst 8300 and 8200 edge platforms

Product ID	Default SM slots	Default NIM slots	Default PIM slots	Maximum NIMs with C-SM-NIM-ADPTR
C8300-2N2S-4T2X	2	2	1	6
C8300-2N2S-6T	2	2	1	6
C8300-1N1S-4T2X	1	1	1	3
C8300-1N1S-6T	1	1	1	3
C8200-1N-4T	0	1	1	Not applicable
C8200L-1N-4T	0	1	1	Not applicable

Contents

The gateway to your intent-based WAN network is here

Ordering Cisco Catalyst 8300 and 8200 Series Edge Platforms with Cisco DNA subscriptions

Cisco DNA subscription applicability matrix for Catalyst 8300 and 8200 edge platforms

Catalyst Routing Essentials for Cisco Catalyst 8300 and 8200 Series Edge Platforms

Ordering C8200 Catalyst Routing Essentials

Ordering C8300 Catalyst Routing Essentials

Catalyst Routing Essential Sample BoM explained

Services

Cisco Smart Licensing

Warranty

Cisco Capital

Ordering information

For more information

Table 5 provides a summary of all NIMs, SMs, and PIMs supported on the Catalyst 8300 and 8200 edge platforms and highlights the modules that work only on these platforms.

Table 5. NIM, PIM, and SM modules supported on all Catalyst 8300 and 8200 edge platforms

LTE modules (PIM and NIM)	NIM data and LAN switching	NIM voice	SM-X ²
P-LTEA-LA	C-NIM-1X*	NIM-2FXO, NIM-4FXO	C-SM-NIM-ADPTR*
P-LTEA-EA	NIM-ES2-4	NIM-2FXSP, NIM-4FXSP	C-SM-16P4M2X*
P-LTEAP18-GL	NIM-ES2-8	NIM-4E/M	C-SM-40P8M2X ^{*1}
NIM-LTEA-LA	NIM-ES2-8-P	NIM-2BRI-NT/TE	SM-X-1T3/E3
NIM-LTEA-EA	NIM-1T	NIM-4BRI-NT/TE	SM-X-64A
	NIM-2T	NIM-2FXS/4FXOP	SM-X-8FXS/12FXO
	NIM-4T	NIM-1MFT-T1/E1	SM-X-16FXS/2FXO
	NIM-16A	NIM-2MFT-T1/E1	SM-X-24FXS/4FXO
	NIM-24A	NIM-4MFT-T1/E1	SM-X-72FXS ¹
	NIM-VA-B	NIM-8MFT-T1/E1	SM-X-PVDM-500
	NIM-VAB-A	NIM-1CE1T1-PRI	SM-X-PVDM-1000
	NIM-VAB-M	NIM-2CE1T1-PRI	SM-X-PVDM-2000
	NIM-4SHDSL-EA	NIM-8CE1T1-PRI	SM-X-PVDM-3000
	NIM-1MFT-T1/E1	NIM-PVDM-32	UCS-E160S-M3/K9
	NIM-2MFT-T1/E1	NIM-PVDM-64	UCS-E180D-M3/K9
			UCS-E1120D-M3/K9

Contents

The gateway to your intent-based WAN network is here

Ordering Cisco Catalyst 8300 and 8200 Series Edge Platforms with Cisco DNA subscriptions

Cisco DNA subscription applicability matrix for Catalyst 8300 and 8200 edge platforms

Catalyst Routing Essentials for Cisco Catalyst 8300 and 8200 Series Edge Platforms

Ordering C8200 Catalyst Routing Essentials

Ordering C8300 Catalyst Routing Essentials

Catalyst Routing Essential Sample BoM explained

Services

Cisco Smart Licensing

Warranty

Cisco Capital

Ordering information

For more information

LTE modules (PIM and NIM)	NIM data and LAN switching	NIM voice	SM-X ²
	NIM-4MFT-T1/E1	NIM-PVDM-128	
	NIM-8MFT-T1/E1	NIM-PVDM-256	
	NIM-1CE1T1-PRI		
	NIM-2CE1T1-PRI		
	NIM-8CE1T1-PRI		
	NIM-2BRI-S/T		
	NIM-4BRI-S/T		
	C-NIM-4X		
	C-NIM-8T		
	C-NIM-8M		
	C-NIM-2T		
	C-NIM-1M		

* These modules are specific to Catalyst 8300 edge platforms and are not compatible with Cisco 4000 Series ISRs.

¹ These are double-wide service modules, which are only supported on C8300-2N2S (2RU) edge platforms.

² Catalyst 8200 edge platforms doesn't support any of the SM modules.

Note: To review a detailed compatibility matrix on each of the NIM, PIM, and SMs, refer [here](#).

Note: For supported optics and transceivers, refer [here](#).

E. Choose the power supplies and cables

All Catalyst 8300 edge platforms, by default, ship with dual redundant AC power supplies and fan trays. You can choose from AC, DC, and Power over Ethernet (PoE) power supply options available with respective power wattage for the corresponding platforms. All the power supplies are field-replaceable. Power cables have to be mandatorily chosen as per individual country

requirements. Table 6 outlines various AC, DC, and PoE power supply options for all Catalyst 8300 edge platforms.

All Catalyst 8200 edge platforms, by default, ship with a chassis integrated, single 100 watts AC power supply and fan trays and is not field replaceable. There is an optional

external 150 watts AC power supply that is required to support Power over Ethernet (PoE) modules, that needs to be ordered separately. When the optional external PoE power supply is connected, the chassis can only draw the power from the PoE power supply. Power cables have to be mandatorily chosen as per individual country requirements.

Table 6. AC, DC, and PoE power supply options for Catalyst 8300 and 8200 edge platforms

Product ID	Power supply part numbers	Description	SPARE PS part numbers
C8300-2N2S-4T2X	PWR-CC1-650WAC	650 watts AC power supply (default)	PWR-CC1-650WAC=
C8300-2N2S-6T	PWR-CC1-1000WAC-P	1000 watts AC PoE power supply	PWR-CC1-1000WAC=
	PWR-CC1-650WDC	650 watts DC power supply	PWR-CC1-650WDC=
C8300-1N1S-4T2X	PWR-CC1-250WAC	250 watts AC power supply (default)	PWR-CC1-250WAC=
C8300-1N1S-6T	PWR-CC1-500WAC	500 watts AC PoE power supply	PWR-CC1-500WAC=
	PWR-CC1-400WDC	400 watts DC power supply	PWR-CC1-400WDC=
C8200-1N-4T	PWR-CC1-100WAC	100 watts AC power supply (default, integrated)	N/A
C8200L-1N-4T	PWR-CC1-150WAC	150 watts AC PoE power supply (external)	PWR-CC1-150WAC=

F. Included in the purchase

Table 7 includes the default system accessories that ship with all Catalyst 8300 and 8200 edge platforms, as well as optional accessories customers can choose.

Table 7. Default system accessories, optional accessories and spares for Catalyst 8300 and 8200 edge platforms

Product ID	Default accessory part numbers	Description	Optional accessory part numbers	Spare accessory part numbers
C8300-2N2S-4T2X C8300-2N2S-6T	C8300-RM-19-2R	Cisco Catalyst 8300 rack-mount kit – 19 inches for 2RU	C8300-RM-23-2R	C8300-RM-19-2R= C8300-RM-23-2R=
	C-RFID-2R	Cisco Catalyst 8000 Edge platforms RFID – 2RU	C-RFID-NONE	N/A
	C8300-FAN-2R	Cisco Catalyst 8300 edge fan tray – 2RU	N/A	C8300-FAN-2R=
C8300-1N1S-4T2X C8300-1N1S-6T C8200- 1N-4T C8200L-1N-4T	C8300-RM-19-1R	Cisco Catalyst 8300 rack-mount kit – 19 inches for 1RU	C8300-RM-23-1R	C8300-RM-19-1R=
	C8200-RM-19-1R	Cisco Catalyst 8200 rack-mount kit – 19 inches for 1RU		C8300-RM-23-1R= C8200-RM-19-1R=
	C-RFID-1R	Cisco Catalyst 8000 Edge platforms RFID – 1RU	C-RFID-NONE	N/A



Product ID	Default accessory part numbers	Description	Optional accessory part numbers	Spare accessory part numbers
All C8300 platforms	C8300-PIM-BLANK*	Cisco Catalyst 8300 PIM blank	N/A	C8300-PIM-BLANK=
	C8300-NIM-BLANK*	Cisco Catalyst 8300 NIM blank	N/A	C8300-NIM-BLANK=
	C8300-SM-BLANK*	Cisco Catalyst 8300 SM blank	N/A	C8300-SM-BLANK=
All C8200 platforms	C8200-PIM-BLANK	Cisco Catalyst 8200 PIM blank	N/A	C8200-PIM-BLANK=
	C8200-NIM-BLANK	Cisco Catalyst 8200 NIM blank	N/A	C8200-NIM-BLANK=

* The SM, NIM and PIM blanks are automatically included only when there are no NIMs, PIMs, and SMs ordered, respectively.

Contents

The gateway to your intent-based WAN network is here

Ordering Cisco Catalyst 8300 and 8200 Series Edge Platforms with Cisco DNA subscriptions

Cisco DNA subscription applicability matrix for Catalyst 8300 and 8200 edge platforms

Catalyst Routing Essentials for Cisco Catalyst 8300 and 8200 Series Edge Platforms

Ordering C8200 Catalyst Routing Essentials

Ordering C8300 Catalyst Routing Essentials

Catalyst Routing Essential Sample BoM explained

Services

Cisco Smart Licensing

Warranty

Cisco Capital

Ordering information

For more information

G. Ordering a crypto export control license (HSEC license)

As per U.S government regulations and export restrictions, for a product to have full crypto functionality (regardless of SD-WAN or traditional routing use cases), a mandatory High Security (HSEC) license needs to be present. HSEC licenses are tied to the chassis serial number. Without an HSEC license, only 1000 secure tunnels and an aggregate crypto throughput of up to 250 Mbps is available.

An HSEC license will always be included along with Cisco DNA subscription licenses:

Option 1: Order Catalyst 8300 and 8200 edge platforms with built-in Cisco DNA subscription: An HSEC license [C8000-HSEC] will be automatically included.

Option 2: Order Hardware and Cisco DNA Subscription separately: When Cisco DNA subscription is ordered through L-DNA-C8200 or L-DNA-C8300, an HSEC license [C8000-HSEC-DNA] will be automatically included.

Table 8 outlines the HSEC licenses for all Catalyst 8300 edge platforms.

Table 8. HSEC licenses for Catalyst 8300 and 8200 edge platforms

Product ID	HSEC part number	Description	Spare HSEC part number
C8300-2N2S-4T2X	C8000-HSEC	U.S. Export Restriction Compliance license for Catalyst 8000 series	C8000-HSEC=
C8300-2N2S-6T			
C8300-1N1S-4T2X			
C8300-1N1S-6T			
C8200-1N-4T			
C8200L-1N-4T			
L-DNA-C8200	C8000-HSEC-DNA	U.S. Export Restriction Compliance license for Catalyst 8000 series	C8000-HSEC=
L-DNA-C8300			



Contents

The gateway to your intent-based WAN network is here

Ordering Cisco Catalyst 8300 and 8200 Series Edge Platforms with Cisco DNA subscriptions

Cisco DNA subscription applicability matrix for Catalyst 8300 and 8200 edge platforms

Catalyst Routing Essentials for Cisco Catalyst 8300 and 8200 Series Edge Platforms

Ordering C8200 Catalyst Routing Essentials

Ordering C8300 Catalyst Routing Essentials

Catalyst Routing Essential Sample BoM explained

Services

Cisco Smart Licensing

Warranty

Cisco Capital

Ordering information

For more information

H. Ordering Unified Communications (UC) licenses

All Catalyst 8300 and 8200 edge platforms require mandatory Cisco DNA subscription licenses. Cisco DNA subscription tiers package all the required license entitlements for running traditional features and the latest innovations of Cisco IOS-XE (refer to step 2).

Unlike the Cisco 4000 Series ISRs, Catalyst 8300 and 8200 edge platforms do not require specific UCK9, SECK9, or APPK9 licenses as these are bundled as a part of the Perpetual (Network Stack) entitlements along with respective Cisco DNA subscription tiers. **Note:** Catalyst Routing Essentials license doesn't come with any UC/Voice feature entitlements.

However, for specific Cisco Unified Border Element (CUBE) and Survivable Remote Site Telephony (SRST) licenses, you need to use a major-line license part number to order.

Table 9 shows the packaging of Network Stack entitlements and the Unified Communications (UC) licenses.

Table 9. Unified Communications support and licenses for Catalyst 8300 and 8200 platforms

UC features	Part number	Minimum Cisco DNA tier required	Network Stack included
CUBE	A-FLEX-3	Cisco DNA Essentials	Network Essentials
SRST	A-FLEX-3	Cisco DNA Advantage	Network Advantage
All voice modules (FXS/ FXO, BRI, E/M, T1-E1 MFT, SM-X-PVDM, NIM-DSP)	N/A	Cisco DNA Advantage	Network Advantage

Contents

The gateway to your intent-based WAN network is here

Ordering Cisco Catalyst 8300 and 8200 Series Edge Platforms with Cisco DNA subscriptions

Cisco DNA subscription applicability matrix for Catalyst 8300 and 8200 edge platforms

Catalyst Routing Essentials for Cisco Catalyst 8300 and 8200 Series Edge Platforms

Ordering C8200 Catalyst Routing Essentials

Ordering C8300 Catalyst Routing Essentials

Catalyst Routing Essential Sample BoM explained

Services

Cisco Smart Licensing

Warranty

Cisco Capital

Ordering information

For more information

I. Ordering Cisco DNA Subscriptions (Optional)

Under the Subscriptions section of the Hardware Platform SKU, select the required Cisco DNA subscription part number (e.g., DNA-C-T3-A-3Y).

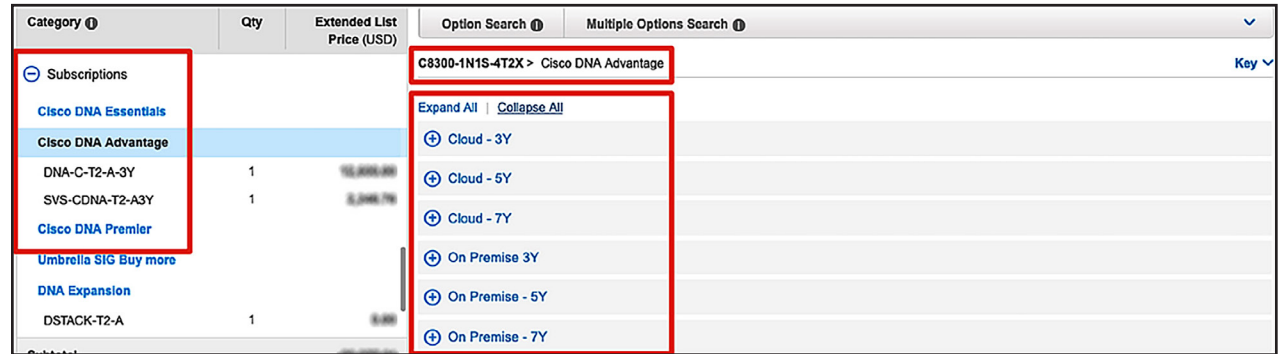

Figure 5. Cisco DNA subscription selection under hardware platform in CCW

Option 2: Order hardware and Cisco DNA subscriptions separately

Step 1. Order the hardware system

To order hardware platform, follow all the steps mentioned in Option 1, except selection of the Cisco DNA subscription (step 1).

Step 2. Order Cisco DNA subscriptions

All Catalyst 8300 and 8200 edge platforms require a mandatory Cisco DNA subscription license. Cisco DNA subscription licenses are common across SD-WAN and traditional routing deployments, giving customers flexibility to consume the latest technology, either in the cloud or on-premises. All Cisco DNA subscription tiers and/or Catalyst Routing Essentials require a Smart Account/Virtual Account (SA/VA).

Contents

The gateway to your intent-based WAN network is here

Ordering Cisco Catalyst 8300 and 8200 Series Edge Platforms with Cisco DNA subscriptions

Cisco DNA subscription applicability matrix for Catalyst 8300 and 8200 edge platforms

Catalyst Routing Essentials for Cisco Catalyst 8300 and 8200 Series Edge Platforms

Ordering C8200 Catalyst Routing Essentials

Ordering C8300 Catalyst Routing Essentials

Catalyst Routing Essential Sample BoM explained

Services

Cisco Smart Licensing

Warranty

Cisco Capital

Ordering information

For more information

Cisco DNA for SD-WAN and Routing, and Catalyst Routing Essentials, subscription licenses include embedded SWSS support, as well as Success Tracks and Solution Support. These services provide coverage ONLY for the subscription functionality (Cisco Catalyst SD-WAN Manager, Cisco Catalyst SD-WAN Analytics, Cisco Catalyst SD-WAN Validator, Cisco Catalyst SD-WAN Controller, etc.) enabled by the Cisco DNA Subscription (Cisco DNA Essentials, Cisco DNA Advantage) and Catalyst Routing Essentials. These services DO NOT include support for the Network Stack.

Use the part number mentioned in Table 10 to order subscription licenses for all Catalyst 8300 and 8200 platforms.

Table 10. Cisco DNA Subscription license part number for all Catalyst 8300 and 8200 edge platforms

Part number	Description
L-DNA-C8300	Cisco DNA Subscriptions for Catalyst 8300 Series Edge Platforms
L-DNA-C8200	Cisco DNA Subscriptions for Catalyst 8200 Series Edge Platforms

Note: For a general overview of Cisco DNA Subscriptions, refer to the “[Cisco DNA Software for SD-WAN and Routing](#)” guide.

Working with L-DNA-C8300 or L-DNA-C8200

Ordering the Cisco DNA subscription license using L-DNA-C8300 or L-DNA-C8200 can be completed in four simple steps:

- Platform Selection
- Select the software mode (the management type; refer to Table 2)
- Choose the Cisco DNA subscription part number (i.e., DNA-C-T1-A-3Y)

A. Platform selection

Select your preferred platform. Also order the required Cisco DNA subscription license that meets your needs, as shown in the following screenshot.

Contents

The gateway to your intent-based WAN network is here

Ordering Cisco Catalyst 8300 and 8200 Series Edge Platforms with Cisco DNA subscriptions

Cisco DNA subscription applicability matrix for Catalyst 8300 and 8200 edge platforms

Catalyst Routing Essentials for Cisco Catalyst 8300 and 8200 Series Edge Platforms

Ordering C8200 Catalyst Routing Essentials

Ordering C8300 Catalyst Routing Essentials

Catalyst Routing Essential Sample BoM explained

Services

Cisco Smart Licensing

Warranty

Cisco Capital

Ordering information

For more information

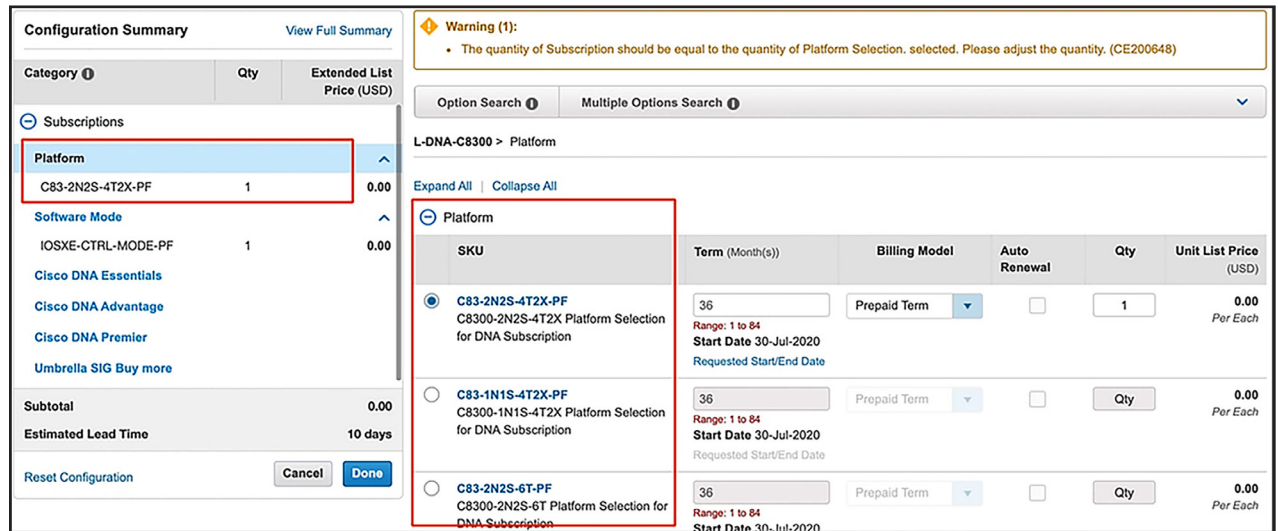

Figure 6. Platform selection

B. Select the software mode (management mode)

Select your preferred software mode (refer to Table 2), which indicates the management type used for the Catalyst 8300 and 8200 edge platforms (as shown in the following screenshot).

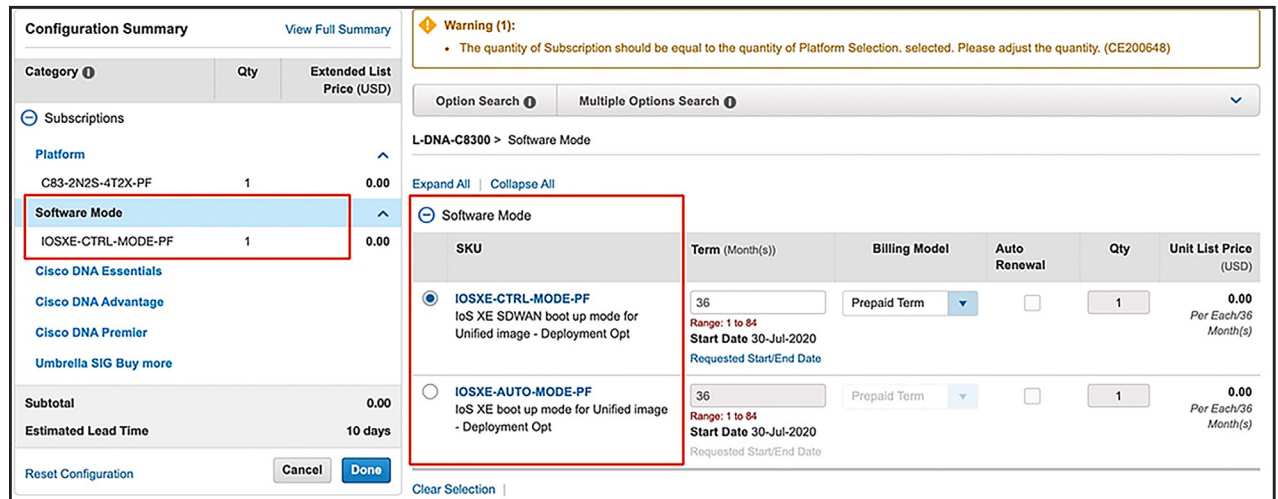

Figure 7. Software mode selection

Contents

The gateway to your intent-based WAN network is here

Ordering Cisco Catalyst 8300 and 8200 Series Edge Platforms with Cisco DNA subscriptions

Cisco DNA subscription applicability matrix for Catalyst 8300 and 8200 edge platforms

Catalyst Routing Essentials for Cisco Catalyst 8300 and 8200 Series Edge Platforms

Ordering C8200 Catalyst Routing Essentials

Ordering C8300 Catalyst Routing Essentials

Catalyst Routing Essential Sample BoM explained

Services

Cisco Smart Licensing

Warranty

Cisco Capital

Ordering information

For more information

C. Choose the Cisco DNA subscription SKU

Next, choose the Cisco DNA subscription SKU based on your management type, your preferred bandwidth, tier, and term requirements (as shown in the following screenshot).

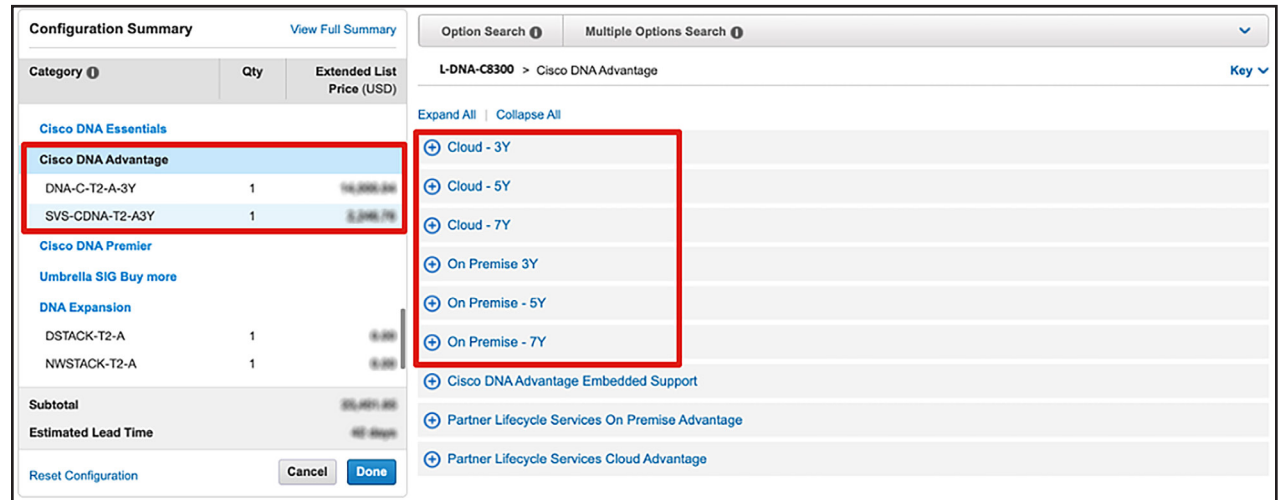

Figure 8. Cisco DNA subscription SKU selection

Please note that an HSEC license [C8000-HSEC-DNA] will be automatically included upon selection of a Cisco DNA subscription tier as highlighted above.

Contents

The gateway to your intent-based WAN network is here

Ordering Cisco Catalyst 8300 and 8200 Series Edge Platforms with Cisco DNA subscriptions

Cisco DNA subscription applicability matrix for Catalyst 8300 and 8200 edge platforms

Catalyst Routing Essentials for Cisco Catalyst 8300 and 8200 Series Edge Platforms

Ordering C8200 Catalyst Routing Essentials

Ordering C8300 Catalyst Routing Essentials

Catalyst Routing Essential Sample BoM explained

Services

Cisco Smart Licensing

Warranty

Cisco Capital

Ordering information

For more information

Cisco DNA subscription applicability matrix for Catalyst 8300 and 8200 edge platforms

Table 11 details subscription bandwidth tiers applicable for respective Platforms.

Table 11. Cisco DNA subscription applicability matrix for all Catalyst 8300 and 8200 edge platforms

Catalyst Edge 8300 and 8200 Platforms	✓ Essentials		✓ Advantage	
	Tier 0 Up to 25M BW (50M Aggr)	Tier 1 Up to 250M BW (500M Aggr)	Tier 2 Up to 1G BW (2G Aggr)	Tier 3 Up to 10G BW (20G Aggr)
C8200-1N-4T	✓✓	✓✓	✓✓	
C8200L-1N-4T	✓✓	✓✓	✓✓	
C8300-1N1S-6T	✓✓	✓✓	✓✓	
C8300-2N2S-6T	✓✓	✓✓	✓✓	
C8300-1N1S-4T2X	✓✓	✓✓	✓✓	✓
C8300-2N2S04T2X	✓✓	✓✓	✓✓	✓

Note: A Tier 3 bandwidth license provides the max platform throughput for C8300-1N1S-4T2X, C8300-2N2S-4T2X, C8500L-8S4X, C8500-12X, and C8500-12X4QC.

Note: A Tier 2 bandwidth license provides the max platform throughput for C8200-uCPE-1NB, C8200-1N-4T, C8200L-1N-4T, C8300-1N1S-6T, C8300-2N2S-6T.

Note: For more information on feature packages and the type of traffic that is counted towards the bandwidth tiers, please refer to the Cisco DNA subscription FAQ: <https://www.cisco.com/c/en/us/products/collateral/software/one-wan-subscription/nb-06-dna-sw-rout-sub-faq-ctp-en.html>.

Note: How to read the Cisco DNA subscription tier SKU in Table 11.

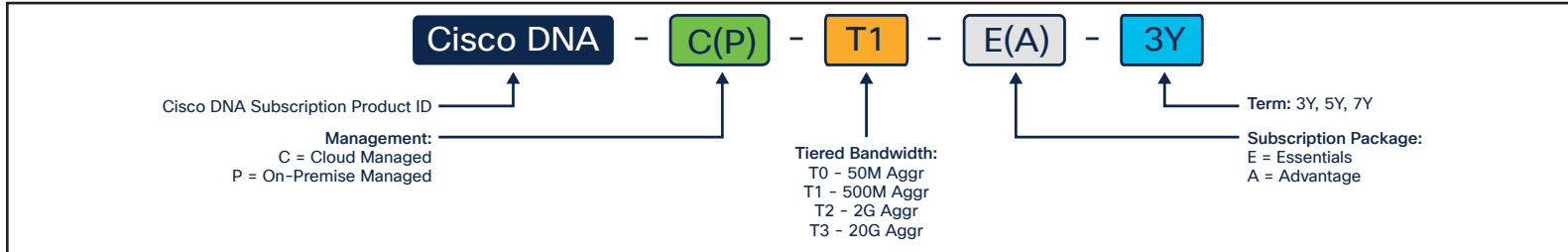

See Table 12 for the applicable subscription SKUs for these tiers.

Table 12. Cisco DNA E/A subscription tiers applicable for all Catalyst 8000 Edge platforms

Platform	Subscription Package Tier	Tier 0 Up to 50M Agg.	Tier 1 Up to 500M Agg.	Tier 2 Up to 2G Agg.	Tier 3 Up to 20G Agg.	Term
C8300-2N2S-4T2X and C8300-1N1S-4T2X	Cisco DNA Advantage	DNA-C-T0-A-3Y	DNA-C-T1-A-3Y	DNA-C-T2-A-3Y	DNA-C-T3-A-3Y*	3Y, 5Y, 7Y
		DNA-C-T0-A-5Y	DNA-C-T1-A-5Y	DNA-C-T2-A-5Y	DNA-C-T3-A-5Y*	
		DNA-C-T0-A-7Y	DNA-C-T1-A-7Y	DNA-C-T2-A-7Y	DNA-C-T3-A-7Y*	
		DNA-P-T0-A-3Y	DNA-P-T1-A-3Y	DNA-P-T2-A-3Y	DNA-P-T3-A-3Y*	
		DNA-P-T0-A-5Y	DNA-P-T1-A-5Y	DNA-P-T2-A-5Y	DNA-P-T3-A-5Y*	
	Cisco DNA Essentials	DNA-P-T0-A-7Y	DNA-P-T1-A-7Y	DNA-P-T2-A-7Y	DNA-P-T3-A-7Y*	3Y, 5Y, 7Y
		DNA-C-T0-E-3Y	DNA-C-T1-E-3Y	DNA-C-T2-E-3Y		
		DNA-C-T0-E-5Y	DNA-C-T1-E-5Y	DNA-C-T2-E-5Y		
		DNA-C-T0-E-7Y	DNA-C-T1-E-7Y	DNA-C-T2-E-7Y		
		DNA-P-T0-E-3Y	DNA-P-T1-E-3Y	DNA-P-T2-E-3Y		
	DNA-P-T0-E-5Y	DNA-P-T1-E-5Y	DNA-P-T2-E-5Y			
	DNA-P-T0-E-7Y	DNA-P-T1-E-7Y	DNA-P-T2-E-7Y			



Platform	Subscription Package Tier	Tier 0 Up to 50M Agg.	Tier 1 Up to 500M Agg.	Tier 2 Up to 2G Agg.	Tier 3 Up to 20G Agg.	Term
C8300-2N2S-6T, C8300-1N1S-6T, C8200-1N-4T and C8200L-1N-4T	Cisco DNA Premier	DNA-C-T0-P-3Y DNA-C-T0-P-5Y DNA-P-T0-P-3Y DNA-P-T0-P-5Y	DNA-C-T1-P-3Y DNA-C-T1-P-5Y DNA-P-T1-P-3Y DNA-P-T1-P-5Y	DNA-C-T2-P-3Y DNA-C-T2-P-5Y DNA-P-T2-P-3Y DNA-P-T2-P-5Y		3Y, 5Y
	Cisco DNA Advantage	DNA-C-T0-A-3Y DNA-C-T0-A-5Y DNA-C-T0-A-7Y DNA-P-T0-A-3Y DNA-P-T0-A-5Y DNA-P-T0-A-7Y	DNA-C-T1-A-3Y DNA-C-T1-A-5Y DNA-C-T1-A-7Y DNA-P-T1-A-3Y DNA-P-T1-A-5Y DNA-P-T1-A-7Y	DNA-C-T2-A-3Y DNA-C-T2-A-5Y DNA-C-T2-A-7Y DNA-P-T2-A-3Y DNA-P-T2-A-5Y DNA-P-T2-A-7Y		3Y, 5Y, 7Y
	Cisco DNA Essentials	DNA-C-T0-E-3Y DNA-C-T0-E-5Y DNA-C-T0-E-7Y DNA-P-T0-E-3Y DNA-P-T0-E-5Y DNA-P-T0-E-7Y	DNA-C-T1-E-3Y DNA-C-T1-E-5Y DNA-C-T1-E-7Y DNA-P-T1-E-3Y DNA-P-T1-E-5Y DNA-P-T1-E-7Y	DNA-C-T2-E-3Y DNA-C-T2-E-5Y DNA-C-T2-E-7Y DNA-P-T2-E-3Y DNA-P-T2-E-5Y DNA-P-T2-E-7Y		3Y, 5Y, 7Y

*Platform is recommended for up to 5G aggregate throughput

Contents

The gateway to your intent-based WAN network is here

Ordering Cisco Catalyst 8300 and 8200 Series Edge Platforms with Cisco DNA subscriptions

Cisco DNA subscription applicability matrix for Catalyst 8300 and 8200 edge platforms

Catalyst Routing Essentials for Cisco Catalyst 8300 and 8200 Series Edge Platforms

Ordering C8200 Catalyst Routing Essentials

Ordering C8300 Catalyst Routing Essentials

Catalyst Routing Essential Sample BoM explained

Services

Cisco Smart Licensing

Warranty

Cisco Capital

Ordering information

For more information

Catalyst Routing Essentials for Cisco Catalyst 8300 and 8200 Series Edge Platforms

Catalyst Routing Essentials license is a tailor-made entry-level Base feature package intended for Traditional Routing deployments with Catalyst Edge 8300 and 8200 series routers. The Catalyst Routing Essentials subscription license includes the following features:

1. **Everything in Cisco's IP-Base license:** For base connectivity and routing features
2. **Point-2-Point IPsec with HSEC:** For branches requiring secure connection to cloud based security services and for MACSEC use cases
3. **Application-based Firewall (NGFW):** To meet today's evolving embedded branch security
4. **On-Premise SD-Routing:** Enables customers to use Catalyst SD-WAN Manager for management, configuration and troubleshooting of installed devices.
5. Additionally, it unlocks maximum platform throughput capability for IP-CEF and Crypto traffic throughput up to 2Gbps.

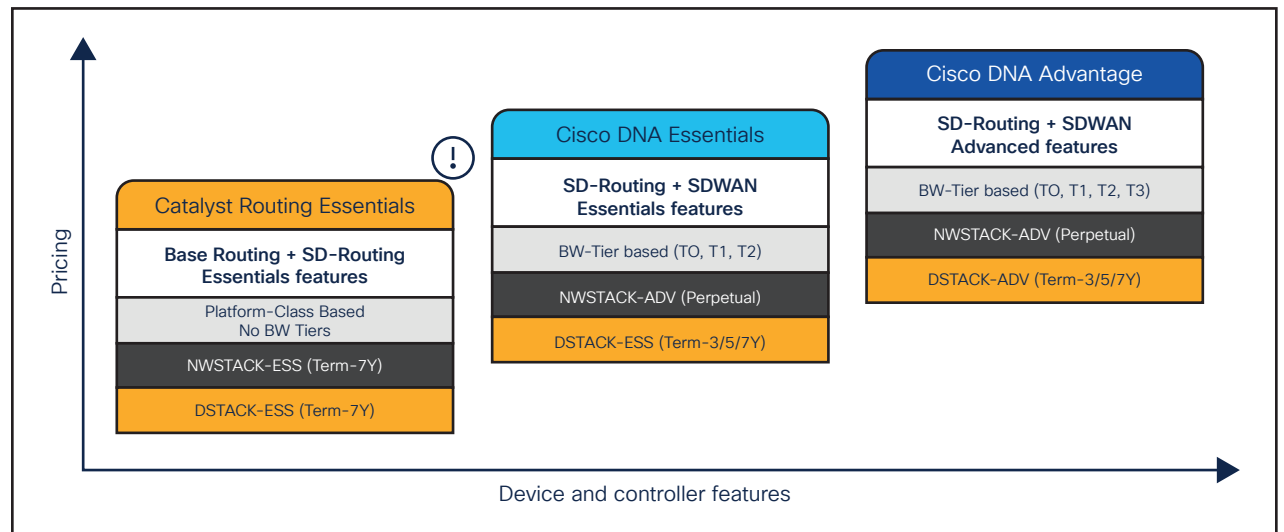

Figure 9. Value Plot of Cisco's SD-WAN and Routing Subscription Offers

Contents

The gateway to your intent-based WAN network is here

Ordering Cisco Catalyst 8300 and 8200 Series Edge Platforms with Cisco DNA subscriptions

Cisco DNA subscription applicability matrix for Catalyst 8300 and 8200 edge platforms

Catalyst Routing Essentials for Cisco Catalyst 8300 and 8200 Series Edge Platforms

Ordering C8200 Catalyst Routing Essentials

Ordering C8300 Catalyst Routing Essentials

Catalyst Routing Essential Sample BoM explained

Services

Cisco Smart Licensing

Warranty

Cisco Capital

Ordering information

For more information

Catalyst Routing Essentials subscription license can be ordered through two different options as shown in the below illustration.

1. Order Catalyst Routing Essentials within the C8200/C8300 Hardware ATOs
2. Order Catalyst Routing Essentials through standalone Subscription ATOs such as L-DNA-C8200 or L-DNA-C8300

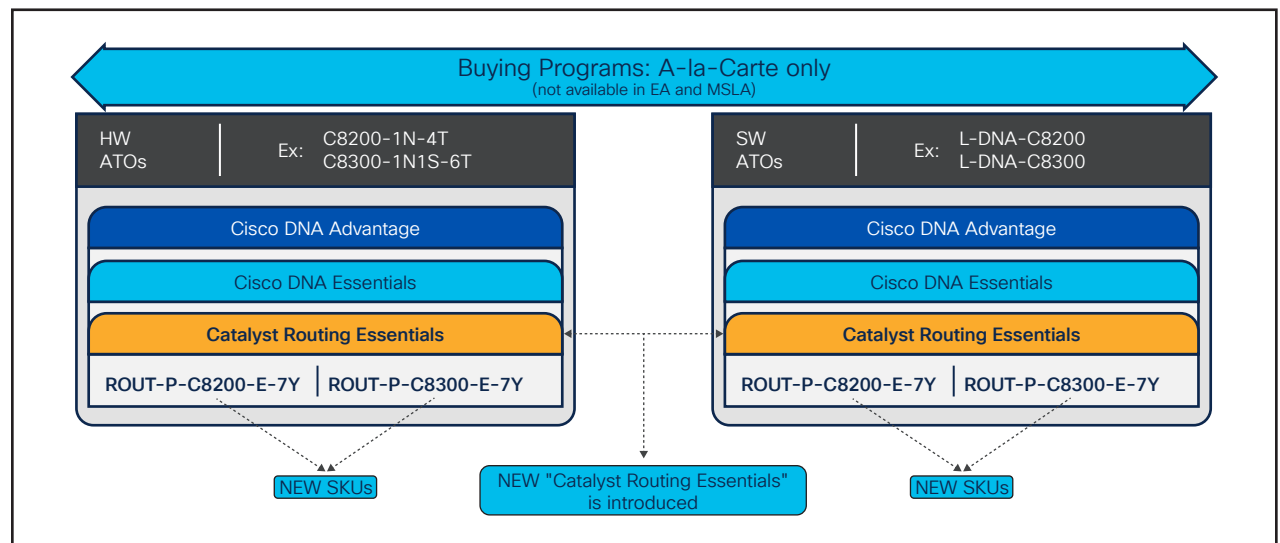

Figure 10. Catalyst Routing Essentials SKUs

The Catalyst Routing Essentials license is only offered as a 7-year term-based subscription. There is no bandwidth tiering necessary for Catalyst Routing Essentials. The platform-class is reflected in the new license SKU.

Contents

The gateway to your intent-based WAN network is here

Ordering Cisco Catalyst 8300 and 8200 Series Edge Platforms with Cisco DNA subscriptions

Cisco DNA subscription applicability matrix for Catalyst 8300 and 8200 edge platforms

Catalyst Routing Essentials for Cisco Catalyst 8300 and 8200 Series Edge Platforms

Ordering C8200 Catalyst Routing Essentials

Ordering C8300 Catalyst Routing Essentials

Catalyst Routing Essential Sample BoM explained

Services

Cisco Smart Licensing

Warranty

Cisco Capital

Ordering information

For more information

Table 13. Catalyst Routing Essentials subscription applicable for all Catalyst 8200 and 8300 Edge platforms

Platform	Subscription Package	Subscription SKU
C8300-1N1S-4T2X C8300-1N1S-6T C8300-2N2S-4T2X C8300-2N2S-6T	Catalyst Routing Essentials	ROUT-P-C8300-E-7Y
C8200L-1N-4T C8200-1N-4T	Catalyst Routing Essentials	ROUT-P-C8200-E-7Y

Ordering C8200 Catalyst Routing Essentials

Catalyst Routing Essentials license on C8200 platform class can be ordered in two ways:

Option-1: Ordering ROUT-ESS within C8200 hardware ATOs

- Add the top-line hardware ATOs (C8200-1N-4T or C8200L-1N-4T) to your order/estimate
- Configure the hardware ATO as per your software version, modules, optics, cables and power supply requirements as usual
- Select “IOSXE-AUTO-MODE” as ROUT-ESS subscription package cannot be selected with “IOSXE-CTRL-MODE”
- Navigate to “Subscriptions”→ “Catalyst Routing Essentials” section on the left panel and select the SKU “ROUT-P-C8200-E-7Y”

Contents

The gateway to your intent-based WAN network is here

Ordering Cisco Catalyst 8300 and 8200 Series Edge Platforms with Cisco DNA subscriptions

Cisco DNA subscription applicability matrix for Catalyst 8300 and 8200 edge platforms

Catalyst Routing Essentials for Cisco Catalyst 8300 and 8200 Series Edge Platforms

Ordering C8200 Catalyst Routing Essentials

Ordering C8300 Catalyst Routing Essentials

Catalyst Routing Essential Sample BoM explained

Services

Cisco Smart Licensing

Warranty

Cisco Capital

Ordering information

For more information

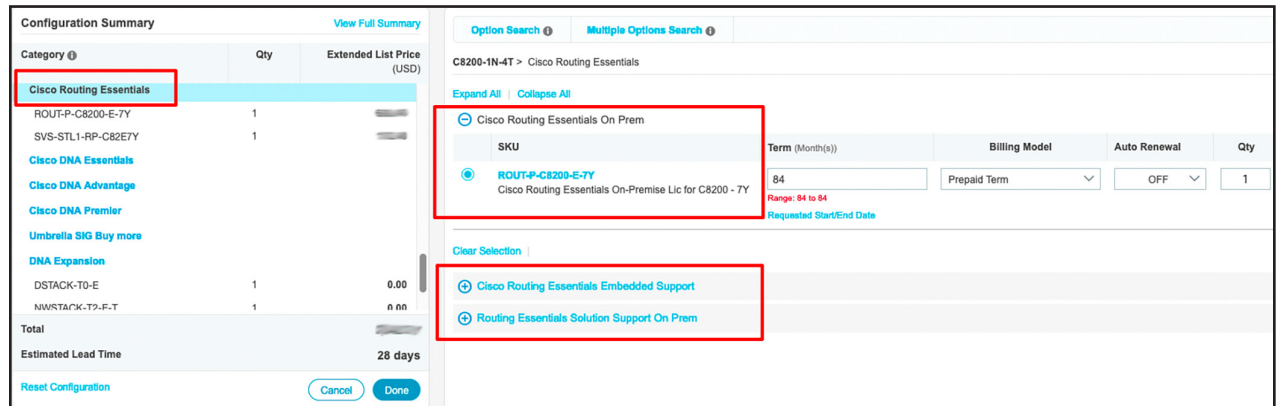

Option-2: Ordering ROUT-ESS using L-DNA-C8200 software ATO

- Add the top-line software ATO “L-DNA-C8200” to your order/estimate
- Make the appropriate platform selection
- Select “IOSXE-AUTO-MODE-PF” as ROUT-ESS subscription package cannot be selected with “IOSXE-CTRL-MODE-PF”
- Navigate to “Catalyst Routing Essentials” section on the left panel and select the SKU “ROUT-P-C8200-E-7Y”

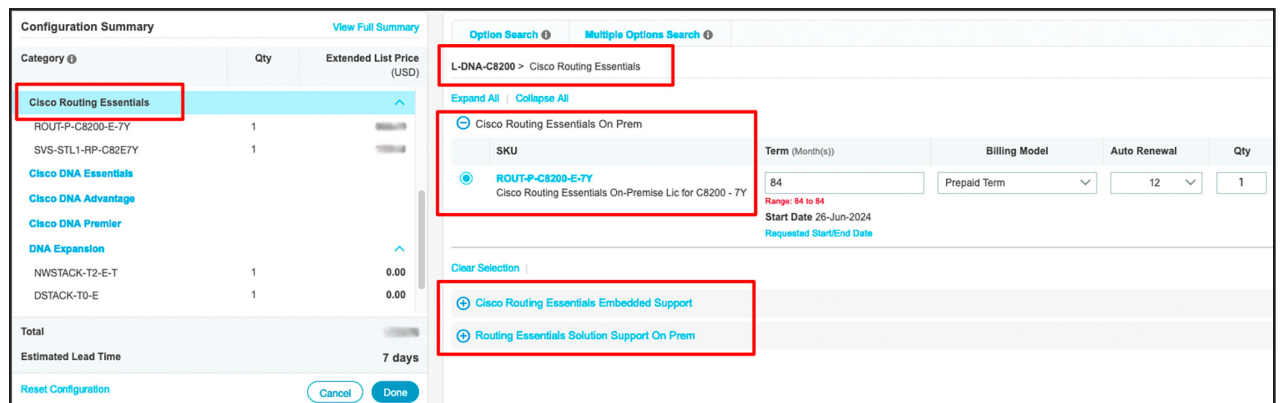

Contents

The gateway to your intent-based WAN network is here

Ordering Cisco Catalyst 8300 and 8200 Series Edge Platforms with Cisco DNA subscriptions

Cisco DNA subscription applicability matrix for Catalyst 8300 and 8200 edge platforms

Catalyst Routing Essentials for Cisco Catalyst 8300 and 8200 Series Edge Platforms

Ordering C8200 Catalyst Routing Essentials

Ordering C8300 Catalyst Routing Essentials

Catalyst Routing Essential Sample BoM explained

Services

Cisco Smart Licensing

Warranty

Cisco Capital

Ordering information

For more information

Ordering C8300 Catalyst Routing Essentials

Catalyst Routing Essentials license on C8300 platform class can be ordered in two ways:

Option-1: Ordering ROUT-ESS within C8300 hardware ATOs

- Add one of the top-line hardware ATOs (C8300-1N1S-6T, C8300-2N2S-6T, C8300-1N1S-4T2X, C8300-2N2S-4T2X) to your order/estimate
- Configure the hardware ATO as per your software version, modules, optics, cables and power supply requirements as usual
- Select “IOSXE-AUTO-MODE” as ROUT-ESS subscription package cannot be selected with “IOSXE-CTRL-MODE”
- Navigate to “Subscriptions”→ “Catalyst Routing Essentials” section on the left panel and select the SKU “ROUT-P-C8300-E-7Y”

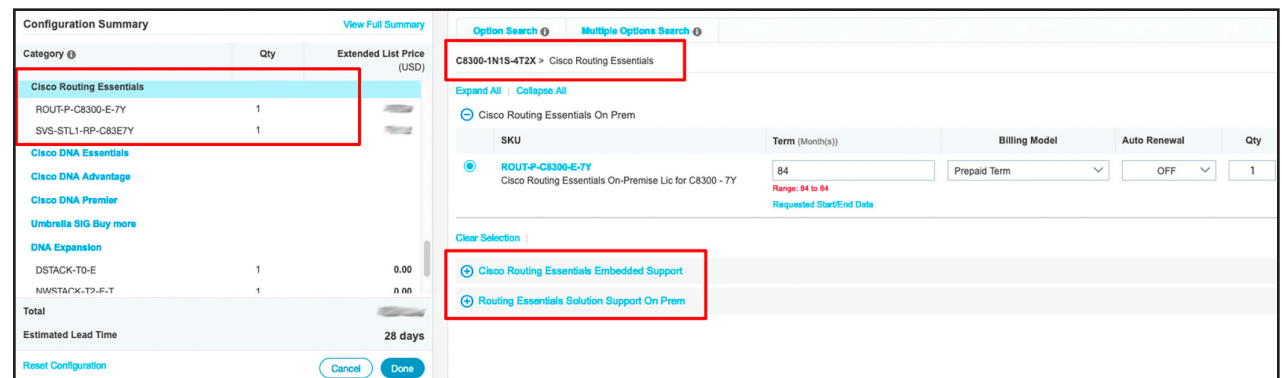

The screenshot displays the Cisco configuration summary interface. On the left, the 'Configuration Summary' table lists items with their categories, quantities, and prices. A red box highlights the 'Cisco Routing Essentials' section, which includes the items 'ROUT-P-C8300-E-7Y' and 'SVS-STL1-RP-C83E7Y'. On the right, the 'Option Search' results show 'C8300-1N1S-4T2X - Cisco Routing Essentials' selected. Below this, the 'SKU' table lists 'ROUT-P-C8300-E-7Y' with a quantity of 1, a term of 84 months, and a billing model of 'Prepaid Term'. A red box highlights the 'ROUT-P-C8300-E-7Y' SKU. At the bottom of the right panel, two additional options are listed: 'Cisco Routing Essentials Embedded Support' and 'Routing Essentials Solution Support On Prem', both highlighted with red boxes.

Category	Qty	Extended List Price (USD)
Cisco Routing Essentials		
ROUT-P-C8300-E-7Y	1	
SVS-STL1-RP-C83E7Y	1	
Cisco DNA Essentials		
Cisco DNA Advantage		
Cisco DNA Premier		
Umbrella SIG Buy more		
DNA Expansion		
DSTACK-TD-E	1	0.00
NWSTACK-TD-F-T	1	n nn
Total		
Estimated Lead Time		28 days

SKU	Term (Month(s))	Billing Model	Auto Renewal	Qty
ROUT-P-C8300-E-7Y	84	Prepaid Term	OFF	1

Contents

The gateway to your intent-based WAN network is here

Ordering Cisco Catalyst 8300 and 8200 Series Edge Platforms with Cisco DNA subscriptions

Cisco DNA subscription applicability matrix for Catalyst 8300 and 8200 edge platforms

Catalyst Routing Essentials for Cisco Catalyst 8300 and 8200 Series Edge Platforms

Ordering C8200 Catalyst Routing Essentials

Ordering C8300 Catalyst Routing Essentials

Catalyst Routing Essential Sample BoM explained

Services

Cisco Smart Licensing

Warranty

Cisco Capital

Ordering information

For more information

Option-2: Ordering ROUT-ESS using L-DNA-C8300 software ATO

- Add the top-line software ATO “L-DNA-C8300” to your order/estimate
- Make the appropriate platform selection
- Select “IOSXE-AUTO-MODE-PF” as ROUT-ESS subscription package cannot be selected with “IOSXE-CTRL-MODE-PF”
- Navigate to “Catalyst Routing Essentials” section on the left panel and select the SKU “ROUT-P-C8300-E-7Y”

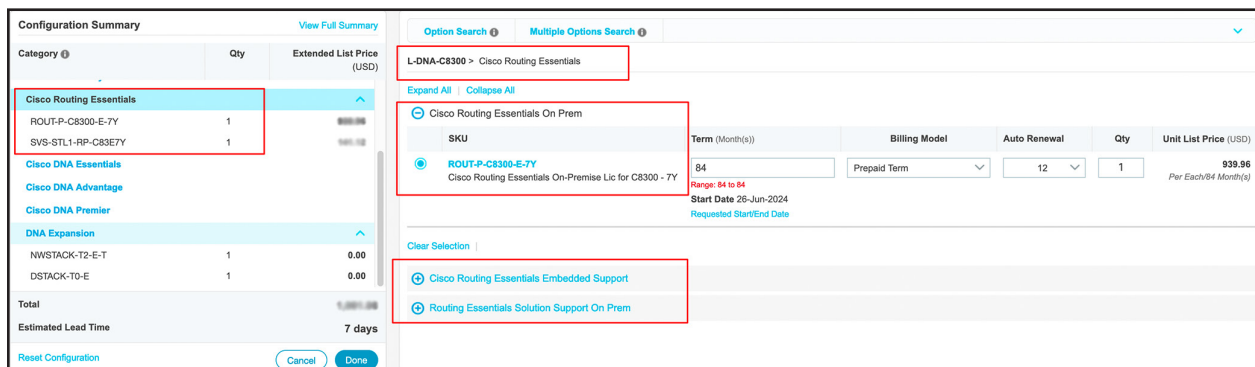

The screenshot displays the Cisco configuration summary interface. On the left, the 'Configuration Summary' table lists items with their quantities and prices. The 'Cisco Routing Essentials' section is highlighted, showing the selection of 'ROUT-P-C8300-E-7Y' (Quantity: 1, Price: \$939.96). The right panel shows the 'Option Search' results for 'L-DNA-C8300 > Cisco Routing Essentials'. The selected SKU is 'ROUT-P-C8300-E-7Y' (Cisco Routing Essentials On-Premise Lic for C8300 - 7Y) with a term of 84 months, a billing model of Prepaid Term, and an auto-renewal of 12 months. The unit list price is \$939.96 per each 84 months. The interface also shows other options like 'Cisco Routing Essentials Embedded Support' and 'Routing Essentials Solution Support On Prem'.

Category	Qty	Extended List Price (USD)
Cisco Routing Essentials		
ROUT-P-C8300-E-7Y	1	\$939.96
SVS-STL1-RP-C83E7Y	1	\$0.00
Cisco DNA Essentials		
Cisco DNA Advantage		
Cisco DNA Premier		
DNA Expansion		
NWSTACK-T2-E-T	1	0.00
DSTACK-T0-E	1	0.00
Total		\$939.96
Estimated Lead Time		7 days

Notes:

- All required entitlements such as NWSTACK-T2-E, DSTACK-T0-E, HSEC is auto-included in the BoM when ROUT-ESS is chosen
- By default, Success Track L1 service SKU gets added. You can change this to Embedded Support or Solution Support by clicking on the relevant blocks on the right panel

Contents

The gateway to your intent-based WAN network is here

Ordering Cisco Catalyst 8300 and 8200 Series Edge Platforms with Cisco DNA subscriptions

Cisco DNA subscription applicability matrix for Catalyst 8300 and 8200 edge platforms

Catalyst Routing Essentials for Cisco Catalyst 8300 and 8200 Series Edge Platforms

Ordering C8200 Catalyst Routing Essentials

Ordering C8300 Catalyst Routing Essentials

Catalyst Routing Essential Sample BoM explained

Services

Cisco Smart Licensing

Warranty

Cisco Capital

Ordering information

For more information

Catalyst Routing Essentials Sample BoM explained

Catalyst Routing Essentials subscription license automatically includes all the license entitlements that is required for enabling HSEC, SD-Routing or CLI-managed features for Traditional Routing. Below is a simple example of a ROUT-ESS bill of materials.

Sample BoM L-DNA-C8300

Item ID	Item Name	Billing Model	Requested Start Date	Term
1.1	C83-2N2S-4TZK-PF C8300-2N2S-4TZK Platform Selection for DNA Subscription More	Prepaid Term	26-Jun-2024	Term 84 Month(s)
Software Mode				
1.2	K83K-AUTO-MODE-PF K83K-AE Autonomous or SD-Routing mode for Unified image	Prepaid Term	26-Jun-2024	Term 84 Month(s)
Export Control License				
1.3	C800-HSEC-0MA U.S. Export Restriction Compliance license for C800 series	Prepaid Term	26-Jun-2024	Term 84 Month(s)
Cisco Routing Essentials				
1.4	ROUT-ESS-C8300-7Y Cisco Routing Essentials On-Premise Lic for C8300 - 7Y	Prepaid Term	26-Jun-2024	Term 84 Month(s)
1.5	SVS-STL1-OP-C83E7Y Success Track L1 - Routing Ess On-Prem Lic for C8300 - 7Y More	Prepaid Term	26-Jun-2024	Term 84 Month(s)
DNA Expansion				
1.6	NWSTACK-T2-E-T Cisco Network Term Essentials Stack - upto 1G (Aggr, 2G)	Prepaid Term	26-Jun-2024	Term 84 Month(s)
1.7	DSTACK-T2-E Cisco DNA Essentials Stack - upto 25M (Aggr, 50M)	Prepaid Term	26-Jun-2024	Term 84 Month(s)
EXPANSION				
1.8	SDWAN-ONPREM-PF Cisco SDWAN On Prem Deployment Option More	Prepaid Term	26-Jun-2024	Term 84 Month(s)

- Platform Selection indicating the intent of ROUT-ESS attach to a specific model, not an entitlement.
- SW mode indicating the intent of ROUT-ESS attach to a specific model (applicable to AUTO mode only), not an entitlement
- Auto-included **HSEC entitlement** with ROUT-ESS
- Commercial SKU** for ROUT-ESS subscription package
- Default **L1-support SKU** attached with ROUT-ESS subscription
- Auto-included term-based **Network-ESS entitlement** with ROUT-ESS
- Auto-included term-based **DSTACK entitlement** (for SD-Routing)

Contents

The gateway to your intent-based WAN network is here

Ordering Cisco Catalyst 8300 and 8200 Series Edge Platforms with Cisco DNA subscriptions

Cisco DNA subscription applicability matrix for Catalyst 8300 and 8200 edge platforms

Catalyst Routing Essentials for Cisco Catalyst 8300 and 8200 Series Edge Platforms

Ordering C8200 Catalyst Routing Essentials

Ordering C8300 Catalyst Routing Essentials

Catalyst Routing Essential Sample BoM explained

Services

Cisco Smart Licensing

Warranty

Cisco Capital

Ordering information

For more information

Services

Cisco Customer Experience Support Services for Catalyst 8000 platforms and Cisco DNA Software for SD-WAN and Routing

This section discusses the Cisco Support Services available for Catalyst 8000 platforms and associated Cisco DNA Software for SD-WAN and Routing, as well as optional Support Service offers.

- **Catalyst 8000 platforms:** Cisco Success Tracks is the default and recommended Cisco support service. However, Cisco Success Tracks is not mandatory; it can be removed or replaced with another Cisco support service or partner service per the customer's preference.
- **Cisco DNA Software for SD-WAN and Routing:** Cisco Success Tracks is the default and recommended Cisco support service. However, Cisco Success Tracks is not mandatory; the customer may choose to use the Cisco Subscription Embedded Software Support included with the purchase of this software or another available Cisco support service or partner service option.

Notes:

- When Success Tracks is selected, it must be ordered on both the Catalyst 8000 platform and Cisco DNA Software for SD-WAN and Routing for complete customer entitlement to this premium support service.
- Cisco DNA Software for SDWAN and Routing licenses: with all services tied to this software license, whether Success Tracks, Solution Support, or Cisco Subscription Embedded Software Support, customers are entitled to maintenance releases and software updates for **Cisco DNA SD-WAN software only**. The support for the Catalyst 8000 platform's OS and network stack, along with OS updates, is covered by the support contract on the Catalyst 8000 platform.

Contents

The gateway to your intent-based WAN network is here

Ordering Cisco Catalyst 8300 and 8200 Series Edge Platforms with Cisco DNA subscriptions

Cisco DNA subscription applicability matrix for Catalyst 8300 and 8200 edge platforms

Catalyst Routing Essentials for Cisco Catalyst 8300 and 8200 Series Edge Platforms

Ordering C8200 Catalyst Routing Essentials

Ordering C8300 Catalyst Routing Essentials

Catalyst Routing Essential Sample BoM explained

Services

Cisco Smart Licensing

Warranty

Cisco Capital

Ordering information

For more information

Success Tracks is a comprehensive suite of services powered by CX Cloud designed to empower customers to simplify, reduce risk and drive innovation for their Cisco IT environments. Success Tracks includes everything in Cisco Solution Support (see description below), plus the following:

- Proven product activation checklists and success tips
- Access to live and on-demand expert resources
- Direct access to engineering expertise
- AI/ML-based analytics
- Curated library of Product Alerts and Field Notices
- Centralized inventory tracking and asset management
- Configuration assessment for security and compliance
- Recommendations for software updates
- Simplified case management and rapid problem resolution
- Practice labs for pre-production testing
- Technical certification learning assistance

Cisco Solution Support is a premium support purpose-built for today's multiproduct, multivendor network environments and provides:

- A primary point of contact centralizing support across a solution deployment
- Solution, product, and interoperability expertise
- No requirement for customers to isolate their issue to a product to open a case.
- 30-minute service response objective for Severity 1 and 2 cases

Contents

The gateway to your intent-based WAN network is here

Ordering Cisco Catalyst 8300 and 8200 Series Edge Platforms with Cisco DNA subscriptions

Cisco DNA subscription applicability matrix for Catalyst 8300 and 8200 edge platforms

Catalyst Routing Essentials for Cisco Catalyst 8300 and 8200 Series Edge Platforms

Ordering C8200 Catalyst Routing Essentials

Ordering C8300 Catalyst Routing Essentials

Catalyst Routing Essential Sample BoM explained

Services

Cisco Smart Licensing

Warranty

Cisco Capital

Ordering information

For more information

- Prioritized case handling over product support cases
- Product support team coordination (Cisco and Solution Support Alliance Partners)
- Accountability for multiproduct, multivendor issue management from first call to resolution, no matter where the issue resides.

Learn more about Cisco Success Tracks [here](#).

Cisco Subscription Embedded Software Support includes:

Access to support and troubleshooting via online tools and web case submission. Case severity or escalation guidelines are not applicable.

- Cisco Technical Assistance Center (TAC) access 24 hours per day, 7 days per week to assist by telephone, or web case submission and online tools with application software use and troubleshooting issues.
- Access to <https://www.cisco.com>, providing helpful technical and general information on Cisco products, as well as access to Cisco's online Software Center library.

Note: No additional products or fees are required to receive embedded support for Cisco DNA Software for SD-WAN and Routing. However, if using embedded support for this software, hardware support for the Catalyst 8000 platforms must be purchased separately, as Cisco Subscription Embedded Software Support does not cover hardware. In this case, Cisco Smart Net Total Care Service is recommended for Catalyst 8000 platforms.

Contents

The gateway to your intent-based WAN network is here

Ordering Cisco Catalyst 8300 and 8200 Series Edge Platforms with Cisco DNA subscriptions

Cisco DNA subscription applicability matrix for Catalyst 8300 and 8200 edge platforms

Catalyst Routing Essentials for Cisco Catalyst 8300 and 8200 Series Edge Platforms

Ordering C8200 Catalyst Routing Essentials

Ordering C8300 Catalyst Routing Essentials

Catalyst Routing Essential Sample BoM explained

Services

Cisco Smart Licensing

Warranty

Cisco Capital

Ordering information

For more information

Cisco Smart Licensing

All Cisco Catalyst 8300/8200 Series Edge Platforms only supports Smart License Using Policy (SLUP). A Smart Account and Virtual Account (SA/VA) is mandatory while ordering the Catalyst 8300/8200 platform hardware and Subscriptions.

Introduction to Smart Licensing

Cisco Smart Licensing is a flexible licensing model that provides you with an easier, faster, and more consistent way to purchase and manage software across the Cisco portfolio and across your organization. And it's secure – you control what users can access. With Smart Licensing you get:

- **Easy Activation:** Smart Licensing establishes a pool of software licenses that can be used across the entire organization—no more PAKs (Product Activation Keys).
- **Unified Management:** My Cisco Entitlements (MCE) provides a complete view into all of your Cisco products and services in an easy-to-use portal, so you always know what you have and what you are using.
- **License Flexibility:** Your software is not node-locked to your hardware, so you can easily use and transfer licenses as needed.

To use Smart Licensing, you must first set up a Smart Account on Cisco Software Central (software.cisco.com).

For a more detailed overview on Cisco Licensing, go to [cisco.com/go/licensingguide](https://www.cisco.com/go/licensingguide).

Warranty

Cisco Catalyst 8300/8200 Series Edge Platform come standard with a Cisco Limited 1-Year Return To Factory Hardware Warranty. For more information, refer to: <https://www.cisco.com/c/en/us/products/warranties/warranty-c99-744450.html>.



Contents

The gateway to your intent-based WAN network is here

Ordering Cisco Catalyst 8300 and 8200 Series Edge Platforms with Cisco DNA subscriptions

Cisco DNA subscription applicability matrix for Catalyst 8300 and 8200 edge platforms

Catalyst Routing Essentials for Cisco Catalyst 8300 and 8200 Series Edge Platforms

Ordering C8200 Catalyst Routing Essentials

Ordering C8300 Catalyst Routing Essentials

Catalyst Routing Essential Sample BoM explained

Services

Cisco Smart Licensing

Warranty

Cisco Capital

Ordering information

For more information

Cisco Capital

Flexible payment solutions to help you achieve your objectives

Cisco Capital® financing makes it easier to get the right technology to achieve your objectives, enable business transformation, and stay competitive. We can help you reduce the total cost of ownership, conserve capital, and accelerate growth. In more than 100 countries, our flexible payment solutions can help you acquire hardware, software, services, and complementary third-party equipment in easy, predictable payments. [Learn more.](#)

Ordering information

To place an order, visit the [Cisco Ordering homepage](#). To download software, visit the [Cisco Software Center](#).

For more information

For more information about the Cisco 8500 Series, visit: <https://www.cisco.com/c/en/us/products/routers/8500-series-edge-routers/index.html> or contact your local Cisco account representative.