



Prisma II Platform  
Remote User Interface  
Guide - System Release 2.02









# For Your Safety

## Explanation of Warning and Caution Icons

Avoid personal injury and product damage! Do not proceed beyond any symbol until you fully understand the indicated conditions.

The following warning and caution icons alert you to important information about the safe operation of this product:

-  **You may find this symbol in the document that accompanies this product. This symbol indicates important operating or maintenance instructions.**
-  **You may find this symbol affixed to the product. This symbol indicates a live terminal where a dangerous voltage may be present; the tip of the flash points to the terminal device.**
-  **You may find this symbol affixed to the product. This symbol indicates a protective ground terminal.**
-  **You may find this symbol affixed to the product. This symbol indicates a chassis terminal (normally used for equipotential bonding).**
-  **You may find this symbol affixed to the product. This symbol warns of a potentially hot surface.**
-  **You may find this symbol affixed to the product and in this document. This symbol indicates an infrared laser that transmits intensity-modulated light and emits invisible laser radiation or an LED that transmits intensity-modulated light.**

## Important

Please read this entire guide. If this guide provides installation or operation instructions, give particular attention to all safety statements included in this guide.

# Notices

## Trademark Acknowledgments

- Cisco, the Cisco logo, Cisco Systems, the Cisco Systems logo, Scientific Atlanta, the Scientific Atlanta logo, Prisma, Prisma II, and SciCare are trademarks or registered trademarks of Cisco Systems, Inc. and/or its affiliates in the U.S. and certain other countries.
- *All other trademarks mentioned in this document are property of their respective owners.*

## Publication Disclaimer

Cisco Systems, Inc. assumes no responsibility for errors or omissions that may appear in this publication. We reserve the right to change this publication at any time without notice. This document is not to be construed as conferring by implication, estoppel, or otherwise any license or right under any copyright or patent, whether or not the use of any information in this document employs an invention claimed in any existing or later issued patent.

## Copyright

© 2008 Cisco Systems, Inc. All rights reserved. Printed in the United States of America.

Information in this publication is subject to change without notice. No part of this publication may be reproduced or transmitted in any form, by photocopy, microfilm, xerography, or any other means, or incorporated into any information retrieval system, electronic or mechanical, for any purpose, without the express permission of Cisco Systems, Inc.

# Contents

<b>Product Notices</b>	<b>vii</b>
<b>Important Safety Instructions</b>	<b>ix</b>
<b>Laser Safety</b>	<b>xix</b>
Warning Labels .....	xxi
<b>Chapter 1 Introduction</b>	<b>1</b>
Related Publications .....	3
<b>Chapter 2 CLI Overview</b>	<b>5</b>
Prisma II Platform Configuration .....	6
User Authorization .....	7
CLI Login and Logout .....	8
CLI Command Modes .....	10
Command Syntax .....	12
General Hints and Help .....	16
<b>Chapter 3 CLI Mode Commands</b>	<b>19</b>
alarm .....	20
clear .....	21
date .....	22
help .....	23
icim .....	25
logout .....	26
manual .....	27
module .....	29
terminal .....	30
who .....	31
whoami .....	32

## Chapter 4 Module Mode Commands 33

Overview .....	35
About Modspecs .....	37
alarm .....	40
alarm domain .....	41
alarm module .....	42
chassis .....	43
exit .....	45
help .....	46
info alarm .....	48
info control .....	50
info module .....	52
info monitor .....	54
logout .....	56
manual .....	57
modid .....	61
reset .....	63
set alarmparam .....	65
set control .....	68
set module .....	70
show alarmparam .....	71
show alarmstate .....	73
show control .....	75
show module .....	77
show monitor .....	79
slot .....	81

## Chapter 5 ICIM Mode Commands 83

Overview .....	85
alarm .....	87
eventlogclear .....	88
eventlogfilter .....	89
exit .....	91
file .....	92
help .....	94
ike .....	96
info .....	97
iproute .....	100
ipsec .....	102
logout .....	103
manual .....	104
reboot .....	109
set .....	110

set clock .....	112
show .....	114
show clock.....	117
show domain .....	118
show eventlog.....	120
show eventlogall .....	121
show eventlogfilter .....	122
show file .....	123
show ike .....	124
show iproute.....	125
show provisioning .....	126
show snmp .....	128
show traps.....	129
show user .....	130
snmp.....	131
traps .....	132
user add.....	133
user change .....	135
user delete .....	137
user unlock.....	138

## Chapter 6 Terminal Mode Commands 141

Overview .....	142
alarm .....	143
colsep .....	144
exit.....	146
headers .....	147
help .....	149
logout.....	151
manual.....	152
paging.....	154
pattern .....	158
show.....	160

## Chapter 7 Web Interface 161

Introduction.....	162
Installation .....	164
Web Browser Setup .....	165
Login and Logout.....	167
Using System View .....	171
Using ICIM Details .....	174
Using Module Details.....	177
Using System Settings .....	185
Using the Event Log .....	189

User Management.....	191
Web Interface Help.....	194
<b>Chapter 8 Customer Support Information</b>	<b>197</b>
Obtaining Product Support.....	198
Return Product for Repair.....	200
<b>Appendix A Prisma II Permitted CLI Commands</b>	<b>207</b>
From CLI.....	208
From ICIM.....	209
From */* MODULE.....	215
From TERMINAL.....	218
<b>Appendix B Features Available via Remote User Interface</b>	<b>219</b>
Overview.....	220
ICIM Data.....	221
Module Data.....	224
Current Alarms.....	225
Module Alarms.....	226
Module Controls.....	227
Module Monitors.....	228
System Information.....	229
User Management.....	230
<b>Appendix C Module Parameter Descriptions</b>	<b>231</b>
XD Chassis Parameters.....	232
<b>Glossary</b>	<b>235</b>
<b>Index</b>	<b>243</b>



# Product Notices

## System Release

The information in this guide pertains to Prisma II System Release 2.02.09 and ICIM2 Firmware Release 2.02.10.

## Operating Temperature



**CAUTION:**

The warranty may be voided and the equipment damaged if you operate the equipment outside the specified temperature limits (32 to 122°F or 0 to 50°C). Specification temperature limits are measured in the air stream at the fan tray inlet and may be higher than room ambient temperature.



# Important Safety Instructions

## Read and Retain Instructions

Carefully read all safety and operating instructions before operating this equipment, and retain them for future reference.

## Follow Instructions and Heed Warnings

Follow all operating and use instructions. Pay attention to all warnings and cautions in the operating instructions, as well as those that are affixed to this equipment.

## Terminology

The terms defined below are used in this document. The definitions given are based on those found in safety standards.

**Service Personnel** - The term *service personnel* applies to trained and qualified individuals who are allowed to install, replace, or service electrical equipment. The service personnel are expected to use their experience and technical skills to avoid possible injury to themselves and others due to hazards that exist in service and restricted access areas.

**User and Operator** - The terms *user* and *operator* apply to persons other than service personnel.

**Ground(ing) and Earth(ing)** - The terms *ground(ing)* and *earth(ing)* are synonymous. This document uses *ground(ing)* for clarity, but it can be interpreted as having the same meaning as *earth(ing)*.

## Electric Shock Hazard

This equipment meets applicable safety standards.



### WARNING:

**To reduce risk of electric shock, perform only the instructions that are included in the operating instructions. Refer all servicing to qualified service personnel only.**

Electric shock can cause personal injury or even death. Avoid direct contact with dangerous voltages at all times. The protective ground connection, where provided, is essential to safe operation and must be verified before connecting the power supply.

Know the following safety warnings and guidelines:

- Dangerous Voltages

## Important Safety Instructions

- Only qualified service personnel are allowed to perform equipment installation or replacement.
- Only qualified service personnel are allowed to remove chassis covers and access any of the components inside the chassis.
- **Grounding**
  - Prisma II equipment is suitable for installation as part of the common bonding network (CBN).
  - Do not violate the protective grounding by using an extension cable, power cable, or autotransformer without a protective ground conductor.
  - Take care to maintain the protective grounding of this equipment during service or repair and to re-establish the protective grounding before putting this equipment back into operation.

**Note:** See the Installation section of this document for specific information regarding the AC and DC power, wiring, fusing, and grounding requirements for this product.

## Installation Site

When selecting the installation site, comply with the following:

- **Protective Ground** - The protective ground lead of the building's electrical installation should comply with national and local requirements.
- **Environmental Condition** - The installation site should be dry, clean, and ventilated. Do not use this equipment where it could be at risk of contact with water. Ensure that this equipment is operated in an environment that meets the requirements as stated in this equipment's technical specifications, which may be found on this equipment's data sheet.

## Installation Requirements



**WARNING:**

**Allow only qualified service personnel to install this equipment. The installation must conform to all local codes and regulations.**

## Equipment Placement



**WARNING:**

**Avoid personal injury and damage to this equipment. An unstable mounting surface may cause this equipment to fall.**

Prisma II equipment is suitable for installation in network telecommunications facilities.

To protect against equipment damage or injury to personnel, comply with the following:

- Install this equipment in a restricted access location.
- Do not install near any heat sources such as radiators, heat registers, stoves, or other equipment (including amplifiers) that produce heat.
- Place this equipment close enough to a DC input voltage source to accommodate the length of this equipment's power cord.
- Route all power cords so that people cannot walk on, place objects on, or lean objects against them. This may pinch or damage the power cords. Pay particular attention to power cords at plugs, outlets, and the points where the power cords exit this equipment.
- Use only with a cart, stand, tripod, bracket, or table specified by the manufacturer, or sold with this equipment.
- Make sure the mounting surface or rack is stable and can support the size and weight of this equipment.
- The mounting surface or rack should be appropriately anchored according to manufacturer's specifications. Ensure this equipment is securely fastened to the mounting surface or rack where necessary to protect against damage due to any disturbance and subsequent fall.

## Ventilation

This equipment has openings for ventilation to protect it from overheating. To ensure equipment reliability and safe operation, do not block or cover any of the ventilation openings. Install the equipment in accordance with the manufacturer's instructions.

## Rack Mounting Safety Precautions

### Mechanical Loading

Make sure that the rack is placed on a stable surface. If the rack has stabilizing devices, install these stabilizing devices before mounting any equipment in the rack.



**WARNING:**

**Avoid personal injury and damage to this equipment. Mounting this equipment in the rack should be such that a hazardous condition is not caused due to uneven mechanical loading.**

## Important Safety Instructions

### Reduced Airflow

When mounting this equipment in the rack, do not obstruct the cooling airflow through the rack. Be sure to mount the blanking plates to cover unused rack space. Additional components such as combiners and net strips should be mounted at the back of the rack, so that the free airflow is not restricted.



#### CAUTION:

**Installation of this equipment in a rack should be such that the amount of airflow required for safe operation of this equipment is not compromised.**

### Elevated Operating Ambient Temperature

Only install this equipment in a humidity- and temperature-controlled environment that meets the requirements given in this equipment's technical specifications.



#### CAUTION:

**If installed in a closed or multi-unit rack assembly, the operating ambient temperature of the rack environment may be greater than room ambient temperature. Therefore, install this equipment in an environment compatible with the manufacturer's maximum rated ambient temperature.**

## Handling Precautions

When moving a cart that contains this equipment, check for any of the following possible hazards:



#### WARNING:



**Avoid personal injury and damage to this equipment! Move any equipment and cart combination with care. Quick stops, excessive force, and uneven surfaces may cause this equipment and cart to overturn.**

- Use caution when moving this equipment/cart combination to avoid injury from tip-over.
- If the cart does not move easily, this condition may indicate obstructions or cables that may need to be disconnected before moving this equipment to another location.
- Avoid quick stops and starts when moving the cart.
- Check for uneven floor surfaces such as cracks or cables and cords.

## Grounding

If this equipment is equipped with an external grounding terminal, attach one end of an 18-gauge wire (or larger) to the grounding terminal; then, attach the other end of the wire to a ground, such as a grounded equipment rack.

## Equipotential Bonding

If this equipment is equipped with an external chassis terminal marked with the IEC 60417-5020 chassis icon () , the installer should refer to CENELEC standard EN 50083-1 or IEC standard IEC 60728-11 for correct equipotential bonding connection instructions.

## Connection to IT Power Systems

This equipment has been tested for IT power systems 240 VAC phase-to-phase.

## Connection to -48 V DC/-60 V DC Power Sources

If this equipment is DC-powered, refer to the specific installation instructions in this manual or in companion manuals in this series for information on connecting this equipment to nominal -48 V DC/-60 V DC power sources.

## Circuit Overload

Know the effects of circuit overloading before connecting this equipment to the power supply.



### CAUTION:

Consider the connection of this equipment to the supply circuit and the effect that overloading of circuits might have on overcurrent protection and supply wiring. Refer to the information on the equipment-rating label when addressing this concern.

## General Servicing Precautions



### WARNING:

Avoid electric shock! Opening or removing this equipment's cover may expose you to dangerous voltages.



### CAUTION:

These servicing precautions are for the guidance of qualified service personnel only. To reduce the risk of electric shock, do not perform any servicing other than that contained in the operating instructions unless you are qualified to do so. Refer all servicing to qualified service personnel.

Be aware of the following general precautions and guidelines:

- **Servicing** - Servicing is required when this equipment has been damaged in any way, such as power supply cord or plug is damaged, liquid has been spilled or objects have fallen into this equipment, this equipment has been exposed to rain or moisture, does not operate normally, or has been dropped.
- **Wristwatch and Jewelry** - For personal safety and to avoid damage of this

## Important Safety Instructions

equipment during service and repair, do not wear electrically conducting objects such as a wristwatch or jewelry.

- **Lightning** - Do not work on this equipment, or connect or disconnect cables, during periods of lightning.
- **Labels** - Do not remove any warning labels. Replace damaged or illegible warning labels with new ones.
- **Covers** - Do not open the cover of this equipment and attempt service unless instructed to do so in the instructions. Refer all servicing to qualified service personnel only.
- **Moisture** - Do not allow moisture to enter this equipment.
- **Cleaning** - Use a damp cloth for cleaning.
- **Safety Checks** - After service, assemble this equipment and perform safety checks to ensure it is safe to use before putting it back into operation.

## Electrostatic Discharge

Electrostatic discharge (ESD) results from the static electricity buildup on the human body and other objects. This static discharge can degrade components and cause failures.

Take the following precautions against electrostatic discharge:

- Use an anti-static bench mat and a wrist strap or ankle strap designed to safely ground ESD potentials through a resistive element.
- Keep components in their anti-static packaging until installed.
- Avoid touching electronic components when installing a module.

## Fuse Replacement

To replace a fuse, comply with the following:

- Disconnect the power before changing fuses.
- Identify and clear the condition that caused the original fuse failure.
- Always use a fuse of the correct type and rating. The correct type and rating are indicated on this equipment.

## Batteries

This product may contain batteries. Special instructions apply regarding the safe use and disposal of batteries:

Safety



- Insert batteries correctly. There may be a risk of explosion if the batteries are incorrectly inserted.
- Do not attempt to recharge 'disposable' or 'non-reusable' batteries.
- Please follow instructions provided for charging 'rechargeable' batteries.
- Replace batteries with the same or equivalent type recommended by manufacturer.
- Do not expose batteries to temperatures above 100°C (212°F).

#### Disposal

- The batteries may contain substances that could be harmful to the environment
- Recycle or dispose of batteries in accordance with the battery manufacturer's instructions and local/national disposal and recycling regulations.



廢電池請回收

- The batteries may contain perchlorate, a known hazardous substance, so special handling and disposal of this product might be necessary. For more information about perchlorate and best management practices for perchlorate-containing substance, see [www.dtsc.ca.gov/hazardouswaste/perchlorate](http://www.dtsc.ca.gov/hazardouswaste/perchlorate).

## Modifications

This equipment has been designed and tested to comply with applicable safety, laser safety, and EMC regulations, codes, and standards to ensure safe operation in its intended environment. Refer to this equipment's data sheet for details about regulatory compliance approvals.

Do not make modifications to this equipment. Any changes or modifications could void the user's authority to operate this equipment.

Modifications have the potential to degrade the level of protection built into this equipment, putting people and property at risk of injury or damage. Those persons making any modifications expose themselves to the penalties arising from proven non-compliance with regulatory requirements and to civil litigation for compensation in respect of consequential damages or injury.

## Accessories

Use only attachments or accessories specified by the manufacturer.

## Electromagnetic Compatibility Regulatory Requirements

This equipment meets applicable electromagnetic compatibility (EMC) regulatory requirements. Refer to this equipment's data sheet for details about regulatory compliance approvals. EMC performance is dependent upon the use of correctly shielded cables of good quality for all external connections, except the power source, when installing this equipment.

- Ensure compliance with cable/connector specifications and associated installation instructions where given elsewhere in this manual.

Otherwise, comply with the following good practices:

- Multi-conductor cables should be of single-braided, shielded type and have conductive connector bodies and backshells with cable clamps that are conductively bonded to the backshell and capable of making 360° connection to the cable shielding. Exceptions from this general rule will be clearly stated in the connector description for the excepted connector in question.
- Ethernet cables should be of single-shielded or double-shielded type.
- Coaxial cables should be of the double-braided shielded type.

## EMC Compliance Statements

Where this equipment is subject to USA FCC and/or Industry Canada rules, the following statements apply:

### FCC Statement for Class A Equipment

This equipment has been tested and found to comply with the limits for a Class A digital device, pursuant to Part 15 of the FCC Rules. These limits are designed to provide reasonable protection against harmful interference when this equipment is operated in a commercial environment.

This equipment generates, uses, and can radiate radio frequency energy and, if not installed and used in accordance with the instruction manual, may cause harmful interference to radio communications. Operation of this equipment in a residential area is likely to cause harmful interference in which case users will be required to correct the interference at their own expense.

### Industry Canada - Industrie Canadienne Statement

This apparatus complies with Canadian ICES-003.  
Cet appareil est conforme à la norme NMB-003 du Canada.

**CENELEC/CISPR Statement with Respect to Class A Information Technology Equipment**

This is a Class A equipment. In a domestic environment this equipment may cause radio interference in which case the user may be required to take adequate measures.



# Laser Safety

## Introduction

This equipment contains an infrared laser that transmits intensity-modulated light and emits invisible radiation.

## Warning: Radiation



### WARNING:

- **Avoid personal injury! Use of controls, adjustments, or procedures other than those specified herein may result in hazardous radiation exposure.**
  - **Avoid personal injury! The laser light source on this equipment (if a transmitter) or the fiber cables connected to this equipment emit invisible laser radiation. Avoid direct exposure to the laser light source.**
  - **Avoid personal injury! Viewing the laser output (if a transmitter) or fiber cable with optical instruments (such as eye loupes, magnifiers, or microscopes) may pose an eye hazard.**
- Do not apply power to this equipment if the fiber is unmated or unterminated.
  - Do not stare into an unmated fiber or at any mirror-like surface that could reflect light emitted from an unterminated fiber.
  - Do not view an activated fiber with optical instruments (e.g., eye loupes, magnifiers, microscopes).
  - Use safety-approved optical fiber cable to maintain compliance with applicable laser safety requirements.

## Warning: Fiber Optic Cables



### WARNING:

**Avoid personal injury! Qualified service personnel may only perform the procedures in this manual. Wear safety glasses and use extreme caution when handling fiber optic cables, particularly during splicing or terminating operations. The thin glass fiber core at the center of the cable is fragile when exposed by the removal of cladding and buffer material. It easily fragments into glass splinters. Using tweezers, place splinters immediately in a sealed waste container and dispose of them safely in accordance with local regulations.**

## Safe Operation for Software Controlling Optical Transmission Equipment

If this manual discusses software, the software described is used to monitor and/or control ours and other vendors' electrical and optical equipment designed to transmit video, voice, or data signals. Certain safety precautions must be observed when operating equipment of this nature.

For equipment specific safety requirements, refer to the appropriate section of the equipment documentation.

For safe operation of this software, refer to the following warnings.



**WARNING:**

- **Ensure that all optical connections are complete or terminated before using this equipment to remotely control a laser device. An optical or laser device can pose a hazard to remotely located personnel when operated without their knowledge.**
- **Allow only personnel trained in laser safety to operate this software. Otherwise, injuries to personnel may occur.**
- **Restrict access of this software to authorized personnel only.**
- **Install this software in equipment that is located in a restricted access area.**

## Warning Labels

The following illustrations display the warning labels on this equipment.



TP492

This device has multiple power entry points.  
Disconnect the appropriate power connection(s) before servicing. Refer to  
Installation / Operator's Guide for power distribution details.

Ce dispositif a les points d'entrée multiples de puissance. Débranchez les  
raccordements de puissance appropriés avant l'entretien. Référez-vous au  
manual de l'opérateur pour des détails de distribution d'énergie. PN 4023663

T13331





# 1

## Introduction

### Overview

The Prisma II™ Intelligent Control Interface Module 2 (ICIM2) and Intelligent Control Interface Module 2 - Extreme Density (ICIM2-XD) currently supports three methods of remote user access:

- Command Line Interface (CLI)
- ICIM Web Interface
- Simple Network Management Protocol (SNMP)

This guide describes remote user access for the ICIM2 (and ICIM2-XD) via the CLI and the Web Interface. Remote access via SNMP is described in detail in the *Prisma II™ XD Platform System Guide*, part number 4021339.

The CLI supports remote monitoring and control of Prisma II and Prisma II XD Platform components and operating parameters by craft operators and element management systems. The Web Interface provides many of the same functions via a user-friendly interface that requires no knowledge of CLI or SNMP command syntax.

### Purpose

This guide provides complete details on using CLI commands and the Web Interface for craft and remote system monitoring and control.

### Who Should Use This Document

This document is intended for authorized service personnel who have experience working with similar equipment. The service personnel should have appropriate background and knowledge to complete the procedures described in this document.

## Qualified Personnel

Only appropriately qualified and skilled personnel should attempt to install, operate, maintain, and service this product.



### **WARNING:**

**Allow only qualified and skilled personnel to install, operate, maintain, and service this product. Otherwise, personal injury or equipment damage may occur.**

## Scope

This guide discusses the following topics.

- Using the Command Line Interface (CLI)
- CLI mode commands
- Module mode commands
- ICIM mode commands
- Terminal mode commands
- ICIM Web Interface
- Descriptions of module parameters

## In This Chapter

- Related Publications ..... 3

## Related Publications

You may find the following publications useful as you implement the procedures in this document.

### Prisma II XD Platform

- *Prisma II™ XD Platform System Guide*, part number 4021339
- *Prisma II™ High Density Dual Reverse Receiver Installation and Operation Guide*, part number 4015908
- *Prisma II™ 1550 nm High Density QAM Transmitter Installation and Operation Guide*, part number 4019959
- *Prisma II™ High Density Forward Receiver Installation and Operation Guide*, part number 4020002
- *Prisma II™ 1310 nm High Density Transmitter Installation and Operation Guide*, part number 4009700
- *Prisma II™ Multi-Wavelength High Density Transmitter Installation and Operation Guide*, part number 4023013



# 2

---

## CLI Overview

### Introduction

The CLI for the ICIM2 allows for monitoring and control of the ICIM2 domain. This domain includes the ICIM2 itself, the chassis in which it is installed, and all other modules installed in the chassis and any daisy-chained chassis.

The CLI is designed for use by both local craft operators and remote monitoring systems. A single command set supports two command entry formats, one intended for use by human operators and another designed for efficient communication with network applications.

### In This Chapter

■ Prisma II Platform Configuration.....	6
■ User Authorization.....	7
■ CLI Login and Logout.....	8
■ CLI Command Modes.....	10
■ Command Syntax .....	12
■ General Hints and Help .....	16

# Prisma II Platform Configuration

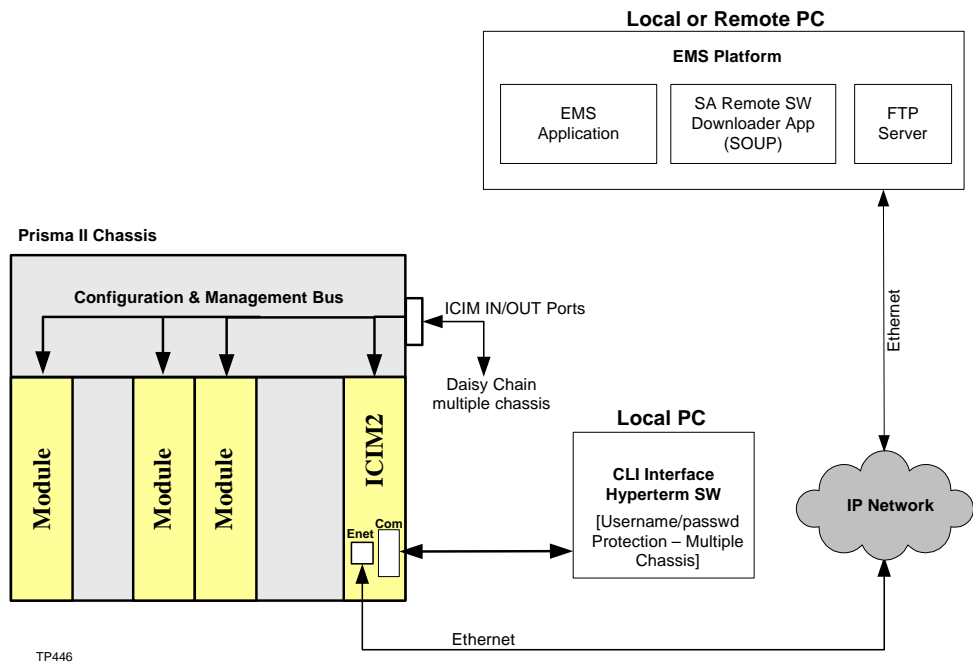

## User Authorization

Access to the CLI is controlled by password-protected login. Each CLI user is granted access at one of three authorization levels:

Authorization Level	Description
Admin	Admin level users can add and delete users, change user passwords, and change IP addresses and other critical values.
ReadWrite	Users with ReadWrite access can view system parameter values as well as change most control and operating parameter values.
Read	Users with Read access can view system parameter values, but cannot change them.

An authorization table in the ICIM2 retains CLI user information. The designated CLI administrator manages this information by adding, deleting, and changing authorizations as required.

For further information, see the commands *show user* (on page 130), *user add* (on page 133), *user change* (on page 135), *user delete* (on page 137), and *user unlock* (on page 138). Additional details are provided in the **User Management** section of the *Prisma II™ XD Platform System Guide*, part number 4021339.

## CLI Login and Logout

To use the CLI, you must first establish communication with a chassis in one of two ways:

- Use a serial connection (e.g., HyperTerminal) as described in the *Prisma II™ XD Platform System Guide*, part number 4021339.
- Use Telnet to establish communication with the chassis over an IP network, as described in the *Prisma II™ XD Platform System Guide*, part number 4021339.
- Use your element management system (see your network administrator for assistance).

Once communication is established, the control console or PC displays the following message from the ICIM2:

```
Scientific-Atlanta Intelligent Communications Interface Module (ICIM)
```

```
-----  
W A R N I N G  
-----
```

```
Unauthorized or improper use of this system may result in  
administrative disciplinary action and civil or criminal penalties.  
By continuing to use this system you indicate your awareness of and  
consent to these terms and conditions of use. LOG OFF IMMEDIATELY  
if you do not agree to the conditions stated in this warning.
```

```
login:
```

**Note:** When communicating via serial connection, some terminal programs may send unexpected characters to the ICIM2 on initial connection. If this occurs and the user presses the Enter key to access the login prompt, the ICIM2 may interpret the unexpected characters as an invalid user name. This leads to a trap and an entry in the event log indicating a failed login.

## To Log In

Complete the following steps to log into the CLI.

- 1 At the login prompt, type your assigned user name, and then press **Enter**. The user name is case-sensitive.

**Note:** If no user name has been assigned yet, use the default user name, **Administrat0r** (note the zero in place of "o").

- 2 At the password prompt, type your assigned password, and then press **Enter**. The password is case-sensitive.

**Note:** If no password has been assigned yet, use the default password, **AdminPassw0rd** (note the zero in place of "o").



An acknowledgement similar to the following appears:

```
User Administrat0r logged in successfully on 09/05/06 at 8:09:18
Previous successful login was on 09/01/06 at 15:56:28
There were no failed attempts to login with this user id previously
CLI>
```

You can now use CLI commands to interact with the ICIM2.

**Note:** For security reasons, it is recommended that the default user be changed immediately. For additional information, see the **User Management** chapter of the *Prisma II™ XD Platform System Guide*, part number 4021339.

## To Log Out

To log out of the CLI and exit the session, type **logout**, and then press **Enter**.

**Note:** The CLI recognizes the **logout** command at any command prompt, regardless of the current command mode.

### Important:

- For Telnet operation, the computer you are using must have a network connection through which it can reach the ICIM2 via its IP address.
- No more than four Telnet sessions are allowed at one time.



#### CAUTION:

Always use the Logout command to close a serial port or Telnet CLI session. Closing a serial port session without issuing the Logout command leaves the session open for a possible future connection. This may allow unauthorized access by a new user if the previous user had a higher authorization privilege level.

## CLI Command Modes

All CLI interactions occur in one of four command modes. Command modes affect the scope of the commands as well as how they are interpreted.

Mode	Description
CLI	The default command mode at login, used for issuing CLI commands to perform general control and monitoring tasks.
Module	Used to issue Module mode commands, which are directed to a specific module or range of modules installed in the ICIM2 domain.
ICIM	Used to issue ICIM mode commands, which are directed to the ICIM2 module itself.
Terminal	Used to issue Terminal mode commands, which control the way that information appears onscreen.

## Command Prompts

The onscreen command prompt indicates the command mode currently in effect, as follows:

Prompt	Meaning
CLI>	CLI mode commands are now recognized.
*/* MODULE>	Module mode commands are now recognized. Commands are directed to all chassis and slots in the ICIM2 domain (see below for details).
ICIM>	ICIM mode commands are now recognized.
TERMINAL>	Terminal mode commands are now recognized.

## To Change Command Modes

CLI mode is the default command mode at login. To select a different command mode, enter the desired mode name at the CLI> command prompt.

The following sample dialog shows how you as a craft operator would change from CLI mode to Module mode:

```
CLI> module
*/* MODULE>
```

You can then use any CLI commands recognized in Module command mode.

To exit Module mode and return to CLI mode, use the **exit** command:

```
*/ * MODULE> exit
```

```
CLI>
```

If desired, you can then change to **icim** command mode:

```
CLI> icim
```

```
ICIM>
```

You cannot change command modes directly, e.g., by typing **terminal** at the ICIM> prompt. Instead, you must first return to CLI mode and then select a new command mode, as shown below:

```
ICIM> exit
```

```
CLI> terminal
```

```
TERMINAL>
```

## Command Syntax

To facilitate its use by both craft operators and remote monitoring systems, the CLI accepts commands in either of two formats:

- A modal command format allows craft operators to first select a command mode, and then use mode-specific commands and help screens.
- A non-modal command format allows an element management system (or a craft operator, if desired) to enter all command parameters, including command mode changes, on a single line. While only one command can be entered, the command mode does not need to be changed between commands.

The syntax for these command formats is described below.

### Modal Command Syntax

The general format for a modal CLI command, as a craft operator might send it, is as follows:

```

modeName modeOptions
modeOptions
modeOptions Action actionOptions Values
Action actionOptions Values
Exit

```

The parameters in the command have the following functions:

Keyword	Function
modeName	The name of a mode switch: <b>cli</b> , <b>module</b> , <b>icim</b> , or <b>terminal</b> .
modeOptions	Options that may be associated with the modename.
Action	A command keyword such as <b>set</b> , <b>show</b> , <b>info</b> , etc.
actionOptions	Options that may be associated with the action.
Values	Values that may be associated with the action.
Exit	Used to return to CLI command mode.

#### Example

Craft operators typically enter commands modally; that is, by first changing to the appropriate command mode and then entering the desired command.

The following sample dialog illustrates this process.

```
CLI> module
*/ * MODULE> chassis 1 slot 6

01/06 MODULE> alarm module
  No active alarms found for the specified module range

01/06 MODULE>
```

- In the first line of this example, the operator selects the Module command mode.
- In the next line, the prompt has changed to reflect the new command mode. The operator then selects chassis 1, slot 6 as the target for subsequent commands.
- On pressing Enter, the prompt then changes from \*/ \* MODULE> to 01/06 MODULE> to show the selection of chassis 1, slot 6 in effect.
- Next, the operator types the **alarm module** command.
- On pressing **Enter**, the system response "No active alarms found for the specified module range" reflects the alarm status of the module in chassis 1, slot 6 of the current ICIM2 domain.

Modal command entry is often helpful for human operators. It can minimize the need for keystrokes in some cases, thus saving time and eliminating a possible source of error. Modal operation can also help streamline the work flow by focusing commands and human attention on a particular chassis or module of interest.

## Non-Modal Command Syntax

The general format for a non-modal CLI command, as usually sent from an element management system, is as follows:

**modeName modeOptions Action actionOptions Values Exit**

The parameters in the command have the same functions as in modal command entry:

Keyword	Function
modeName	The name of a mode switch: <b>cli</b> , <b>module</b> , <b>icim</b> , or <b>terminal</b> .
modeOptions	Options that may be associated with the modename.
Action	A command keyword such as <b>set</b> , <b>show</b> , <b>info</b> , etc.
actionOptions	Options that may be associated with the action.
Values	Values that may be associated with the action.
Exit	Used to return to CLI command mode.

### Example

A non-modal command is entered without changing command modes. For example, the **alarm module** command shown above could have been entered as follows:

## Chapter 2 CLI Overview

```
CLI> module chassis 1 slot 6 exit
SUCCESS!
CLI> module alarm module exit
  No active alarms found for the specified module range
SUCCESS!
CLI>
```

The CLI command line interpreter would then parse the command into the following sequence of instructions:

- Switch to **Module** command mode.
- Direct subsequent commands to **chassis 1** in the current ICIM2 domain.
- Direct subsequent commands to **slot 6** of the designated chassis in the current ICIM2 domain.
- **Exit** Module mode and return to CLI command mode following command execution.
- Display the **alarm** status of the specified device, i.e., the module occupying chassis 1, slot 6.
- **Exit** Module mode and return to CLI command mode following command execution.

This command entry format is generally preferred for use by element management systems. For maximum efficiency, these systems should be programmed to send CLI commands in non-modal format, i.e., with all command parameters on a single line.

On occasion, this method may also be more efficient for craft operators who are already very familiar with the syntax of the command being used.

## Command Usage Guidelines

- CLI commands, unlike login passwords, are insensitive to case. For example, the keywords **Set**, **set**, and **SET** all have the same meaning in CLI.
- If a particular action requires parameters that are not included in the command, an error message will be issued.
- In general, CLI commands issued from an element management system should have the non-modal "single-line" form shown above. Exceptions may be made where they will improve efficiency.
- For non-modal command entry, the **exit** parameter is included for backward compatibility. It is not required in order to return to the CLI mode.
- Mode changes can be used to restrict the scope of most CLI commands. When the command mode changes, the prompt changes to reflect the new mode.

## Wildcards

Some CLI command parameters can include one or more "wildcard" characters (\*) for added flexibility.

The following sample dialog shows how a craft operator could use a wildcard to check the output power on all modules in chassis 20:

```
CLI> module
/* MODULE> chassis 1 slot *
SUCCESS!
01/* MODULE> show monitor outpwr

  MODID  NAME      VALUE      UNITS
  01/01  OutPwr     3.1        dBm
  01/15  OutPwr     9.9512     dBm

SUCCESS!
01/* MODULE>
```

- In the first line above, the operator changes from CLI command mode to Module command mode and specifies chassis 1, any (\*) slot.
- In the next line, the prompt (01/\* MODULE>) now reflects the new command mode and chassis specification.
- At this prompt, the operator enters the **show** command followed by **monitor** and **outpwr**. These parameters specify that the response should include only modules for which OutPwr is a monitored parameter.
- In the next three lines, the response identifies each module by its chassis and slot location (e.g., 01/01) and displays the current output power level in dBm.

In the following example, a craft operator uses the wildcard character to check all monitored parameters whose name contained **pwr**:

```
CLI> module chassis 2 slot *
SUCCESS!
02/* MODULE> show monitor *pwr

  MODID  NAME      VALUE      UNITS
  02/03  InPwr     -0.255989  dBm
  02/03  RFPwr     -6.81404   dBm
  02/12  InPwr     -1.41318   dBm
  02/12  RFPwr     -3.79324   dBm

SUCCESS!
02/* MODULE>
```

The pattern matching is caseless, so the parameters OutPwr, InPwr, and RFPwr are included in the response even though a lowercase P was used in the command line.

Wildcards default to MS Windows filename pattern matching format, where **?**, **\***, and **[x-y]** have special meaning. This format can be adjusted to use POSIX regex wildcards using the **pattern** command from Terminal command mode. See *Terminal Mode Commands* (on page 141) for additional information.

**Note:** Wildcards are never allowed anywhere in a **set** command.

## General Hints and Help

The CLI command information in this section applies regardless of the command or command mode currently in use.

### Shortcuts and Abbreviations

The CLI interpreter recognizes shortcuts and abbreviations for certain commands. A shortcut is a single key or key combination (such as Ctrl-u) that is functionally equivalent to a longer command. Shortcuts are handy for craft operators because they reduce keystrokes, saving time and reducing the risk of a typing error.

The following table lists the shortcuts available in all CLI command modes.

Shortcut	Description
TAB	Automatically completes typing of a keyword.
?	Displays a list of expected keywords or tokens.
Ctrl-d	Deletes the current character.
Ctrl-u	Deletes text up to the cursor.
Ctrl-k	Deletes text from the cursor to the end of the line.
Ctrl-a	Moves the cursor to the beginning of the line.
Ctrl-e	Moves the cursor to the end of the line.
Ctrl-p	Gets the previous command from history.
Ctrl-n	Gets the next command from history.
Ctrl-b	Moves the cursor left.
Ctrl-f	Moves the cursor right.
Esc-b	Moves back one word.
Esc-f	Moves forward one word.
Esc-c	Converts the remainder of the word to uppercase.
Esc-l	Converts the remainder of the word to lowercase.
Esc-d	Deletes the remainder of the word.
Ctrl-w	Deletes the current word up to the cursor.
Ctrl-t	Transposes the current and previous characters.
Ctrl-z	Enters the command and then returns to the root prompt.
Ctrl-l	Refreshes the input line.
↑	Gets the previous command from history.
↓	Gets the next command from history.



Shortcut	Description
←	Moves the cursor left.
→	Moves the cursor right.

**Note:** You can also view a list containing most of these shortcuts from the CLI by issuing the command **help edit**.

An abbreviation is a truncated form of a command name. The CLI recognizes the shortest character string that uniquely identifies a command or parameter. For example, in CLI command mode, typing **i** (or **ici**, etc.) is recognized as equivalent to typing the **icim** command. As with shortcuts, abbreviations are useful for craft operators because they save typing time and reduce the chance of typing error.

**Note:** Avoid using shortcuts and abbreviations in commands sent by a network or element management system. In this context, they would do little to reduce typing time or error and could make program code more difficult to maintain.

## Alarm Information

You can use the **alarm** command in any command mode to get a list of currently active alarms in the ICIM2 domain. In Module command mode, you can use the **alarm module** command to narrow the scope of the response. For details, see *alarm module* (on page 42).

## Getting Online Help

To display a listing of recognized commands for the current command mode, type **help** and then press **Enter**, or just type the **?** character.

Typing the **?** character is the best way to get help for available commands and parameters. For example:

- Typing **?** at the ICIM> prompt will show all of the available ICIM mode commands.
- Typing **set ?** at the ICIM> prompt will show all of the available parameters for the **set** command.

To display a description of all recognized commands for the current command mode, type **manual** and then press **Enter**.

You can also display a list of recognized commands for Module, ICIM, and Terminal modes from CLI command mode using the following commands:

- module manual
- terminal manual
- icim manual

**Note:** A summary of recognized CLI commands by command mode is provided in *Prisma II Permitted CLI Commands* (on page 207).

# 3

## CLI Mode Commands

### Introduction

This chapter describes the commands that can be executed in CLI command mode. Some of the commands available in CLI command mode are global in scope, and give the same results whether entered in CLI mode or another command mode.

### In This Chapter

■ alarm.....	20
■ clear.....	21
■ date.....	22
■ help .....	23
■ icim.....	25
■ logout.....	26
■ manual.....	27
■ module.....	29
■ terminal .....	30
■ who .....	31
■ whoami.....	32

# alarm

## Syntax

alarm

## Description

The **alarm** command is used to display all active alarms in the domain of the ICIM2. This command produces the same results whether entered in CLI, Module, Terminal, or ICIM command mode.

**Note:** This command is functionally equivalent to *alarm domain* (on page 41).

## Parameters

None

## Access Rights Required

Read, ReadWrite, or Admin

## Example

```
CLI> alarm
  No active alarms found

CLI>
```

This response shows that no alarms are active in the ICIM2 domain. To narrow the command scope to specific chassis or modules, use *alarm module* (on page 42).

## Related Commands

- alarm (Module command mode)
- alarm (ICIM command mode)
- alarm (Terminal command mode)
- alarm domain (Module command mode)
- alarm module (Module command mode)

# clear

## Syntax

clear

## Description

The **clear** command is used to clear the terminal display.

## Parameters

None

## Access Rights Required

Read, ReadWrite, or Admin

## Example

```
CLI> clear  
[screen clears and new prompt appears at top line]  
CLI>
```

## Related Commands

None

## date

### Syntax

date

### Description

The **date** command is used to display the current date and time.

### Parameters

None

### Access Rights Required

Read, ReadWrite, or Admin

### Example

```
CLI> date
Tue, 3 Oct 2006 11:36:43 EST
SUCCESS!
CLI>
```

### Related Commands

show clock (ICIM command mode)

# help

## Syntax

```
help modeOption
```

## Description

The **help** command is used alone to display onscreen help for all CLI mode commands, or with a **modeOption** parameter to display help for a single command or function.

**Note:** Typing a question mark (?) character at the CLI> command prompt gives the same result as typing help without a mode option parameter.

## Parameters

The possible values and results for the **modeOption** parameter are listed below.

<b>modeOption</b>	<b>Description</b>
<empty>	Displays onscreen help for all recognized CLI mode commands.
<commandname>	Displays onscreen help for the specified command, if recognized.
edit	Displays onscreen help for command line editing and syntax.
commands	Displays onscreen help for global commands (exit, help, who, whoami).

## Access Rights Required

Read, ReadWrite, or Admin

## Examples

```
CLI> help
```

```
alarm           - Display active alarms for all modules
clear           - Clear the screen
date            - Display the current system date & time
icim            - Enter ICIM mode
logout          - Log off this system
manual          - Show detailed help text
module          - Enter module mode
terminal        - Enter terminal mode
```

```
CLI> help edit
```

```
Available editing keystrokes
```

## Chapter 3 CLI Mode Commands

```
Delete current character.....Ctrl-d
Delete text up to cursor.....Ctrl-u
Delete from cursor to end of line.....Ctrl-k
Move to beginning of line.....Ctrl-a
Move to end of line.....Ctrl-e
Get prior command from history.....Ctrl-p
Get next command from history.....Ctrl-n
Move cursor left.....Ctrl-b
Move cursor right.....Ctrl-f
Move back one word.....Esc-b
Move forward one word.....Esc-f
Convert rest of word to uppercase.....Esc-c
Convert rest of word to lowercase.....Esc-l
Delete remainder of word.....Esc-d
Delete word up to cursor.....Ctrl-w
Transpose current and previous character.....Ctrl-t
Enter command and return to root prompt.....Ctrl-z
Refresh input line.....Ctrl-l
```

CLI>

## Related Commands

- help (Module command mode)
- help (ICIM command mode)
- help (Terminal command mode)



# icim

## Syntax

icim

## Description

The **icim** command is used to change from CLI command mode to ICIM command mode.

## Parameters

None

## Access Rights Required

Read, ReadWrite, or Admin

## Examples

CLI is the default command mode at login. To enter ICIM command mode, enter the **icim** command as follows:

```
CLI> icim
ICIM> exit
CLI>
```

To enter ICIM command mode from any command mode other than CLI, it is necessary to first exit to CLI command mode, as follows:

```
*/ * MODULE> exit
CLI> ICIM
ICIM>
```

## Related Commands

module

terminal

exit

# logout

## Syntax

logout

## Description

The **logout** command is used to terminate the current CLI session. This command is available in every command mode.

### Important:

- For Telnet operation, the computer you are using must have a network connection through which it can reach the ICIM2 via its IP address.
- No more than four Telnet sessions are allowed at one time.



### CAUTION:

Always use the Logout command to close a serial port or Telnet CLI session. Closing a serial port session without issuing the Logout command leaves the session open for a possible future connection. This may allow unauthorized access by a new user if the previous user had a higher authorization privilege level.

## Parameters

None

## Access Rights Required

Read, ReadWrite, or Admin

## Example

```
CLI> logout
connection to host lost
C:\>
```

## Related Commands

- logout (Module command mode)
- logout (ICIM command mode)
- logout (Terminal command mode)

# manual

## Syntax

**modeOption** manual

## Description

The **manual** command is used to display detailed help for CLI command mode, or for another command mode if specified by a preceding **modeOption** parameter.

## Parameters

The possible values for the **modeOption** parameter and their results are listed below.

<b>modeOption</b>	<b>Description</b>
<empty>	Displays detailed help for CLI command mode.
module	Displays detailed help for Module command mode.
terminal	Displays general help for Terminal command mode.
icim	Displays detailed help for ICIM command mode.

## Access Rights Required

Read, ReadWrite, or Admin

## Example

```
CLI> manual
```

Try one of these help commands for details on specific modes:

```
  module manual
  terminal manual
  icim manual
```

General Hints:

Keywords can be abbreviated to a unique prefix. For instance in CLI mode, the keyword 'MODULE' can be given as just 'm' or 'mod'.

Use TAB to autocomplete a keyword.  
 Use ? to list expected keywords or tokens (depends on previous input).  
 Use BACKSPACE to erase previous characters.  
 Use 'help edit' to display more editing commands

Use Alarm in any mode to get a list of active alarms. When in Module mode, you can also narrow the list of active alarms to just those in the current ModSpec range. See the Module Help for further details.

Note: entering a mode command (MODULE, ICIM, TERMINAL) enters that mode immediately but it is not indicated until the next prompt is displayed.

## Chapter 3 CLI Mode Commands

The interface uses modes: CLI, MODULE, TERMINAL, and ICIM. The prompt reflects the current mode. Enter the mode name to enter that mode, and use EXIT to leave the mode and return to CLI mode.

```
CLI>
```

### Related Commands

manual (ICIM command mode)

manual (Module command mode)

manual (Terminal command mode)

help

# module

## Syntax

module

## Description

The **module** command is used to change from CLI command mode to Module command mode.

## Parameters

None

## Access Rights Required

Read, ReadWrite, or Admin

## Examples

CLI is the default command mode at login. To enter Module command mode, enter the **module** command as follows:

```
CLI> module
/* MODULE> exit
CLI>
```

To enter Module command mode from any command mode other than CLI, it is necessary to first exit to CLI command mode, as follows:

```
ICIM> exit
CLI> module
/* MODULE>
```

## Related Commands

icim

terminal

exit

## terminal

### Syntax

terminal

### Description

The **terminal** command is used to change from CLI command mode to Terminal command mode.

### Parameters

None

### Access Rights Required

Read, ReadWrite, or Admin

### Examples

CLI is the default command mode at login. To enter Terminal command mode, enter the **terminal** command as follows:

```
CLI> terminal
TERMINAL> exit
CLI>
```

To enter Terminal command mode from any command mode other than CLI, it is necessary to first exit to CLI command mode, as follows:

```
*/ * MODULE> exit
CLI> terminal
TERMINAL>
```

### Related Commands

module

icim

exit

# who

## Syntax

who

## Description

The **who** command is used to display a list of the currently logged in users.

## Parameters

None

## Access Rights Required

Admin

## Example

```
CLI> who

LOGIN IDENTIFIER  IP ADDRESS      TYPE      LOGIN TIME
Administrat0r    local console   CLI       03/13/07 11:22:01

SUCCESS!
CLI>
```

**Note:** The value in the IP Address column indicates the IP address from which the remote user is connecting to the ICIM2. If the user is connecting locally via the ICIM2 serial port, the value in this column will be "local console," as shown in the example above.

## Related Commands

whoami

## whoami

### Syntax

whoami

### Description

The **whoami** command is used to display the username of the current CLI user.

### Parameters

None

### Access Rights Required

Read, ReadWrite, or Admin

### Example

```
CLI> whoami
User name: AdministratOr
CLI>
```

### Related Commands

who



# 4

---

## Module Mode Commands

### Introduction

This chapter describes the CLI commands that can be executed in the Module command mode.

## In This Chapter

■ Overview .....	35
■ About Modspecs .....	37
■ alarm .....	40
■ alarm domain .....	41
■ alarm module .....	42
■ chassis .....	43
■ exit .....	45
■ help .....	46
■ info alarm .....	48
■ info control .....	50
■ info module .....	52
■ info monitor .....	54
■ logout .....	56
■ manual .....	57
■ modid .....	61
■ reset .....	63
■ set alarmparam .....	65
■ set control .....	68
■ set module .....	70
■ show alarmparam .....	71
■ show alarmstate .....	73
■ show control .....	75
■ show module .....	77
■ show monitor .....	79
■ slot .....	81

## Overview

Module mode commands allow for the control and monitoring of a selected module or range of modules. The scope of a Module mode command is defined using a special command called a module specification, or **modspec**. The Module mode command prompt always indicates the modspec currently in effect. For additional information, see *About Modspecs* (on page 37).

### Types of Module Commands

The following commands are recognized in Module command mode:

- The **alarm** commands are used to display active alarms in selected portions of the ICIM2 domain.
- The **chassis** command is used to select a chassis or range of chassis for subsequent commands.
- The **exit** command is used to exit Module command mode and return to CLI command mode.
- The **help** command is used to display abbreviated help for Module mode commands.
- The **info** commands are used to display selected alarm, control, module, or monitoring information in detail.
- The **logout** command is used to exit the currently active CLI session.
- The **manual** command is used to display detailed help for Module mode commands.
- The **modid** command is used to specify the modspec (chassis and slot) for subsequent commands.
- The **reset** command is used to restore module controls and alarms to their factory default values.
- The **set** commands are used to assign a value to alarm or control parameters.
- The **show** commands are used to display the values of selected alarm, control, module, or monitoring parameters.
- The **slot** command is used to select a slot or range of slots for subsequent commands.

This chapter describes each of these commands and its applications in detail.

**Note:** The **show** commands can accept a wildcard character as well as a range of chassis and slots. All other Module mode commands must be applied to a specific chassis and slot location, as explained in *About Modspecs* (on page 37).

## To Access Module Command Mode

The CLI only recognizes Module mode commands in Module command mode.

Complete the following steps to enter Module command mode.

- 1 Confirm that you have logged onto CLI as explained in *CLI Login and Logout* (on page 8).
- 2 At the CLI> prompt, type **module**, and then press **Enter**.
- 3 Confirm that the command prompt changes to X/Y MODULE> where X and Y are either \*, a number, or a range of numbers in brackets. You are now in Module command mode.

## About Modspecs

Module specifications, or **modspecs**, are commands that specify the chassis and slot to which subsequent Module mode commands apply. Modspecs can specify a single chassis or a range of chassis, and likewise, can specify a single module or a range of modules. The command prompt in Module mode (e.g. 01/01 MODULE>) always reflects the modspec currently in effect. For this reason, the Module mode prompt is also sometimes referred to as the modspec.

### Module Command Prompt

Once in Module mode, the command prompt takes the form

**X/Y MODULE>**

where X indicates the chassis specification currently in effect, and Y indicates the current slot specification.

The appearance of the Module command prompt changes to reflect the changing modspec, as shown in the following examples.

Module Prompt	Indication
*/* MODULE>	The modspec is "wild." The command will include all slots and chassis in the ICIM2 domain.
20/* MODULE>	The modspec specifies a chassis but not a slot. The command will address all slots (modules) in chassis 20.
*/11 MODULE>	The modspec specifies a slot but not a chassis. The command will address slot 11 of all chassis in the ICIM2 domain.
20/11 MODULE>	The modspec specifies a chassis and a slot. The command will address only slot 11 of chassis 20 in the ICIM2 domain.
[1-7]/[4-15] MODULE>	The modspec indicates a range of slots and chassis. The command will address slots 4-15 of chassis 1-7 in the domain.

### Modspec Commands

Three commands, **chassis**, **slot**, and **modid**, allow you to select a single chassis and slot location, a range of chassis or slots (or some combination), or the entire ICIM2 domain.

**chassis**

The **chassis** command can be used to specify any of the following:

- A single chassis, using the chassis ID number (0-99).

## Chapter 4 Module Mode Commands

- A range of chassis, using two chassis ID numbers in brackets, e.g., [2-87].
- All chassis in the ICIM2 domain, using the wildcard character (\*) in place of a chassis ID.

The following sample dialog illustrates the use of all three methods. Note how the Module mode prompt changes on each line to reflect the changing modspec.

```
*/ * MODULE> chassis 10           (selects any slot in chassis 10)
10/* MODULE> chassis [2-87]      (selects any slots in chassis 2-87)
[02-87]/* MODULE> chassis *      (selects all chassis and slots)
*/ * MODULE>
```

### slot

The **slot** command can be used to specify any of the following:

- A single slot, using the slot number (0-16).
- A range of slots, using two slot numbers in brackets, e.g., [2-16].
- All slots in all chassis currently specified, using the wildcard character (\*) in place of a slot number.

The following sample dialog illustrates the use of all three methods. Note how the Module prompt changes on each line to reflect the changing modspec.

```
10/* MODULE> slot [2-16]          (selects chassis 10, slots 2-16)
10/[02-16] MODULE> slot 15        (selects chassis 10, slot 15)
10/15 MODULE> slot *              (selects chassis 10, all slots)
10/* MODULE>
```

### chassis and slot

The **chassis** and **slot** commands can also be used together on a single command line, as shown in the following example.

```
10/* MODULE> chassis [1-5] slot [4-13] (selects chassis 1-5, slots 4-13)
[01-05]/[04-13] MODULE> chassis 5 slot 12 (selects chassis 5, slot 12)
05/12 MODULE> chassis * slot *          (selects all chassis and slots)
*/ * MODULE>
```

### modid

The **modid** command combines the functions of the **chassis** and **slot** commands, allowing you to specify a chassis and slot location using a single parameter, as shown below.

```
*/ * MODULE> modid [1-5]/[4-13]      (selects chassis 1-5, slots 4-13)
[01-05]/[04-13] MODULE> modid 0512   (selects chassis 5, slot 12)
05/12 MODULE> modid *                 (selects all chassis and slots)
*/ * MODULE>
```

The **modid** command can be somewhat faster to enter, but the resulting dialog may be less readable than when using the **chassis** and **slot** commands, either separately or together on one command line.

## Notes on Usage

- Modspecs stay in effect when exiting and re-entering Module command mode. However, modspecs do not affect the scope of CLI, ICIM, or Terminal mode commands.
- When specifying a range of chassis or slots, the specified range need not be fully populated. For example, the chassis range [1-7] is valid even if there are fewer than seven chassis within that range. In addition, all chassis within the specified range are included whether or not their chassis numbers are contiguous.
- For an element management system or other automatic control interface, a specific chassis and slot are required for backward compatibility, and should always be specified.
- For craft operators, ranges may be specified for all Module mode commands except for **set**.

# alarm

## Syntax

alarm

## Description

The **alarm** command is used to display all active alarms in the domain of the ICIM2. This command produces the same results whether entered in CLI, Module, Terminal, or ICIM command mode.

**Note:** This command is functionally equivalent to *alarm domain* (on page 41).

## Parameters

None

## Access Rights Required

Read, ReadWrite, or Admin

## Example

```
20/* MODULE> alarm
  No active alarms found

20/* MODULE>
```

This response shows that no alarms are active in the ICIM2 domain. To narrow the command scope to specific chassis or modules, use *alarm module* (on page 42).

## Related Commands

alarm (CLI command mode)

alarm (ICIM command mode)

alarm (Terminal command mode)

alarm domain

alarm module



# alarm domain

## Syntax

alarm domain

## Description

The **alarm domain** command is used to display all active alarms in the domain of the ICIM2.

**Note:** This command is functionally equivalent to the **alarm** command.

## Parameters

None

## Access Rights Required

Read, ReadWrite, or Admin

## Example

```
20/* MODULE> alarm domain
  No active alarms found

20/* MODULE>
```

This response indicates that no alarms are currently active anywhere in the ICIM2 domain. Note that the scope of the response is not limited to chassis 20, despite the current status of the Module prompt.

## Related Commands

alarm

alarm module

## alarm module

### Syntax

```
alarm module
```

### Description

The **alarm module** command is used to display all active alarms in the range indicated by the Module prompt (modspec).

### Parameters

None

### Access Rights Required

Read, ReadWrite, or Admin

### Example

```
20/[5-7] MODULE> alarm module
  No active alarms found for the specified module range
20/[5-7] MODULE>
```

This response indicates that no alarms are currently active in modules 5, 6, or 7 of chassis 20 in the ICIM2 domain. It does not reflect any alarms that may exist in other modules in chassis 20 or in other chassis in the domain.

### Related Commands

alarm

alarm domain

# chassis

## Syntax

chassis chassisidvalue

## Description

The **chassis** command is used to specify:

- A single chassis, using the chassis ID number (0-99; see caution below).
- A range of chassis, using two chassis ID numbers in brackets, e.g., [2-87].
- All chassis in the ICIM2 domain, using the wildcard character (\*) in place of a chassis ID.

## Parameters

The **chassisidvalue** parameter can be any number from 0 to 99, a bracketed pair of numbers in the same range separated by a hyphen (-), or a wildcard (\*) to indicate all chassis.



### CAUTION:

Setting the chassis ID to 00 is not recommended as it causes the entity MIB to violate RFC-2737 by creating an invalid object identifier. This may affect operation with some management systems that use the entity MIB. In particular, attempts to access the fans (in virtual slot 0) in chassis 00 will fail if made via serial TNCs (or ROSA-EM) or LCI.

## Access Rights Required

Read, ReadWrite, or Admin

## Example

The following sample dialog illustrates the use of all three methods described above.

```

*/ * MODULE> chassis 10           (selects any slot in chassis 10)
10/* MODULE> chassis [2-87]      (selects chassis 2-87, all slots)
[02-87]/* MODULE> chassis *      (selects all chassis and slots)
*/ * MODULE>

```

### Notes on Usage

- The **chassis** command can be used together with the **slot** command to specify a particular chassis and slot location. However, it is often simpler to use the **modid** command for this purpose. See *modid* (on page 61) for details.

## Chapter 4 Module Mode Commands

- Modspecs stay in effect when exiting and re-entering Module command mode. However, modspecs do not affect the scope of CLI, ICIM, or Terminal mode commands.
- When specifying a range of chassis or slots, the specified range need not be fully populated. For example, the chassis range [1-7] is valid even if there are fewer than seven chassis within that range. In addition, all chassis within the specified range are included whether or not their chassis numbers are contiguous.
- For an element management system or other automatic control interface, a specific chassis and slot are required for backward compatibility, and should always be specified.
- For craft operators, ranges may be specified for all Module mode commands except for **set**.

### Related Commands

slot

modid

# exit

## Syntax

exit

## Description

The **exit** command is used to exit Module command mode to the CLI command mode for the purpose of entering CLI mode commands or selecting ICIM or Terminal command mode.

**Note:** The **exit** command is not recognized in CLI mode and does not result in a logout. See *logout* (on page 56) for details.

## Parameters

None

## Access Rights Required

Read, ReadWrite, or Admin

## Example

```
/* MODULE> exit
CLI> icim
ICIM> exit
CLI> terminal
TERMINAL> exit
CLI> module
/* MODULE>
```

## Related Commands

logout

# help

## Syntax

```
help modeOption
```

## Description

The **help** command is used alone to display onscreen help for all Module mode commands, or with a **modeOption** parameter to display help for a single command or function.

**Note:** Typing a question mark (?) at the command prompt gives results similar to typing help without a mode option parameter.

## Parameters

The possible values and results for the **modeOption** parameter are listed below.

<b>modeOption</b>	<b>Description</b>
<empty>	Displays onscreen help for all recognized Module mode commands.
<commandname>	Displays onscreen help for the specified command, if recognized.
edit	Displays onscreen help for command line editing and syntax.
commands	Displays onscreen help for global commands (exit, help, who, whoami).

## Access Rights Required

Read, ReadWrite, or Admin

## Example

```
*/ * MODULE> help
```

```
module          - Enter module mode
alarm           - Display active alarms
chassis        - Set the chassis (and optionally the slot) specification
                for module commands
info           - Display detailed information regarding modules
logout         - Log off this system
manual         - Show detailed help text
modid          - Set the chassis and slot ranges for module commands
reset         - Reset a module to its default values
set           - Set a value for a module
show          - Display the values of specified parameters. If the alarm
                param parameter is specified then the name and alarm_par
                am parameters must also be specified. If the alarmstate,
                control or monitor parameters are specified, then the
                name (and only name) parameter must also be specified.
                If the module parameter is specified, then no other
                parameters are accepted.

slot           - Set the slot specification for module commands

*/ * MODULE>
```

## Related Commands

help (CLI command mode)

help (ICIM command mode)

help (Terminal command mode)

## info alarm

### Syntax

```
info alarm alarmName detail1 detail2 . . . detailn
```

### Description

The **info alarm** command is used to display more detailed alarm information than is returned by using the **show** command.

### Parameters

The **alarmName** parameter specifies the type of alarm. The allowable alarmName values vary by module because different modules have different types of alarms. To learn about possible alarms for each module, do one of the following:

- Use the **modid** command to select a single module (by chassis and slot location), and then issue the command **show alarmstate \*** to list all available alarm names.
- When entering this command, do not use the letter **h** to abbreviate hysteresis, as this will instead invoke the **help** command.
- See *Module Parameter Descriptions* (on page 231) for a list of possible alarms for each module.

The **detail** parameters specify the characteristics that can be requested for each **alarmName**, as follows:

Detail parameter	Description
Hysteresis	Threshold hysteresis value.
Index	Alarm number, starting at 1, in the list of alarms.
Label	Name of the alarm.
Limitadjust	Allowed if alarm is adjustable, not allowed if not.
Majorhigh	High Major threshold.
Majorlow	Low Major threshold.
Minorhigh	High Minor threshold.
Minorlow	Low Minor threshold.
Nominal	Alarm nominal value.
Rangehi	Upper limit for this threshold.
Rangelow	Lower limit for this threshold.



Detail parameter	Description
Type	Alarm type (types 1, 2, and 7 are adjustable).
Value	Alarm state.

## Access Rights Required

Read, ReadWrite, or Admin

## Example

The following sample dialog illustrates the use of the **info alarm** command to view the thresholds of a post-amplifier output power alarm. Note that these thresholds are relative to the nominal alarm value.

```
02/05 MODULE> info alarm outpwr majorhigh minorhigh minorlow majorlow
hysteresis nominal
MODID NAME      MAJORHIGH MINORHIGH MINORLOW MAJORLOW HYSTERESIS NOMINAL
02/05 OutPwr   1          0.5      -0.5    -1       0.1      3
SUCCESS!
02/05 MODULE>
```

## Related Commands

info control

info module

info monitor

show alarmstate

show alarmparam

## info control

### Syntax

```
info control controlName detail1 detail2 . . . detailn
```

### Description

The **info control** command is used to display more detailed control information than is returned by using the **show** command.

### Parameters

The **controlName** parameter specifies the type of control. Different application modules have different types of controls, so the allowable controlName values vary by module type. For a listing of controlName values for a particular module, use the **modid** command to select a single chassis and slot, and then issue the command **show control \*** to list all available control names.

The **detail** parameters specify the characteristics that can be requested for the **controlName**, and are as follows:

Detail parameter	Description
Index	Control number, starting at 1, in the list of controls.
Label	Name of the control.
Rangehi	Upper limit for this control.
Rangelo	Lower limit for this control.
Rangestep	Smallest increment allowed.
Statenames	List of symbolic control values. <b>Note:</b> Not all controls and monitors have statenames.
Type	Control type: D(igital), F(loat), B(olean), S(tate).
Units	Control unit.
Value	Control setting.

### Access Rights Required

Read, ReadWrite, or Admin

## Example

The following sample dialog illustrates the use of the **info control** command to view the **value** and **statenames** characteristics of the **mode** control for all applicable modules installed in chassis 3:

```
03/* MODULE> info control mode value statenames

MODID  NAME      VALUE          STATENAMES
03/02  Mode      Master (1)    (0) Slave, (1) Master
03/06  Mode      Master (1)    (0) Slave, (1) Master
03/11  Mode      Master (1)    (0) Slave, (1) Master
03/16  Mode      Master (1)    (0) Slave, (1) Master

SUCCESS!
03/* MODULE>
```

In the command above, the control name pattern was made explicit; that is, no wildcards were used. The details requested were Value (the current control setting) and the available StateNames. In this example, four of the modules in chassis 3 have a mode control, and the current setting for all four modules is Master (1).

## Related Commands

info alarm

info module

info monitor

show control

## info module

### Syntax

```
info module detail1 detail2 . . . detailn
```

### Description

The **info module** command is used to display more detailed module information than is returned by using the **show** command.

### Parameters

The **detail** parameter specifies the characteristics that can be requested for each **module** in the command scope, and are as follows:

Detail parameter	Description
Activerev	Active software image revision for the module.
Bootrev	Current boot image revision for the module.
CLEI	Reserved for future use.
CLLI	Reserved for future use.
Coderev	Indicates module vintage.
Datecode	Manufacturing date (encoded).
Devtype	Numeric type value used for element manager.
Downldable	Reserved for future use.
Inactiverev	Reserved for future use.
Mandata	Manufacturing data.
Modtype	Manufacturing data (alias for MANDATA).
Name	Name of module.
Nextimage	Image that will be active after the next reboot.
Numanalogcontrols	Number of analog controls.
Numcontrols	Total number of controls.
Numdigitalcontrols	Number of digital controls.
Nummonits	Number of monitored values.
Numofalarms	Number of alarms.
Scriptrev	Script revisions.

Detail parameter	Description
Selftest	Status of module self test.
Serial	Serial number.
Tos	Time of service.

## Access Rights Required

Read, ReadWrite, or Admin

## Example

The example below shows how a network management system might construct an **info module** command to determine the domain of an ICIM2.

```

CLI> module chassis * slot *
CLI> module info module devtype name exit
  MODID  DEVTYPE  NAME
  01/00  5020    XD-Chassis
  01/01  1020    HDTx
  01/02  1020    HDTx
  01/03  1020    HDTx
  01/04  1020    HDTx
  01/05  1032    HDTx
  01/06  1032    HDTx
  01/07  1032    HDTx
  01/08  1032    HDTx
  01/09  2015    P2-HD-RXF
  01/10  2015    P2-HD-RXF
  01/11  2015    P2-HD-RXF
  01/12  2015    P2-HD-RXF
  01/13  2015    P2-HD-RXF
  01/14  2015    P2-HD-RXF
  01/15  2015    P2-HD-RXF
  01/16  2015    P2-HD-RXF
SUCCESS!
CLI> logout

```

## Related Commands

info alarm

info control

info monitor

show module

## info monitor

### Syntax

```
info monitor monitorname detail1 detail2 . . . detailn
```

### Description

The **info monitor** command is used to display more detailed monitor information than is returned by using the **show** command.

### Parameters

The **monitorname** parameter specifies the type of monitored information. Because different applications modules have different types of monitored parameters, the allowable monitorname values vary by module type. For a listing of monitorname values for a particular module, use the **modid** command to select a single chassis and slot, and then issue the command **show monitor \*** to list all available monitor names.

The **detail** parameters specify the characteristics that can be requested for each **monitorname**, and are as follows:

Monitor Name	Description
Index	Monitor number, starting at 1, in the list of monitors.
Label	Name of monitor.
Statenames	List of symbolic values.
Type	Value type: D(igital), F(loat), B(olean), S(tate).
Units	Units of measurement.
Value	Value of monitor.

### Access Rights Required

Read, ReadWrite, or Admin

## Example

The following sample dialog illustrates the use of this command:

```
01/10 MODULE> info monitor inrf index label statenames type units value
MODID  NAME  INDEX LABEL  STATENAMES  TYPE  UNITS  VALUE
01/10  InRF  1      InRF  N/A        F     dB     0.0781822
SUCCESS!
01/10 MODULE>
```

In the example above, the monitor name pattern was made explicit; that is, no wildcards were used. The details to be listed were all possible monitor details for a Transmitter Input RF monitor name.

## Related Commands

info alarm

info control

info module

# logout

## Syntax

logout

## Description

The **logout** command is used to terminate the current CLI session. This command is available in every command mode.

### Important:

- For Telnet operation, the computer you are using must have a network connection through which it can reach the ICIM2 via its IP address.
- No more than four Telnet sessions are allowed at one time.



### CAUTION:

Always use the Logout command to close a serial port or Telnet CLI session. Closing a serial port session without issuing the Logout command leaves the session open for a possible future connection. This may allow unauthorized access by a new user if the previous user had a higher authorization privilege level.

## Parameters

None

## Access Rights Required

Read, ReadWrite, or Admin

## Example

```
*/ * MODULE> logout
connection to host lost
C:\>
```

## Related Commands

exit



# manual

## Syntax

manual

## Description

The **manual** command is used to display detailed help for Module command mode, or for another command mode if specified while another mode is active.

## Parameters

None

## Access Rights Required

Read, ReadWrite, or Admin

## Example

```
20/08 MODULE> manual
```

Try one of these help commands for details on specific modes:

```
module manual
terminal manual
icim manual
```

General Hints:

Keywords can be abbreviated to a unique prefix. For instance in CLI mode, the keyword 'MODULE' can be given as just 'mo' or 'mod'.

Use TAB to autocomplete a keyword.  
Use ? to list expected keywords or tokens (depends on previous input).  
Use BACKSPACE to erase previous characters.  
Use 'help edit' to display more editing commands

Use Alarm in any mode to get a list of active alarms. When in Module mode, you can also narrow the list of active alarms to just those in the current ModSpec range. See the Module Help for further details.

Note: entering a mode command (MODULE, ICIM, TERMINAL) enters that mode immediately but it is not indicated until the next prompt is displayed.

The interface uses modes: CLI, MODULE, TERMINAL, and ICIM. The prompt reflects the current mode. Enter the mode name to enter that mode, and use EXIT to leave the mode and return to CLI mode.

To enter MODULE mode, just enter MODULE, any ModSpecs and newline.

Once in MODULE mode, the prompt will be of the form:

```
X/Y MODULE>
```

where X is the chassis specification, and Y is the slot spec. Changes to the ModSpecs are retained across commands.

## Chapter 4 Module Mode Commands

Use `Exit` to leave Module mode, or `Logout` to exit the CLI interface

All keywords and parameters are caseless. That is, `MoDuLe == MODULE == module`

Module Commands:

`alarm [parameters]`

Use the 'alarm' command to show all the current alarms. This command works in all modes. Using the optional parameter 'domain' is the same as not using any parameter. However, using the optional parameter 'module' will display only the alarms for the currently selected module.

`chassis <chassis_range> [slot [slot_range]]`

Use the 'chassis' command to specify the desired chassis number. The <chassis\_range> parameter can be either a specific chassis number between 0 and 99, or it can be '\*' to indicate the wildcard chassis selection, or it can be a range of chassis numbers. Specify a range of chassis in the form '[DIGITS - DIGITS]' such as '[5 - 15]'. The 'chassis' command can be optionally followed by the slot command on the same input line.

`exit`

Use the 'exit' command to return to CLI mode. This command must be used before entering ICIM or TERMINAL mode.

`info <parameter> <subparameters>`

Use the 'info' command to display one or more module parameter values. Any number of available parameters can be requested with the same command. The <parameter> field can be either alarm, control, monitor or module. Each has a different set of <subparameters>. Following are examples:

`X/Y MODULE> info alarm <name> <alarm_param>`

where <name> is the actual alarm name such as Enable. Wildcards are allowed. For example, `LasTemp*` will select `LasTempA` and `LasTempB`. The following values are allowed for `alarm_param`:

- `hysteresis` - The alarm threshold hysteresis value
- `index` - The alarm number, starting at 1, in the list of alarms
- `label` - The name of the alarm
- `limitadjust` - Specifies whether the alarm has adjustable threshold values
- `majorhigh` - The high critical alarm threshold value; must be less than or equal to the upper limit for this alarm
- `majorlow` - The low critical alarm threshold value; must be greater than or equal to the lower limit for this alarm
- `minorhigh` - The high non-critical alarm threshold value
- `minorlow` - The low non-critical alarm threshold value
- `nominal` - The alarm nominal value
- `rangehi` - The upper limit for this alarm threshold
- `rangelo` - The lower limit for this alarm threshold
- `type` - The alarm type (1, 2 & 7 are adjustable)
- `value` - The current alarm state

`X/Y MODULE> info control <name> <control_param>`

where <name> is the actual control name such as Enable. Wildcards are allowed. For example, `Service*` will select `ServiceA` and `ServiceB`. The following values are allowed for `control_param`:

- `index` - The control number, starting at 1, in the list of controls
- `label` - The name of the control
- `rangehi` - The upper limit for this control
- `rangelo` - The lower limit for this control
- `rangestep` - The smallest increment allowed for the control
- `statenames` - The list of symbolic control values
- `type` - The control type: D(igital), F(loat), B(olean), S(tate)
- `units` - The units for the control
- `value` - The current control setting

X/Y MODULE> info monitor <name> <monitor\_param>  
 where <name> is the actual monitor name such as Enable. Wildcards are allowed. For example, LasTemp\* will select LasTempA and LasTempB. The following values are allowed for monitor\_param:

index	- The monitor number, starting at 1, in the list of monitors
label	- The name of the monitor
statenames	- The list of symbolic values
type	- The value type: D(igital), F(loat), B(olean), S(tate)
units	- The units of measurement for the monitor
value	- The current value of the monitor

X/Y MODULE> info module <module\_param>  
 where <module\_param> is one of the following:

activerev	- The active software revision
bootrev	- The current boot image revision
clei	- The Current Language Equipment ID code
clli	- The Current Language Locator ID code
coderev	- The code revision
datecode	- The [encoded] manufacturing date
devtype	- The numeric type value used for element managers
downloadable	- Whether a module can be downloaded with new firmware
inactiverev	- The inactive software image revision
mandata	- The [encoded] manufacturing data
modtype	- The manufacturing data (same as mandata)
name	- The module name
nextimage	- The flash bank where the active image resides
numanalogcontrols	- The number of analog controls
numcontrols	- The total number of controls
numdigitalcontrols	- The number of digital controls
nummonits	- The number of monitored values
numofalarms	- The number of alarms
scriptrev	- The script revision(s)
selftest	- The status of the module's self test
serial	- The serial number
tos	- The time of service

#### logout

Use the 'logout' command to logout of the CLI session. If the session is a telnet session, it will be closed. If the session is the local console port, the login prompt will be given.

#### manual

Use the 'manual' command to display this help.

#### modid <mod\_range>

Use the 'modid' command to specify the ModSpec of the desired module(s). With this command, the user can specify the chassis and the slot selection with a single command. The <mod\_range> parameter can take one of three forms. It can be a specific chassis and slot combination such as 0212, where 02 is the chassis number and 12 is the slot number. It can be a '\*' to indicate the wildcard modspec selections. Or it can be a range of chassis and slots, such as '[1-13]/[4-6]'.

#### reset

Use the 'reset' command to set all the controls and alarms on a module to the factory defaults. A dialog is presented to confirm this potentially dangerous action and it can be executed only by an Adminuser. This command is only supported on the new CCB3 modules and cannot be executed unless only a single module is specified in the modspec.

#### set <parameters> <subparameters>

Use the 'set' command to set values on the module. There are three types of parameters available for setting:

alarmparam	- An alarm parameter such as a threshold value
control	- A control value
module	- A module parameter, currently only the CLLI

The subparameters vary based on the parameter specified. Here are some examples of each type.

## Chapter 4 Module Mode Commands

```
X/Y MODULE> set alarmparam <name> <alarm_param> <value>
  where <name> is the name of the alarm and <alarm_param> is one of the
  following values:
  hysteresis           - The alarm threshold hysteresis value
  majorhigh            - The high critical alarm threshold value; must be
                        less than or equal to the upper limit for this
                        alarm
  majorlow             - The low critical alarm threshold value; must be
                        greater than or equal to the lower limit for this
                        alarm
  minorhigh            - The high non-critical alarm threshold value
  minorlow             - The low non-critical alarm threshold value
  and <value> is the new value to set.

X/Y MODULE> set control <name> <value>
  where <name> is the name of the control and <value> is the new value.

X/Y MODULE> set module cli <location>
  where <location> is the new CLI code string.

show <type> [<name> <parameter>]
  Use the 'show' command to display one or more module parameter values.
  Any number of available parameters can be requested with the same command.
  The <name> field can be either alarmparam, alarmstate, control, monitor or
  module. Following are examples:

X/Y MODULE> show alarmparam <name> <alarm_param>
  where <name> is the name of the alarm and <alarm_param> is the parameter
  of interest (hysteresis, majorhigh, minorhigh, majorlow, minorlow).

X/Y MODULE> show alarmstate <name>
  where <name> is the name of the alarm.

X/Y MODULE> show control <name>
  where <name> is the name of the control.

X/Y MODULE> show monitor <name>
  where <name> is the name of the monitor.

X/Y MODULE> show module
  This command will show the ModID, ModType, Name and Serial Number
  for this module.

slot <slot_range>
  Use the 'slot' command to specify the desired slot number.
  The <slot_range> parameter can be either a specific slot number
  between 0 and 47, or it can be '*' to indicate the wildcard slot
  selection, or it can be a range of slot numbers. Specify a range of
  slots in the form '[DIGITS - DIGITS]' such as '[5 - 12]'.

20/08 MODULE>
```

## Related Commands

- manual (CLI command mode)
- manual (ICIM command mode)
- manual (Terminal command mode)
- help

# modid

## Syntax

```
modid modIdValue
```

## Description

The **modid** command is used to specify a chassis and slot location using a single **modidValue** parameter.

## Parameters

The **modidValue** parameter can take any of these forms:

- A 4-digit number signifying a single chassis and slot location, such as 0512 for chassis 5, slot 12.
- Bracketed numbers separated by a / symbol, representing a range of chassis and slot locations, such as [1-5]/[4-13] for chassis 1 through 5, slots 4 through 13.
- A wildcard character (\*), indicating all chassis and slot locations within the ICIM2 domain.

## Access Rights Required

Read, ReadWrite, or Admin

## Example

The following sample dialog illustrates each of the **modid** entry formats described above.

```
[10-34]/01 MODULE> modid [1-5]/[4-13] (selects chassis 1-5, slots 4-13)
[01-05]/[04-13] MODULE> modid 0512 (selects chassis 5, slot 12)
05/12 MODULE> modid * (selects all chassis and slots)
*/* MODULE>
```

### Notes on Usage

- It may be faster to enter the **modid** command than to enter than separate **chassis** and **slot** commands, but the resulting dialog may be more difficult for a human operator to understand.

- Modspecs stay in effect when exiting and re-entering Module command mode. However, modspecs do not affect the scope of CLI, ICIM, or Terminal mode commands.
- When specifying a range of chassis or slots, the specified range need not be fully populated. For example, the chassis range [1-7] is valid even if there are fewer than seven chassis within that range. In addition, all chassis within the specified range are included whether or not their chassis numbers are contiguous.
- For an element management system or other automatic control interface, a specific chassis and slot are required for backward compatibility, and should always be specified.
- For craft operators, ranges may be specified for all Module mode commands except for **set**.

### Related Commands

chassis

slot

# reset

## Syntax

```
reset
```

## Description

The **reset** command is used to set all controls and alarms in a specified module to their factory defaults.

Because this action has potentially severe consequences, this command can only be executed by an Admin user as explained in *User Authorization* (on page 7), and then only for a specific chassis and module. It is not possible to reset a range of modules, a chassis, or a range of chassis using a single reset command. When you enter a **reset** command, a dialog is presented for confirmation. You must confirm your intention by typing **yes** (typing **Y** alone is not sufficient).

**Note:** In the factory default state, some modules have their outputs disabled. Thus, resetting modules may result in loss of output signal.

## Parameters

None

## Access Rights Required

Admin

## Example

```
*/ * MODULE> modid 0105
```

```
01/05 MODULE> reset
```

```
The module control & alarm settings are about to be reset to factory defaults.
Module outputs may become disabled as a result. Are you sure you want to
proceed (Yes/No)? yes
```

```
The module has been reset to factory defaults. Please allow several
minutes for module rediscovery by the ICIM2 and then re-enable module
outputs as desired.
```

```
SUCCESS!
```

```
01/05 MODULE>
```

## Related Commands

set control

set alarmparam



# set alarmparam

## Syntax

```
set alarmparam alarmName alarmParamName alarmParamValue
```

## Description

The **set alarmparam** command can be used to change the values of certain types of alarm parameters. The **set alarmparam** command is typically used in conjunction with the **info** command to first learn about alarm type and status, and then change the alarm status where appropriate and allowed.

### Alarm Types

Alarms are classified by type to characterize their overall behavior. The table below summarizes the possible types of alarms in terms of class (Boolean vs. Non-Boolean), impact (User vs. Module), and threshold implementation (Relative vs. Absolute).

Alarm Type	Class	Impact	Threshold
1 *	Non-Boolean	User	Relative
2 *	Non-Boolean	User	Absolute
3	Non-Boolean	Module	Relative
4	Non-Boolean	Module	Absolute
5	Boolean	User	na
6	Boolean	Module	na
7 *	Non-Boolean	User	Absolute
8	Non-Boolean	Module	Absolute

\* Only these alarms may be changed by a user.

Boolean alarms (Types 5 and 6) can have either of two states, **OK** or **Fault**. Non-Boolean alarms (Types 1, 2, 3, 4, 7, and 8) can have one of five states:

- **OK** - no alarm condition exists
- **majorlow** - low threshold setting for a Major alarm exceeded
- **minorlow** - low threshold setting for a Minor alarm exceeded
- **minorhigh** - high threshold setting for a Minor alarm exceeded
- **majorhigh** - high threshold setting for a Major alarm exceeded

Non-Boolean alarms also have a hysteresis setting that can be used to adjust the amount of change required to switch states. For possible hysteresis values, see *Module Parameter Descriptions* (on page 231). For additional information, see the **SNMP Management** section of the *Prisma II™ XD Platform System Guide*, part number 4021339.

With regard to the **set alarmparam** command, alarm types 1, 2, and 7 in the table above are the only types with thresholds that may be changed by a user. These alarms also share in common that they will not cause a module to shut down. Any attempt to use **set alarmparam** to change the parameter of an alarm not of type 1, 2, or 7 will result in an error message.

## Parameters

The possible values for **alarmName**, **alarmParamName**, and **alarmParamValue** depend on the object (chassis or application module) in question. The table below identifies alarm parameters for the XD chassis; for possible parameter values, see *Module Parameter Descriptions* (on page 231). Application module alarm parameters are provided in the module documentation. See *Related Publications* (on page 3) for a list of available documents.

**Note:** When selecting parameters for this command, one or more wildcard characters (\*) may be used to specify a range of matching responses.

### XD Chassis (devtype: 5020)

<b>alarmName</b>	<b>Description</b>
Fan1_Ok	Fan 1 operating status.
Fan2_Ok	Fan 2 operating status.
Fan3_Ok	Fan 3 operating status.
ChasTemp	Chassis fan tray temperature.
ConvAIn	DC-to-DC Converter A input power status.
ConvA+24	DC-to-DC Converter A +24 V output power status.
ConvA+5	DC-to-DC Converter A +5 V output power status.
ConvA-5	DC-to-DC Converter A -5 V output power status.
ConvBIn	DC-to-DC Converter B input power status.
ConvB+24	DC-to-DC Converter B +24 V output power status.
ConvB+5	DC-to-DC Converter B +5 V output power status.
ConvB-5	DC-to-DC Converter B -5 V output power status.

## Access Rights Required

ReadWrite or Admin

## Examples

The following sample dialog shows the **info** command can be used to first learn about all (\*) alarms in Module 2006 (the module in chassis 20, slot 06), a high-density transmitter:

```
20/06 MODULE> info alarm * type majorlow minorlow majorhigh minorhigh

MODID  NAME      TYPE  MAJORLOW  MINORLOW  MAJORHIGH  MINORHIGH
20/06  LasTemp   3     -15      -5         15         5
20/06  LasBias   3     -20      -10        20         10
20/06  InRF      1     1000     -5         N/A        N/A
20/06  Enable    6     N/A      N/A        N/A        N/A
20/06  OutPwr    1     -1       -0.5       1          0.5
20/06  PsOk      6     N/A      N/A        N/A        N/A

SUCCESS!
20/06 MODULE>
```

This response shows that the LasTemp, LasBias, InRF, and OutPwr alarms have majorlow and minorlow parameters. However, because LasTemp and LasBias are of type 3 rather than 1, 2, or 7, their values cannot be changed.

The following sample dialog shows how a craft operator would set the **majorhigh** parameter of **outpwr** to 2, and then confirm the change.

```
20/06 MODULE> set alarmparam outpwr majorhigh 2

SUCCESS!
20/06 MODULE> info alarm * type majorhigh

MODID  NAME      TYPE  MAJORHIGH
20/06  LasTemp   3     15
20/06  LasBias   3     20
20/06  InRF      1     N/A
20/06  Enable    6     N/A
20/06  OutPwr    1     2
20/06  PsOk      6     N/A

SUCCESS!
20/06 MODULE>
```

## Related Commands

info alarm

show alarmparam

## set control

### Syntax

```
set control controlName controlValue
```

### Description

The **set control** command is followed by two additional arguments: **controlName** identifies the control parameter, and **controlValue** specifies the value to be assigned.

**Important:** To avoid possible system disruption, broadcast **set** commands are not supported. This means that the **set control** command can only be applied to one module (chassis and slot number) at a time. If a specific chassis and slot number are not specified in advance, the CLI interpreter will disallow the command. In addition, the name of the control to be changed must be explicit; no wildcard characters are permitted.

#### Control Types

Control parameters are classified as type F (floating-point) or type S (state) to characterize the types of variables they control. In general:

- Type F controls are numeric values that can vary between maximum and minimum thresholds. The adjustment increments are set by separate hysteresis values for each control.
- Type S controls are state variables that have a limited range of discrete values such as On or Off, Master or Slave, Auto or Manual, and so on. The set of possible values is defined as appropriate for each control.

### Parameters

The possible values for **controlName** and **controlValue** depend on the object (chassis or application module) in question. The table below identifies controls and possible values for the chassis. Application module controls and possible values are provided in the module documentation. See *Related Publications* (on page 3) for a list of available documents.

**Note:** When selecting control parameters for this command, one or more wildcard characters (\*) may be used to specify a range of matching responses.

### Access Rights Required

ReadWrite or Admin

## Example

The following example shows how a craft operator might use **set control** to disable the module in slot 5 of chassis 20, and then use **show control** to confirm the change.

```
*/05 MODULE> module chassis 20
20/05 MODULE> set control enable 0
SUCCESS!
20/05 MODULE> show control enable
  MODID      NAME      SETTINGS  UNITS
  20/05      Enable    0
SUCCESS!
20/05 MODULE>
```

The following example shows what would happen if the operator had not specified the chassis number in advance:

```
*/05 MODULE> set control enable 0
Error: This command can only be used at an explicit chassis and slot prompt
Set the chassis and slot to specific values before using this command
*/05 MODULE>
```

## Related Commands

show control

## set module

This command is reserved for future use.

# show alarmparam

## Syntax

```
show alarmparam alarmName alarmParamName
```

## Description

The **show alarmparam** command is used to select a particular alarm (**alarmName**) and display the value of a specified parameter for that alarm (**alarmParamName**).

Alarm parameters are settings that control when an alarm occurs, its severity, and the size of the steps used to adjust alarm threshold settings.

## Parameters

The **alarmParamName** parameter can have any of the following values:

<b>alarmParamName</b>	<b>Description</b>
hysteresis	Smallest unit of adjustment for alarm threshold.
majorhigh	High threshold setting for a Major alarm.
majorlow	Low threshold setting for a Major alarm.
minorhigh	High threshold setting for a Minor alarm.
minorlow	Low threshold setting for a Minor alarm.

The possible values for **alarmName** depend on the object (chassis or application module) in question. For possible parameter values, see *Module Parameter Descriptions* (on page 231). Application module alarm parameters are provided in the module documentation. See *Related Publications* (on page 3) for a list of available documents.

**Note:** When selecting parameters for this command, one or more wildcard characters (\*) may be used to specify a range of matching responses.

## Access Rights Required

Read, ReadWrite, or Admin

## Example

The following example shows the kind of information returned by this command.

```
*/ * MODULE> show alarmparam *pwr minorhigh
```

MODID	NAME	MINORHIGH
01/01	OutPwr	0.5
01/15	OutPwr	0.5
02/03	InPwr	2
02/03	RFPwr	10
02/12	InPwr	2
02/12	RFPwr	10
98/04	OutPwr	0.5
98/05	OutPwr	0.5
98/09	OutPwr	0.5
98/10	OutPwr	0.5
98/11	OutPwr	0.5
98/13	OutPwr	0.5
98/14	OutPwr	0.5
98/15	OutPwr	0.5

```
SUCCESS!
```

```
*/ * MODULE>
```

### Notes:

- A returned value of N/A for any alarm indicates that the alarm does not have the requested parameter.
- Some alarm values can also be changed by a properly authorized craft operator or element management system. See *set alarmparam* (on page 65) for details.

## Related Commands

show control

show module

show monitor

show alarmstate

set alarmparam



# show alarmstate

## Syntax

```
show alarmstate alarmName
```

## Description

The **show alarmstate** command is used to display the specified states of specified active alarms. The **alarmName** parameter identifies the alarm or alarms to be displayed.

## Parameters

The possible values for **alarmName** depends on the object (chassis or application module) in question. The table below identifies the alarm parameters for the chassis; for possible parameter values, see Module Parameter *Descriptions* (on page 231). Application module alarm parameters are provided in the module documentation. See *Related Publications* (on page 3) for a list of available documents.

### Note:

- When selecting parameters for this command, one or more wildcard characters (\*) may be used to specify a range of matching responses.
- For information on the alarm types listed below, see *show alarmparam* (on page 71).

### XD Chassis (devtype: 5020)

alarmName	Description
Fan1_Ok	Fan 1 operating status.
Fan2_Ok	Fan 2 operating status.
Fan3_Ok	Fan 3 operating status.
ChasTemp	Chassis fan tray temperature.
ConvAIn	DC-to-DC Converter A input power status.
ConvA+24	DC-to-DC Converter A +24 V output power status.
ConvA+5	DC-to-DC Converter A +5 V output power status.
ConvA-5	DC-to-DC Converter A -5 V output power status.
ConvBIn	DC-to-DC Converter B input power status.
ConvB+24	DC-to-DC Converter B +24 V output power status.

alarmName	Description
ConvB+5	DC-to-DC Converter B +5 V output power status.
ConvB-5	DC-to-DC Converter B -5 V output power status.

## Access Rights Required

Read, ReadWrite, or Admin

## Example

The following example shows the kinds of information returned by this command.

```
*/ * MODULE> show alarmstate *pwr
```

```

MODID  NAME      STATE
01/01  OutPwr    2 (ok)
01/15  OutPwr    2 (ok)
02/03  InPwr     2 (ok)
02/03  RFPwr     2 (ok)
02/12  InPwr     2 (ok)
02/12  RFPwr     2 (ok)
98/04  OutPwr    2 (ok)
98/05  OutPwr    2 (ok)
98/09  OutPwr    2 (ok)
98/10  OutPwr    2 (ok)
98/11  OutPwr    2 (ok)
98/13  OutPwr    2 (ok)
98/14  OutPwr    2 (ok)
98/15  OutPwr    2 (ok)

```

```

SUCCESS!
*/ * MODULE>

```

**Note:** The information returned by the **show alarmstate** command includes both the state value and how to interpret it.

## Related Commands

show control

show module

show monitor

show alarmparam

# show control

## Syntax

```
show control controlName
```

## Description

The **show control** command is used to display the values of all control parameters in the range indicated by **controlName**.

### Control Types

Control parameters are classified as type F (floating-point) or type S (state) to characterize the types of variables they control. In general:

- Type F controls are numeric values that can vary between maximum and minimum thresholds. The adjustment increments are set by separate hysteresis values for each control.
- Type S controls are state variables that have a limited range of discrete values such as On or Off, Master or Slave, Auto or Manual, and so on. The set of possible values is defined as appropriate for each control.

## Parameters

The values possible for **controlName** depend on the object (chassis or application module) in question. For example, the table below identifies the controls for the XD chassis along with their types and possible values. Application module controls and possible values are provided in the module documentation. See *Related Publications* (on page 3) for a list of available documents.

**Note:** When selecting control parameters for this command, one or more wildcard characters (\*) may be used to specify a range of matching responses.

### XD Chassis (devtype: 5020)

Control	Description	Type	Possible Values
AlmMuteA	Mutes AC-to-DC bulk power supply and DC-to-DC converter alarms for power section A.	S	On (1), Off (0)
AlmMuteB	Mutes AC-to-DC bulk power supply and DC-to-DC converter alarms for power section B.	S	On (1), Off (0)

## Access Rights Required

Read, ReadWrite, or Admin

## Examples

```
*/ * MODULE> show control enable

MODID  NAME      SETTING  UNITS
01/01  Enable    1
01/15  Enable    1
98/04  Enable    1
98/05  Enable    1
98/09  Enable    1
98/10  Enable    1
98/11  Enable    1
98/13  Enable    1
98/14  Enable    1
98/15  Enable    1
```

SUCCESS!

```
*/ * MODULE> show control alm*

MODID  NAME      SETTING  UNITS
01/00  AlmMuteA  Off (0)
01/00  AlmMuteB  Off (0)
02/00  AlmMuteA  Off (0)
02/00  AlmMuteB  Off (0)
03/00  AlmMuteA  Off (0)
03/00  AlmMuteB  Off (0)
98/00  AlmMuteA  Off (0)
98/00  AlmMuteB  Off (0)
```

SUCCESS!

```
*/ * MODULE>
```

## Related Commands

show module

show monitor

show alarmstate

show alarmparam

# show module

## Syntax

```
show module
```

## Description

The **show module** command is used to generate a list of information for specific modules to help with their physical identification. Modules are specified by first changing to the desired Module prompt (modspec), and then entering the **show module** command.

## Parameters

None; however, the modspec is used to specify the scope of the command within the ICIM2 domain. See *About Modspecs* (on page 37) for further information.

## Access Rights Required

Read, ReadWrite, or Admin

## Examples

The following example shows how a craft operator might display information for the modules in slots 3, 4, and 5 of all chassis in the ICIM2 domain.

```

*/ * MODULE> slot [3-5]
SUCCESS!
*/ [03-05] MODULE> show module

  MODID  MODTYPE                NAME          SERIAL
  01/03   3 dBm TXTS 1310 nm        HDTx         MMAAFEFJ
  01/04   3 dBm TXTS 1310 nm        HDTx         MMAAFEFK
  01/05   3 dBm TXTS 1310 nm        HDTx         MMAAFEBV
  02/03   3 dBm TXTS 1310 nm        HDTx         NNAAAF CJ
  02/04   3 dBm TXTS 1310 nm        HDTx         NNAAAF BY
  02/05   3 dBm TXTS 1310 nm        HDTx         NNAAAF BX
  98/05   3 dBm TXTS 1310 nm        HDTx         NNAAAF BZ

SUCCESS!
*/ [03-05] MODULE>

```

## Related Commands

show control

show monitor

show alarmstate

show alarmparam

# show monitor

## Syntax

```
show monitor monitorName
```

## Description

The **show monitor** command is used to display the values of all active alarms in the range indicated by **monitorName**.

### Monitored Parameter Types

Monitored parameters are classified as type F (floating-point) or type S (state) to characterize the types of variables they monitor. In general:

- Type F parameters monitor numeric values that can vary between maximum and minimum thresholds. The adjustment increments are set by separate hysteresis values for each parameter.
- Type S parameters monitor state variables that have a limited range of discrete values such as On or Off, Master or Slave, Auto or Manual, and so on. The set of possible values is defined as appropriate for each parameter.

## Parameters

The possible values for **monitorName** depend on the object (chassis or application module) in question. *Module Parameter Descriptions* (on page 231) lists the monitor parameters for the chassis along with their types and possible values. Application module monitors and possible values are provided in the module documentation. See *Related Publications* (on page 3) for a list of available documents.

**Note:** When selecting parameters for this command, one or more wildcard characters (\*) may be used to specify a range of matching responses.

## Access Rights Required

Read, ReadWrite, or Admin

## Example

The following sample dialog shows how the kind of information returned by this command.

```
*/ * MODULE> show monitor *pwr

MODID  NAME      VALUE      UNITS
01/01  OutPwr    3.1        dBm
01/15  OutPwr    9.9512     dBm
02/03  InPwr     -0.232192  dBm
02/03  RFPwr     -6.4044    dBm
02/12  InPwr     -1.41318   dBm
02/12  RFPwr     -3.79324   dBm
98/04  OutPwr    3.2        dBm
98/05  OutPwr    3.2        dBm
98/09  OutPwr    3.12       dBm
98/10  OutPwr    3.5        dBm
98/11  OutPwr    3.25       dBm
98/13  OutPwr    3.1        dBm
98/14  OutPwr    3.4        dBm
98/15  OutPwr    3.2        dBm

SUCCESS!
*/ * MODULE>
```

**Note:** The information returned by the **show monitor** command includes units of measurement.

## Related Commands

show control

show module

show alarmstate

show alarmparam



# slot

## Syntax

slot slotidValue

## Description

The **slot** command is used to specify:

- A single slot, using the desired slot number (0-16).
- A range of slots, using two slot numbers in brackets, e.g., [2-16].
- All slots in all chassis currently specified, using the wildcard character (\*) in place of a slot number.

## Parameters

The **slotidValue** parameter can be any number from 0 to 16, or a bracketed pair of numbers in this range separated by a hyphen (-).

**Note:** If an HDRx chassis is monitored by a daisy-chain to a Prisma II XD chassis, the HDRx chassis has slots 1-47.

## Access Rights Required

Read, ReadWrite, or Admin

## Example

The following sample dialog illustrates the use of all three methods described above.

```
10/* MODULE> slot [2-16]      (selects chassis 10, slots 2-16)
10/[02-16] MODULE> slot 15    (selects chassis 10, slot 15)
10/15 MODULE> slot *          (selects chassis 10, all slots)
10/* MODULE>
```

### Notes on Usage

- The **slot** command can be used together with the **chassis** command to specify a particular chassis and slot location. However, it is often simpler to use the **modid** command for this purpose. See *modid* (on page 61) for details.
- Modspecs stay in effect when exiting and re-entering Module command mode. However, modspecs do not affect the scope of CLI, ICIM, or Terminal mode commands.

## Chapter 4 Module Mode Commands

- When specifying a range of chassis or slots, the specified range need not be fully populated. For example, the chassis range [1-7] is valid even if there are fewer than seven chassis within that range. In addition, all chassis within the specified range are included whether or not their chassis numbers are contiguous.
- For an element management system or other automatic control interface, a specific chassis and slot are required for backward compatibility, and should always be specified.
- For craft operators, ranges may be specified for all Module mode commands except for **set**.

### Related Commands

chassis

modid

# 5

---

## ICIM Mode Commands

### Introduction

This chapter describes the commands that can be executed in the ICIM command mode. These commands enable monitoring and control of the ICIM2 module itself as well as general parameters of the ICIM2 domain.

## In This Chapter

■ Overview.....	85
■ alarm.....	87
■ eventlogclear.....	88
■ eventlogfilter.....	89
■ exit.....	91
■ file.....	92
■ help .....	94
■ ike.....	96
■ info .....	97
■ iproute .....	100
■ ipsec .....	102
■ logout.....	103
■ manual.....	104
■ reboot.....	109
■ set .....	110
■ set clock .....	112
■ show.....	114
■ show clock.....	117
■ show domain .....	118
■ show eventlog .....	120
■ show eventlogall .....	121
■ show eventlogfilter .....	122
■ show file .....	123
■ show ike .....	124
■ show iproute.....	125
■ show provisioning .....	126
■ show sntp.....	128
■ show traps.....	129
■ show user .....	130
■ sntp .....	131
■ traps .....	132
■ user add.....	133
■ user change .....	135
■ user delete .....	137
■ user unlock.....	138

## Overview

ICIM mode commands provide for monitoring and control of the ICIM2 itself and for all modules in its domain.

### Types of ICIM Commands

The following commands are recognized in ICIM command mode:

- The **alarm** command is used to display all active alarms in the ICIM2 domain.
- The **eventlogclear** command is used to clear the ICIM2 event log.
- The **eventlogfilter** command is used to change the event log filter settings.
- The **exit** command is used to exit ICIM command mode and return to CLI command mode.
- The **file** command is used to set the parameters needed to transfer the event log file from the ICIM2 to a remote FTP server.
- The **help** command is used to display abbreviated help for ICIM mode commands.
- The **ike** command is reserved for future use.
- The **info** command is used to request a listing of ICIM2 parameter values.
- The **iproute** command is used to change the current IP routing table.
- The **ipsec** command is reserved for future use.
- The **logout** command is used to exit CLI and return to the system prompt.
- The **manual** command is used to display detailed help for ICIM mode commands.
- The **reboot** command is used to reset the ICIM2 and allow any new settings to take effect.
- The **set** commands are used to assign values to ICIM2 alarm or control parameters, and to set the system clock.
- The **show** commands are used to display information about the ICIM2 domain, review configuration, event log, and trap settings, and access the system clock.
- The **sntp** commands are reserved for future use.
- The **traps** command is used to enable or disable selected traps within the ICIM2 domain.
- The **user** commands are used to add, change, and delete system user information and to unlock user accounts.

This chapter describes each of these commands and its applications in detail.

## To Access ICIM Command Mode

The CLI only recognizes ICIM mode commands in ICIM command mode.

Complete the following steps to enter ICIM command mode.

- 1 Confirm that you have logged onto CLI as explained in *CLI Login and Logout* (on page 8).
- 2 At the CLI> prompt, type **icim**, and then press **Enter**.
- 3 Confirm that the command prompt changes to ICIM>. You are now in ICIM command mode.

# alarm

## Syntax

alarm

## Description

The **alarm** command is used to display all active alarms in the domain of the ICIM2. This command produces the same results whether entered in CLI, Module, Terminal, or ICIM command mode.

**Note:** This command is functionally equivalent to *alarm domain* (on page 41).

## Parameters

None

## Access Rights Required

Read, ReadWrite, or Admin

## Example

```
ICIM> alarm
  No active alarms found
ICIM>
```

This response shows that no alarms are active in the ICIM2 domain. To narrow the command scope to specific chassis or modules, use *alarm module* (on page 42).

## Related commands

- alarm (CLI command mode)
- alarm (Module command mode)
- alarm (Terminal command mode)
- alarm domain (Module command mode)
- alarm module (Module command mode)
- show alarmparam (Module command mode)
- show alarmstate (Module command mode)

## eventlogclear

### Syntax

```
eventlogclear
```

### Description

The **eventlogclear** command is used to erase the entire contents of the event log. The user is prompted for confirmation before action is taken.

It is recommended that the event log be cleared after it has been copied (transferred) to a remote FTP server. See *file* (on page 92) for details.

**Note:** This command performs the same function as the Clear Event Log button in the Web Interface Event Log screen. It is also functionally equivalent to setting ICIM MIB object p2icimFileMgmtCmd to clearEventLog (2) and then setting p2icimFileMgmtAction to execute (2) via SNMP.

### Parameters

None

### Access Rights Required

Admin

### Examples

```
ICIM> eventlogclear
You are about to remove 210 entries from the system log.
Are you sure you want to proceed (Yes/No)? yes
SUCCESS!
ICIM>
```

### Related Commands

```
eventlogfilter
show eventlog
show eventlogall
show eventlogfilter
```



# eventlogfilter

## Syntax

```
eventlogfilter logCategory setting
```

## Description

The **eventlogfilter** command is used to set the event log filter parameters, which select the categories of events that are saved in the ICIM2 event log.

## Parameters

The **logCategory** parameter selects the event category to be changed. It can have one of the following values.

<b>logCategory</b>	<b>Description</b>
hardware	Designates hardware events, i.e., module insertion and removal events.
provisioning	Designates events related to configuring modules, such as changing alarm thresholds, hysteresis, and control parameters.
system	Designates events related to system activities, such as downloads, reboots, formatting, or clearing the event log.

The **setting** parameter is either **on** to save events of that type in the log, or **off** not to log these events.

## Access Rights Required

Admin

## Examples

```
ICIM> eventlogfilter system on
SUCCESS!
ICIM>
```

## Related Commands

eventlogclear

show eventlog

show eventlogall

show eventlogfilter

# exit

## Syntax

exit

## Description

The **exit** command is used to exit ICIM command mode to the CLI command mode for the purpose of entering CLI mode commands or selecting Module or Terminal command mode.

**Note:** The exit command is not recognized in CLI mode and does not result in a logout. See *logout* (on page 103) for details.

## Parameters

None

## Access Rights Required

Read, ReadWrite, and Admin

## Examples

```
ICIM> exit
CLI> terminal
TERMINAL> exit
CLI> module
*/* MODULE> exit
CLI> icim
ICIM>
```

## Related Commands

logout

## file

### Syntax

```
file fileParameter value
```

### Description

The **file** command is used to set the file management parameters used for FTP transfers of the event log file from the ICIM2 to a remote FTP server.

**Note:** This command is functionally equivalent to the subset of ICIM MIB objects used for file management, as further explained in the **SNMP Management** chapter of the *Prisma II™ XD Platform System Guide*, part number 4021339.

### Parameters

The **fileParameter** parameter can have one of the values listed below.

fileParameter	Description
ip	The destination IP address of the remote FTP server.
name	The destination file name and extension, e.g., event0418.log.
password	The password for the destination remote FTP server.
path	The complete destination path for the file, minus the file name.
user	The username for the destination remote FTP server.

The **value** parameter specifies the value assigned to fileParameter. The format restrictions for this value are listed below.

value	Restrictions
ip (ip address)	Must be of the form 172.24.28.151.
name (file name)	31 characters maximum; must include file name and extension.
password (for FTP)	31 characters maximum; must include at least one letter and at least one number.
path (destination)	Case-sensitive for Solaris, with elements separated by backslash (\).
user (for FTP)	31 characters maximum, and must include at least one letter and at least one number.

### Access Rights Required

ReadWrite or Admin

## Examples

```
ICIM> file ip 192.28.46.118
SUCCESS!
ICIM> file name eventlog.txt
SUCCESS!
ICIM> file user ftp_user
SUCCESS!
ICIM> file password ftp_pw
SUCCESS!
ICIM> file path ftproot
SUCCESS!
ICIM>
```

## Related Commands

show file

# help

## Syntax

```
help modeOption
```

## Description

The **help** command is used alone to display onscreen help for all ICIM mode commands, or with a **modeOption** parameter to display help for a single command or function.

**Note:** Typing a question mark (?) character at the ICIM> command prompt gives the same result as typing help without a mode option parameter.

## Parameters

The possible values and results for the **modeOption** parameter are listed below.

<b>modeOption</b>	<b>Description</b>
<empty>	Displays onscreen help for all recognized ICIM mode commands.
<commandname>	Displays onscreen help for the specified command, if recognized.
edit	Displays onscreen help for command line editing and syntax.
commands	Displays onscreen help for global commands (exit, help, who, whoami).

## Access Rights Required

Read, ReadWrite, or Admin

## Example

```
ICIM> help
```

```

icim          - Enter ICIM mode
alarm         - Display active alarms for all modules
eventlogclear - Clear the event log
eventlogfilter - Set the event log filter parameters
file         - Access file related commands
ike          - Access IPsec Internet key exchange protocol related
              commands
info         - Display information on 1 or more ICIM2 parameters. All
              parameters are optional and can be entered in any order.
              At least 1 parameter must be specified for the command to
              be valid.
iproute      - Access IP routing related commands
ipsec        - Enable or disable IPsec on the ICIM2
logout       - Log off this system
manual       - Show detailed help text
reboot       - Reboot the ICIM2
set          - Access ICIM2 set related commands
show         - Display information on 1 or more ICIM2 parameters. All
              parameters are optional and can be entered in any order.
              At least 1 parameter must be specified for the command to
              be valid.
              Exceptions to multiple parameters are those commands that
              return multi-word replies: clock, domain, eventlog,
              eventlogall, eventlogfilter, file, ike, iproute,
              provisioning, traps and user. These must be entered
              separately.
sntp         - Access SNTP parameter settings
traps        - Update an entry in the trap receiver table
user        - Access user related commands

ICIM>

```

## Related Commands

help (CLI command mode)

help (Module command mode)

help (Terminal command mode)

## ike

This command is reserved for future use.



## info

### Syntax

```
info icimValue1 icimValue2 . . . icimValuen
```

### Description

The **info** command is used to request a listing of one or more parameter values specific to the ICIM2 module itself. Any number of these values can be listed, and the output returns the values in the order requested.

### Parameters

Each **icimValue** parameter can have one of the values listed below.

Argument	Description
ACTIVEREV	Active software image revision for the ICIM2.
ATTNSTATUS	Value for the Attention line (high is normal).
BOOTREV	Current boot image revision for the ICIM2.
CHASSIS	Chassis containing the ICIM2.
CLEI	Reserved for future use.
CLLI	Reserved for future use.
COMMREAD <sup>1</sup>	The SNMP Community Read string.
COMMTRAP <sup>1</sup>	The SNMP Community Trap string.
COMMWRITE <sup>1</sup>	The SNMP Community Write string.
DEVTYPE	The devtype for the ICIM2.
DOWNLDCMD	Reserved for future use.
DOWNLDDIR	Reserved for future use.
DOWNLDFILE	Reserved for future use.
DOWNLDRESULT	Reserved for future use.
DOWNLDSEM	Reserved for future use.
DOWNLDSIG	Reserved for future use.
DOWNLDSTATE	Reserved for future use.
DOWNLDTGT	Reserved for future use.
DOWNLDUSER	Reserved for future use.

<b>Argument</b>	<b>Description</b>
FTPSEVER	Reserved for future use.
FTPUSER	User name for FTP account.
GATEWAY	IP address of TCP/IP gateway, for packet routing.
HWREV	Hardware revision.
INACTIVEREV	Reserved for future use.
IP	IP address for the ICIM2.
IPSEC	Reserved for future use.
LOCKOUT	Current User Lockout interval.
MAC	MAC Address for the ICIM2.
MANDATA	Manufacturing data for the ICIM2.
NEXTIMAGE	Image to be active after next reboot.
PREVIOUSIP	Previous IP address for the ICIM2.
SELFTEST	Results of the ICIM2 self test.
SERIAL	Serial number for the ICIM2.
SIZE	Number of modules in the ICIM2 domain.
SLOT	The slot for the ICIM2 (17 for XD chassis, 15 for standard chassis).
SMC	Internal index for the ICIM2 (chassis * 100 + Slot).
STATUSMSG	Status and Error message information.
SUBNET	Subnet mask applied to the ICIM2 IP address.
SWDATE	Software date (obsolete/unused).
SWREV	Software revision (obsolete/unused).
THRESHOLD	Login attempts threshold value.
TIMEOUT	User session inactivity timeout value.
TOS	Time of Service information for the ICIM2.
TZONE	Time zone string setting.
UPDATEID	Flag to update chassis IDs (always zero, write-only).

<sup>1</sup> These values are available to Admin users only.

## Access Rights Required

Read, ReadWrite, or Admin

## Example

The sample dialog below shows how this command might be sent by an element management system.

```
CLI> icim info IP devtype serial swrev attnstatus size exit
IP          DEVTYPE  SERIAL   SWREV   ATTNSTATUS  SIZE
172.23.200.154 5011     AADORTI  2.02.10  1           20
SUCCESS!
CLI>
```

## Related Commands

show

## iproute

### Syntax

```
iproute keyWord ip_address gateWay
```

### Description

The **iproute** command is used to add, delete, or show ICIM2 IP route definitions.

### Parameters

Each **keyWord** parameter can have one of the values listed below.

keyWord	Description
add	Adds a new route to the specified destination IP address via the specified gateway IP address.
delete	Deletes the existing route to the specified destination IP address via the specified gateway IP address.

The **ip\_address** parameter is the IP address of the destination, and the **gateWay** parameter is the gateway IP address.

### Access Rights Required

Admin

### Example

```
ICIM> show iproute

ROUTE NET TABLE
destination      gateway          flags           Refcnt  Use      Interface
-----
0.0.0.0          172.24.28.254   33619971        3        3        motfec0
172.24.28.0      172.24.28.151   33554689        1        0        motfec0
-----

ROUTE HOST TABLE
destination      gateway          flags           Refcnt  Use      Interface
-----
127.0.0.1        127.0.0.1        35651589        0        0        lo0
172.18.1.7        172.24.28.254   33685511        1        115     motfec0
172.18.9.24       172.24.28.254   33947655        0        9        motfec0
172.18.10.23      172.24.28.254   33685511        1        181     motfec0
-----

SUCCESS!
ICIM>
```

## Related Commands

show iproute

## ipsec

This command is reserved for future use.

# logout

## Syntax

logout

## Description

The **logout** command is used to terminate the current CLI session. This command is available in every command mode.

### Important:

- For Telnet operation, the computer you are using must have a network connection through which it can reach the ICIM2 via its IP address.
- No more than four Telnet sessions are allowed at one time.



### CAUTION:

Always use the Logout command to close a serial port or Telnet CLI session. Closing a serial port session without issuing the Logout command leaves the session open for a possible future connection. This may allow unauthorized access by a new user if the previous user had a higher authorization privilege level.

## Parameters

None

## Access Rights Required

Read, ReadWrite, or Admin

## Example

```
ICIM> logout
connection to host lost
C:\>
```

## Related Commands

exit

# manual

## Syntax

manual

## Description

The **manual** command is used to display detailed help for the ICIM command mode, or for another command mode if specified while another mode is active.

## Parameters

None

## Access Rights Required

Read, ReadWrite, or Admin

## Example

```
ICIM> manual
```

Try one of these help commands for details on specific modes:

```
module manual
terminal manual
icim manual
```

General Hints:

Keywords can be abbreviated to a unique prefix. For instance in CLI mode, the keyword 'MODULE' can be given as just 'm' or 'mod'.

Use TAB to autocomplete a keyword.

Use ? to list expected keywords or tokens (depends on previous input).

Use BACKSPACE to erase previous characters.

Use 'help edit' to display more editing commands

Use Alarm in any mode to get a list of active alarms. When in Module mode, you can also narrow the list of active alarms to just those in the current ModSpec range. See the Module Help for further details.

Note: entering a mode command (MODULE, ICIM, TERMINAL) enters that mode immediately but it is not indicated until the next prompt is displayed.

The interface uses modes: CLI, MODULE, TERMINAL, and ICIM. The prompt reflects the current mode. Enter the mode name to enter that mode, and use EXIT to leave the mode and return to CLI mode.

ICIM Commands:

Enter ICIM mode by giving 'ICIM' and a newline. Thereafter, until an 'Exit' is found, the interface is in ICIM mode.

alarm

Use the 'alarm' command to show all the current alarms. This command works in all modes.



**eventlogclear**

Use the 'eventlogclear' command to erase the entire contents of the event log.

**eventlogfilter**

Use the 'eventlogfilter' command to set the filter parameters for the event log. There are three available parameters: hardware, provisioning and system. Specify on to log events of each parameter type or off to skip logging these events.

Example of valid commands:

```
ICIM> eventlogfilter hardware off
ICIM> eventlogfilter provisioning on
ICIM> eventlogfilter system on
```

**exit**

Use the 'exit' command to return to CLI mode. This command must be used before entering MODULE or TERMINAL mode.

**file <parameter> <value>**

Use the 'file' command to change the settings for transferring the event log from the ICIM2 to a remote FTP server as a text file.

Following are examples of settings for these 5 values:

```
ICIM> file ip <ip_address>
ICIM> file name goqam
ICIM> file password <ftp_password>
ICIM> file path <ftp_path>
ICIM> file user <ftp_username>
```

To show the current settings, use the 'show file' command.

**ike**

Use the 'ike' command to show or change the Internet Key Exchange settings. To show the current settings, use the 'show ike' command.

To add an entry in the ike settings:

```
ICIM> ike add <ip_address> <key>
```

To delete an entry:

```
ICIM> ike delete <ip_address>
```

## Chapter 5 ICIM Mode Commands

**info <parameter(s)>**  
Use the 'info' command to display one or more ICIM parameter values. Any number of available parameters can be requested with the same command. Examples of valid commands:  
ICIM> info activerev  
ICIM> info commread commwrite clei  
This is a list of all parameters available for use with this command:

activerev	Active software image revision for the ICIM
attnstatus	Value of the Attention line (High is normal)
bootrev	Current boot image revision for the ICIM
chassis	Chassis containing the ICIM
clei	Common Language Equipment ID code for ICIM
clli	Common Language Locator ID code for ICIM
commread	SNMP Read Community string
commtrap	SNMP Trap Community string
commwrite	SNMP Write Community string
devtype	Numeric type value used for element manager, Typically 5011
downldcmd	Download Command
downlddir	Directory path (excluding filename) for FTP
downldfile	Filename ONLY of image to FTP
downldresult	Download progress status and result
downldsem	Application security semaphore
downldsig	Application security info
downldstate	State machine value to indicate ftp/download progress
downldtgt	Module Chassis and slot to upgrade with release image
downlduser	Application User ID to ensure only one instance
ftpserver	IP address of FTP Server
ftpuser	User name for FTP server
gateway	IP address of TCP/IP gateway, for packet routing
hwrev	Hardware Revision
inactiverev	Inactive software image revision for the ICIM
ip	TCP/IP address of the ICIM
ipsec	IP Security state (enabled or disabled)
lockout	Lockout interval in minutes
mac	MAC Address (used in low-level ethernet routing)
mandata	Manufacturing data
nextimage	The image to be active after next reboot
previousip	Value of the TCP/IP before it was last changed
selftest	Results of ICIM self test
serial	Serial Number
size	Number of modules in this ICIM's domain
slot	Always 15 -- the slot holding the ICIM
smc	The value: (Chassis * 100) + Slot for the ICIM
statusmsg	Status and Error Msg info
subnet	Subnet mask, such as 255.255.255.0
swdate	Software date (obsolete)
swrev	Software Revision (obsolete)
threshold	Login attempts threshold value
timeout	User session inactivity timeout value
tzone	Time zone string
tos	Time of Service
updateid	Always 0 (this is a write-only value)

**iproute**  
Use the 'iproute' command to add delete or show IP routes. Following are examples of the 'iproute' command usage:  
ICIM> iproute add <ip address> <gateway>  
ICIM> iproute delete <ip address> <gateway>  
To show the current settings, use 'show iproute'

**ipsec**  
Use the 'ipsec' command to enable or disable the use of IPSec.  
ICIM> ipsec enable  
ICIM> ipsec disable

**logout**  
Use the 'logout' command to logout of the CLI session. If the session is a telnet session, it will be closed. If the session is the local console port, the login prompt will be given.

**manual**  
Use the 'manual' command to display this help.

**reboot**  
Use the 'reboot' command to reboot the ICIM2. The modules will not be rebooted.

set <parameter> <value>

Use the 'set' command to set any of the user-changeable ICIM2 values. Following are the parameters available for modification:

cli	Common Language Locator ID code for ICIM
clock	The ICIM2 real time clock (value MUST be in quotes)
commread	SNMP Read Community string
commtrap	SNMP Trap Community string
commwrite	SNMP Write Community string
gateway	IP address of TCP/IP gateway, for packet routing
ip	TCP/IP address of the ICIM
lockout	Lockout interval in minutes (0 disables lockout)
statusmsgclearkey	Set to 1 to clear the status message
subnet	Subnet mask, such as 255.255.255.0
threshold	Use the 'set threshold' command to set the login threshold number. Valid values are 0-15, where 0 disables threshold checking.
timeout	Use the 'set timeout' command to set the user inactivity timeout. Once a user session has been inactive for this many minutes, the user will be automatically logged out of the system. Valid values are from 1 to 60. Changes to timeout affect future console, Telnet and Web sessions.
tzone	Time zone string
updateid	Set to 1 to have the system read a new chassis ID

And here are some examples of using the 'set' command:

```
ICIM> set commread public
ICIM> set clock "9/12/2006 14:21:30"
ICIM> set updateid 1
```

show

Use the 'show' command to display one or more ICIM parameter values. Any number of available parameters can be requested with the same command. Exception commands are those that return multi-word replies: clock, domain eventlog, eventlogall, eventlogfilter, file, ike, iproute, provisioning, traps and user. These must be entered separately.

Examples of valid commands:

```
ICIM> show activercv
ICIM> show commread commwrite clei
```

The 'show' command can be used to display all of the parameters that are supported by the 'info' command, plus these:

clock	The ICIM2 real time clock
domain	The complete module listing for this ICIM domain
eventlog	The ICIM2 event log with only the timestamp, user and description fields to make console viewing simpler
eventlogall	The ICIM2 event log with all fields
eventlogfilter	The filter settings for the event logging
file	The file management settings for FTP transfer of event log
ike	The Internet Key Exchange settings
iproute	The IP Route settings
lockedusers	The currently locked user accounts
provisioning	The commands needed to restore the module configuration
sntp	The SNTP settings to synchronize the RTC with the NTP Server
traps	The trap receiver table settings
user	The table of configured user accounts

sntp <parameter> <value>

Use the 'sntp' command to change the settings to synchronize the ICIM's Real Time Clock with the Network Time Protocol Server.

Last of all, activate SNTP by changing sntp state to 'enable'.

Following are examples of settings for these values:

```
ICIM> sntp mode <unicast | broadcast>
ICIM> sntp ip <ip address>
ICIM> sntp timeout <seconds>
ICIM> sntp interval <hours>
ICIM> sntp state <enable | disable>
```

To show the current settings, use the 'show sntp' command.

traps <state> <index> <ip\_address>

Use the 'traps' command to modify the trap receiver table. The table holds 10 trap receivers, indexed 0 to 9. If a receiver entry already exists and its state is being modified, it is not necessary to use the <ip\_address> parameter. Examples:

```
ICIM> traps enable 0 192.32.101.12
ICIM> traps disable 3
```

## Chapter 5 ICIM Mode Commands

```
user
Use the 'user' command to display or modify the user table.
To show the table:
  ICIM> show user
To add a new user to the table:
  ICIM> user add <user_id> <access_level> <account_status>
The user_id field must be between 6 and 14 characters and contain both
alpha and numeric characters. The access_level can be admin, read or
readwrite. The account_status can be either enable or disable. Once
the command is accepted, the user will be prompted for a new password.
To delete a user from the table:
  ICIM> user delete <user_id>
To change settings for an existing user:
  ICIM> user change access_rights <user_id> <new_access_value>
  ICIM> user change account_status <user_id> <new_status_value>
  ICIM> user change password <user_id>
<new_access_value> can be admin, read or readwrite, while
<new_status_value> can be enable or disable. The user will be prompted
for a new password in the case of that change.
To unlock a user account:
  ICIM> user unlock <user_id>

ICIM>
```

## Related Commands

- manual (CLI command mode)
- manual (Module command mode)
- manual (Terminal command mode)
- help

# reboot

## Syntax

reboot

## Description

The **reboot** command causes the ICIM2 to reboot. This command does not affect module operations. However, you may have to re-establish all user services.

**Note:** This command reboots the ICIM2 only.

## Parameters

None

## Access Rights Required

Admin

## Example

The lines shown below will be followed by the usual startup messages, and then by the login prompt.

```
ICIM> reboot
```

```
The ICIM2 is about to reboot. This will end all current login and web  
sessions. Are you sure you want to proceed (Yes/No)? yes
```

```
SUCCESS!
```

## Related Commands

None

# set

## Syntax

```
set valueName newValue
```

## Description

The **set** command allows a single parameter value to be set in the ICIM2 by specifying the parameter to be changed and the new value.

## Parameters

The **valueName** parameter can be one of the following:

<b>valueName</b>	<b>Description</b>
CLLI	Reserved for future use.
CLOCK	Date and Time as maintained by the ICIM2.
COMMREAD	SNMP Read Community string (default prismaread).
COMMTRAP	SNMP Trap Community string (default prismatrap).
COMMWRITE	SNMP Write Community string (default prismawrite).
GATEWAY	IP address of the TCP/IP gateway, for packet routing (of the form 172.24.28.254).
IP	TCP/IP address of the ICIM2 (of the form 172.24.25.151).
LOCKOUT	Change the User Lockout interval (1-60 minutes; 0 to disable).
STATUSMSGCLEARKEY	Controls whether Error or Status message is kept or cleared.
SUBNET	Subnet mask (of the form 255.255.0.0).
THRESHOLD	User failed login attempts threshold.
TIMEOUT	User inactivity timeout in minutes.
TZONE	Time zone of the ICIM2 (see note below).
UPDATEID	Write-only; value of 1 causes ICIM2 to re-read ID of all modules.

The **newValue** parameter is the new parameter value to be set.

### Notes:

- Some of these values (IP and GATEWAY, for example) result in changes to ICIM2 non-volatile memory, but do not take effect until the next reboot.

- Be careful when using the **set tzone** command. Systems that use an external clock reference may periodically overwrite settings made with this command. Date, time, and timezone changes should be made to the master clock reference if one is in use.

## Access Rights Required

Admin

## Example

```
ICIM> set ip 192.0.2.12
ICIM> set gateway 192.0.2.17
ICIM> set subnet 192.0.2.11
```

## Related Commands

info

show

## set clock

### Syntax

```
set clock "mm/dd/yyyy hh:mm:ss"
```

### Description

The **set clock** command allows the ICIM2 Real Time Clock (RTC) to be set and confirmed by a single command.

#### Notes:

- The new date/time value must be enclosed in quotes.
- Be careful when using this command in systems that employ an external clock reference. These systems may periodically overwrite settings made with the **set clock** command. For this reason, it is best to make date, time, and timezone changes to the master clock reference, if one is used.

### Parameters

The date parameter, **mm/dd/yyyy**, defines:

- The current month as one or two digits.
- The current day as one or two digits.
- The current year as four digits.

The time parameter, **hh:mm:ss**, defines:

- The current hour as two digits in 24-hour format.
- The current minute as two digits.
- The current second as two digits.

### Access Rights Required

Admin



## Example

In the following example, note that the system responds by confirming the current date and time settings. This avoids the need to issue a separate **show clock** confirmation command.

```
ICIM> set clock "10/5/2005 12:40:00"  
Wed, 05 Oct 2005 12:40:00 EST  
SUCCESS!  
ICIM>
```

## Related Commands

show clock

## show

### Syntax

```
show icimValue1 icimValue2 . . . icimValuen
```

### Description

The **show** command is used to request a listing of one or more parameter values specific to the ICIM2 module itself.

Multiple values may be listed, except that values returning multiple-word responses (see table below) must be listed individually.

When two or more values are listed, the output returns the values in the order requested.

### Parameters

Each **icimValue** parameter can have one of the values listed below.

Argument	Description
ACTIVEREV	Active software image revision for the ICIM2.
ATTNSTATUS	Value for the Attention line (0 is normal).
BOOTREV	Current boot image revision for the ICIM2.
CHASSIS	Chassis containing the ICIM2.
CLEI	Reserved for future use.
CLLI	Reserved for future use.
CLOCK <sup>1</sup>	The Date and Time as maintained by the ICIM2.
COMMREAD <sup>2</sup>	The SNMP Community Read string.
COMMTRAP <sup>2</sup>	The SNMP Community Trap string.
COMMWRITE <sup>2</sup>	The SNMP Community Write string.
DEVTYPE	The devtype for the ICIM2.
DOMAIN <sup>1</sup>	Requests information on all modules in the ICIM2 domain.
DOWNLDCMD	Reserved for future use.
DOWNLDDIR	Reserved for future use.
DOWNLDFILE	Reserved for future use.
DOWNLDRESULT	Reserved for future use.

<b>Argument</b>	<b>Description</b>
DOWNLDSEM	Reserved for future use.
DOWNLDSIG	Reserved for future use.
DOWNLDSTATE	Reserved for future use.
DOWNLDTGT	Reserved for future use.
DOWNLDUSER	Reserved for future use.
EVENTLOG <sup>1,2</sup>	ICIM2 event log, abbreviated (only timestamp, user, and description fields included to facilitate console viewing).
EVENTLOGALL <sup>1,2</sup>	ICIM2 event log, all fields included.
EVENTLOGFILTER <sup>1</sup>	Event log filter parameters.
FILE <sup>1</sup>	Event log file management parameters.
FTPSEVER	Reserved for future use.
FTPUSER	Reserved for future use.
GATEWAY	IP address of TCP/IP gateway, for packet routing.
HWREV	Hardware Revision.
INACTIVEREV	Inactive software image revision for the ICIM2.
IKE <sup>1,2</sup>	Reserved for future use.
IP	TCP/IP address of the ICIM2.
IPROUTE <sup>1</sup>	IP route settings.
IPSEC	Reserved for future use.
LOCKEDUSERS <sup>1</sup>	Lists users currently locked out for reaching maximum failed logins.
LOCKOUT	Displays the current User Lockout interval.
MAC	MAC Address, used in low-level Ethernet routing.
MANDATA	Manufacturing data.
NEXTIMAGE	The image to be active after the next reboot.
PREVIOUSIP	Value of the TCP/IP address before it was last changed.
PROVISIONING <sup>1</sup>	Causes the system provisioning commands to be sent to the terminal.
SELFTTEST	Results of the ICIM2 self test.
SERIAL	Serial number of the ICIM2.
SIZE	Number of modules in the ICIM2 domain.
SLOT	The slot for the ICIM2 (17 for XD chassis, 15 for standard chassis).
SMC	The value (Chassis * 100) + Slot for the ICIM2.

Argument	Description
SNTP <sup>1</sup>	Reserved for future use.
STATUSMSG	Status and Error message information.
SUBNET	Subnet mask, such as 255.255.255.0.
SWDATE	Software date (obsolete).
SWREV	Software revision (obsolete).
THRESHOLD	User failed login threshold.
TIMEOUT	User inactivity timeout.
TOS	Time of Service of the ICIM2.
TRAPS <sup>1</sup>	Displays the current trap receiver table.
TZONE	Time zone of the ICIM2.
UPDATEID	Always zero (0); this is a write-only value.
USER <sup>1,2</sup>	Table of defined users; System Release 2.01 adds LOCKED column.

<sup>1</sup> These values return multiple-word responses, and so must be listed individually.

<sup>2</sup> These values are available to Admin users only.

## Access Rights Required

Read, ReadWrite, or Admin

## Example

The sample dialog below shows how this command might be sent by an element management system.

```
CLI> icim show IP devtype serial attnstatus size exit
IP          DEVTYP  SERIAL  ATTNSTATUS  SIZE
172.23.200.154 5011    AADORTI  0           20
SUCCESS!
CLI>
```

## Related Commands

info

# show clock

## Syntax

```
show clock
```

## Description

The **show clock** command is used to display the current ICIM2 Real Time Clock (RTC) date and time settings.

## Parameters

None

## Access Rights Required

Read, ReadWrite, or Admin

## Example

```
ICIM> show clock  
  
MM-DD-YYYY      HH:mm:ss  
10-17-2006      12:01:40  
  
Tue, 17 Oct 2006 12:01:40 EST  
  
SUCCESS!  
ICIM>
```

## Related Commands

set clock

## show domain

### Syntax

```
show domain
```

### Description

The **show domain** command is used to request information about the elements in the ICIM2 domain. This command displays a list of all of the modules in the ICIM2 domain.

### Parameters

None

### Access Rights Required

Read, ReadWrite, or Admin

### Example

The sample dialog below illustrates the use of this command.

```
ICIM> show domain

MODID  DEVTYPE  SERIAL      ACTIVEREV  CODEREV  NAME
01/00  5020     ^ABCDEFGG   1.01.05    CF_CCB3  XD-Chassis
01/01  1020     MMAAFEFJ   N/A        155      HDTx
01/15  1032     MMAAFCEP   N/A        172      HDTx
02/00  5020     ^ABCDEFGG   1.01.05    CF_CCB3  XD-Chassis
02/03  2015     ~AAUPYYM   1.01.11    CF_CCB3  P2-HD-RXF
02/12  2015     ~AAUPYZN   1.01.11    CF_CCB3  P2-HD-RXF
03/00  5020     ^ABCDEFGG   1.01.05    CF_CCB3  XD-Chassis
03/02  2014     ~AAURBRH   1.01.09    CF_CCB3  P2-HD-RXR
03/06  2011     ~AAUOLZE   1.01.08    CF_CCB3  P2-HD-RXR-HG
03/11  2014     ~AAURBRW   1.01.09    CF_CCB3  P2-HD-RXR
03/16  2011     ~AAUPTZK   1.01.08    CF_CCB3  P2-HD-RXR-HG
98/00  5020     ^ABCDEFGG   1.01.05    CF_CCB3  XD-Chassis
98/04  1020     MMAAFEFK   N/A        155      HDTx
98/05  1020     MMAAFEBV   N/A        155      HDTx
98/09  1020     KKAAEBTG   N/A        1.55     HDTx
98/10  1020     NNAAAFBJ   N/A        YCCB155  HDTx
98/11  1020     KKAAEBUL   N/A        1.55     HDTx
98/13  1020     NNAAAFBY   N/A        YCCB155  HDTx
98/14  1020     NNAAAFBX   N/A        YCCB155  HDTx
98/15  1020     NNAAAFBZ   N/A        YCCB155  HDTx

SUCCESS!
ICIM>
```

In the response, each module is identified by its chassis and slot number (MODID) as well as by object type (DEVTYPE), serial number (SERIAL), software revision number (ACTIVEREV), code revision number (CODEREV), and product description (NAME).

## Related Commands

show provisioning

show traps

## show eventlog

### Syntax

```
show eventlog
```

### Description

The **show eventlog** command is used to display an abbreviated version of the event log. Only three columns are displayed: date/time, user, and description. This is the preferred method for viewing the event log through the CLI. For further information, see the **Event Log** section of the *Prisma II™ XD Platform System Guide*, part number 4021339.

### Parameters

None

### Access Rights Required

Admin

### Example

The sample dialog below illustrates the use of this command.

```
ICIM> show eventlog
10/30/06 17:34:15 Administrat0r   Change inactivity
                    timer setting to: 60 minutes
10/30/06 17:33:33 Administrat0r   Login successful
10/30/06 17:33:25 admin1         Log Off
3 log messages displayed

SUCCESS!
ICIM>
```

### Related Commands

```
show eventlogall
```

```
show eventlogfilter
```



# show eventlogall

## Syntax

```
show eventlogall
```

## Description

The **show eventlogall** command is used to display a full version of the event log. All columns are displayed: date/time, user, user access level, log category, log action ID, and description.

This method typically produces an output too wide for terminal settings, but may be useful when all log fields are needed. For further information, see the **Event Log** section of the *Prisma II™ XD Platform System Guide*, part number 4021339.

## Parameters

None

## Access Rights Required

Admin

## Example

The sample dialog below illustrates the use of this command.

```
ICIM> show eventlogall

10/30/06 17:34:15 Administrat0r AD AD CHG_INACTIVITY_TIMER Change
    inactivity timer setting to: 60 minutes
10/30/06 17:33:33 Administrat0r AD SE LOGIN_SUCCESS Login successful
10/30/06 17:33:25 admin1 AD SE LOG OFF Log Off
3 log messages displayed

SUCCESS!
ICIM>
```

## Related Commands

show eventlog

show eventlogfilter

## show eventlogfilter

### Syntax

```
show eventlogfilter
```

### Description

The **show eventlogfilter** command is used to display the current event log filter parameter settings. These settings determine which of three categories of events (Provisioning, Hardware, and System) are included or excluded in future event log entries. For further information, see the **Event Log** section of the *Prisma II™ XD Platform System Guide*, part number 4021339.

### Parameters

None

### Access Rights Required

Read, ReadWrite, or Admin

### Example

The sample dialog below illustrates the use of this command.

```
ICIM> show eventlogfilter

Event Log Settings:
  Provisioning Events: on
  Hardware Events: on
  System Events: on
  (a value of "on" means to log events of that category)

SUCCESS!
ICIM>
```

### Related Commands

```
show eventlog
```

```
show eventlogall
```

## show file

### Syntax

```
show file
```

### Description

The **show file** command is used to display the current event log file management parameter settings. These settings control the FTP transfer of the event log file from the ICIM2 to a remote FTP server.

### Parameters

None

### Access Rights Required

ReadWrite or Admin

### Example

The sample dialog below illustrates the use of this command.

```
ICIM> show file

File Transfer Settings:
  IP Address   192.15.26.102
  Remote Path  \ftproot
  File Name    eventlog.txt
  User Name    Set
  Password     Set

SUCCESS!
ICIM>
```

**Note:** For security reasons, the username and password are not displayed. If these values are set, then "Set" is shown. Otherwise, "Not Set" indicates that the values have not yet been assigned.

### Related Commands

file

## show ike

This command is reserved for future use.

# show iproute

## Syntax

```
show iproute
```

## Description

The **show iproute** command is used to display the ICIM2 IP routing table.

## Parameters

None

## Access Rights Required

Read, ReadWrite, or Admin

## Example

The sample dialog below illustrates the use of this command.

```
ICIM> show iproute

ROUTE NET TABLE
destination      gateway          flags           Refcnt  Use           Interface
-----
0.0.0.0          192.24.28.254   33619971       2       127           motfec0
192.24.28.0     192.24.28.155   33554689       1       0             motfec0
-----

ROUTE HOST TABLE
destination      gateway          flags           Refcnt  Use           Interface
-----
127.0.0.1       127.0.0.1       35651589       0       0             lo0
192.18.9.24     192.24.28.254   33947655       0       374          motfec0
192.18.9.88     192.24.28.254   33685511       1       18           motfec0
-----

SUCCESS!
ICIM>
```

## Related Commands

iproute

## show provisioning

### Syntax

```
show provisioning
```

### Description

The **show provisioning** command is used to request information about how the elements of the ICIM2 domain are currently provisioned (configured).

This command displays a list of the CLI commands needed to restore any replacement modules in the ICIM2 domain to their current operating states. This list can serve as a command reference to quickly configure a replacement module so that it operates identically to the original.

The output is intended primarily for use by an element management system, which would store the provisioning commands until needed. In the event that a module is replaced, the system would then send the provisioning commands required to configure the replacement module to match the operating state of the original.

### Parameters

None

### Access Rights Required

Read, ReadWrite, or Admin

### Example

The following sample dialog shows how a network management system might send the command, and includes part of a typical response. Note that the element management system uses an inline (non-modal) command to switch from CLI to ICIM command mode.

```
CLI> icim show provisioning exit

Module Modid 0100 EXIT
Module Set Control AlmMuteA Off EXIT
Module Set Control AlmMuteB Off EXIT

Module Modid 0101 EXIT
Module Set Control Enable 1 EXIT
Module Set Control CwMode 0 EXIT
Module Set Control LoRFInh 0 EXIT
Module Set Control Master Master EXIT
Module Set Control RFDrive 0 EXIT
Module Set Control AGC 0 EXIT

. . . . .
```

```
Module Modid 9815 EXIT
Module Set Control Enable 1 EXIT
Module Set Control CwMode 0 EXIT
Module Set Control LoRFInh 0 EXIT
Module Set Control Master Master EXIT
Module Set Control RFDrive 0 EXIT
Module Set Control AGC 0 EXIT

Module Modid */* EXIT

SUCCESS!
CLI>
```

Using the list requires first locating all command lines that target the chassis and slot location of the replacement module. The commands are then sent to the replacement module one at a time in the order listed. For example, after replacing the module in chassis 1 slot 1 in the above example, the commands on lines 5-10 of the response would be sent to configure the replacement module.

**Note:** The CLI has no mechanism for accepting multiple commands at a single prompt from a craft operator or element management system. It is necessary to send the first command, wait for a new prompt, send the next command, and so on until all commands are sent.

## Related Commands

show domain

show traps

## show sntp

This command is reserved for future use.



# show traps

## Syntax

```
show traps
```

## Description

The **show traps** command is used to request information about the traps defined in the ICIM2 Trap table. In response to this command, the system displays the current status of the Trap table.

## Parameters

None

## Access Rights Required

Read, ReadWrite, or Admin

## Example

A typical response to this command is shown in the sample craft operator dialog below:

```
ICIM> show traps

IDX  STATE      IP Address
 0   Enabled   172.18.50.41
 1   Enabled   172.18.50.1
 2   Enabled   172.18.50.6
 3   Disabled  0.0.0.0
 4   Disabled  0.0.0.0
 5   Disabled  0.0.0.0
 6   Disabled  0.0.0.0
 7   Disabled  0.0.0.0
 8   Disabled  0.0.0.0
 9   Disabled  0.0.0.0

SUCCESS!
ICIM>
```

## Related Commands

show domain

show provisioning

traps

## show user

### Syntax

```
show user
```

### Description

The **show user** command is used by an Administrator (a user with Admin level authorization) to list all the available logins and authorization levels. It does not display the passwords.

### Parameters

None

### Access Rights Required

Admin

### Example

```
ICIM> show user

LOGIN IDENTIFIER  ACCESS LEVEL  STATUS  LAST LOGIN  FAILED  LOCKED
Administrat0r    ADMIN        Enabled  09/02/06 09:02:07  0       No
Benjamin9       READWRITE   Enabled  09/01/06 12:46:13  0       No
Chris555        READ        Enabled  08/29/06 23:55:55  0       No
Doug3333       ADMIN        Enabled  09/02/06 13:16:31  0       No
Emily567891012  READWRITE   Enabled  09/13/06 18:09:50  0       No
Frank5          READ        Enabled  06/30/06 03:24:34  0       No
george8         ADMIN        Enabled  07/12/06 11:38:21  0       No
HEIDI2345      READWRITE   Enabled  09/06/06 09:22:44  0       No

SUCCESS!
ICIM>
```

### Related Commands

user add

user change

user delete

## sntp

This command is reserved for future use.

## traps

### Syntax

```
traps state index [IPAddress]
```

### Description

The **traps** command allows the entries in the Trap table to be enabled or disabled, and allows the IP address of the Trap table to be set.

#### Note:

- The Trap table has 10 entries, indexed 0 through 9. Each entry can be enabled by supplying a valid IP address, or if the table entry already has a valid IP address.
- When enabling or disabling an entry already in the Trap table, the IP address parameter is optional, so you do not have to specify it.

For instructions on viewing the Trap table, see *show traps* (on page 129).

### Parameters

Parameter	Description
state	Specifies whether this command is to <b>enable</b> or <b>disable</b> traps.
index	Trap table index (0-9).
[IPAddress]	Optional IP address to put in the table.

### Access Rights Required

Admin

### Example

```
ICIM> traps disable 2
```

```
You are about to change entry 2 to 'disabled' with an IP of 172.16.0.0
To confirm, you must type 'YES' followed by an Enter: yes
```

```
SUCCESS!
ICIM>
```

### Related Commands

```
show traps
```

## user add

### Syntax

```
user add username authlevel accountstatus
```

### Description

The **user add** command is used to add a new login and password to the ICIM2 authentication table. A dialog is used to obtain and validate the password.

### Parameters

The **username**, or user identifier, must be 6 to 14 characters in length and contain both letters and numbers. The username cannot include special characters special characters such as %, @, and !. An example of a valid username is abc123.

The **authlevel**, or authorization level, may be one of the following:

authlevel	Description
Admin	Equivalent to a Unix superuser (root) and should be allowed for only the most trusted logins. An Admin can change passwords, IP addresses, and other critical values.
ReadWrite	Allows typical operations, including the ability to change control values and alarm parameters.
Read	Allows the user to read non-critical values only, and has no write permissions.

The **accountstatus** may be one of the following:

accountstatus	Description
Enable	The account is enabled.
Disable	The account is created but disabled.

**Note:** After entering this command, you will be prompted to enter a password for the user. The password must be 6 to 14 characters in length and contain both letters and numbers. Unlike the username, the password may contain special characters such as %, @, and !. An example of a valid password that contains special characters is &bc12?.

### Access Rights Required

Admin

## Example

```
ICIM> user add smith8 readwrite enable  
Please enter the password:
```

## Related Commands

user change

user delete

user unlock

show user

# user change

## Syntax

```
user change userparam username newvalue
```

## Description

The **user change** command is used by the Administrator (a user with Admin authorization) to change the access rights, account status, or password of an existing user. A dialog is used to obtain and validate the new setting.

Passwords must be 6 to 14 characters in length and contain both letters and numbers. Unlike user names, passwords may contain special characters such as %, @, and !.

**Note:** This command can be used to change the authorization level of a user without having to delete and add the user.

## Parameters

The **userparam** may be one of the following:

<b>userparam</b>	<b>Description</b>
Access_rights	Specify this parameter to change the user access rights or authorization level. The <b>newvalue</b> parameter must be set to <b>admin</b> , <b>readwrite</b> , or <b>read</b> , as appropriate.
Account_status	Specify this parameter to change the user account status. The <b>newvalue</b> parameter must be set to <b>enable</b> or <b>disable</b> , as appropriate.
Password	Specify this parameter to change the user password. Omit the <b>newvalue</b> parameter. A dialog will prompt for the new password.

The **username** or user identifier must be 6 to 14 characters in length and contain both letters and numbers. Unlike passwords, user names cannot contain special characters such as %, @, and !. An example of a valid username is abc123. The user name must already exist in the authentication table.

## Access Rights Required

Admin

## Example

```
ICIM> user change password smith8  
Please enter the password:
```

## Related Commands

user add

user delete

user unlock

show user



# user delete

## Syntax

```
user delete username
```

## Description

The **user delete** command is used by an Administrator (a user with Admin level authorization) to remove an existing login and password from the ICIM2 authentication table.

### Notes:

- It is not necessary to delete a user to change account settings. See *user change* (on page 135) for details.
- Deleting a user that is already logged in does not terminate their current session.

## Parameters

The **username** must be 6 to 14 characters in length and contain both letters and numbers. The username cannot include special characters. For example, abc123 is a valid user name. The username must already exist in the authentication table.

## Access Rights Required

Admin

## Example

```
ICIM> user delete smith8  
SUCCESS!  
ICIM>
```

## Related Commands

```
user add  
user change  
user unlock  
show user
```

## user unlock

### Syntax

```
user unlock username
```

### Description

The **user unlock** command is used by an Administrator (a user with Admin level authorization) to unlock a locked-out user before the lockout interval has expired.

#### Notes:

- It is not necessary to unlock a user to change account settings. See *user change* (on page 135) for details.
- Unlocking a locked-out user also resets the failed login attempts counter for that user.
- Users are also unlocked when their user account is enabled or when the ICIM2 is rebooted.
- Do not attempt to unlock a user by changing the user lockout interval, as this may result in an unexpected actual lockout interval for the user.

### Parameters

The **username** must be 6 to 14 characters in length and contain both letters and numbers. The username cannot include special characters. For example, abc123 is a valid user name. The user name must already exist in the authentication table.

### Access Rights Required

Admin

### Example

```
ICIM> user unlock User9438  
SUCCESS!  
ICIM>
```

## Related Commands

user add

user change

show user



# 6

## Terminal Mode Commands

### Introduction

This chapter describes the commands that can be executed in the Terminal command mode. These commands control the appearance of information displayed onscreen in response to other CLI commands.

### In This Chapter

■ Overview .....	142
■ alarm .....	143
■ colsep .....	144
■ exit .....	146
■ headers .....	147
■ help .....	149
■ logout .....	151
■ manual .....	152
■ paging .....	154
■ pattern .....	158
■ show .....	160

## Overview

Terminal mode commands are used to control the way that information appears onscreen in response to CLI commands.

### Types of Terminal Commands

The following commands are recognized in Terminal command mode:

- The **colsep** command controls the separation between columns in a tabular information display.
- The **exit** command is used to exit Terminal command mode and return to CLI command mode.
- The **headers** command controls the presence of headers on any table columns in the display.
- The **help** command is used to display abbreviated help for Terminal mode commands.
- The **logout** command is used to exit CLI and return to the system prompt.
- The **manual** command is used to display detailed help for Terminal mode commands.
- The **paging** command controls whether long output is displayed on screen with or without paging.
- The **pattern** command controls which of two possible wildcard pattern matching styles is in effect.
- The **show** command (in Terminal command mode) displays the current values of all terminal states.

This chapter describes each of these commands and its applications in detail.

### To Access Terminal Command Mode

The CLI only recognizes Terminal mode commands in Terminal command mode.

Complete the following steps to enter Terminal command mode.

- 1 Confirm that you have logged onto CLI as explained in *CLI Login and Logout* (on page 8).
- 2 At the CLI> prompt, type **terminal**, and then press **Enter**.
- 3 Confirm that the command prompt changes to TERMINAL>. You are now in Terminal command mode.

# alarm

## Syntax

alarm

## Description

The **alarm** command is used to display all active alarms in the domain of the ICIM2. This command produces the same results whether entered in CLI, Module, Terminal, or ICIM command mode.

**Note:** This command is functionally equivalent to *alarm domain* (on page 41).

## Parameters

None

## Access Rights Required

Read, ReadWrite, or Admin

## Example

```
TERMINAL> alarm
  No active alarms found
TERMINAL>
```

This response shows that no alarms are active in the ICIM2 domain. To narrow the command scope to specific chassis or modules, use *alarm module* (on page 42).

## Related Commands

alarm (CLI command mode)

alarm (Module command mode)

alarm (ICIM command mode)

alarm domain (Module command mode)

alarm module (Module command mode)

## colsep

### Syntax

```
colsep "string"
```

### Description

The **colsep** command controls the separation between columns of output in the display.

By default, output is displayed in columns only slightly wider than are needed for the longest value in the column. Adding spaces between columns can make the output more legible to a craft operator, but may make output parsing more difficult for a remote element management system.

On the other hand, if element management software recognizes a specific character (such as |) as a column separator, the colsep command can be used to insert this character between columns in the output.

### Parameters

The **string** parameter is the column separation character or characters, or is empty (") to specify default column separation.

### Access Rights Required

Read, ReadWrite, or Admin

### Examples

In the sample dialog below, a network management system sends this command to enforce default column separation just before it sends a command requesting columns of output.

```
CLI> terminal colsep "" exit
CLI> module modid * exit
CLI> module show control *serv* exit

  MODID  NAME      SETTING  UNITS
  01/07  Service  Off (0)
  01/08  Service  Off (0)
  01/09  ServiceA  On (1)
  01/09  ServiceB  Off (0)

SUCCESS!
CLI>
```



The next example shows how the output could be modified to make it more easily parsed by a program such as Microsoft Excel, which recognizes a comma-separated values (CSV) file format.

```
CLI> terminal colsep "," exit
CLI> module modid * exit
CLI> module show control *serv* exit
CHASSIS,SLOT,NAME,SETTING,UNITS
1,7,Service,Off(0),
1,8,Service,Off(0),
1,9,ServiceA,On(1),
1,9,ServiceB,Off(0),
SUCCESS!
CLI>
```

If the output data itself might contain columns, another character such as | can be used as a column separator, as shown in the following example:

```
CLI> terminal colsep "|" exit
CLI> module modid * exit
CLI> module show control *serv* exit
CHASSIS|SLOT|NAME|SETTING|UNITS
1|7|Service|Off(0)
1|8|Service|Off(0)
1|9|ServiceA|On(1)
1|9|ServiceB|Off(0)
SUCCESS!
CLI>
```

## Related Commands

headers

paging

pattern

show (Terminal mode)

# exit

## Syntax

exit

## Description

The **exit** command is used to exit Terminal command mode to the CLI command mode for the purpose of entering CLI mode commands or selecting Module or ICIM command mode.

**Note:** The exit command is not recognized in CLI mode and does not result in a logout. See *logout* (on page 151) for details.

## Parameters

None

## Access Rights Required

Read, ReadWrite, or Admin

## Example

```
TERMINAL> exit
CLI> icim
ICIM> exit
CLI> module
/* MODULE> exit
CLI> terminal
TERMINAL>
```

## Related Commands

logout

# headers

## Syntax

headers digits

## Description

The **headers** command is used to enable or disable the display of column headers that may appear in CLI output. Column headers are enabled by default, but may be disabled and re-enabled using the headers command.

**Note:** This command does not affect the event log, which is always displayed without headers.

## Parameters

The **digits** parameter is 0 to disable header display, and 1 to enable header display.

## Access Rights Required

Read, ReadWrite, or Admin

## Examples

Headers are enabled (1) by default, as shown in the sample craft operator dialog below:

```
02/00 MODULE> show monitor conv*5*
  MODID  NAME      VALUE      UNITS
  02/00  ConvA+5   5.31409    V
  02/00  ConvA-5   -5.24671   V
  02/00  ConvB+5   5.30624    V
  02/00  ConvB-5   -5.26423   V

SUCCESS!
02/00 MODULE>
```

The following sample dialog shows how a craft operator might disable the column headers and confirm the change:

```
02/00 MODULE> exit
CLI> terminal
TERMINAL> headers 0
TERMINAL> exit
CLI> module modid 0200
SUCCESS!
CLI> module
```

## Chapter 6 Terminal Mode Commands

```
02/00 MODULE> show monitor conv*5*  
02/00 ConvA+5 5.31409 V  
02/00 ConvA-5 -5.24671 V  
02/00 ConvB+5 5.30624 V  
02/00 ConvB-5 -5.26423 V  
  
SUCCESS!  
02/00 MODULE>
```

## Related Commands

colsep

paging

pattern

show (Terminal mode)

# help

## Syntax

help modeOption

## Description

The **help** command is used alone to display onscreen help for all Terminal mode commands, or with a **modeOption** parameter to display help for a single command or function.

**Note:** Typing a question mark (?) character at the TERMINAL> command prompt gives the same result as typing help without a mode option parameter.

## Parameters

The possible values and results for the **modeOption** parameter are listed below.

<b>modeOption</b>	<b>Description</b>
<empty>	Displays onscreen help for all recognized Terminal mode commands.
<commandname>	Displays onscreen help for the specified command, if recognized.
edit	Displays onscreen help for command line editing and syntax.
commands	Displays onscreen help for global commands (exit, help, who, whoami).

## Access Rights Required

Read, ReadWrite, or Admin

## Example

```
TERMINAL> help

terminal      - Enter terminal mode
alarm         - Display active alarms for all modules
colsep        - Set the separation character used in the CLI output
headers       - Enable/disable the display of column headers in the CLI
logout        - Log off this system
manual        - Show detailed help text
paging        - Set the paging behavior for long CLI output
pattern       - Set the pattern matching style used in the CLI
show          - Display the current values for the terminal states
```

```
TERMINAL>
```

## Related Commands

help (CLI command mode)

help (Module command mode)

help (ICIM command mode)

# logout

## Syntax

logout

## Description

The **logout** command is used to terminate the current CLI session. This command is available in every command mode.

### Important:

- For Telnet operation, the computer you are using must have a network connection through which it can reach the ICIM2 via its IP address.
- No more than four Telnet sessions are allowed at one time.



### CAUTION:

Always use the Logout command to close a serial port or Telnet CLI session. Closing a serial port session without issuing the Logout command leaves the session open for a possible future connection. This may allow unauthorized access by a new user if the previous user had a higher authorization privilege level.

## Parameters

None

## Access Rights Required

Read, ReadWrite, or Admin

## Example

```
TERMINAL> logout
connection to host lost
C:\>
```

## Related Commands

exit

# manual

## Syntax

manual

## Description

The **manual** command is used to display onscreen instructions for Terminal command mode, or for another command mode if specified while another command mode is active.

## Parameters

None

## Access Rights Required

Read, ReadWrite, or Admin

## Example

```
TERMINAL> manual
```

```
Try one of these help commands for details on specific modes:
```

```
  module manual
  terminal manual
  icim manual
```

```
General Hints:
```

```
Keywords can be abbreviated to a unique prefix. For instance
in CLI mode, the keyword 'MODULE' can be given as just 'm'
or 'mod'.
```

```
Use TAB to autocomplete a keyword.
Use ? to list expected keywords or tokens (depends on previous input).
Use BACKSPACE to erase previous characters.
Use 'help edit' to display more editing commands
```

```
Use Alarm in any mode to get a list of active alarms. When in Module
mode, you can also narrow the list of active alarms to just those in
the current ModSpec range. See the Module Help for further details.
```

```
Note: entering a mode command (MODULE, ICIM, TERMINAL) enters that mode
immediately but it is not indicated until the next prompt is displayed.
```

```
The interface uses modes: CLI, MODULE, TERMINAL, and ICIM. The prompt
reflects the current mode. Enter the mode name to enter that mode, and
use EXIT to leave the mode and return to CLI mode.
```

```
To enter TERMINAL mode, just enter TERMINAL and newline.
```

```
Use Exit to leave Terminal mode, or Logout to exit the CLI interface
```

```
All keywords and parameters are caseless. That is, TeRmInAl == TERMINAL ==
terminal
```



## Terminal Commands:

## alarm

Use the 'alarm' command to show all the current alarms. This command works in all modes.

## colsep

Use the 'colsep' command to set the separation character used in the CLI output. When the display is being parsed automatically rather than by a craft operator, it may be more useful to have columns that have a fixed character as a separator. The default separator would have a typical module control display like this:

```
MODID  NAME      SETTING  UNITS
01/09  ServiceA  Off (0)
```

while setting the separator to a comma would have this display:

```
MODID,NAME,SETTING,UNITS
01/09,ServiceA,Off (0)
```

## exit

Use the 'exit' command to return to CLI mode. This command must be used before entering ICIM or MODULE mode.

## headers

Use the 'headers' command to enable or disable the display of column headers in the CLI. By default, headers are enabled.

## logout

Use the 'logout' command to logout of the CLI session. If the session is a telnet session, it will be closed. If the session is the local console port, the login prompt will be given.

## manual

Use the 'manual' command to display this help.

## paging

Use the 'paging' command to set the paging behavior for long CLI output. The command parameter specifies the number of lines to display on a single page. Once that number of lines is reached, the user is asked to hit a key to continue with the next page. Setting the parameter to 0 will disable paging and all CLI output will be displayed as a single page.

## pattern

Use the 'pattern' command to set the pattern matching style used in the CLI. Valid selections are regex or wildcard (default).

## show

Use the 'show' command to display the current values for the terminal settings for colsep, headers, paging and pattern parameters.

TERMINAL>

## Related Commands

manual (CLI command mode)

manual (ICIM command mode)

manual (Module command mode)

help

## paging

### Syntax

`paging digits`

### Description

The **paging** command is used to control paging behavior for long CLI output.

When paging is enabled in CLI, a feature called Smart Paging attempts to determine the best Telnet window size automatically. If it cannot do so, Smart Paging uses the number of lines specified in the Paging command as the Telnet window size. Smart Paging has no effect when paging is disabled.

### Parameters

The **digits** parameter is zero (0) to disable paging completely, or a number to specify the height of the paging window in lines of text.

### Access Rights Required

Read, ReadWrite, or Admin

### Examples

With paging enabled, CLI output too long to fit in a single 24-line Telnet window is automatically paged using the “more” format shown below.

```
CLI> module modid * exit
SUCCESS!
CLI>
CLI> module show control * exit
```

MODID	NAME	SETTING	UNITS
01/00	AlmMuteA	Off (0)	
01/00	AlmMuteB	Off (0)	
01/01	Enable	1	
01/01	CwMode	0	
01/01	LoRFInh	0	
01/01	Master	Master (1)	
01/01	RFDrive	0	dB
01/01	AGC	0	
01/15	Enable	1	
01/15	LoRFInh	0	
01/15	Master	Master (1)	
01/15	RFDrive	0	dB
01/15	AGC	0	
01/15	FibLinDi	35	km
01/15	Dither	1	
02/00	AlmMuteA	Off (0)	
02/00	AlmMuteB	Off (0)	
02/03	Mode	Single (1)	
02/03	Mute	Off (0)	
02/03	Attn	0	dB
02/03	NomPwr	0	dBm
02/03	NomRF	0	dBm
02/03	Alarm	Off (0)	

Press any key to continue (Q to quit)

You can then either press any key to display the next page of output, or press **Q** to stop the flow of output.

While craft operators can be expected to understand the message "Press any key to continue (Q to quit)," an element management system may have difficulty parsing this output format. The **paging** command can address this problem by turning off all paging, as shown below.

```
CLI> terminal paging 0 exit
```

```
SUCCESS!
CLI>
```

```
CLI> module modid * exit
```

```
SUCCESS!
CLI>
```

```
CLI> module show control * exit
```

## Chapter 6 Terminal Mode Commands

MODID	NAME	SETTING	UNITS
01/00	AlmMuteA	Off (0)	
01/00	AlmMuteB	Off (0)	
01/01	Enable	1	
01/01	CwMode	0	
01/01	LoRFInh	0	
01/01	Master	Master (1)	
01/01	RFDrive	0	dB
01/01	AGC	0	
01/15	Enable	1	
01/15	LoRFInh	0	
01/15	Master	Master (1)	
01/15	RFDrive	0	dB
01/15	AGC	0	
01/15	FibLinDi	35	km
01/15	Dither	1	
02/00	AlmMuteA	Off (0)	
02/00	AlmMuteB	Off (0)	
02/03	Mode	Single (1)	
02/03	Mute	Off (0)	
02/03	Attn	0	dB
02/03	NomPwr	0	dBm
02/03	NomRF	0	dBm
02/03	Alarm	Off (0)	
02/03	WaveLen	1310nm (0)	
02/12	Mode	Single (1)	
02/12	Mute	Off (0)	
02/12	Attn	0	dB
02/12	NomPwr	0	dBm
02/12	NomRF	0	dBm
02/12	Alarm	Off (0)	
02/12	WaveLen	1310nm (0)	
03/00	AlmMuteA	Off (0)	
03/00	AlmMuteB	Off (0)	
03/02	Mode	Master (1)	
03/02	Enable1	On (1)	
03/02	Enable2	On (1)	
03/02	Mute1	Off (0)	
03/02	Mute2	Off (0)	
03/02	Attn1	0	dB
03/02	Attn2	0	dB
03/02	NomPwr1	0	dBm
03/02	NomPwr2	0	dBm
03/02	Alarm	Off (0)	
03/02	WaveLen1	1310nm (0)	
03/02	WaveLen2	1310nm (0)	
03/06	Mode	Master (1)	
03/06	Enable1	On (1)	
03/06	Enable2	On (1)	
03/06	Mute1	Off (0)	
03/06	Mute2	Off (0)	
03/06	Attn1	0	dB
03/06	Attn2	0	dB
03/06	NomPwr1	0	dBm
03/06	NomPwr2	0	dBm
03/06	Alarm	Off (0)	
03/06	WaveLen1	1310nm (0)	
03/06	WaveLen2	1310nm (0)	
03/11	Mode	Master (1)	
03/11	Enable1	On (1)	
03/11	Enable2	On (1)	
03/11	Mute1	Off (0)	
03/11	Mute2	Off (0)	
03/11	Attn1	0	dB
03/11	Attn2	0	dB
03/11	NomPwr1	0	dBm
03/11	NomPwr2	0	dBm
03/11	Alarm	Off (0)	
03/11	WaveLen1	1310nm (0)	
03/11	WaveLen2	1310nm (0)	
03/16	Mode	Master (1)	
03/16	Enable1	On (1)	
03/16	Enable2	On (1)	
03/16	Mute1	Off (0)	
03/16	Mute2	Off (0)	
03/16	Attn1	0	dB

```

03/16 Attn2      0          dB
03/16 NomPwr1   0          dBm
03/16 NomPwr2   0          dBm
03/16 Alarm     Off (0)
03/16 WaveLen1  1310nm (0)
03/16 WaveLen2  1310nm (0)
98/00 AlmMuteA Off (0)
98/00 AlmMuteB Off (0)
98/04 Enable    1
98/04 CwMode    0
98/04 LoRFInh  1
98/04 Master    Master (1)
98/04 RFDrive   0          dB
98/04 AGC       0
98/05 Enable    1
98/05 CwMode    0
98/05 LoRFInh  0
98/05 Master    Master (1)
98/05 RFDrive   0          dB
98/05 AGC       0
98/09 Enable    1
98/09 CwMode    0
98/09 LoRFInh  0
98/09 Master    Master (1)
98/09 RFDrive   0          dB
98/09 AGC       0
98/10 Enable    1
98/10 CwMode    0
98/10 LoRFInh  0
98/10 Master    Slave (0)
98/10 RFDrive   0          dB
98/10 AGC       0
98/11 Enable    1
98/11 CwMode    0
98/11 LoRFInh  0
98/11 Master    Master (1)
98/11 RFDrive   0          dB
98/11 AGC       0
98/14 Enable    1
98/14 CwMode    0
98/14 LoRFInh  0
98/14 Master    Master (1)
98/14 RFDrive   0          dB
98/14 AGC       0
98/15 Enable    1
98/15 CwMode    0
98/15 LoRFInh  0
98/15 Master    Master (1)
98/15 RFDrive   0          dB
98/15 AGC       0

```

SUCCESS!  
CLI>

The **paging 0** setting can be useful in allowing an element management system or other interacting program to capture all CLI output at once.

## Related Commands

colsep

headers

pattern

show (Terminal mode)

# pattern

## Syntax

pattern patternStyle

## Description

The **pattern** command is used to select one of two pattern matching styles for the names of monitor, control, and alarm parameters. This setting controls whether CLI supports Windows style pattern matching (which includes the \* wildcard character as well as ? and [xyz] patterns) or POSIX regular expression (regex) pattern matching as used in many Unix and Perl programs.

The default is Windows-style or **wildcard** pattern matching. The **regex** style includes a much more powerful but also more complex pattern matching format. While a full description of regex pattern matching is beyond the scope of this document, a good overview of the subject is available via the public internet at:

- [http://en.wikipedia.org/wiki/Regular\\_expression](http://en.wikipedia.org/wiki/Regular_expression)

More detailed information is available via links at the end of the above article. For additional details, see other resources available on the internet for Perl or Boost, such as:

- <http://perldoc.perl.org/>
- <http://www.boost.org/libs/regex/doc/syntax.html>

## Parameters

The **patternStyle** parameter can have one of two values:

<b>patternStyle</b>	<b>Description</b>
wildcard	Standard Windows-style wildcard pattern matching.
regex	POSIX regular expression pattern matching.

## Access Rights Required

Read, ReadWrite, or Admin

## Examples

When the default Windows-style wildcard pattern matching is in effect, CLI interprets wildcards as shown in the following sample dialogs.

```
02/00 MODULE> show monitor conv*

  MODID  NAME          VALUE      UNITS
  02/00  ConvA+24      24.0797    V
  02/00  ConvA+5        5.31409    V
  02/00  ConvA-5        -5.25547   V
  02/00  ConvB+24      24.1148    V
  02/00  ConvB+5        5.30624    V
  02/00  ConvB-5       -5.26423   V
  02/00  ConvAIns      Yes (1)
  02/00  ConvBIns      Yes (1)

SUCCESS!
02/00 MODULE> show monitor conv*5*

  MODID  NAME          VALUE      UNITS
  02/00  ConvA+5        5.31409    V
  02/00  ConvA-5       -5.24671   V
  02/00  ConvB+5        5.30624    V
  02/00  ConvB-5       -5.26423   V

SUCCESS!
02/00 MODULE>
```

## Related Commands

colsep

headers

paging

show (Terminal mode)

## show

### Syntax

show

### Description

The **show** command is used to display the current values for the **colsep**, **headers**, **paging**, and **pattern** terminal states.

### Parameters

None

### Access Rights Required

Read, ReadWrite, or Admin

### Example

A typical response to this command is shown in the following sample craft operator dialog.

```
TERMINAL> show
Terminal Settings:
    COLSEP  ""
    PAGING  25 LINES PER PAGE (WINDOW)
    PATTERN WILDCARD
    HEADERS 1 (Enabled)
SUCCESS!
TERMINAL>
```

### Related Commands

colsep

headers

paging

pattern



# 7

---

## Web Interface

### Introduction

This chapter describes the features and operation of the Web Interface for the ICIM2 with Firmware Release 2.02.10.

### In This Chapter

■ Introduction.....	162
■ Installation .....	164
■ Web Browser Setup .....	165
■ Login and Logout .....	167
■ Using System View.....	171
■ Using ICIM Details .....	174
■ Using Module Details.....	177
■ Using System Settings .....	185
■ Using the Event Log .....	189
■ User Management.....	191
■ Web Interface Help.....	194

## Introduction

The Web Interface for the ICIM2 is a set of HTML pages hosted by the web server in the ICIM2. These pages display information about the ICIM2 and other modules in its domain. These pages also allow authorized users to adjust certain parameter values.

Users navigate and interact with the Web Interface through the use of menus and hyperlinks, just as with a typical web site. This chapter describes the steps for logging in and navigating the Web Interface and for using each of its screens.

The Web Interface provides a subset of CLI functionality using SNMP as the underlying communication protocol. However, use of the Web Interface requires no knowledge of either SNMP or CLI. For the benefit of users already familiar with SNMP or CLI, this chapter includes tables that identify the command equivalent(s) for elements of the Web Interface.

**Note:** For these pages to work properly, both JavaScript and cookies must be enabled in your web browser.

## Web Browsers Supported

The Web Interface is designed for compatibility with the following web browsers.

- Mozilla for Unix or Linux, version 1.7
- Microsoft Internet Explorer for Windows, version 6

Other browsers are potentially compatible, but are not officially supported.



**CAUTION:**

**Always log out of the Web Interface before closing the browser. Use the Logout link at the bottom of the navigation pane on the left side of the page.**

**Closing the browser or browser tab in which the Web Interface session is running before logging out causes the session to "hang" open for the duration of a timeout interval. This may prevent access to the ICIM2 via the CLI or Web Interface by you or other users. This may also create a security breach by enabling unauthorized users to access the Web Interface at the previous user authorization level simply by opening a new browser tab.**

## Information Color Code

The following color coding scheme is used throughout all pages of the Web Interface.

- Items shown in red signal conditions that require prompt user attention.
- Items shown in blue are links to pages with more details.
- Items shown in black signal normal conditions or values falling within nominal limits.

## Online Help

Help is accessible from within the application. The Help page provides general help on the application itself. The information it contains is essentially a condensed version of the information in this chapter.

**Note:** For security reasons, users may not have access to every page of the Web Interface. If a particular page is unavailable to a user because of access level (Read Only, ReadWrite, or Admin), the corresponding Help section may also be unavailable.

## Installation

The Web Interface is already resident in the ICIM2 firmware. All that is needed for access is to install an appropriate web browser and point it to the ICIM2 IP address. Your system administrator can provide the IP address for this page in your installation.

**Note:** The current system release supports Mozilla for Unix or Linux, Version 1.7 and Microsoft Internet Explorer for Windows, Version 6.

### To Install the Web Interface for Windows

To download the instructions for installing Internet Explorer 6 for Windows, use your current browser to access the links for installation provided at <http://www.microsoft.com>.

### To Install the Web Interface in Solaris

To download the instructions for installing Mozilla 1.7 on Sparc Workstations (Solaris 8 and 9), use your current browser to access the links for installation provided at <http://www.mozilla.org>.

## Web Browser Setup

Before logging in, you must set up the web browser for compatibility with the Web Interface. This involves:

- Enabling support for JavaScript
- Allowing cookies to be set
- Disabling auto-complete

Procedures for web browser setup are provided below for each of the supported web browsers.

### Setup for Mozilla 1.7

Complete the following steps to set up Mozilla 1.7 for compatibility with the Web Interface.

#### Enable JavaScript Support

- 1 On the browser menu bar, select **Edit | Preferences**.
- 2 Double-click **Advanced** in the left pane.
- 3 Check the **Enable Java** checkbox.
- 4 Click **Scripts & Plugins** in the left pane.
- 5 Check the **Navigator** checkbox.
- 6 Click **OK**, and then close the window.
- 7 Reload the page.

#### Allow for Cookies

- 1 From the Tools menu, click **Cookies Manager**.
- 2 Select one of the following options that allow Mozilla to accept cookies:
  - Use default cookie permissions
  - Allow cookies from this site
- 3 Close the window.
- 4 Reload the page.

#### Disable Auto-Complete

- 1 On the browser menu bar, select **Edit | Preferences**.
- 2 Select **Privacy & Security** from the Categories tree in the left pane.
- 3 Expand the tree item, and then select **Passwords**.
- 4 Clear the **Remember passwords** checkbox in the password manager box.

## Setup for Internet Explorer 6

Complete the following steps to set up Internet Explorer 6 for compatibility with the Web Interface.

### Enable JavaScript Support

- 1 Select **Tools | Internet Options**.
- 2 Click the **Security** tab.
- 3 Click the **Custom Level** button.
- 4 Scroll down to the **Scripting** section.
- 5 Select **Enable** for all three scripting categories.
- 6 Click **OK**.
- 7 If a message appears asking you to confirm your selections, click **Yes**.
- 8 Click **OK**, and then close the window.
- 9 Reload the page.

### Allow for Cookies

- 1 Select **Tools | Internet Options**.
- 2 Click the **Privacy** tab.
- 3 Move the slide bar to the **middle** notch.
- 4 Click **OK**.
- 5 If a message appears asking you to confirm your selections, click **Yes**.
- 6 Click **OK**, and then close the window.
- 7 Reload the page.

### Disable Auto-Complete

- 1 On the browser main menu bar, select **Tools | Internet Options**.
- 2 Select the **Content** tab, and then press the **Auto-complete** button.
- 3 Clear the checkbox for using **Auto-complete for username and passwords on forms**.

## Login and Logout

To use the Web Interface, you must enter a valid user name and password. The default user name and password are given below.

- User name: **Administrat0r**
- Password: **AdminPassw0rd**

### Notes:

- Both the default user name and the default password have a zero (0) in place of the expected "o" character.
- For security reasons, it is recommended that the default user name be changed immediately. For additional information, see **User Management** in the *Prisma II™ XD Platform System Guide*, part number 4021339.

## To Log In

Complete the following steps to log into the ICIM2.

- 1 Confirm that your web browser is set up as described in *Web Browser Setup* (on page 165).
- 2 Obtain the actual IP address of the Web Interface Login page from your system administrator.
- 3 Open your web browser and type the IP address of the ICIM2 (e.g., **172.24.25.175**) in the browser address bar.

- 4 Press the **Enter** key or click the **Go** button. The ICIM Login page appears as shown below.

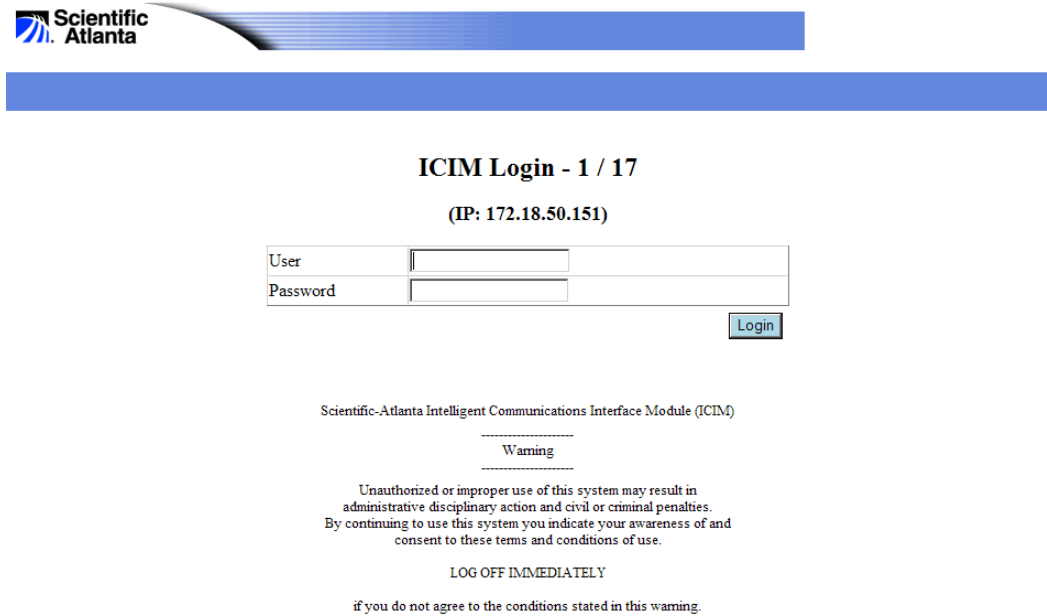

TP447

- 5 Type your **User** name and **Password** in the fields provided, and then click the **Login** button. The ICIM Welcome page appears as shown below.

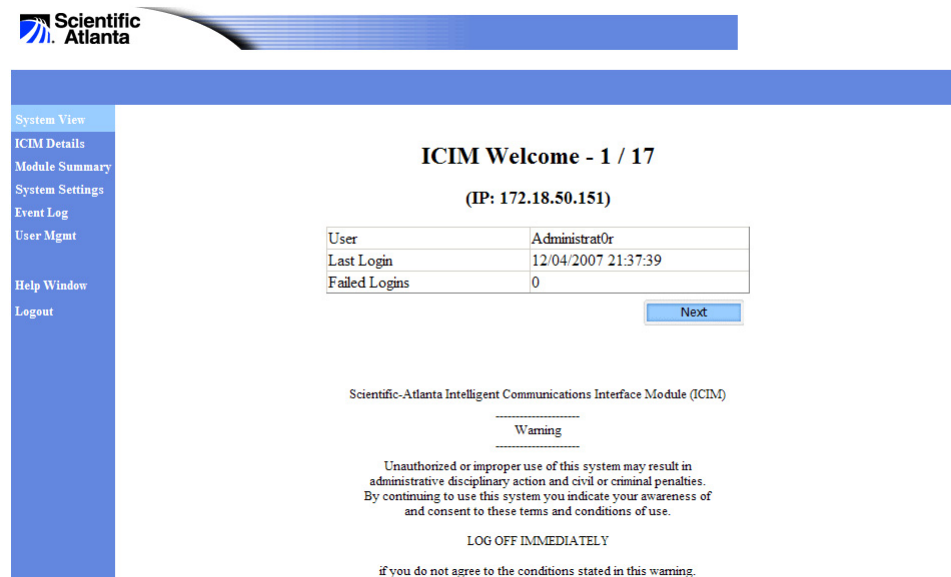

TP448

- 6 Use one of the following navigation methods as appropriate:
  - Click **Next** to go to the System View page. Or, wait 10 seconds to be taken to System View automatically.
  - Use the menu at the left of the screen to go directly to System View or to choose another page of interest.



**CAUTION:**

Always log out of the Web Interface before closing the browser. Use the Logout link at the bottom of the navigation pane on the left side of the page.

Closing the browser or browser tab in which the Web Interface session is running before logging out causes the session to "hang" open for the duration of a timeout interval. This may prevent access to the ICIM2 via the CLI or Web Interface by you or other users. This may also create a security breach by enabling unauthorized users to access the Web Interface at the previous user authorization level simply by opening a new browser tab.

## To Log Out

Complete the following steps to log out of the Web Interface.

- 1 Click **Logout** in the main menu. The Web Interface Logout page appears as shown below.



**You are now logged out**

Please close your browser for security

[Login to ICIM](#)

TP449

- 2 Close your browser window as a security precaution.

**CAUTION:**

Always log out of the Web Interface before closing the browser. Use the Logout link at the bottom of the navigation pane on the left side of the page.

Closing the browser or browser tab in which the Web Interface session is running before logging out causes the session to "hang" open for the duration of a timeout interval. This may prevent access to the ICIM2 via the CLI or Web Interface by you or other users. This may also create a security breach by enabling unauthorized users to access the Web Interface at the previous user authorization level simply by opening a new browser tab.

## To Change Login Defaults

Complete the following steps to change the default user name and password.

- 1 Add a new user having Admin Level privileges.
- 2 Log out of the default user account, and then log back in using the new Admin level account.
- 3 Locate the original default user name in the list of users. Click the **Delete** button beside the default user name to delete it from the list.

**Important:** Note your new login defaults for future reference. Failure to remember your new user ID and password may result in being locked out of the ICIM2 permanently. You cannot revert to the default user name and password once they are deleted.

## Using System View

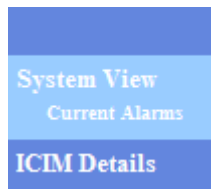

The System View page displays manufacturing information for the ICIM2 and selected modules. System View also allows you to view the current alarms for the ICIM2 and any application modules in the domain.

### To View ICIM Information

The default selection, System View, displays the following information about the ICIM2:

#### **ICIM Information** [\(details\)](#)

Chassis / Slot	1 / 17
IP Address	172.18.50.151
Serial Number	~AAVGTHZ
CLLI Code	ICIM01
<b>Alarm Count</b>	<a href="#">2 Alarms</a>
sysLocation	SVT-LAB
Domain Size	68

**TP450**

This table contains at least one, and possibly two, hyperlinks to other pages of the interface.

- Clicking the **details** link in the title takes you to the ICIM Details screen.
- Clicking the **Alarm Count** link when alarms are active takes you to the Current Alarms table.

These pages are described in later sections of this chapter.

## To View Module Summary

The Module Summary table at the bottom of the System View page lists the modules in the ICIM2 domain and identifies their chassis and slot locations, module types (if reported by the module) and devtypes, and the number of alarms currently active.

### Module Summary

Chassis/Slot	Module Name	Mod Type	Dev Type	Alarms	Details
1/0	XD-Chassis		5020	0	<a href="#">Details</a>
1/1	HDTx	03dBm TS	1020	0	<a href="#">Details</a>
1/2	HDTx	3dBm TXTS 1310 nm	1020	1	<a href="#">Details</a>
1/3	HDTx	3dBm TXTS 1310 nm	1020	0	<a href="#">Details</a>
1/4	HDTx	3dBm TXTS 1310 nm	1020	0	<a href="#">Details</a>
1/5	HDTx		1032	0	<a href="#">Details</a>
1/6	HDTx		1032	0	<a href="#">Details</a>
1/7	HDTx		1032	0	<a href="#">Details</a>
1/8	HDTx		1032	0	<a href="#">Details</a>
1/9	HDTx		1032	1	<a href="#">Details</a>
1/10	HDTx		1032	0	<a href="#">Details</a>
1/11	HDTx		1032	0	<a href="#">Details</a>
1/12	HDTx		1032	0	<a href="#">Details</a>
1/13	HDTx		1032	0	<a href="#">Details</a>
1/14	HDTx		1032	0	<a href="#">Details</a>
1/15	HDTx		1032	0	<a href="#">Details</a>
1/16	HDTx		1032	0	<a href="#">Details</a>

TP451

**Note:** Clicking the **Details** link for a particular module displays the Module Details page, described in a later section.

## To View Current Alarms

To view current alarms in the system, click the **Current Alarms** submenu item.

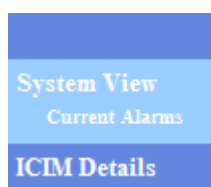

The Current Alarms page appears, displaying any active alarms in a table similar to the one shown below.

### Current Alarms

Chas / Slot	Label	Time	Description
1/2	InRF	Tue, 04 Dec 2007 05:48:58 EST	Module=HDTx, Model=1020
1/9	InRF	Tue, 04 Dec 2007 05:49:07 EST	Module=HDTx, Model=1032

TP452

In this table:

- Chas/Slot is the number of the chassis and slot in which the module is located.
- Label is the name of the alarm.
- Time is the time at which the module went into alarm.
- Description is the module description.

**Note:** When troubleshooting alarms, additional diagnostic information is available from the System Settings and the Event Log pages. These pages are described later in this chapter.

## Using ICIM Details

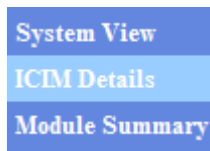

Clicking the ICIM Details menu option displays the ICIM Details screen. This screen includes two kinds of information:

- A Time and Date stamp shows when the page was last updated.
- An ICIM Details table displays various ICIM2 parameters.

### Time and Date Stamp

The Time and Date stamp shows the time that the screen on which it appears was last updated. To view the most recent information, you must update the page by choosing the **Refresh** option in your browser.

#### ICIM Details

Real Time Clock (RTC) 12/04/2007 21:50:09 EST TP453

The Time and Date stamp shows the current time zone in abbreviated form. Time zone abbreviations are listed below for reference.

Abbreviation	Time Zone
EST	Eastern Standard Time
EDT	Eastern Daylight Time
CST	Central Standard Time
CDT	Central Daylight Time
MST	Mountain Standard Time
MDT	Mountain Daylight Time
PST	Pacific Standard Time
PDT	Pacific Daylight Time
AST	Alaska Standard Time
ADT	Alaska Daylight Time
HST	Hawaii-Aleutian Standard Time
HDT	Hawaii-Aleutian Daylight Time

**Note:** If a time zone is not entered, the default time zone "EST" appears.

## ICIM Details Table

The ICIM Details table lists the ICIM2 details that are most commonly referred to for system configuration and maintenance.

### ICIM Details

Real Time Clock (RTC)	12/04/2007 21:50:09 EST
Chassis / Slot	1 / 17
Domain Size	68
IP Address	172.18.50.151
IP Subnet Mask	255.255.255.0
IP Gateway	172.18.50.254
MAC Address	00:1a:c3:d0:55:1d
CLLI Code	<input type="text" value="ICIM01"/>
CLEI Code	
Manufacture Data	ICIM2
Serial Number	~AAVGTHZ
Hardware Revision	BdRev87A
Active Software Rev	92.02.10
Inactive Software Rev	N/A
Time Of Service	1843 Hours
Self Test Message	ICIM Self-test Passed
DownLoad Status	1
sysDescr	Scientific-Atlanta Prisma II ICIM2
sysUptime	16:01:41

TP454

## ICIM CLI and SNMP Equivalents

The information displayed on this page may also be seen by passing CLI commands to the ICIM2 or by viewing the MIB Objects via SNMP. The corresponding CLI commands and SNMP MIB Objects are listed below.

Web Interface Field Name	CLI Command	SNMP MIB Object
Real Time Clock (RTC)	ICIM> show clock	p2icimClock
Chassis / Slot	ICIM> info chassis slot	p2icimChassisID p2icimSlotID
Domain Size	ICIM> info size	p2icimDomainSize
IP Address	ICIM> info IP	p2icimIPAddr
IP Subnet Mask	ICIM> info subnet	p2icimSubnetMask
IP Gateway	ICIM> info gateway	p2icimGatewayAddr
MAC Address	ICIM> info MAC	p2icimMACAddr
CLLI Code	Reserved for future use.	Reserved for future use.
CLEI Code	Reserved for future use.	Reserved for future use.

<b>Web Interface Field Name</b>	<b>CLI Command</b>	<b>SNMP MIB Object</b>
Manufacture Data	ICIM> info mandata	p2manufactureData
Serial Number	ICIM> info serial	p2icimSerialNumber
Hardware Revision	ICIM> info hwrev	p2icimHardwareRevision
Active Software Rev	ICIM> info activerev	p2icimActiveCodeRevision
Inactive Software Rev	Reserved for future use.	Reserved for future use.
Time Of Service	ICIM> info TOS	p2icimTimeOfService
Self Test Message	ICIM> info selftest	p2icimSelfTest
DownLoad Status	ICIM> info downldstate	p2icimDownLdState
sysDescr	na	MIB-2: sysDescr
sysUptime	na	MIB-2: sysUpTime

For additional information, see the *Prisma II™ XD Platform System Guide*, part number 4021339.



## Using Module Details

ICIM Details  
 Module Summary  
 System Settings

Clicking the **Module Summary** menu option navigates to the lower portion of the System View screen, which contains the list of modules in the ICIM2 domain.

**Note:** In a daisy-chained system, you may have to scroll the page to view all of the chassis and their modules.

### Module Summary

Chassis/Slot	Module Name	Mod Type	Dev Type	Alarms	Details
1/0	XD-Chassis		5020	0	<a href="#">Details</a>
1/1	HDTx	03dBm TS	1020	0	<a href="#">Details</a>
1/2	HDTx	3dBm TXTS 1310 nm	1020	1	<a href="#">Details</a>
1/3	HDTx	3dBm TXTS 1310 nm	1020	0	<a href="#">Details</a>
1/4	HDTx	3dBm TXTS 1310 nm	1020	0	<a href="#">Details</a>
1/5	HDTx		1032	0	<a href="#">Details</a>
1/6	HDTx		1032	0	<a href="#">Details</a>
1/7	HDTx		1032	0	<a href="#">Details</a>
1/8	HDTx		1032	0	<a href="#">Details</a>
1/9	HDTx		1032	1	<a href="#">Details</a>
1/10	HDTx		1032	0	<a href="#">Details</a>
1/11	HDTx		1032	0	<a href="#">Details</a>
1/12	HDTx		1032	0	<a href="#">Details</a>
1/13	HDTx		1032	0	<a href="#">Details</a>
1/14	HDTx		1032	0	<a href="#">Details</a>
1/15	HDTx		1032	0	<a href="#">Details</a>
1/16	HDTx		1032	0	<a href="#">Details</a>

TP455

### To View Module Details

When you click **Details** in the Module Summary table in System View, the Module Details screen for the corresponding module appears, as shown in the example below.

**Note:** When viewing module details, always use the links provided on the Module Details screen. Attempts to access this information by editing the URL in the browser address bar may cause unexpected results.

## Module Details

Chassis/Slot	1/0
Module Name	XD-Chassis
Module Type	
Device Type	5020
Serial Number	^ABCDEFGF
Time Of Service	38 hours
Downloadable	Yes
CLLI Code	<input type="text" value="N/A"/>
CLEI Code	N/A
Self Test Message	Passed
Active Code Revision	1.01.05
Inactive Code Revision	1.01.04



### TP456

When the Module Details screen appears, a submenu lets you select Alarms, Thresholds, Controls, and Monitors for the module.

Module Summary
Module Details
Alarms
Thresholds
Controls
Monitors
System Settings

Each of these options is described below.

## To View Alarms

To view the status of all alarms for the chosen module, click the **Alarms** submenu option. The Alarm Status table appears as shown below.

### Alarm Status

**XD-Chassis**  
**(Chassis/Slot: 1/0)**

Label	Value	Type
Fan1_Ok	0 (ok)	6
Fan2_Ok	0 (ok)	6
Fan3_Ok	0 (ok)	6
ChasTemp	2 (ok)	2
ConvAIn	0 (ok)	5
ConvA+24	2 (ok)	2
ConvA+5	2 (ok)	2
ConvA-5	2 (ok)	2
ConvBIn	0 (ok)	5
ConvB+24	2 (ok)	2
ConvB+5	2 (ok)	2
ConvB-5	2 (ok)	2

**TP457**

## To View Thresholds

To view the current threshold values for all alarms for the chosen module, click the **Thresholds** submenu option. The Module Alarm Thresholds table appears as shown below.

### Module Alarm Thresholds

XD-Chassis  
(Chassis/Slot: 1/0)

Label	Type	Major Low	Minor Low	Value	Nominal	Minor High	Major High	Hysteresis	Range Low	Range High	
Fan1_Ok	6	N/A	N/A	0 (ok)	1	N/A	N/A	N/A	N/A	N/A	
Fan2_Ok	6	N/A	N/A	0 (ok)	1	N/A	N/A	N/A	N/A	N/A	
Fan3_Ok	6	N/A	N/A	0 (ok)	1	N/A	N/A	N/A	N/A	N/A	
ChasTemp	2	-40	-35	2 (ok)	25	60	65	1	-32768	32767	Apply
ConvAln	5	N/A	N/A	0 (ok)	1	N/A	N/A	N/A	N/A	N/A	
ConvA+24	2	18	18.4	2 (ok)	24.7	25.9	26.1	0.1	-3276.8	3276.7	Apply
ConvA+5	2	3.6	3.7	2 (ok)	5.4	5.9	6.1	0.1	-3276.8	3276.7	Apply
ConvA-5	2	-5.6	-5.5	2 (ok)	-5.4	-4.6	-4.5	0.1	-3276.8	3276.7	Apply
ConvBln	5	N/A	N/A	0 (ok)	1	N/A	N/A	N/A	N/A	N/A	
ConvB+24	2	18	18.4	2 (ok)	24.7	25.9	26.1	0.1	-3276.8	3276.7	Apply
ConvB+5	2	3.6	3.7	2 (ok)	5.4	5.9	6.1	0.1	-3276.8	3276.7	Apply
ConvB-5	2	-5.6	-5.5	2 (ok)	-5.4	-4.6	-4.5	0.1	-3276.8	3276.7	Apply

Cancel

TP458

If any of the alarms have user-adjustable threshold values, these values are shown in ruled fields to indicate that they are editable.

- To change a threshold value, click inside the field, type the desired value, and then either click the **Apply** button to the right of the row containing the field. Or, you may press **Enter** to invoke the changes on that row immediately.
- To abort the change, click the **Cancel** button before clicking Apply. Clicking Cancel reloads the page, discarding any unapplied changes.

**Note:** Clicking Apply updates all fields in the corresponding row. For this reason, double-check the values in all editable fields before applying changes.

After you click Apply, a popup window appears asking you to confirm the save operation:

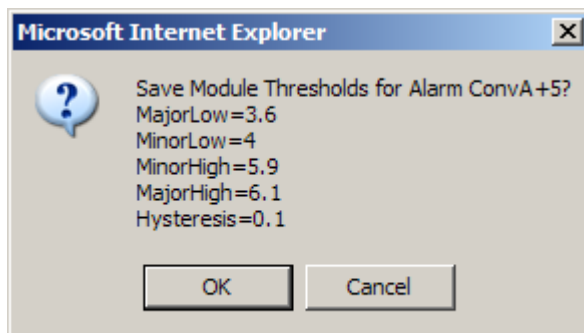

TP459

Click **OK** to confirm, or click **Cancel** to abort.

## To View Controls

To review the control parameters for the chosen module, click the **Controls** submenu option. The Module Controls table appears as shown below.

### Module Controls

XD-Chassis  
(Chassis/Slot: 1/0)

Label	Value	Units / Choices	Low	High	Step	
AlmMuteA	<input type="text" value="0"/>	(0) Off, (1) On	0	1	1	Apply
AlmMuteB	<input type="text" value="0"/>	(0) Off, (1) On	0	1	1	Apply

Cancel

TP460

If any of the control parameters have user-adjustable threshold values, these values are shown in ruled fields to indicate that they are editable.

- To change a control value, click inside the field, type the desired value, and then either click the **Apply** button to the right of the row containing the field. Or, you may press **Enter** to invoke the changes on that row immediately.
- To abort the change, click the **Cancel** button before clicking Apply. Clicking Cancel reloads the page, discarding any unapplied changes.

**Note:** Clicking Apply updates all fields in the corresponding row, so double-check the values in all editable fields before applying changes.

After you click Apply, a popup window appears asking you to confirm the save operation:

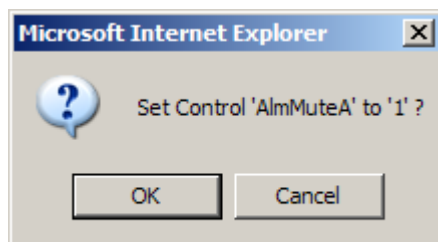

TP461

Click **OK** to confirm, or click **Cancel** to abort.

## To View Monitors

To review the monitor parameters for the chosen module, click the **Monitors** submenu option. The Module Monitors table appears as shown below.

### Module Monitors

**XD-Chassis**  
(Chassis/Slot: 1/0)

Label	Value	Units
ConvA+24	24.185	V
ConvA+5	5.28269	V
ConvA-5	-5.27299	V
ConvB+24	24.0095	V
ConvB+5	5.27484	V
ConvB-5	-5.2905	V
PSA_Inst	1	N/A
PSB_Inst	1	N/A
ConvAIns	1	N/A
ConvBIns	1	N/A
Chas+24V	24.1177	V
Chas+5V	5.0277	V
Chas-5V	-4.93157	V
ChasTemp	27	degC

TP462

#### Notes:

- The Module Monitors table is read-only.
- Although this table may display 6 or more decimal digits of precision, only 3 or 4 digits of precision are actually available. Thus, for example, 24.0095 V is really 24.01 V.

## Module CLI and SNMP Equivalents

The information displayed on the Module Details pages of the Web Interface may also be seen by entering CLI commands in the ICIM2 or by viewing the MIB Objects via SNMP. The corresponding CLI command(s) and MIB Object(s) for each field in the Module Details pages are listed below.

## Module Details

<b>Web Interface Field Name</b>	<b>CLI Command (for module in chassis 3, slot 7)</b>	<b>SNMP MIB Object (P2moduleTable)</b>
Chassis / Slot	<code>*/* module&gt; modid 0307</code> <code>03/07 module&gt;</code>	p2chassisID p2slotID
Module Name	<code>03/07 module&gt; info module name</code>	p2moduleName
Module Type	<code>03/07 module&gt; info module modtype</code>	p2manufactureData
Device Type	<code>03/07 module&gt; info module devtype</code>	p2moduleType
Serial Number	<code>03/07 module&gt; info module serial</code>	p2serialNumber
Time of Service	<code>03/07 module&gt; info module tos</code>	p2timeOfService
Downloadable	Reserved for future use.	Reserved for future use.
CLLI Code	Reserved for future use.	Reserved for future use.
CLEI Code	Reserved for future use.	Reserved for future use.
SelfTest Message	<code>03/07 module&gt; info module selftest</code>	p2moduleSelfTest
Active Software Revision	<code>03/07 module&gt; info module activerev</code>	p2activeCodeRevision
Inactive Software Revision	Reserved for future use.	Reserved for future use.

## Alarm Status

<b>Web Interface Field Name</b>	<b>CLI Command (for module in chassis 3, slot 7)</b>	<b>SNMP MIB Object (P2moduleAlarmTable)</b>
Module Details / Alarms	<code>03/07 module&gt; show alarmstate *</code>	p2almLabel p2almValue p2almType

## Module Alarm Thresholds

Web Interface Field Name	CLI Command (for module in chassis 3, slot 7)	SNMP MIB Object (P2moduleAlarmTable)
Module Details / Thresholds	03/07 module> show alarmparam * majorlow	p2almMajorLowLimit
	03/07 module> show alarmparam * minorlow	p2almMinorLowLimit
	03/07 module> show alarmparam * minorhigh	p2almMinorHighLimit
	03/07 module> show alarmparam * majorhigh	p2almMajorHighLimit
	03/07 module> show alarmparam * hysteresis	p2almHysteresis

## Module Controls

Web Interface Field Name	CLI Command (for module in chassis 3, slot 7)	SNMP MIB Table
Module Details / Controls	03/07 module> show control *	p2moduleControlTable

## Module Monitors

Web Interface Field Name	CLI Command (for module in chassis 3, slot 7)	SNMP MIB Table
Module Details / Monitors	03/07 module> show monitor *	p2moduleMonitorTable

## Current Alarms

Web Interface Field Name	CLI Command (for module in chassis 3, slot 7)	SNMP MIB Table
Current Alarms	03/07 module> alarm	p2moduleCurrentAlarmTable

For additional information, see the *Prisma II™ XD Platform System Guide*, part number 4021339.



## Using System Settings

Module Summary
System Settings
Login Settings
Event Log
SNMP Traps
Event Log

The System Settings page allows users with Admin privileges to review and, where possible, change settings that control login functionality, the event log, and SNMP traps.

To change any of these settings, click in the appropriate field and type the desired setting.

- To save the changes, click the **Apply** button beneath the settings table, or press **Enter**.
- To cancel an entry and restore the previous setting, click the **Cancel** button before clicking Apply.

### Login Settings

The following login parameters may be adjusted.

#### Login Settings

Max Login Attempts	<input type="text" value="5"/>	attempts	1-15 attempts, 0 disables the limit.
Inactivity Timeout	<input type="text" value="60"/>	minutes	1-60 minutes
Lockout Interval	<input type="text" value="57"/>	minutes	1-60 minutes, 0 disables the lockout feature

TP463

The fields in this table have the following meanings.

- Max Login Attempts - the number of times a user can try unsuccessfully to log into the Web Interface. A trap is sent to alert management of each failed login attempt. This parameter can be set from 1 to 15 attempts. If Max Login Attempts is set to 0, this feature is disabled and user login failures are not tracked.
- Inactivity Timeout - the length of time over which the lack of user activity will trigger an automatic logoff. This parameter may be set from 1 to 60 minutes. The default is 10 minutes.  
The inactivity timeout applies to CLI and Web sessions alike. If a Web session is improperly closed (i.e., if the browser is closed before logging out), the inactivity timeout determines how long the session will "hang."
- Lockout Interval - the length of time that users are prevented from logging in

after they reach the maximum number of login attempts. This parameter may be set from 1 to 60 minutes, or may be set to 0 to disable User Lockout.

**Note:** Never change the User Lockout interval while a user is locked, as this may result in an unexpected actual lockout interval for the user.

## Event Log Settings

The event log keeps a record of the last 5,000 events involved with ICIM2 communication and module management.

### Event Log Settings

<input checked="" type="checkbox"/> Log Provisioning events
<input checked="" type="checkbox"/> Log Hardware events
<input checked="" type="checkbox"/> Log System events

TP464

The following types of events can be selected for inclusion in the event log:

- Provisioning - events related to configuring modules, such as changing alarm thresholds, hysteresis, or control parameters.
- Hardware - module insertion or removal events.
- System - events related to downloads, reboots, formatting, or clearing the event log.

The following types of events are always included in the event log:

- Administration - events related to changing login parameters, user information, trap destinations, and clock settings.
- Security - events related to ICIM2 login, logout, and control of IPsec.

Administration and Security events are always included in the event log. Logging of these events cannot be disabled.

## SNMP Traps

The SNMP Traps table allows you to enable up to 10 trap destinations, set the IP address for each destination, and configure settings for the trap.

Clicking inside the checkbox for a trap destination alternately enables and disables it. In the example shown below, traps 0-2 are enabled, while the remaining traps are not used.

#### SNMP Traps

Trap Entry	Enabled	Destination IP Address	
0	<input checked="" type="checkbox"/> Enabled	172.18.50.42	Edit Details
1	<input checked="" type="checkbox"/> Enabled	172.18.50.3	Edit Details
2	<input checked="" type="checkbox"/> Enabled	172.18.50.6	Edit Details
3	<input type="checkbox"/> Enabled	0.0.0.0	Edit Details
4	<input type="checkbox"/> Enabled	0.0.0.0	Edit Details
5	<input type="checkbox"/> Enabled	0.0.0.0	Edit Details
6	<input type="checkbox"/> Enabled	0.0.0.0	Edit Details
7	<input type="checkbox"/> Enabled	0.0.0.0	Edit Details
8	<input type="checkbox"/> Enabled	0.0.0.0	Edit Details
9	<input type="checkbox"/> Enabled	0.0.0.0	Edit Details

TP465

All trap destinations are IP addresses with SNMP managers. SNMP managers are entities such as notification groups, dispatch centers, and work order generation systems, which are prepared to take appropriate action on receipt of the trap.

#### Trap Details

After enabling a trap, click the Edit Details button for the trap to access the trap Details screen, where you can configure settings for the trap.

With the Prisma II XD Chassis, for example, clicking the Edit Details button for trap 0 navigates to the screen shown below.

**Scientific Atlanta**

**Settings for Trap Entry #0**

Note: Unchecking the "Entry Enabled" checkbox will disable *all* traps indicated on this page. Refer to the Installation and Operation Guide (I&O Guide) for details on configuring SNMP traps.

Take caution when making changes to this page as there may be other systems that depend on reception of traps, such as TNCS or ROSA-EM.

Destination Address (IP Format):   Entry Enabled

The Enhanced Trap contains information for all alarms and many events. It can be used in addition to or in place of the other traps as it is completely independent. It also has the advantage of being duplicated in the Trap Log Table

Enhanced Trap Enabled

Standard Traps (independent of the Enhanced Trap, above)

IP Changed Trap Enabled  
 Module Inserted Trap Enabled  
 Module Removed Trap Enabled

Minor Alarm Trap:  
 Disabled  Alarm Cleared  Alarm Set  Alarm Changed (Set or Cleared)

Major Alarm Trap:  
 Disabled  Alarm Cleared  Alarm Set  Alarm Changed (Set or Cleared)

TP466

The Destination Address field and Entry Enabled checkbox in the top portion of the screen simply duplicate the functions of the SNMP Traps screen.

The Enhanced Trap checkbox in the middle portion of the screen lets you define this trap as an Enhanced trap. The Enhanced trap is further explained in the **SNMP Management** chapter of the *Prisma II™ XD Platform System Guide*, part number 4021339.

The Standard Traps checkboxes in the bottom portion of the screen let you define this trap as a having any of the following functions:

- IP Changed Trap - a trap is sent when the IP address of the ICIM2 is changed.
- Module Inserted Trap - a trap is sent when a module in the ICIM2 domain is inserted.
- Module Removed Trap - a trap is sent when a module in the ICIM2 domain is removed.

The radio buttons at the bottom of the screen work independently of the trap settings above. These buttons let you determine:

- Whether the trap is sent for a major alarm, a minor alarm, or both.
- Whether the trap is sent when the alarm is cleared, when it is set, or both.

For additional information on standard traps, see the *Prisma II™ XD Platform System Guide*, part number 4021339.

## Using the Event Log

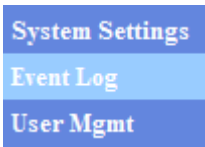

Clicking the Event Log menu item displays the event log, which lists the significant actions performed by each system user.

You can view the event log and completely clear its contents, if desired.

### To View the Event Log

To access the event log, click the **Event Log** menu item.

If the event log contains more than one page, a page navigation control appears above the left side of the Event Log table.

- To advance in the table, click **Next** or a higher page number.
- To return to a previous page in the table, click **Previous** or a lower page number.

### Event Log

Clear Event Log

Page 1 of 54

<<Previous [1, 2, 3, 4, 5, 6, 7, 8, 9, 10, 11, 12, 13, 14, 15, 16, 17, 18, 19, 20, 21] Next>>  
 <<First [20, 40] Last>>

Go to Page:

Timestamp	Action	User ID	Description	Sec Level	Category
12/04/07 21:37:39	Login Success	Administrat0r	Login successful	Admin	Security
12/04/07 21:35:02	Log Off	Administrat0r	Log Off	Admin	Security
12/04/07 21:20:23	Dnld Complete		Module download complete (3/1)	Unknown	System
12/04/07 21:20:21	Login Success	gary001	Login successful	Admin	Security
12/04/07 21:19:08	Dnld Start		Module download start (3/1)	Unknown	System
12/04/07 21:18:57	Dnld Complete		Module download complete (3/2)	Unknown	System
12/04/07 21:17:48	Dnld Start		Module download start (3/2)	Unknown	System
12/04/07 21:17:36	Dnld Complete		Module download complete (3/4)	Unknown	System
12/04/07 21:17:04	Login Success	Administrat0r	Login successful	Admin	Security
12/04/07 21:16:27	Dnld Start		Module download start (3/4)	Unknown	System
12/04/07 21:16:16	Dnld Complete		Module download complete (3/5)	Unknown	System
12/04/07 21:15:08	Dnld Start		Module download start (3/5)	Unknown	System
12/04/07 21:14:56	Dnld Complete		Module download complete (3/6)	Unknown	System
12/04/07 21:13:47	Dnld Start		Module download start (3/6)	Unknown	System
12/04/07 21:13:35	Dnld Complete		Module download complete (3/7)	Unknown	System
12/04/07 21:12:21	Dnld Start		Module download start (3/7)	Unknown	System
12/04/07 21:12:10	Dnld Complete		Module download complete (3/8)	Unknown	System
12/04/07 21:10:58	Dnld Start		Module download start (3/8)	Unknown	System
12/04/07 21:10:47	Dnld Complete		Module download complete (3/9)	Unknown	System
12/04/07 21:09:39	Dnld Start		Module download start (3/9)	Unknown	System
12/04/07 21:09:27	Dnld Complete		Module download complete (3/11)	Unknown	System
12/04/07 21:08:19	Dnld Start		Module download start (3/11)	Unknown	System
12/04/07 21:08:08	Dnld Complete		Module download complete (3/14)	Unknown	System
12/04/07 21:06:59	Dnld Start		Module download start (3/14)	Unknown	System
12/04/07 21:06:48	Dnld Complete		Module download complete (3/16)	Unknown	System

TP467

The Event Log table lists the following information.

- Timestamp - The time at which the event was logged.
- Action - The name of the event that triggered the log entry.
- User ID - The login name of the user who performed the action.
- Description - A brief description of the action that triggered the log entry.
- Sec Level - The security level of the user who performed the event.
- Category - The type of event that was logged: Administration, Hardware, Provision, Security, or System.

## To Clear the Event Log

To empty the contents of the event log, click the **Clear Event Log** button immediately below the table title. After clearing the table, a record of the action is added to the newly cleared event log and a trap is sent.

# User Management

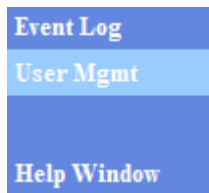

The User Management page allows users with Admin privileges to manage ICIM2 user accounts. Users may log on via the CLI or Web Interface.

The User Management table lists all user records and their status. You can add a new user, edit the security information for an existing user, change a password, or unlock user accounts.

If a user is deleted, there is no further record of the user apart from any related information saved in the event log.

## User Management

(Max 16 Users)

Number	User ID	Security	Status	Last Login	Failed Logins	Locked		
1	Administrat0r	Admin	Enabled	12/04/07 21:37:39	0	No	<a href="#">Edit</a>	Delete
2	gary001	Admin	Enabled	12/04/07 21:20:21	0	No	<a href="#">Edit</a>	<a href="#">Delete</a>
3	user01	Admin	Enabled	12/04/07 02:46:52	0	No	<a href="#">Edit</a>	<a href="#">Delete</a>
4	gary002	Read-Only	Enabled	11/14/07 13:36:02	0	No	<a href="#">Edit</a>	<a href="#">Delete</a>

TP468

[New User](#)

**Note:** The Failed Logins field counts the number of unsuccessful login attempts for each user. The count is cleared upon successful login, when a valid login threshold is reached, or if a locked out user account is unlocked.

## To Add a New User

To add a new user for the Web Interface, click the **New User** button below the User Management table. The New User Information form appears as shown below.

### New User Information

User ID	<input type="text"/>
Password	<input type="text"/>
Confirm Password	<input type="text"/>
Security Level	<input type="text" value="Read-Only"/>
Status	<input type="text" value="Enabled"/>

TP469

[Save](#) [Cancel](#)

Complete the following steps to fill in the New User Information form.

- 1 Click inside the **User ID** field and enter the user ID number for the user.
- 2 Click inside the **Password** field and enter a password for the new user.  
**Note:** User ID and Password security protocols are enforced.
- 3 Click the **Security Level** drop-down arrow and choose the correct security level for the new user: Read-Only, Read-Write, or Admin.
- 4 Click the **Status** drop-down arrow and choose one of the following:
  - Enabled, to make this user record active immediately.
  - Disabled, to delay activation to a later time, such as the user start date.
- 5 Click **Save** to add the new user record to the database, or click **Cancel** to abort the operation and close the User Information form.

## To Edit an Existing User

To update information for an existing user, click the **Edit** button to the right of the user listing in the User Management table. The User Information form appears as shown below.

### User Information (User=Administrat0r)

---

Password	<input type="text"/>		
Confirm Password	<input type="text"/>		Cancel Save

---

Security Level	Admin ▾		Cancel Save
----------------	---------	--	-------------

---

Status	Enabled ▾		Cancel Save
--------	-----------	--	-------------

---

Unlock User	Save
-------------	------

TP470

Complete the following steps to update the user information.

- 1 If necessary, change the password for the user as follows:
  - a Click inside the **Password** field and type the new password.
  - b Click inside the **Confirm Password** field and type the password again.
  - c Click the **Save** button to the right of the Confirm Password to field to save the change, or click **Cancel** to abort.



- 2 If necessary, change the security level for the user as follows:
  - a Open the **Security Level** drop-down menu and select the appropriate menu option: Read-Only, Read-Write, or Admin.
  - b Click the **Save** button to the right of the Security Level field to save the change, or click **Cancel** to abort.
- 3 If necessary, change the status for the user as follows:
  - a Open the **Status** drop-down menu and select one of the following menu options:
    - Enabled, to make the user record active immediately. If the user account is locked, enabling it also unlocks the account.
    - Disabled, to delay activation to a later time, such as the user start date.
  - b Click the **Save** button to the right of the Security Level field to save the change, or click **Cancel** to abort.
- 4 If necessary, click the **Save** button to unlock the user account and enable the user to log in to the ICIM2.

## To Review Current Users

The Currently Logged In table, located below the User Management table at the bottom of the page, appears as shown in the following example.

**Currently Logged In**

User ID	Session Type	Source IP	Login Date / Time
gary001	CLI	172.18.50.5	12/04/07 21:20:21
Administrat0r	WEB	172.18.1.7	12/04/07 21:37:39

TP471

This table provides a list of all users currently logged into the ICIM2. It identifies the User ID and source IP address, and indicates whether the method of access is CLI or the Web Interface (WEB). Finally, the table lists the login date and time for each current user.

## Web Interface Help

The Web Interface Help page provides general help on the pages available from the web server built into the ICIM2. The left side of the Help page contains a navigation pane similar to the one found on other Web Interface pages.



However, there are two important differences:

- Rather than jump to a page in the Web Interface, the links in the Help navigation pane jump to the Help section for that page.
- The Help navigation pane includes a Navigate by Keywords link that jumps to a list of keywords at the bottom of the Help page. Each keyword, in turn, is a link that jumps to the Help section in which it is referenced. Use keyword links if you have trouble finding the page to use for certain operations.

### To Access Help

To open the Help page, click the **Help Window** link in the Web Interface navigation pane. The Help page opens in a separate window to facilitate using help while using the other pages at the same time.

All Help sections are on a single page, so you can access a particular section either by using the navigation pane to jump to the section or simply by scrolling down the page.

### Help Menu

Clicking the Help option opens a menu of Help subjects. This menu works like the navigation pane on all other pages, except that the links navigate not to the indicated page but to the specific Help section for that page.

#### Notes:

- Users restricted from using a particular page of the Web Interface may also be restricted from accessing its corresponding Help section.
- Some pages are only available to users with sufficiently high permissions. In these cases, the corresponding Help sections may also be restricted.

## To Use Navigate by Keywords

The keyword search feature navigates to the Help page on which the selected keyword is referenced.

Complete the following steps to use Keyword search.

- 1 Click the **Keyword** link in the Help menu to navigate to the list of keywords at the bottom of the Help page.  
Alternatively, you can use the browser's Find function, usually **Ctrl-F**, to search for the keyword.
- 2 Locate the keyword that best describes the functional area of interest, and then click the keyword to navigate to the related Help information.



# 8

---

## Customer Support Information

### Introduction

This chapter contains information on obtaining product support and returning products to Scientific Atlanta.

### In This Chapter

- Obtaining Product Support ..... 198
- Return Product for Repair ..... 200

## Obtaining Product Support

IF...	THEN...
you have general questions about this product	contact your distributor or sales agent for product information or refer to product data sheets on <a href="http://www.cisco.com">www.cisco.com</a> .
you have technical questions about this product	call the nearest Technical Service center or Scientific Atlanta office.
you have customer service questions or need a return material authorization (RMA) number	call the nearest Customer Service center or Scientific Atlanta office.

## Support Telephone Numbers

This table lists the Technical Support and Customer Service numbers for your area.

Region	Centers	Telephone and Fax Numbers
North America	SciCare™ Services Atlanta, Georgia United States	For <i>Technical Support</i> , call: <ul style="list-style-type: none"> <li>■ Toll-free: 1-800-722-2009</li> <li>■ Local: 678-277-1120 (Press 2 at the prompt)</li> </ul> For <i>Customer Service</i> or to request an RMA number, call: <ul style="list-style-type: none"> <li>■ Toll-free: 1-800-722-2009</li> <li>■ Local: 678-277-1120 (Press 3 at the prompt)</li> <li>■ Fax: 770-236-5477</li> <li>■ E-mail: <a href="mailto:customer.service@sciatl.com">customer.service@sciatl.com</a></li> </ul>
Europe, Middle East, Africa	Belgium	For <i>Technical Support</i> , call: <ul style="list-style-type: none"> <li>■ Telephone: 32-56-445-197 or 32-56-445-155</li> <li>■ Fax: 32-56-445-053</li> </ul> For <i>Customer Service</i> or to request an RMA number, call: <ul style="list-style-type: none"> <li>■ Telephone: 32-56-445-133 or 32-56-445-118</li> <li>■ Fax: 32-56-445-051</li> <li>■ E-mail: <a href="mailto:elc.service@sciatl.com">elc.service@sciatl.com</a></li> </ul>
Japan	Japan	<ul style="list-style-type: none"> <li>■ Telephone: 81-3-5908-2153 or +81-3-5908-2154</li> <li>■ Fax: 81-3-5908-2155</li> <li>■ E-mail: <a href="mailto:yuri.oguchi@sciatl.com">yuri.oguchi@sciatl.com</a></li> </ul>
Korea	Korea	<ul style="list-style-type: none"> <li>■ Telephone: 82-2-3429-8800</li> <li>■ Fax: 82-2-3452-9748</li> <li>■ E-mail: <a href="mailto:kelly.song@sciatl.com">kelly.song@sciatl.com</a></li> </ul>
China (mainland)	China	<ul style="list-style-type: none"> <li>■ Telephone: 86-21-2401-4433</li> <li>■ Fax: 86-21-2401-4455</li> <li>■ E-mail: <a href="mailto:xiangyang.shan@sciatl.com">xiangyang.shan@sciatl.com</a></li> </ul>
All other Asia-Pacific countries & Australia	Hong Kong	<ul style="list-style-type: none"> <li>■ Telephone: 852-2588-4746</li> <li>■ Fax: 852-2588-3139</li> <li>■ E-mail: <a href="mailto:support.apr@sciatl.com">support.apr@sciatl.com</a></li> </ul>

<b>Region</b>	<b>Centers</b>	<b>Telephone and Fax Numbers</b>
Brazil	Brazil	<p>For <i>Technical Support</i>, call:</p> <ul style="list-style-type: none"> <li>■ Telephone: 55-11-3845-9154 ext 230</li> <li>■ Fax: 55-11-3845-2514</li> </ul> <p>For <i>Customer Service</i> or to request an RMA number, call:</p> <ul style="list-style-type: none"> <li>■ Telephone: 55-11-3845-9154, ext 109</li> <li>■ Fax: 55-11-3845-2514</li> <li>■ E-mail: luiz.fattinger@sciatl.com</li> </ul>
Mexico, Central America, Caribbean	Mexico	<p>For <i>Technical Support</i>, call:</p> <ul style="list-style-type: none"> <li>■ Telephone: 52-3515152599</li> <li>■ Fax: 52-3515152599</li> </ul> <p>For <i>Customer Service</i> or to request an RMA number, call:</p> <ul style="list-style-type: none"> <li>■ Telephone: 52-55-50-81-8425</li> <li>■ Fax: 52-55-52-61-0893</li> <li>■ E-mail: karla.lugo@sciatl.com</li> </ul>
All other Latin America countries	Argentina	<p>For <i>Technical Support</i>, call:</p> <ul style="list-style-type: none"> <li>■ Telephone: 54-23-20-403340 ext 109</li> <li>■ Fax: 54-23-20-403340 ext 103</li> </ul> <p>For <i>Customer Service</i> or to request an RMA number, call:</p> <ul style="list-style-type: none"> <li>■ Telephone: 770-236-5662</li> <li>■ Fax: 770-236-5888</li> <li>■ E-mail: veda.keillor@sciatl.com</li> </ul>

## Return Product for Repair

You must have a return material authorization (RMA) number to return a product. Contact the nearest customer service center and follow their instructions.

Returning a product to Scientific Atlanta for repair includes the following steps:

- *Obtaining an RMA Number and Shipping Address* (on page 200)
- *Completing the Scientific Atlanta Transmission Networks Repair Tag* (on page 201)
- *Packing and Shipping the Product* (on page 204)

### Obtaining an RMA Number and Shipping Address

You must have an RMA number to return products.

RMA numbers are only valid for 60 days. RMA numbers older than 60 days must be revalidated by calling a customer service representative before the product is returned. You can return the product after the RMA number is revalidated. Failure to comply with the above may delay the processing of your RMA request.

Complete the following steps to obtain an RMA number and shipping address.

- 1 Contact a customer service representative to request a new RMA number or revalidate an existing one.

Refer to *Support Telephone Numbers* (on page 198) to find a customer service telephone number for your area.

- 2 Provide the following information to the customer service representative:
  - Your company name, contact, telephone number, email address, and fax number
  - Product name, model number, part number, serial number (if applicable)
  - Quantity of products to return
  - A reason for returning the product and repair disposition authority
  - Any service contract details
- 3 A purchase order number or advance payment to cover estimated charges will be requested at the time a customer service representative issues an RMA number.

**Notes:**

- For credit card or cash in advance customers, a proforma invoice will be sent to you upon completion of product repair listing all charges incurred.
- Customer service must receive a purchase order number within 15 days after you receive the proforma invoice.



- In-warranty products can accrue costs through damage, misuse, cosmetics, or if no problem is found. Products incurring costs will not be returned to you without a valid purchase order number.
- 4 Once an RMA number has been issued, a confirmation e-mail or fax will be sent to you detailing the RMA number, product and product quantities authorized for return, together with shipping address details and RMA terms and conditions.  
**Note:** Alternatively, you may obtain an RMA fax request form, complete and fax it to a customer service representative, or e-mail your completed request form to: [customer.service@sciatl.com](mailto:customer.service@sciatl.com).
  - 5 Go to *Completing the Scientific Atlanta Transmission Networks Repair Tag* (on page 201).

## Completing the Scientific Atlanta Transmission Networks Repair Tag

Product returned for repair, both in-warranty and out-of-warranty, should have a repair tag attached to the product detailing the failure mode. A supply of tags can be obtained free of charge by calling a customer service representative.

The Scientific Atlanta Transmission Networks repair tag provides important failure information to the Scientific Atlanta repair department. This information will reduce the amount of time needed to repair the unit and return it to you. This information can also reduce the cost of out-of-warranty repairs.

It is best to have the Scientific Atlanta Transmission Networks repair tag completed by a person knowledgeable about the failure symptoms of the unit to be returned for repair. The tag should be securely attached to the failed unit with the elastic string, tape, or another method and returned to Scientific Atlanta.

**Scientific Atlanta**  
A CISCO COMPANY

**Scientific Atlanta**  
**Transmission Networks Repair Tag**

RMA #3 \_\_\_\_\_ Date: \_\_\_\_\_  
 Company: \_\_\_\_\_ City: \_\_\_\_\_  
 SA Part #: \_\_\_\_\_ Serial #: \_\_\_\_\_  
 Product: \_\_\_\_\_

Please identify when this unit failed

1  Out of box - During installation  
 2  Out of box - In 1st month  
 3  Early life - In 1st year of operation  
 4  Useful life - After 1st year of operation

Please describe failure condition: \_\_\_\_\_  
 \_\_\_\_\_  
 \_\_\_\_\_  
 \_\_\_\_\_  
 \_\_\_\_\_  
 \_\_\_\_\_  
 \_\_\_\_\_  
 \_\_\_\_\_

Technician: \_\_\_\_\_  
 Phone number (optional): \_\_\_\_\_  
 Reorder SA Part # 4004401

T11025

Complete the following steps to fill out the Scientific Atlanta Transmission Networks repair tag.

- 1 Complete header information.

**Scientific Atlanta**  
A CISCO COMPANY

**Scientific Atlanta**  
**Transmission Networks Repair Tag**

RMA #3 \_\_\_\_\_ Date: \_\_\_\_\_  
 Company: \_\_\_\_\_ City: \_\_\_\_\_  
 SA Part #: \_\_\_\_\_ Serial #: \_\_\_\_\_  
 Product: \_\_\_\_\_

T11026

- **RMA Number:** Enter the RMA number provided by the Scientific Atlanta customer service representative. All RMA numbers start with "3" and are followed by 7 additional digits. An RMA number is required to return products to Scientific Atlanta.
- If you are the technician who is filling out this tag, you may not have the RMA number. Leave it blank for now. Someone else in your organization, who has the number, can fill it in later.
- **Date:** Enter the date the unit was removed from service. If this date is unknown, enter the date you are completing the repair tag.



- If the failure happens only at specific environmental conditions (i.e., at hot temperature).
- If the failure is intermittent or constant.
- How you were powering the unit when it failed? (DC vs. AC, voltage levels, etc.)

**Important:** Descriptions like “bad unit,” “failed,” or “no HBO” are not specific enough to be helpful.

- Technician and Phone Number: Enter the name and phone number of the technician completing the failure description information. A Scientific Atlanta representative may want to call this person to better understand the problem.
- 4 Attach the repair tag to the unit you are returning for repair. Use the elastic string provided, tape, or another method to securely attach the tag.
  - 5 Go to *Packing and Shipping the Product* (on page 204).

## Packing and Shipping the Product

Complete the following steps to pack the product and ship it to Scientific Atlanta.

- 1 Are the product’s original container and packing material available?
  - If yes, pack the product in the original container using the original packing material.
  - If no, pack the product in a sturdy corrugated box, that is suitable to the method of shipment, and cushion it with packing material.

**Important:** You are responsible for delivering the returned product to Scientific Atlanta safely and undamaged. Shipments damaged due to improper packaging may be refused and returned to you at your expense.

**Note:** PLEASE DO NOT RETURN ANY POWER CORDS, ACCESSORY CABLES, OR OTHER ACCESSORY PRODUCTS. Instructions for ordering replacement power cords, accessory cables, or other accessories can be provided by a customer service representative.

- 2 Write the following information on the outside of the shipping container:
  - RMA number
  - Your name
  - Your complete address
  - Your telephone number
  - "Attention: Factory Service"

**Important:** The RMA number should be clearly marked on all returned product, boxes, packages, and accompanying paperwork. RMAs received by the factory service receiving department that are not clearly marked may experience delays in the processing of RMA requests. All returned product should be marked to the attention of Factory Service.

- 3 Ship the product to the address provided by the customer service representative in the confirmation e-mail or fax.

**Note:** Scientific Atlanta does not accept freight collect. Be sure to prepay and insure all shipments. For both in-warranty and out-of-warranty repairs, you are responsible for paying your outbound freight expense, any applicable import and/or export duties and taxes. Scientific Atlanta will pay the return freight expense for in-warranty repairs.

**International Shipments:** International shipments should be consigned to Scientific Atlanta with the notified party on the Airway Bill stated as "Expeditors International for Customs Clearance".

- 4 On receipt of product returned under an RMA number, a receipt notification e-mail or fax will be sent to you by Repair Receiving confirming receipt of product and quantities received. Please check the receipt notification to assure the product and quantity of product received by Scientific Atlanta matches what you shipped.



# A

## Prisma II Permitted CLI Commands

### Introduction

The following tables summarize the available CLI commands for the Prisma II and Prisma II XD platforms. Each table lists the commands available for one of the four major CLI prompts: CLI, \*/\* MODULE, TERMINAL, and ICIM.

Entries shown in parenthesis () are module-specific and must be typed in full. Hints are given to display available entries for those cases. All other entries may be abbreviated to the shortest unambiguous form, as explained in the CLI online help screens.

**Note:** Some commands are limited to Admin level users only.

For further information and assistance when working with CLI, type **help** at the appropriate CLI prompt, and then press **Enter** to display the corresponding help screens.

### In This Appendix

■ From CLI .....	208
■ From ICIM .....	209
■ From */* MODULE .....	215
■ From TERMINAL .....	218

## From CLI

ALARM	
CLEAR	
DATE	
EXIT	
HELP	ALARM
	CLEAR
	COMMANDS
	DATE
	EDIT
	EXIT
	ICIM
	LOGOUT
	MANUAL
	MODULE
	TERMINAL
	WHO
	WHOAMI
ICIM	
LOGOUT	
MANUAL	
MODULE	
TERMINAL	
WHO	
WHOAMI	
'?'	



## From ICIM

ALARM		
EVENTLOGCLEAR		
EVENTLOGFILTER	HARDWARE	ON/OFF
	PROVISIONING	ON/OFF
	SYSTEM	ON/OFF
EXIT		
FILE	IP	(IP_ADDRESS)
	NAME	(FILENAME)
	PASSWORD	(PASSWORD)
	PATH	(PATH)
	USER	(USERNAME)
HELP		
IKE *	ADD	(IP_ADDRESS)
	DELETE	(IP_ADDRESS)
INFO	ACTIVEREV	
	ATTNSTATUS	
	BOOTREV	
	CHASSIS	
	CLEI *	
	CLLI *	
	COMMREAD	
	COMMTRAP	
	COMMWRITE	
	DEVTYPE	
	DOWNLDCMD *	
	DOWNLDDIR *	
	DOWNLDFILE *	
	DOWNLDRESULT *	
	DOWNLDSEM *	
	DOWNLDSIG *	
	DOWNLDSTATE *	

Appendix A  
Prisma II Permitted CLI Commands

	DOWNLDTGT *	
	DOWNLDUSER *	
	FTPSERVER *	
	FTPUSER *	
	GATEWAY	
	HWREV	
	INACTIVEREV *	
	IP	
	IPSEC *	
	LOCKOUT	
	MAC	
	MANDATA	
	NEXTIMAGE	
	PREVIOUSIP	
	SELFTEST	
	SERIAL	
	SIZE	
	SLOT	
	SMC	
	STATUSMSG	
	SUBNET	
	SWDATE	
	SWREV	
	THRESHOLD	
	TIMEOUT	
	TOS	
	TZONE	
	UPDATEID	
IPROUTE	ADD	(DESTINATION)
		(GATEWAY)
	DELETE	(DESTINATION)
		(GATEWAY)
IPSEC *	DISABLE	

	ENABLE	
LOGOUT		
MANUAL		
REBOOT		
SET	CLLI *	(CLLI)
	CLOCK	(DATE_TIME)
	COMMREAD	(READ_STRING)
	COMMTRAP	(TRAP_STRING)
	COMMWRITE	(WRITE_STRING)
	GATEWAY	(GATEWAY)
	IP	(IP_ADDRESS)
	LOCKOUT	(INTERVAL)
	STATUSMSG-CLEARKEY	(1)
	SUBNET	(SUBNET_MASK)
	THRESHOLD	(THRESHOLD)
	TIMEOUT	(TIMEOUT)
	TZONE	(TIMEZONE)
	UPDATEID	(1)
SHOW	ACTIVEREV	
	ATTNSTATUS	
	BOOTREV	
	CHASSIS	
	CLEI *	
	CLLI *	
	CLOCK	
	COMMREAD	
	COMMTRAP	
	COMMWRITE	
	DEVTYPE	
	DOMAIN	
	DOWNLDCMD *	
	DOWNLDDIR *	
	DOWNLDFILE *	

Appendix A  
Prisma II Permitted CLI Commands

	DOWNLDRESULT *	
	DOWNLDSEM *	
	DOWNLDSIG *	
	DOWNLDSTATE *	
	DOWNLDTGT *	
	DOWNLDUSER *	
	EVENTLOG	
	EVENTLOGALL	
	EVENTLOGFILTER	
	FILE	
	FTPSERVER *	
	FTPUSER *	
	GATEWAY	
	HWREV	
	IKE *	
	INACTIVEREV *	
	IP	
	IPROUTE	
	IPSEC *	
	LOCKOUT	
	LOCKEDUSERS	
	MAC	
	MANDATA	
	NEXTIMAGE	
	PREVIOUSIP	
	PROVISIONING	
	SELFTEST	
	SERIAL	
	SIZE	
	SLOT	
	SMC	
	SNTP *	
	STATUSMSG	

	SUBNET	
	SWDATE	
	SWREV	
	THRESHOLD	
	TIMEOUT	
	TOS	
	TRAPS	
	TZONE	
	UPDATEID	
	USER	
SNTP *	INTERVAL	
	IP	
	MODE	
	STATE	
	TIMEOUT	
TRAPS	DISABLE	(INDEX)
		(IP_ADDRESS)
	ENABLE	(INDEX)
		(IP_ADDRESS)

USER	ADD	(USER_ID)	ADMIN	DISABLE
				ENABLE
			READ	DISABLE
				ENABLE
			READWRITE	DISABLE
				ENABLE
	CHANGE	ACCESS_RIGHTS	(USER_ID)	ADMIN
				READ
				READWRITE
		ACCOUNT_STATUS	(USER_ID)	DISABLE
				ENABLE
		PASSWORD	(USER_ID)	(PASSWORD)
	DELETE	(USER_ID)		
	UNLOCK	(USER_ID)		

Appendix A  
Prisma II Permitted CLI Commands

'?'				
-----	--	--	--	--

\* Reserved for future use.

## From \*/\* MODULE

ALARM	DOMAIN		
	MODULE		
CHASSIS	(digits)		
	*		
	[range]		
EXIT			
HELP			
INFO	ALARM	(ALARMNAME)	HYSTERESIS
		use show alarms *	INDEX
			LABEL
			LIMITADJUST
			MAJORHIGH
			MAJORLOW
			MINORHIGH
			MINORLOW
			NOMINAL
			RANGEHI
			RANGELO
			TYPE
			VALUE
	CONTROL	(CONTROLNAME)	INDEX
		use show control *	LABEL
			RANGEHI
			RANGELO
			RANGESTEP
			STATENAMES
			TYPE
			UNITS
			VALUE
	MODULE	ACTIVEREV	
		BOOTREV	
		CLEI <sup>1</sup>	

Appendix A  
Prisma II Permitted CLI Commands

		CLLI <sup>1</sup>	
		CODEREV	
		DATECODE	
		DEVTYPE	
		DOWNLOADABLE <sup>1</sup>	
		INACTIVEREV <sup>1</sup>	
		MANDATA	
		MODTYPE	
		NAME	
		NEXTIMAGE	
		NUMANALOGCONTROLS	
		NUMCONTROLS	
		NUMDIGITALCONTROLS	
		NUMMONITS	
		NUMOFALARMS	
		SCRIPTREV	
		SELFTEST	
		SERIAL	
		TOS	
	MONITOR	(MONITORNAME)	INDEX
		use show mon *	LABEL
			STATENAMES
			TYPE
			UNITS
			VALUE
LOGOUT			
MANUAL			
MODID	digits		
	*		
	[range]		
RESET			
SET	ALARMPARAM	(ALARMNAME)	HYSTERESIS
			MAJORHIGH



			MAJORLOW
			MINORHIGH
			MINORLOW
	CONTROL	(CONTROLNAME)	(VALUE)
	MODULE	CLLI <sup>1</sup>	(CLLI)
SHOW	ALARMPARAM	(ALARMNAME)	HYSTERESIS
		use show alarms *	MAJORHIGH
			MAJORLOW
			MINORHIGH
			MINORLOW
	ALARMSTATE	(ALARMNAME)	
	CONTROL	(CONTROLNAME)	
	MODULE		
	MONITOR	(MONITORNAME)	
SLOT	digits		
	*		
	[range]		
'?'			

<sup>1</sup> Reserved for future use.

## From TERMINAL

ALARM	
COLSEP	(string)
EXIT	
HEADERS	(digits)
HELP	
LOGOUT	
MANUAL	
PAGING	(digits)
PATTERN	REGEX
	WILDCARD
SHOW	
'?'	

# B

## Features Available via Remote User Interface

### Introduction

This appendix lists the features of the remote user interface and identifies the availability (CLI, Web Interface, or both) and required user access level (Read-Only, Read-Write, or Admin) for each feature.

### In This Appendix

■ Overview .....	220
■ ICIM Data.....	221
■ Module Data .....	224
■ Current Alarms .....	225
■ Module Alarms .....	226
■ Module Controls .....	227
■ Module Monitors .....	228
■ System Information .....	229
■ User Management.....	230

## Overview

The tables below list the features available via either the CLI or the Web Interface. Symbols appearing in the cells of these tables have the meanings described below.

- In the CLI or Web column:
  - An asterisk (\*) indicates that the corresponding interface (CLI or Web) supports this feature.
  - A dash (-) indicates that the corresponding interface (CLI or Web) does not support this feature.
- In the Read-Only User, Read-Write User, or Admin User security column:
  - A dash (-) indicates that this feature is not available to the corresponding access level.
  - The letter R indicates that the corresponding access level has Read-Only access to this feature.
  - The letter RW indicates that the corresponding access level has Read-Write access to this feature.

**Note:** The hierarchy of access goes from Read-Only to Read-Write to Admin. So, if a Read-Only user has the privilege to view a particular data element, a Read-Write user would be able to view the same data element. Similarly, if a Read-Write user is able to view or edit a data element, an Admin level user would be able to do the same.

## ICIM Data

Feature	CLI	Web	Read-Only User Privilege	Read-Write User Privilege	Admin User Privilege
IP address	* <sup>1</sup>	*	R	R	RW
Active rev	*	*	R	R	R
Attnstatus	*	-	R	R	R
Boot rev	*	-	R	R	R
Chassis	*	*	R	R	R
CLEI <sup>2</sup>	*	*	R	R	R
CLLI <sup>2</sup>	*	*	R	RW	RW
Clock	* <sup>1</sup>	*	R	R	RW
Commread	*	-	-	-	RW
Commwrite	*	-	-	-	RW
Commtrap	*	-	-	-	RW
DevType	*	-	R	R	R
Domain	*	*	R	R	R
Downldcmd <sup>2</sup>	*	-	R	R	R
Downlddir <sup>2</sup>	*	-	R	R	R
Downldfile <sup>2</sup>	*	-	R	R	R
Downldresult <sup>2</sup>	*	-	R	R	R
Downldsem <sup>2</sup>	*	-	R	R	R
Downldsig <sup>2</sup>	*	-	R	R	R
Downldstate <sup>2</sup>	*	*	R	R	R
Downldtgt <sup>2</sup>	*	-	R	R	R
Downlduser <sup>2</sup>	*	-	R	R	R
Eventlog	*	-	-	-	R
Eventlogall	*	*	-	-	R
File	*	-	-	R	RW
Ftpserver <sup>2</sup>	*	-	R	R	R
Ftpuser <sup>2</sup>	*	-	-	-	R
Gateway	* <sup>1</sup>	*	R	R	RW

Appendix B  
Features Available via Remote User Interface

Feature	CLI	Web	Read-Only User Privilege	Read-Write User Privilege	Admin User Privilege
Hwrev	*	*	R	R	R
Inactiverrev <sup>2</sup>	*	*	R	R	R
IKE <sup>2</sup>	*	-	-	-	RW
IProute	*	-	R	R	RW
IPSec <sup>2</sup>	*	-	R	R	RW
LockedUsers	*	*	-	-	R
LockoutInterval	*	*	R	R	RW
MAC	*	*	R	R	R
Mandata	*	*	R	R	R
Nextimage	*	-	R	R	R
Previousip	*	-	R	R	R
Provisioning	*	-	R	R	R
Reboot	*	-	-	-	W
Selftest	*	*	R	R	R
Serial	*	*	R	R	R
Size	*	*	R	R	R
Slot	*	*	R	R	R
Smc	*	*	R	R	R
SNTPInterval <sup>2</sup>	*	-	-	-	RW
SNTPIPAddress <sup>2</sup>	*	-	-	-	RW
SNTPLastUpdate <sup>2</sup>	*	-	-	-	R
SNTPMode <sup>2</sup>	*	-	-	-	RW
SNTPState <sup>2</sup>	*	-	-	-	RW
SNTPTimeout <sup>2</sup>	*	-	-	-	RW
Statusmsg	*	-	R	R	R
Statusmsgclearkey	*	-	-	-	W
Subnet	* <sup>1</sup>	*	R	R	RW
Swdate	*	-	R	R	R
Swrev	*	-	R	R	R
sysDescr	-	*	R	R	R

<b>Feature</b>	<b>CLI</b>	<b>Web</b>	<b>Read-Only User Privilege</b>	<b>Read-Write User Privilege</b>	<b>Admin User Privilege</b>
sysLocation	-	*	R	R	R
sysUptime	-	*	R	R	R
Threshold	* <sup>3</sup>	*	R	R	RW
Timeout	* <sup>3</sup>	*	R	R	RW
TOS	*	*	R	R	R
Traps	* <sup>3</sup>	*	R	R	RW
Timezone	* <sup>1</sup>	*	R	R	RW
Updateid	*	-	R	R	RW
User	*	*	-	-	RW

<sup>1</sup> May be modified through the CLI but not through the Web Interface.

<sup>2</sup> Reserved for future use.

<sup>3</sup> May be read through the CLI but not through the Web Interface.

## Module Data

Feature	CLI	Web	Read-Only User Privilege	Read-Write User Privilege	Admin User Privilege
Active rev	*	*	R	R	R
Boot rev	*	-	R	R	R
Chassis	*	*	R	R	R
CLEI <sup>1</sup>	*	*	R	R	R
CLLI <sup>1</sup>	*	*	R	RW	RW
Device Type	*	*	R	R	R
Downloadable <sup>1</sup>	*	*	R	R	R
Inactive Rev <sup>1</sup>	*	*	R	R	R
Module Name	*	*	R	R	R
Module Type	*	*	R	R	R
Reset	*	-	-	-	W
Selftest	*	*	R	R	R
Serial	*	*	R	R	R
Slot	*	*	R	R	R
Time of Service	*	*	R	R	R

<sup>1</sup> Reserved for future use.



## Current Alarms

<b>Feature</b>	<b>CLI</b>	<b>Web</b>	<b>Read-Only User Privilege</b>	<b>Read-Write User Privilege</b>	<b>Admin User Privilege</b>
Current Alarms	*	*	R	R	R

## Module Alarms

<b>Feature</b>	<b>CLI</b>	<b>Web</b>	<b>Read-Only User Privilege</b>	<b>Read-Write User Privilege</b>	<b>Admin User Privilege</b>
Hysteresis	*	*	R	RW	RW
Label	*	*	R	R	R
MajorHigh	*	*	R	RW	RW
MajorLow	*	*	R	RW	RW
MinorHigh	*	*	R	RW	RW
MinorLow	*	*	R	RW	RW
RangeHigh	*	*	R	R	R
RangeLow	*	*	R	R	R
Type	*	*	R	R	R
Value	*	*	R	R	R

## Module Controls

<b>Feature</b>	<b>CLI</b>	<b>Web</b>	<b>Read-Only User Privilege</b>	<b>Read-Write User Privilege</b>	<b>Admin User Privilege</b>
High	*	*	R	R	R
Label	*	*	R	R	R
Low	*	*	R	R	R
Step	*	*	R	R	R
Units	*	*	R	R	R
Value	*	*	R	RW	RW

## Module Monitors

<b>Feature</b>	<b>CLI</b>	<b>Web</b>	<b>Read-Only User Privilege</b>	<b>Read-Write User Privilege</b>	<b>Admin User Privilege</b>
Label	*	*	R	R	R
Units	*	*	R	R	R
Value	*	*	R	R	R

## System Information

<b>Feature</b>	<b>CLI</b>	<b>Web</b>	<b>Read-Only User Privilege</b>	<b>Read-Write User Privilege</b>	<b>Admin User Privilege</b>
Event Log Filter	* <sup>4</sup>	*	R	R	RW
Event Log Clear	*	*	-	-	R/Clear
Max Login Attempts	* <sup>4</sup>	*	R	R	RW
Inactivity Timeout	* <sup>4</sup>	*	R	R	RW
Lockout Interval	*	*	R	R	RW
Trap Receive Table	* <sup>4</sup>	*	R	R	RW

<sup>4</sup> May be read through the CLI but not through the Web Interface.

## User Management

Feature	CLI	Web	Read-Only User Privilege	Read-Write User Privilege	Admin User Privilege
Add user	*	*	-	-	RW
Change user	*	*	-	-	RW
Current users	*	*	-	-	R
Delete user	*	*	-	-	RW
Unlock user	*	- <sup>1</sup>	-	-	RW

<sup>1</sup> A user account may be unlocked through the Web Interface by enabling the account.

# C

## Module Parameter Descriptions

### Introduction

This appendix provides manufacturing data, monitored parameters, configurable parameters, and alarms for the Prisma II XD Platform. The examples shown in the tables are for guidance only.



**CAUTION:**

The warranty may be voided and the equipment damaged if you operate the equipment above the specified temperature limits (0 to 50°C). Specification temperature limits are measured in the air stream at the fan inlet and may be higher than room ambient temperature.

### In This Appendix

- XD Chassis Parameters ..... 232

## XD Chassis Parameters

### XD Chassis Control Parameters

Control	Function	Value	Default
AlmMuteA	Alarm muting for power section A	0 (OFF) 1 (ON)	0 (OFF)
AlmMuteB	Alarm muting for power section B	0 (OFF) 1 (ON)	0 (OFF)

### XD Chassis Alarm Data Parameters

#### User Alarm Data Parameters

Alarm	Function	Major Low Threshold	Minor Low Threshold	Minor High Threshold	Major High Threshold	Hysteresis	Typical Range/ Nom. Value
ChasTemp	Fan tray temperature	-40°C	-35°C	60°C	65°C	1°C	-40°C to 65°C / 25°C
ConvA+24	+24 V alarm for supply A	18.0 VDC	18.4 VDC	25.9 VDC	26.1 VDC	0.1 VDC	23.8 to 25.6 VDC / 24.7 V
ConvA+5	+5 V alarm for supply A	3.6 VDC	3.7 VDC	5.9 VDC	6.1 VDC	0.1 VDC	4.9 to 5.3 VDC / 5.4 V
ConvA-5	-5 V alarm for supply A	-5.6 VDC	-5.5 VDC	-4.6 VDC	-4.5 VDC	0.1 VDC	-5.3 to -4.9 VDC / -5.4 V
ConvB+24	+24 V alarm for supply B	18.0 VDC	18.4 VDC	25.9 VDC	26.1 VDC	0.1 VDC	23.8 to 25.6 VDC / 24.7 V
ConvB+5	+5 V alarm for supply B	3.6 VDC	3.7 VDC	5.9 VDC	6.1 VDC	0.1 VDC	4.9 to 5.3 VDC / 5.4 V
ConvB-5	-5 V alarm for supply B	-5.6 VDC	-5.5 VDC	-4.6 VDC	-4.5 VDC	0.1 VDC	-5.3 to -4.9 VDC / -5.4 V



## Module Alarm Data Parameters

Alarm	Function	Major Low Threshold	Minor Low Threshold	Minor High Threshold	Major High Threshold	Hysteresis	Typical Range/ Nom. Value
Fan 1_Ok	Fan 1 status	na	na	na	na	na	OK or Fault
Fan 2_Ok	Fan 2 status	na	na	na	na	na	OK or Fault
Fan 3_Ok	Fan 3 status	na	na	na	na	na	OK or Fault
ConvAIn	Converter A power status	na	na	na	na	na	OK or Fault
ConvBIn	Converter B power status	na	na	na	na	na	OK or Fault

## XD Chassis Monitor Parameter Examples

Parameter	Function	Initial Value	Operating Value (typ)
PSA Inst	1 if power supply A is installed and powered, 0 if not	1 (Installed and powered)	1 (Installed and powered)
ConvAIns	1 if converter A is installed, 0 if not	1 (Installed)	1 (Installed)
ConvA+24	Measured +24 V DC of slot A	24.1148 V	24.1148 V
ConvA+5	Measured +5 V DC of slot A	5.29054 V	5.29054 V
ConvA-5V	Measured -5 V DC of slot A	-5.29926 V	-5.29926 V
PSB Inst	1 if power supply B is installed and powered, 0 if not	0 (Not installed)	1 (Installed)
ConvBIns	1 if converter B is installed, 0 if not	1 (Installed)	1 (Installed)
ConvB+24	Measured +24 V DC of slot B	24.1481 V	24.1481 V
ConvB+5	Measured +5 V DC of slot B	5.0949 V	5.0949 V
ConvB-5V	Measured -5 V DC of slot B	-5.02933 V	-5.02933 V
Chas+24	Chassis +24 V bus	24.14 V	24.14 V
Chas+5	Chassis +5 V bus	5.08 V	5.08 V
Chas-5	Chassis -5 V bus	-5.05 V	-5.05 V
ChasTemp	Chassis internal temperature	26.5°C	26.5°C

**Note:** All monitored values may vary from module to module. The values shown above are examples only.

## XD Chassis Manufacturing Data Parameter Examples

### XD Chassis

Manufacturing Data	Typical Values
Module Name	P2-XD-CHASSIS
Module Type	5020
Manufacturing Data	<NULL>
Serial # [1]	AAFHJJT
Date Code [1]	K06
Module ID	<NULL>
CLLI Code [1]	<NULL>
CLEI Code [1]	<NULL>
Sw Ver (Software Version) [1]	1.01.00
In Service Hours [1]	372

### ICIM2-XD

Manufacturing Data	Typical Values
Module Name	P2-ICIM2-XD
Module Type	5011
Manufacturing Data	ICIM2
Serial # [1]	~AAVGTHZ
Date Code [1]	C07
Module ID	<NULL>
CLLI Code [1]	<NULL>
CLEI Code [1]	<NULL>
Hardware Revision	BdRev87A
Sw Ver (Software Version) [1]	2.02.10
In Service Hours [1]	372

**Note:** [1] These values may vary from module to module. The values shown above are examples only.

# Glossary

---

## A

ampere. A unit of measure for electrical current.

## ac, AC

alternating current. An electric current that reverses its direction at regularly recurring intervals.

## AD

administration.

## Admin

administrator.

## AGC

automatic gain control. A process or means by which gain is automatically adjusted in a specified manner as a function of input level or other specified parameters.

## AWG

American Wire Gauge. A U.S. standard for wire conductor sizes.

## binding

A parameter representing the physical or logical objects associated with a trap.

## CAT5

category 5 Ethernet cable.

## CBN

common bonding network.

## CCB

client controller board or chassis control board.

## Glossary

### CENELEC

Comité Européen de Normalisation ELEctrotechnique. The European Committee for electro-technical standardization.

### CLEI

common language equipment identifier. CLEI code is globally unique ten-character intelligent code, assigned by Telcordia, that identifies communications equipment in a concise, uniform feature-oriented language, which describes product type, features, source document and associated drawings and vintages.

### CLI

command line interface. A command reference software that allows the user to interact with the operating system by entering commands and optional arguments.

### CLLI

common language location identification. A CLLI code is typically an 11-character alphanumeric descriptor used to identify network elements and their locations.

### COM

communication.

### CSV

comma-separated values. A data file format supported by many spreadsheet programs, in which fields are separated by commas. Also referred to as comma delimited.

### dc, DC

direct current. An electric current flowing in one direction only and substantially constant in value.

### EEPROM

electrically erasable programmable read-only memory.

### EIA

Electronic Industries Association. A United States association that provides standards for use between manufacturers and purchasers of electronic products.

### EMC

electromagnetic compatibility. A measure of equipment tolerance to external electromagnetic fields.

## EMS

Element Management System. A system that controls a single element, or many elements of a single type. Usually works up into a full network management system (NMS).

## ESD

electrostatic discharge. Discharge of stored static electricity that can damage electronic equipment and impair electrical circuitry, resulting in complete or intermittent failures.

## FCC

Federal Communications Commission. Federal organization set up by the Communications Act of 1934 which has authority to regulate all inter-state (but not intra-state) communications originating in the United States (radio, television, wire, satellite, and cable).

## FTP

file transfer protocol. Allows users to transfer text and binary files to and from a personal computer, list directories on the foreign host, delete and rename files on the foreign host, and perform wildcard transfers between hosts.

## FTTP

fiber-to-the-premises. Fiber optic service to the subscriber's premises.

## HDRx

high density receiver.

## HDTx

high density transmitter.

## HTTP

hypertext transport protocol. A communication protocol used to request and transmit files over the Internet and other networks.

## HW

hardware.

## Hz

hertz. A unit of frequency equal to one cycle per second.

## I/O

input/output.

## Glossary

### ICIM

intelligent communications interface module.

### ID

identifier.

### IEC

International Electro-technical Commission.

### in-lb

inch-pound. A measure of torque defined by the application of one pound of force on a lever at a point on the lever that is one inch from the pivot point.

### IP

Internet protocol. A standard that was originally developed by the United States Department of Defense to support the internetworking of dissimilar computers across a network. IP is perhaps the most important of the protocols on which the Internet is based. It is the standard that describes software that keeps track of the internetwork addresses for different nodes, routes, and outgoing/incoming messages on a network. Some examples of IP applications include email, chat, and Web browsers.

### LCD

liquid crystal display. A display medium made of liquid crystal. Liquid crystal's reflectance changes when an electric field is applied. Commonly used in monitors, televisions, cell phones, digital watches, etc.

### LCI

local craft interface.

### LED

light-emitting diode. An electronic device that lights up when electricity passes through it.

### MIB

management information base. SNMP collects management information from devices on the network and records the information in a management information base. The MIB information includes device features, data throughput statistics, traffic overloads, and errors.

### MSO

multiple system operator. A cable company that operates more than one cable system.

nm

nanometer. One billionth of a meter.

Nm

Newton meter. A measure of torque defined by the application of one Newton of force on a lever at a point on the lever that is one meter from the pivot point. (1 Nm = 0.737561 ft-lb)

NMS

network management system. A software system designed specifically to monitor a network and to facilitate troubleshooting.

NTP

network time protocol.

OID

object identifier.

OMI

optical modulation index.

PR

provisioning.

PWR

power.

QAM

quadrature amplitude modulation. A phase modulation technique for representing digital information and transmitting that data with minimal bandwidth. Both phase and amplitude of carrier waves are altered to represent the binary code. By manipulating two factors, more discrete digital states are possible and therefore larger binary schemes can be represented.

RF

radio frequency. The frequency in the portion of the electromagnetic spectrum that is above the audio frequencies and below the infrared frequencies, used in radio transmission systems.

RMA

return material authorization. A form used to return products.

## Glossary

### RO

read-only.

### RTC

real time clock.

### RW

read-write.

### RX

receive or receiver.

### SE

security.

### semaphore

In programming, a control token (variable or abstract data type) used to restrict access to a resource. The Scientific Atlanta SOUP program uses a semaphore to prevent multiple instances of the SOUP from running and trying to change Prisma II EMS chassis parameters at the same time.

### SMC

status monitoring and control. The process by which the operation, configuration, and performance of individual elements in a network or system are monitored and controlled from a central location.

### SNMP

simple network management protocol. A protocol that governs network management and the monitoring of network devices and their functions.

### SOUP

software upgrade program. A utility used to update firmware in Prisma II EMS application modules.

### SY

system.

### TNCS

Transmission Network Control System. A Scientific Atlanta application that allows status



monitoring and control of all transmission equipment located in headends and hubs plus optical nodes, power supplies, and amplifiers in the outside plant. TNCS provides access to and information on the entire network in an easy to understand, topology driven, graphical user display.

trap

An unsolicited message sent by a network device to notify a network or element management system of an alarm or other condition that requires administrative attention.

TX

transmit or transmitter.

V AC

volts alternating current.

V DC

volts direct current.

XD

extreme density.



# Index

## A

- A • 235
- About Modspecs • 37
- ac, AC • 235
- AD • 235
- Admin • 235
- AGC • 235
- alarm • 20, 40, 87, 143
- alarm domain • 41
- alarm module • 42
- AWG • 235

## B

- binding • 235

## C

- CAT5 • 235
- CBN • 235
- CCB • 235
- CENELEC • 236
- chassis • 43
- clear • 21
- CLEI • 236
- CLI • 236
- CLI Command Modes • 10
- CLI Login and Logout • 8
- CLI Mode Commands • 19
- CLI Overview • 5
- CLLI • 236
- colsep • 144
- COM • 236
- Command Syntax • 12
- Completing the Scientific Atlanta Transmission Networks Repair Tag • 201
- CSV • 236
- Current Alarms • 225
- Customer Support Information • 197

## D

- date • 22
- dc, DC • 236

## E

- EEPROM • 236
- EIA • 236
- EMC • 236
- EMS • 237
- ESD • 237
- eventlogclear • 88
- eventlogfilter • 89
- exit • 45, 91, 146

## F

- FCC • 237
- file • 92
- From \*/\* MODULE • 215
- From CLI • 208
- From ICIM • 209
- From TERMINAL • 218
- FTP • 237
- FTTP • 237

## G

- General Hints and Help • 16

## H

- HDRx • 237
- HDTx • 237
- headers • 147
- help • 23, 46, 94, 149
- HTTP • 237
- HW • 237
- Hz • 237

## I

- I/O • 237
- icim • 25
- ICIM • 238
- ICIM CLI and SNMP Equivalents • 175
- ICIM Data • 221
- ICIM Mode Commands • 83
- ID • 238
- IEC • 238

- ike • 96
- info • 97
- info alarm • 48
- info control • 50
- info module • 52
- info monitor • 54
- in-lb • 238
- Installation • 164
- Introduction • 1, 162
- IP • 238
- iproute • 100
- ipsec • 102

## L

- LCD • 238
- LCI • 238
- LED • 238
- Login and Logout • 167
- logout • 26, 56, 103, 151

## M

- manual • 27, 57, 104, 152
- MIB • 238
- modid • 61
- module • 29
- Module Alarms • 226
- Module CLI and SNMP Equivalents • 182
- Module Controls • 227
- Module Data • 224
- Module Mode Commands • 33
- Module Monitors • 228
- MSO • 238

## N

- nm • 239
- Nm • 239
- NMS • 239
- NTP • 239

## O

- Obtaining an RMA Number and Shipping Address • 200
- Obtaining Product Support • 198
- OID • 239
- OMI • 239
- Overview • 35, 85, 142, 220

## P

- Packing and Shipping the Product • 204
- paging • 154

- pattern • 158
- PR • 239
- Prisma II Platform Configuration • 6
- PWR • 239

## Q

- QAM • 239

## R

- reboot • 109
- Related Publications • 3
- reset • 63
- Return Product for Repair • 200
- RF • 239
- RMA • 239
- RO • 240
- RTC • 240
- RW • 240
- RX • 240

## S

- SE • 240
- semaphore • 240
- set • 110
- set alarmparam • 65
- set clock • 112
- set control • 68
- set module • 70
- show • 114, 160
- show alarmparam • 71
- show alarmstate • 73
- show clock • 117
- show control • 75
- show domain • 118
- show eventlog • 120
- show eventlogall • 121
- show eventlogfilter • 122
- show file • 123
- show ike • 124
- show iproute • 125
- show module • 77
- show monitor • 79
- show provisioning • 126
- show sntp • 128
- show traps • 129
- show user • 130
- slot • 81
- SMC • 240
- SNMP • 240
- sntp • 131

SOUP • 240  
Support Telephone Numbers • 198  
SY • 240  
System Information • 229

## T

terminal • 30  
Terminal Mode Commands • 141  
TNCS • 240  
trap • 241  
traps • 132  
TX • 241

## U

user add • 133  
User Authorization • 7  
user change • 135  
user delete • 137  
User Management • 191, 230  
user unlock • 138  
Using ICIM Details • 174  
Using Module Details • 177  
Using System Settings • 185  
Using System View • 171  
Using the Event Log • 189

## V

V AC • 241  
V DC • 241

## W

Warning Labels • xxi  
Web Browser Setup • 165  
Web Interface • 161  
Web Interface Help • 194  
who • 31  
whoami • 32

## X

XD • 241  
XD Chassis Alarm Data Parameters • 232  
XD Chassis Control Parameters • 232  
XD Chassis Manufacturing Data Parameter  
Examples • 234  
XD Chassis Monitor Parameter Examples • 233  
XD Chassis Parameters • 232



Scientific Atlanta, A Cisco Company  
5030 Sugarloaf Parkway, Box 465447  
Lawrenceville, GA 30042

678.277.1000  
[www.scientificatlanta.com](http://www.scientificatlanta.com)

This document includes various trademarks of Cisco Systems, Inc. Please see the Notices section of this document for a list of Cisco Systems, Inc., trademarks used in this document. Product and service availability are subject to change without notice.

© 2008 Cisco Systems, Inc. All rights reserved.

November 2008 Printed in United States of America

Part Number 4012441 Rev B