









Cisco RF Gateway 1 System Guide

For Your Safety

Explanation of Warning and Caution Icons

Avoid personal injury and product damage! Do not proceed beyond any symbol until you fully understand the indicated conditions.

The following warning and caution icons alert you to important information about the safe operation of this product:

-  You may find this symbol in the document that accompanies this product. This symbol indicates important operating or maintenance instructions.
-  You may find this symbol affixed to the product. This symbol indicates a live terminal where a dangerous voltage may be present; the tip of the flash points to the terminal device.
-  You may find this symbol affixed to the product. This symbol indicates a protective ground terminal.
-  You may find this symbol affixed to the product. This symbol indicates a chassis terminal (normally used for equipotential bonding).
-  You may find this symbol affixed to the product. This symbol warns of a potentially hot surface.
-  You may find this symbol affixed to the product and in this document. This symbol indicates an infrared laser that transmits intensity-modulated light and emits invisible laser radiation or an LED that transmits intensity-modulated light.

Important

Please read this entire guide. If this guide provides installation or operation instructions, give particular attention to all safety statements included in this guide.

Notices

Trademark Acknowledgments

Cisco and the Cisco logo are trademarks or registered trademarks of Cisco and/or its affiliates in the U.S. and other countries. To view a list of cisco trademarks, go to this URL: www.cisco.com/go/trademarks.

Third party trademarks mentioned are the property of their respective owners.

The use of the word partner does not imply a partnership relationship between Cisco and any other company. (1110R)

Publication Disclaimer

Cisco Systems, Inc. assumes no responsibility for errors or omissions that may appear in this publication. We reserve the right to change this publication at any time without notice. This document is not to be construed as conferring by implication, estoppel, or otherwise any license or right under any copyright or patent, whether or not the use of any information in this document employs an invention claimed in any existing or later issued patent.

Copyright

© 2008, 2012 Cisco and/or its affiliates. All rights reserved. Printed in the United States of America.

Information in this publication is subject to change without notice. No part of this publication may be reproduced or transmitted in any form, by photocopy, microfilm, xerography, or any other means, or incorporated into any information retrieval system, electronic or mechanical, for any purpose, without the express permission of Cisco Systems, Inc.

Contents

| | |
|--------------------------------------|------------|
| Important Safety Instructions | vii |
|--------------------------------------|------------|

| | |
|---------------------|-------------|
| Laser Safety | xvii |
|---------------------|-------------|

| | |
|-------------------------------|----------|
| Chapter 1 Introduction | 1 |
|-------------------------------|----------|

| | |
|--|----|
| Features and Benefits | 3 |
| Primary Benefits..... | 3 |
| Primary Features..... | 3 |
| Modular Concept | 4 |
| Housing..... | 5 |
| LED Indicators..... | 5 |
| Connectors | 5 |
| Additional Information..... | 6 |
| Power Supply | 7 |
| Introduction..... | 7 |
| AC PSU Features and Benefits..... | 7 |
| DC PSU Features and Benefits..... | 8 |
| QAM Card | 9 |
| General | 9 |
| Features and Benefits | 9 |
| Embedded Graphical User Interface..... | 10 |
| Introduction..... | 10 |
| Product Identification..... | 11 |
| Introduction..... | 11 |

| | |
|-------------------------------|-----------|
| Chapter 2 Installation | 13 |
|-------------------------------|-----------|

| | |
|---|----|
| Preparing for Installation..... | 14 |
| Tools and Accessories | 14 |
| Unpacking and Inspecting the Module | 14 |
| Chassis Dimensions..... | 15 |
| Site Requirements | 16 |
| Access Requirements..... | 16 |
| Equipment Rack..... | 16 |
| Operating Environment..... | 16 |
| Rack Mounting..... | 17 |
| Tools and Accessories | 17 |
| Mounting Requirements | 17 |
| Mounting the RF Gateway 1 | 17 |

| | |
|---|----|
| Installing and Removing RF Gateway 1 Components | 19 |
| Installing/Removing the PSU..... | 19 |
| Installing/Removing the QAM Card..... | 20 |
| Installing/Removing SFP Modules..... | 21 |
| Connecting Cables | 24 |
| Connecting AC Power..... | 24 |
| Connecting DC Power..... | 24 |
| Cabling the Earth-Bonding Terminal..... | 26 |
| Connecting the Input and Output Cables | 27 |

Chapter 3 Maintenance and Troubleshooting 31

| | |
|---|----|
| Maintenance..... | 32 |
| Maintaining the Equipment | 32 |
| Replacing a Fan | 32 |
| Troubleshooting | 34 |
| Checking LED Indicators..... | 34 |
| Optical Connector Cleaning Guidelines..... | 36 |
| Optical Connector Cleaning Overview..... | 36 |
| Recommended Equipment..... | 36 |
| Tips for Optimal Connector Performance..... | 36 |
| To Clean Optical Connectors | 37 |

Chapter 4 Customer Support Information 39

Appendix A Technical Specifications 41

| | |
|--|----|
| General Specifications | 42 |
| Introduction..... | 42 |
| Environmental Specifications..... | 42 |
| Chassis Mechanical Specifications..... | 42 |
| Physical..... | 42 |
| Power Supply Specifications..... | 43 |
| Electrical Specifications..... | 44 |
| GbE Input Interface | 44 |
| Management Interface..... | 44 |
| DTI Interface..... | 44 |
| RF Outputs..... | 44 |
| Signal Specifications | 45 |
| Specifications Optical Types SFP Modules | 46 |
| Electrical GbE SFP Transceiver | 46 |

| | |
|----------|----|
| Glossary | 47 |
| Index | 55 |

Important Safety Instructions

Read and Retain Instructions

Carefully read all safety and operating instructions before operating this equipment, and retain them for future reference.

Follow Instructions and Heed Warnings

Follow all operating and use instructions. Pay attention to all warnings and cautions in the operating instructions, as well as those that are affixed to this equipment.

Terminology

The terms defined below are used in this document. The definitions given are based on those found in safety standards.

Service Personnel - The term *service personnel* applies to trained and qualified individuals who are allowed to install, replace, or service electrical equipment. The service personnel are expected to use their experience and technical skills to avoid possible injury to themselves and others due to hazards that exist in service and restricted access areas.

User and Operator - The terms *user* and *operator* apply to persons other than service personnel.

Ground(ing) and Earth(ing) - The terms *ground(ing)* and *earth(ing)* are synonymous. This document uses *ground(ing)* for clarity, but it can be interpreted as having the same meaning as *earth(ing)*.

Electric Shock Hazard

This equipment meets applicable safety standards.



WARNING:

To reduce risk of electric shock, perform only the instructions that are included in the operating instructions. Refer all servicing to qualified service personnel only.

Electric shock can cause personal injury or even death. Avoid direct contact with dangerous voltages at all times. The protective ground connection, where provided, is essential to safe operation and must be verified before connecting the power supply.

Know the following safety warnings and guidelines:

- Dangerous Voltages

Important Safety Instructions

- Only qualified service personnel are allowed to perform equipment installation or replacement.
- Only qualified service personnel are allowed to remove chassis covers and access any of the components inside the chassis.
- Grounding
 - Do not violate the protective grounding by using an extension cable, power cable, or autotransformer without a protective ground conductor.
 - Take care to maintain the protective grounding of this equipment during service or repair and to re-establish the protective grounding before putting this equipment back into operation.

Installation Site

When selecting the installation site, comply with the following:

- **Protective Ground** - The protective ground lead of the building's electrical installation should comply with national and local requirements.
- **Environmental Condition** - The installation site should be dry, clean, and ventilated. Do not use this equipment where it could be at risk of contact with water. Ensure that this equipment is operated in an environment that meets the requirements as stated in this equipment's technical specifications, which may be found on this equipment's data sheet.

Installation Requirements



WARNING:

Allow only qualified service personnel to install this equipment. The installation must conform to all local codes and regulations.

Equipment Placement



WARNING:

Avoid personal injury and damage to this equipment. An unstable mounting surface may cause this equipment to fall.

To protect against equipment damage or injury to personnel, comply with the following:

- Install this equipment in a restricted access location.
- Do not install near any heat sources such as radiators, heat registers, stoves, or other equipment (including amplifiers) that produce heat.
- Place this equipment close enough to a mains AC outlet to accommodate the length of this equipment's power cord.

- Route all power cords so that people cannot walk on, place objects on, or lean objects against them. This may pinch or damage the power cords. Pay particular attention to power cords at plugs, outlets, and the points where the power cords exit this equipment.
- Use only with a cart, stand, tripod, bracket, or table specified by the manufacturer, or sold with this equipment.
- Make sure the mounting surface or rack is stable and can support the size and weight of this equipment.
- The mounting surface or rack should be appropriately anchored according to manufacturer's specifications. Ensure this equipment is securely fastened to the mounting surface or rack where necessary to protect against damage due to any disturbance and subsequent fall.

Ventilation

This equipment has openings for ventilation to protect it from overheating. To ensure equipment reliability and safe operation, do not block or cover any of the ventilation openings. Install the equipment in accordance with the manufacturer's instructions.

Rack Mounting Safety Precautions

Mechanical Loading

Make sure that the rack is placed on a stable surface. If the rack has stabilizing devices, install these stabilizing devices before mounting any equipment in the rack.



WARNING:

Avoid personal injury and damage to this equipment. Mounting this equipment in the rack should be such that a hazardous condition is not caused due to uneven mechanical loading.

Reduced Airflow

When mounting this equipment in the rack, do not obstruct the cooling airflow through the rack. Be sure to mount the blanking plates to cover unused rack space. Additional components such as combiners and net strips should be mounted at the back of the rack, so that the free airflow is not restricted.



CAUTION:

Installation of this equipment in a rack should be such that the amount of airflow required for safe operation of this equipment is not compromised.

Elevated Operating Ambient Temperature

Only install this equipment in a humidity- and temperature-controlled environment that meets the requirements given in this equipment's technical specifications.

Important Safety Instructions



CAUTION:

If installed in a closed or multi-unit rack assembly, the operating ambient temperature of the rack environment may be greater than room ambient temperature. Therefore, install this equipment in an environment compatible with the manufacturer's maximum rated ambient temperature.

Handling Precautions

When moving a cart that contains this equipment, check for any of the following possible hazards:



WARNING:



Avoid personal injury and damage to this equipment! Move any equipment and cart combination with care. Quick stops, excessive force, and uneven surfaces may cause this equipment and cart to overturn.

- Use caution when moving this equipment/cart combination to avoid injury from tip-over.
- If the cart does not move easily, this condition may indicate obstructions or cables that may need to be disconnected before moving this equipment to another location.
- Avoid quick stops and starts when moving the cart.
- Check for uneven floor surfaces such as cracks or cables and cords.

Grounding

This section provides instructions for verifying that the equipment is properly grounded.

Safety Plugs (USA Only)

This equipment may be equipped with either a 3-terminal (grounding-type) safety plug or a 2-terminal (polarized) safety plug. The wide blade or the third terminal is provided for safety. Do not defeat the safety purpose of the grounding-type or polarized safety plug.

To properly ground this equipment, follow these safety guidelines:

- **Grounding-Type Plug** - For a 3-terminal plug (one terminal on this plug is a protective grounding pin), insert the plug into a grounded mains, 3-terminal outlet.
Note: This plug fits only one way. If this plug cannot be fully inserted into the outlet, contact an electrician to replace the obsolete 3-terminal outlet.
- **Polarized Plug** - For a 2-terminal plug (a polarized plug with one wide blade and one narrow blade), insert the plug into a polarized mains, 2-terminal outlet in which one socket is wider than the other.

Note: If this plug cannot be fully inserted into the outlet, try reversing the plug. If the plug still fails to fit, contact an electrician to replace the obsolete 2-terminal outlet.

Grounding Terminal

If this equipment is equipped with an external grounding terminal, attach one end of an 18-gauge wire (or larger) to the grounding terminal; then, attach the other end of the wire to a ground, such as a grounded equipment rack.

Safety Plugs (European Union)

- **Class I Mains Powered Equipment** – Provided with a 3-terminal AC inlet and requires connection to a 3-terminal mains supply outlet via a 3-terminal power cord for proper connection to the protective ground.

Note: The equipotential bonding terminal provided on some equipment is not designed to function as a protective ground connection.

- **Class II Mains Powered Equipment** – Provided with a 2-terminal AC inlet that may be connected by a 2-terminal power cord to the mains supply outlet. No connection to the protective ground is required as this class of equipment is provided with double or reinforced and/or supplementary insulation in addition to the basic insulation provided in Class I equipment.

Note: Class II equipment, which is subject to EN 50083-1, is provided with a chassis mounted equipotential bonding terminal. See the section titled **Equipotential Bonding** for connection instructions.

Equipotential Bonding

If this equipment is equipped with an external chassis terminal marked with the IEC 60417-5020 chassis icon () , the installer should refer to CENELEC standard EN 50083-1 or IEC standard IEC 60728-11 for correct equipotential bonding connection instructions.

AC Power

Important: If this equipment is a Class I equipment, it must be grounded.

- If this equipment plugs into an outlet, the outlet must be near this equipment, and must be easily accessible.
- Connect this equipment only to the power sources that are identified on the equipment-rating label normally located close to the power inlet connector(s).
- This equipment may have two power sources. Be sure to disconnect all power sources before working on this equipment.
- If this equipment **does not** have a main power switch, the power cord connector serves as the disconnect device.

Important Safety Instructions

- Always pull on the plug or the connector to disconnect a cable. Never pull on the cable itself.
- Unplug this equipment when unused for long periods of time.

Connection to -48 V DC/-60 V DC Power Sources

If this equipment is DC-powered, refer to the specific installation instructions in this manual or in companion manuals in this series for information on connecting this equipment to nominal -48 V DC/-60 V DC power sources.

Circuit Overload

Know the effects of circuit overloading before connecting this equipment to the power supply.



CAUTION:

Consider the connection of this equipment to the supply circuit and the effect that overloading of circuits might have on overcurrent protection and supply wiring. Refer to the information on the equipment-rating label when addressing this concern.

General Servicing Precautions



WARNING:

Avoid electric shock! Opening or removing this equipment's cover may expose you to dangerous voltages.



CAUTION:

These servicing precautions are for the guidance of qualified service personnel only. To reduce the risk of electric shock, do not perform any servicing other than that contained in the operating instructions unless you are qualified to do so. Refer all servicing to qualified service personnel.

Be aware of the following general precautions and guidelines:

- **Servicing** - Servicing is required when this equipment has been damaged in any way, such as power supply cord or plug is damaged, liquid has been spilled or objects have fallen into this equipment, this equipment has been exposed to rain or moisture, does not operate normally, or has been dropped.
- **Wristwatch and Jewelry** - For personal safety and to avoid damage of this equipment during service and repair, do not wear electrically conducting objects such as a wristwatch or jewelry.
- **Lightning** - Do not work on this equipment, or connect or disconnect cables, during periods of lightning.
- **Labels** - Do not remove any warning labels. Replace damaged or illegible

warning labels with new ones.

- **Covers** - Do not open the cover of this equipment and attempt service unless instructed to do so in the instructions. Refer all servicing to qualified service personnel only.
- **Moisture** - Do not allow moisture to enter this equipment.
- **Cleaning** - Use a damp cloth for cleaning.
- **Safety Checks** - After service, assemble this equipment and perform safety checks to ensure it is safe to use before putting it back into operation.

Electrostatic Discharge

Electrostatic discharge (ESD) results from the static electricity buildup on the human body and other objects. This static discharge can degrade components and cause failures.

Take the following precautions against electrostatic discharge:

- Use an anti-static bench mat and a wrist strap or ankle strap designed to safely ground ESD potentials through a resistive element.
- Keep components in their anti-static packaging until installed.
- Avoid touching electronic components when installing a module.

Fuse Replacement

To replace a fuse, comply with the following:

- Disconnect the power before changing fuses.
- Identify and clear the condition that caused the original fuse failure.
- Always use a fuse of the correct type and rating. The correct type and rating are indicated on this equipment.

Batteries

This product may contain batteries. Special instructions apply regarding the safe use and disposal of batteries:

Safety

- Insert batteries correctly. There may be a risk of explosion if the batteries are incorrectly inserted.
- Do not attempt to recharge 'disposable' or 'non-reusable' batteries.
- Please follow instructions provided for charging 'rechargeable' batteries.

Important Safety Instructions

- Replace batteries with the same or equivalent type recommended by manufacturer.
- Do not expose batteries to temperatures above 100°C (212°F).

Disposal

- The batteries may contain substances that could be harmful to the environment
- Recycle or dispose of batteries in accordance with the battery manufacturer's instructions and local/national disposal and recycling regulations.



廢電池請回收

- The batteries may contain perchlorate, a known hazardous substance, so special handling and disposal of this product might be necessary. For more information about perchlorate and best management practices for perchlorate-containing substance, see www.dtsc.ca.gov/hazardouswaste/perchlorate.

Modifications

This equipment has been designed and tested to comply with applicable safety, laser safety, and EMC regulations, codes, and standards to ensure safe operation in its intended environment. Refer to this equipment's data sheet for details about regulatory compliance approvals.

Do not make modifications to this equipment. Any changes or modifications could void the user's authority to operate this equipment.

Modifications have the potential to degrade the level of protection built into this equipment, putting people and property at risk of injury or damage. Those persons making any modifications expose themselves to the penalties arising from proven non-compliance with regulatory requirements and to civil litigation for compensation in respect of consequential damages or injury.

Accessories

Use only attachments or accessories specified by the manufacturer.

Electromagnetic Compatibility Regulatory Requirements

This equipment meets applicable electromagnetic compatibility (EMC) regulatory requirements. Refer to this equipment's data sheet for details about regulatory compliance approvals. EMC performance is dependent upon the use of correctly shielded cables of good quality for all external connections, except the power source, when installing this equipment.

- Ensure compliance with cable/connector specifications and associated installation instructions where given elsewhere in this manual.

Otherwise, comply with the following good practices:

- Multi-conductor cables should be of single-braided, shielded type and have conductive connector bodies and backshells with cable clamps that are conductively bonded to the backshell and capable of making 360° connection to the cable shielding. Exceptions from this general rule will be clearly stated in the connector description for the excepted connector in question.
- Ethernet cables should be of single-shielded or double-shielded type.
- Coaxial cables should be of the double-braided shielded type.

EMC Compliance Statements

Where this equipment is subject to USA FCC and/or Industry Canada rules, the following statements apply:

FCC Statement for Class A Equipment

This equipment has been tested and found to comply with the limits for a Class A digital device, pursuant to Part 15 of the FCC Rules. These limits are designed to provide reasonable protection against harmful interference when this equipment is operated in a commercial environment.

This equipment generates, uses, and can radiate radio frequency energy and, if not installed and used in accordance with the instruction manual, may cause harmful interference to radio communications. Operation of this equipment in a residential area is likely to cause harmful interference in which case users will be required to correct the interference at their own expense.

Industry Canada - Industrie Canadienne Statement

This apparatus complies with Canadian ICES-003.
Cet appareil est conforme à la norme NMB-003 du Canada.

CENELEC/CISPR Statement with Respect to Class A Information Technology Equipment

This is a Class A equipment. In a domestic environment this equipment may cause radio interference in which case the user may be required to take adequate measures.

Laser Safety

Introduction

This equipment can be provided with an infrared laser that transmits intensity-modulated light and emits invisible laser radiation.

Warning: Radiation



WARNING:

- **Avoid personal injury! Use of controls, adjustments, or performance of procedures other than those specified herein may result in hazardous radiation exposure.**
 - **Avoid personal injury! The laser light source on the equipment emits invisible laser radiation. Avoid direct exposure to the laser light source.**
 - **Avoid personal injury! Viewing the laser output with optical instruments (such as eye loupes, magnifiers, or microscopes) within a distance of 100 mm may pose an eye hazard.**
- Do not apply power to the equipment if the fiber is unmated or unterminated.
 - Do not stare into an unmated fiber or at any mirror-like surface that could reflect light that is emitted from an unterminated fiber.
 - Do not view an activated fiber with optical instruments (e.g., eye loupes, magnifiers, microscopes).
 - Use safety-approved optical fiber cable to maintain compliance with applicable laser safety requirements.

Warning: Fiber Optic Cables



WARNING:

Avoid personal injury! Qualified service personnel may only perform the procedures in this document. Wear safety glasses and use extreme caution when handling fiber optic cables, particularly during splicing or terminating operations. The thin glass fiber core at the center of the cable is fragile when exposed by the removal of cladding and buffer material. It easily fragments into glass splinters. Using tweezers, place splinters immediately in a sealed waste container and dispose of them safely in accordance with local regulations.

Laser Safety

The following laser safety precautions are applicable to the equipment. According to the type of optical transmitter inside the equipment, there are different laser safety precautions. A laser label that clearly indicates the laser aperture is affixed to the equipment's rear panel.



Depending upon whether you are located in Europe (IEC-standard) or in the U.S. (CDRH-standard), there are different laser safety precautions. For more information about the equipment's laser output, refer to the equipment's data sheet.

Class 1 and Class I Labels

The following illustrations show the class 1 and class I labels attached to the housing, according to the standards.

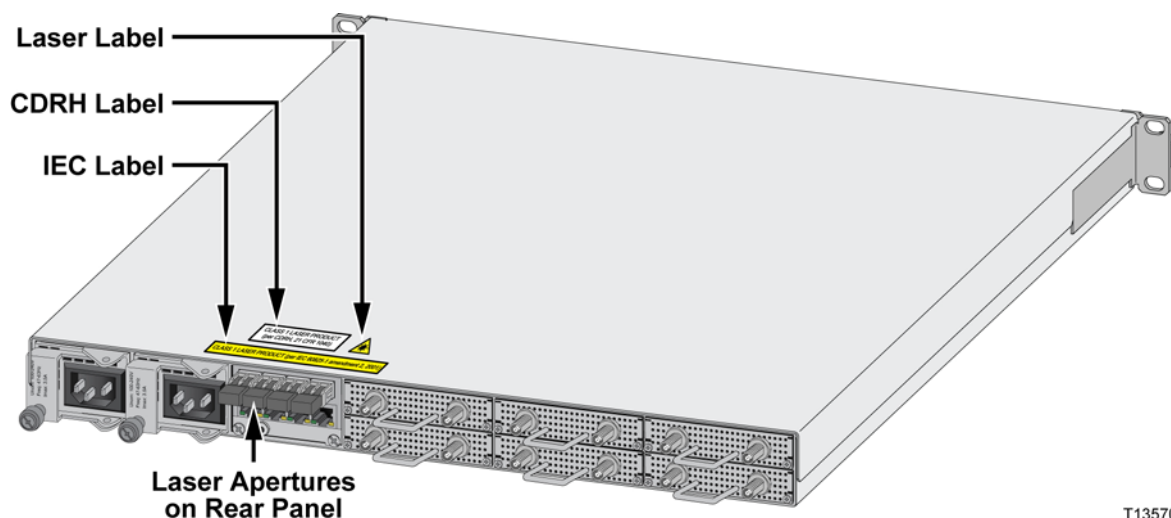

T13570

In Accordance with the IEC Standard

The Laser type SFP modules used are classified in class 1 laser products according to IEC 60825-1, 1997 amendment 2001.

The label below is attached to the top cover and the package of class 1 laser product.

CLASS 1 LASER PRODUCT (per IEC 60825-1 amendment 2, 2001)

In Accordance with the CDRH Standard

The Laser type SFP modules used are classified in class I laser product per CDRH, 21 CFR 1040 Laser Safety requirements.

For the CDRH standard, a certification label is attached to the top cover of each product classified in class I. See also the product ID label affixed to each product.

CLASS I LASER PRODUCT
(per CDRH, 21 CFR 1040)

1

Introduction

The Cisco® RF Gateway 1 is a universal edge QAM (U-EQAM) device that offers industry leading performance, and a standards-based solution for video, data, and converged video and data deployments requiring high density and maximum reliability.

Purpose

This system guide provides the necessary information to install, operate, maintain and upgrade the system. This chapter describes the RF Gateway 1 and presents a summary of the equipment.

Who Should Use This Document

This document is intended for authorized service personnel who have experience working with similar equipment. The service personnel should have appropriate background and knowledge to complete the procedures described in this document.

Qualified Personnel

Only appropriately qualified and skilled personnel should attempt to install, operate, maintain, and service this product.



WARNING:

Allow only qualified and skilled personnel to install, operate, maintain, and service this product. Otherwise, personal injury or equipment damage may occur.

Document Version

This is the second release of this system guide.

In This Chapter

| | |
|--|----|
| ■ Features and Benefits | 3 |
| ■ Modular Concept | 4 |
| ■ Housing | 5 |
| ■ Power Supply | 7 |
| ■ QAM Card | 9 |
| ■ Embedded Graphical User Interface..... | 10 |
| ■ Product Identification | 11 |

Features and Benefits

Primary Benefits

The RF Gateway 1 provides the following benefits for cable operators.

- Rapid time-to-market of QAM-based services
- Maximum spectrum efficiency (SDV, QAM Sharing, 1 GHz) and U-EQAM functionality
- Quality and reliability through a redundant architecture

Primary Features

The primary features are:

- True U-EQAM video (broadcast, SDV SD/HD, MPEG-2, AVD) and high-speed data
- M-CMTS/DTI, DOCSIS 3.0 in 1RU form factor
- Table-based or session-based video functionality
- 48 configurable QAM channels
- Redundant design with redundant Ethernet, DOCSIS timing interface ports, and power supplies
- Front-to-back airflow
- Low-power consumption
- Internet Group Management Protocol Version 3 (IGMPv3) support

Modular Concept

The RF Gateway 1 is a fully modular concept built around a 1 RU high housing. The flexible modular concept ensures easy system capacity upgrades.

The following illustration is a front view of the RF Gateway 1.



The following equipment is available:

- -48 V DC or 100 - 240 V AC Power Supply Unit (PSU)
- Hot swappable 8-channel QAM Card (4 QAM channels per F connector).
- Pluggable Input Card (not hot swappable)

Housing

LED Indicators

The following table describes the LED indicators on the front panel.

| Label | Type | Description |
|-----------|----------------|---|
| ALARM | Red | Indicates a pending alarm or error detected by the processor |
| PS1 | Solid Green | The PS1 power supply active |
| | Flashing Green | The PS1 power supply in alarm state |
| | Off | No PS1 power supply available |
| PS2 | Solid Green | The PS2 power supply active |
| | Flashing Green | The PS2 power supply in alarm state |
| | Off | No PS2 power supply available |
| GBE 1-4 | Solid Green | SFP Present and Ethernet link achieved |
| | Flashing Green | Indicates data activity |
| | Off | Indicates no Ethernet link |
| QAM 1 - 6 | Solid Green | Indicates the module is in the corresponding slot and ready for use |
| | Off | No card inserted/card is not ready for use |

Connectors

The following table describes the connectors on the rear panel.

| Label | Type | Description |
|---------------------------------|-----------------------------|---|
| RF Connectors | F | RF output |
| GbE 1-4 | SFP (optical or electrical) | IP input |
| Ethernet 10/100BT | RJ-45 | 10/100Base-T Ethernet port to manage the device |
| Ethernet 10/100BT | RJ-45 | Conditional access key handling |
| Primary DOCSIS Timing Interface | RJ-45 | DOCSIS Primary Interface |
| Backup DOCSIS Timing Interface | RJ-45 | DOCSIS Backup Interface |

Additional Information

For additional information about housing specifications, refer to *Appendix A Technical Specifications* (on page 41).

Power Supply

Introduction

The RF Gateway 1 has 1+1 redundancy which allows the system to remain fully operational if one of the power supplies is removed or fails. Each power supply generates a 12 V DC supply voltage, capable of supplying the whole unit. The following illustration shows the AC Power Supply Unit (PSU).

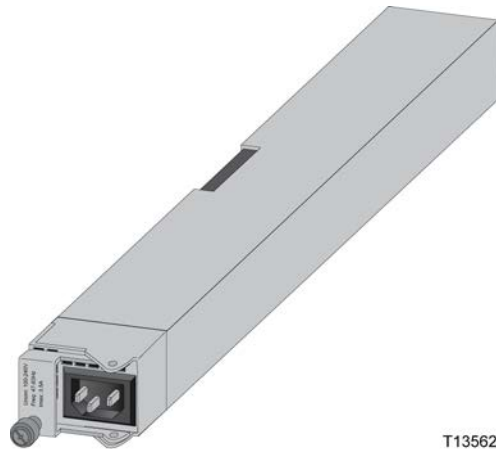

Two PSUs are available:

- 100 - 240 V AC (part number 4015490)
- -48 V DC (part number 4015491)

For additional information, refer to *Appendix A Technical Specifications* (on page 41).

AC PSU Features and Benefits

The standard features and benefits of the AC PSU are:

- Universal AC input
- Max output power 29A
- 85% typical efficiency
- Hot pluggable
- Current sharing based on droop method
- Power Factor Corrected. EN 61000-3-2 compliant
- 1 isolated fully protected 12 V DC output

DC PSU Features and Benefits

The standard features and benefits of the DC PSU are:

- Universal DC input (-36 - 72 V DC)
- Max output power 29A
- 85% typical efficiency
- Hot pluggable
- Current sharing based on droop method
- 1 isolated fully protected 12 V DC output

QAM Card

General

Each RF output port contains four combined adjacent QAM channels.

You can install a maximum of six QAM Cards inside the housing. When installing a QAM Card in the housing, all settings are automatically loaded from the system controller and the card is immediately in service.

The following illustration shows the QAM Card.

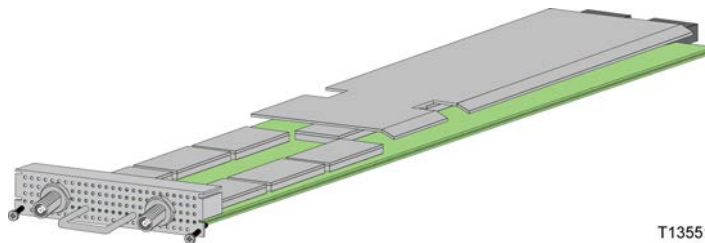

For additional information, refer to *Appendix A Technical Specifications* (on page 41).

Features and Benefits

The standard features and benefits are:

- New DirectRF technology significantly reduces the price per stream
- Works with all major VOD server brands
- Hot swappable: after insertion, settings for the card location are loaded and the board starts functioning
- Extremely low power consumption
- QAM modulation (64 & 256) according to DVB (ITU-A), OpenCable (ITU-B) or ITU-C
- Excellent MER (≥ 45 dB @ RF) and BER ($\leq 5 \times 10^{-9}$ pre-FEC and $\leq 1 \times 10^{-13}$ post-FEC @256 QAM)
- Fully agile from 45 to 1000 MHz (channel edges within that range)
- RF specifications exceeding (EURO) DOCSIS requirements
- Provides 4 adjacent QAM carriers per RF port

Embedded Graphical User Interface

Introduction

The RF Gateway 1 can be configured and monitored via an embedded graphical user interface (GUI) that can be accessed with a standard web browser.

The following shows the start page of the embedded GUI.

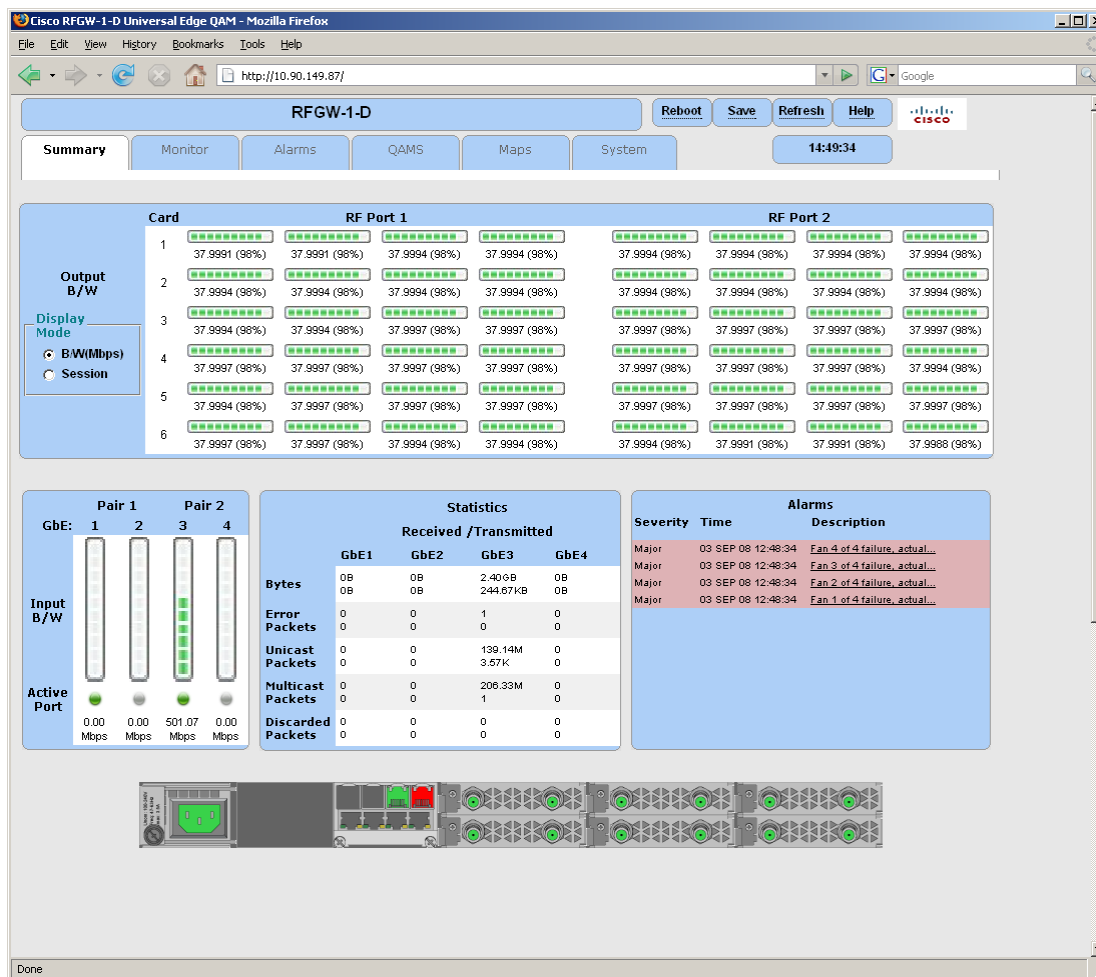

To access the embedded GUI, enter the IP address of the device in the address box of the web browser. For information on how to enter the IP address, refer to the *Cisco RF Gateway 1 Configuration Guide*, part number 4025112.

Product Identification

Introduction

Products can be identified by the ID label attached to the product.

The following information is available on the label(s).

- Company address
- Model number
- Serial number
- Part number
- Nominal supply voltage
- Maximum current

This information may be necessary if returning your unit.

2

Installation

This chapter contains instructions for installing the RF Gateway 1 and describes the site requirements, equipment and tools needed for installation.

In This Chapter

- Preparing for Installation..... 14
- Site Requirements 16
- Rack Mounting..... 17
- Installing and Removing RF Gateway 1 Components 19
- Connecting Cables 24

Preparing for Installation

Before you begin, make sure the chassis is in good condition and that you have the tools and equipment needed.

Tools and Accessories

You need the following tools and accessories for mounting the unit:

- Screwdriver
- Rails and screws

Unpacking and Inspecting the Module

As you unpack the module, inspect it for shipping damage. If you find any damage, contact Customer Service. Refer to *Customer Support Information* (on page 39) for information on contacting Customer Service.

Chassis Dimensions

The following drawing shows the dimensions of the RF Gateway 1 housing.

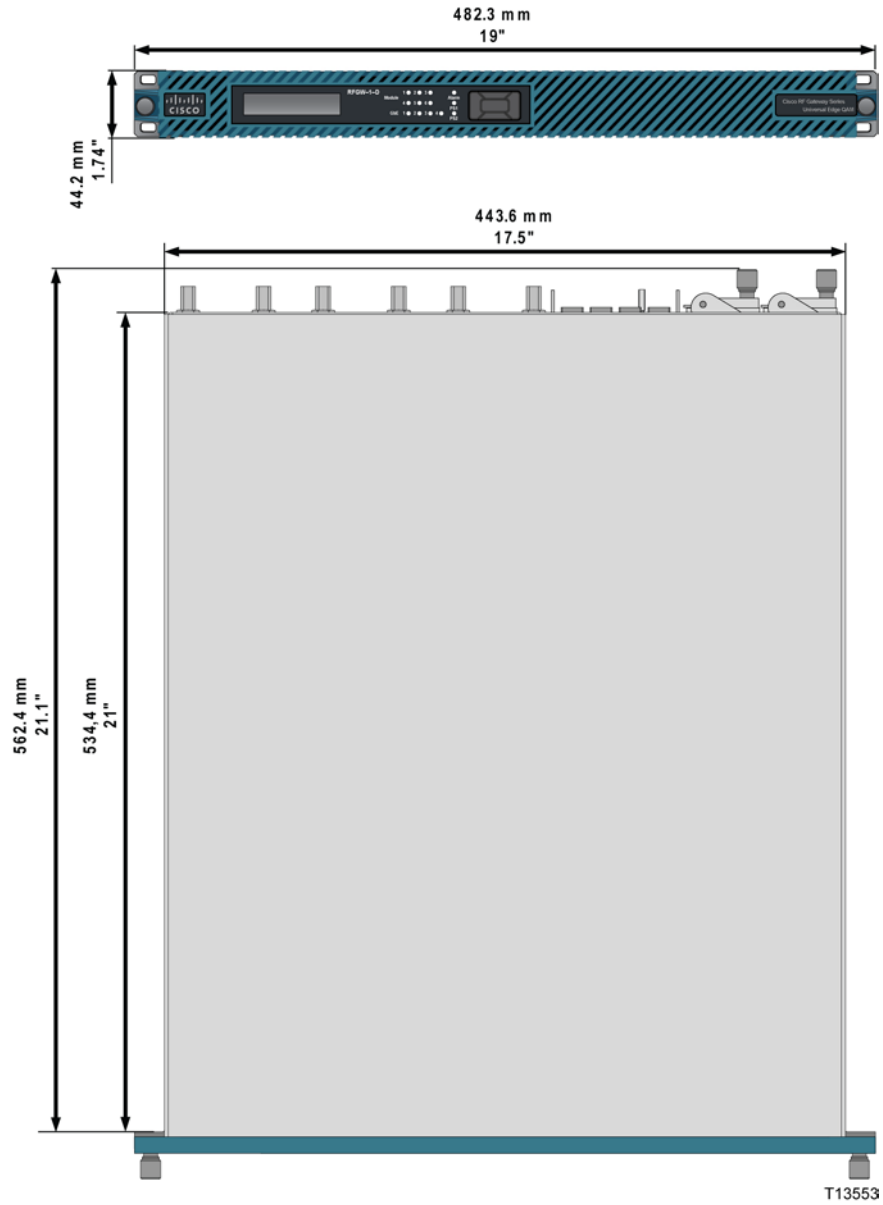

Site Requirements

Before you begin, make certain that your installation site meets the requirements discussed in this section.

Access Requirements

Ensure that only authorized personnel have access to this equipment. Otherwise, personal injury or equipment damage may occur.



WARNING:

Use this product in locations that restrict access to all persons who are not authorized. Otherwise, personal injury or equipment damage may occur.

Equipment Rack

To install this module, your site must be equipped with an Electronics Industry Association (EIA) equipment rack that properly houses the chassis with proper spacing for air circulation. For instructions on installing the chassis in the rack, refer to *Mounting the RF Gateway 1* (on page 17).

Operating Environment



CAUTION:

Avoid damage to this product! Operating this product outside the specified operating temperature limits voids the warranty.

Follow these recommendations to maintain an acceptable operating temperature of the equipment.

- Temperature at the air inlet must be between 0°C and 50°C (32°F and 122°F).
- Keep cooling vents clear and free of obstructions.
- Provide ventilation as needed using air-deflecting baffles, forced-air ventilation, or air outlets above enclosures, either alone or in combination.

Rack Mounting

Tools and Accessories

You need the following tools and accessories for mounting the unit:

- Screwdriver
- Support brackets and rack mounting screws.

Mounting Requirements

Follow the mounting guidelines below:

- Use 19-inch racks with the appropriate depth.
- Mount the unit adequately to secure optimal operation and reliability.
- Use rack-compatible support brackets to support the unit properly.
- Pay attention to the mechanical loading and stability to avoid hazardous situations.
- The RF Gateway 1 was designed such that no empty rack units are required between adjacent chassis.

Mounting the RF Gateway 1



CAUTION:

It is very important that the RF Gateway 1 and its components be placed in a conditioned room within ambient temperature specifications. For more information, refer to Appendix A Technical Specifications (on page 41).

To Mount the RF Gateway 1 in a Rack

- 1 Unpack the device. Refer to *Unpacking and Inspecting the Module* (on page 14).
- 2 Select a location in the rack that has 1 RU of space for installation.
- 3 If the rack holes are not threaded, install a cage nut in the top and bottom holes on the selected RU space.
- 4 Mount left and right support brackets in the 19-inch rack.



CAUTION:

Installing the RF Gateway 1 without support brackets may result in damage to the device.

- 5 Slide the housing completely into the 19-inch rack with the bottom supported by the brackets.

Chapter 2 Installation

- 6 Insert the front panel rack mounting screws through the washers into the threaded holes or cage nuts.
- 7 Tighten the front panel rack mounting screws.

Installing and Removing RF Gateway 1 Components

Installing/Removing the PSU



CAUTION:

- During installation, the module connector must align evenly with the connector inside the module slot. Misalignment may cause the connector pins to bend.
- Modules contain static-sensitive devices. Always follow proper electrostatic discharge (ESD) handling procedures (wristband with ground strap and ESD mat) when installing modules in the housing. Follow Electronic Industries Association (EIA) standard EIA-625.

The following illustration shows the location of PSU1 and PSU2.

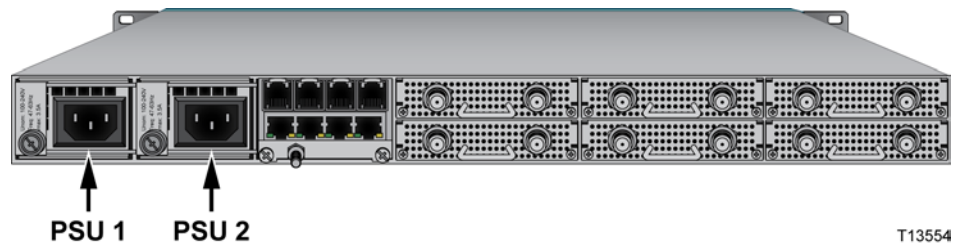

The following illustration shows the PSU installed.



To Install the PSU

- 1 Loosen the thumbscrew and pull back the face of the PSU.
- 2 Slide the PSU into the appropriate slot as shown above.

Chapter 2 Installation

- 3 Push the PSU in carefully, making sure the latch fits into the holes of the flange on the right side of the unit. This properly seats the PSU.
- 4 Tighten the thumb screw.
- 5 Connect the power cord.

To Remove a PSU

- 1 Remove the power cord from the PSU.
- 2 Unscrew the thumb screw.
- 3 Pull the latch and disengage from the flange.
- 4 Firmly pull and remove the PSU.

Installing/Removing the QAM Card

The housing contains 6 hot-pluggable QAM Cards. These cards occupy slots 1-6 of the housing. The following illustration shows the 6 QAM card slots in the housing.

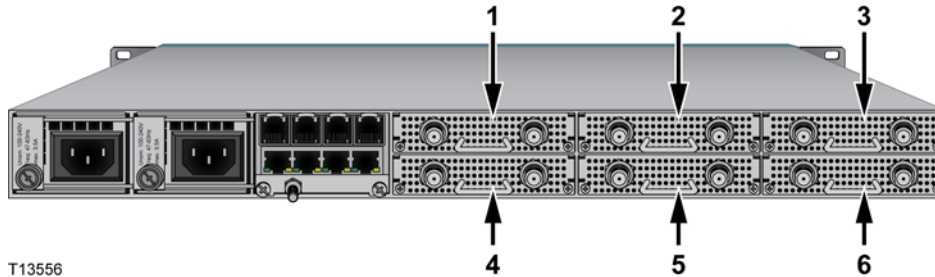

T13556

Note:

- For cooling purposes, install card blanks in the unpopulated slots.

To Install the QAM Card

Note: When a QAM Card is installed in the chassis and connected to the ground via the power cord or via an earth bonding wire, the wristband with ground strap should be connected to the ESD socket of the chassis. See illustration below.

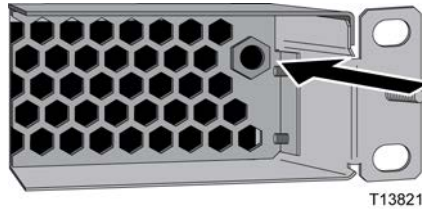

- 1 Slide the card in the card guides of the slot as shown in the illustration.

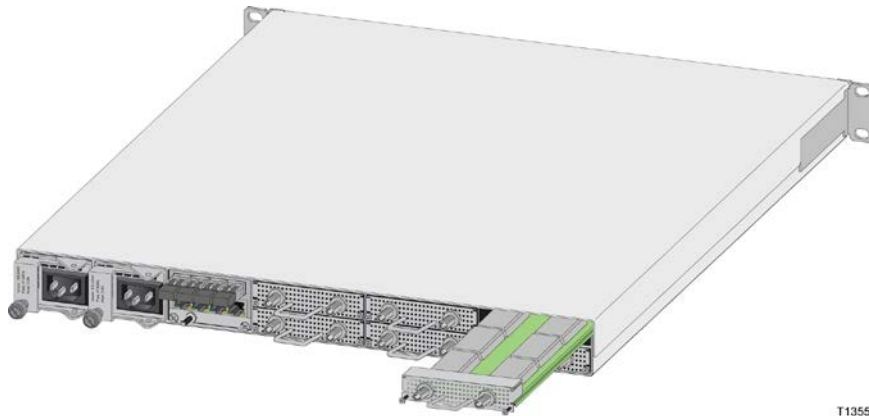

- 2 Push the card in carefully making sure the QAM Card aligns with the system controller connector.

Note: After the QAM Card is inserted, the card loads settings from the system controller board and immediately starts running.

- 3 Tighten the QAM Card screws.

To Remove a QAM Card

Important: It is recommended that the user disable the QAM Card on the GUI, (turn port control off) to prevent unintended service glitches on other channels.

- 1 Loosen the QAM Card screws.
- 2 Pull the QAM Card by its handle and gently remove from the housing.

Installing/Removing SFP Modules

The housing has 4 ports that can be configured with electrical or optical small form-factor pluggable (SFP) modules. The SFP transceivers have three different types of latching devices used to secure and detach the SFP module from a Gigabit Ethernet port:

- The Tab SFP transceiver (a)
- The Button SFP transceiver (b)

- The Cam Latch SFP transceiver (c)

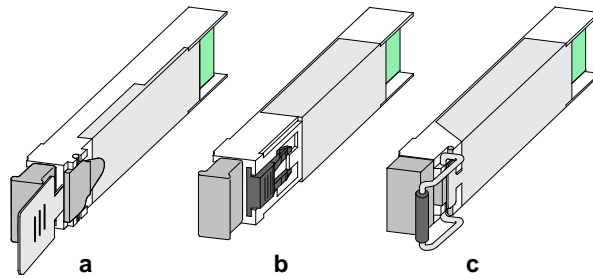

WARNING:

Invisible laser radiation may be emitted from disconnected optical fibers or connectors. Do not stare into beams or view directly with optical instruments.

Notes:

- When the cables are extracted from the SFP transceiver, insert a clean rubber dust plug into the SFP transceiver to protect the transceiver.
- Clean the optic surface of the fiber cables before inserting into an optical SFP transceiver. Refer to *Optical Connector Cleaning Guidelines* (on page 36).

To Install an SFP Module

- 1 Slide the SFP module into the housing located on the back of the RF Gateway 1.

Note:

- Before inserting a Cam Latch SFP module, close the latch as shown below.

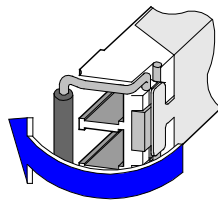

- 2 Gently pull on the SFP module to make sure the module is locked in place.

To Remove an SFP Module

- 1 Unplug the optical fiber or electrical cable from the SFP module.
- 2 Remove the SFP module according to the instructions below.

- To remove a Tab SFP module, pull the tab gently until the module disengages from the port. Pull the SFP module out.

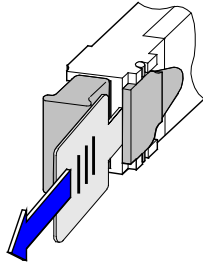

- To remove a Button SFP module, gently press the actuator/button on the front of the module until it clicks and the latch mechanism activates, releasing the module from the port.

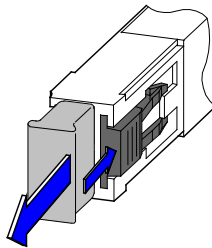

- To remove a Cam latch SFP module, remove the rubber dust plug from the module if present. Open the latch on the module and then pull the module out.

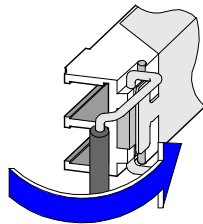

- To protect the module, it is recommended that you insert a clean rubber dust plug.

Connecting Cables

Connecting AC Power

The RF Gateway 1 is equipped with an AC mains input connector. For the allowable nominal voltage, refer to the ratings label on the power supply module.

To Connect AC Power

- 1 Connect the AC power cord to the back of the device.

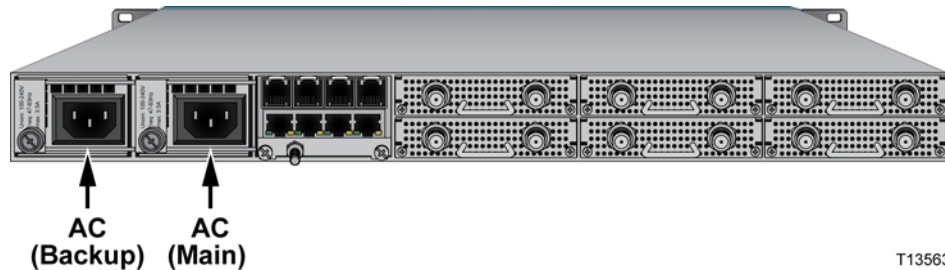

- 2 Connect the power cord to the AC power outlet.

Notes:

- If your system is equipped with two AC power supply units, it is recommended that you plug each power supply unit into a separate dedicated branch circuit.
- Once the system is powered up, the device starts booting.



CAUTION:

Do not insert or unplug a power supply from the chassis without disconnecting the power source.

Connecting DC Power

The DC PSU is designed and rated for connection to -48 V DC nominal power. Normal service voltage range should not exceed -38 V DC to -58 V DC.

**WARNING:**

- Use a listed DC rated Branch Circuit protection in accordance with the wire size, and with a maximum of 15 A current. The circuit protection must be placed in the hot wire.
- We recommend a minimum of 1.5 mm² (or AWG16) for 15 A fusing.
- The DC power source must be electrically isolated from the Mains AC source in accordance with the standard of the country where you are installing the product.
- The wire size of the cable used to connect a product to the DC distribution module or bus bar must have the appropriate wire size to avoid overloading.
- Always wire the protective earth terminal of the DC power supply connector or cable.

To Connect to Centralized DC Power Systems

A centralized DC power distribution system (typically -48 V DC) is a power system consisting of open batteries, charger/rectifier circuits, and primary, and secondary distribution equipment intended to provide power to equipment loads. Two types of systems exist:

- **Source earthed DC power systems:** connection to the earthing electrode is located at the source, and separate earthed and protective earth conductors, are provided throughout the system.
- **DC power system earthed at the equipment location:** connection to the earthing electrode is located in the area where the load equipment is installed.

A typical power distribution architecture is shown below:

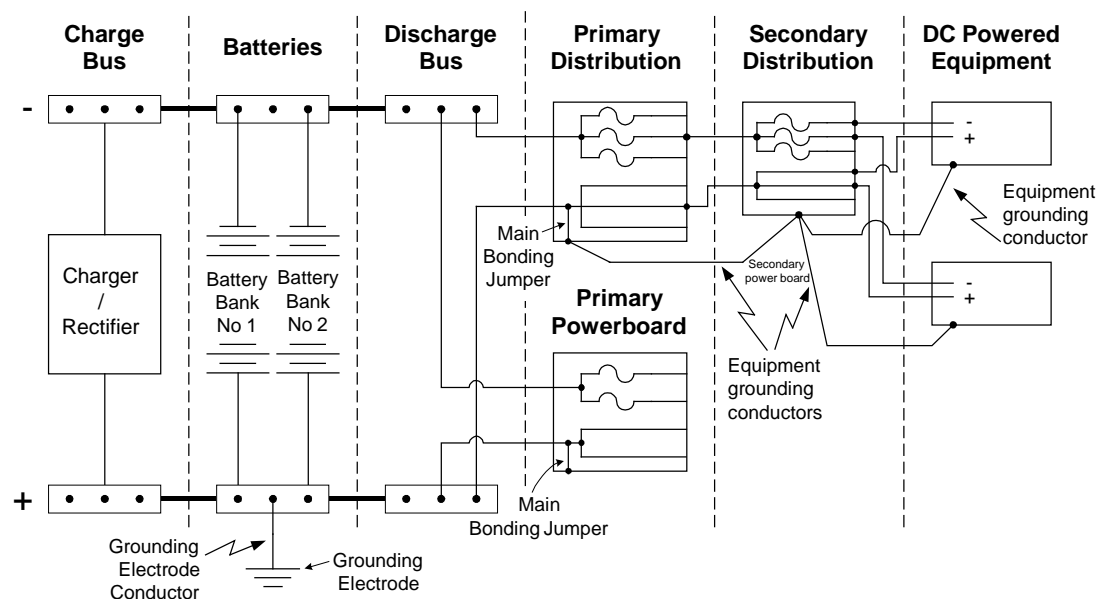

To Connect to a DC Power Source

The following illustration shows the main and backup connector for the -48 V DC power supply and the power supply connector pinout.

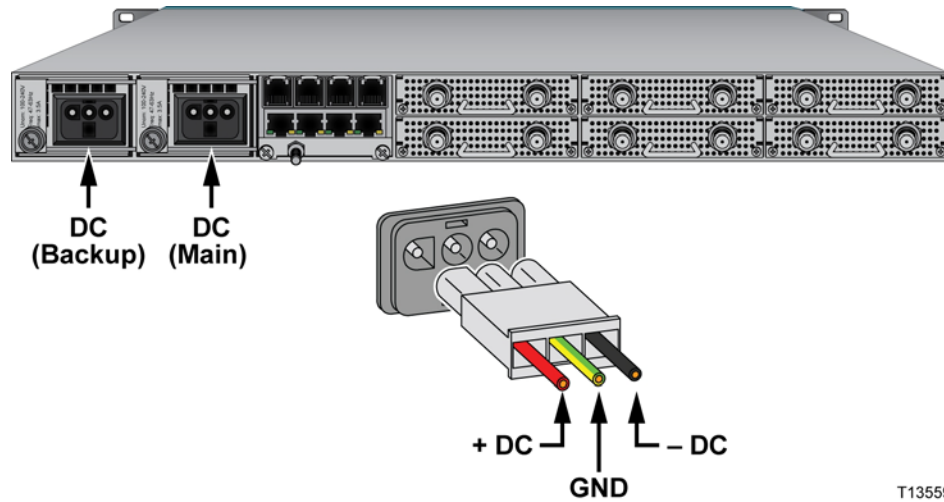

Note: Make sure the DC mains source voltage (-38 to -58 V DC) corresponds to the appropriate power input voltage for the unit. This voltage is noted on the back of the chassis.

 **WARNING:**
Pay close attention when making DC power source connections. Incorrect connections may result in damage to the PSU module.

Cabling the Earth-Bonding Terminal

- 1 Remove the nut and washer from the earth-bonding terminal. See illustration below.

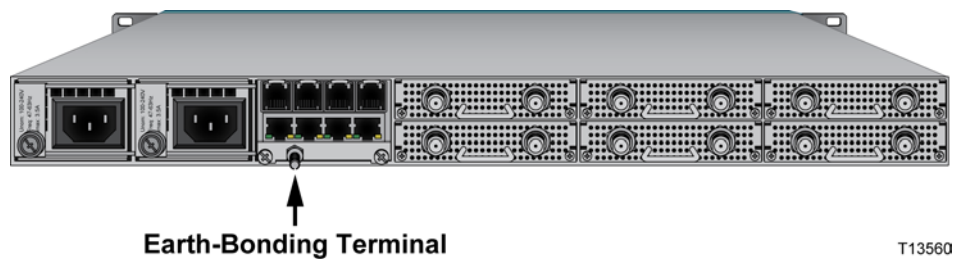

- 2 Place the eye strap of the earth-bonding wire over the terminal.
- 3 Replace the washer and the nut.
- 4 Tighten the nut.

Connecting the Input and Output Cables

RF Output Connectors

The housing is equipped with 12 RF output connectors. These RF outputs are indicated by two digits separated by a slash. The first digit indicates the slot position of the QAM Card and the second digit is the RF output on the QAM Card. The following illustration shows the RF output connector numbering.

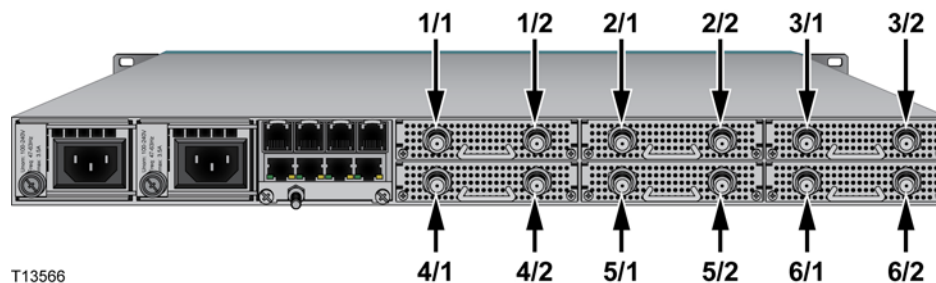

The RF outputs are F-type connectors. These connectors should only accept a coaxial cable center conductor between 0.56 mm and 1.19 mm in diameter.



CAUTION:

- Do not use a coaxial cable center conductor smaller than 0.56 mm or larger than 1.19 mm. Damage or loss of signal may occur.
- If a large diameter center conductor is inserted into an F-type connector, it cannot then be replaced with a smaller conductor. Loss of signal may occur.

IP Input Connectors

The RF Gateway 1 contains 4 Gigabit Ethernet ports. The following illustration shows the Gigabit Ethernet ports.

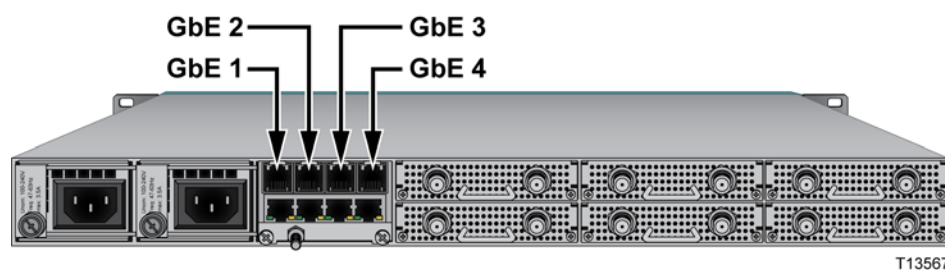

The following table shows the pin configuration of an electrical SFP module.

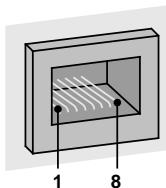

| Pin Number | Name |
|------------|-------|
| 1 | TRD0+ |
| 2 | TRD0- |
| 3 | TRD1+ |
| 4 | TRD2+ |
| 5 | TRD2- |
| 6 | TRD1- |
| 7 | TRD3+ |
| 8 | TRD3- |

Ethernet Connectors

The RF Gateway 1 has two Ethernet ports. The first 10/100Base-T Ethernet port can be used for management purposes. This Ethernet port has a unique MAC address and IP address (default 150.158.231.250). The second 10/100Base-T Ethernet port can be used for conditional access key handling (future use only).

You can assign another IP address to the Ethernet port using the front panel controls or the graphical user interface (GUI). The following illustration shows the 10/100Base-T Ethernet port.



The following table shows the pin configuration of a 10/100Base-T RJ-45 connector:

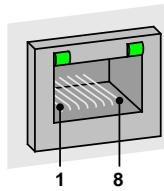

| Pin | Description (MDIX) | Name | Pin | Description (MDI) | Name |
|-----|--------------------|------|-----|-------------------|------|
| 1 | Receive data + | RD+ | 1 | Transmit data + | TD+ |
| 2 | Receive data - | RD- | 2 | Transmit data - | TD- |
| 3 | Transmit data + | TD+ | 3 | Receive data + | RD+ |
| 4 | Not used | - | 4 | Not used | - |
| 5 | Not used | - | 5 | Not used | - |
| 6 | Transmit data - | TD- | 6 | Receive data - | RD- |
| 7 | Not used | - | 7 | Not used | - |
| 8 | Not used | - | 8 | Not used | - |

Note: You can connect your PC directly to the 10/100Base-T Ethernet port of the housing using an Ethernet crossover cable. The following table gives the pin configuration of an Ethernet crossover cable.

| Pinout Connector 1 | Pinout Connector 2 |
|--------------------|--------------------|
| 1 | 3 |
| 2 | 6 |
| 3 | 1 |
| 4 | open |
| 5 | open |
| 6 | 2 |
| 7 | open |
| 8 | open |

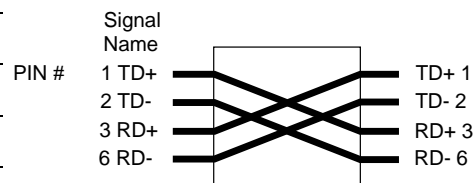

DOCSIS Timing Interface Connectors

The RF Gateway 1 has two DOCSIS timing ports. The following illustration shows the DOCSIS Timing Interface.

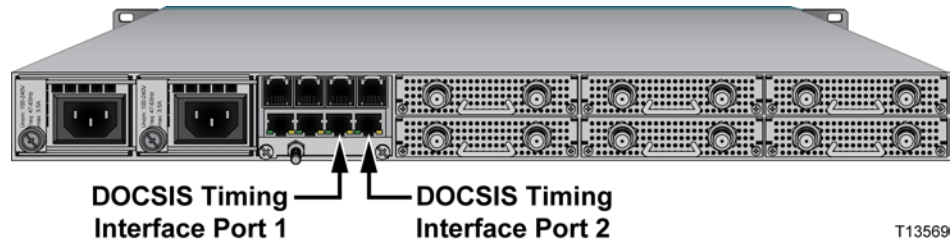

T13569

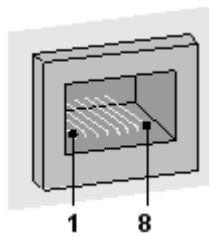

| Pin | Description | Name |
|-----|--------------|-------|
| 1 | DTI Signal + | SIG + |
| 2 | DTI Signal - | SIG - |
| 3 | not used | NC |
| 4 | not used | NC |
| 5 | not used | NC |
| 6 | not used | NC |
| 7 | not used | NC |
| 8 | not used | NC |

3

Maintenance and Troubleshooting

This chapter provides information to assist you in maintaining and troubleshooting the RF Gateway 1.

In This Chapter

| | |
|---|----|
| ■ Maintenance | 32 |
| ■ Troubleshooting | 34 |
| ■ Optical Connector Cleaning Guidelines | 36 |

Maintenance

Maintaining the Equipment

To ensure optimal performance, the following maintenance is recommended.

| Frequency | Maintenance Required |
|-------------|---|
| Weekly | Check all parameters |
| Quarterly | Make sure all cables are mated properly. Inspect cables for stress and chafing. Make sure all retaining screws are tight. |
| When needed | Carefully clean the module with a soft cloth that is dampened with mild detergent. |

Replacing a Fan

A fan malfunction alarm indicates that at least one of the fans is malfunctioning.



WARNING:

When the front cover is removed, an ESD wrist strap should be used to prevent damage to the device.

- 1 Loosen the thumb screws on the front of the housing and remove the front cover.
Important: Make sure the wrist strap is attached.
- 2 Depress the tab on the side of the fan connector and pull to remove the fan cable.
- 3 Remove the two fan screws.
- 4 Remove the defective fan.
- 5 Install the new fan as shown in the illustration.

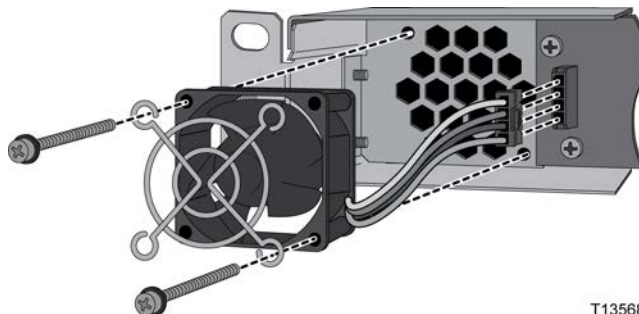

Note: Ensure proper orientation of the fan. A fan that is not installed properly will not cool the device.

- 6 Replace the two fan screws.
- 7 Reattach the fan cable.

- 8 Disconnect the wrist strap.
- 9 Replace the front cover, taking care not to pinch the ribbon cable.
- 10 Tighten the front cover thumb screws.

Troubleshooting

Checking LED Indicators

The housing contains the following LED indicators on the front panel.

- PS1 LED indicator
- PS2 LED indicator
- SFP 1-4 indicator
- QAM 1-6 indicator
- ALARM LED indicator

| LED Status | Indication | Recommended Action |
|-------------------------------|--|--|
| PS1 indicator off | No PS1 power supply installed | Install a PSU1 power supply |
| PS1 indicator solid green | PS1 active | OK - no action required |
| PS1 indicator flashing green | PS1 in alarm state | Attempt to restart by disconnecting power source. If alarm state persists, replace power supply. |
| PS2 indicator off | No PS2 power supply installed | Install a PSU2 power supply |
| PS2 indicator solid green | PS2 active | OK - no action required |
| PS2 indicator flashing green | PS2 in alarm state | Attempt to restart by disconnecting power source. If alarm state persists, replace power supply. |
| SFP1 indicator off | No SFP installed in slot 1 or no Ethernet link | Install the SFP, check auto-negotiation settings for GbE1 |
| SFP1 indicator solid green | SFP1 has Ethernet link, no data | Verify that data is properly routed to the RF Gateway 1 |
| SFP1 indicator flashing green | SFP1 active | OK - no action required |
| SFP2 indicator off | No SFP installed in slot 1 or no Ethernet link | Install the SFP, check auto-negotiation settings for GbE2 |
| SFP2 indicator solid green | SFP2 has Ethernet link, no data | Verify that data is properly routed to the RF Gateway 1 |
| SFP2 indicator flashing green | SFP2 active | OK - no action required |

| LED Status | Indication | Recommended Action |
|-------------------------------|---|---|
| SFP3 indicator off | No SFP installed in slot 1 or no Ethernet link | Install the SFP, check auto-negotiation settings for GbE3 |
| SFP3 indicator solid green | SFP3 has Ethernet link, no data | Verify that data is properly routed to the RF Gateway 1 |
| SFP3 indicator flashing green | SFP3 active | OK - no action required |
| SFP4 indicator off | No SFP installed in slot 1 or no Ethernet link | Install the SFP, check auto-negotiation settings for GbE4 |
| SFP4 indicator solid green | SFP4 has Ethernet link, no data | Verify that data is properly routed to the RF Gateway 1 |
| SFP4 indicator flashing green | SFP4 active | OK - no action required |
| QAM1 indicator off | No QAM card in slot 1 | Install QAM card |
| QAM1 indicator solid green | QAM1 active | OK - no action required |
| QAM2 indicator off | No QAM card in slot 2 | Install QAM card |
| QAM2 indicator solid green | QAM2 active | OK - no action required |
| QAM3 indicator off | No QAM card in slot 3 | Install QAM card |
| QAM3 indicator solid green | QAM3 active | OK - no action required |
| QAM4 indicator off | No QAM card in slot 4 | Install QAM card |
| QAM4 indicator solid green | QAM4 active | OK - no action required |
| QAM5 indicator off | No QAM card in slot 5 | Install QAM card |
| QAM5 indicator solid green | QAM5 active | OK - no action required |
| QAM6 indicator off | No QAM card in slot 6 | Install QAM card |
| QAM6 indicator solid green | QAM6 active | OK - no action required |
| ALARM indicator on | Pending alarm or error detected by the CPU module | Troubleshoot the alarm or error message |

Optical Connector Cleaning Guidelines

Optical Connector Cleaning Overview

Cleaning fiber-optic connectors can help prevent interconnect problems and therefore aid system performance. When optical connectors are disconnected and reconnected, the fiber surface can become dirty or scratched. The goal of cleaning the fiber optic connectors is to remove all dust and contaminants without leaving any residue.

Recommended Equipment

The following equipment is recommended to clean the ends of fiber-optic connectors.

- CLETOP or OPTIPOP ferrule cleaner (CLETOP Type A for SC, Type B for LC)
- Compressed air (also called “canned air”)
- Lint-free wipes moistened with optical-grade (99%) isopropyl alcohol
- Bulkhead swabs for LC or SC type connectors (choose appropriate type)
- Optical connector scope

Tips for Optimal Connector Performance

Follow these guidelines to ensure optimal connector performance.

- Do not connect or disconnect optical connectors while optical power is present.
- Always use compressed air before cleaning the fiber-optic connectors.
- Always use end caps on connectors when they are not in use.
- Always use compressed air to clean the end caps.
- If you have any degraded signal problems, clean the fiber-optic connector.
- Advance a clean portion of the ferrule cleaner reel for each cleaning.

To Clean Optical Connectors



Warning:

- **Avoid personal injury! Use of controls, adjustments, or procedures other than those specified herein may result in hazardous radiation exposure.**
- **Avoid personal injury! The laser light source on this equipment (if a transmitter) or the fiber cables connected to this equipment emit invisible laser radiation.**
- **Avoid personal injury! Viewing the laser output (if a transmitter) or fiber cable with optical instruments (such as eye loupes, magnifiers, or microscopes) may pose an eye hazard.**

- Do not apply power to this equipment if the fiber is unmated or unterminated.
- Do not stare into an unmated fiber or at any mirror-like surface that could reflect light emitted from an unterminated fiber.
- Do not view an activated fiber with optical instruments (e.g., loupes, magnifiers, microscopes).
- Use safety-approved optical fiber cable to maintain compliance with applicable laser safety requirements.

Important: Ensure that no optical power is present prior to this procedure.

- 1 Turn optical power off to the connector.
- 2 Using an optical connector scope, inspect the connector for scratches, burns, or other signs of damage.

Note: If the connector is damaged, replace the jumper.

- 3 If the connector requires cleaning, swipe it across the face of the appropriate ferrule cleaner several times.

Result: This will remove dust and some films.

Note: You may hear a slight "squeak" while cleaning the connector, indicating that it is clean.

- 4 Inspect the connector again. If the connector requires further cleaning, clean it using 99% isopropyl alcohol and a lint free wipe.
- 5 Swipe the connector across the face of the appropriate ferrule cleaner several more times to remove any film left by the alcohol.
- 6 Repeat all the steps above as needed until the connector is clean.

4

Customer Support Information

If You Have Questions

If you have technical questions, call Cisco Services for assistance. Follow the menu options to speak with a service engineer.

Access your company's extranet site to view or order additional technical publications. For accessing instructions, contact the representative who handles your account. Check your extranet site often as the information is updated frequently.

A

Technical Specifications

About This Appendix

This appendix provides system specifications for the RF Gateway 1.

Note: Technical specifications are subject to change without prior notice.

In This Appendix

- General Specifications 42
- Electrical Specifications..... 44

General Specifications

Introduction

The following table lists the general specifications of the RF Gateway 1 equipment.

Environmental Specifications

| Item | Specification |
|---------------------------|----------------------------|
| Ambient temperature range | |
| ■ Within specs | 0 to 50°C (32 to 122°F) |
| ■ Operation | 0 to 50°C (32 to 122°F) |
| ■ Storage | -40 to 70°C (-40 to 158°F) |
| Operating humidity | 5% to 95%, non-condensing |

Chassis Mechanical Specifications

| Item | Specification |
|--------|---------------------------|
| Height | 1.75 in. (44.5 mm) (1 RU) |
| Width | 19 in. (482.6 mm) |
| Depth | 21 in. (533.4 mm) |
| Weight | 27.5 lbs (12.5 kg) |

Physical

| Item | Specification |
|-----------------------|-------------------------------|
| Dimension | |
| ■ In mm (H x W x D) | 44.5 mm x 482.6 mm x 533.4 mm |
| ■ In inch (H x W x D) | 1.75" x 19" x 21" |
| Weight | |
| ■ Fully loaded | 12.5 kg (27.5 lbs) |
| ■ Empty housing | 6.6 kg (14.5 lbs) |

Power Supply Specifications

| Item | Specification |
|-----------------------------|--|
| Power supply (nominal) | 100 - 240 V AC \pm 10% -48 V DC (voltage range -38 to -58 V DC) |
| Power consumption (nominal) | Typical < 375 Maximum < 410 W |

Electrical Specifications

GbE Input Interface

| Item | Specification |
|--------------------|--|
| Number of inputs | 2 + 2 (for redundancy) |
| Connector | Electrical and optical small form factor pluggable (SFP) |
| Interface type | Gigabit Ethernet according to IEEE 802.3ab (electrical) or IEEE 802.3z (optical) |
| Data rate | Full line rate |
| Syntax | VBR and CBR MPEG SPTS and MPTS on UDP (RFC-768), RTP, L2TPv3, IGMPv3 |
| Dejitter Buffering | 150 ms |

Management Interface

| Item | Specification |
|----------------|-----------------------|
| Interface type | Ethernet 10/100Base-T |
| Connector | 1 x RJ 45 |
| Protocols | HTTP, SNMP, FTP, RPC |

DTI Interface

| Item | Specification |
|----------------|---------------------------------|
| Interface type | Ethernet 10/100Base-T |
| Connector | 2 x RJ 45 Primary and Redundant |

RF Outputs

| Item | Specification |
|-------------------|---|
| Number of outputs | Max. 12 (each with 4 adjacent QAM channels) |
| Connector | F-type, 75 Ω |
| Frequency | |

| | |
|-------------------|--|
| ■ Range | Channel edges between 45 and 1000 MHz (tunable) |
| ■ Step size | 1 kHz |
| ■ Stability | ± 3 ppm |
| ■ Accuracy | ± 3 ppm |
| Channel bandwidth | 6, 7 or 8 MHz depending on QAM standard |
| Level | |
| ■ Range | Quad Mode: 53 dBmV RMS Max per QAM channel in 0.1 dB steps Dual Mode: 57 dBmV RMS Max per QAM channel in 0.1 dB steps Single Mode: 61 dBmV RMS Max per QAM channel in 0.1 dB steps |
| ■ Stability | ± 1 dB |
| ■ Accuracy | ± 1 dB |
| Return loss | > 14 dB 45-750 MHz > 13 dB 750-870 MHz > 12 dB 870-1000 MHz Per DOCSIS 3.0 DRFI specification CM-SP-DRFI-103-060106 |

Signal Specifications

| Item | Specification |
|------------------------|--|
| Channel encoding | Randomization, Reed-Solomon, Trellis and Interleaving according to ITU-T Annex A, B or C |
| MER (before equalizer) | ≥ 40 dB (at RF) |
| MER (after equalizer) | ≥ 45 dB (at RF) |
| BER (256 QAM) | ≤ 5x10 ⁻⁹ (ITU-A/C pre FEC) ≤ 1x10 ⁻¹³ (ITU-B pre FEC/post trellis) |
| Bandwidth | 6, 7 or 8 MHz (transmission standard depending) |
| QAM constellation | 64 & 256 QAM |

Specifications Optical Types SFP Modules

The following table describes the optical type SFP transceivers available.

| Part Number | Type | Distance | Wave Length | Mode |
|--------------------|-------------|-----------------|--------------------|-------------|
| 4002019 | WDM | Up to 500m | 850 nm | Multi mode |

Electrical GbE SFP Transceiver

The following table describes the electrical GbE SFP transceiver available.

| Part Number | Description |
|--------------------|--------------------|
| 4006222 | GbE SFP copper |

Glossary

ac, AC

alternating current. An electric current that reverses its direction at regularly recurring intervals.

ARP

address resolution protocol. Internet protocol used to map an IP addresses to physical (hardware) addresses on local area networks.

ASI

asynchronous serial interface. Allows the intermittent transfer of data one bit at a time rather than in a steady stream.

AWG

American Wire Gauge. A U.S. standard for wire conductor sizes.

BER

bit error rate. The percentage of bits that have errors relative to the total number of bits received in a transmission.

CAT5

category 5 Ethernet cable.

channel

A television channel is a signal of a specified bandwidth for carrying information. Typically, a 6 MHz bandwidth space is used to transmit the video, audio, and color carriers for the channel.

CSA

Canadian Standards Association.

CWDM

coarse wave-division multiplexing. CWDM allows a modest number of channels, typically eight or less, to be stacked in the 1550 nm region of the fiber called the C-Band. This capacity

Glossary

is greater than WDM (wave-division multiplexing) and lesser than DWDM (dense wave-division multiplexing).

dc, DC

direct current. An electric current flowing in one direction only and substantially constant in value.

DEPI

downstream external PHY interface.

DOCSIS

data over cable service interface specification.

DTI

DOCSIS timing interface.

DWDM

dense wave-division multiplexing. A method of placing multiple wavelengths of light into a single fiber that yields higher bandwidth capacity. Dense WDM indicates close spacing and more than 4 to 8 wavelengths.

EIA

Electronic Industries Association. A United States association that provides standards for use between manufacturers and purchasers of electronic products.

EMC

electromagnetic compatibility. A measure of equipment tolerance to external electromagnetic fields.

ESD

electrostatic discharge. Discharge of stored static electricity that can damage electronic equipment and impair electrical circuitry, resulting in complete or intermittent failures.

Ethernet

A standard protocol (IEEE 802.3) for a 10 Mbps local area network (LAN) that uses carrier sense multiple access with collision detection (CSMA/CD) to handle simultaneous access demands. Ethernet is the most widely-installed LAN technology. An Ethernet LAN typically uses coaxial cable or special grades of twisted-pair wires. The most commonly installed Ethernet systems are called 10-BaseT and provide transmission speeds up to 10 Mbps.

FEC

forward error correction. System of data transmission in which redundant bits generated at the transmitted end are used by the receiver to detect, locate, and correct transmission errors before delivering the data to the local data communications link. This avoids requiring the transmitter to resend information.

FTP

file transfer protocol. Allows users to transfer text and binary files to and from a personal computer, list directories on the foreign host, delete and rename files on the foreign host, and perform wildcard transfers between hosts.

GbE or GigE

gigabit Ethernet. A LAN transmission standard that provides a data rate of 1 billion bits per second. Gigabit Ethernet is defined in the IEEE 802.3z standard. Gigabit Ethernet is carried primarily on optical fiber.

GUI

graphical user interface. A program interface that takes advantage of a computer graphics capabilities to make the program visually easier to use.

HFC

hybrid fiber/coaxial. A network that uses a combination of fiber optics and coaxial cable to transport signals from one place to another. A broadband network using standard cable television transmission components, such as optical transmitters and receivers, coaxial cable, amplifiers, and power supplies. The broadband output stream is transmitted as an optical signal, over the high-speed, fiber optic transmission lines to local service areas where it is split, converted to electrical RF signals, and distributed to set-tops over coaxial cable.

IEC

International Electro-technical Commission.

IP

Internet protocol. A standard that was originally developed by the United States Department of Defense to support the internetworking of dissimilar computers across a network. IP is perhaps the most important of the protocols on which the Internet is based. It is the standard that describes software that keeps track of the internetwork addresses for different nodes, routes, and outgoing/incoming messages on a network. Some examples of IP applications include email, chat, and Web browsers.

IP address

Internet protocol address. A 32-bit sequence of numbers used for routing IP data. Each IP address identifies a specific component on a specific network. The address contains a network

Glossary

address identifier and a host identifier.

ISO

International Organization for Standardization. An international body that defines global standards for electronic and other industries.

ITU

International Telecommunications Union.

LCD

liquid crystal display. A display medium made of liquid crystal. Liquid crystal's reflectance changes when an electric field is applied. Commonly used in monitors, televisions, cell phones, digital watches, etc.

LED

light-emitting diode. An electronic device that lights up when electricity passes through it.

M-CMTS

modular cable Modem termination system.

MAC

media access control. The layer in the OSI model above the physical layer. It defines media access control methods and parameters for access to the physical media.

MAC address

media access control address. A unique 48-bit number that identifies the input/output card of a particular device. The MAC address is programmed into the card by the manufacturer. The MAC sub-layer handles access to shared media.

MIB

management information base. SNMP collects management information from devices on the network and records the information in a management information base. The MIB information includes device features, data throughput statistics, traffic overloads, and errors.

MPEG

Motion Picture Experts Group. A joint committee of the International Standards Organization (ISO) and the International Electrotechnical Commission (IEC). This committee develops and maintains the MPEG specification for a series of hardware and software standards designed to reduce the storage requirements of digital video and audio. The common goal of MPEG compression is to convert the equivalent of about 7.7 MB down to under 150 K, which represents a compression ratio of approximately 52 to 1. Current standards are MPEG-1,

MPEG-2, and MPEG-4.

MPTS

multi-program transport stream.

PC

personal computer.

PCB

printed circuit board.

PIC

process identifier.

PID

packet identifier or program identifier.

PMT

program map table. Identifies and indicates the locations of the streams that make up each service, and the location of the Program Clock Reference fields for a service.

QAM

quadrature amplitude modulation. A phase modulation technique for representing digital information and transmitting that data with minimal bandwidth. Both phase and amplitude of carrier waves are altered to represent the binary code. By manipulating two factors, more discrete digital states are possible and therefore larger binary schemes can be represented.

RF

radio frequency. The frequency in the portion of the electromagnetic spectrum that is above the audio frequencies and below the infrared frequencies, used in radio transmission systems.

RMA

return material authorization. A form used to return products.

RMS

root mean square. A kind of statistical average of a set of numbers. To find the root mean square of a set of numbers, square all of the numbers in the set, take the average of those squares, and then calculate the square root of that average.

Glossary

RPC

remote-procedure call.

RPT

resilient packet transport. A pre-standard superset of resilient packet ring (RPR).

RU

rack unit. RU is the measuring unit of vertical space in a standard equipment rack. One RU equals 1.75" (44.5 mm).

SDI

serial digital interface.

SFP

small form-factor pluggable.

SNMP

simple network management protocol. A protocol that governs network management and the monitoring of network devices and their functions.

SNTP

simple network time protocol. A system for synchronizing the clocks of networked computer systems.

SPTS

single program transport stream.

U-EQAM

universal edge QAM. Convergence of high-speed and bandwidth data and video distribution at the edge of the cable access network.

UDP

user datagram protocol. A connectionless protocol, like TCP, that runs on top of IP networks. Unlike TCP/IP, UDP/IP provides very few error recovery services, offering instead a direct way to send and receive datagrams over an IP network without acknowledgements for guaranteed delivery.

V

volt.

Index

A

AC PSU Features and Benefits • 7
ac, AC • 47
Access Requirements • 16
Additional Information • 6
ARP • 47
ASI • 47
AWG • 47

B

BER • 47

C

Cabling the Earth-Bonding Terminal • 26
CAT5 • 47
channel • 47
Chassis Dimensions • 15
Checking LED Indicators • 34
Connecting AC Power • 24
Connecting Cables • 24
Connecting DC Power • 24
Connecting the Input and Output Cables • 27
Connectors • 5
CSA • 47
customer support information • 39
Customer Support Information • 39
CWDM • 47

D

DC PSU Features and Benefits • 8
dc, DC • 48
DEPI • 48
DOCSIS • 48
DTI • 48
DWDM • 48

E

EIA • 48
Electrical Specifications • 44
Embedded Graphical User Interface • 10
EMC • 48

Equipment Rack • 16
ESD • 48
Ethernet • 48

F

FEC • 49
FTP • 49

G

GbE or GigE • 49
General • 9
General Specifications • 42
GUI • 49

H

HFC • 49
Housing • 5

I

IEC • 49
important safety instructions • vii
Installation • 13
Installing and Removing RF Gateway 1
 Components • 19
Installing/Removing SFP Modules • 21
Installing/Removing the PSU • 19
Installing/Removing the QAM Card • 20
Introduction • 1, 7, 10
IP • 49
IP address • 49
ISO • 50
ITU • 50

L

LCD • 50
LED • 50
LED Indicators • 5

M

MAC • 50
MAC address • 50
Maintaining the Equipment • 32

Maintenance • 32
Maintenance and Troubleshooting • 31
M-CMTS • 50
MIB • 50
Modular Concept • 4
Mounting Requirements • 17
Mounting the RF Gateway 1 • 17
MPEG • 50
MPTS • 51

O

Operating Environment • 16
Optical Connector Cleaning Guidelines • 36
Optical Connector Cleaning Overview • 36

P

PC • 51
PCB • 51
PIC • 51
PID • 51
PMT • 51
Power Supply • 7
Preparing for Installation • 14
Primary Benefits • 3
Primary Features • 3
Product Identification • 11

Q

QAM • 51
QAM Card • 9

R

Rack Mounting • 17
Recommended Equipment • 36
Replacing a Fan • 32
RF • 51
RMA • 51
RMS • 51
RPC • 52
RPT • 52
RU • 52

S

Scrambling Introduction • 3, 9
SDI • 52
SFP • 52
Site Requirements • 16
SNMP • 52
SNTP • 52
SPTS • 52

T

Tips for Optimal Connector Performance • 36
To Clean Optical Connectors • 37
Tools and Accessories • 14, 17
Troubleshooting • 34

U

UDP • 52
U-EQAM • 52
Unpacking and Inspecting the Module • 14

V

V • 53



Cisco Systems, Inc.
5030 Sugarloaf Parkway, Box 465447
Lawrenceville, GA 30042

678 277-1120
800 722-2009
www.cisco.com

This document includes various trademarks of Cisco Systems, Inc. Please see the Notices section of this document for a list of the Cisco Systems, Inc. trademarks used in this document.

Product and service availability are subject to change without notice.

© 2008, 2012 Cisco and/or its affiliates. All rights reserved.

August 2012 Printed in USA

Part Number 4024958 Rev B