



RoomOS 11.9

Cisco Board and Desk Series

User guide

What's in this guide

Introduction

Cisco Board Pro	4
Cisco Board	5
Cisco Desk Pro	6
Cisco Desk	7
Cisco Desk Mini	8
RoomOS 11: Basic navigation.....	9
Pairing with Bluetooth®	10
Headsets (<i>Desk Series, Board Pro</i>).....	11
Use as a USB camera (<i>Desk Pro, Desk</i>)	12
Sign in with your own credentials.....	13

Video calls

RoomOS 11: Call controls.....	15
Audio settings	16
Place a call from your contact list	17
Edit a contact before calling.....	18
Place a call using a name, number, or address.....	19
Incoming calls	20
Receive a call while in another call.....	21
Disconnect yourself from a call	22
Put a call on hold and resume a call on hold.....	23
Transfer an ongoing call.....	24
Change the call rate.....	25
Activate do not disturb	26
Automated forwarding of all calls	27
Open the keypad in call.....	28
Add participants to an ongoing call.....	29
Disconnect a participant from a conference	30
Admit a participant to a meeting	31
Pin a speaker in a meeting.....	32
Raise hand in a meeting.....	33
Find call details for recent calls	34

Cisco Proximity

Cisco Proximity ultrasound signal.....	36
--	----

Content sharing

Share content with a cable	38
Share content with the Webex app.....	39
Share content with Miracast®	40
Share content with Airplay®	41
Change the screen layout in a call	42
Whiteboarding.....	43
End your session to clear your device.....	44
Annotate shared content.....	45
Send annotations or drawings by email	46
Wired touch redirect	47
Web apps.....	48

Scheduled meetings

Join a scheduled meeting	50
Join a Webex meeting	51
Join a third-party meeting.....	52

Contacts

Favorites, Recents, and Directory.....	55
Add someone to Favorites during a call	56
Add someone to Favorites outside a call	57
Edit a Favorite	58

Camera control

Turn the camera on and off.....	60
Access and adjust the selfview in and out of call.....	61
Move the selfview	62
Virtual backgrounds (<i>Desk Series</i>).....	63
Control your camera manually.....	64
Select an automatic camera mode (<i>Board Series</i>)....	65
Control a far-end camera	66

Settings

Control panel and Device settings	68
---	----

All entries in the table of contents are active hyperlinks that take you to the corresponding section. To move between chapters click on the icons in the sidebar.

This guide describes the use of Cisco Board Series (Board Pro, Board), and Cisco Desk Series (Desk Pro, Desk, and Desk Mini), when registered to an on-premises service. In cases where certain functionality applies to one series or device but not all, the applicable series or device is mentioned.

A Cisco Board can be used as a stand-alone device or controlled with a Touch 10 or Room Navigator. This guide covers use of Boards as stand-alone devices.

If you're using a touch controller with your Board, read about touch controller features and functionality in the *Cisco Room Series User Guide*.

Note: Some of the features described in this user guide may be optional in certain markets and might not apply to your device.



Introduction

Introduction

Cisco Board Pro

All-in-one device with 4K camera, built-in microphones and speakers, and a high-resolution 4K touchscreen. There are three mounting options available: floor stand, wheel base, or wall mounted.

Board Pro is available in two different screen sizes: 55" and 75".

See the *Administration Guide* for detailed information about the Board Pro connector panel.



- ① Camera
- ② Loudspeaker (across bottom)
- ③ Magnetic pen holder (both sides)
- ④ Connector panel (at rear)

Introduction

Cisco Board

All-in-one device with 4K camera, built-in microphones and speakers, and a high-resolution 4K touchscreen. There are three mounting options available: floor stand, wall stand, or wall mounted. The second generation of Board is referred to as the *S Series*, representing some minor optimizations to the hardware platform.

Board is available in three different screen sizes:

- Board 55 and 55S with a 55" LED screen
- Board 70 and 70S with a 70" LED screen
- Board 85S with a 85" LED screen

See the *Administration Guide* for detailed information about the Board connector panel, as there are some slight variations between series and size.



Introduction

Cisco Desk Pro

Use as PC monitor. Use an HDMI or USB-C cable to connect your computer (see below). If you use a USB-C cable, you can charge your laptop through the same cable.

To view the PC screen on Desk Pro, tap **PC Input**.

Incoming calls appear as usual, irrespective of mode (PC or video) unless Do not disturb is active, see [“Activate do not disturb” on page 26](#).

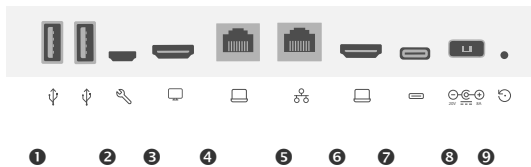
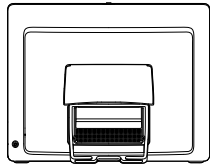

- ❶ USB ports
- ❷ Service port
- ❸ HDMI out: screen
- ❹ Network expansion. Connect your computer network here to let it share a common connection with your Desk Pro
- ❺ Network
- ❻ HDMI in: content sharing
- ❼ USB-C connector
- ❽ Power
- ❾ Factory reset pinhole



- ❶ Camera with privacy shutter
- ❷ Loudspeaker volume controls and microphone mute button
- ❸ USB and mini-jack socket on the right side of the unit
- ❹ Stylus
- ❺ Loudspeaker
- ❻ Microphones (6 locations)
- ❼ Power On/Off on the back of the device

Introduction

Cisco Desk

Use as PC monitor. Use an HDMI or USB-C cable to connect your computer (see below).

To view the PC screen on Webex Desk, tap **PC Input**.

Incoming calls appear as usual, irrespective of mode (PC or video) unless Do not disturb is active, see [“Activate do not disturb” on page 26](#).

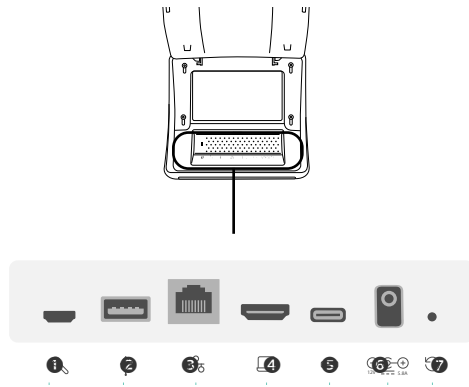

- ❶ Service port
- ❷ USB port: for headset
- ❸ Network
- ❹ HDMI in: content sharing
- ❺ USB-C connector
- ❻ Power
- ❼ Factory reset pinhole



- ❶ Camera with privacy shutter
- ❷ Loudspeaker volume controls and microphone mute button
- ❸ Loudspeaker
- ❹ Microphones (4 locations)
- ❺ Power On/Off on the back of the device

Introduction

Cisco Desk Mini

Use as PC monitor. Connect your computer with a USB-C cable. Extend your screen and use Desk Mini's speakers, microphone, camera, and touch control with the apps running on your laptop.

Incoming calls appear as usual, irrespective of mode (PC or video) unless Do not disturb is active, see ["Activate do not disturb" on page 26](#).

There's a magnetic panel covering the connectors on the back of the device - you can pull it off and put it back on. Here are the connectors on your Desk Mini:

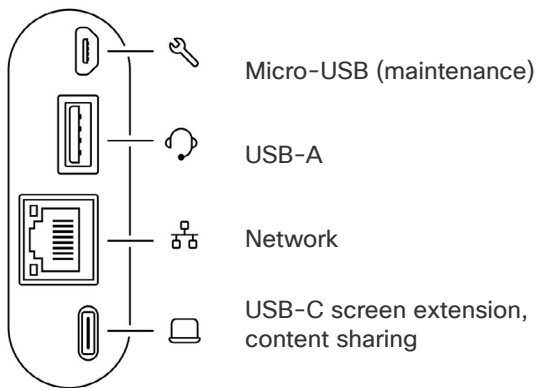

- ❶ Camera with privacy shutter
- ❷ Loudspeaker volume controls and microphone mute button
- ❸ Power On/Off on the back of the screen
- ❹ Loudspeaker
- ❺ Microphone

RoomOS 11: Basic navigation

Tap the device name to see its contact information.

To access the home screen and any open apps, swipe up with the bottom handle. This opens the task switcher.

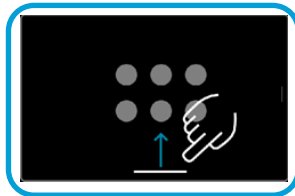

Tap the button or swipe from the right side to open the control panel.

Dots under the buttons means there are more buttons off-screen. Swipe to see them.

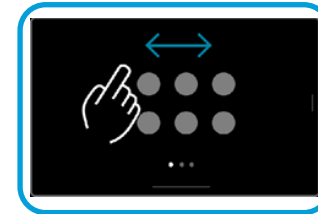

The task switcher shows any open apps, whether you're in a call or not. If your laptop's connected, its screen appears in the task switcher.

Whiteboards you create in a session are open as separate apps in the task switcher.

Tap the **Files** button to see all the whiteboards you've created on the device, and any other files that are available to you on your device.



Some apps open as dialogs. Touch and hold the top edge of a dialog to move it around. Tap outside a dialog to close it.

To close a full screen app swipe up from the bottom of the screen. Then swipe up on the preview image of the app you want to close.

Introducing RoomOS 11

Cisco Board and Desk Series support the new RoomOS 11 operating system.

While most familiar features work on RoomOS 11 in the same way as before, some have changed, or you access them in different places. There is also new functionality available.

This guide introduces some of the new features and changes to existing ones that you'll find on the RoomOS 11 user interface on Board and Desk Series devices.

Find out more about the RoomOS 11 User Experience, at <https://help.webex.com/n01kjh1/>.

Introduction

Pairing with Bluetooth®

You can use Bluetooth connection to pair external devices such as your phone or laptop, with your Cisco device. You can also pair headsets – see the next page.

You can switch between the speaker on the Cisco device and the devices connected through Bluetooth. Select the icon in the status bar of the user interface, and choose from the available devices.

NOTE: You can't have both a headset and another Bluetooth device connected simultaneously.

Pairing devices

NOTE: You can't use Bluetooth to stream music while in a call.

To pair an external device:

1. Open the control panel, tap **Device settings** and scroll to **Bluetooth**. If Bluetooth is disabled, toggle it on. It's enabled by default.
2. Toggle on **Discoverable**. You only need to set the Cisco device as discoverable when you connect a new device. The Cisco device goes automatically out of discoverable mode after five minutes.
3. Go to the Bluetooth settings on your external device and scan for available devices.
4. Select your Cisco device from the devices list and pairing begins. It may take a few seconds for the pairing to complete.
5. If the pairing is successful, your device is listed as connected. The pairing is completed.

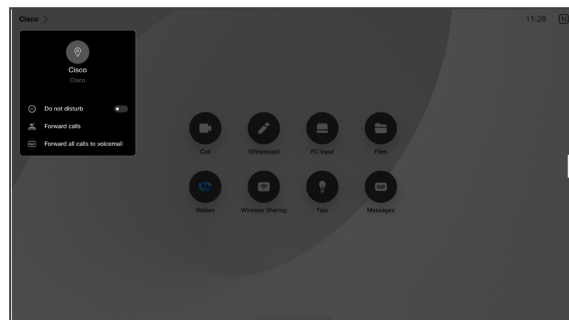

Icon appears here. Tap it to change between Cisco device speakers and another device.

- Speakers
- Analog headset
- USB headset
- USB handset
- Bluetooth device

The Bluetooth® word mark and logos are registered trademarks owned by Bluetooth SIG, Inc. and any use of such marks by Cisco is under license. Other trademarks and trade names are those of their respective owners.

Headsets *(Desk Series, Board Pro)*

Bluetooth headsets®

You can use a Bluetooth headset with your Cisco Desk Series device or Board Pro. Either pair it directly with the device or use a USB Bluetooth dongle. You can pair multiple headsets to your device, but only use one at a time

The following Bluetooth profiles supported:

- HFP (Hands-Free Profile)
- A2DP (Advanced Audio Distribution Profile)
- The headset must support both HFP and A2DP, or HFP-only. A2DP-only is not supported.

The range is up to 10 m (30 ft). If you move outside the range when in a call, the audio switches to the speakers on the device.

Most headsets have built-in volume controls. In a call, the volume of the headset and device is synchronized. When not in a call, the volume buttons on the headset and device operate independently.

Supported Bluetooth features:

- Answer incoming calls
- Reject incoming calls
- Hang up calls
- Hold and resume calls
- Volume up and down

Some headsets have mute control. When using a Cisco headset the mute controls on the headset and on the device are synchronized. For other headsets mute control operates independently of the mute control on the device.

Pair with a Bluetooth headset

1. Activate Bluetooth pairing on the headset. If in doubt, consult the instruction manual for the headset.
2. Open the control panel, tap Device settings and scroll to Bluetooth. If Bluetooth is disabled, toggle it on. It's enabled by default.
3. The Cisco device scans for other devices. Upon successful discovery the Bluetooth headset should be displayed in the device list.
4. Select the device and pairing begins. It may take a few seconds for the pairing to complete.
5. If the pairing is successful, the Cisco device lists the headset as connected. The pairing is completed.

USB Bluetooth dongle

When using the dongle the headset is detected as a USB headset.

Note that synchronization of headset volume and device volume doesn't work when using a dongle.

See also <https://help.webex.com/nkiifbo/>.

USB headsets

(Desk Series)

Cisco Desk Series implements the standard protocol for USB wired audio devices.

Manufacturers can implement the standard differently (called HID protocol).

Consequently, different models from the same manufacturer can behave differently and we can't guarantee that all headsets and handsets work.

We have only tested wired headsets or headsets with a dongle.

Read more about USB headsets and see the full list of supported headsets in <https://help.webex.com/nkiifbo/>.

Introduction

Use as a USB camera *(Desk Pro, Desk)*

The Cisco Desk or Desk Pro may also be used as a USB camera.

If you did not register your Desk or Desk Pro with Cisco, you can use it as any other USB camera.

If you have registered the Desk or Desk Pro with Cisco, you can still use it as a USB camera, but observe the following:

- The Desk or Desk Pro will enter do not disturb (DND) mode when the software client starts using the camera, and not when the cable is plugged.
- This will allow scenarios where a dedicated computer is connected to the device at all times, but the desk device can be still be used for regular Cisco calls.

To use the Desk or Desk Pro as a USB camera, connect it via a USB cable between your computer and the USB-C socket on the Desk or Desk Pro.

This configuration will make use of the microphones and the loudspeakers of the Desk or Desk Pro, ensuring a great sound experience.

If you want to extend the configuration to include an external monitor with this setup, connect your computer to the monitor in the usual way.

Other Device Settings are also fully accessible, with the exception of the Do Not Disturb, which cannot be disabled on a Cisco registered Desk or Desk Pro.

Used as USB camera when already registered

When placing calls using a third party client, the camera, microphone and loudspeakers are selected based on the OS/app. defaults. You may override these settings.

To maintain privacy, the camera light indicator will be illuminated whenever the camera is active.

All other functionality is controlled by the third party client.

Used as USB camera when not registered

The first time you start up a Cisco video device, the Setup Wizard will appear.

This wizard lets you specify how to register with Cisco Services (Cloud or on-premises). The Desk or Desk Pro provides the option of skipping the wizard if you are going to use it as a USB device only.

Detailed instructions are provided on-screen to show you how to do this.

If you later want to register the Desk or Desk Pro with Cisco, open the control panel and tap **Device settings**. Scroll to and select **Device activation**.

Introduction

Sign in with your own credentials

1



Tap the **Extension Mobility** button.

If you can't see the button, swipe the home screen buttons to left.

2

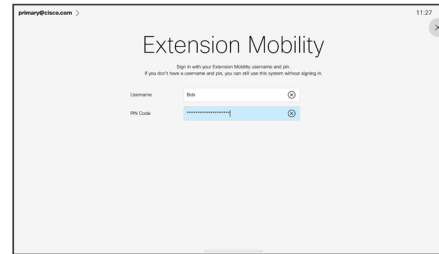

Type in your username and PIN code, and then tap **Login**. You'll see a confirmation that your sign in was successful.

3

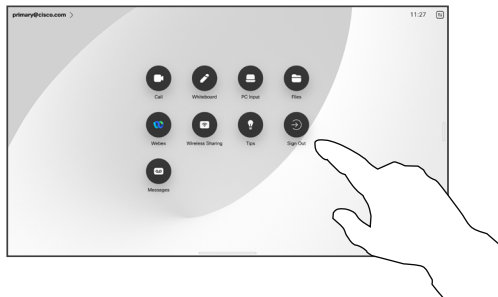

To log out again, tap **Sign out**. If you can't see the button, swipe the home screen buttons to left.

About Extension mobility

Devices located in meeting rooms and quiet rooms and running under CUCM (Cisco Unified Communications Manager) may allow you to log in to the device with your own personal credentials.

CUCM then routes all of your incoming calls to that specific device.

Once you log out from Extension Mobility, your list of Recents is cleared from the device.



Video calls

Video calls

RoomOS 11: Call controls

Tap the screen to bring up the call controls during a call.

In addition to standard buttons like **Mute/Unmute**, **Volume**, **Start/Stop video**, and **Leave meeting**, all the other controls you need during your call are in the same place at the bottom of your screen.

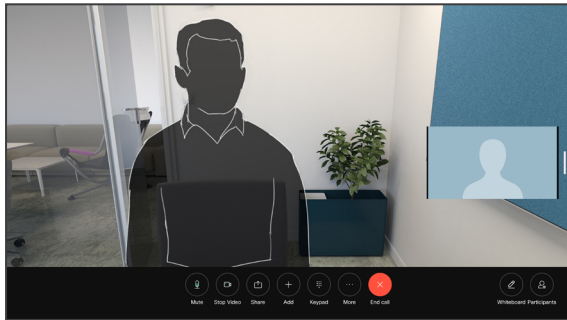

- **Layout** menu. Choose a layout that fits your meeting style.
- **Selfview**. Opens the manual camera controls and options to change and move your selfview.
- **Share**. Opens the sharing options.
- **Participants** list. Opens the list of people in the current call. Tapping a participant shows the options that are available to you – like mark as Favorite. Hosts/cohosts have additional options such as Remove from call, Admit, and muting options.
- **More**. Tap More to get additional options like **Lock meeting**, **Microphone** settings (also available in the Control panel), **Add** participants, open the **Keypad**.

View laptop screen in call

To use your Cisco device as an extension for your laptop screen, connect your laptop with the HDMI or USB-C cable. You'll see the laptop screen in the task switcher.

To see your laptop screen during a call, select it in the task switcher. You'll see the call and presentation in a filmstrip. To make the laptop preview smaller and the call larger, drag down from the handle on top of the laptop preview. Tap and drag the filmstrip to change it to a small floating window which you can drag and drop on designated areas on the screen.

Video calls

Audio settings

The following audio settings are available to you in or out of call, from the microphone options. To turn one of these settings on, open the control panel your device and then tap **Microphone**. Tap the option you want on. Tap **Neutral** if you don't want any of them.

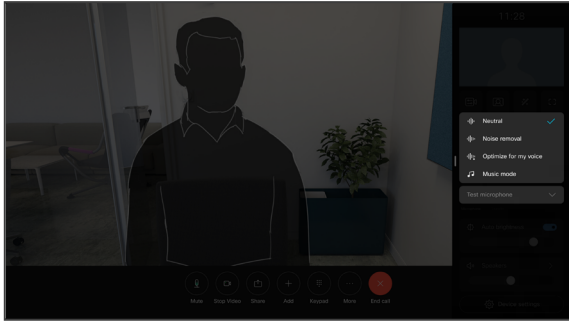

Noise Removal

You can use noise removal to filter out distracting noises from your environment in a call. Noise removal is especially useful in a shared spaces or a home office.

Optimize for my voice

Remove background noises during a call, only picking up your own voice and suppressing the voices of other people talking nearby.

Test microphone

Record and playback your voice, to check that the Cisco device is picking it up properly, and test the effectiveness of the noise removal setting.

Music mode

Using Music mode allows the dynamic range of music go through in a call. This creates a better experience in settings where it's important to hear the nuances in music.

Music mode is useful for remote music lessons, testing musical instruments, and other situations where it's important to hear the full range of music. The device still uses its echo cancellation and environmental background noise reduction capabilities to avoid the need for external equipment, without detracting from the performance.

When Music mode isn't in use, the device filters out additional noises and reduces sound level variations. This caters for meeting settings and helps reduce distracting noise. The additional filtering also works well when you play recorded music through the device.

To use Music mode, enable it on your device first: open the control panel and tap Device settings. Scroll to and select **Music mode**. Toggle it on or off.

NOTE: you can't use Music mode and Noise removal at the same time.

Ringtone and volume

To change the ringtone and to adjust the ringtone volume, open the control panel and then tap **Device settings**. Scroll to **Ringtone and volume**. Select a ringtone from the list and use the slider to set the sound level.

Video calls

Place a call from your contact list

1



Tap the Call button.

2

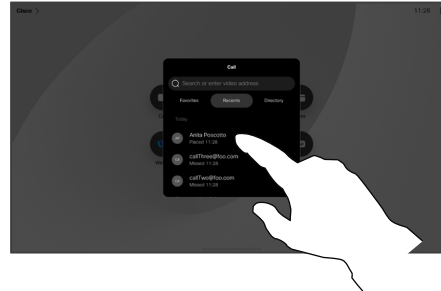

Tap Favorites, Recents, or Directory and then scroll down to locate a contact.

3

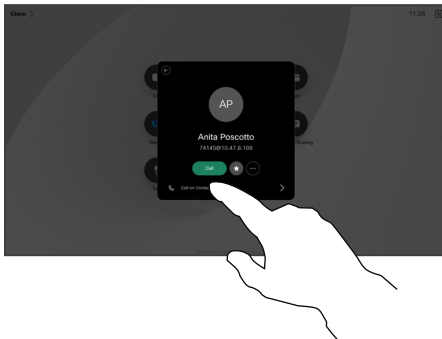

Tap that contact and then tap the green **Call** button.

4

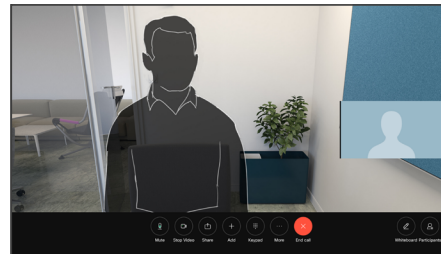

The call is placed. To end the call, tap the red **End Call** button.

About the Contact lists

Your contacts list consists of three parts:

Favorites. These contacts are put there by you. They are entries you call frequently or otherwise need to access quickly and conveniently from time to time.

Directory is typically a corporate directory installed on your device by your video support team.

Recents is a list of calls you have placed, received, or missed earlier.

The following options apply:

- Type in a name, number, or an IP address and the device looks in all lists for you.
- Add the entry to your *Favorites*; edit it before calling, and change the call rate.

You can only remove *Recents* from the web interface.

Video calls

Edit a contact before calling

1

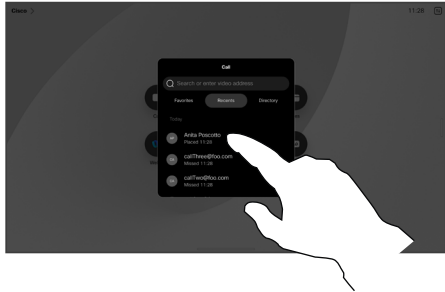

Tap the Call button. Then locate the contact you want to edit and tap it.

2

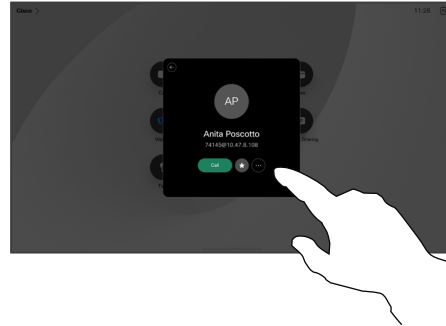

Tap the **More (...)** button on the contact card.

3

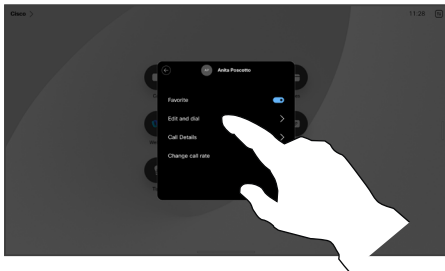

Tap **Edit and Dial**.

4



Edit with the keyboard and then tap the green **Call** button to place the call.

About entry edits

You may have to edit an entry in one of the contact lists before you place the call. You might need to add a prefix, a suffix, or otherwise alter the entry.

Video calls

Place a call using a name, number, or address

1



Tap the **Call** button.

2

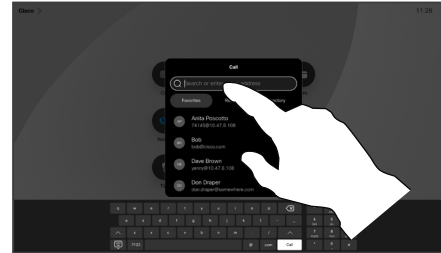

Tap the Search field. This opens the keyboard.

3

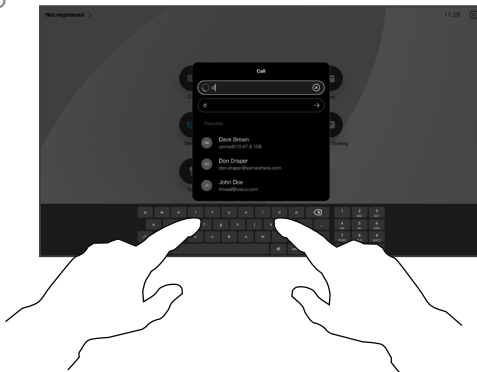

Type in a name, number, or address. Matches and suggestions appear as you type. If the correct match appears, tap it, otherwise keep typing.

4

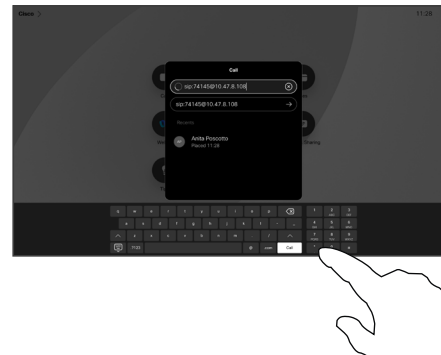

Once you've located and selected your contact, tap the green **Call** button to place the call.

About placing calls

To call someone who isn't listed in your contacts you type their name, address or number on a virtual keyboard that opens on your screen.

Anyone you previously called, or who has called you, appears in the *Recents* list and you can add any of them to your *Favorites*. This is described in the section *Contacts*.

Sometimes you need to enter numbers during a call, typically to reach extensions or to provide a pin code. Tap the **Keypad** button in the call controls to open the keyboard.

Note that you clear *Recents* from the web interface only.

Video calls

Incoming calls

1

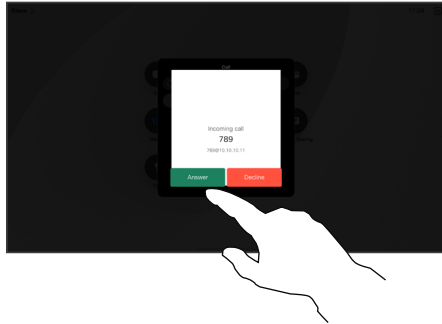

Tap to Answer or Decline an incoming call.

2

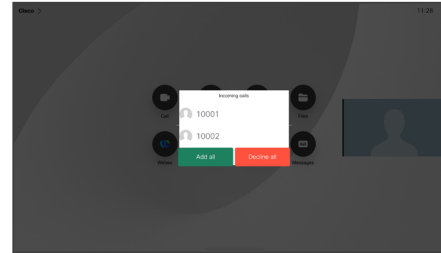

If your video infrastructure permits it, you may receive multiple incoming calls. You then have the choice to add them to an existing call, or decline them.

If someone calls you

If someone calls you, you may accept, decline, or ignore the call.

- If you decline the call, busy information is sent to the caller.
- If you ignore the call, the caller perceives this as if you were absent (you didn't pick up the call).
- Your video infrastructure may allow you to receive multiple incoming calls. Consult your video support team, if needed.

Video calls

Receive a call while in another call

Add: If your device is running Ad-hoc conferencing under CUCM you can add incoming participants.

The identity of the new incoming call.

Decline the incoming call and carry on as you have been doing.

About the options

If you already are in a call, you can accept another incoming call under certain circumstances.

Accept & Hold: Answer the call and put the existing call on hold.

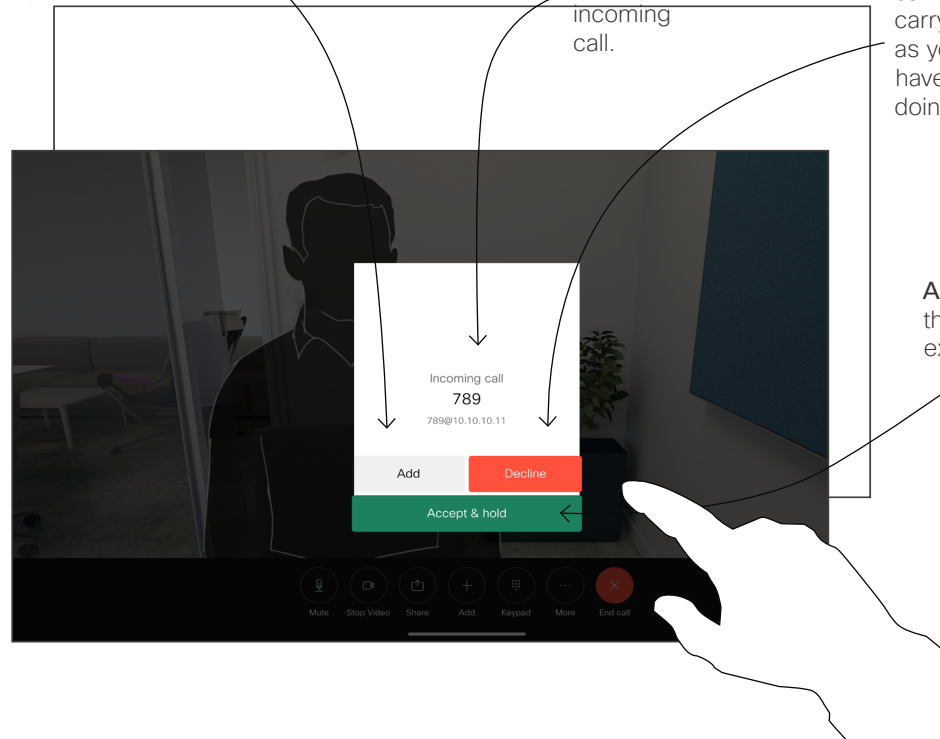

Video calls

Disconnect yourself from a call

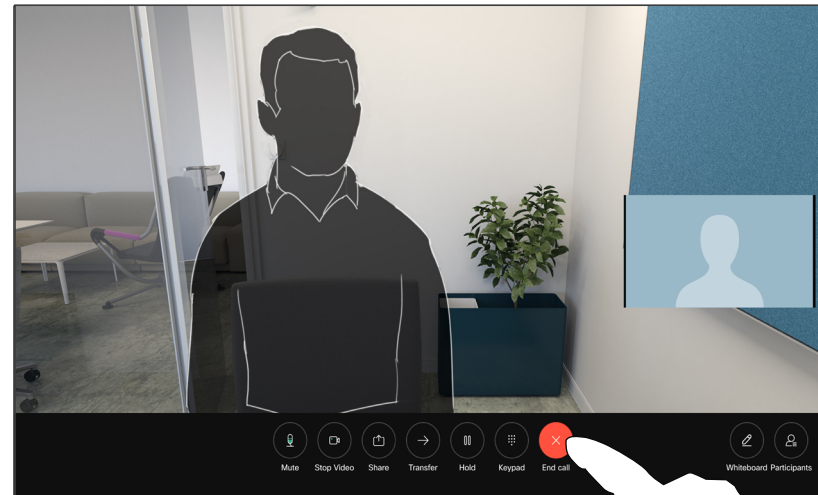

To disconnect yourself from a call, tap **End Call**.

About disconnecting a call

Tapping **End** in a call disconnects you from the call. In a call with two parties only, this terminates the call.

In a conference call with multiple participants tapping **End call** only terminates your participation if you are a regular participant.

However, if you are the host of such a conference, tapping **End call**, for some types of conferences, cause the entire conference to terminate.

Video calls

Put a call on hold and resume a call on hold

1

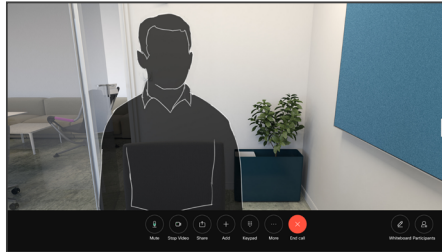

In a call, tap **Hold**. You might need to tap **More** first.

2

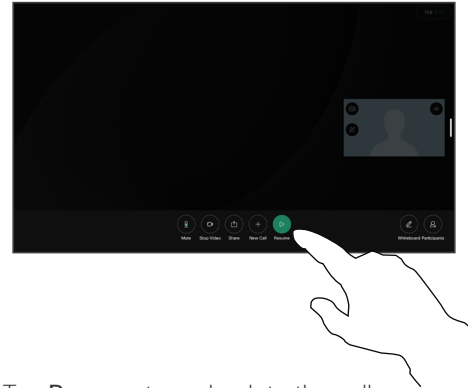

Tap **Resume** to go back to the call on hold.

About putting on hold

Putting someone on hold is typically the first step when transferring the call to another person. It's also an alternative to muting when you want to also stop the video transmission.

Video calls

Transfer an ongoing call

1

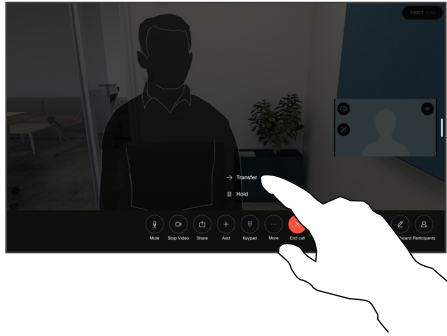

Tap More and then tap **Transfer**. This puts the current call on hold.

2

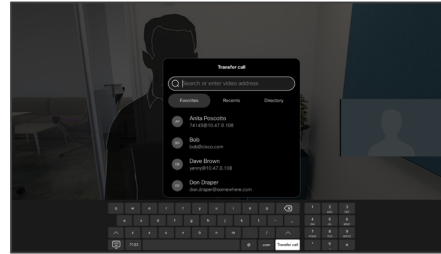

Search for a contact.

3

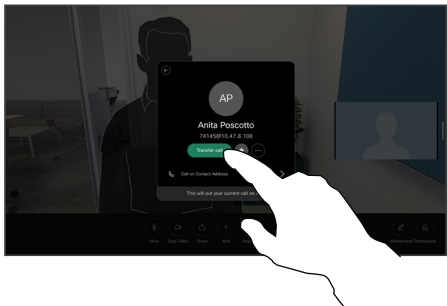

Tap the green **Transfer call** button. Talk to the person to confirm that transfer is OK. The person to be transferred is still on hold.

4

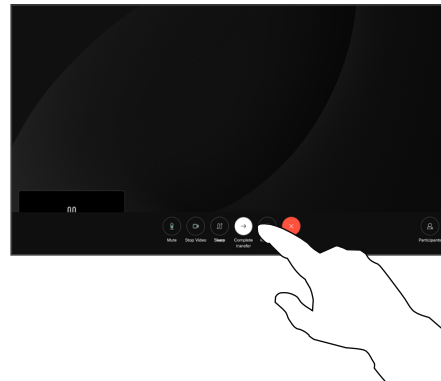

Tap **Complete Transfer**.

About transfers

You can transfer an ongoing call to another person. Transfer is always optional and you can talk to the person you are going to transfer a call to, before you actually transfer the call.

Video calls

Change the call rate

1

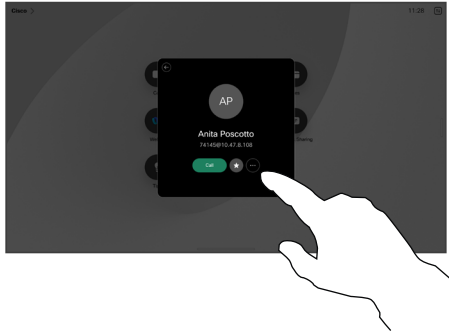

Tap the **Call** button and locate the entry whose call rate you want to alter. Tap it and then tap **More**.

2

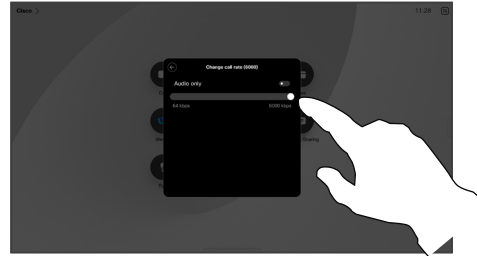

Tap **Change call rate**. Move the slider.

3

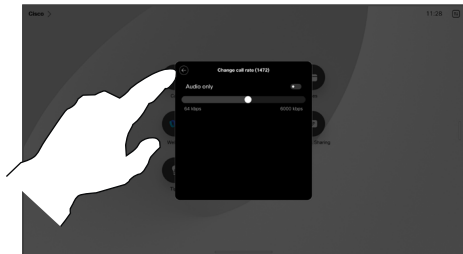

Tap the back button and then tap **Call**.

About call rates

Call rate is the term used to express the amount of bandwidth allocated to the call. It is measured in kbps (kilobits per second).

The higher the call rate is, the better the quality is, but on the expense of higher bandwidth consumption.

The device comes with a default call rate. This is normally set by your video support team. Under normal conditions the call rate is adjusted automatically by the device, whenever needed. This is done to avoid choking the video call when you try to call someone at a higher rate than their device and connection support.

If, for some reason, the automatic call rate setting fails, you may also do this manually as a last resort.

Call rate can't be changed during a call, but you may change it just before you place a call, as shown at left..

Video calls

Activate do not disturb

1



Tap the device name in the upper left corner of the homescreen.

2



Toggle on **Do not disturb**. Tap again to deactivate the setting.

About do not disturb

Your device can be set to not respond to incoming calls. You can still call others.

Your video support team may have set a time-out on this feature, after which the device responds to incoming calls as usual. Default time-out setting is 60 minutes.

Note that access to this feature may have been removed by your video support team.

Video calls

Automated forwarding of all calls

1



Tap the device name in the upper left corner of the homescreen.

2



Select the Forward calls entry there. Look up and select a contact. Then tap the green Forward button.

To stop forwarding calls open the same menu and select Stop forwarding.

About forwarding calls

If enabled on your device, you can forward all calls, choosing either voicemail or another receiver.

Your administrator can disable access to the set of menus and options shown.

Video calls

Open the keypad in call

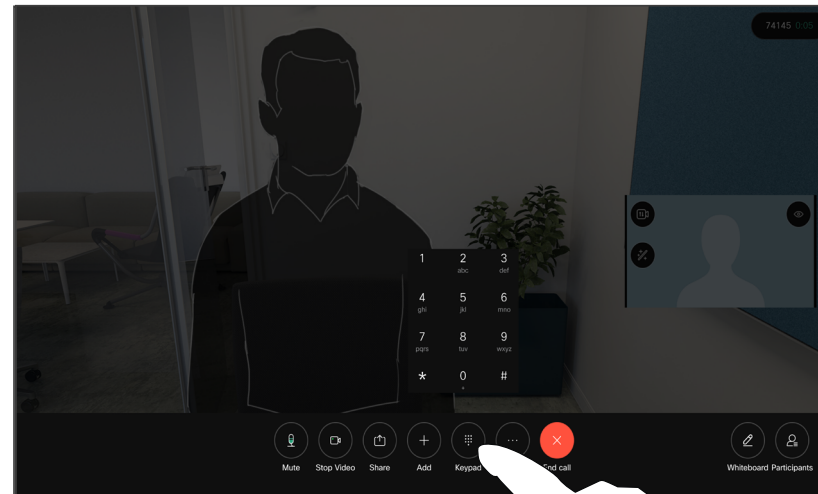

In a call, tap the screen to open the call controls. Then tap the **Keypad** button.

Using the keypad in a call

In a call you might get prompted to submit numbers to be able to reach an extension or otherwise gain entrance to something (for example by means of a PIN-code).

To enter numbers, open the keypad on the touch screen.

Video calls

Add participants to an ongoing call

1

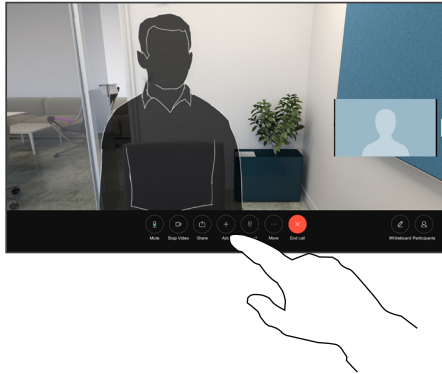

Tap the screen to access the call controls during a call, and tap **Add**.

2



Locate and select the next person you want to call.

3

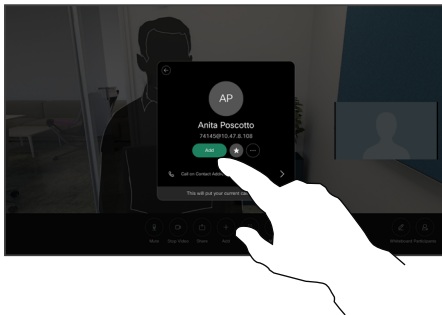

Tap **Add** on the contact card.

4

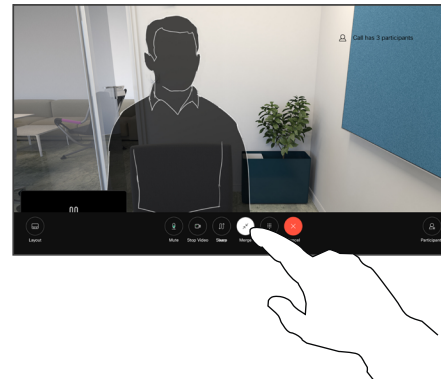

Tap **Merge** in the call controls to add the new call to the existing one. You have now established a conference.

You can repeat this procedure to the extent permitted by your video infrastructure.

About video conferences

Your network may be equipped with the capability to initiate a video conference with several participants.

The maximum number of participants supported by your device depends on device configuration and the video infrastructure. If in doubt, contact your video support team.

To initiate a video conference, you call each participant one by one.

If you are the one who initiated the conference you can terminate the entire conference. The other participants can only disconnect themselves from the conference.

Video calls

Disconnect a participant from a conference

1

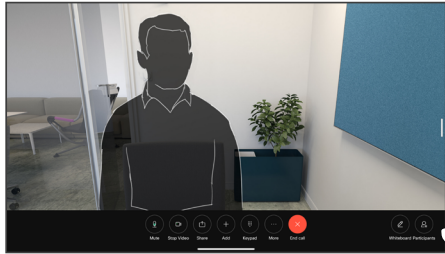

In a call, tap the screen to get the call controls. Then tap the **Participants** button.

2

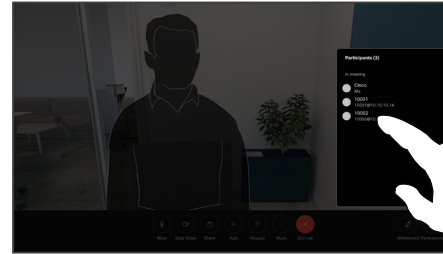

Tap the participant to be dropped from the conference.

3

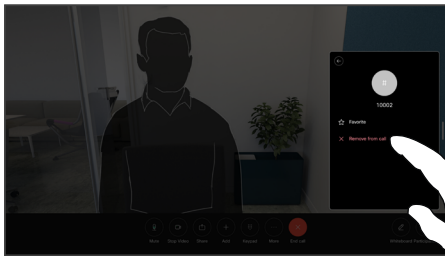

Tap **Remove from call**.

About video conferences

The ability to conduct a video conference from your device is an optional feature that may or may not be available for your device.

Note that you must be the host of the conference to be able to disconnect others from a conference.

Video calls

Admit a participant to a meeting

1

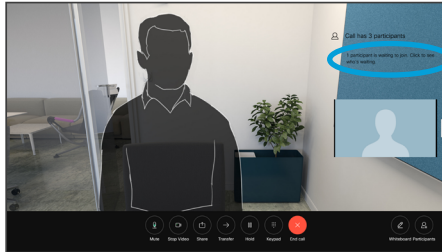

You'll be notified during a call if someone is waiting in the lobby.

2

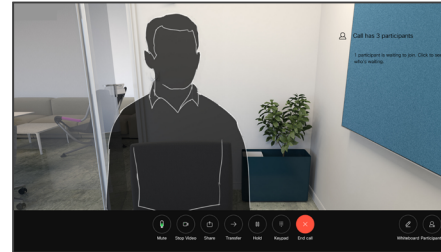

Tap the screen to get the call controls. Then tap the **Participants** button.

About admit participant

In a CMS meeting that is locked, you can let a participant join the meeting from the participant list.

3

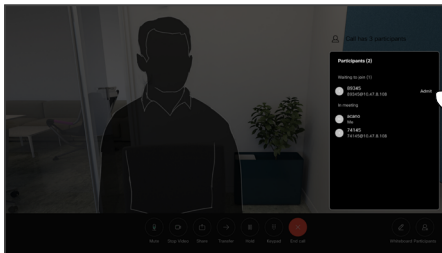

Tap **Admit** to let the waiting participant into the meeting.

Video calls

Pin a speaker in a meeting

1

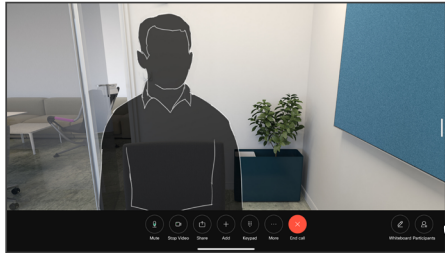

In a call, tap the screen to get the call controls. Then tap the **Participants** button.

2

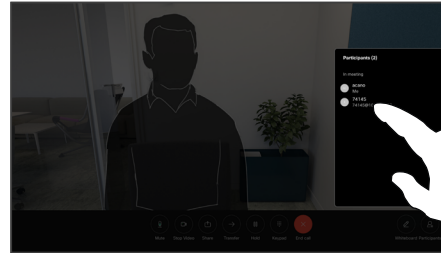

Tap the participant you want to pin.

3

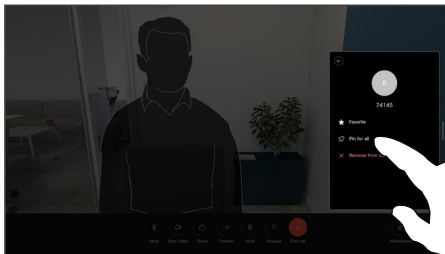

Tap **Pin for all**.

About pinning a speaker

In a CMS meeting you can pin a meeting participant to show up as important for all the meeting participants. This way that participant or meeting room shows up on everyone's screens even when they are not the active speaker.

When you pin a speaker, a notification that they have been pinned shows up on their screen. Similarly, when you unpin them, they see a notification that they have been unpinned.

If you pin an audio-only participant, this will not affect the layout.

By default only the host can pin for all, but the meeting organizer can change this in the meeting settings.

You can pin a speaker for the whole meeting only in CMS meetings.

Video calls

Raise hand in a meeting

1

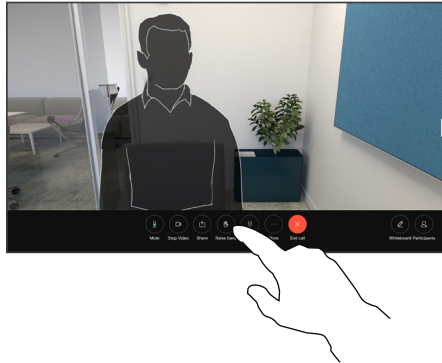

In a meeting, tap the screen to open the call controls. Then tap the **Raise hand** button.

2

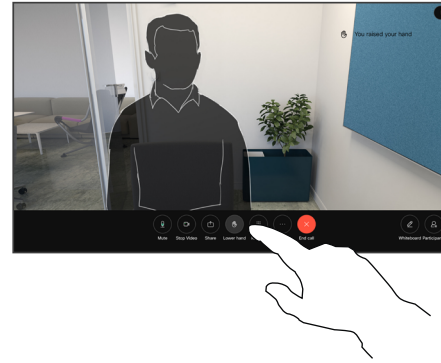

Tap the **Lower hand** button to lower your hand. This also removes the icon from the participant list next to your name.

About raise hand

Use the **Raise Hand** button to let others know you have a question or a comment without interrupting the conversation.

Both the host and others in the meeting see an on-screen notification that someone has raised their hand. The notification with a full name shows up for the first raised hand.

After that, the Raise Hand icon shows how many have raised their hands.

Open the Participants list to see who has raised their hand.

Raise Hand is available in CMS meetings with more than two participants.

Video calls

Find call details for recent calls

1

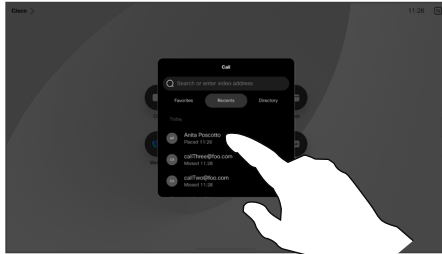

Tap **Call** and select an entry in the Recents list.

2

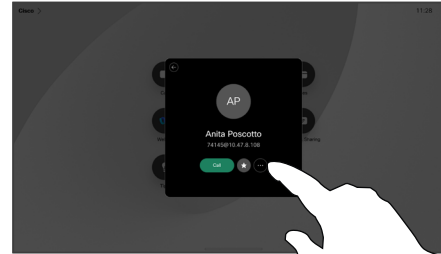

Tap **More**.

3

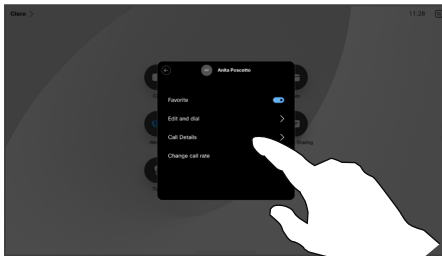

On the next screen, tap **Call details**.

4



Scroll down the list to see the call details. Tap the back arrow to leave the details screen.

About call details

To troubleshoot a recent call, you can find the call details in the recent calls list.



Cisco Proximity

Cisco Proximity ultrasound signal

Cisco devices emit ultrasound as part of the Proximity feature. Most people are exposed to ultrasound more or less daily in many environments, including industry, commercial applications, and home appliances.

Even if airborne ultrasound may cause subjective effects for some individuals, it is very unlikely that any effects occur for sound pressure levels below 75 dB. Guidelines for ultrasound exposure limits vary heavily between countries, but 75 dB is the lowest limit presently found for the frequency band around 20 kHz, which is where the Cisco proximity signal is emitted.

A good reference for this information is Health Canada's guidelines, http://www.hc-sc.gc.ca/ewh-semt/pubs/radiation/safety-code_24-secureite/index-eng.php#a2.2.2.

These guidelines state that sound pressure levels lower than 120 dB have not been demonstrated to cause hearing loss, neither permanently nor temporarily.

For Cisco devices for personal use the ultrasound sound pressure level is below 70 dB at a distance of 20 cm or more from the loudspeaker.

In most practical cases the level at the ear of the user will be much lower than these max levels, due to loudspeaker directivity, distance attenuation, and high degree of high frequency absorption in typical rooms. The levels will range from what for audible sound would be typical background / ambient noise levels in meeting spaces up to so-called conversational levels of normal speech.

It is therefore deemed safe for humans to be continuously subjected to the proximity signal. Most people will not be aware of the presence of the signal, and suffer no effects from it. A few individuals with especially acute high frequency hearing can, however, be able to hear it, this is most likely to happen directly in front of and close to the loudspeaker.

Animals like dogs will hear the proximity signal, since their frequency range of hearing is so much wider.

However, the effect of sound is also level dependent, and the level range of a dog's hearing is not significantly different from that of a human. The hearing threshold of dogs at 20 kHz can be as low as 0–10 dB, similar to the threshold of a human ear in its most sensitive frequency range.

Cisco has not done testing or qualification of the possible effects the signal can have on dogs. Due to the limited levels it is believed that while the signal is clearly audible, it is not bothersome to dogs.

A dog in an office or meeting room will be subject to ultrasound at levels comparable to normal background noise, or at most conversational levels. There has been no reports of animals being bothered by the signals in the years we have had this feature in our products.

However, the question of ultrasound effect on dogs is fair, since dog repeller devices using ultrasound do exist. These devices typically claim to use discomforting, but not harmful ultrasound. Cisco does not have insight into dog repeller design, but scanning the specifications of such devices typically reveals that the exposure levels typically are 100 dB and upwards.

For solutions using Cisco video codecs with 3rd party loudspeaker systems Cisco is not able to control the ultrasound sound pressure level. In most cases the necessary loudspeaker sensitivity and frequency response will result in levels below the 75 dB limit. However, if excessive external amplification is applied, or the loudspeaker system has an emphasized high-frequency response, levels in excess of the limit can be produced.

About Cisco Proximity

The Cisco Proximity feature allows you to share content from a computer wirelessly on a Cisco device. You can even use your own smart phone, tablets, PC or MAC to control calls on the video device.

Observe the following:

You need to download (free of charge) the Cisco Intelligent Proximity app from App Store or Google Play.

Windows or OS X users, go to <https://proximity.cisco.com/>.

Your video support team may have activated none, some, or all of the available features.

Proximity uses ultrasound to connect users (more at left). Don't block the microphone on your computer, phone or tablet.

Proximity doesn't work outside meeting rooms when doors are closed. You need to be close to the video endpoint to use Proximity.

For privacy, keep meeting room doors closed to avoid possible eavesdropping.

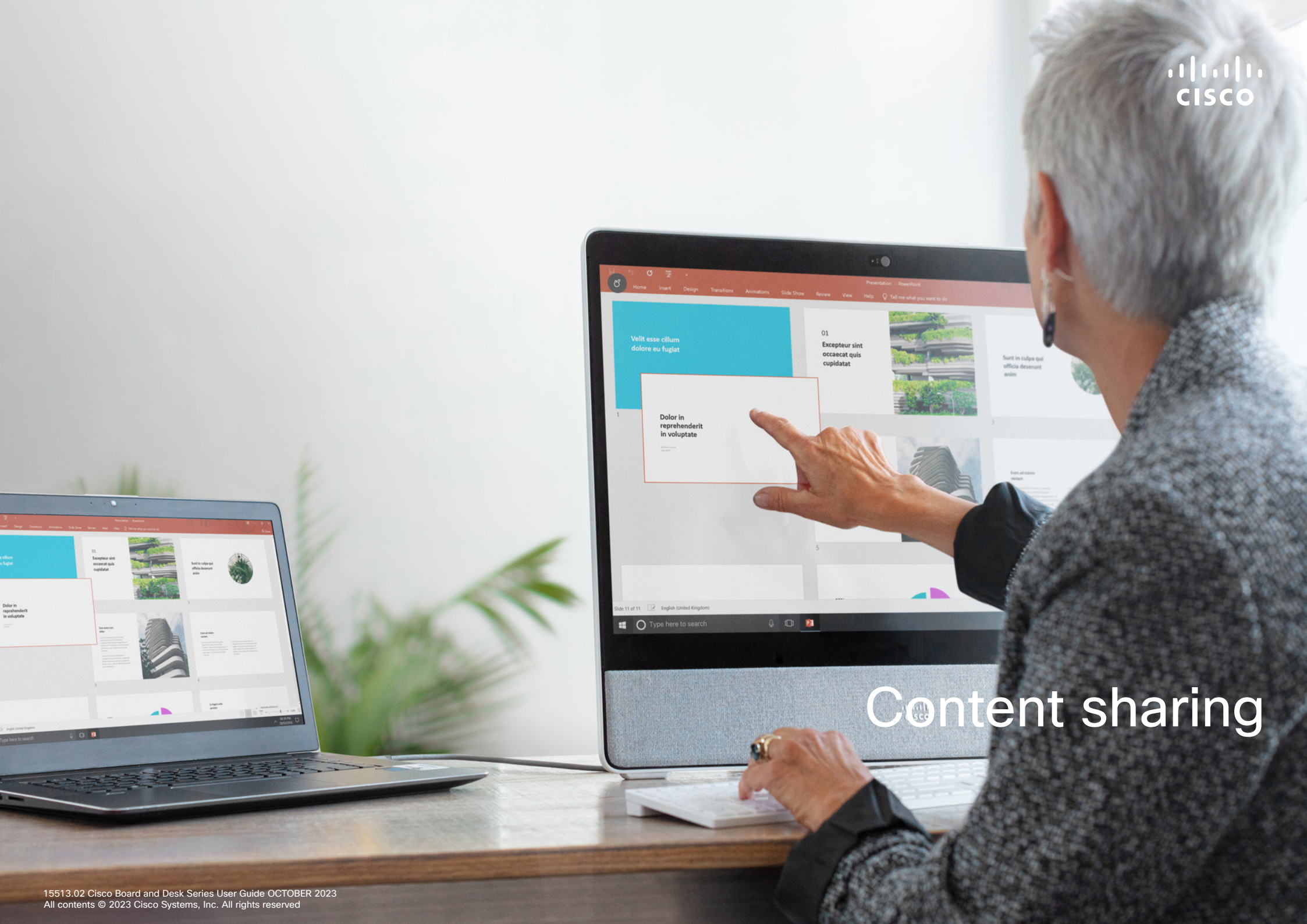

Content sharing

Content sharing

Share content with a cable

1

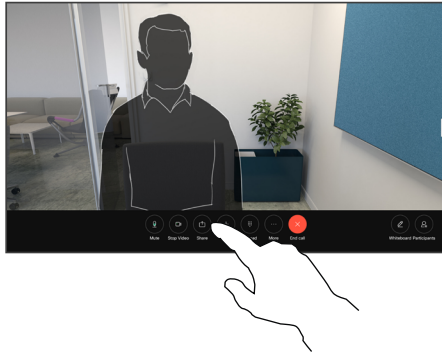

If using a cable, connect your source and make sure it's switched on. Tap the screen to get the call controls and then tap the **Share** button.

3

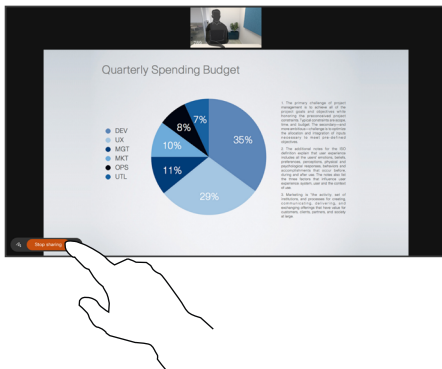

To stop sharing content, tap **Stop sharing**.

2



Select your source. Tap **View** for a preview. No one can see your computer screen yet - tap **Share** when you're ready. Or tap **Share in call** to share immediately.

About content sharing

Share content and whiteboards on your Cisco device by connecting your PC to the device with a USB-C or HDMI cable. Or, share wirelessly with your Webex app, Cisco Proximity, Miracast®, or AirPlay.

To share outside a call using a cable, connect your source and make sure it's switched on. Your computer screen will appear on the device. To stop sharing swipe up from the bottom of your device screen and select a different screen, or disconnect your source.

When your camera is on you can show yourself in front of your content, as though you were presenting in a meeting room. Just connect your laptop with the HDMI or USB-C cable. Tap the **Share** button in the call controls. Toggle on **Show me in front of presentation** and then tap **Share in call**. Drag and drop your image on the screen to your preferred location, and pinch and zoom your image to change its size.

When Miracast is enabled you can share content wirelessly from your laptop to a Cisco device without a client. This works both in and out of calls: to share in-call, start the call first.

When AirPlay is enabled you can wirelessly connect your iPhone, iPad, or Mac, to share your screen, collaborate, and playback audio and video content.

Content sharing

Share content with the Webex app

On Windows and Mac laptop

1. Click on the device name on the Webex App and click **Share on device**.
2. Select the screen or app to share.
3. In order to see a preview of what you're sharing at the top of the screen. go to the control bar at the top of the screen and click the down arrow.
4. When you're done, click on **Stop Sharing**.

About the Webex app

After you have enabled ultrasound, you can automatically connect to the device as soon as you enter the same room. You can use these devices to share content wirelessly with people in the same room.

Note that Cloud Pairing is required when sharing content with the Webex app on mobile. Read [this article](#) for more information.

Content sharing

Share content with Miracast®

On Windows laptop

1. On your laptop press **Windows+K**, or click the Action Center icon and then click **Connect**. Windows will scan for Miracast receivers.
2. Click on the Board or Desk Series device you want to cast to. A PIN will appear on the device's screen.
3. Enter the PIN on your laptop and click **Connect**.
 - When in call, an auto share pop up appears, showing a five-second countdown before the sharing starts. During the countdown you can cancel the share.
 - Outside a call, the sharing starts immediately.
4. Sharing starts.

On Android phone

1. On a Samsung device, open the Settings menu and select **Smart View** or **Dex**. Note that the naming is different on other Android devices.
2. Click on the Board or Desk Series device you want to cast to. A PIN will appear on the device's screen.
3. Enter the PIN on your Android device.
4. Tap **Connect**.
 - When in call, an auto share pop up appears, showing a five-second countdown before the sharing starts. During the countdown you can cancel the share.
 - Outside a call, the sharing starts immediately.
5. Sharing starts.

About Miracast

Miracast uses Wi-Fi Direct to establish a direct network connection from your laptop to the Cisco device, allowing you to share content wirelessly. This works both in and out of calls: to share in-call, start the call first. Making or receiving a call during an active share will disconnect your Miracast session. Read [this article](#) for more information.

Content sharing

Share content with Airplay®

On Iphone, Ipad, or Mac

1. Open the **Control Center** on your iPhone, iPad, or Mac.
Select **Screen Mirroring**.
2. Select the Board or Desk Series device you want to cast to.
A passcode will appear on the device's screen.
3. Enter the passcode on your Apple device and select **OK**.
4. Sharing starts.

Swiping up from the bottom of the homescreen opens the Task Switcher, and you can move to another app. This will end your share.

About Airplay

Cisco devices support AirPlay, offering another simple and familiar sharing experience. Wirelessly connect your iPhone, iPad, or Mac to effortlessly share your screen, collaborate, and playback audio and video content. Read [this article](#) for more information.

Content sharing

Change the screen layout in a call

1

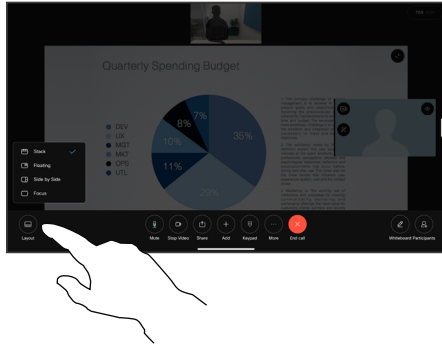

During a call, tap the screen to get the call controls and then tap the **Layout** button.

2

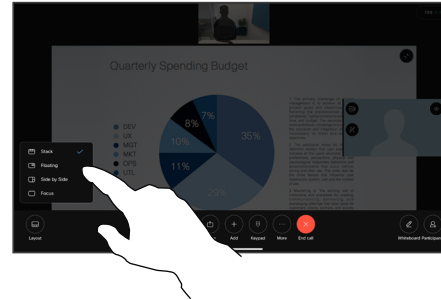

Select your preferred layout from the menu that opens.

When sharing a presentation

The layouts available to you depend on your device and number of screens, but typical options include:

Stack: presenter and up to 6 participants are stacked above the content.

Floating: presenter floats over top of the content.

Side by Side: presenter and content share the screen.

Focus: content takes the whole screen.

1

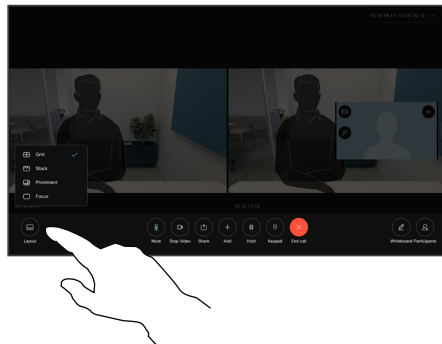

During a call, tap the screen to get the call controls and then tap the **Layout** button.

2

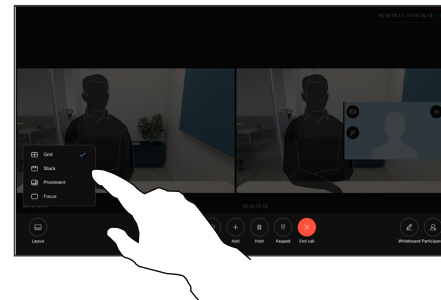

Select your preferred layout from the menu that opens.

Layouts available in a call

The layouts available to you depend on your device and number of screens, but typical options include:

Grid: shows a grid of up to 5 participants. Grid is the default layout for single screens.

Stack: up to 6 thumbnails of the participants appear above the active speaker.

Prominent: shows the active speaker in the upper left part of the screen, while other participants are arranged along the bottom and on the right side.

Focus: the active speaker takes the whole screen.

Content sharing

Whiteboarding

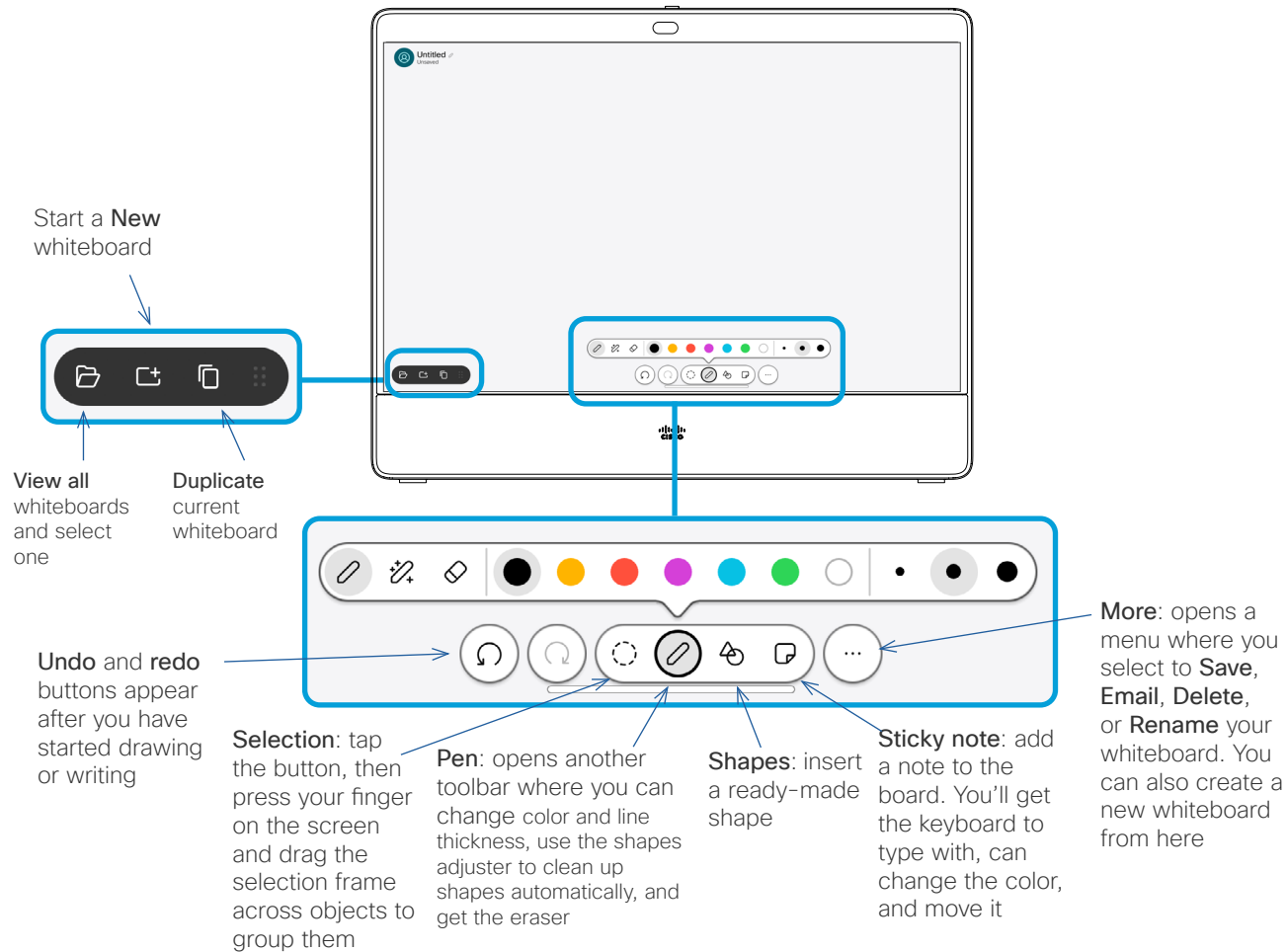

About whiteboards

You can use your Board or Desk series device for digital whiteboarding.

To open the whiteboard tap the **Whiteboard** button on the homescreen, and use the stylus or your finger to write and draw.

The size of a whiteboard page is as large as you want. Use two fingers to drag the whiteboard and pinch to zoom.

To save your whiteboard drawings you can send them as emails. If your device is configured to do this, tap the **More** button and select **Send as email**. Whiteboards are sent in PDF format.

Remember, swiping up from the bottom of the screen opens the task switcher. You'll see any open apps, other current whiteboards, and the homescreen there, and can switch between them.

To delete all whiteboards, open the control panel and tap **End Session**.

End your session to clear your device

1

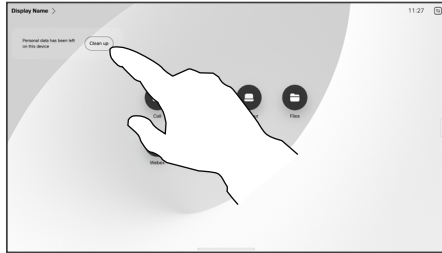

When you're finished working, open the control panel and tap **End session**. You can also tap **Clean up** on the home screen. This notification will appear when you have quit applications and left personal data.

2



Decide if you want to clear all whiteboards, all website data, or both. The option to delete website data appears only if the web engine is enabled.

About sessions

During a session your whiteboards, annotations, and web activity is stored on your device. You can take a break or switch between activities and then go back to your files and continue your work.

If your device is in shared mode, you can end your session at any time to clear up all whiteboards and browsing data for the next user.

By default, whiteboards and web data are deleted automatically every day at midnight. Check with your system administrator if the automatic cleanup is disabled or set to occur at a different time.

Content sharing

Annotate shared content

1

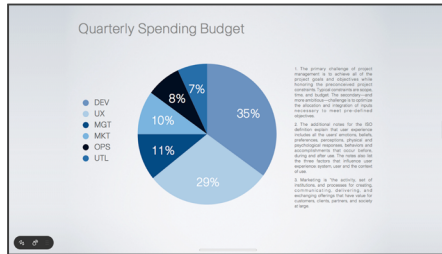

Outside calls, share your computer screen with the image you want to annotate on it, to your device. Tap the **Annotation** button.

2

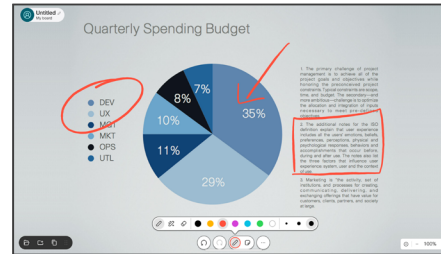

Make your annotations using the tools across the bottom of the screen. You can then resume a presentation or disconnect your source completely.

3

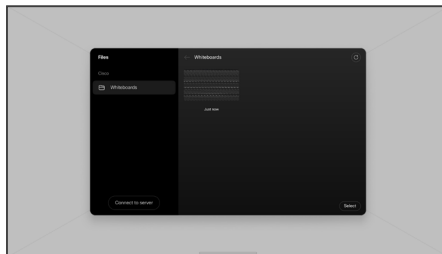

Your annotated image is saved as a whiteboard. Swipe up to see all your current whiteboards. You can add another whiteboard or delete any of the existing whiteboards. Whiteboards will be deleted when your session is over.

About annotation

You can annotate a presentation outside calls.

When you annotate an image, a snapshot of that image is generated, so that your changes don't impact the presentation.

When you're finished, the annotated image exists as a whiteboard. Note that the whiteboards are deleted from the device after a while for privacy reasons.

To keep your annotations, send them by email, if your device is configured for it.

Annotations are sent as PDFs.

Send annotations or drawings by email

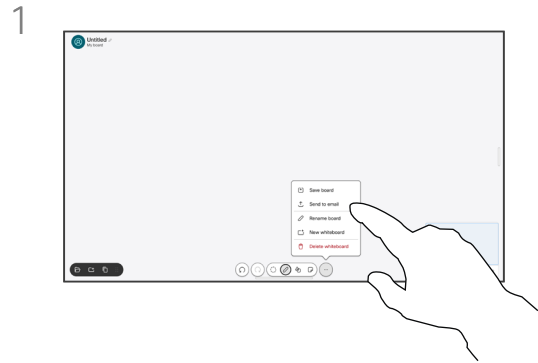

On your whiteboard, tap **More** and then tap **Send to Email**.

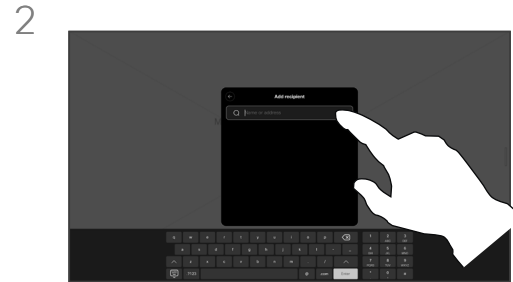

Start typing a recipient name or address. Select the person and tap the right arrow.

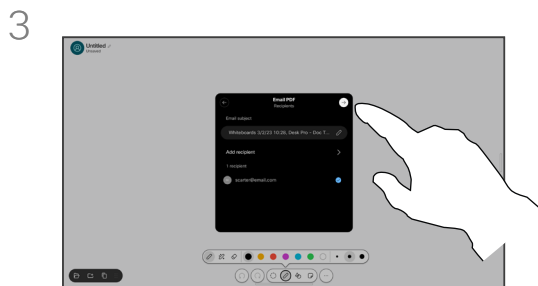

Add more recipients if you want, and tap the white arrow when you're done.

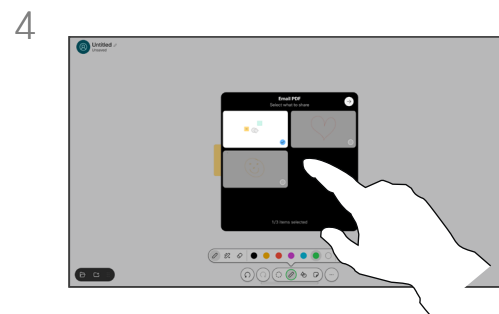

Select the whiteboard(s) you want to send. Tap the white arrow again, and your whiteboards are sent.

About annotation

You can send one or more whiteboards as an email attachment to the recipient(s) of your choice, provided that your device is configured for it.

The whiteboards are sent in PDF format.

On a shared device, this is the only way to keep a whiteboard after your whiteboarding session is over.

Content sharing

Wired touch redirect

You can control your laptop from a Cisco device's screen. This works when you have connected your Windows 10 laptop to the device with an HDMI cable and/or a USB-C cable. It's great for tasks involving drag and drop, drawing programs, and maps.

Touch redirect is available if you're sharing locally or sharing in a call.

The feature is tested and verified with Windows 10. Basic functionality should also work with another OS.

(Board Series) NOTE: This feature is available on S-series Boards and Board Pro only.

Limitations:

- When you use touch redirect, you can't annotate on the screen you are sharing.
- Volume control on the Cisco device is not available when touch redirect is in use. Use the volume control from your laptop.
- *(Board Series)* If your device has a Touch 10 or Room Navigator controller connected, you can't move your self-view while a USB-C cable is connected to the board.

Enable drag and drop in your browser

To use touch redirect for drag and drop on your browser, enable it on your browser.

- Chrome: go to **chrome://flags/#touch-events** and set to **Enabled**.
- Firefox: go to **about:config** and set **Dom.w3c_touch_events.legacy_apis.enabled = true**.
- Edge: go to **about:flags** and set **Enable Touch Events = always on**.

Use touch redirect with Windows 10 laptops

1. Switch your laptop to tablet mode by selecting the action center on the taskbar next to the date and time, and then select Tablet mode to turn it on.
2. Connect your laptop to a Cisco device with an HDMI cable and/or a USB-C cable. You can use either a USB-C-USB-C cable, or a USB-C-USB-A cable.
Note: USB-C-USB-A cables are supported for longer cable lengths.
3. Tap Share on the device screen and then tap the **Touch Redirect** button.

If you want to switch to other activities on the device while you are using touch redirect, swipe up from the bottom of the screen and open another screen or app.

Content sharing

Web apps

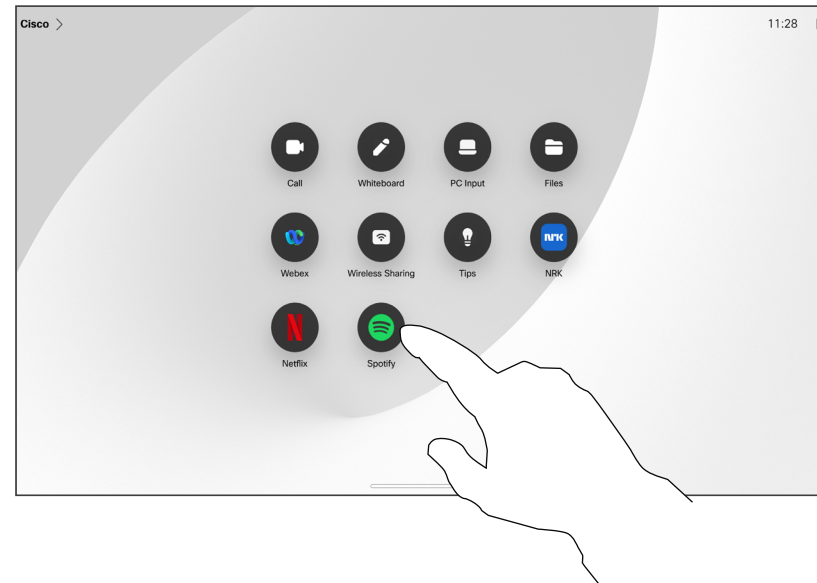

About web apps

A web app is a web page or application you access from the device's home screen. You can share and work on a web app locally or in call.

Web apps launch in full screen, and time out after 15 minutes if not used. The web app may be interactive.

When you open a web app in a call, it's automatically shared. You can't preview the web app while in call.

When presenting a web app that plays audio but doesn't allow volume control, you can't adjust the audio that's shared to the participants. Data such as cache, cookies, and local storage, is automatically cleared when the session ends.

You can add, delete, and edit web apps directly from the settings menu on your device.

Open the control panel and tap **Device settings**. Scroll to and tap **Manage Web Apps**. You can add a web app, and edit or delete ones that are already there.

Any web apps configured in the UI extension editor are visible in the web apps list under Externally Managed Web Apps, but it's not possible to edit or delete them from the device.



Scheduled meetings

Scheduled meetings

Join a scheduled meeting

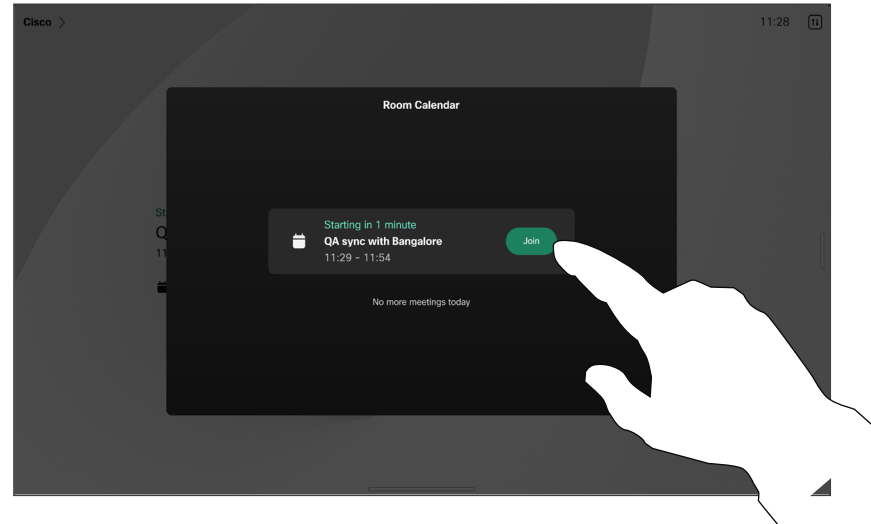

When a meeting is about to start, you'll be prompted to join it. Tap **Join**.

Joining a meeting

Your video device may be connected to a management system capable of scheduling video meetings. Any meetings scheduled will then appear as shown at left. When a scheduled meeting appears on the device screen, the device wakes up from stand-by.

Tap **Join** to participate in the meeting.

The meeting appears 5 minutes before its starting time. You can join the meeting at any time, even if the meeting has already started.

Scheduled meetings

Join a Webex meeting

Joining a meeting

Your device may be connected to a management system connected to Webex.

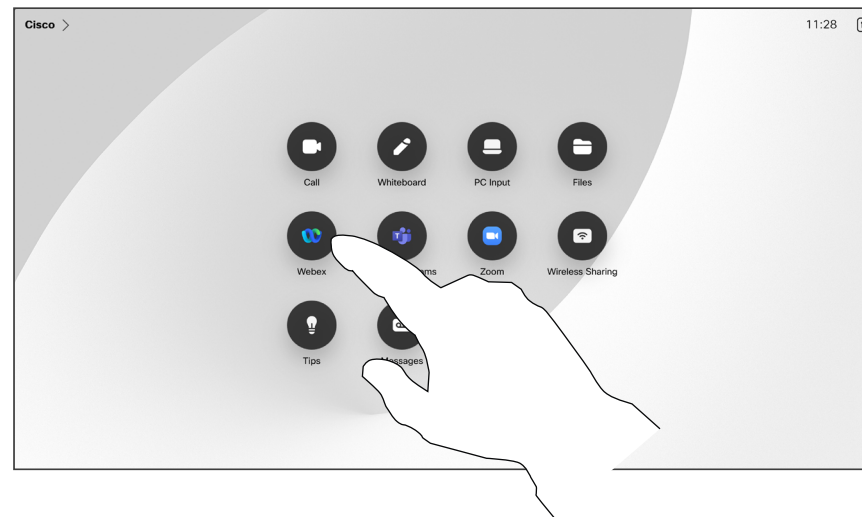

Tap **Webex**. You are prompted to type in the meeting number you received in your invite. Tap Join to join the meeting.

Scheduled meetings

Join a third-party meeting

Joining a meeting

Your device may be connected to a management system connected to Zoom or Microsoft Teams.



Tap **Microsoft Teams**, or **Zoom**. You are prompted to type in the meeting number you received in your invite. Tap **Join** to join the meeting.



Contacts



Favorites, Recents, and Directory

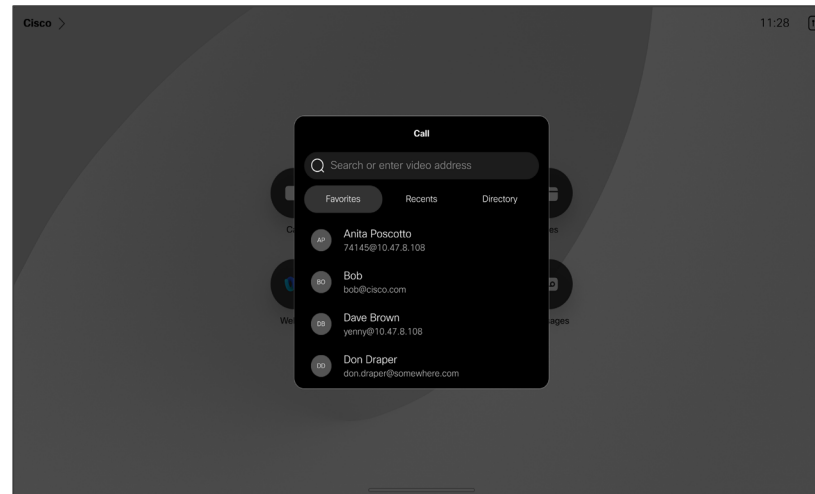

About the Contact lists

Tap the **Call** button to open your contacts lists. The contacts list consists of three parts:

Favorites. These contacts are put there by you. These entries are those you call frequently or otherwise need to access in a swift and convenient manner from time to time.

Directory is typically a corporate directory installed on your device by your video support team.

Recents is a list of calls you have placed, received or missed earlier.

Note that removing entries from *Recents* can only be done from the web interface.

Contacts

Add someone to Favorites during a call

1

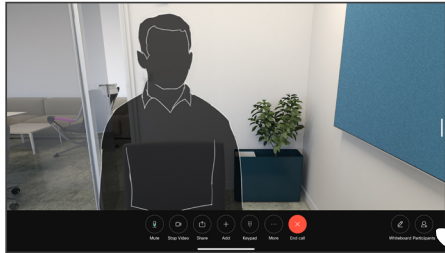

In a call, tap the screen to get the call controls and then tap the **Participants** button.

2

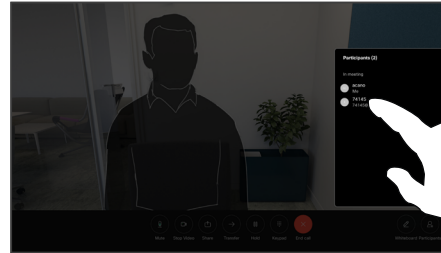

Tap the participant to add to Favorites.

3

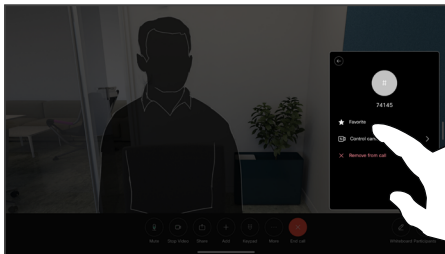

Tap **Favorite**. Tap outside the menu to close it. Remove people from Favorites the same way.

About favorites

The **Favorites** is your own shortlist of contacts you frequently call or otherwise want to have easy access to.

Favorites may be populated from the Recents or Directory lists as well as from manual entries.

Contacts

Add someone to Favorites outside a call

1

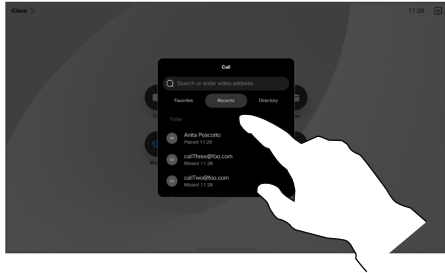

While not in a call, tap **Call** to open the contacts list. Tap **Recents** or **Directory** and search for the entry to add to your Favorites and tap it to open the contact card.

2

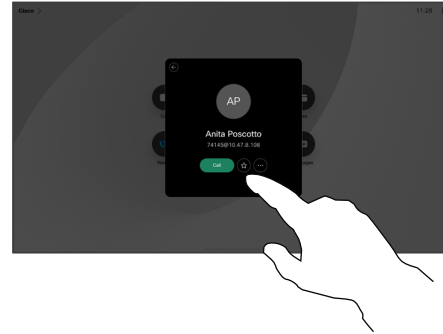

Tap the star button on the contact card to favorite the person right away. Or, tap the **More** button.

3

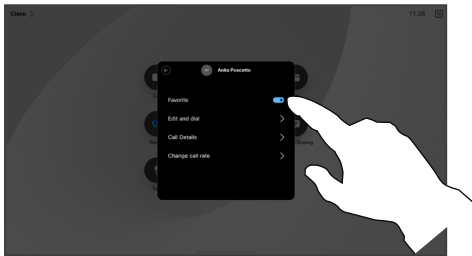

Toggle **Favorite** on or off. Tap anywhere outside the menu to exit.

4

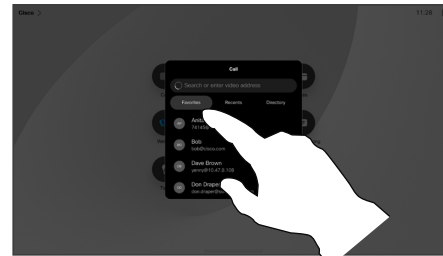

To remove an entry from your Favorites, go to **Favorites** in the contacts list and repeat the procedure.

About favorites

The **Favorites** is your own shortlist of contacts you frequently call or otherwise want to have easy access to.

Favorites may be populated from the Recents or Directory lists as well as from manual entries.

Contacts

Edit a Favorite

1

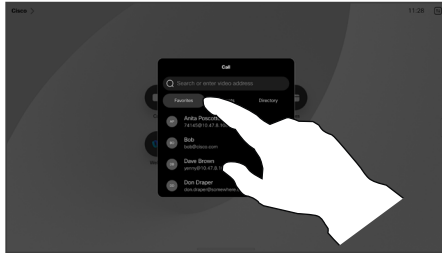

Tap **Call** to open the contacts list. Then tap **Favorites**.

2

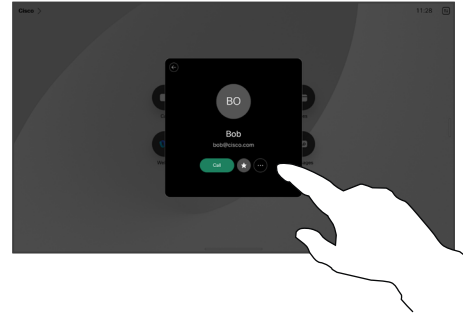

Tap the person to be edited. Then tap **More**.

3

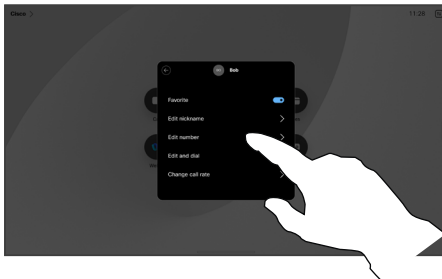

Edit the entry and tap **Save** on the keyboard to exit. Otherwise tap the back arrow on the contact card, or anywhere outside the card to exit.

About favorites

You can update a favorite contact at any time.



Camera control

Camera control

Turn the camera on and off

1

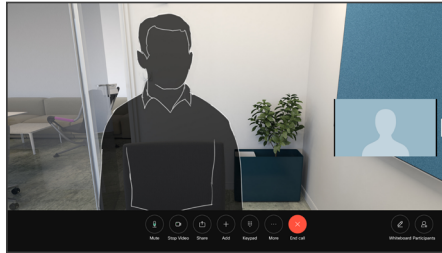

During a call, tap the screen to get the call controls.

2

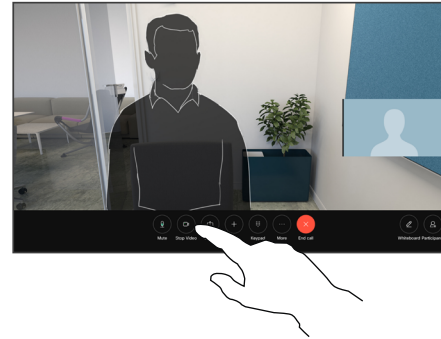

Tap the **Stop Video** button. Tap Start Video to turn the outgoing video back on.

About video off

You can also control the video transmission from your camera on some devices by mechanically blocking the camera.

Camera control

Access and adjust the selfview in and out of call

1

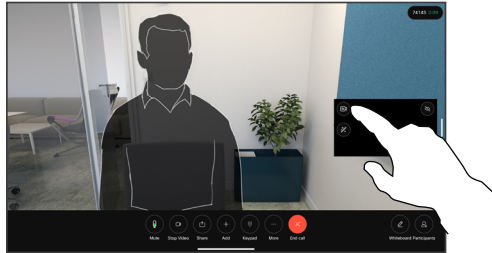

Make sure your camera is on. During a call, tap the screen to open the selfview up on top of the call. Then tap the button on the selfview's right corner and change the visibility to **Hide**, **Show in call**, or **Always show**.

In or out of call, open the control panel and tap the Selfview button to get the same settings.

2

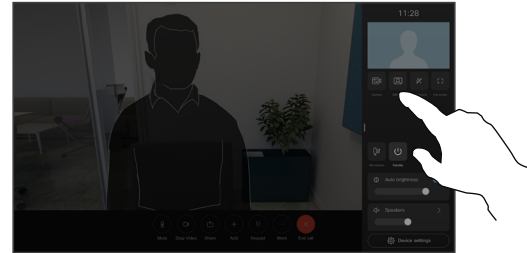

Even when you select to hide it, your selfview will still appear to you in the control panel with the same options available there.

About selfview

The selfview shows what others see from your device. You can use it to confirm that they see what you want them to see.

You can see, adjust, and move your selfview around the screen both in and out of call.

To check your selfview at any time, open the control panel. As long as your camera is open/on, you'll see your selfview there and can expand it to **Fullscreen** if you want. To exit fullscreen, open the control panel and tap Fullscreen again.

Tap the **Selfview** button in the control panel to set visibility for your selfview to **Hide**, **Show in call**, or **Always show**.

Camera control

Move the selfview

1

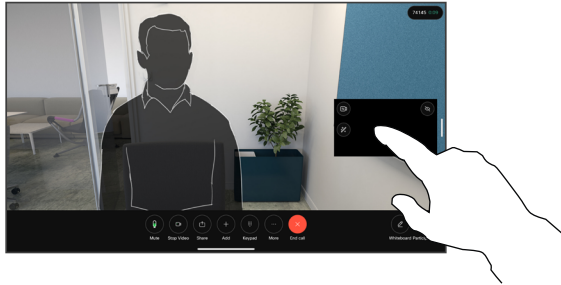

Tap and hold the selfview image. Drag and drop it to a new position on your screen.

2

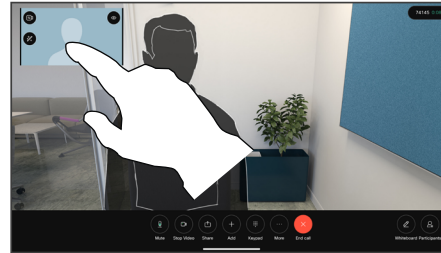

Lift your finger to release the image in the new place.

About selfview

Selfview shows what others see from your device. You can use it to confirm that they see what you want them to see.

You can see, adjust, and move your selfview around the screen both in and out of call.

Virtual backgrounds (Desk Series)

1

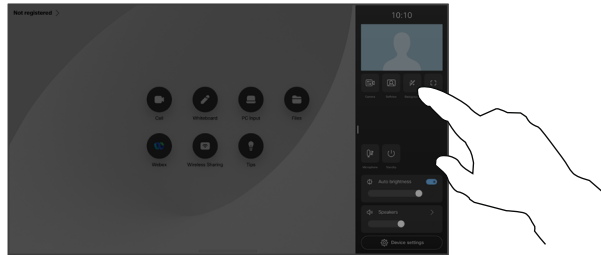

Open the control panel and tap the **Background** button, or, tap on your selfview image and then tap the Background button there.

2

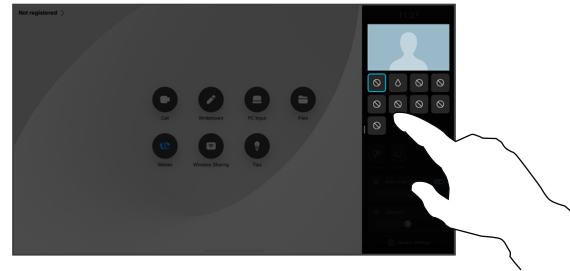

The background options open and you can choose one. Tap anywhere outside the control panel or selfview when you're done.

About backgrounds

With video backgrounds you can change or blur the background of the image others see in the video meeting. This helps you to be the focus of the image or hide a messy background at the office.

Background options:

- Background blur
- Computer screen share as background (if your computer is connected to the desk device)
- Standard background images
- Custom background image (if custom images have been uploaded by your administrator)

NOTE: The blurring may not cover the background entirely and possible sensitive information may be visible to others in the video meeting.

Camera control

Control your camera manually

1

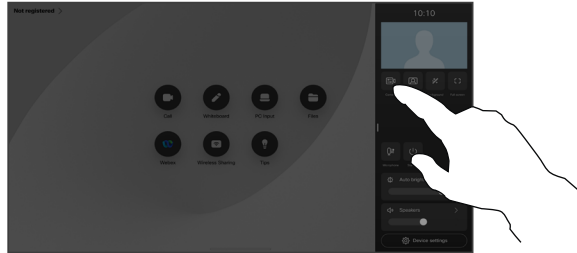

In or out of call, open the control panel and tap the **Camera** button. Or, tap the selfview image and then tap the Camera button there.

Select **Manual** under Camera mode.

2

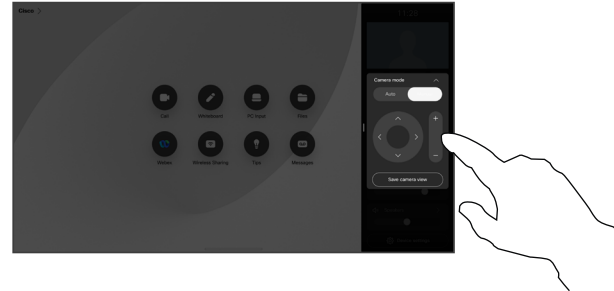

Use the controls to pan, tilt, and zoom the camera. Tap anywhere else on the screen to exit.

About manual camera control

Desk devices automatically frame you with **Best view**. However, in some situations on any device you might want to adjust the framing.

You can control the zoom, pan, and tilt of the camera manually, in or out of a call.

(Board Series) When you adjust the camera manually, if you like the view you might want to save it to use again. To create and save custom views with predefined zoom and camera direction, you need to use a touch controller, connected to your Board. If you've got a touch controller connected to your Board, see the *RoomOS 11.1 Room Series User Guide*, for details.

Camera control

Select an automatic camera mode *(Board Series)*

1

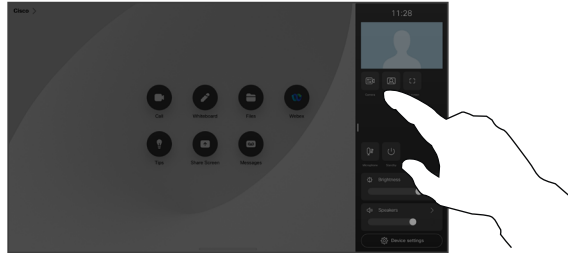

In or out of call, open the control panel and tap the **Camera** button. Select **Auto** under Camera mode.

2

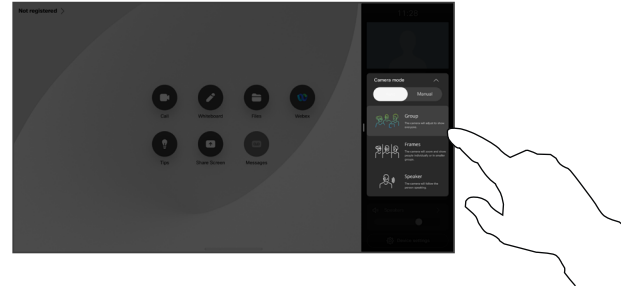

Choose a camera mode. Tap outside the control panel to exit.

About camera modes

By selecting an automatic camera mode you'll get the best view for your device and meeting, without having to manually control the cameras yourself during meetings. You can change camera modes whether you're in a call or not.

The automatic modes available to you depends on configurations your administrator has set:

- **Group.** The camera will adjust to show everyone.
- **Frames.** Crops away unnecessary space around participants and composes a view where the people appear closer together, evenly sized and at the same eye level, in up to four frames.
- **Speaker.** The camera will follow the person speaking. The maximum distance for speaker tracking to work is 7.5 meters.

If you have a Touch 10 or Room Navigator connected to your Board, you can also use that to control the camera view.

Camera control

Control a far-end camera

1

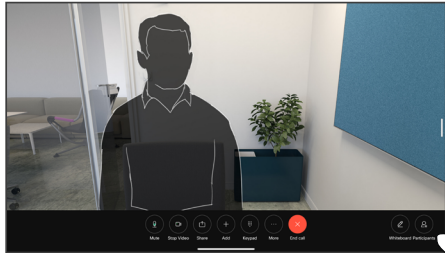

During a call, tap the screen to get the call controls. Then tap the **Participants** button.

2

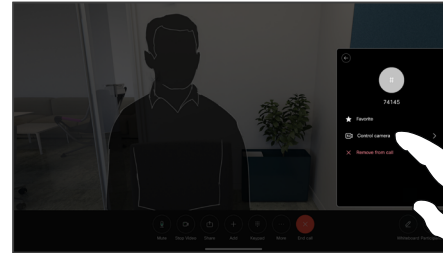

Tap the participant whose camera you want to control, then tap **Control camera**.

3

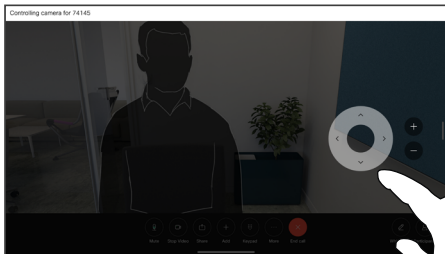

Adjust the remote camera's tilt, pan, and zoom with the camera control buttons. Tap anywhere outside the controls when you're done.

About far-end cameras

When you're in a video call where one or more of the other devices have a remotely controllable camera, you can control those cameras from your own device.

If the far-end device has activated **Speaker** mode where the camera follows the active speaker or is using **Best View**, you can't control the camera remotely.

You don't have remote access to any camera presets.



Settings

Settings

Control panel and Device settings

In the **Settings** menu you can check device information and change several settings.

- About - provides video address information, IP and MAC address, SIP Proxy, and the current software version
- Issues and diagnostics
- Activate and deactivate Bluetooth
- Select ringtone and set its volume
- Turn Music mode on or off.
- Choose a call service
- Select between Wired and Wireless (Wi-Fi) connection
- Restart the device
- Perform a Factory Reset to return to factory default settings. By doing this, you lose your current registration. You cannot undo a factory reset

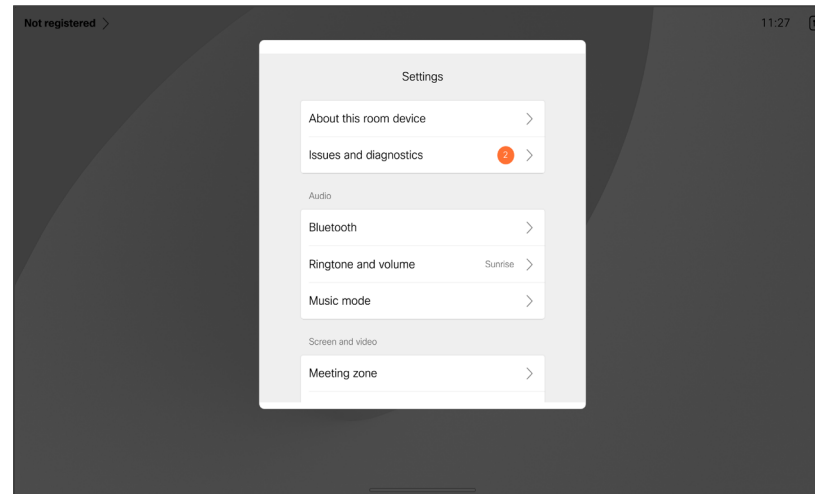

Access the settings

To open the control panel swipe from the right side of the screen, or tap the button on the upper right corner of the home screen. As long as your camera is open, you'll see your self-view at the top. In the control panel you can find:

- Camera controls
- Selfview
- (*Desk Series*) Backgrounds
- Microphone options
- Standby
- Screen brightness
- Device volume/speakers
- Access to device settings
- End session (when you have created whiteboards or annotations)

To get to the Settings menu, open the control panel. Then tap **Device settings**. The menu opens and you can scroll through it. If you are in a call, the menu opens as a dialog on top of your call.

Which settings are available may have been restricted by your administrator.



Americas Headquarters

Cisco Systems, Inc.
San Jose, CA

Asia Pacific Headquarters

Cisco Systems (USA) Pte. Ltd.
Singapore

Europe Headquarters

Cisco Systems International BV Amsterdam,
The Netherlands

Cisco has more than 200 offices worldwide. Addresses, phone numbers, and fax numbers are listed on the Cisco Website at www.cisco.com/go/offices.

Cisco and the Cisco logo are trademarks or registered trademarks of Cisco and/or its affiliates in the U.S. and other countries. To view a list of Cisco trademarks, go to this URL: www.cisco.com/go/trademarks. Third-party trademarks mentioned are the property of their respective owners. The use of the word partner does not imply a partnership relationship between Cisco and any other company. (1110R)