

Cisco UCS X215c M8 Compute Node

A printed version of this document is only a copy and not necessarily the latest version. Refer to the following link for the latest released version:

<https://www.cisco.com/c/en/us/products/servers-unified-computing/ucs-x-series-modular-system/datasheet-listing.html>



OVERVIEW	3
DETAILED VIEWS	5
Cisco UCS X215c M8 Compute Node Front View	5
COMPUTE NODE STANDARD CAPABILITIES and FEATURES	7
CONFIGURING the Cisco UCS X215c M8 Compute Node	9
STEP 1 CHOOSE BASE CISCO UCS X215c M8 COMPUTE NODE SKU	10
STEP 2 CHOOSE CPU(S)	11
STEP 3 CHOOSE MEMORY	14
Memory configurations and mixing rules	16
STEP 4 CHOOSE REAR mLOM ADAPTER	19
STEP 5 CHOOSE OPTIONAL REAR MEZZANINE VIC/BRIDGE ADAPTERS	23
STEP 6 CHOOSE OPTIONAL FRONT MEZZANINE ADAPTER	25
STEP 7 CHOOSE OPTIONAL GPU PCIe NODE	26
STEP 8 CHOOSE OPTIONAL GPUs	27
STEP 9 CHOOSE OPTIONAL DRIVES	28
STEP 10 ORDER M.2 SATA SSDs AND RAID CONTROLLER	30
STEP 11 ORDER NVMe BOOT (OPTIONAL)	31
STEP 12 CHOOSE OPTIONAL TRUSTED PLATFORM MODULE	32
STEP 13 CHOOSE OPERATING SYSTEM AND VALUE-ADDED SOFTWARE	33
STEP 14 CHOOSE OPTIONAL OPERATING SYSTEM MEDIA KIT	36
SUPPLEMENTAL MATERIAL	37
Simplified Block Diagram	37
UPGRADING or REPLACING CPUs and Memory	41
TECHNICAL SPECIFICATIONS	42
Dimensions and Weight	42
Environmental Specifications	42
DISCONTINUED EOL PRODUCTS	43

OVERVIEW

The Cisco UCS X-Series Modular System simplifies your data center, adapting to the unpredictable needs of modern applications while also providing for traditional scale-out and enterprise workloads. It reduces the number of server types to maintain, helping to improve operational efficiency and agility as it helps reduce complexity. Powered by the Cisco Intersight™ cloud operations platform, it shifts your thinking from administrative details to business outcomes with hybrid cloud infrastructure that is assembled from the cloud, shaped to your workloads, and continuously optimized.

The Cisco UCS X215c M8 Compute Node is integrated into the Cisco UCS X-Series Modular System. Up to eight compute nodes can reside in the 7-Rack-Unit (7RU) Cisco UCS X9508 Chassis, offering one of the highest densities of compute, IO, and storage per rack unit in the industry.

The Cisco UCS X215c M8 Compute Node offers the following:

- **CPU:**
 - Up to 2x 5th Gen. AMD EPYC™ CPUs with up to 160 cores per processor or
 - Up to 2x 4th Gen. AMD EPYC™ CPUs with up to 128 cores per processor
- **Memory:**
 - 24 x 256GB DDR5-6400 DIMMs, in a 2-socket configuration with 5th Gen. AMD EPYC™ processors
 - 24 x 256GB DDR5-5600 DIMMs, in a 2-socket configuration with 4th Gen. AMD EPYC™ processors
 - Up to 6 TB of capacity
- **Storage:** Up to 6 hot-pluggable, Solid-State Drives (SSDs), or Non-Volatile Memory Express (NVMe) 2.5-inch drives with a choice of enterprise-class Redundant Array of Independent Disks (RAID) or pass-through controllers with four lanes each of PCIe Gen 4 connectivity and up to 2 M.2 SATA or NVMe drives for flexible boot and local storage capabilities.
- **Optional Front Mezzanine GPU module:** The Cisco UCS Front Mezzanine GPU module is a passive PCIe Gen 4 front mezzanine option with support for up to two U.2/U.3 NVMe drives and two HHHL GPUs.
- **mLOM virtual interface cards:**
 - Cisco UCS Virtual Interface Card (VIC) 15420 occupies the server's Modular LAN on Motherboard (mLOM) slot, enabling up to 50Gbps (2 x25Gbps) of unified fabric connectivity to each of the chassis Intelligent Fabric Modules (IFMs) for 100Gbps connectivity per server.
 - Cisco UCS Virtual Interface Card (VIC) 15230 occupies the server's modular LAN on motherboard (mLOM) slot, enabling up to 100 Gbps of unified fabric connectivity to each of the chassis Intelligent Fabric Modules (IFMs) for 100 Gbps connectivity per server with secure boot capability.
- **Optional Mezzanine card:**
 - Cisco UCS Virtual Interface Card (VIC) 15422 can occupy the server's mezzanine slot at the bottom rear of the chassis. An included bridge card extends this VIC's 100Gbps (4 x 25Gbps) of network connections through IFM connectors, bringing the total bandwidth to 100Gbps per VIC 15420 and 15422 (for a total of 200Gbps per server). In addition to IFM connectivity, the VIC 15422 I/O connectors link to Cisco UCS X-Fabric technology.

- Cisco UCS PCIe Mezz card for X-Fabric can occupy the server's mezzanine slot at the bottom rear of the chassis. This card's I/O connectors link to Cisco UCS X-Fabric modules and enable connectivity to the X440p PCIe Node.
- **Security:** Includes secure boot silicon root of trust FPGA, ACT2 anti-counterfeit provisions, and optional Trusted Platform Model (TPM).

Figure 1 on page 5 shows a front view of the Cisco UCS X215c M8 Compute Node.

Figure 1 Cisco UCS X215c M8 Compute Node

Front View with Drives



Front View with Drives and GPU



DETAILED VIEWS

Cisco UCS X215c M8 Compute Node Front View

Figure 2 & Figure 3 is a front view of the Cisco UCS X215c M8 Compute Node.

Figure 2 Cisco UCS X215c M8 Compute Node Front View (Drives option)

Storage Drives Option

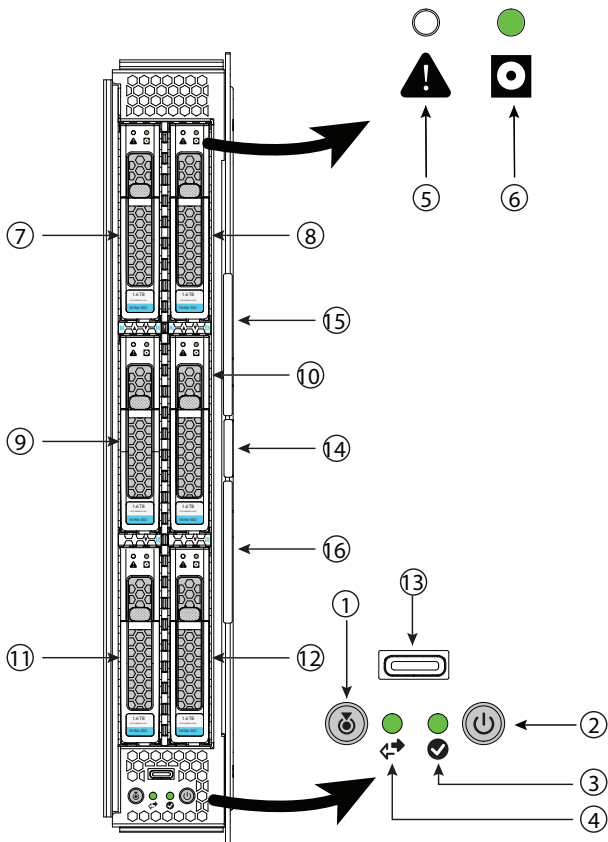

1	Locate button/LED	9	Drive Bay 3 (shown populated)
2	Power button/LED	10	Drive Bay 4 (shown populated)
3	Status LED	11	Drive Bay 5 (shown populated)
4	Network activity LED	12	Drive Bay 6 (shown populated)
5	Warning LED (one per drive)	13	OCuLink console port ¹
6	Disk drive activity LED (one per drive)	14	Ejector handle retention button
7	Drive Bay 1 (shown populated)	15	Upper ejector handle
8	Drive Bay 2 (shown populated)	16	Lower ejector handle

Notes:

1. An adapter cable (PID UCSX-C-DEBUGCBL) is required to connect the OCuLink port to the transition serial USB and video (SUV) octopus cable.

Figure 3 Cisco UCS X215c M8 Compute Node Front View (Drives and GPU option)

Storage Drives and GPU Option

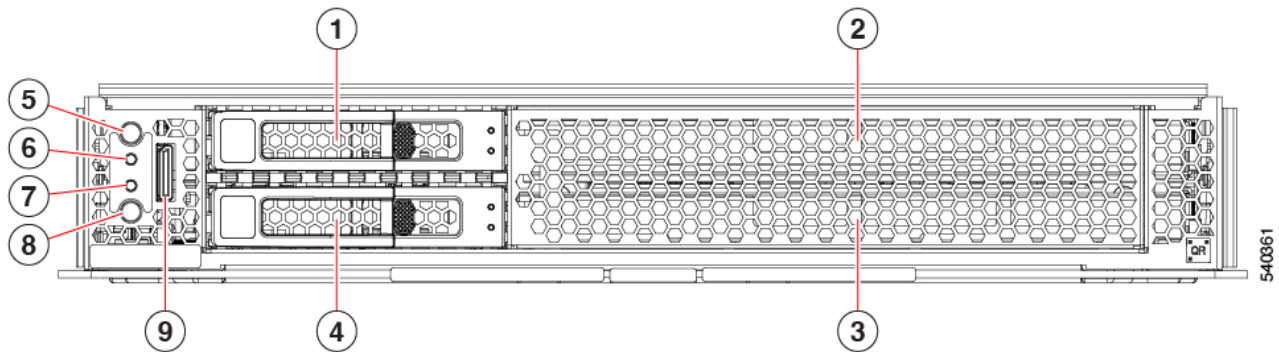

1	U.2/U.3 NVMe drive slot 1	6	Activity LED
2	GPU slot 1	7	Health LED
3	GPU slot 2	8	Locator LED
4	U.2/U.3 NVMe drive slot 2	9	Console port
5	Power Button/LED	-	-

COMPUTE NODE STANDARD CAPABILITIES and FEATURES

Table 1 lists the capabilities and features of the base Cisco UCS X215c M8 Compute Node. Details about how to configure the compute node for a listed feature or capability (for example, number of processors, disk drives, or amount of memory) are provided in *CONFIGURING the Cisco UCS X215c M8 Compute Node on page 9*.

Table 1 Capabilities and Features

Capability/Feature	Description
Chassis	The Cisco UCS X215c M8 Compute Node mounts in a Cisco UCS X9508 chassis.
CPU	<ul style="list-style-type: none"> ■ One or two AMD EPYC™ 97x4, 9004 Series, and 9004 Series with 3D V-Cache™ Technology Processors or ■ One or two AMD EPYC™ 9005 Series Processors
Memory	24 slots for registered DIMMs (RDIMMs)
Storage	Up to 6 hot-pluggable, Solid-State Drives (SSDs), or Non-Volatile Memory Express (NVMe) 2.5-inch drives with a choice of enterprise-class Redundant Array of Independent Disks (RAID) or pass-through controllers with four lanes each of PCIe Gen 4 connectivity and up to 2 M.2 SATA or NVMe drives for flexible boot and local storage capabilities.
Additional Storage	<ul style="list-style-type: none"> ■ Dual 80 mm SATA 3.0 M.2 cards (up to 960GB per card) on a boot-optimized hardware RAID controller ■ Dual 80 mm NVMe cards (up to 960GB per card) on a passthrough controller
Mezzanine Adapters (Front)	<p>One front mezzanine connector that supports:</p> <ul style="list-style-type: none"> ■ Up to 6 x 2.5-inch SAS and SATA RAID-compatible SSDs ■ Up to 6 x 2.5-inch NVMe PCIe drives ■ A mixture of up to six SAS/SATA or NVMe drives ■ A mixture of up to two GPUs and up to two NVMe drives <p> Note: Drives require a RAID or pass-through controller in the front mezzanine module slot or a front mezzanine GPU module.</p>
Mezzanine Adapter (Rear)	<ul style="list-style-type: none"> ■ An optional Cisco UCS Virtual Interface Card 15422 can occupy the server's mezzanine slot at the bottom of the chassis. A bridge card extends this VIC's 2x 50Gbps of network connections up to the mLOM slot and out through the mLOM's IFM connectors, bringing the total bandwidth to 100Gbps per fabric—a total of 200Gbps per server. ■ An optional UCS PCIe Mezz card for X-Fabric is also supported in the server's mezzanine slot. This card's I/O connectors link to the Cisco UCS X-Fabric modules for UCS X-series Gen4 PCIe node access.

Table 1 Capabilities and Features (continued)

Capability/Feature	Description						
mLOM	<p>The modular LAN on motherboard (mLOM) cards (the Cisco UCS VIC 15230 and 15420) is located at the rear of the compute node.</p> <ul style="list-style-type: none"> ■ The Cisco UCS Virtual Interface Card VIC 15420 is a Cisco designed PCI Express (PCIe) based card that supports two 2x25G-KR network interfaces to provide Ethernet communication to the network by means of the Intelligent Fabric Modules (IFMs) in the Cisco UCS X9508 chassis. The Cisco UCS VIC 15420 mLOM can connect to the rear mezzanine adapter card with a bridge connector. ■ The Cisco UCS Virtual Interface Card (VIC) 15230 occupies the server's modular LAN on motherboard (mLOM) slot, enabling up to 100 Gbps of unified fabric connectivity to each of the chassis Intelligent Fabric Modules (IFMs) for 100 Gbps connectivity per server with secure boot capability. 						
Video	<p>Video uses a Matrox G200e video/graphics controller.</p> <ul style="list-style-type: none"> ■ Integrated 2D graphics core with hardware acceleration ■ DDR4 memory interface supports up to 512 MB of addressable memory (16 MB is allocated by default to video memory) ■ Supports display resolutions up to 1920 x 1200 32 bpp@ 60Hz ■ Video is available with an Oculink connector on the front panel. An adapter cable (PID UCSX-C-DEBUGCBL) is required to connect the OCuLink port to the transition serial USB and video (SUV) octopus cable. 						
Front Panel Interfaces	OCuLink console port. Note that an adapter cable is required to connect the OCuLink port to the transition serial USB and video (SUV) octopus cable.						
Power subsystem	Power is supplied from the Cisco UCS X9508 chassis power supplies. The Cisco UCS X215c M8 Compute Node consumes a maximum of 1300 W.						
Fans	Integrated in the Cisco UCS X9508 chassis.						
Integrated management processor	The built-in Cisco Integrated Management Controller enables monitoring of Cisco UCS X215c M8 Compute Node inventory, health, and system event logs.						
Baseboard Management Controller (BMC)	ASPEED Pilot IV						
ACPI	Advanced Configuration and Power Interface (ACPI) 6.5 Standard Supported. ACPI states S0 and S5 are supported. There is no support for states S1 through S4.						
Front Indicators	<ul style="list-style-type: none"> ■ Power button and indicator ■ System activity indicator ■ Location button and indicator 						
Management	<ul style="list-style-type: none"> ■ Cisco Intersight software (SaaS, Virtual Appliance and Private Virtual Appliance) ■ Starting with UCS Manager (UCSM) 4.3(4) or later 						
Firmware standards	<table> <tr> <td>UEFI Spec</td> <td>2.9</td> </tr> <tr> <td>ACPI</td> <td>6.5</td> </tr> <tr> <td>SMBIOS Ver</td> <td>3.6</td> </tr> </table>	UEFI Spec	2.9	ACPI	6.5	SMBIOS Ver	3.6
UEFI Spec	2.9						
ACPI	6.5						
SMBIOS Ver	3.6						
Fabric Interconnect	Compatible with the Cisco UCS 6454, 64108 and 6536 fabric interconnects						

CONFIGURING the Cisco UCS X215c M8 Compute Node

Follow these steps to configure the Cisco UCS X215c M8 Compute Node:

- *STEP 1 CHOOSE BASE CISCO UCS X215c M8 COMPUTE NODE SKU, page 10*
- *STEP 2 CHOOSE CPU(S), page 11*
- *STEP 3 CHOOSE MEMORY, page 14*
- *STEP 4 CHOOSE REAR mLOM ADAPTER, page 19*
- *STEP 5 CHOOSE OPTIONAL REAR MEZZANINE VIC/BRIDGE ADAPTERS, page 23*
- *STEP 6 CHOOSE OPTIONAL FRONT MEZZANINE ADAPTER, page 25*
- *STEP 7 CHOOSE OPTIONAL GPU PCIe NODE, page 26*
- *STEP 8 CHOOSE OPTIONAL GPUs, page 27*
- *STEP 9 CHOOSE OPTIONAL DRIVES, page 28*
- *STEP 10 Order Boot-optimized M.2 Front Panel Module and Drives, page 30*
- *STEP 11 ORDER NVMe BOOT (OPTIONAL), page 31*
- *STEP 12 CHOOSE OPTIONAL TRUSTED PLATFORM MODULE, page 32*
- *STEP 13 CHOOSE OPERATING SYSTEM AND VALUE-ADDED SOFTWARE, page 33*
- *STEP 14 CHOOSE OPTIONAL OPERATING SYSTEM MEDIA KIT, page 36*
- *SUPPLEMENTAL MATERIAL, page 37*

STEP 1 CHOOSE BASE CISCO UCS X215c M8 COMPUTE NODE SKU

Top Level ordering product ID (PID) of the Cisco UCS X215c M8 Compute Node as shown in [Table 2](#)

Table 2 Top level ordering PID

Product ID (PID)	Description
UCSX-M8-MLB	UCSX M8 Modular Server and Chassis MLB

Select the product ID (PID) of the Cisco UCS X215c M8 Compute Node as shown in [Table 3](#).

Table 3 PID of the Base Cisco UCS X215c M8 Compute Node

Product ID (PID)	Description
UCSX-215C-M8	Cisco UCS X215c M8 Compute Node without CPU, memory, drive bays, drives, VIC adapter, or mezzanine adapters (ordered as a UCS X9508 chassis option)
UCSX-215C-M8-U	Cisco UCS X215c M8 Compute Node without CPU, memory, drive bays, drives, VIC adapter, or mezzanine adapters (ordered standalone)

A base Cisco UCS X215c M8 Compute Node ordered in [Table 3](#) does not include any components or options. They must be selected during product ordering.

Please follow the steps on the following pages to order components such as the following, which are required in a functional compute node:

- CPUs
- Memory
- Cisco storage RAID or passthrough controller with drives (or blank, for no local drive support)
- SAS, SATA, NVMe, M.2, or U.2/U.3 drives
- Cisco adapters (such as the 15000 series VIC or Bridge)

STEP 2 CHOOSE CPU(S)

- 5th Gen. AMD EPYC™ processors highlights are:
 - CPU-to-CPU communication using Infinity Fabric Interconnect
 - Cache size of up to 512 MB
 - Up to 160 cores
 - Power: Up to 400Watts
- 4th Gen. AMD EPYC™ processors highlights are:
 - CPU-to-CPU communication using Infinity Fabric Interconnect
 - Cache size of up to 1152 MB
 - Up to 128 cores
 - Power: Up to 400Watts

Select CPUs

- The available 5th Gen. AMD EPYC™ processors are listed in [Table 4](#).
- The available 4th Gen. AMD EPYC™ processors are listed in [Table 5](#).



CAUTION: For systems configured with processors operating above 28° C [82.4° F], a fan fault or executing workloads with extensive use of heavy instructions sets may assert thermal and/or performance faults with an associated event recorded in the System Event Log (SEL).

Table 4 Available 5th Gen. AMD EPYC™ CPUs

Product ID (PID) ¹	Maximum Socket	Core	Clock Freq	Power	Cache Size	Highest DDR5 DIMM Clock Support
	(S)	(C)	(GHz)	(W)	(MB)	(MT/s) ²
5th Gen EPYC 9005 Series Processors						
UCSX-CPU-A9845 ³	2S	160	2.10	390	320	6000
UCSX-CPU-A9825 ³	2S	144	2.20	390	384	6000
UCSX-CPU-A9745 ³	2S	128	2.40	400	256	6000
UCSX-CPU-A9655	2S	96	2.60	400	384	6000
UCSX-CPU-A9645 ³	2S	96	2.30	320	256	6000
UCSX-CPU-A9565 ³	2S	72	3.15	400	384	6000
UCSX-CPU-A9555	2S	64	3.20	360	256	6000
UCSX-CPU-A9535 ³	2S	64	2.40	300	256	6000
UCSX-CPU-A9455 ³	2S	48	3.15	300	256	6000
UCSX-CPU-A9365 ³	2S	36	3.40	300	192	6000
UCSX-CPU-A9355	2S	32	3.55	280	256	6000
UCSX-CPU-A9335 ³	2S	32	3.00	210	128	6000

Table 4 Available 5th Gen. AMD EPYC™ CPUs

Product ID (PID) ¹	Maximum Socket	Core	Clock Freq	Power	Cache Size	Highest DDR5 DIMM Clock Support
	(S)	(C)	(GHz)	(W)	(MB)	(MT/s) ²
UCSX-CPU-A9255 ³	2S	24	3.25	200	128	6000
UCSX-CPU-A9135	2S	16	3.65	200	64	6000
UCSX-CPU-A9115 ³	2S	16	2.60	125	64	6000
UCSX-CPU-A9015 ³	2S	8	3.60	125	64	6000
UCSX-CPU-A9575F	2S	64	3.30	400	256	6000
UCSX-CPU-A9475F ³	2S	48	3.65	400	256	6000
UCSX-CPU-A9375F ³	2S	32	3.85	320	256	6000
UCSX-CPU-A9275F ³	2S	24	4.10	320	256	6000
UCSX-CPU-A9175F ³	2S	16	4.20	320	512	6000
UCSX-CPU-A9655P ³	1S	96	2.60	400	384	6000
UCSX-CPU-A9555P ³	1S	64	3.20	360	256	6000
UCSX-CPU-A9455P ³	1S	48	3.15	300	256	6000
UCSX-CPU-A9355P ³	1S	32	3.55	280	256	6000

Notes:

1. Any CPU PID ending in “P” cannot be used in a 2-CPU system. They can only be used in a 1-CPU system. The X215c M8 is IO optimized for 1 CPU configurations. All storage and network options can be used with one CPU. X-Fabric options for connecting to PCIe nodes require a two CPU configuration.
2. If higher or lower speed DIMMs are selected than what is shown in [Table 8 on page 16](#) for a given CPU speed, the DIMMs will be clocked at the lowest common denominator of CPU clock and DIMM clock.
3. SKU available in Q1CY25

Table 5 Available 4th Gen. AMD EPYC™ CPUs

Product ID (PID) ¹	Maximum Socket	Core	Clock Freq	Power	Cache Size	Highest DDR5 DIMM Clock Support
	(S)	(C)	(GHz)	(W)	(MB)	(MT/s) ²
4th Gen EPYC 97x4 Processors						
UCSX-CPU-A9754	2S	128	2.25	360	256	4800
UCSX-CPU-A9734	2S	112	2.20	340	256	4800
4th Gen EPYC 9004 Series Processor						
UCSX-CPU-A9654	2S	96	2.40	360	384	4800
UCSX-CPU-A9634	2S	84	2.25	290	384	4800
UCSX-CPU-A9554	2S	64	3.10	360	256	4800
UCSX-CPU-A9534	2S	64	2.45	280	256	4800
UCSX-CPU-A9454	2S	48	2.75	290	256	4800
UCSX-CPU-A9354	2S	32	3.25	280	256	4800
UCSX-CPU-A9334	2S	32	2.70	210	128	4800

Table 5 Available 4th Gen. AMD EPYC™ CPUs

Product ID (PID) ¹	Maximum Socket	Core	Clock Freq	Power	Cache Size	Highest DDR5 DIMM Clock Support
	(S)	(C)	(GHz)	(W)	(MB)	(MT/s) ²
UCSX-CPU-A9254	2S	24	2.90	200	128	4800
UCSX-CPU-A9224	2S	24	2.50	200	64	4800
UCSX-CPU-A9124	2S	16	3.00	200	64	4800
UCSX-CPU-A9474F	2S	48	3.60	360	256	4800
UCSX-CPU-A9374F	2S	32	3.85	320	256	4800
UCSX-CPU-A9274F	2S	24	4.05	320	256	4800
UCSX-CPU-A9174F	2S	16	4.10	320	256	4800
UCSX-CPU-A9654P	1S	96	2.40	360	384	4800
UCSX-CPU-A9554P	1S	64	3.10	360	256	4800
UCSX-CPU-A9454P	1S	48	2.75	290	256	4800
UCSX-CPU-A9354P	1S	32	3.25	280	256	4800
4th Gen EPYC 9004 Series with 3D V-Cache™ Technology						
UCSX-CPU-A9684X	2S	96	2.55	400	1152	4800
UCSX-CPU-A9384X	2S	32	3.10	320	768	4800
UCSX-CPU-A9184X	2S	16	3.55	320	768	4800

Notes:

- Any CPU PID ending in “P” cannot be used in a 2-CPU system. They can only be used in a 1-CPU system. The X215c M8 is IO optimized for 1 CPU configurations. All storage and network options can be used with one CPU. X-Fabric options for connecting to PCIe nodes require a two CPU configuration.
- If higher or lower speed DIMMs are selected than what is shown in [Table 7 on page 15](#) for a given CPU speed, the DIMMs will be clocked at the lowest common denominator of CPU clock and DIMM clock.

Supported Configurations**(1) Configurations with NVMe PCIe drives:**

- Select one or two identical CPUs from [Table 4 on page 11](#) or [Table 5 on page 12](#)

(2) Configurations with GPUs:

- Select one or two identical CPUs from [Table 4 on page 11](#) or [Table 5 on page 12](#)

(3) One-CPU Configuration

- Choose one CPU from any one of the rows of [Table 4 on page 11](#) or [Table 5 on page 12](#)

(4) Two-CPU Configuration

- Choose two identical CPUs from any one of the rows of [Table 4 on page 11](#) or [Table 5 on page 12](#)

STEP 3 CHOOSE MEMORY

The *Table 6* below describes the main memory DIMM features supported on Cisco UCS X215c M8 rack server.

Table 6 X215c M8 Main Memory Features

Memory DIMM server technologies	Description
DDR5 memory clock speed	4th Gen. AMD EPYC™ CPUs: Up to 4800 MT/s 1DPC
	5th Gen. AMD EPYC™ CPUs: Up to 6000 MT/s 1DPC
Operational voltage	1.1 Volts
DRAM fab density	16Gb, 24Gb, and 32Gb
DRAM DIMM type	RDIMM (Registered DDR5 DIMM)
Memory DIMM organization	Twelve memory DIMM channels per CPU; 1 DIMM per channel only
Maximum number of DRAM DIMM per server	Up to 24 (2-Socket)
DRAM DIMM Densities and Ranks	16GB 1Rx8, 32GB 1Rx4, 48GB 1Rx4, 64GB 2Rx4, 96GB 2Rx4, 128GB 4Rx4, 128GB (32Gb) 2Rx4
Maximum system capacity (DRAM DIMMs only)	6TB (24x256GB)

Figure 4 12-Channel Memory Organization

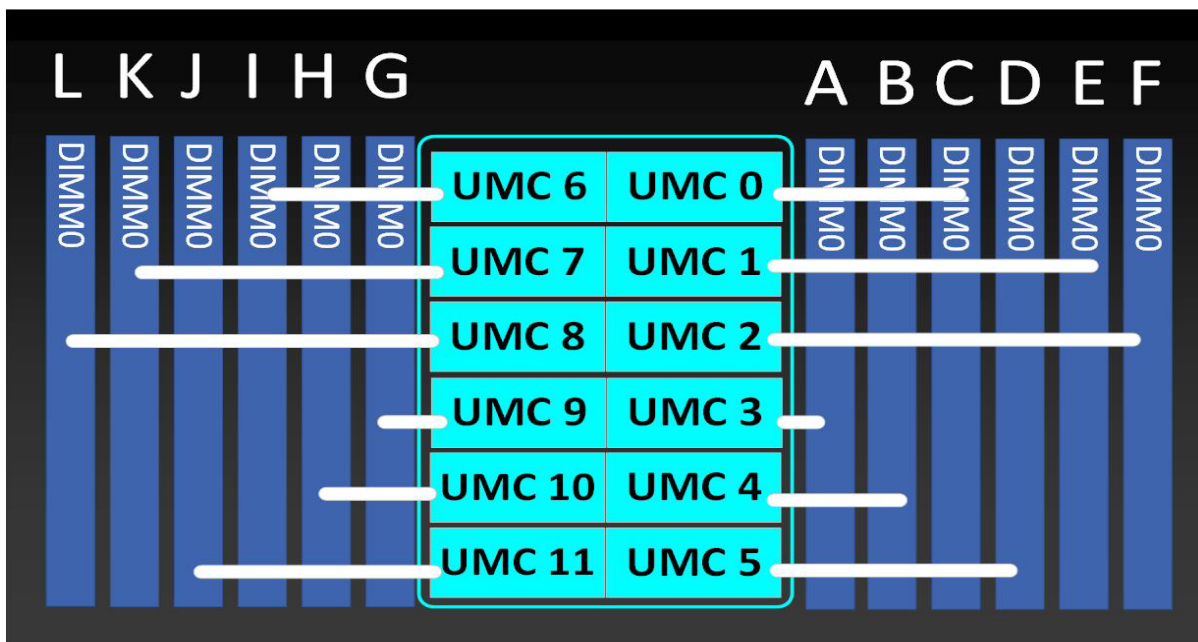

Select DIMMs

The supported memory DIMMs are listed in [Table 7](#) and [Table 8](#).



NOTE:

- When paired with 4th Gen. AMD EPYC™ CPUs, all memory DIMMs must be Cisco DDR5-5600 memory PIDs, although the memory will operate at the maximum speed of the 4th Gen. AMD EPYC™ CPUs memory controller, up to 4800 MT/s.
- When paired with 5th Gen. AMD EPYC™ CPUs, all memory DIMMs must be Cisco DDR5-6400 memory PIDs, although the memory will operate at the maximum speed of the 5th Gen. AMD EPYC™ CPUs memory controller, up to 6000 MT/s.

Table 7 Available DDR5 DIMMs for 4th Gen. AMD EPYC™ CPUs

Product ID (PID)	PID Description	Ranks/DIMM
DDR5-5600 MT/s PIDs list¹		
UCSX-MR256G8RE3 ²	256GB DDR5-5600 RDIMM 8Rx4 (16Gb)	8
UCSX-MR128G4RE3	128GB DDR5-5600 RDIMM 4Rx4 (16Gb)	4
UCSX-MR128G2RG3 ³	128GB DDR5-5600 RDIMM 2Rx4 (32Gb)	2
UCSX-MRX96G2RF3	96GB DDR5-5600 RDIMM 2Rx4 (24Gb)	2
UCSX-MRX64G2RE3	64GB DDR5-5600 RDIMM 2Rx4 (16Gb)	2
UCSX-MRX48G1RF3	48GB DDR5-5600 RDIMM 1Rx4 (24Gb)	1
UCSX-MRX32G1RE3	32GB DDR5-5600 RDIMM 1Rx4 (16Gb)	1
UCSX-MRX16G1RE3	16GB DDR5-5600 RDIMM 1Rx8 (16Gb)	1
DIMM Blank⁴		
UCSX-DIMM-BLK	UCS DIMM Blank	

Notes:

1. If higher or lower speed DIMMs are selected than for a given CPU speed, the DIMMs will be clocked at the lowest common denominator of CPU clock and DIMM clock. check the [Table 5](#) column “Highest DDR5 DIMM Clock Support”
2. Available in Q4CY24
3. Available in Q1CY25
4. Any empty DIMM slot must be populated with a DIMM blank to maintain proper cooling airflow.

Table 8 Available DDR5 DIMMs for 5th Gen. AMD EPYC™ CPUs

Product ID (PID)	PID Description	Ranks/DIMM
DDR5-6400 MT/s PIDs list^{1,2}		
UCSX-MRX64G2RE5	64GB DDR5-6400 RDIMM 2Rx4 (16Gb)	2
UCSX-MRX32G1RE5	32GB DDR5-6400 RDIMM 1Rx4 (16Gb)	1
DIMM Blank³		
UCSX-DIMM-BLK	UCS DIMM Blank	

Notes:

1. If higher or lower speed DIMMs are selected than for a given CPU speed, the DIMMs will be clocked at the lowest common denominator of CPU clock and DIMM clock. check the [Table 4](#) column “Highest DDR5 DIMM Clock Support”
2. DDR5-6400 16GB, 48GB, 96GB, 128GB, 256GB will be available in Q1CY25
3. Any empty DIMM slot must be populated with a DIMM blank to maintain proper cooling airflow.

Memory configurations and mixing rules



GOLDEN RULE: Memory on every CPU socket shall be configured identically. Therefore, the memory configuration of CPU-1 will be identical to CPU-2 for a 2-Socket system. Unbalanced populations are unsupported.

- System speed is dependent on the CPU DIMM speed support. Refer to [Available 4th Gen. AMD EPYC™ CPUs on page 12](#) for DIMM speeds.
- For full details on supported memory configurations see the [M8 Memory Guide](#).
- DIMM Count Rules:

Table 9 Allowed DIMM Count for 1-CPU and 2-CPU

Allowed DIMM Count rules	Minimum Count	Maximum Count	Allowed Count	Not Allowed Count
16GB, 32GB, 48GB, 64GB, 96GB, 128GB, 256GB (4th and 5th Gen. AMD EPYC™ CPUs)¹				
DIMM count for 1 CPU	1	12	1,2,4,6,8,10,12	3,5,7,9,11
DIMM count for 2-CPU	2	24	2,4,8,12,16,20,24	6,10,14,18, 22

Notes:

1. 1DPC support only.

- DIMM Population Rules:
 - When populating memory on a server powered by one or more 4th Gen. AMD EPYC™ CPUs:
 - All memory DIMMs must be RDIMM (16GB, 32GB, 48GB, 64GB, 96GB, and 128GB) or RDIMM 3DS (128GB, and 256GB) module types.
 - When paired with 4th Gen. AMD EPYC™ CPUs, all memory DIMMs must be Cisco DDR5-5600 memory PIDs, although the memory will operate at the maximum speed of the 4th Gen. AMD EPYC™ CPUs memory controller, up to 4800 MT/s.
 - When paired with 5th Gen. AMD EPYC™ CPUs, all memory DIMMs must be Cisco DDR5-6400 memory PIDs, although the memory will operate at the maximum speed of the 5th Gen. AMD EPYC™ CPUs memory controller, up to 6000 MT/s.
 - Balanced memory configurations maximize memory bandwidth by optimizing memory interleaving. To obtain a balanced memory configuration:
 - Populate each socket with 1, 2, 4, 6, 8, 10, or 12 memory channels.
 - Use the same memory configuration in all populated memory channels. No DIMM density mixing across channel is allowed.
 - Use the same DIMM configuration for each processor socket, on a 2-socket configuration.
 - No DIMM mixing within a channel is possible as X215c server supports only 1DPC.

Table 10 M8 DIMM population order for 16GB, 32GB, 48GB, 64GB, 96GB, 128GB, 256GB

#DIMMs per CPU	DIMM Population - 16GB, 32GB, 48GB, 64GB, 128GB, 256GB ¹
	Slot 1 (Blue)
1	A1
2	A1, G1
4	A1, C1, G1, I1
6	A1, B1, C1, G1, H1, I1
8	A1, B1, C1, E1, G1, H1, I1, K1
10	A1, B1, C1, D1, E1, G1, H1, I1, J1, K1
12	A1, B1, C1, D1, E1, F1, G1, H1, I1, J1, K1, L1

Notes:

1. 1DPC support only.

- Memory Limitations:
 - Memory on every CPU socket shall be configured identically.
 - Refer to [Table 10](#) for DIMM population and DIMM mixing rules.
 - Cisco Memory DIMM PIDs used on M8 X215c server models powered by 4th Gen. AMD EPYC™ CPUs are DDR5-5600 PIDs, although the memory will operate at the maximum speed of the 4th Gen. AMD EPYC™ CPUs memory controller, up to 4800 MT/s. Check [Table 11](#) for CPU SKUs definition and maximum memory speed.
 - Cisco Memory DIMM PIDs used on M8 X215c server models powered by 5th Gen. AMD EPYC™ CPUs are DDR5-6400 PIDs, although the memory will operate at the maximum speed of the 5th Gen. AMD EPYC™ CPUs memory controller, up to 6000 MT/s. Check [Table 12](#) for CPU SKUs definition and maximum memory speed.

- For best performance, observe the following:

Table 11 Maximum Memory Operating Frequency - 4th Gen. AMD EPYC™ CPUs - 1 DIMM Per Channel only

4th Gen. CPU Memory Speed	DIMM Rank	DIMM Max operating Speed
RDIMM	One Rank, two Rank, four Rank, eight Rank	4800 MT/s

Table 12 Memory Maximum Operating Frequency - 5th Gen. AMD EPYC™ CPUs - 1 DIMM Per Channel only

5th Gen. CPU Memory Speed	DIMM Rank	DIMM Max operating Speed
RDIMM	One Rank, two Rank, four Rank	6000 MT/s



NOTE: For full details on supported memory configurations see the [M8 Memory guide](#)

STEP 4 CHOOSE REAR mLOM ADAPTER

The Cisco UCS X215c M8 Compute Node must be ordered with a Cisco VIC mLOM Adapter. The adapter is located at the back and can operate in a single-CPU or dual-CPU configuration.

[Table 13](#) shows the mLOM adapter choices.

Table 13 mLOM Adapters

Product ID (PID)	Description	Connection type
UCSX-MLV5D200GV2D	Cisco UCS VIC 15230 modular LOM w/Secure Boot X Compute Node	mLOM
UCSX-ML-V5Q50G-D	UCS VIC 15420 4x25G secure boot mLOM for X Compute Node	mLOM



NOTE:

- VIC 15420 are supported with both X9108-IFM-25G and X9108-IFM-100G. VIC 15420 will operate at 4x 25G with both X9108-IFM-25G and X9108-IFM-100G. While, VIC 15230 will operate at 4x 25G with X9108-IFM-25G and at 2x 100G with X9108-IFM-100G.
- There is no backplane in the Cisco UCS X9508 chassis; thus, the compute nodes directly connect to the IFMs using Orthogonal Direct connectors.
- [Figure 5](#) shows the location of the mLOM and rear mezzanine adapters on the Cisco UCS X215c M8 Compute Node. The bridge adapter connects the mLOM adapter to the rear mezzanine adapter.

Figure 5 Location of mLOM and Rear Mezzanine Adapters

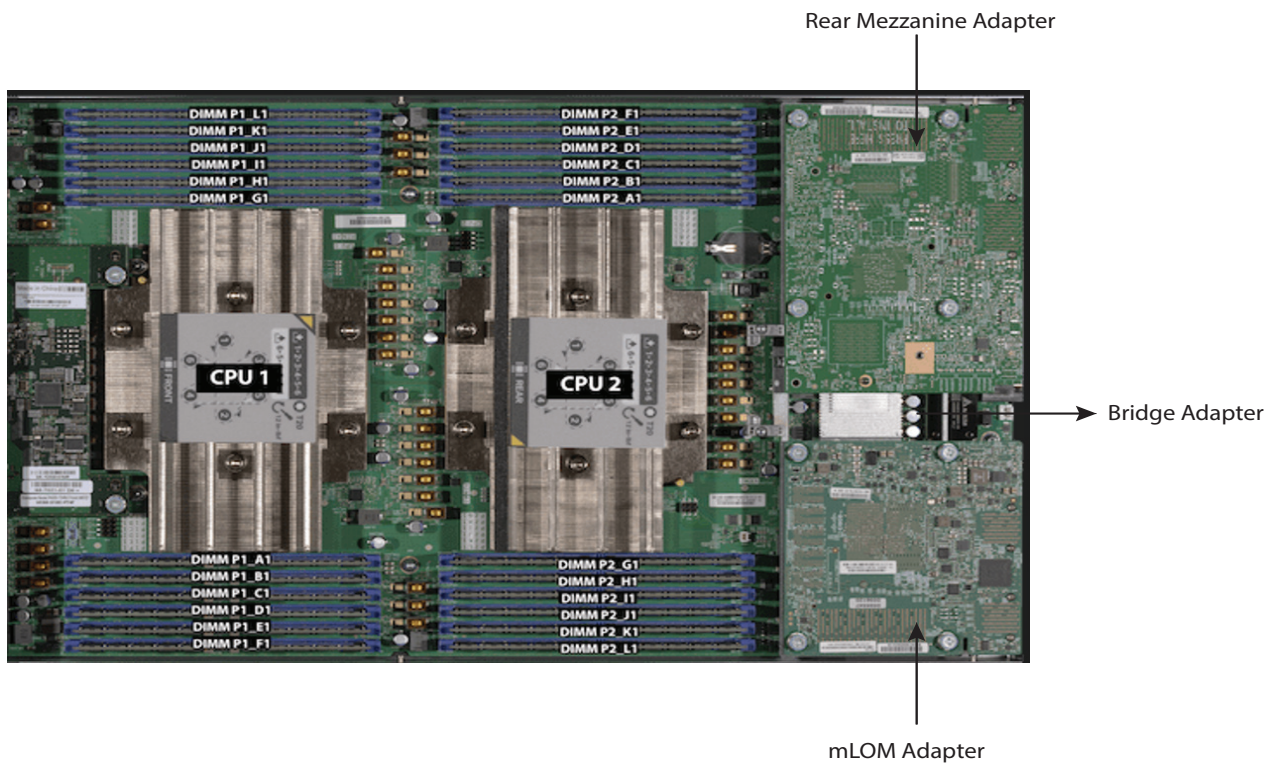

Figure 6 shows the network connectivity from the mLOM out to the 25G IFMs.

Figure 6 Network Connectivity 25G IFMs

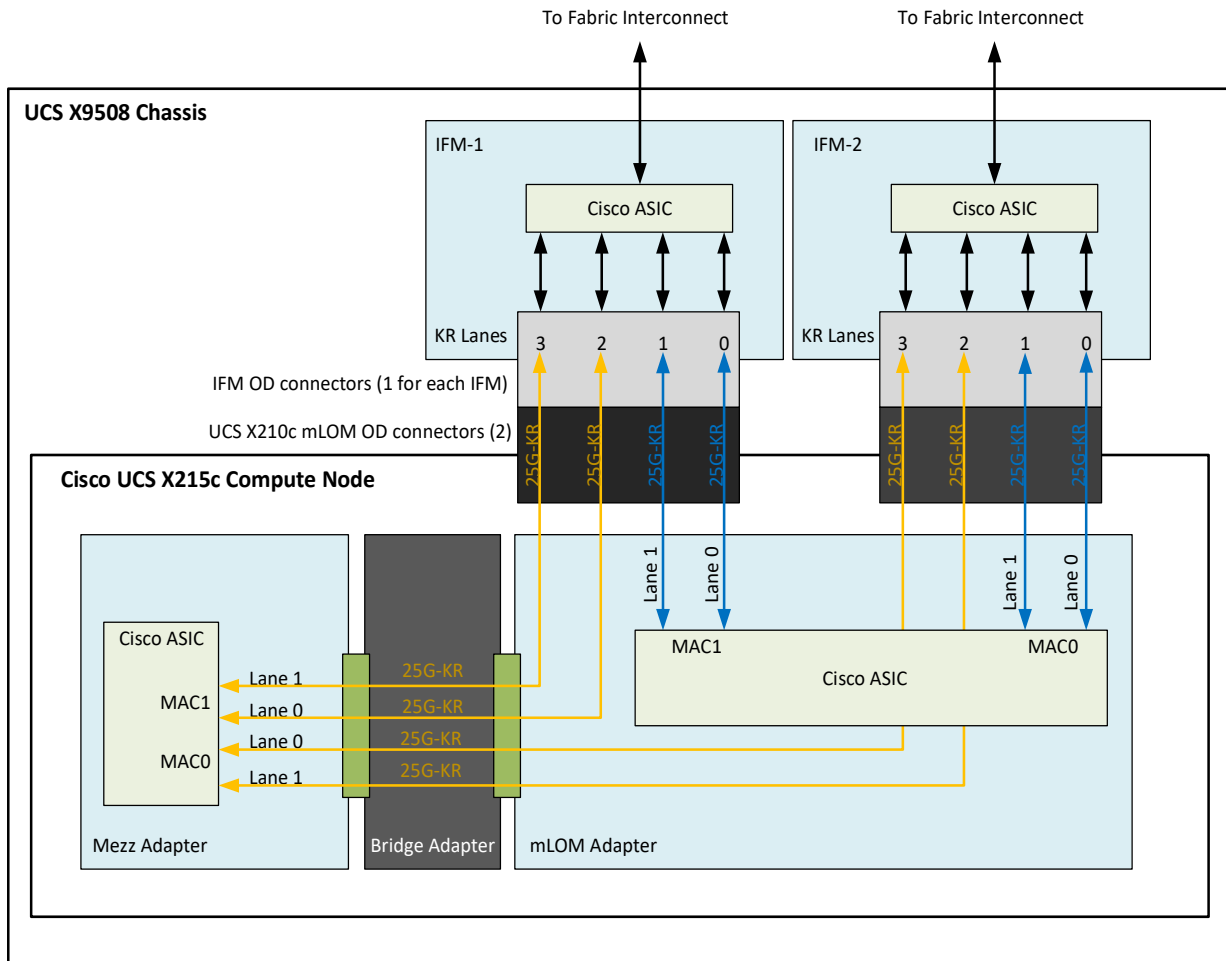
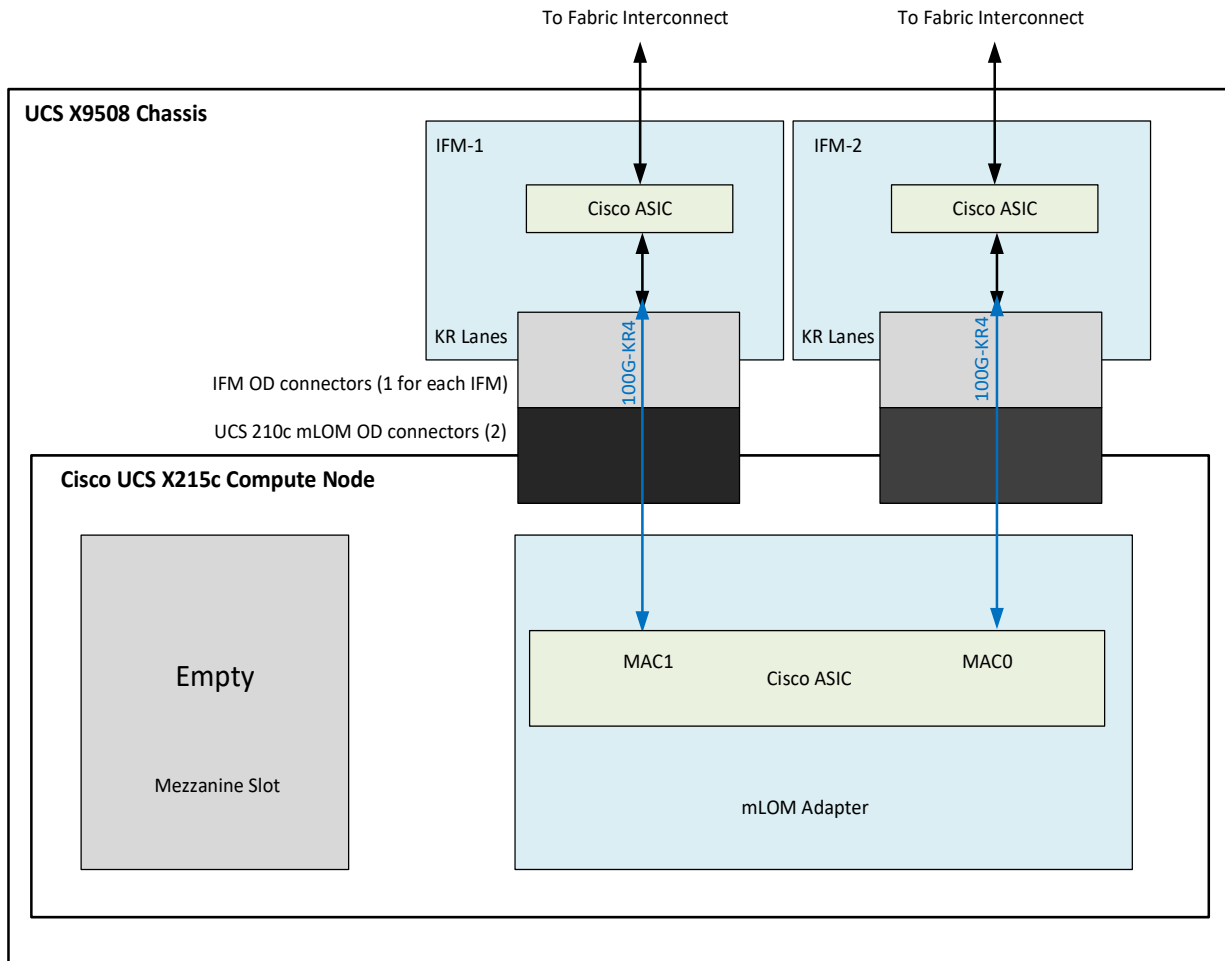

Figure 7 shows the network connectivity from the mLOM out to the 100G IFMs.

Figure 7 Network Connectivity 100G IFMs



STEP 5 CHOOSE OPTIONAL REAR MEZZANINE VIC/BRIDGE ADAPTERS

The Cisco UCS X215c M8 Compute Node has one rear mezzanine adapter connector which can have a UCS VIC 15422 Mezz card that can be used as a second VIC card on the compute node for network connectivity or as a connector to the X440p PCIe node via X-Fabric modules. The same mezzanine slot on the compute node can also accommodate a pass-through mezzanine adapter for X-Fabric which enables compute node connectivity to the X440p PCIe node. Refer to [Table 14](#) for supported adapters.

Table 14 Available Rear Mezzanine Adapters

Product ID(PID)	PID Description	CPUs Required	Connector Type
Cisco VIC Card			
UCSX-V4-PCIME-D ¹	UCS PCIe Mezz Card for X-Fabric	2 CPUs required	Rear Mezzanine connector on motherboard
UCSX-ME-V5Q50G-D ²	UCS VIC 15422 4x25G secure boot mezz for X Compute Node	2 CPUs required	Rear Mezzanine connector on motherboard
Cisco VIC Bridge Card³			
UCSX-V5-BRIDGE-D	UCS VIC 15000 bridge to connect mLOM and mezz X Compute Node (This bridge to connect the Cisco VIC 15420 mLOM and Cisco VIC 15422 Mezz for the X215c M8 Compute Node)		One connector on Mezz card and one connector on mLOM card

Notes:

1. If this adapter is selected, then two CPUs are required.
2. UCSX-ME-V5Q50G-D only requires 2 CPUs if being used with a PCIe node.
3. Included with the Cisco VIC 15422 mezzanine adapter.



NOTE: The UCSX-V4-PCIME-D rear mezzanine card for X-Fabric has PCIe Gen4 x16 connectivity towards each CPU1 and CPU2. Additionally, the UCSX-V4-PCIME-D also provides two PCIe Gen4 x16 to each X-fabric. This rear mezzanine card enables connectivity from the X215c M8 Compute Node to the X440p PCIe node.

Table 15 Throughput Per UCS X215c M8 Server

X215c M8 Compute Node	FI-6536 + X9108-IFM-100G	FI-6536/6400 + X9108-IFM-25G	FI-6536 + X9108-IFM-25G/100G or FI-6400 + X9108-IFM-25G	FI-6536 + X9108-IFM-25G/100G or FI-6400 + X9108-IFM-25G	
X215c configuration	VIC 15230	VIC 15230	VIC 15420	VIC 15420 + VIC 15422	
Throughput per node	200G (100G per IFM)	100G (50G per IFM)	100G (50G per IFM)	200G (100G per IFM)	
vNICs needed for max BW	2	2	2	4	
KR connectivity from VIC to each IFM	1x 100GKR	2x 25GKR	2x 25GKR	4x 25GKR	
Single vNIC throughput on VIC	100G (1x100GKR)	50G (2x25G KR)	50G (2x25G KR)	50G (2x25G KR)	50G (2x25G KR)
Max Single flow BW per vNIC	100G	25G	25G	25G	25G
Single vHBA throughput on VIC	100G	50G	50G	50G	50G

Supported Configurations

- One of mLOM VIC from [Table 13](#) is always required.
- If a UCSX-ME-V5Q50G-D rear mezzanine VIC card is installed, a UCSX-V5-BRIDGE-D VIC bridge card is included and connects the mLOM to the mezzanine adapter.
- All the connections to Cisco UCS X-Fabric 1 and Cisco UCS X-Fabric 2 are through the Molex Orthogonal Direct (OD) connector on the mezzanine card.

STEP 6 CHOOSE OPTIONAL FRONT MEZZANINE ADAPTER

The Cisco UCS X215c M8 Compute Node has one front mezzanine connector that can accommodate one of the following mezzanine cards:

- Pass-through controller for up to 6 U.2/U.3 NVMe drives
- RAID controller (RAID levels 0, 1, 5, 6, 10, and 50) for 6 SAS/SATA/U.2/U.3 NVMe drives or up to 4 SAS/SATA/U.2/U.3 NVMe (drive slots 5-6)
- GPU Front Mezz to Support up to 2 U.2/U.3 NVMe drives and 2 NVIDIA T4 GPUs.



NOTE:

- The Cisco UCS X215c M8 Compute Node can be ordered with or without the front mezzanine adapter. Refer to [Table 16 Available Front Mezzanine Adapters](#)
- Only one Front Mezzanine connector or Front GPU can be selected per Server.
- RAID with NVMe drives is only supported with the NVMe U.2/U.3 drives as they connect to the RAID controller and RAID is not supported with the NVME drives as they directly interface with the server via the PCIe bus.

Table 16 Available Front Mezzanine Adapters

Product ID(PID)	PID Description	Connector Type
UCSX-X10C-PT4F-D	Cisco UCS X215c M8 Compute Node compute pass through controller for up to 6 NVMe drives	Front Mezzanine
UCSX-X10C-RAIDF-D	Cisco UCS X215c M8 Compute Node RAID controller w/4GB Cache, with LSI 3900 for up to 6 SAS/SATA/NVMe drives (SAS/SATA and NVMe drives can be mixed)	Front Mezzanine
UCSX-X10C-GPUFM-D	UCS X10c Compute Node GPU Front Mezz	Front Mezzanine

STEP 7 CHOOSE OPTIONAL GPU PCIe NODE

Refer to [Table 17](#) for GPU PCIe Node

Table 17 GPU PCIe Node

Product ID(PID)	PID Description
UCSX-440P-D	UCS X-Series Gen4 PCIe node



NOTE:

- If UCSX-440P-D is selected, then rear mezzanine is required.
-

STEP 8 CHOOSE OPTIONAL GPUS

Select GPU Options

The available Compute node GPU options are listed in [Table 18](#)

Table 18 Available PCIe GPU Card supported on the Compute Node Front Mezz

GPU Product ID (PID)	PID Description
UCSX-GPU-L4-MEZZ	NVIDIA GPU L4, Gen4x16, 1 Slot, HHHH, 70W 24GB, PCIe

The available PCIe node GPU options are listed in [Table 19](#).

Table 19 Available PCIe GPU Cards supported on the PCIe Node

GPU Product ID (PID)	PID Description	Maximum number of GPUs per node
UCSX-GPU-A16-D	NVIDIA A16 PCIE 250W 4X16GB	2
UCSX-GPU-L4	NVIDIA L4 Tensor Core, 70W, 24GB	4
UCSX-GPU-L40S	NVIDIA L40S: 350W, 48GB, 2-slot FHFL GPU	2
UCSX-GPU-H100-NVL	NVIDIA H100 NVL, 400W, 94GB, 2-slot FHFL GPU	2

STEP 9 CHOOSE OPTIONAL DRIVES

The Cisco UCS X215c M8 Compute Node can be ordered with or without drives. The drive options are:

- One to six 2.5-inch small form factor SAS/SATA SSDs or PCIe U.2/U.3 NVMe drives
 - Hot-pluggable
 - Sled-mounted

Select one or two drives from the list of supported drives available in [Table 20](#).

Table 20 Available Drive Options

Product ID (PID)	Description	Drive Type	Speed	Size
SAS/SATA SSDs^{1,2,3}				
Self-Encrypted Drives (SED)				
UCSX-SD16TBKANK9D	1.6TB 2.5in Enter Perf 24G SAS Kioxia PM7 SSD (3X SED-FIPS)	SAS	12G	1.6TB
UCSX-SD38TBKANK9D	3.8TB 2.5in Enter Value 24G SAS Kioxia PM7 SSD (SED-FIPS)	SAS	12G	3.8TB
UCSX-SD38TBKANK9D	3.8TB Enterprise Value SAS SSD (1X FWPD, SED)	SAS	12G	3.8TB
UCSX-SD960GM2NK9D	960GB 2.5in Enter Value 6G SATA Micron G2 SSD (SED)	SATA	6G	960GB
UCSX-SD19TEM2NK9D	1.9TB 2.5in Enter Value 6G SATA Micron G2 SSD (SED)	SATA	6G	1.6TB
UCSX-SD38TEM2NK9D	3.8TB 2.5in Enter Value 6G SATA Micron G2 SSD (SED)	SATA	6G	3.8TB
UCSX-SD76TEM2NK9D	7.6TB 2.5in Enter Value 6G SATA Micron G2 SSD (SED)	SATA	6G	7.6TB
Enterprise Performance SSDs (high endurance, supports up to 3X DWPD (drive writes per day))				
UCSX-SD16TKA3XEPD	1.6TB 2.5in Enter Perf 24G SAS Kioxia PM7 SSD (3X)	SAS	12G	1.6TB
UCSXSD32TKA3XEP-D	3.2TB 2.5in Enter Perf 24G SAS Kioxia PM7 SSD (3X)	SAS	12G	3.2TB
UCSX-SD19T63XEP-D	1.9TB 2.5 inch Enterprise performance 6G SATA SSD (3X endurance)	SATA	6G	1.9TB
UCSXSD480G63XEP-D	480GB 2.5in Enterprise performance 6G SATA SSD (3X endurance)	SATA	6G	480GB
UCSXSD960G63XEP-D	960GB 2.5 inch Enterprise performance 6G SATA SSD (3X endurance)	SATA	6G	960GB
UCSX-SD38T63XEP-D	3.8TB 2.5 in Enterprise performance 6G SATA SSD (3X endurance)	SATA	6G	3.8TB
UCSX-SD19TBM3XEPD	1.9TB 2.5in Enter Perf 6G SATA Micron G2 SSD (3X)	SATA	6G	1.9TB
UCSXSD480GBM3XEPD	480GB 2.5in Enter Perf 6G SATA Micron G2 SSD (3X)	SATA	6G	480GB
UCSXSD960GBM3XEPD	960GB 2.5in Enter Perf 6G SATA Micron G2 SSD (3X)	SATA	6G	960GB
Enterprise Value SSDs (Low endurance, supports up to 1X DWPD (drive writes per day))				
UCSXSD38T611XEVD	3.8TB 2.5 inch Enterprise Value 6G SATA SSD	SATA	6G	3.8TB
UCSXSD240GBM1XEVD	240GB 2.5in Enter Value 6G SATA Micron G2 SSD	SATA	6G	240GB
UCSXSD480GBM1XEVD	480 GB 2.5in Enter Value 6G SATA Micron G2 SSD	SATA	6G	480GB
UCSX-SD19TBM1XEVD	1.9TB 2.5in Enter Value 6G SATA Micron G2 SSD	SATA	6G	1.9TB
UCSX-SDB960SA1VD	960GB 2.5in 6G SATA Enter Value 1X Samsung G1PM893A SSD	SATA	6G	960GB

Table 20 Available Drive Options (*continued*)

Product ID (PID)	Description	Drive Type	Speed	Size
UCSX-SDB1T9SA1VD	1.9TB 2.5in 6G SATA Enter Value 1X Samsung G1PM893A SSD	SATA	6G	1.9TB
UCSX-SDB3T8SA1VD	3.8TB 2.5in 6G SATA Enter Value 1X Samsung G1PM893A SSD	SATA	6G	3.8TB
UCSX-SDB7T6SA1VD	7.6TB 2.5in 6G SATA Enter Value 1X Samsung G1PM893A SSD	SATA	6G	7.6TB
UCSXSD38TKA1XEVD	3.8TB 2.5in Enter Value 24G SAS Kioxia PM7 SSD	SAS	12G	3.8TB
UCSX-SD15TKA1XEVD	15.3TB 2.5in Enter Value 24G SAS Kioxia PM7 SSD	SAS	12G	15.3TB
UCSX-SD19TKA1XEVD	1.9TB 2.5in Enter Value 24G SAS Kioxia PM7 SSD	SAS	12G	1.9TB
UCSX-SD38TBM1XEVD	3.8TB 2.5in Enter Value 6G SATA Micron G2 SSD	SATA	6G	3.8TB
UCSX-SD76TBM1XEVD	7.6TB 2.5in Enter Value 6G SATA Micron G2 SSD	SATA	6G	7.6TB
UCSXSD960GBM1XEVD	960GB 2.5in Enter Value 6G SATA Micron G2 SSD	SATA	6G	960GB
NVMe^{4, 5,6}				
UCSX-NVMEG4M1536D	15.3TB 2.5in U.3 Micron 7450 NVMe High Perf Medium Endurance	NVMe	U.3	15.3TB
UCSX-NVMEG4M1600D	1.6TB 2.5in U.3 Micron 7450 NVMe High Perf High Endurance	NVMe	U.3	1.6TB
UCSX-NVMEG4M1920D	1.9TB 2.5in U.3 Micron 7450 NVMe High Perf Medium Endurance	NVMe	U.3	1.9TB
UCSX-NVMEG4M3200D	3.2TB 2.5in U.3 Micron 7450 NVMe High Perf High Endurance	NVMe	U.3	3.2TB
UCSX-NVMEG4M3840D	3.8TB 2.5in U.3 Micron 7450 NVMe High Perf Medium Endurance	NVMe	U.3	3.8TB
UCSX-NVMEG4M6400D	6.4TB 2.5in U.3 Micron 7450 NVMe High Perf High Endurance	NVMe	U.3	6.4TB
UCSX-NVMEG4M7680D	7.6TB 2.5in U.3 Micron 7450 NVMe High Perf Medium Endurance	NVMe	U.3	7.6TB
UCSX-NVMEG4-M960D	960GB 2.5in U.3 Micron 7450 NVMe High Perf Medium Endurance	NVMe	U.3	960GB
NOTE: Cisco uses solid state drives from several vendors. All solid state drives are subject to physical write limits and have varying maximum usage limitation specifications set by the manufacturer. Cisco will not replace any solid state drives that have exceeded any maximum usage specifications set by Cisco or the manufacturer, as determined solely by Cisco.				

Notes:

1. SSD drives require the **UCSX-X10C-RAIDF-D** front mezzanine adapter
2. For SSD drives to be in a RAID group, two identical SSDs must be used in the group.
3. If SSDs are in JBOD Mode, the drives do not need to be identical.
4. NVMe drives require a front mezzanine the UCSX-X10C-PT4F-D pass through controller or UCSX-X10C-RAIDF-D RAID controller for RAID support
5. A maximum of 6x NVMe drives can be ordered with RAID controller.
6. A maximum of 2x NVMe drives can be ordered with Front Mezzanine GPU module.

STEP 10 Order Boot-optimized M.2 Front Panel Module and Drives

- **Cisco 6GB/s SATA Boot-Optimized M.2 RAID Controller (included):** Boot-Optimized RAID controller (UCSX-M2-HWRD-FPS) for hardware RAID across two SATA M.2 storage modules. The Boot-Optimized RAID controller plugs into the motherboard and the M.2 SATA drives plug into the Boot-Optimized RAID controller.



NOTE:

- The UCSX-M2-HWRD-FPS is auto included with the server configuration
- The UCSX-M2-HWRD-FPS controller supports RAID 1 and JBOD mode and is available only with 240GB, 480GB, and 960GB M.2 SATA SSDs.
- Cisco IMM is supported for configuring of volumes and monitoring of the controller and installed SATA M.2 drives
- Hot-plug replacement is not supported. The compute node must be powered off to replace.
- The Boot-Optimized RAID controller supports VMware, Windows, and Linux Operating Systems

Table 21 Boot-Optimized RAID controller (auto included)

Product ID (PID)	PID Description
UCSX-M2-HWRD-FPS	UCSX Front panel with M.2 RAID controller for SATA drives

- **Select Cisco M.2 SATA SSDs:** Order one or two matching M.2 SATA SSDs. This connector accepts the boot-optimized RAID controller (see [Table 21](#)). Each boot-optimized RAID controller can accommodate up to two SATA M.2 SSDs shown in [Table 22](#).



NOTE:

- Each boot-optimized RAID controller can accommodate up to two SATA M.2 SSDs shown in [Table 22](#). The boot-optimized RAID controller plugs into the motherboard.
- It is recommended that M.2 SATA SSDs be used as boot-only devices.
- The SATA M.2 drives can boot in UEFI mode only. Legacy boot mode is not supported.

Table 22 M.2 SATA SSDs

Product ID (PID)	PID Description
UCSX-M2-240G-D	240GB 2.5in M.2 SATA Micron G2 SSD
UCSX-M2-480G-D	480GB 2.5in M.2 SATA Micron G2 SSD
UCSX-M2-960G-D	960GB 2.5in M.2 SATA Micron G2 SSD
UCSX-M2-I240GB-D	240GB SATA M.2 SSD
UCSX-M2-I480GB-D	480GB SATA M.2 SSD

STEP 11 ORDER NVMe BOOT (OPTIONAL)

Table 23 NVMe BOOT

Product ID (PID)	PID Description
UCSX-M2-PT-FPN	UCSX Front Panel w/M.2 Pass Through Controller for NVMe Drv

Table 24 M.2 NVMe

Product ID (PID)	PID Description
UCSX-NVM2-400GB	400GB M.2 Boot NVMe
UCSX-NVM2-960GB	960GB M.2 Boot NVMe

STEP 12 CHOOSE OPTIONAL TRUSTED PLATFORM MODULE

Trusted Platform Module (TPM) is a computer chip or microcontroller that can securely store artifacts used to authenticate the platform or Cisco UCS X215c M8 Compute Node. These artifacts can include passwords, certificates, or encryption keys. A TPM can also be used to store platform measurements that help ensure that the platform remains trustworthy. Authentication (ensuring that the platform can prove that it is what it claims to be) and attestation (a process helping to prove that a platform is trustworthy and has not been breached) are necessary steps to ensure safer computing in all environments.

Table 25 Available TPM Option

Product ID (PID)	Description
UCSX-TPM2-002D-D	TPM 2.0 FIPS 140-2 MSW2022 compliant AMD M8 servers
UCSX-TPM-OPT-OUT-D ¹	OPT OUT, TPM 2.0, TCG, FIPS140-2, CC EAL4+ Certified

Notes:

1. Please note Microsoft certification requires a TPM 2.0 for bare-metal or guest VM deployments. Opt-out of the TPM 2.0 voids the Microsoft certification.



NOTE:

- The TPM module used in this system conforms to TPM v2.0 as defined by the Trusted Computing Group (TCG).
- TPM installation is supported after-factory. However, a TPM installs with a one-way screw and cannot be replaced, upgraded, or moved to another compute node. If a Cisco UCS X215c M8 Compute Node with a TPM is returned, the replacement Cisco UCS X215c M8 Compute Node must be ordered with a new TPM. If there is no existing TPM in the Cisco UCS X215c M8 Compute Node, you can install a TPM 2.0. Refer to the following document for Installation location and instructions:

https://www.cisco.com/content/en/us/td/docs/unified_computing/ucs/x/hw/210c-m6/install/b-cisco-ucs-X215c-m7-install.html

STEP 13 CHOOSE OPERATING SYSTEM AND VALUE-ADDED SOFTWARE

- Operating System ([Table 26](#))



NOTE:

- See this link for operating system guidance:
<https://ucshcltool.cloudapps.cisco.com/public/>

Table 26 Operating System

Product ID (PID)	PID Description
Microsoft Windows Server	
MSWS-22-ST16CD	Windows Server 2022 Standard (16 Cores/2 VMs)
MSWS-22-ST16CD-NS	Windows Server 2022 Standard (16 Cores/2 VMs) - No Cisco SVC
MSWS-22-DC16CD	Windows Server 2022 Data Center (16 Cores/Unlimited VMs)
MSWS-22-DC16CD-NS	Windows Server 2022 DC (16 Cores/Unlim VMs) - No Cisco SVC
MSWS-19-ST16CD	Windows Server 2019 Standard (16 Cores/2 VMs)
MSWS-19-ST16CD-NS	Windows Server 2019 Standard (16 Cores/2 VMs) - No Cisco SVC
MSWS-19-DC16CD	Windows Server 2019 Data Center (16 Cores/Unlimited VMs)
MSWS-19-DC16CD-NS	Windows Server 2019 DC (16 Cores/Unlim VMs) - No Cisco SVC
Red Hat	
RHEL-2S2V-D1A	Red Hat Enterprise Linux (1-2 CPU,1-2 VN); 1-Yr Support Req
RHEL-2S2V-D3A	Red Hat Enterprise Linux (1-2 CPU,1-2 VN); 3-Yr Support Req
RHEL-2S2V-D5A	Red Hat Enterprise Linux (1-2 CPU,1-2 VN); 5-Yr Support Req
RHEL-VDC-2SUV-D1A	RHEL for Virt Datacenters (1-2 CPU, Unlim VN) 1 Yr Supp Req
RHEL-VDC-2SUV-D3A	RHEL for Virt Datacenters (1-2 CPU, Unlim VN) 3 Yr Supp Req
RHEL-VDC-2SUV-D5A	RHEL for Virt Datacenters (1-2 CPU, Unlim VN) 5 Yr Supp Req
Red Hat Ent Linux/ High Avail/ Res Strg/ Scal	
RHEL-2S2V-D1S	Red Hat Enterprise Linux (1-2 CPU,1-2 VN); Prem 1Yr SnS Reqd
RHEL-2S2V-D3S	Red Hat Enterprise Linux (1-2 CPU,1-2 VN); Prem 3Yr SnS Reqd
RHEL-2S-HA-D1S	RHEL High Availability (1-2 CPU); Premium 1-yr SnS Reqd
RHEL-2S-HA-D3S	RHEL High Availability (1-2 CPU); Premium 3-yr SnS Reqd
RHEL-2S-RS-D1S	RHEL Resilent Storage (1-2 CPU); Premium 1-yr SnS Reqd
RHEL-2S-RS-D3S	RHEL Resilent Storage (1-2 CPU); Premium 3-yr SnS Reqd

Table 26 Operating System (continued)

Product ID (PID)	PID Description
RHEL-VDC-2SUV-D1S	RHEL for Virt Datacenters (1-2 CPU, Unlim VN) 1 Yr SnS Reqd
RHEL-VDC-2SUV-D3S	RHEL for Virt Datacenters (1-2 CPU, Unlim VN) 3 Yr SnS Reqd
Red Hat SAP	
RHEL-SAP-2S2V-D1S	RHEL for SAP Apps (1-2 CPU, 1-2 VN); Prem 1-Yr SnS Reqd
RHEL-SAP-2S2V-D3S	RHEL for SAP Apps (1-2 CPU, 1-2 VN); Prem 3-Yr SnS Reqd
RHEL-SAPSP-D3S	RHEL SAP Solutions Premium - 3 Years
RHEL-SAPSS-D3S	RHEL SAP Solutions Standard - 3 Years
SUSE	
SLES-2S2V-D1A	SUSE Linux Enterprise Svr (1-2 CPU,1-2 VM); 1-Yr Support Req
SLES-2S2V-D3A	SUSE Linux Enterprise Svr (1-2 CPU,1-2 VM); 3-Yr Support Req
SLES-2S2V-D5A	SUSE Linux Enterprise Svr (1-2 CPU,1-2 VM); 5-Yr Support Req
SLES-2SUVM-D1A	SUSE Linux Enterprise Svr (1-2 CPU,Unl VM) LP; 1Y Supp Req
SLES-2SUVM-D3A	SUSE Linux Enterprise Svr (1-2 CPU,Unl VM) LP; 3Y Supp Req
SLES-2SUVM-D5A	SUSE Linux Enterprise Svr (1-2 CPU,Unl VM) LP; 5Y Supp Req
SLES-2S-LP-D1A	SUSE Linux Live Patching Add-on (1-2 CPU); 1yr Support Req
SLES-2S-LP-D3A	SUSE Linux Live Patching Add-on (1-2 CPU); 3yr Support Req
SLES-2S2V-D1S	SUSE Linux Enterprise Svr (1-2 CPU,1-2 VM); Prio 1-Yr SnS
SLES-2S2V-D3S	SUSE Linux Enterprise Svr (1-2 CPU,1-2 VM); Prio 3-Yr SnS
SLES-2S2V-D5S	SUSE Linux Enterprise Svr (1-2 CPU,1-2 VM); Prio 5-Yr SnS
SLES-2SUVM-D1S	SUSE Linux Enterprise Svr (1-2 CPU,Unl VM) LP; Prio 1Y SnS
SLES-2SUVM-D3S	SUSE Linux Enterprise Svr (1-2 CPU,Unl VM) LP; Prio 3Y SnS
SLES-2SUVM-D5S	SUSE Linux Enterprise Svr (1-2 CPU,Unl VM) LP; Prio 5Y SnS
SLES-2S-HA-D1S	SUSE Linux High Availability Ext (1-2 CPU); 1yr SnS
SLES-2S-HA-D3S	SUSE Linux High Availability Ext (1-2 CPU); 3yr SnS
SLES-2S-HA-D5S	SUSE Linux High Availability Ext (1-2 CPU); 5yr SnS
SLES-2S-GC-D1S	SUSE Linux GEO Clustering for HA (1-2 CPU); 1yr Sns
SLES-2S-GC-D3S	SUSE Linux GEO Clustering for HA (1-2 CPU); 3yr SnS
SLES-2S-GC-D5S	SUSE Linux GEO Clustering for HA (1-2 CPU); 5yr SnS
SLES-2S-LP-D1S	SUSE Linux Live Patching Add-on (1-2 CPU); 1yr SnS Required

Table 26 Operating System (*continued*)

Product ID (PID)	PID Description
SLES-2S-LP-D3S	SUSE Linux Live Patching Add-on (1-2 CPU); 3yr SnS Required
SLES and SAP	
SLES-SAP-2S2V-D1S	SLES for SAP Apps (1-2 CPU, 1-2 VM); Priority 1-Yr SnS
SLES-SAP-2S2V-D3S	SLES for SAP Apps (1-2 CPU, 1-2 VM); Priority 3-Yr SnS
SLES-SAP-2S2V-D5S	SLES for SAP Apps (1-2 CPU, 1-2 VM); Priority 5-Yr SnS
SLES-SAP-2S2V-D1A	SLES for SAP Apps w/ HA (1-2 CPU, 1-2 VM); 1-Yr Support Req'd
SLES-SAP-2S2V-D3A	SLES for SAP Apps w/ HA (1-2 CPU, 1-2 VM); 3-Yr Support Req'd
SLES-SAP-2S2V-D5A	SLES for SAP Apps w/ HA (1-2 CPU, 1-2 VM); 5-Yr Support Req'd

STEP 14 CHOOSE OPTIONAL OPERATING SYSTEM MEDIA KIT

Select the optional operating system media listed in [Table 27](#).

Table 27 OS Media

Product ID (PID)	PID Description
MSWS-22-ST16CD-RM	Windows Server 2022 Stan (16 Cores/2 VMs) Rec Media DVD Only
MSWS-22-DC16CD-RM	Windows Server 2022 DC (16Cores/Unlim VM) Rec Media DVD Only

SUPPLEMENTAL MATERIAL

Simplified Block Diagram

A simplified block diagram of the Cisco UCS X215c M8 Compute Node system board is shown in [Figure 8](#).

Figure 8 Cisco UCS X215c M8 Compute Node Simplified Block Diagram (VIC 25G with Drives)

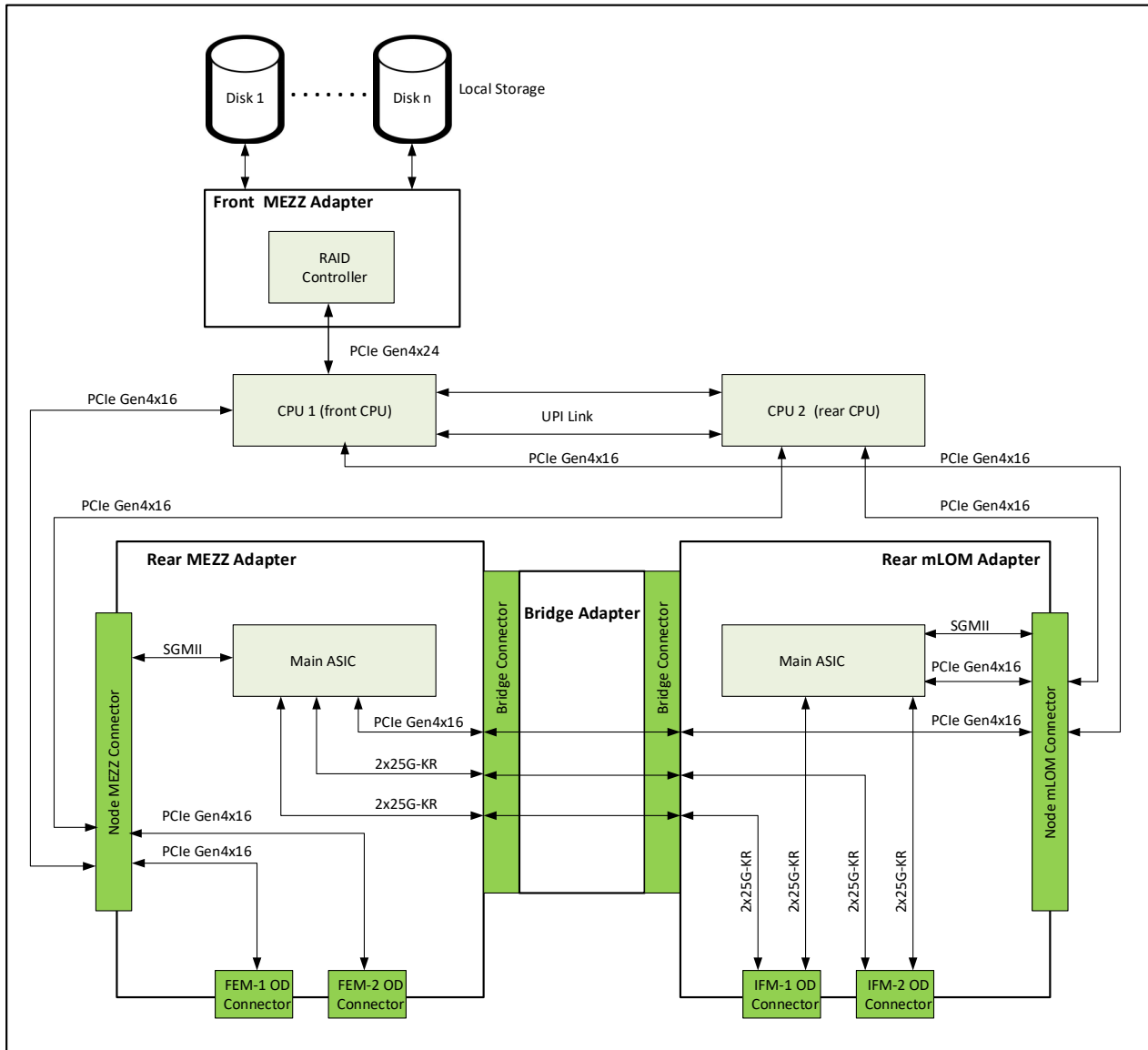

Figure 9 Cisco UCS X215c M8 Compute Node Simplified Block Diagram (VIC 100G with Drives)

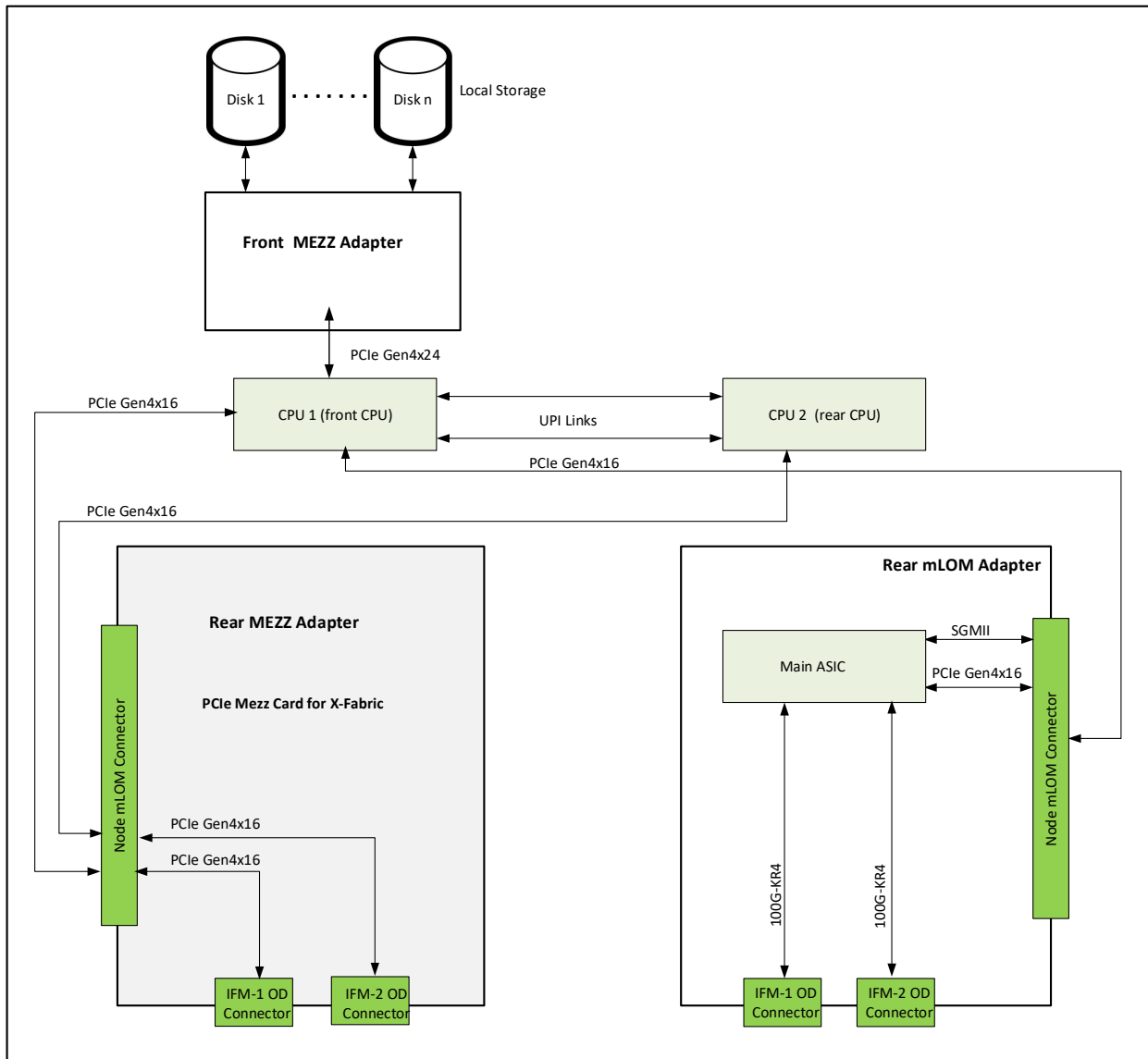

Figure 10 Cisco UCS X215c M8 Compute Node Simplified Block Diagram (VIC 25G with Drives and GPUs)

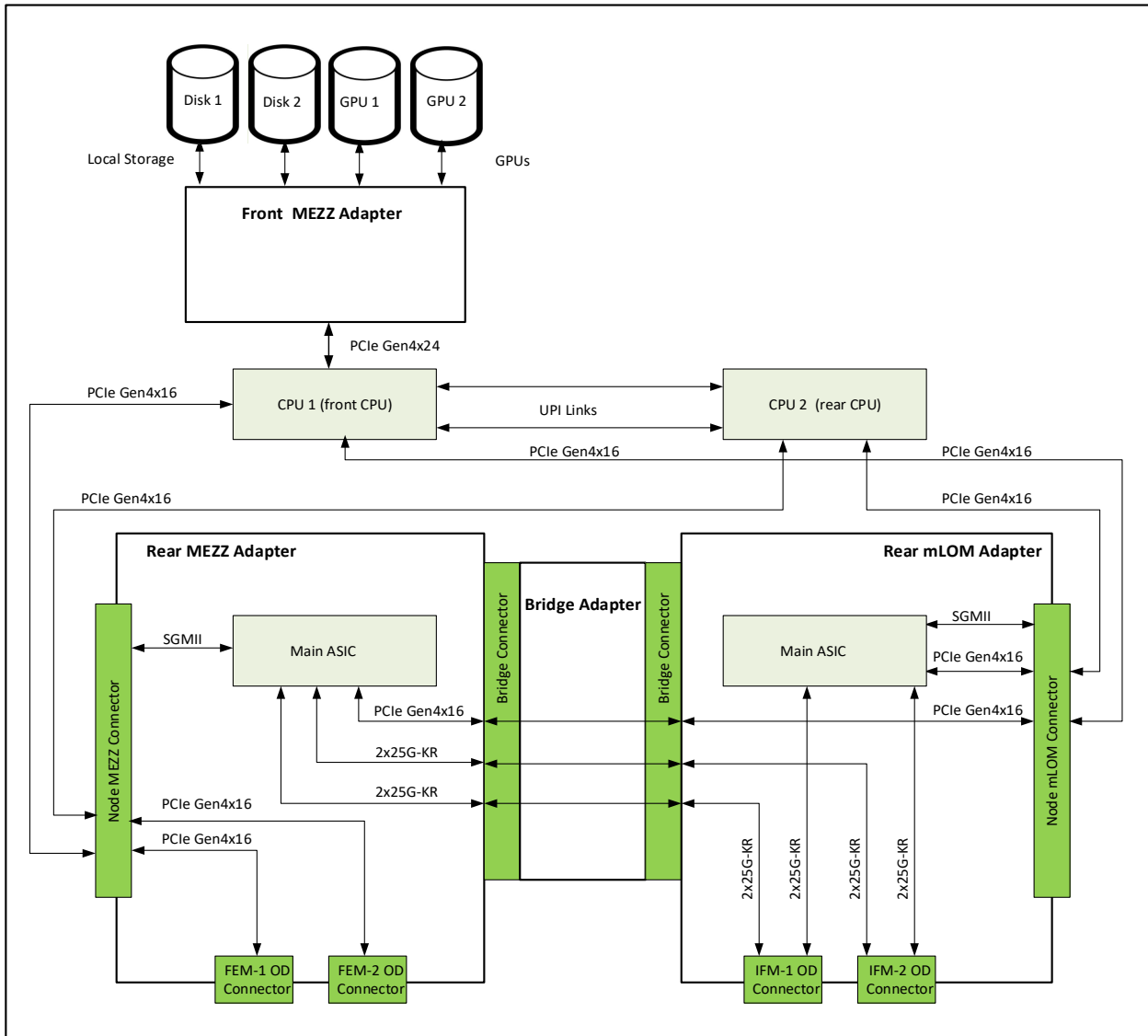
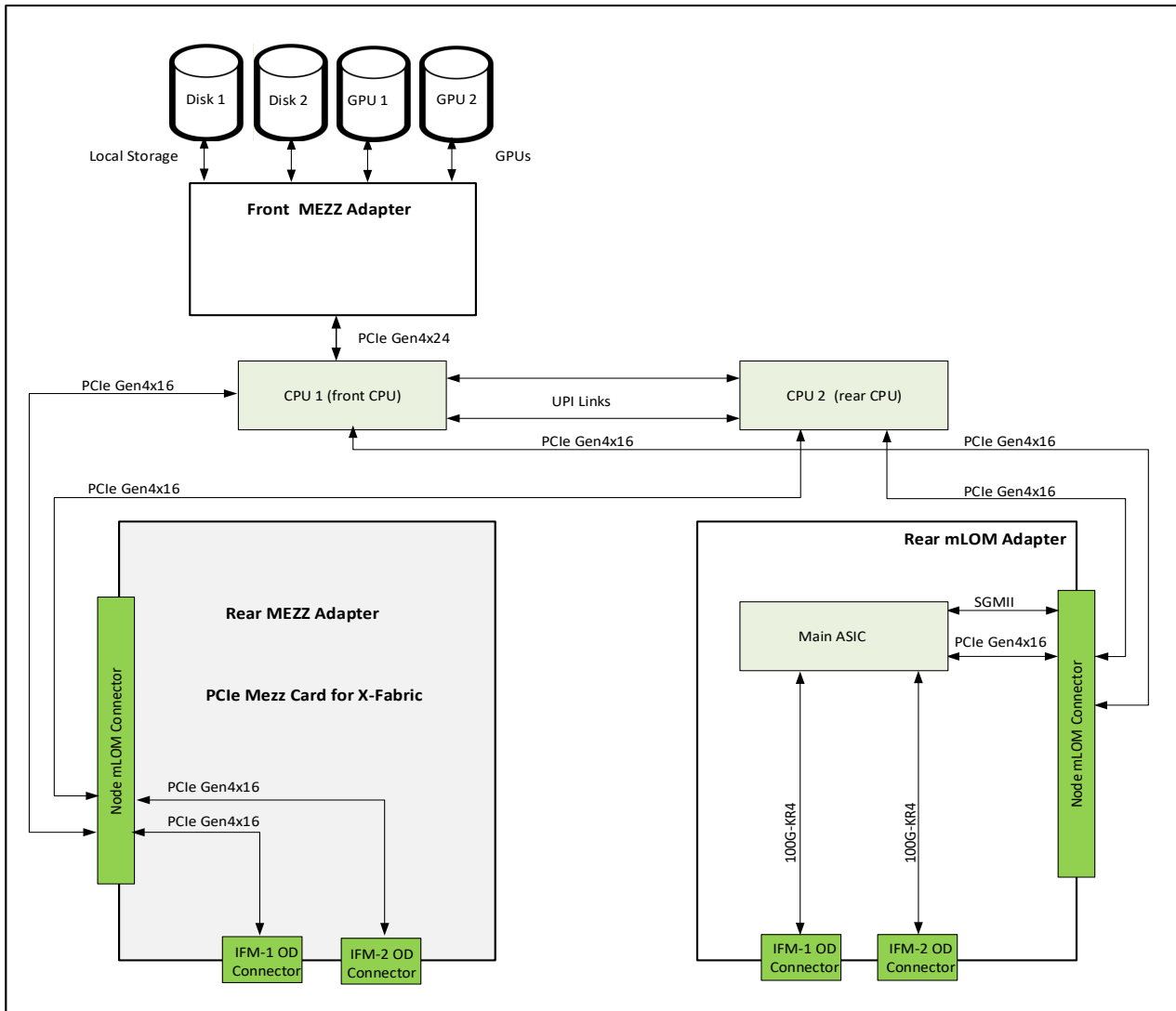

Figure 11 Cisco UCS X215c M8 Compute Node Simplified Block Diagram (VIC 100G with Drives and GPUs)



1	Front mezzanine slot for SAS/SATA or NVMe drives and M.2 Controllers.	5	Rear mezzanine slot, which supports a mezzanine card with standard or extended mLOM. If an extended mLOM slot is used, it occupies this slot, such that no rear mezzanine card can be installed.
2	DIMM slots (32 maximum)	6	Bridge adapter (for connecting the mLOM to the rear mezzanine card)
3	CPU 1 slot (shown populated)	7	mLOM slot for a standard or extended mLOM
4	CPU 2 slot (shown populated)	-	-

Please refer to the [Cisco UCS X215c M8 Compute Node Installation Guide](#) for installation procedures.

UPGRADING or REPLACING CPUs and Memory

- Refer to [Cisco UCS X215c M8 Server Installation and Service Guide](#) for upgrading or replacing the CPUs and Memory Devices.

TECHNICAL SPECIFICATIONS

Dimensions and Weight

Table 28 Cisco UCS X215c M8 Compute Node Dimensions and Weight

Parameter	Value
Height	1.80 in. (45.7 mm)
Width	11.28 in. (286.5 mm)
Depth	23.7 in. (602 mm)
Weight	<ul style="list-style-type: none"> ■ Minimally configured node weight = 12.84 lbs. (5.83 kg) ■ Fully configured compute node weight = 25.1 lbs. (11.39 kg)

Environmental Specifications

Table 29 Cisco UCS X215c M8 Compute Node Environmental Specifications

Parameter	Value
Operating temperature	50° to 95° F (10° to 35° C)
Non-operating temperature	-40° to 149° F (-40° to 65° C)
Operating humidity	5% to 90% noncondensing
Non-operating humidity	5% to 93% noncondensing
Operating altitude	0 to 10,000 ft (0 to 3000m); maximum ambient temperature decreases by 1° C per 300m
Non-operating altitude	40,000 ft (12,000m)

For configuration-specific power specifications, use the Cisco UCS Power Calculator at:

<http://ucspowercalc.cisco.com>



NOTE: The Cisco UCS X215c Server Node has a power cap of 1300 Watts for all combinations of components (CPUs, DIMMs, drives, and so on). Also, the ambient temperature must be less than 35 °C (95 °F).



Americas Headquarters
Cisco Systems, Inc.
San Jose, CA

Asia Pacific Headquarters
Cisco Systems (USA) Pte. Ltd.
Singapore

Europe Headquarters
Cisco Systems International BV Amsterdam,
The Netherlands

Cisco has more than 200 offices worldwide. Addresses, phone numbers, and fax numbers are listed on the Cisco Website at www.cisco.com/go/offices.

Cisco and the Cisco Logo are trademarks of Cisco Systems, Inc. and/or its affiliates in the U.S. and other countries. A listing of Cisco's trademarks can be found at www.cisco.com/go/trademarks. Third party trademarks mentioned are the property of their respective owners. The use of the word partner does not imply a partnership relationship between Cisco and any other company. (1005R)

