



Cisco UCS C240 M6 SFF Rack Server

A printed version of this document is only a copy and not necessarily the latest version. Refer to the following link for the latest released version:

<https://www.cisco.com/c/en/us/products/servers-unified-computing/ucs-c-series-rack-servers/datasheet-listing.html>



CISCO SYSTEMS
170 WEST TASMAN DR.
SAN JOSE, CA, 95134
WWW.CISCO.COM

PUBLICATION HISTORY

REV C.09 AUGUST 28, 2024

CONTENTS

OVERVIEW	3
DETAILED VIEWS	7
Chassis Front View - Option 1	7
Chassis Rear View - Option 1	8
Chassis Front View - Option 2	10
Chassis Rear View - Option 2	11
Chassis Front View - Option 3	14
Chassis Rear View - Option 3	15
Chassis Front View - Option 4	17
Chassis Rear View - Option 4	18
BASE SERVER STANDARD CAPABILITIES and FEATURES	20
CONFIGURING the SERVER	24
STEP 1 VERIFY SERVER SKU	25
STEP 2 SELECT RISER CARDS (REQUIRED)	27
STEP 3 SELECT CPU(s)	28
STEP 4 SELECT MEMORY	32
Memory Configurations, Features, and Modes	34
STEP 5 SELECT DRIVE CONTROLLERS	39
AHCI with SATA Interposer	39
Cisco 12G SAS RAID Controller	39
Cisco M6 12G SAS RAID Controller with 4 GB FBWC	40
Cisco 12G SAS HBA	40
RAID Volumes and Groups	40
STEP 6 SELECT DRIVES	44
Intel® Virtual RAID on CPU (Intel® VROC)	48
STEP 7 SELECT OPTION CARD(s)	49
STEP 8 ORDER OPTIONAL PCIe OPTION CARD ACCESSORIES	52
STEP 9 ORDER GPU CARDS (OPTIONAL)	55
GPU Ready Configuration	57
STEP 10 ORDER POWER SUPPLY	58
STEP 11 SELECT INPUT POWER CORD(s)	60
STEP 12 ORDER TOOL-LESS RAIL KIT AND OPTIONAL REVERSIBLE CABLE MANAGEMENT ARM	64
STEP 13 SELECT MANAGEMENT CONFIGURATION (OPTIONAL)	65
STEP 14 SELECT SERVER BOOT MODE (OPTIONAL)	66
STEP 15 ORDER SECURITY DEVICES (OPTIONAL)	67
STEP 16 SELECT LOCKING SECURITY BEZEL (OPTIONAL)	68
STEP 17 ORDER OPTICAL DRIVE (OPTIONAL)	69
STEP 18 ORDER M.2 SATA SSDs (OPTIONAL)	70
STEP 19 SELECT OPERATING SYSTEM AND VALUE-ADDED SOFTWARE	72
STEP 20 SELECT OPERATING SYSTEM MEDIA KIT	76
STEP 21 SELECT SERVICE and SUPPORT LEVEL	77
Unified Computing Warranty, No Contract	77
Smart Net Total Care (SNTC) for Cisco UCS	77
Smart Net Total Care for Cisco UCS Onsite Troubleshooting Service	79
Solution Support (SSPT) for UCS	80
Solution Support for Service Providers	81
Smart Net Total Care for UCS Hardware Only Service	82
Partner Support Service for UCS	83
PSS for UCS Hardware Only	84

CONTENTS

Distributor Support Service	85
Unified Computing Combined Support Service	86
UCS Drive Retention Service	87
Local Language Technical Support for UCS	87
SUPPLEMENTAL MATERIAL	88
Feature Comparison	88
Block Diagrams	90
Serial Port Details	93
KVM Cable	93
Chassis	94
Risers	96
Riser Card Configuration and Options	98
Memory Support for 3rd Generation Intel® Xeon® Scalable Processors (Ice Lake)	104
SPARE PARTS	105
UPGRADING or REPLACING CPUs	123
UPGRADING or REPLACING MEMORY	124
DISCONTINUED EOL PRODUCTS	125
TECHNICAL SPECIFICATIONS	127
Dimensions and Weight	127
Power Specifications	128
Environmental Specifications	133
Extended Operating Temperature Hardware Configuration Limits	135
Compliance Requirements	137

OVERVIEW

The UCS C240 M6 SFF server extends the capabilities of Cisco's Unified Computing System portfolio in a 2U form factor with the addition of the 3rd Gen Intel® Xeon® Scalable Processors (Ice Lake), 16 DIMM slots per CPU for 3200-MHz DDR4 DIMMs with DIMM capacity points up to 256 GB¹. The maximum memory capacity for 2 CPUs is listed here:

- 8 TB: 32 x 256 GB DDR4 DIMMs¹, or
- 12 TB: 16 x 256 GB DDR4 DIMMs¹ and 16 x 512 GB Intel® Optane™ Persistent Memory Modules (PMem).

There are several options to choose from:

- Option 1 (see [Figure 1 on page 5](#)):
 - Up to 12 front SFF SAS/SATA HDDs or SSDs (optionally up to 4 of the drives can be NVMe)
 - I/O-centric option provides up to 8 PCIe slots using all three rear risers
 - Storage-centric option provides 6 PCIe slots and one rear riser with a total of up to 2 SFF drives (SAS/SATA and NVMe PCIe Gen4 x4)
 - Optional optical drive
- Option 2 (see [Figure 2 on page 6](#)):
 - Up to 24 front SFF SAS/SATA HDDs or SSDs (optionally up to 4 of the slots can be NVMe)
 - I/O-centric option provides up to 8 PCIe slots using all three rear risers
 - Storage-centric option provides 3 PCIe slots using slots in one of the rear risers and two rear risers with a total of up to 4 SFF drives (SAS/SATA or NVMe PCIe Gen4 x4), or
- Option 3 (see [Figure 3 on page 7](#)):
 - Up to 12 front SFF NVMe-only drives
 - I/O-centric option provides up to 6 PCIe slots using two rear risers
 - Storage-centric option provides 3 PCIe slots using slots in one of the rear risers and up to 2 SFF drives (NVMe PCIe Gen4 x4) using one of the rear risers
- Option 4 (see [Figure 4 on page 8](#)):
 - Up to 24 front NVMe-only drives
 - I/O-centric option provides up to 6 PCIe slots using two rear risers
 - Storage-centric option provides 3 PCIe slots using slots in one of the rear risers and up to 2 SFF drives (NVMe PCIe Gen4 x4) using one of the rear risers

See [Table 44 on page 87](#) for a side-by-side server feature comparison.

Notes:

1. 256 GB DIMM is available on all C240M6 server models, with the exclusion of C240M6 LFF model.

The server provides one or two internal slots (depending on the server type) for the following:

- One slot for a SATA Interposer to control up to 8 SATA-only drives from the PCH (AHCI), or
- One slot for a Cisco 12G RAID controller with cache backup to control up to 28 SAS/SATA drives, or
- Two slots for Cisco 12G SAS pass-through HBAs. Each HBA controls up to 16 SAS/SATA drives



NOTE:

PCIe drives are controlled directly from the CPUs.

The UCS C240 M6 server has two LOM ports (10Gbase-T LOM) and a single 1 GbE management port. A modular LAN on motherboard (mLOM) module provides up to two 100 GbE ports. A connector on the front of the chassis provides KVM functionality.

The Cisco UCS C240 M6 server can be used standalone, or as part of the Cisco Unified Computing System, which unifies computing, networking, management, virtualization, and storage access into a single integrated architecture enabling end-to-end server visibility, management, and control in both bare metal and virtualized environments.

See [Figure 1 on page 5](#) and [Figure 2 on page 6](#) for front and rear views of all the configurations of the UCS C240 M6 server.

Figure 1 Cisco UCS C240 M6 SFF Rack Server

Option 1

12 Front drives are SAS/SATA and NVMe mix (up to 4 front NVMe drives) and optionally 2 SAS/SATA/NVMe rear drives.
Front View (no optical drive option)



Front View (optical drive option)

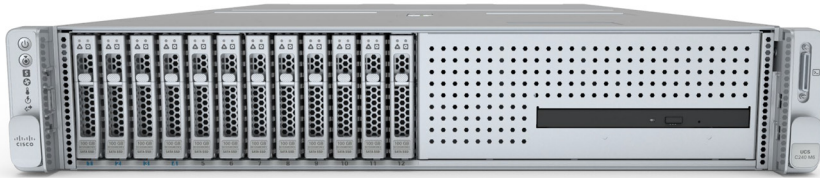

Rear View (all slots shown unpopulated - see [Figure 4 on page 8](#) for details)

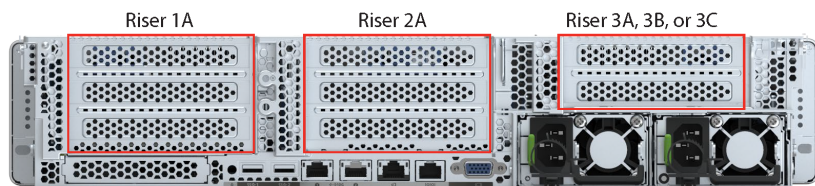

Option 2

24 Front drives are SAS/SATA and NVMe mix (up to 4 NVMe front drives) and optionally 4 SAS/SATA/NVMe rear drives

Front View



Rear View (all slots shown unpopulated - see [Figure 6 on page 11](#) for details)

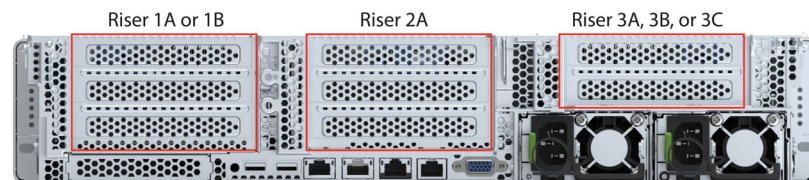
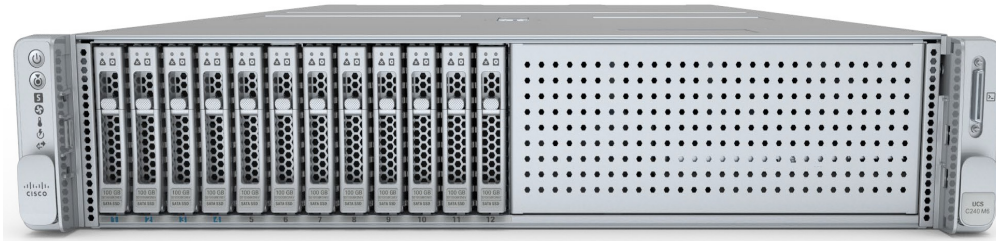

Figure 2 Cisco UCS C240 M6 SFF Rack Server

Option 3

12 front drives are all NVMe (only) drives and optionally 2 NVMe (only) rear drives

Front View



Rear View (all slots shown unpopulated - see [Figure 8 on page 15](#) for details)

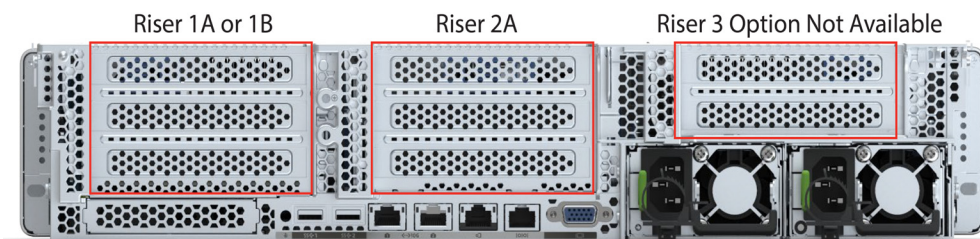

Option 4

24 front drives are all NVMe (only) drives and optionally 2 NVMe (only) rear drives

Front View



Rear View (all slots shown unpopulated - see [Figure 10 on page 18](#) for details)

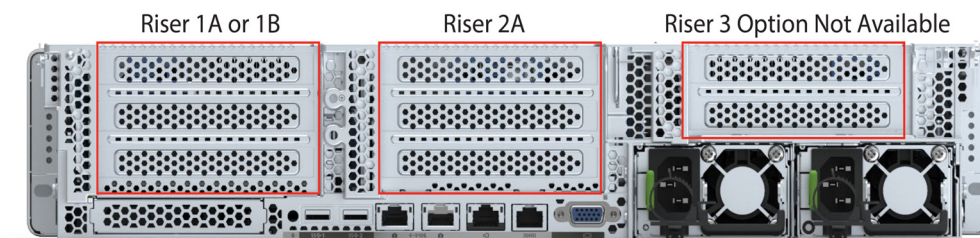

DETAILED VIEWS

Chassis Front View - Option 1

Figure 3 shows the front View of the C240 M6 SFF Rack Server configured with 12 SFF front drives. The drives can be a mix of SAS/SATA and NVMe (up to 4 NVMe drives) and optionally up to 4 SAS/SATA/NVMe rear drives. The DVD drive is optional.

Figure 3 Chassis Front View (Option 1 - UCSC-C240-M6S)

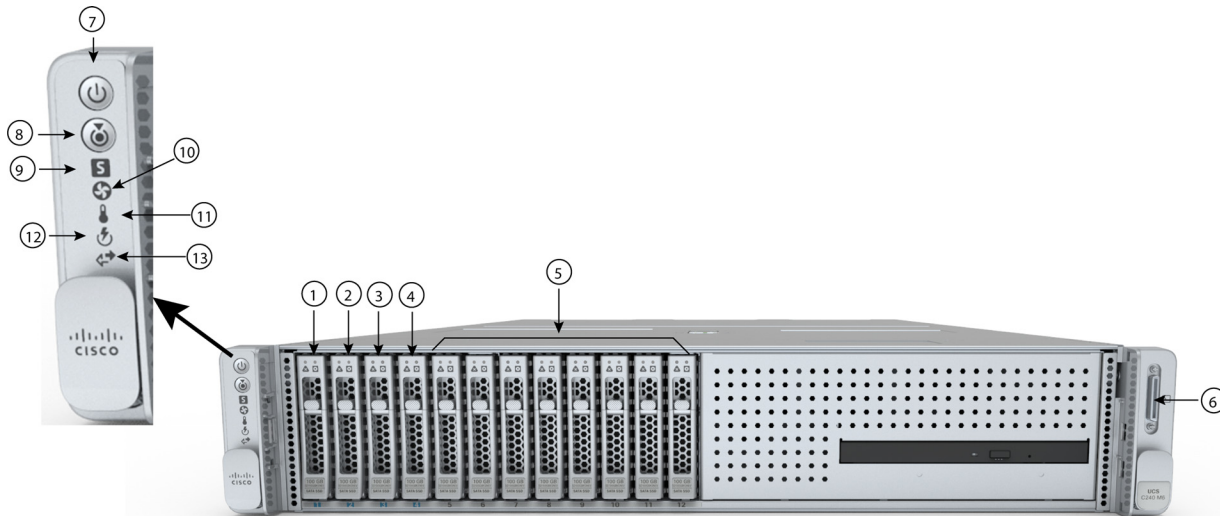

1 - 4	Drive bays 1 - 4 support SAS/SATA hard drives and solid state drives (SSDs) as well as NVMe PCIe drives ^{1, 2, 3} .	9	System status LED
5	Drive bays 5 - 12 support SAS/SATA hard drives and solid state drives (SSDs) only	10	Fan status LED
6	KVM connector (used with KVM cable that provides USB 3.0, one VGA, and one serial connector)	11	Temperature status LED
7	Power button/Power status LED	12	Power supply status LED
8	Unit Identification button/LED	13	Network link activity LED

Notes:

1. If NVMe drives are selected, you must also select 2 CPUs.
2. You can mix and match in drive bays 1-4. For example, slots 1 and 2 can hold NVMe drives and slots 3 and 4 can hold SAS/SATA HDDs or SSDs.
3. If using a SATA Interposer board, up to a maximum of 8 SATA-only drives can be configured (slots 1-8 only)

Chassis Rear View - Option 1

Figure 4 shows the external features of the rear panel. The I/O centric version shows all PCIe slots. The storage centric version shows a combination of PCIe risers and storage bays.

Figure 4 Chassis Rear View (Option 1 - UCSC-C240-M6S)

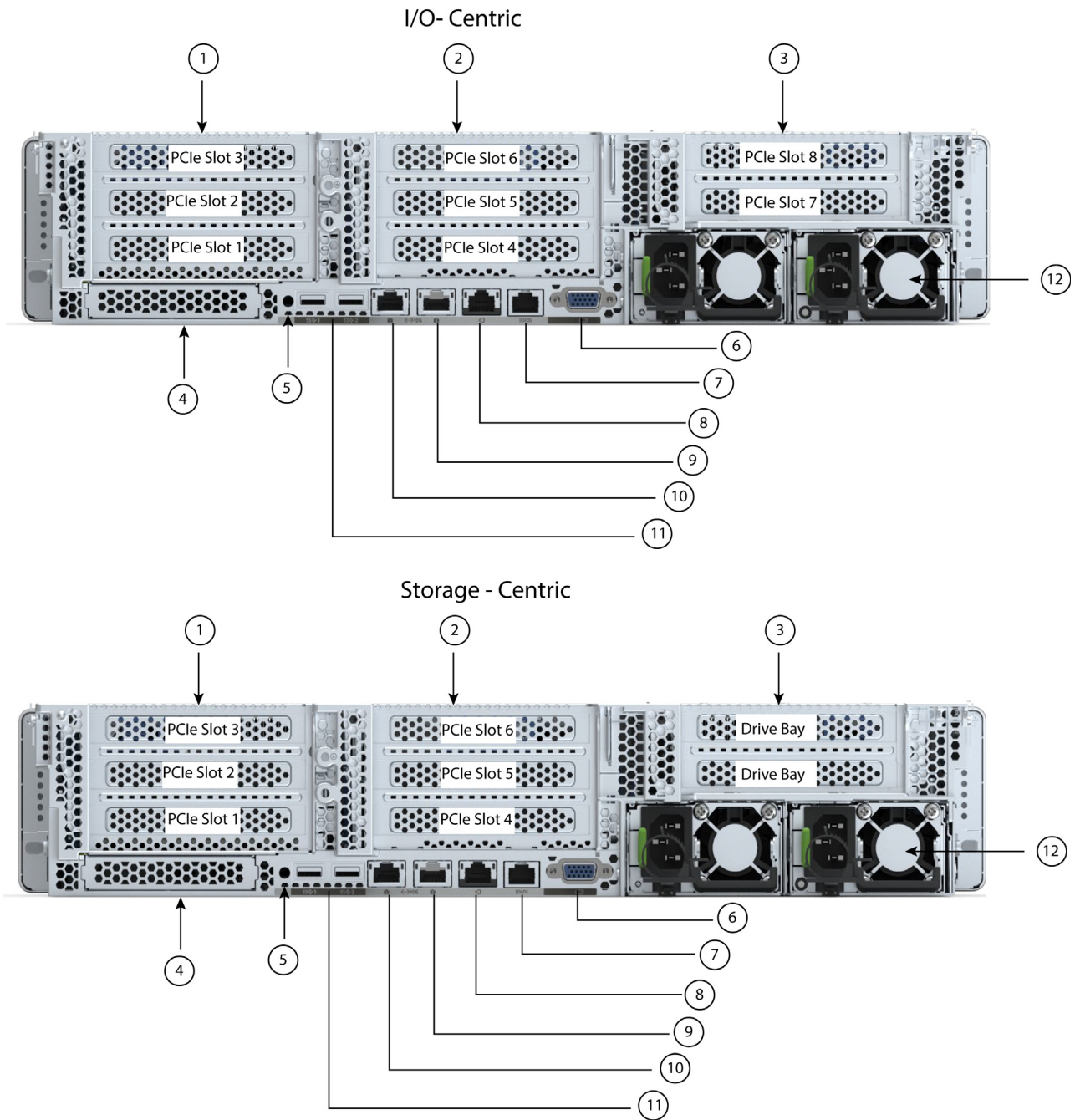

1	<p>There is one Riser 1 option:</p> <p>Riser 1A (I/O-centric, CPU1 control)</p> <p>Supports three PCIe slots:</p> <ul style="list-style-type: none"> ■ Slot 1 is full-height, 3/4 length, x8, NCSI ■ Slot 2 is full-height, full-length, x16, NCSI ■ Slot 3 is full-height, full-length, x8, no NCSI <p>See Riser Card Configuration and Options, page 97 for details.</p>	7	COM port (RJ45 connector)
2	<p>Riser 2A (always I/O-centric, CPU2 control)</p> <p>Supports three PCIe slots:</p> <ul style="list-style-type: none"> ■ Slot 4 is full-height, 3/4 length, x8 ■ Slot 5 is full-height, full-length, x16 ■ Slot 6 is full-height, full length, x8 <p>See Riser Card Configuration and Options, page 97 for details.</p>	8	1 GbE dedicated Ethernet management port
3	<p>There are three Riser 3 options</p> <p>Riser 3A (I/O-centric, CPU2 control)</p> <ul style="list-style-type: none"> ■ Supports two PCIe slots: <ul style="list-style-type: none"> • Slot 7 is full-height, full-length, x8, no NCSI • Slot 8 is full-height, full-length, x8, no NCSI <p>Riser 3B (storage-centric, CPU2 control)</p> <ul style="list-style-type: none"> ■ Supports two SFF drives (SAS/SATA/NVMe) <ul style="list-style-type: none"> • Slot 7 (drive bay 104), x4 • Slot 8 (drive bay 103), x4 • When using AHCI in the server, only SATA SSDs are supported in the rear bays. <p>Riser 3C (for GPU, CPU2 control)</p> <ul style="list-style-type: none"> ■ Supports one full-height, full-length, double-wide GPU (PCIe slot 7 only), x16 ■ Slot 8 is blocked by double-wide GPU <p>See Riser Card Configuration and Options, page 97 for details.</p>	9 -10	<p>Dual 1/10 GbE Ethernet ports (LAN1, LAN2)</p> <p>LAN1 is left connector, LAN2 is right connector</p>
4	Modular LAN-on-motherboard (mLOM) card slot (x16)	11	USB 3.0 ports (two)
5	System ID pushbutton/LED	12	Power supplies (two)
6	VGA display port (DB15 connector)	-	-



NOTE: For GPU support on a particular riser slot, see [Table 18 on page 55](#)

Chassis Front View - Option 2

Figure 5 shows the front View of the C240 M6 SFF Rack Server configured with 24 front drives. The drives can be a mix of SAS/SATA and NVMe (up to 4 NVMe drives) and optionally 4 SAS/SATA rear drives.

Figure 5 Chassis Front View (Option 2 - UCSC-C240-M6SX)

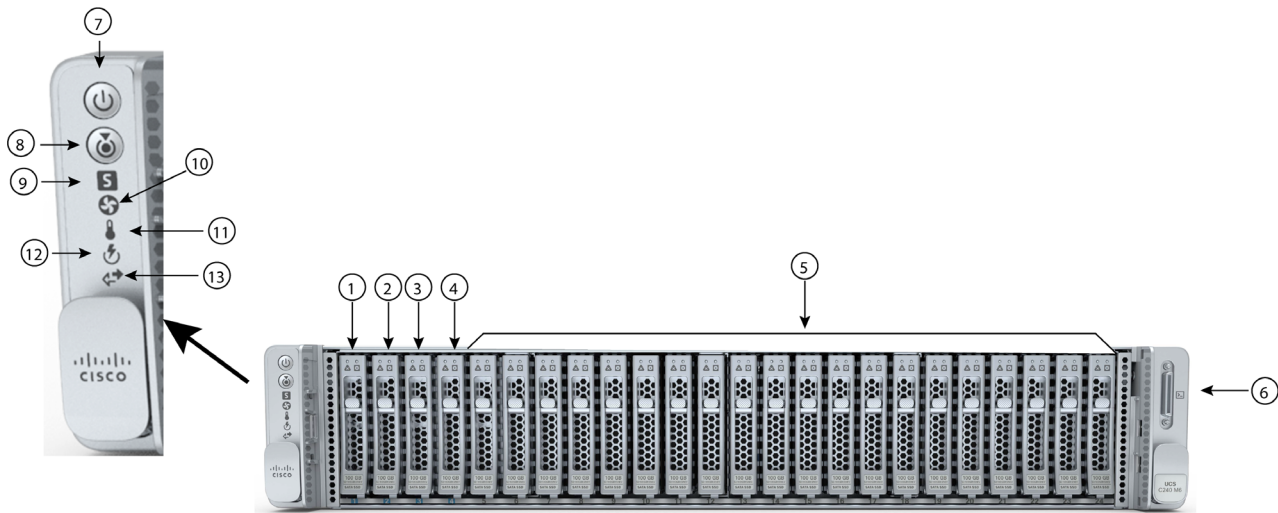

1 - 4	Drive bays 1 - 4 support SAS/SATA hard drives and solid state drives (SSDs) as well as NVME PCIe drives ^{1, 2, 3} .	9	System status LED
5	Drive bays 5 - 24 support SAS/SATA hard drives and solid state drives (SSDs) only	10	Fan status LED
6	KVM connector (used with KVM cable that provides one USB 2.0, one VGA, and one serial connector)	11	Temperature status LED
7	Power button/Power status LED	12	Power supply status LED
8	Unit Identification button/LED	13	Network link activity LED

Notes:

1. If NVMe drives are selected, you must also select 2 CPUs.
2. You can mix and match in drive bays 1-4. For example, slots 1 and 2 can hold NVMe drives and slots 3 and 4 can hold SAS/SATA HDDs or SSDs.
3. If using a SATA Interposer board, up to a maximum of 8 SATA-only drives can be configured (slots 1-8 only)

Chassis Rear View - Option 2

Figure 6 shows the external features of the rear panel. The I/O centric version shows all PCIe slots. The storage centric version shows a combination of PCIe risers and storage bays.

Figure 6 Chassis Rear View (Option 2 - UCSC-C240-M6SX)

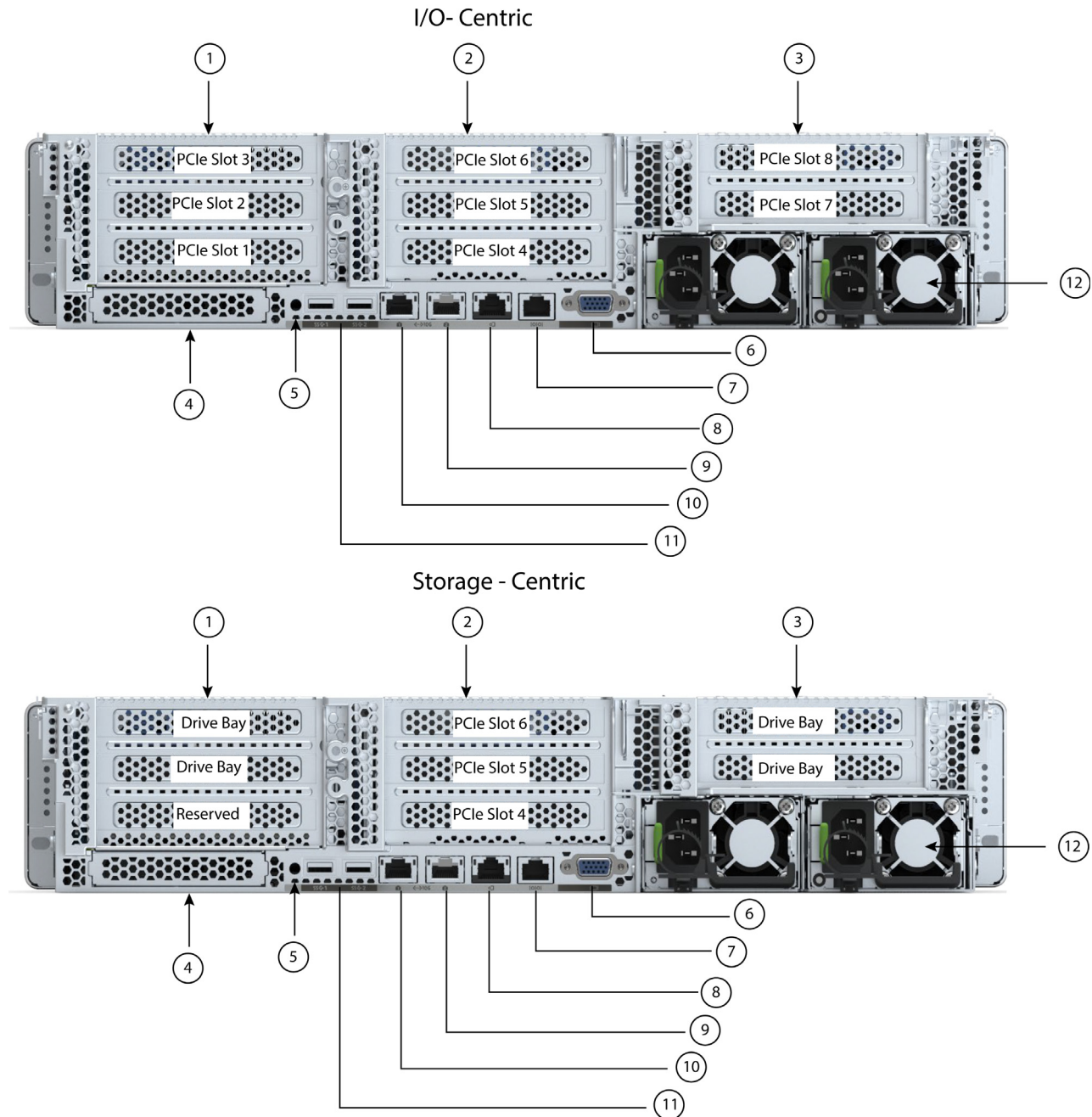

<p>1</p>	<p>There are two Riser 1 options: Riser 1A (I/O-centric, CPU1 control) Supports three PCIe slots:</p> <ul style="list-style-type: none"> ■ Slot 1 is full-height, 3/4 length, x8, NCSI ■ Slot 2 is full-height, full-length, x16, NCSI ■ Slot 3 is full-height, full-length, x8, no NCSI <p>Riser 1B (storage-centric)</p> <ul style="list-style-type: none"> ■ Supports two SFF SAS/SATA/NVMe drives <ul style="list-style-type: none"> • Slot 1 is reserved • Slot 2 (drive bay 102), x4 (CPU1 control) • Slot 3 (drive bay 101), x4 (CPU1 control) • • When using AHCI in the server, only SATA SSDs are supported in the rear bays. <p>See Riser Card Configuration and Options, page 97 for details.</p>	<p>7</p>	<p>COM port (RJ45 connector)</p>
<p>2</p>	<p>Riser 2A (always I/O-centric, CPU2 control) Supports three PCIe slots:</p> <ul style="list-style-type: none"> ■ Slot 4 is full-height, 3/4 length, x8 ■ Slot 5 is full-height, full-length, x16 ■ Slot 6 is full-height, full length, x8 <p>See Riser Card Configuration and Options, page 97 for details.</p>	<p>8</p>	<p>1 GbE dedicated Ethernet management port</p>
<p>3</p>	<p>There are three Riser 3 options Riser 3A (I/O-centric, CPU2 control)</p> <ul style="list-style-type: none"> ■ Supports two PCIe slots: <ul style="list-style-type: none"> • Slot 7 is full-height, full-length, x8, no NCSI • Slot 8 is full-height, full-length, x8, no NCSI <p>Riser 3B (storage-centric, CPU2 control)</p> <ul style="list-style-type: none"> ■ Supports two SFF drives (SAS/SATA/NVMe) <ul style="list-style-type: none"> • Slot 7 (drive bay 104), x4 • Slot 8 (drive bay 103), x4 • When using AHCI in the server, only SATA SSDs are supported in the rear bays. <p>Riser 3C (for GPU, CPU2 control)</p> <ul style="list-style-type: none"> ■ Supports one full-height, full-length, double-wide GPU (PCIe slot 7 only), x16 ■ Slot 8 is blocked by double-wide GPU <p>See Riser Card Configuration and Options, page 97 for details.</p>	<p>9 -10</p>	<p>Dual 1/10 GbE Ethernet ports (LAN1, LAN2) LAN1 is left connector, LAN2 is right connector</p>

4	Modular LAN-on-motherboard (mLOM) card slot (x16)	11	USB 3.0 ports (two)
5	System ID pushbutton/LED	12	Power supplies (two)
6	VGA display port (DB15 connector)	-	-



NOTE: For GPU support on a particular riser slot, see [Table 18 on page 55](#)

Chassis Front View - Option 3

Figure 7 shows the front View of the C240 M6 SFF Rack Server configured with up to 12 NVMe front drives and optionally two NVMe rear drives. The drives are all NVMe.

Figure 7 Chassis Front View (Option 3 - UCSC-C240-M6N)

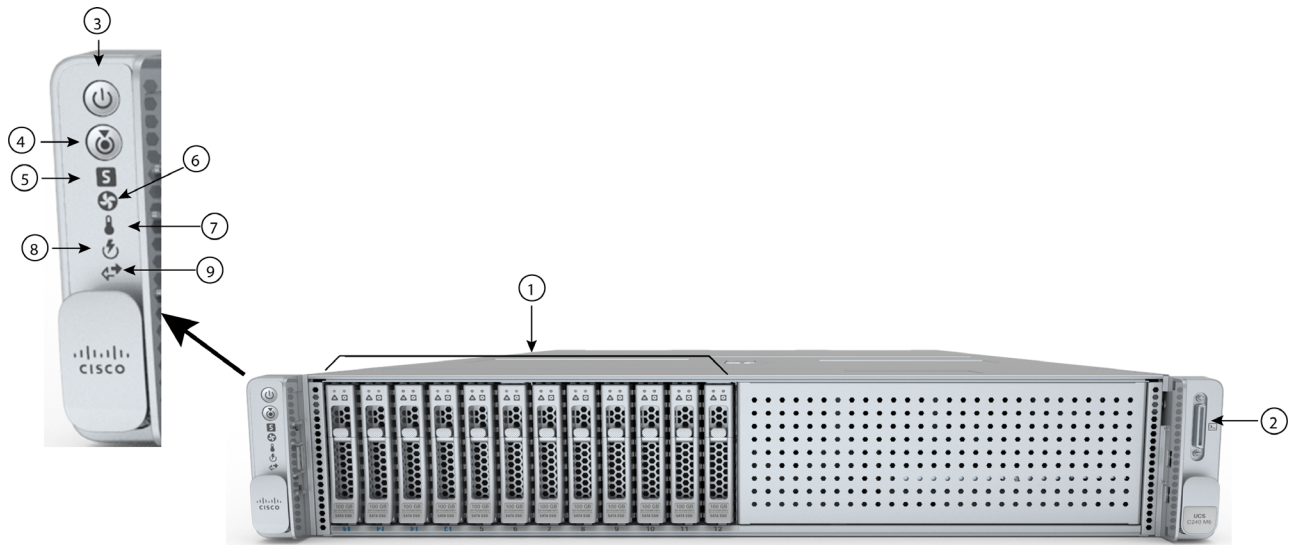

1	Drive bays 1 - 12 support SFF NVME PCIe drives (only) ¹ .	6	Fan status LED
2	KVM connector (used with KVM cable that provides two USB 2.0, one VGA, and one serial connector)	7	Temperature status LED
3	Power button/Power status LED	8	Power supply status LED
4	Unit Identification button/LED	9	Network link activity LED
5	System status LED	-	-

Notes:

1. When NVMe drives are selected, you must also select 2 CPUs.

Chassis Rear View - Option 3

Figure 8 shows the external features of the rear panel. The I/O centric version shows all PCIe slots (two of the slots are not supported). The storage centric version shows a combination of PCIe risers and storage bays (two of the slots are not supported).

Figure 8 Chassis Rear View (Option 3 - UCSC-C240-M6N)

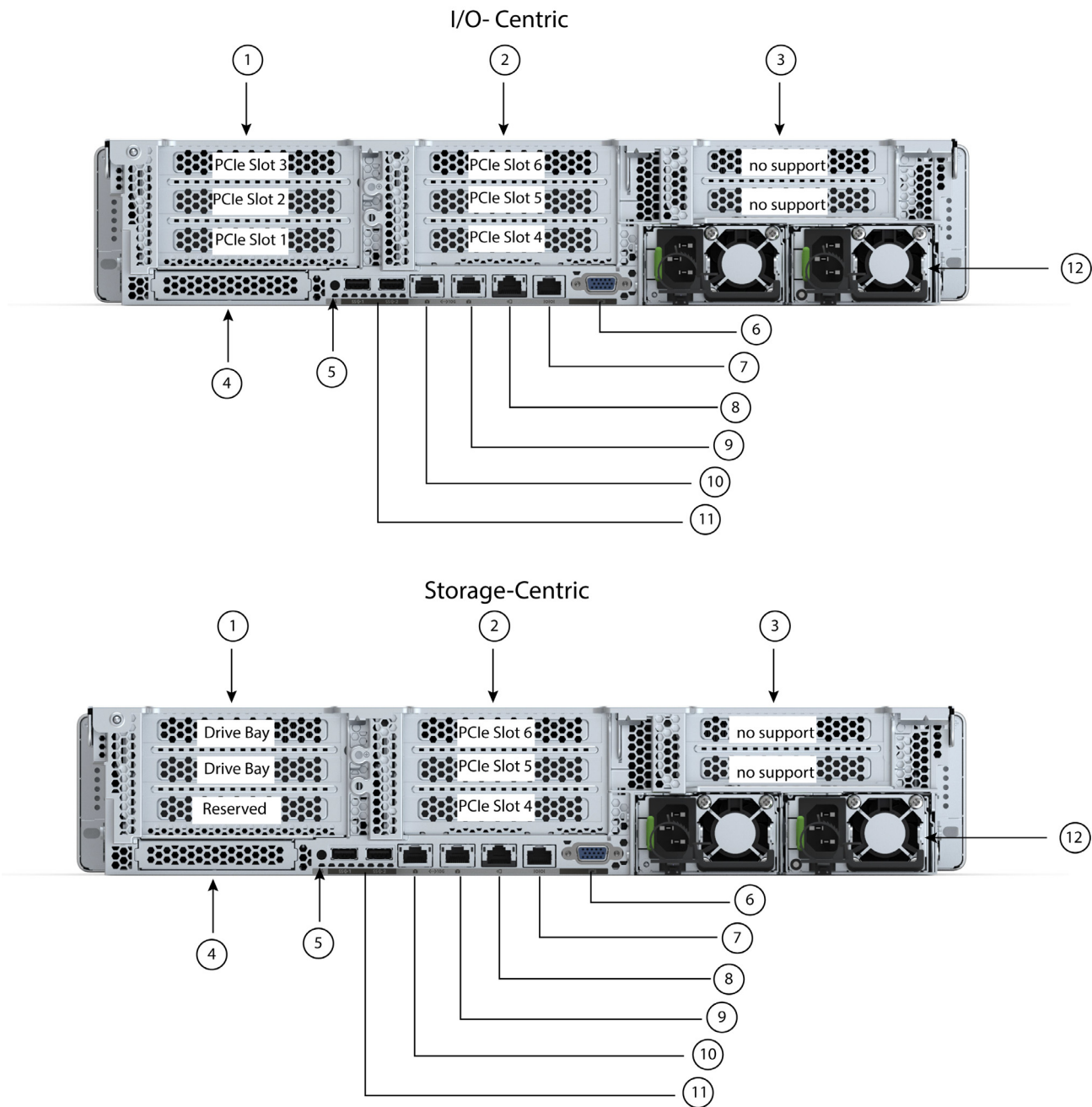

1	<p>There are two Riser 1 options: Riser 1A (I/O-centric, CPU1 control) Supports three PCIe slots:</p> <ul style="list-style-type: none"> ■ Slot 1 is full-height, 3/4 length, x8, NCSI ■ Slot 2 is full-height, full-length, x16, NCSI ■ Slot 3 is full-height, full-length, x8, no NCSI <p>Riser 1B (storage-centric)</p> <ul style="list-style-type: none"> ■ Supports two NVMe drives <ul style="list-style-type: none"> • Slot 1 is reserved • Slot 2 (drive bay 102), x4 (CPU1 control) • Slot 3 (drive bay 101), x4 (CPU1 control) <p>See Riser Card Configuration and Options, page 97 for details.</p>	7	COM port (RJ45 connector)
2	<p>Riser 2A (always I/O-centric, CPU2 control) Supports three PCIe slots:</p> <ul style="list-style-type: none"> ■ Slot 4 is full-height, 3/4 length, x8, NCSI ■ Slot 5 is full-height, full-length, x16, NCSI ■ Slot 6 is full-height, full length, x8 <p>See Riser Card Configuration and Options, page 97 for details.</p>	8	1 GbE dedicated Ethernet management port
3	<p>Riser 3A, 3B, and 3C</p> <ul style="list-style-type: none"> ■ Not supported 	9 - 10	Dual 1/10 GbE Ethernet ports (LAN1, LAN2) LAN1 is left connector, LAN2 is right connector
4	Modular LAN-on-motherboard (mLOM) card slot (x16)	11	USB 3.0 ports (two)
5	System ID pushbutton/LED	12	Power supplies (two)
6	VGA display port (DB15 connector)	-	-



NOTE: For GPU support on a particular riser slot, see [Table 18 on page 55](#)

Chassis Front View - Option 4

Figure 9 shows the front View of the C240 M6 SFF Rack Server configured with 24 SFF NVMe front drives and optionally two NVMe rear drives. The drives are all NVMe drives.

Figure 9 Chassis Front View (Option 4 - UCSC-C240-M6SN)

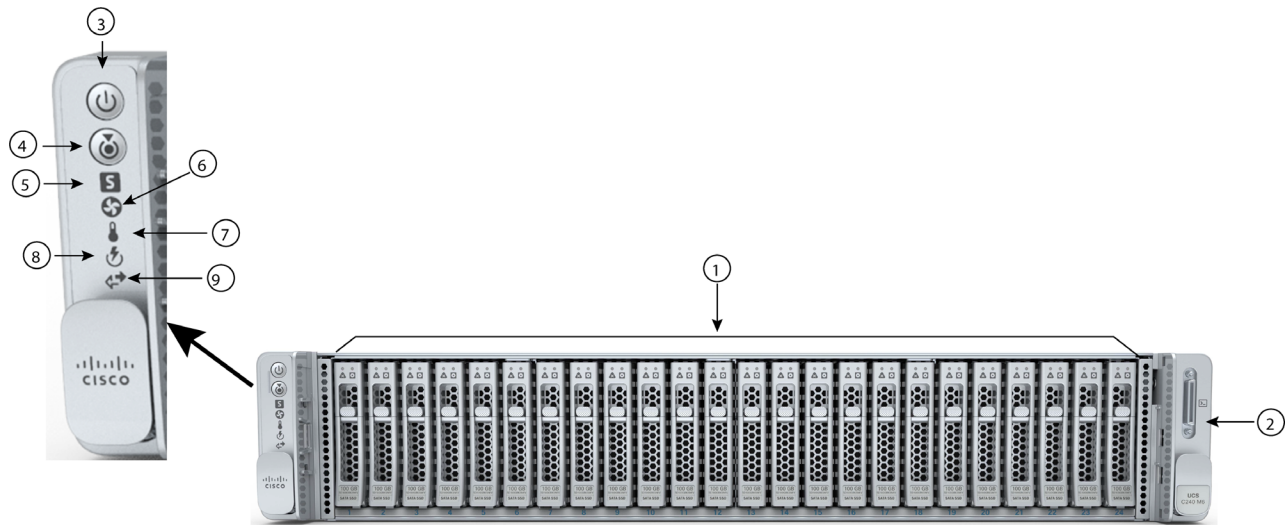

1	Drive bays 1 - 24 support NVME PCIe drives (only) ¹	6	Fan status LED
2	KVM connector (used with KVM cable that provides two USB 2.0, one VGA, and one serial connector)	7	Temperature status LED
3	Power button/Power status LED	8	Power supply status LED
4	Unit Identification button/LED	9	Network link activity LED
5	System status LED	-	-

Notes:

1. If NVMe drives are selected, you must also select 2 CPUs.

Chassis Rear View - Option 4

Figure 10 shows the external features of the rear panel. The I/O centric version shows all PCIe slots (two slots are not supported). The storage centric version shows a combination of PCIe risers and storage bays (two slots are not supported).

Figure 10 Chassis Rear View (Option 4 - UCSC-C240-M6SN)

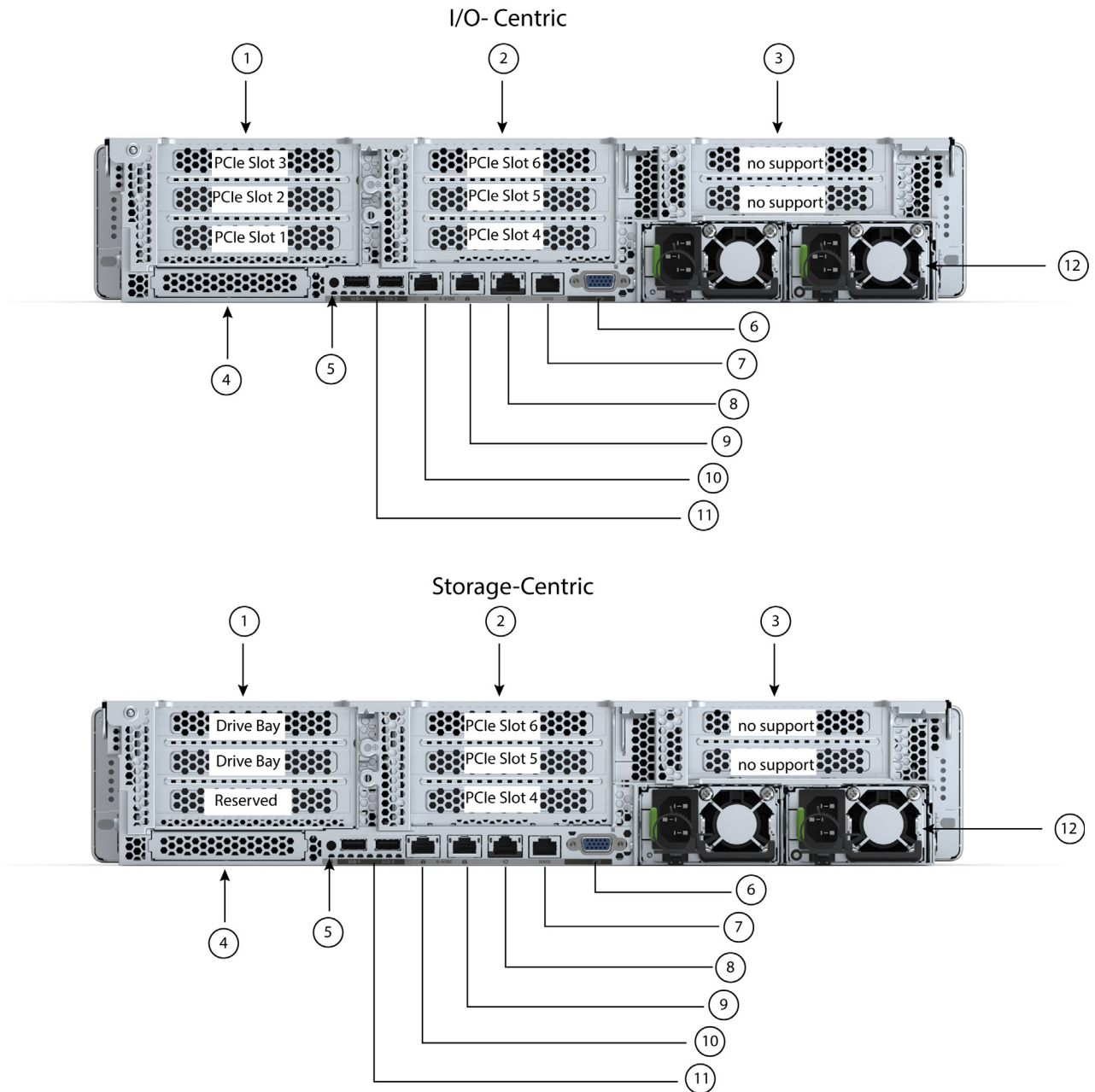

1	<p>There are two Riser 1 options: Riser 1A (I/O-centric, CPU1 control) Supports three PCIe slots:</p> <ul style="list-style-type: none"> ■ Slot 1 is full-height, 3/4 length, x8, NCSI ■ Slot 2 is full-height, full-length, x16, NCSI ■ Slot 3 is full-height, full-length, x8, no NCSI <p>Riser 1B (storage-centric)</p> <ul style="list-style-type: none"> ■ Supports two NVMe drives <ul style="list-style-type: none"> • Slot 1 is reserved • Slot 2 (drive bay 102), x4 (CPU1 control) • Slot 3 (drive bay 101), x4 (CPU1 control) <p>See Riser Card Configuration and Options, page 97 for details.</p>	7	COM port (RJ45 connector)
2	<p>Riser 2A (always I/O-centric, CPU2 control) Supports three PCIe slots:</p> <ul style="list-style-type: none"> ■ Slot 4 is full-height, 3/4 length, x8 ■ Slot 5 is full-height, full-length, x16 ■ Slot 6 is full-height, full length, x8 <p>See Riser Card Configuration and Options, page 97 for details.</p>	8	1 GbE dedicated Ethernet management port
3	<p>Riser 3A, 3B, and 3C</p> <ul style="list-style-type: none"> • Not supported 	9 - 10	Dual 1/10 GbE Ethernet ports (LAN1, LAN2) LAN1 is left connector, LAN2 is right connector
4	Modular LAN-on-motherboard (mLOM) card slot (x16)	11	USB 3.0 ports (two)
5	System ID pushbutton/LED	12	Power supplies (two)
6	VGA display port (DB15 connector)	-	-



NOTE: For GPU support on a particular riser slot, see [Table 18 on page 55](#)

BASE SERVER STANDARD CAPABILITIES and FEATURES

Table 1 lists the capabilities and features of the base server. Details about how to configure the server for a particular feature or capability (for example, number of processors, disk drives, or amount of memory) are provided in *CONFIGURING the SERVER, page 24*.

Table 1 Capabilities and Features

Capability/Feature	Description
Chassis	Two rack unit (2RU) chassis
CPU	One or two 3rd Gen Intel® Xeon® Scalable Processors (Ice Lake) ¹
Chipset	Intel® C621A series chipset
Memory	32 slots for registered DIMMs (RDIMMs) or load-reduced DIMMs (LRDIMMs) and support for Intel® Optane™ Persistent Memory Modules (PMem)
Multi-bit Error Protection	This server supports multi-bit error protection.
Video	The Cisco Integrated Management Controller (CIMC) provides video using the Matrox G200e video/graphics controller: <ul style="list-style-type: none"> ■ Integrated 2D graphics core with hardware acceleration ■ Embedded DDR memory interface supports up to 512 MB of addressable memory (8 MB is allocated by default to video memory) ■ Supports display resolutions up to 1920 x 1200 16bpp @ 60Hz ■ High-speed integrated 24-bit RAMDAC ■ Single lane PCI-Express host interface running at Gen 1 speed
Power subsystem	Up to two of the following hot-swappable power supplies: <ul style="list-style-type: none"> ■ 1050 W (AC) ■ 1050 W (DC) ■ 1600 W (AC) ■ 2300 W (AC) One power supply is mandatory; one more can be added for 1 + 1 redundancy.
Front Panel	A front panel controller provides status indications and control buttons.
ACPI	This server supports the advanced configuration and power interface (ACPI) 6.2 standard.
Fans	Six hot-swappable fans for front-to-rear cooling
Infiniband	The InfiniBand architecture is supported by the PCIe slots.

Capability/ Feature	Description
Expansion slots	<ul style="list-style-type: none"> ■ Riser 1A (3 PCIe slots) ■ Riser 1B (2 drive bays) ■ Riser 2A (3 PCIe slots) ■ Riser 3A (2 PCIe slots) ■ Riser 3B (2 drive bays) ■ Riser 3C (1 full-length, double-wide GPU)  <p>Note: Not all risers are available in every server configuration option.</p> <ul style="list-style-type: none"> ■ One or two dedicated slots (depending on the server type) for a SATA interposer or storage controller(s). ■ For more details on the variations of riser 1, riser 2, and riser 3, see Riser Card Configuration and Options, page 97.
Interfaces	<ul style="list-style-type: none"> ■ Rear panel <ul style="list-style-type: none"> • One 1Gbase-T RJ-45 management port • Two 10Gbase-T LOM ports • One RS-232 serial port (RJ45 connector) • One DB15 VGA connector • Two USB 3.0 port connectors • One flexible modular LAN on motherboard (mLOM) slot that can accommodate various interface cards ■ Front panel <ul style="list-style-type: none"> • One KVM console connector (supplies two USB 2.0 connectors, one VGA DB15 video connector, and one serial port (RS232) RJ45 connector)

Capability/ Feature	Description
Internal storage devices	<ul style="list-style-type: none"> ■ UCSC-C240-M6S (Option 1): <ul style="list-style-type: none"> • Up to 12 front SFF SAS/SATA hard drives (HDDs) or SAS/SATA solid state drives (SSDs). • Optionally, up to four front SFF NVMe PCIe SSDs. These drives must be placed in front drive bays 1, 2, 3, and 4 only. The rest of the bays (5 - 12) can be populated with SAS/SATA SSDs or HDDs. Two CPUs are required when choosing NVMe SSDs. • Optionally, one front-facing DVD drive • Optionally, up to two SFF rear-facing SAS/SATA/NVMe drives • If using a SATA Interposer, up to 8 SATA-only drives can be installed in slots 1-8. ■ UCSC-C240-M6SX (Option 2): <ul style="list-style-type: none"> • Up to 24 front SFF SAS/SATA hard drives (HDDs) or SAS/SATA solid state drives (SSDs). • Optionally, up to four front SFF NVMe PCIe SSDs. These drives must be placed in front drive bays 1, 2, 3, and 4 only. The rest of the bays (5 - 24) can be populated with SAS/SATA SSDs or HDDs. Two CPUs are required when choosing NVMe SSDs. • Optionally, up to four SFF rear-facing SAS/SATA/NVMe drives ■ UCSC-C240-M6N (Option 3): <ul style="list-style-type: none"> • Up to 12 front NVMe (only) drives • Optionally, up to 2 rear NVMe (only) drives • Two CPUs are required when choosing NVMe SSDs ■ UCSC-C240-M6SN (Option 4): <ul style="list-style-type: none"> • Up to 24 front NVMe drives (only). • Optionally, up to 2 rear NVMe drives (only) • Two CPUs are required when choosing NVMe SSDs <p>Other storage:</p> <ul style="list-style-type: none"> ■ A mini-storage module connector on the motherboard supports a boot-optimized RAID controller carrier that holds up to two SATA M.2 SSDs. Mixing different capacity SATA M.2 SSDs is not supported. ■ 8GB FlexMMC utility storage for staging of firmware and other user data. 8GB FlexMMC storage is built into the motherboard on M6.
Integrated management processor	<p>Baseboard Management Controller (BMC) running Cisco Integrated Management Controller (CIMC) firmware.</p> <p>Depending on your CIMC settings, the CIMC can be accessed through the 1GE dedicated management port, the 1GE/10GE OCP/mLOM ports, or a Cisco virtual interface card (VIC).</p> <p>CIMC manages certain components within the server, such as the Cisco 12G SAS HBA.</p>

Capability/Feature	Description
Storage controllers	<p>One SATA Interposer board, one 12G SAS RAID controller, or one or two 12G SAS HBAs plug into a dedicated slot.</p> <ul style="list-style-type: none"> ■ SATA Interposer board <ul style="list-style-type: none"> • AHCI support of up to eight SATA-only drives (slots 1-8 only) • Supported only on the UCSC-C240-M6S server ■ Cisco 12G RAID SAS RAID controller with 4GB FBWC (for UCSC-240-M6S server) <ul style="list-style-type: none"> • RAID support (RAID 0, 1, 5, 6, 10) and SRAID0 • Supports up to 16 internal SAS/SATA drives ■ Cisco M6 12G SAS RAID controller with 4GB FBWC (for UCSC-240-M6SX server) <ul style="list-style-type: none"> • RAID support (RAID 0, 1, 5, 6, 10) and SRAID0 • Supports up to 28 internal SAS/SATA drives ■ Cisco M6 12G SAS HBA (for UCSC-240-M6S and UCSC-240-M6SX servers) <ul style="list-style-type: none"> • No RAID support • JBOD/Pass-through Mode support • Each HBA supports up to 16 SAS/SATA internal drives
Modular LAN on Motherboard (mLOM) slot	<p>The dedicated mLOM slot on the motherboard can flexibly accommodate the following cards:</p> <ul style="list-style-type: none"> ■ Cisco Virtual Interface Cards
Intersight	Intersight provides server management capabilities
CIMC	Cisco Integrated Management Controller 4.2(1) or later

Notes:

1. If NVMe drives are selected, you must also select 2 CPUs.

CONFIGURING the SERVER

Follow these steps to configure the Cisco UCS C240 M6 SFF Rack Server:

- *STEP 1 VERIFY SERVER SKU, page 25*
- *STEP 2 SELECT RISER CARDS (REQUIRED), page 27*
- *STEP 3 SELECT CPU(s), page 28*
- *STEP 4 SELECT MEMORY, page 32*
- *STEP 5 SELECT DRIVE CONTROLLERS, page 39*
- *STEP 6 SELECT DRIVES, page 44*
- *STEP 7 SELECT OPTION CARD(s), page 50*
- *ORDER OPTIONAL PCIe OPTION CARD ACCESSORIES, page 54*
- *STEP 8 ORDER GPU CARDS (OPTIONAL), page 55*
- *STEP 9 ORDER POWER SUPPLY, page 58*
- *STEP 10 SELECT INPUT POWER CORD(s), page 60*
- *STEP 11 ORDER TOOL-LESS RAIL KIT AND OPTIONAL REVERSIBLE CABLE MANAGEMENT ARM, page 64*
- *STEP 12 SELECT MANAGEMENT CONFIGURATION (OPTIONAL), page 65*
- *STEP 13 SELECT SERVER BOOT MODE (OPTIONAL), page 66*
- *STEP 14 ORDER SECURITY DEVICES (OPTIONAL), page 67*
- *STEP 15 SELECT LOCKING SECURITY BEZEL (OPTIONAL), page 68*
- *STEP 16 ORDER OPTICAL DRIVE (OPTIONAL), page 69*
- *STEP 17 ORDER M.2 SATA SSDs (OPTIONAL), page 70*
- *STEP 18 SELECT OPERATING SYSTEM AND VALUE-ADDED SOFTWARE, page 72*
- *STEP 19 SELECT OPERATING SYSTEM MEDIA KIT, page 76*
- *STEP 20 SELECT SERVICE and SUPPORT LEVEL, page 77*

STEP 1 VERIFY SERVER SKU

Top level ordering product ID (PID) is shown in [Table 2](#)

Table 2 Top level ordering PID (major line bundle)

Product ID (PID)	Description
UCS-M6-MLB	UCS M6 Rack, Blade, Chassis MLB This major line bundle (MLB) consists of the Rack Server (UCSC-C240-M6S, UCSC-C240-M6S, UCSC-C240-M6N, or UCSC-C240-M6SN) with software PIDs. Use this PID to begin a new configuration.

Select one server product ID (PID) from [Table 3](#).

Table 3 PID of the C240 M6 SFF Rack Base Server

Product ID (PID)	Description
UCSC-C240-M6S ¹ (Option 1)	Small form-factor (SFF) drives, with 12-drive backplane. <ul style="list-style-type: none"> ■ Front-loading drive bays 1–12 support 2.5-inch SAS/SATA drives. ■ Optionally, front-loading drive bays 1, 2, 3, and 4 support 2.5-inch NVMe SSDs. ■ Optionally, 2 rear facing SAS/SATA/NVMe drives ■ No CPU, memory, drives, PCIe cards, or power supply included
UCSC-C240-M6SX ¹ (Option 2)	Small form-factor (SFF) drives, with 24-drive backplane. <ul style="list-style-type: none"> ■ Front-loading drive bays 1–24 support 2.5-inch SAS/SATA drives. ■ Optionally, front-loading drive bays 1, 2, 3, and 4 support 2.5-inch NVMe SSDs. ■ Optionally, 4 rear facing SAS/SATA/NVMe drives ■ No CPU, memory, drives, PCIe cards, or power supply included
UCSC-C240-M6N ¹ (Option 3)	Small form-factor (SFF) drives, with 12-drive backplane. <ul style="list-style-type: none"> ■ Front-loading drive bays 1–12 support 2.5-inch NVMe (only) drives. ■ Optionally, 2 rear facing NVMe (only) drives ■ No CPU, memory, drives, PCIe cards, or power supply included
UCSC-C240-M6SN ¹ (Option 4)	Small form-factor (SFF) drives, with 24-drive backplane. <ul style="list-style-type: none"> ■ Front-loading drive bays 1–24 support 2.5-inch NVMe (only) drives. ■ Optionally, 2 rear facing NVMe (only) drives ■ No CPU, memory, drives, PCIe cards, or power supply included

Notes:

1. This product may not be purchased outside of the approved bundles (must be ordered under the MLB)

The Cisco UCS C240 M6 SFF Server:

- Includes either a 24- or 12-drive backplane.



NOTE: The C240 M6 SFF server hard drive backplane is not field upgradeable. This means, for example, that you cannot “upgrade” from the 12-drive backplane version to the 24-drive backplane version. Likewise, the backplane is not field “downgradeable.”

- Does not include power supply, CPU, memory (DIMMs or PMem), hard disk drives (HDDs), solid-state drives (SSDs), NVMe drives, SD cards, riser 1, riser 2, riser 3, tool-less rail kit, or PCIe cards.



NOTE: Use the steps on the following pages to configure the server with the components that you want to include.

STEP 2 SELECT RISER CARDS (REQUIRED)

Select risers from [Table 4](#).

Table 4 PIDs of the Risers

Product ID (PID)	Description
UCSC-RIS1A-240M6 (default riser)	C240 M6 Riser1A (controlled with CPU1) <ul style="list-style-type: none"> ■ PCIe Slot 1 (bottom slot): full height, 3/4 length, x8, NCSI ■ PCIe Slot 2 (middle slot): full height, full length (GPU Card), x16, NCSI ■ PCIe Slot 3 (top slot): full height, full length, x8
UCSC-RIS1B-240M6 (storage riser)	C240 M6 Riser1B (controlled with CPU1) <ul style="list-style-type: none"> ■ Slot 1 is reserved ■ Slot 2 (middle slot, 2.5" drive bay 102), x4 ■ Slot 3 (top slot, 2.5" drive bay 101), x4
UCSC-RIS2A-240M6 (default riser)	C240 M6 Riser2A (controlled with CPU2) <ul style="list-style-type: none"> ■ Slot 4 (bottom slot): full height, 3/4 length, x8, NCSI ■ Slot 5 (middle slot): full height, full length (GPU Card), x16, NCSI ■ Slot 6 (top slot): full height, full length, x8
UCSC-RIS3A-240M6 (default riser)	C240 M6 Riser3A (controlled with CPU2) <ul style="list-style-type: none"> ■ Slot 7 (bottom slot): full height, full length, x8 ■ Slot 8 (top slot): full height, full length, x8
UCSC-RIS3B-240M6 (storage riser)	C240 M6 Riser 3B (controlled with CPU2) <ul style="list-style-type: none"> ■ Slot 7 (bottom slot, 2.5" drive bay 104), x4 ■ Slot 8 (top slot, 2.5" drive bay 103), x4
UCSC-RIS3C-240M6 (GPU riser)	C240 M6 Riser 3C (controlled with CPU2) <ul style="list-style-type: none"> ■ Slot 7 supports one full-height, full-length, double-wide GPU (PCIe slot 7 only), x16 ■ Slot 8 blocked by double-wide GPU



NOTE:

- Riser filler blank UCSC-FBRS2-C240M6 for riser 2 and UCSC-FBRS3-C240M6 for riser 3 is auto included, if riser 2 or riser 3 are not selected.
- CBL-RSASR1B-240M6 is auto included with selection of riser 1 and Raid controller (UCSC-SAS-240M6)
- CBL-RSASR3B-240M6 is auto included with selection of riser 3 and Raid controller (UCSC-SAS-240M6 or UCSC-RAID-M6SD).
- For additional details on riser cards, see [Riser Card Configuration and Options, page 97](#).

STEP 3 SELECT CPU(s)

The standard CPU features are:

- 3rd Gen Intel® Xeon® Scalable Processors (Ice Lake)
- Intel® C621A series chipset
- Cache size of up to 60 MB
- Up to 40 cores

Select CPUs

The available CPUs are listed in [Table 5](#). See [Table 6 on page 30](#) for CPU suffix notations

Table 5 Available CPUs

Product ID (PID)	Clock Freq (GHz)	Power (W)	Cache Size (MB)	Cores	UPI ¹ Links (GT/s)	Highest DDR4 DIMM Clock Support (MHz) ²	PMem Support
8000 Series Processors							
UCS-CPU-I8380	2.3	270	60	40	3 at 11.2	3200	Yes
UCS-CPU-I8368	2.4	270	57	38	3 at 11.2	3200	Yes
UCS-CPU-I8362	2.8	265	48	32	3 at 11.2	3200	Yes
UCS-CPU-I8360Y	2.4	250	54	36	3 at 11.2	3200	Yes
UCS-CPU-I8358P	2.6	240	48	32	3 at 11.2	3200	Yes
UCS-CPU-I8358	2.6	250	48	32	3 at 11.2	3200	Yes
UCS-CPU-I8352M	2.3	185	48	32	3 at 11.2	3200	Yes
UCS-CPU-I8352Y	2.2	205	48	32	3 at 11.2	3200	Yes
UCS-CPU-I8352V	2.1	195	54	36	3 at 11.2	2933	Yes
UCS-CPU-I8352S	2.2	205	48	32	3 at 11.2	3200	Yes
UCS-CPU-I8351N ³	2.4	225	54	36	0	2933	Yes
6000 Series Processors							
UCS-CPU-I6354	3.0	205	39	18	3 at 11.2	3200	Yes
UCS-CPU-I6348	2.6	235	42	28	3 at 11.2	3200	Yes
UCS-CPU-I6346	3.1	205	36	16	3 at 11.2	3200	Yes
UCS-CPU-I6342	2.8	230	36	24	3 at 11.2	3200	Yes
UCS-CPU-I6338N	2.2	185	48	32	3 at 11.2	2666	Yes
UCS-CPU-I6338T	2.1	165	36	24	3 at 11.2	3200	Yes
UCS-CPU-I6338	2.0	205	48	32	3 at 11.2	3200	Yes
UCS-CPU-I6336Y	2.4	185	36	24	3 at 11.2	3200	Yes
UCS-CPU-I6334	3.6	165	18	8	3 at 11.2	3200	Yes
UCS-CPU-I6330N	2.2	165	42	28	3 at 11.2	2666	Yes
UCS-CPU-I6330	2.0	205	42	28	3 at 11.2	2933	Yes

Table 5 Available CPUs

Product ID (PID)	Clock Freq (GHz)	Power (W)	Cache Size (MB)	Cores	UPI ¹ Links (GT/s)	Highest DDR4 DIMM Clock Support (MHz) ²	PMem Support
UCS-CPU-I6326	2.9	185	24	16	3 at 11.2	3200	Yes
UCS-CPU-I6314U ⁴	2.3	205	48	32	0	3200	Yes
UCS-CPU-I6312U ⁵	2.4	185	36	24	0	3200	Yes
5000 Series Processors							
UCS-CPU-I5320T	2.3	150	30	20	3 at 11.2	2933	Yes
UCS-CPU-I5320	2.2	185	39	26	3 at 11.2	2933	Yes
UCS-CPU-I5318N	2.1	150	36	24	3 at 11.2	2666	Yes
UCS-CPU-I5318S	2.1	165	36	24	3 at 11.2	2933	Yes
UCS-CPU-I5318Y	2.1	165	36	24	3 at 11.2	2933	Yes
UCS-CPU-I5317	3.0	150	18	12	3 at 11.2	2933	Yes
UCS-CPU-I5315Y	3.2	140	12	8	3 at 11.2	2933	Yes
4000 Series Processors							
UCS-CPU-I4316	2.3	150	30	20	2 at 10.4	2666	No
UCS-CPU-I4314	2.4	135	24	16	2 at 10.4	2666	Yes
UCS-CPU-I4310T	2.3	105	15	10	2 at 10.4	2666	No
UCS-CPU-I4310	2.1	120	18	12	2 at 10.4	2666	No
UCS-CPU-I4309Y	2.8	105	12	8	2 at 10.4	2666	No

Notes:

1. UPI = Ultra Path Interconnect.
2. If higher or lower speed DIMMs are selected than what is shown in [Table 7 on page 33](#) for a given CPU speed, the DIMMs will be clocked at the lowest common denominator of CPU clock and DIMM clock.
3. The maximum number of UCS-CPU-I8351N CPUs is one
4. The maximum number of UCS-CPU-I6314U CPUs is one
5. The maximum number of UCS-CPU-I6312U CPUs is one

**NOTE:**

- UCSC-HSHP-240M6 option is auto included with selection of the processor

Table 6 CPU Suffixes

CPU Suffix	Description	Features
N	Networking Optimized	Optimized for use in networking applications like L3 forwarding, 5G UPF, OVS DPDK, VPP FIB router, VPP IPsec, web server/NGINX, vEPC, vBNG, and vCMTS. SKUs have higher base frequency with lower TDPs to enable best performance/Watt
P	Cloud Optimized	SKU specifically designed for cloud IaaS environments to deliver higher frequencies at constrained TDPs
V	Cloud Optimized	SKUs specifically designed for cloud environments to deliver high rack density and maximize VM/cores per TCO\$
T	High T case	SKUs designed for Network Environment-Building System (NEBS) environments
U	1-socket Optimized	Optimized for targeted platforms adequately served by the cores, memory bandwidth and IO capacity available from a single processor
S	Max SGX enclave size	Supports Max SGX enclave size (512GB) to enhance and protect the most sensitive portions of a workload or service
M	Media and AI optimized	Media, AI and HPC Segment Optimized for lower TDP & higher frequencies delivering better perf/w
Y	Speed Select - Performance Profile	Intel® Speed Select Technology provides the ability to set a guaranteed base frequency for a specific number of cores, and assign this performance profile to a specific application/workload to guarantee performance requirements. It also provides the ability to configure settings during runtime and provide additional frequency profile configuration opportunities.



CAUTION: For systems configured with 3rd Gen Intel® Xeon® Scalable Processors (Ice Lake) operating above 28° C [82.4° F], a fan fault or executing workloads with extensive use of heavy instructions sets such as Intel® Advanced Vector Extensions 512 (Intel® AVX-512), may assert thermal and/or performance faults with an associated event recorded in the System Event Log (SEL).

If an NVIDIA A10 or A100 GPU is installed or rear HDDs are installed, the 28° C [82.4° F] restriction changes to 25° C [77° F]

Supported Configurations

(1) DIMM only configurations:

- Select one or two identical CPUs listed in [Table 5 on page 28](#)

(2) DIMM/PMem Mixed Configurations:

- You must select two identical CPUs listed in [Table 5 on page 28](#)

(3) Configurations with NVMe PCIe drives (either all NVMe drives or mixed NVMe/SAS/SATA):

- You must select two identical CPUs listed in [Table 5 on page 28](#)

(4) One-CPU Configuration

- Choose one CPU from any one of the rows of [Table 5 Available CPUs, page 28](#)

(5) Two-CPU Configuration

- Choose two identical CPUs from any one of the rows of [Table 5 Available CPUs, page 28](#)



NOTE:

- You cannot have two I8351N or two I6314U or I6312U CPUs in a two-CPU configuration.
 - If you configure a server with one I8351N CPU or one I6314U CPU or one I6312U CPU you cannot later upgrade to a 2-CPU system with two of these CPUs.
-

Caveats

- The selection of 1 or 2 CPUs depends on the desired server functionality. See the following sections:
 - [STEP 4 SELECT MEMORY, page 32](#)
 - [STEP 5 SELECT DRIVE CONTROLLERS, page 39](#)
 - [STEP 6 SELECT DRIVES, page 44](#)
 - [STEP 7 SELECT OPTION CARD\(s\), page 50](#)

STEP 4 SELECT MEMORY

The available memory main characteristics for the C240 M6 SFF are as follows:

- Clock speed: 3200 MHz
- Ranks per DIMM: 1, 2, 4, or 8
- Operational voltage: 1.2 V
- Registered ECC DDR4 DIMMs (RDIMMs), Load-reduced DIMMs (LRDIMMs), or Intel® Optane™ Persistent Memory Modules (PMem).

Memory is organized with eight memory channels per CPU, with up to two DIMMs per channel, as shown in *Figure 11*.

Figure 11 C240 M6 SFF Memory Organization

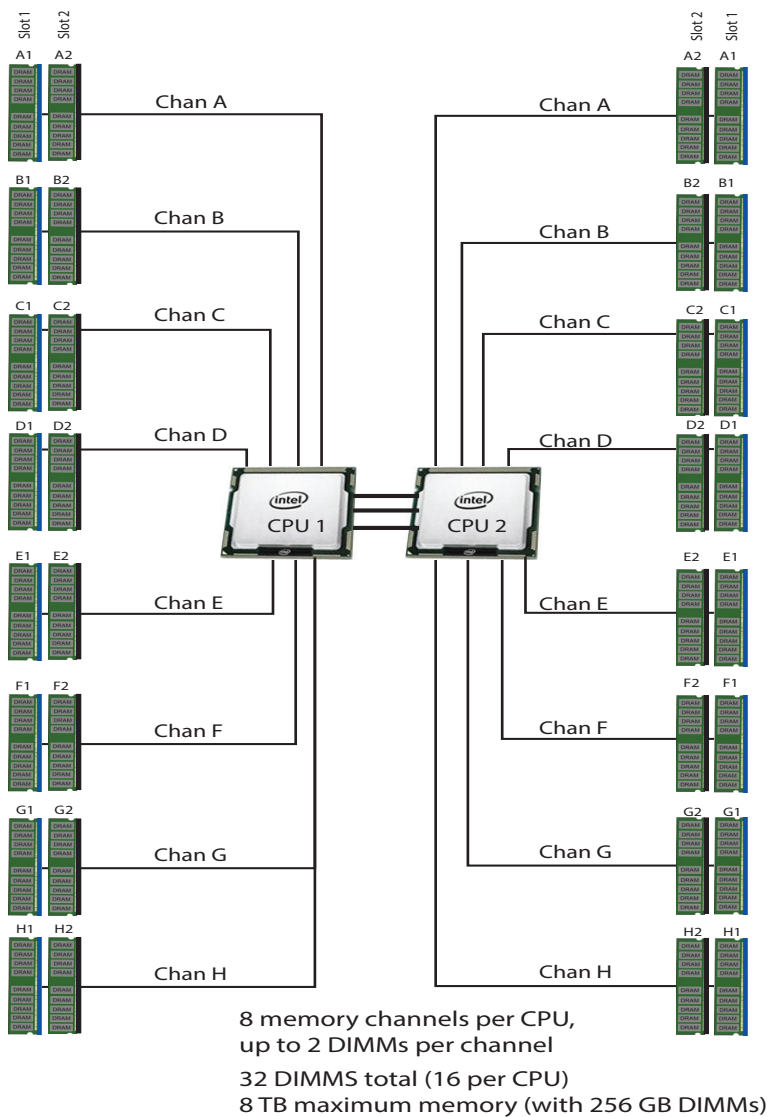

Select DIMMs and Memory Mirroring

Select the memory configuration and whether or not you want the memory mirroring option. The available memory DIMMs and mirroring option are listed in [Table 7](#).



NOTE: When memory mirroring is enabled, the memory subsystem simultaneously writes identical data to two channels. If a memory read from one of the channels returns incorrect data due to an uncorrectable memory error, the system automatically retrieves the data from the other channel. A transient or soft error in one channel does not affect the mirrored data, and operation continues unless there is a simultaneous error in exactly the same location on a DIMM and its mirrored DIMM. Memory mirroring reduces the amount of memory available to the operating system by 50% because only one of the two populated channels provides data.

Table 7 Available DDR4 DIMMs

Product ID (PID)	PID Description	Voltage	Ranks /DIMM
3200-MHz DIMMs			
UCS-MR-X16G1RW	16 GB RDIMM SRx4 3200 (8Gb)	1.2 V	1
UCS-MR-X32G1RW	32 GB RDIMM SRx4 3200 (16Gb)	1.2 V	1
UCS-MR-X32G2RW	32 GB RDIMM DRx4 3200 (8Gb)	1.2 V	2
UCS-MR-X64G2RW	64 GB RDIMM DRx4 3200 (16Gb)	1.2 V	2
UCS-ML-128G4RW	128 GB LRDIMM QRx4 3200 (16Gb) (non 3DS)	1.2 V	4
UCS-ML-256G8RW ^{1,2}	256 GB LRDIMM 8Rx4 3200 (16Gb) (3Ds)	1.2 V	8
Intel® Optane™ Persistent Memory (PMem)³			
UCS-MP-128GS-B0	Intel® Optane™ Persistent Memory, 128GB, 3200 MHz		
UCS-MP-256GS-B0	Intel® Optane™ Persistent Memory, 256 GB, 3200 MHz		
UCS-MP-512GS-B0	Intel® Optane™ Persistent Memory, 512 GB, 3200 MHz		
DIMM Blank⁴			
UCS-DIMM-BLK	UCS DIMM Blank		
Intel® Optane™ Persistent Memory (PMem) Operational Modes			
UCS-DCPMM-AD	App Direct Mode		
UCS-DCPMM-MM	Memory Mode		
Memory Mirroring Option			
N01-MMIRROR	Memory mirroring option		

Notes:

1. 256 GB DIMM is available on all C240M6 server models, with the exclusion of C240M6 LFF model.
2. 256 GB DIMMs cannot be combined with GPU cards, and the ambient temperature shall be limited to a maximum of 28°C.
3. All 3rd Generation Intel® Xeon® Scalable Processors (Ice Lake) support PMem products, except 4309Y, 4310, 4310T, and 4316 processor.
4. Any empty DIMM slot must be populated with a DIMM blank to maintain proper cooling airflow.

Memory Configurations, Features, and Modes

System speed is dependent on the CPU DIMM speed support. Refer to [Available CPUs, page 28](#) for DIMM speeds.

- The server supports the following memory reliability, availability, and serviceability (RAS) BIOS options (only one option can be chosen):
 - Adaptive Double Device Data Correction (ADDDC) (default)
 - Maximum performance
 - Full mirroring
 - Partial mirroring
- For best performance, observe the following:
 - When one DIMM is used, it must be populated in DIMM slot 1 (farthest away from the CPU) of a given channel.
 - When single- or dual-rank DIMMs are populated in two DIMMs per channel (2DPC) configurations, always populate the higher number rank DIMM first (starting from the farthest slot). For a 2DPC example, first populate with dual-rank DIMMs in DIMM slot 1. Then populate single-rank DIMMs in DIMM 2 slot.
- DIMMs for CPU 1 and CPU 2 (when populated) must always be configured identically.
- Cisco memory from previous generation servers (DDR3 and DDR4) is not compatible with the server.
- Memory can be configured in any number of DIMMs as pairs, although for optimal performance, see the document at the following link

[Cisco UCS C220/C240/B200 M6 Memory Guide](#)

- For detailed Intel® Optane™ Persistent Memory (PMem) configurations, refer to

https://www.cisco.com/content/en/us/td/docs/unified_computing/ucs/c/hw/c240m6/install/b-c240-m6-install-guide.html

Approved Configurations

(1) 1-CPU configuration without memory mirroring:

- Select from 1 to 16 DIMMs.
 - 1, 2, 4, 6, 8, 12, or 16 DIMMs allowed
 - 3, 5, 7, 9, 10, 11, 13, 14, 15 DIMMs not allowed
 - DIMMs for both CPUs must be configured identically.

The DIMMs will be placed by the factory as shown in the following tables.

# DIMMs Per CPU	CPU 1 DIMM Placement in Channels (for identically ranked DIMMs)
1	(A1)
2	(A1, E1)
4	(A1, C1); (E1, G1)
6	(A1, C1); (D1, E1); (G1, H1)
8	(A1, C1); (D1, E1); (G1, H1); (B1, F1)
12	(A1, C1); (D1, E1); (G1, H1); (A2, C2); (D2, E2); (G2, H2)
16	(A1, B1); (C1, D1); (E1, F1); (G1, H1); (A2, B2); (C2, D2); (E2, F2); (G2, H2)

(2) 1-CPU configuration with memory mirroring:

- Select 8 or 16 DIMMs per CPU (DIMMs for all CPUs must be configured identically). In addition, the memory mirroring option (N01-MMIRROR) as shown in [Table 7 on page 33](#) must be selected.

The DIMMs will be placed by the factory as shown in the following tables.

# DIMMs Per CPU	CPU 1 DIMM Placement in Channels (for identical ranked DIMMs)
8	(A1, C1); (D1, E1); (G1, H1); (B1, F1)
16	(A1, B1); (C1, D1); (E1, F1); (G1, H1); (A2, B2); (C2, D2); (E2, F2); (G2, H2)

- Select the memory mirroring option (N01-MMIRROR) as shown in [Table 7 on page 33](#).

(3) 2-CPU configuration without memory mirroring:

- Select from 1 to 16 DIMMs per CPU.
 - 1, 2, 4, 6, 8, 12, or 16 DIMMs allowed
 - 3, 5, 7, 9, 10, 11, 13, 14, 15 DIMMs not allowed
 - DIMMs for both CPUs must be configured identically.

The DIMMs will be placed by the factory as shown in the following tables.

# DIMMs Per CPU	CPU 1 DIMM Placement in Channels (for identically ranked DIMMs)	CPU 2 DIMM Placement in Channels (for identically ranked DIMMs)
1	(A1)	(A1)
2	(A1, E1)	(A1, E1)
4	(A1, C1); (E1, G1)	(A1, C1); (E1, G1)
6	(A1, C1); (D1, E1); (G1, H1)	(A1, C1); (D1, E1); (G1, H1)
8	(A1, C1); (D1, E1); (G1, H1); (B1, F1)	(A1, C1); (D1, E1); (G1, H1); (B1, F1)
12	(A1, C1); (D1, E1); (G1, H1); (A2, C2); (D2, E2); (G2, H2)	(A1, C1); (D1, E1); (G1, H1); (A2, C2); (D2, E2); (G2, H2)
16	(A1, B1); (C1, D1); (E1, F1); (G1, H1); (A2, B2); (C2, D2); (E2, F2); (G2, H2)	(A1, B1); (C1, D1); (E1, F1); (G1, H1); (A2, B2); (C2, D2); (E2, F2); (G2, H2)

(4) 2-CPU configuration with memory mirroring:

- Select 8 or 16 DIMMs per CPU (DIMMs for all CPUs must be configured identically). In addition, the memory mirroring option (N01-MMIRROR) as shown in [Table 7 on page 33](#) must be selected.

The DIMMs will be placed by the factory as shown in the following tables.

# DIMMs Per CPU	CPU 1 DIMM Placement in Channels (for identical ranked DIMMs)	CPU 2 DIMM Placement in Channels (for identically ranked DIMMs)
8	(A1, C1); (D1, E1); (G1, H1); (B1, F1)	(A1, C1); (D1, E1); (G1, H1); (B1, F1)
16	(A1, B1); (C1, D1); (E1, F1); (G1, H1); (A2, B2); (C2, D2); (E2, F2); (G2, H2)	(A1, B1); (C1, D1); (E1, F1); (G1, H1); (A2, B2); (C2, D2); (E2, F2); (G2, H2)

- Select the memory mirroring option (N01-MMIRROR) as shown in [Table 7 on page 33](#).



NOTE: System performance is optimized when the DIMM type and quantity are equal for both CPUs, and when all channels are filled equally across the CPUs in the server.

Table 8 3200-MHz DIMM Memory Speeds with Different Intel® Xeon® Ice Lake® Processors

DIMM and CPU Frequencies (MHz)	DPC	LRDIMM (8Rx4)- 256 GB (MHz)	LRDIMM (4Rx4)- 128 GB (MHz)	RDIMM (2Rx4) - 64 GB (MHz)	RDIMM (2Rx4) - 32 GB (MHz)	RDIMM (1Rx4) - 16 GB (MHz)
		1.2 V	1.2 V	1.2 V	1.2 V	1.2 V
DIMM = 3200 CPU = 3200	1DPC	3200	3200	3200	3200	3200
	2DPC	3200	3200	3200	3200	3200
DIMM = 3200 CPU = 2933	1DPC	2933	2933	2933	2933	2933
	2DPC	2933	2933	2933	2933	2933
DIMM = 3200 CPU = 2666	1DPC	2666	2666	2666	2666	2666
	2DPC	2666	2666	2666	2666	2666

DIMM Rules

- Allowed DIMM count for 1 CPU:
 - Minimum DIMM count = 1; Maximum DIMM count = 16
 - 1, 2, 4, 6, 8, 12, or 16 DIMMs allowed
 - 3, 5, 7, 9, 10, 11, 13, 14, or 15 DIMMs not allowed.
- Allowed DIMM count for 2 CPUs
 - Minimum DIMM count = 2; Maximum DIMM count = 32
 - 2, 4, 8, 12, 16, 24, or 32 DIMMs allowed
 - 6, 10, 14, 18, 20, 22, 26, 28, or 30 DIMMs not allowed.
- DIMM Mixing:
 - Mixing different types of DIMM (RDIMM with any type of LRDIMM or 3DS LRDIMM with non-3DS LRDIMM) is not supported within a server.
 - Mixing RDIMM with RDIMM types is allowed if they are mixed in same quantities, in a balanced configuration.
 - Mixing 16 GB, 32 GB, and 64 GB RDIMMs is supported.
 - 128 GB and 256 GB LRDIMMs cannot be mixed with other RDIMMs
 - 128 GB non-3DS LRDIMMs cannot be mixed with 256 GB 3DS LRDIMMs



NOTE: DIMM mixing is not allowed when PMem are installed; in these cases, all DIMMs must be the same type and size.

See the detailed mixing DIMM configurations at the following link
[Cisco UCS C220/C240/B200 M6 Memory Guide](#)

See [Table 9](#) for PMem memory modes.

Table 9 Intel® Optane™ Persistent Memory Modes

Intel® Optane® Persistent Memory Modes	
App Direct Mode:	PMem operates as a solid-state disk storage device. Data is saved and is non-volatile. Both PMem and DIMM capacities count towards the CPU capacity limit.
Memory Mode:	PMem operates as a 100% memory module. Data is volatile and DRAM acts as a cache for PMem. Only the PMem capacity counts towards the CPU capacity limit. This is the factory default mode.

Table 10 3rd Gen Intel® Xeon® Scalable Processors (Ice Lake) Allowable Mixed DIMM/PMem¹ Physical Configurations (per socket)

DIMM + PMem Count	CPU 1 or CPU 2															
	ICX: IMC2				ICX: IMC3				ICX: IMC1				ICX: IMC0			
	Chan 0 (F)		Chan 1 (E)		Chan 0 (H)		Chan 1 (G)		Chan 0 (C)		Chan 1 (D)		Chan 0 (A)		Chan 1 (B)	
	Slot 1	Slot 2	Slot 1	Slot 2	Slot 1	Slot 2	Slot 1	Slot 2	Slot 2	Slot 1	Slot 2	Slot 1	Slot 2	Slot 1	Slot 2	Slot 1
4 + 4 ²	PMem		DIMM		PMem		DIMM			DIMM		PMem		DIMM		PMem
8 + 1 ³	DIMM		DIMM		DIMM		DIMM			DIMM		DIMM	PMem	DIMM		DIMM
8 + 4 ⁴	DIMM		DIMM	PMem	DIMM		DIMM	PMem	PMem	DIMM		DIMM	PMem	DIMM		DIMM
8 + 8 ⁵	DIMM	PMem	DIMM	PMem	DIMM	PMem	DIMM	PMem	PMem	DIMM	PMem	DIMM	PMem	DIMM	PMem	DIMM

NOTE: AD = App Direct Mode, MM = Memory Mode

Notes:

1. All systems must be fully populated with two CPUs when using PMem at this time.
2. AD, MM
3. AD
4. AD, MM
5. AD, MM

For detailed Intel PMem configurations, refer to

https://www.cisco.com/content/en/us/td/docs/unified_computing/ucs/c/hw/c240m6/install/b-c240-m6-install-guide.html

For detailed DIMM/PMem information, refer to

[Cisco UCS C220/C240/B200 M6 Memory Guide](#)

STEP 5 SELECT DRIVE CONTROLLERS

The following list summarizes how drives are controlled on the server:

- Servers with only SATA drives are controlled by the Intel C621 PCH through the SATA Interposer (AHCI), or
- SAS/SATA drives are controlled through one Cisco 12G RAID controller, or
- SAS/SATA drives are controlled through one or two Cisco 12G SAS pass-through HBAs
- PCIe drives are controlled directly from the CPUs

AHCI with SATA Interposer

The default configuration is Advanced Host Control Interface (AHCI), which supports SATA-only drives in a non-RAID configuration. A maximum of 8 SATA drives are supported with AHCI and this configuration requires a SATA interposer board, which plugs directly into the drive backplane. The SATA Interposer supports drives in slots 1-8.



NOTE: AHCI is limited to Windows and Linux operating systems only. There is no VMware support for AHCI.

Cisco 12G SAS RAID Controller



NOTE: This RAID controller is used in the UCSC-C240-M6S server

This RAID controller supports up to 16 SAS or SATA drives (the UCSC-C240-M6S server has 12 in front and 2 in rear) operating at 3 Gbs, 6 Gbs, and 12Gbs. It includes a SuperCap for a 4 GB flash-back write cache (FBWC) and supports RAID 0, 1, 5, 6, 10, 50, 60, JBOD mode, and SRAID0. The RAID controller plugs into a dedicated slot.



NOTE: 64 RAID groups (virtual drives) are supported with this RAID controller.

Cisco M6 12G SAS RAID Controller with 4 GB FBWC



NOTE: This RAID controller is used in the UCSC-C240-M6SX server

This RAID controller supports up to 28 SAS or SATA drives (the UCSC-C240-M6SX server has 24 front drives and 4 rear drives). It includes a SuperCap for a 4 GB flash-back write cache (FBWC) and supports RAID 0, 1, 5, 6, 10, 50, 60, JBOD mode, and SRAID0. The RAID controller plugs into a dedicated slot.



NOTE: 64 RAID groups (virtual drives) are supported with this RAID controller.

Cisco 12G SAS HBA



NOTE:

- This RAID controller is used in the UCSC-C240-M6S and UCSC-C240-M6SX servers
 - SAS HBA supports 28 drives and requires 2 quantity.
-

This HBA supports up to 16 SAS or SATA drives (the UCSC-C240-M6S server has 12 front drives and 2 rear drives and the UCSC-C240-M6SX server has 24 front drives and 2 or 4 rear drives) operating at 3 Gbs, 6 Gbs, and 12Gbs. It supports JBOD or pass-through mode (not RAID) and plugs directly into the drive backplane. Two of these controllers are required to control 24 front drives and 2 or 4 rear drives.

RAID Volumes and Groups

When creating each RAID volume, follow these guidelines:

- Use the same capacity for each drive in each RAID volume
- For the Cisco 12G RAID controllers, use either all SAS HDDs, or all SAS SSDs, or all SATA SSDs in each RAID volume

Select RAID Controller Options

If you do not want the default AHCI 8 SATA-only drive setup (8 internal drives in drive bays 1-8 and 2 SATA M.2 drives), select one of the following:

- Cisco 12G RAID controller (see [Table 11](#)), or
- Cisco 12G SAS HBA (see [Table 11](#))



NOTE:

- The default solution is AHCI, which supports a limited number of drives, operating systems, and virtualized environments. For a more comprehensive solution, choose a controller from [Table 11](#).
- vSAN HCL listed/qualified component is UCSC-SAS-M6T (UCSC-SAS-240M6).

Table 11 Hardware Controller Options

Product ID (PID)	PID Description
Controllers for Internal Drives	
Note that if a Cisco 12G SAS RAID controller, Cisco M6 12G SAS RAID controller, or Cisco 12G SAS HBA is selected, it is factory-installed in the drive backplane connector.	
UCSC-RAID-240M6	Cisco 12G SAS RAID controller SuperCap and 4GB FBWC (for UCSC-C240-M6S server) <ul style="list-style-type: none"> ■ Supports up to 16 internal SAS HDDs and SAS/SATA SSDs. ■ Supports RAID 0, 1, 5, 6, 10, 50, 60, and JBOD mode. Supports mixed RAID and JBOD mode. ■ For all self-encrypting drives (SED), standalone Management (CIMC/UCSM) is supported for configuring and managing local keys. For now, SED drives are managed with local key management only. Third-party key management will be supported (KMIP compliant).
UCSC-RAID-M6SD	Cisco M6 12G SAS RAID controller with SuperCap and 4GB FBWC (for UCSC-C240-M6SX server) <ul style="list-style-type: none"> ■ Supports up to 28 internal SAS HDDs and SAS/SATA SSDs. ■ Supports RAID 0, 1, 5, 6, 10, 50, 60, and JBOD mode. Supports mixed RAID and JBOD mode. ■ For all self-encrypting drives (SED), standalone Management (CIMC/UCSM) is supported for configuring and managing local keys. For now, SED drives are managed with local key management only. Third-party key management will be supported (KMIP compliant).
UCSC-SAS-240M6	Cisco 12G SAS HBA (for UCSC-C240-M6S and UCSC-C240-M6SX servers) ¹ <ul style="list-style-type: none"> ■ Supports up to 16 internal SAS HDDs and SAS/SATA SSDs ■ Supports 28 internal SAS HDDs and SAS/SATA SSDs and requires 2 quantity. ■ Supports JBOD or pass-through mode
SATA Interposer	

Table 11 Hardware Controller Options (*continued*)

Product ID (PID)	PID Description
UCSC-SATAIN-220M6	SATA Interposer (for control of up to 8 SATA-only drives using AHCI). Only used in the UCSC-C240-M6S server.
Supercap	
UCS-SCAP-M6	M6 Supercap for write cache backup
RAID Configuration Options (not available for Cisco 12G SAS HBA or AHCI)	
R2XX-SRAID0	Enable single disk RAID 0 Setting.
R2XX-RAID0	Factory preconfigured RAID striping option Enable RAID 0 Setting. Requires two or more hard drive.s
R2XX-RAID1	Factory preconfigured RAID mirroring option Enable RAID 1 Setting. Requires two or more drives with the same size, speed, capacity.
R2XX-RAID5	Factory preconfigured RAID option Enable RAID 5 Setting. Requires a minimum of three drives of the same size, speed, capacity.
R2XX-RAID6	Factory preconfigured RAID option Enable RAID 6 Setting. Requires a minimum of four drives of the same size, speed, capacity.
R2XX-RAID10	Factory preconfigured RAID option Enable RAID 10 Setting. Requires a even number of drives (minimum of four drives) of the same size, speed, capacity.

Notes:

- Two of these controllers are required to control 24 front drives and four rear drives

**NOTE:**

- CBL-SAS24-240M6 and CBL-SAS12-240M6 included with the selection of UCSC-SAS-240M6 drive controller.
- CBL-SDSAS-240M6 and UCS-SCAP-M6 is included with the selection of UCSC-RAID-M6SD drive controller.
- if you are adding drive controller later as spare, you may need to order cables and super cap/cables with it.

Approved Configurations

The C240 M6 SFF server can be ordered as follows:

- UCSC-C240-M6S (12-drive SAS/SATA and 4 optionally of those can be NVMe)
- UCSC-C240 M6SX (24-drive SAS/SATA backplane and optionally 4 of those can be NVMe)
- UCSC-C240-M6N (12-drive NVMe only)
- UCSC-C240-M6SN (24-drive NVMe only)
- There is no RAID support for NVMe drives.
- In a configuration with a SATA Interposer and AHCI control, only 8 SATA-only drives (8 internal in drive bays 1-8) can be installed (no RAID support).

STEP 6 SELECT DRIVES

The standard disk drive features are:

- 2.5-inch small form factor
- Hot-pluggable
- Drives come mounted in sleds



NOTE: If NVMe SSDs are selected, you must also select 2 CPUs.

Select Drives

The available drives are listed in [Table 12](#).

Table 12 Available Hot-Pluggable Sled-Mounted Drives
(UCSC-C240-M6S (12-drive system), UCSC-C240-M6SX (24-drive system), UCSC-C240-M6N (12 NVMe only drive system), UCSC-C240M6SN (24 NVMe only drive system))

Product ID (PID)	PID Description	Drive Type	Capacity
HDDs			
HDDs (15K RPM)			
UCS-HD900G15K12N	900 GB 12G SAS 15K RPM SFF HDD	SAS	900 GB
UCS-HD300G15K12N	300 GB 12G SAS 15K RPM SFF HDD	SAS	300 GB
UCS-HD600G15K12N	600 GB 12G SAS 15K RPM SFF HDD	SAS	600 GB
HDDs (10K RPM)			
UCS-HD300G10K12N	300 GB 12G SAS 10K RPM SFF HDD	SAS	300 GB
UCS-HD600G10K12N	600 GB 12G SAS 10K RPM SFF HDD	SAS	600 GB
UCS-HD12TB10K12N	1.2 TB 12G SAS 10K RPM SFF HDD	SAS	1.2 TB
UCS-HD18TB10K4KN ¹	1.8 TB 12G SAS 10K RPM SFF HDD (4K)	SAS	1.8 TB
UCS-HD24TB10K4KN ¹	2.4 TB 12G SAS 10K RPM SFF HDD (4K)	SAS	2.4 TB
Enterprise Performance SAS/SATA SSDs (High endurance, supports up to 10X or 3X DWPD (drive writes per day))²			
UCS-SD19T63X-EP	1.9 TB 2.5in Enterprise performance 6GSATA SSD(3X endurance)	SATA	1.9 TB
UCS-SD960G63X-EP	960 GB 2.5in Enterprise performance 6GSATA SSD(3X endurance)	SATA	960 GB
UCS-SD480G63X-EP	480 GB 2.5in Enterprise Performance 6GSATA SSD(3X endurance)	SATA	480 GB
UCS-SD19TBM3X-EP	1.9TB 2.5in Enterprise performance 6GSATA SSD(3X endurance)	SATA	1.9 TB
UCS-SD960GBM3X-EP	960GB 2.5in Enterprise performance 6GSATA SSD(3X endurance)	SATA	960 GB
UCS-SD480GBM3X-EP	480GB 2.5in Enterprise Performance 6GSATA SSD(3X endurance)	SATA	480 GB
UCS-SD38T63X-EP	3.8TB 2.5in Enter Perf 6G SATA Intel SSD (3X)	SATA	3.8 TB
UCS-SD800GK3X-EP	800 GB 2.5in Enterprise Performance 12G SAS SSD(3X endurance)	SAS	800 GB
UCS-SD32TKA3X-EP	3.2TB 2.5in Enter Perf 12G SAS Kioxia G2 SSD (3X)	SAS	3.2 TB

Table 12 Available Hot-Pluggable Sled-Mounted Drives (continued)
 (UCSC-C240-M6S (12-drive system), UCSC-C240-M6SX (24-drive system), UCSC-C240-M6N (12 NVMe only drive system), UCSC-C240M6SN (24 NVMe only drive system))

Product ID (PID)	PID Description	Drive Type	Capacity
UCS-SD16TKA3X-EP	1.6TB 2.5in Enterprise Performance 12G SAS SSD(3X endurance)	SAS	1.6 TB
UCS-SD800GS3X-EP	800GB 2.5in Enter Perf 12G SAS Seagate SSD (3X)	SAS	800 GB
UCS-SD16TS3X-EP	1.6TB 2.5in Enter Perf 12G SAS Seagate SSD (3X)	SAS	1.6 TB
UCS-SD32TS3X-EP	3.2TB 2.5in Enter Perf 12G SAS Seagate SSD (3X)	SAS	3.2 TB
Enterprise Value SAS/SATA SSDs (Low endurance, supports up to 1X DWPD (drive writes per day))³			
UCS-SD38T611X-EV	3.8 TB 2.5 inch Enterprise Value 6G SATA SSD	SATA	3.8 TB
UCS-SD960G611X-EV	960 GB 2.5 inch Enterprise Value 6G SATA SSD	SATA	960 GB
UCS-SD480G611X-EV	480 GB 2.5 inch Enterprise Value 6G SATA SSD	SATA	480 GB
UCS-SD19T61X-EV	1.9 TB 2.5 inch Enterprise Value 6G SATA SSD	SATA	1.9 TB
UCS-SD38T61X-EV	3.8 TB 2.5 inch Enterprise Value 6G SATA SSD	SATA	3.8 TB
UCS-SD120GM1X-EV	120 GB 2.5 inch Enterprise Value 6G SATA SSD	SATA	120 GB
UCS-SD960GM1X-EV	960 GB 2.5 inch Enterprise Value 6G SATA SSD	SATA	960 GB
UCS-SD16TM1X-EV	1.6 TB 2.5 inch Enterprise Value 6G SATA SSD	SATA	1.6 TB
UCS-SD19TM1X-EV	1.9 TB 2.5 inch Enterprise Value 6G SATA SSD	SATA	1.9 TB
UCS-SD38TM1X-EV	3.8 TB 2.5 inch Enterprise Value 6G SATA SSD	SATA	3.8 TB
UCS-SD960G6S1X-EV	960GB 2.5 inch Enterprise Value 6G SATA SSD	SATA	960 GB
UCS-SD19T6S1X-EV	1.9TB 2.5 inch Enterprise Value 6G SATA SSD	SATA	1.9 TB
UCS-SD38T6S1X-EV	3.8TB 2.5 inch Enterprise Value 6G SATA SSD	SATA	3.8 TB
UCS-SD76T6S1X-EV	7.6TB 2.5 inch Enterprise Value 6G SATA SSD	SATA	7.6 TB
UCS-SD76TBM1X-EV	7.6TB 2.5 inch Enterprise Value 6G SATA SSD	SATA	7.6 TB
UCS-SD38TBM1X-EV	3.8TB 2.5 inch Enterprise Value 6G SATA SSD	SATA	3.8 TB
UCS-SD19TBM1X-EV	1.9TB 2.5 inch Enterprise Value 6G SATA SSD	SATA	1.9 TB
UCS-SD16TBM1X-EV	1.6TB 2.5 inch Enterprise Value 6G SATA SSD	SATA	1.6 TB
UCS-SD960GBM1X-EV	960GB 2.5 inch Enterprise Value 6G SATA SSD	SATA	960 GB
UCS-SD480GBM1X-EV	480GB 2.5 inch Enterprise Value 6G SATA SSD	SATA	480 GB
UCS-SD240GBM1X-EV	240GB 2.5 inch Enterprise Value 6G SATA SSD	SATA	240 GB
UCS-SD19TM1X-EV	1.9TB 2.5in Enter Value 6G SATA Micron G1 SSD	SATA	1.9 TB
UCS-SD960GK1X-EV	960 GB 2.5 inch Enterprise Value 12G SAS SSD	SAS	960 GB
UCS-SD15TKA1X-EV	15.3TB 2.5in Enter Value 12G SAS Kioxia G2 SSD	SAS	15.3 TB
UCS-SD76TKA1X-EV	7.6TB 2.5 inch Enterprise Value 12G SAS SSD	SAS	7.6 TB
UCS-SD38TKA1X-EV	3.8TB 2.5 inch Enterprise Value 12G SAS SSD	SAS	3.8 TB
UCS-SD19TKA1X-EV	1.9TB 2.5 inch Enterprise Value 12G SAS SSD	SAS	1.9 TB
Self-Encrypted Drives (SED)			
UCS-HD24T10NK9	2.4TB 10k rpm 4k SED HDD	SED	2.4 TB
UCS-HD18T10NK9	1.8 TB 12G SAS 10K RPM SFF HDD (4K format, SED)	SED	1.8 TB
UCS-HD12T10NK9	1.2TB 12G SAS 10K RPM SFF HDD (SED-FIPS)	SED	1.2 TB
UCS-HD600G15NK9	600 GB 12G SAS 15K RPM SFF HDD (SED)	SED	600 GB
UCS-SD800GBKNK9	800 GB Enterprise Performance SAS SSD (3X DWPD, SED)	SED	800 GB

Table 12 Available Hot-Pluggable Sled-Mounted Drives (continued)
 (UCSC-C240-M6S (12-drive system), UCSC-C240-M6SX (24-drive system), UCSC-C240-M6N (12 NVMe only drive system), UCSC-C240M6SN (24 NVMe only drive system))

Product ID (PID)	PID Description	Drive Type	Capacity
UCS-SD960GBKNK9	960 GB Enterprise Value SAS SSD (1X DWPD, SED)	SED	960 GB
UCS-SD76TBKNK9	7.6TB Enterprise value SAS SSD (1 DWPD, SED-FIPS)	SED-FIPS	7.6 TB
UCS-SD38TBKNK9	3.8 TB Enterprise Value SAS SSD (1X DWPD, SED)	SED	3.8 TB
UCS-SD76TEM2NK9	7.6TB Enterprise value SATA SSD (1X, SED)	SED	7.6 TB
UCS-SD960GM2NK9	960GB Enterprise value SATA SSD (1X , SED)	SED	960 GB
UCS-SD76TBKANK9	7.6TB Enterprise value SAS SSD (1 DWPD, SED-FIPS)	SED	7.6 TB
UCS-SD38TBKANK9	3.8TB 2.5in Enterprise value 12G SAS SSD (1DWPD, SED-FIPS)	SED	3.8 TB
UCS-SD16TBKANK9	1.6TB 2.5in Enter Perf 12G SAS Kioxia G2 SSD (3X SED-FIPS)	SED	1.6 TB
PCIe / NVMe (2.5-inch) SFF Drives⁴			
UCSC-NVMEXPB-I375	375 GB 2.5in Intel® Optane™ NVMe Extreme Performance SSD	NVMe	375 GB
UCSC-NVMEXP-I750	750 GB 2.5in Intel® Optane™ NVMe Extreme Perf.	NVMe	750 GB
UCS-NVMEI4-I1600	1.6 TB 2.5in U.2 Intel P5600 NVMe High Perf Medium Endurance	NVMe	1.6 TB
UCS-NVMEI4-I3200	3.2 TB 2.5in U.2 Intel P5600 NVMe High Perf Medium Endurance	NVMe	3.2 TB
UCS-NVMEXP-I400	400GB 2.5in U.2 Intel P5800X Optane NVMe Extreme Perform SSD	NVMe	400 GB
UCS-NVMEXP-I800	800GB 2.5in U.2Intel P5800X Optane NVMe Extreme Perform SSD	NVMe	800 GB
UCS-NVME4-1920	1.9TB 2.5in U.2 15mm P5520 Hg Perf Med End NVMe	NVMe	1,9 TB
UCS-NVME4-3840	3.8TB 2.5in U.2 15mm P5520 Hg Perf Med End NVMe	NVMe	3.8 TB
UCS-NVME4-7680	7.6TB 2.5in U.2 15mm P5520 Hg Perf Med End NVMe	NVMe	7.6 TB
UCS-NVME4-1536	15.3TB 2.5in U.2 15mm P5520 Hg Perf Med End NVMe	NVMe	15.3 TB
UCS-NVME4-1600	1.6TB 2.5in U.2 15mm P5620 Hg Perf Hg End NVMe (3X)	NVMe	1.6 TB
UCS-NVME4-3200	3.2TB 2.5in U.2 15mm P5620 Hg Perf Hg End NVMe (3X)	NVMe	3.2 TB
UCS-NVME4-6400	6.4TB 2.5in U.2 15mm P5620 Hg Perf Hg End NVMe (3X)	NVMe	6.4 TB
UCS-NVMEQ-1536	15.3TB 2.5in U.2 15mm P5316 Hg Perf Low End NVMe	NVMe	15.3 TB
UCS-NVMEM6-W3200	3.2 TB 2.5in U.2 WD SN840 NVMe Extreme Perf. High Endurance	NVMe	3.2 TB
UCS-NVMEM6-W7680	7.6 TB 2.5in U.2 WD SN840 NVMe Extreme Perf. Value Endurance	NVMe	7.6 TB
UCS-NVMEM6-W15300	15.3 TB 2.5in U.2 WD SN840 NVMe Extreme Perf. Value Endurance	NVMe	15.3 TB
UCS-NVMEG4-M960 ⁵	960GB 2.5in U.3 Micron P7450 NVMe High Perf Medium Endurance	NVMe	960 GB
UCS-NVMEG4-M1920 ⁵	1.9TB 2.5in U.3 Micron P7450 NVMe High Perf Medium Endurance	NVMe	1.9 TB
UCS-NVMEG4-M3840 ⁵	3.8TB 2.5in U.3 Micron P7450 NVMe High Perf Medium Endurance	NVMe	3.8 TB
UCS-NVMEG4-M7680 ⁵	7.6TB 2.5in U.3 Micron P7450 NVMe High Perf Medium Endurance	NVMe	7.6 TB
UCS-NVMEG4-M1536 ⁵	15.3TB 2.5in U.3 MicronP7450 NVMe High Perf Medium Endurance	NVMe	15.3 TB
UCS-NVMEG4-M1600 ⁵	1.6TB 2.5in U.3 Micron P7450 NVMe High Perf High Endurance	NVMe	1.6 TB
UCS-NVMEG4-M3200 ⁵	3.2TB 2.5in U.3 Micron P7450 NVMe High Perf High Endurance	NVMe	3.2 TB
UCS-NVMEG4-M6400 ⁵	6.4TB 2.5in U.3 Micron P7450 NVMe High Perf High Endurance	NVMe	6.4 TB

Table 12 Available Hot-Pluggable Sled-Mounted Drives (continued)
 (UCSC-C240-M6S (12-drive system), UCSC-C240-M6SX (24-drive system), UCSC-C240-M6N (12 NVMe only drive system), UCSC-C240M6SN (24 NVMe only drive system))

Product ID (PID)	PID Description	Drive Type	Capacity
<p>NOTE: Cisco uses solid state drives from a number of vendors. All solid state drives are subject to physical write limits and have varying maximum usage limitation specifications set by the manufacturer. Cisco will not replace any solid state drives that have exceeded any maximum usage specifications set by Cisco or the manufacturer, as determined solely by Cisco.</p>			

Notes:

- Operating Systems that support 4k sector size drives are as follows:
 - CentOS 7.9/8.2/8.3 (and later)
 - Windows Server 2016/2019 (and later)
 - Red Hat Enterprise Linux 7.9/8.2 (and later)
 - SUSE Linux Enterprise Server 15.2 (and later)
 - ESXi 6.7 U3/7.0 U2 (and later)
 - See this link for operating system guidance: <https://ucshcltool.cloudapps.cisco.com/public/>
 - UEFI Mode must be used when booting from 4K sector size drives (legacy mode is not supported).
 - Ensure that 4K sector size and 512 byte sector size drives are not mixed in the same RAID volume.
- Targeted for write centric IO applications. Supports endurance of 10 or 3 DWPD (drive writes per day). Target applications are caching, online transaction processing (OLTP), data warehousing, and virtual desktop infrastructure (VDI).
- Targeted for read centric IO applications. Supports endurance of 1 DWPD (drive write per day). Target applications are boot, streaming media, and collaboration.
- Except HGST, Intel and WD NVMe drives can be mixed.
- Rear drive slots are not supported for the U.3 NVMe drives.

	<p>NOTE:</p> <ul style="list-style-type: none"> ■ When you order front-facing NVMe drives with or without raid controller (12G SAS HBA or UCSC-RAID-M6SD), an NVMe cable (PID: CBL-FNVME-240M6) is included along with the drives. ■ If you decide to add front-facing NVMe drives later, you may need to order the drives as spare and also an spare NVMe cable (PID: CBL-FNVME-240M6=) this each PID includes two cables: <ul style="list-style-type: none"> • This cable plugs into NVMe-C on MB side, and NVMe-C on BP side and controls drives 1-2. • This cable plugs into NVMe-D on MB side, and NVMe-D on BP side and controls drives 3-4. ■ If you are adding a rear NVMe drive later, you may need to order the storage riser (UCSC-RIS1B-240M6/UCSC-RIS3B-240M6) and cables with it. <p>See for <i>SPARE PARTS, page 104</i> section for all the spare components and required other parts with it.</p>
---	---

Caveats

- You can choose only SATA SSDs or M.2 SATA drives when using AHCI with a SATA Interposer.

- Front SFF NVMe drives are connected directly to CPU2, and are not managed by any drive controller.
- Raid Controller is not required with rear NVMe drives.
- You can mix HDDs and SSDs as long as you keep all HDDs in their own RAID volume and all SSDs in their own RAID volume.
- You can mix SAS HDDs and SAS/SATA SSDs when using a Cisco 12G SAS RAID Controller or Cisco 12G SAS HBA.
- If you order any front SFF NVMe drives, you must also order two CPUs.
- SFF NVMe drives are bootable in UEFI mode only.
- SED drives can be mixed with the non-SED drives in [Table 12 on page 44](#)
- Rear NVMe drives in riser 1B are connected directly to CPU1
- Rear NVMe drives in riser 3B are connected directly to and require CPU 2
- Rear SAS/SATA drives in riser 1B or 3B connect to 12G-RAID/SAS-HBA.
- Rear drive slots are not supported for the U.3 NVMe drives.

Intel® Virtual RAID on CPU (Intel® VROC)

The server supports Intel® Virtual RAID on CPU (Intel® VROC). VROC is an enterprise RAID solution used with Intel NVMe SSDs (see [Table 12](#) for supported Intel NVMe SSDs). The Intel® Volume Management Device (Intel® VMD) is a controller integrated into the CPU PCIe root complex. Intel® VMD NVMe SSDs are connected to the CPU, which allows the full performance potential of fast Intel® Optane™ SSDs to be realized. Intel® VROC, when implemented, replaces traditional hardware RAID host bus adapter (HBA) cards placed between the drives and the CPU.

**NOTE:**

- Intel® VROC is only supported with Intel drives
 - Intel® VROC enablement key factory pre-provisioned to BIOS - no additional licensing required.
-

VROC has the following features:

- Small Form Factor (SFF) drive support (only)
- No battery backup (BBU) or external SuperCap needed
- Software-based solution utilizing Intel SFF NVMe direct connected to Intel CPU
- RAID 0/1/5/10 support
- Windows, Linux, VMware OS support.
- Host Tools- Windows GUI/CLI, Linux CLI.
- UEFI Support- HII Utility, OBSE.
- Intel VROC NVMe operates in UEFI mode only
- See the [instructions on setting up and managing VROC for Intel NVMe SSDs](#) for more information.

STEP 7 SELECT OPTION CARD(s)

For up-to-date server compatibility, please check the Hardware and Software compatibility list (HCL) at <https://ucshcltool.cloudapps.cisco.com/public/>.

The standard option card offerings are:

- Modular LAN on Motherboard (mLOM)
- Open Compute Project (OCP)
- Virtual Interface Cards (VICs)
- Network Interface Cards (NICs)
- Nexus Smart Network Interface Cards (NICs)
- Host Bus Adapters (HBAs)
- UCS NVMe/PCIe Add-in Storage Cards



WARNING: If VIC/MLOM modules are not selected then the product does not offer any onboard management port capability.

Select PCIe Option Cards

The available PCIe option cards are listed in [Table 13](#).

Table 13 Available Option Cards

Product ID (PID)	PID Description	Location	Card Size ¹
Modular LAN on Motherboard (mLOM)			
UCSC-M-V25-04	Cisco UCS VIC 1467 quad port 10/25G SFP28 mLOM	mLOM	HHHL, SS
UCSC-M-V100-04	Cisco UCS VIC 1477 dual port 40/100G QSFP28 mLOM	mLOM	HHHL, SS
UCSC-M-V5D200G	Cisco UCS VIC 15238 dual port 40/100/200G MLOM	mLOM	HHHL, SS
UCSC-M-V5Q50GV2 ²	Cisco UCS VIC 15427 Quad Port CNA MLOM with Secure Boot	mLOM	HHHL, SS
UCSC-M-V5D200GV2 ²	VIC 15237, MLOM, 2x40/100/200G for Rack	mLOM	HHHL, SS
Open Compute Project (OCP)			
UCSC-O-N6CD100GF	Cisco-NVDA MCX623436AC-CDAB CX6Dx 2x100G QSFP56 x16 OCP NIC	OCP	SFF
UCSC-O-N6CD25GF	Cisco-NVDA MCX631432AC-ADAB CX6Lx 2x25G SFP28 x8 OCP NIC	OCP	SFF
Virtual Interface Card (VICs)			
UCSC-PCIE-C100-04 ³	Cisco UCS VIC 1495 Dual Port 40/100G QSFP28 CNA PCIe	Riser 1 or 2	HHHL, SS
UCSC-PCIE-C25Q-04 ³	Cisco UCS VIC 1455 quad port 10/25G SFP28 PCIe	Riser 1 or 2	HHHL, SS
UCSC-P-V5Q50G	Cisco UCS VIC 15425 Quad Port 10/25/50G CNA PCIE	Riser 1 or 2	HHHL, SS

Table 13 Available Option Cards (continued)

Product ID (PID)	PID Description	Location	Card Size ¹
UCSC-P-V5D200G	Cisco UCS VIC 15235 Dual Port 40/100/200G CNA PCIe	Riser 1 or 2	HHHL, SS
Network Interface Cards (NICs)			
1 Gb NICs			
UCSC-PCIE-IRJ45	Intel i350 quad-port 1G copper PCIe	Riser 1, 2, or 3	HHHL, SS
10 Gb NICs			
UCSC-PCIE-ID10GF	Intel X710-DA2 Dual Port 10Gb SFP+ NIC	Riser 1, 2, or 3	HHHL, SS
UCSC-PCIE-IQ10GF	Intel X710 quad-port 10G SFP+ NIC	Riser 1, 2, or 3	FHHL, SS
UCSC-P-ID10GC	Cisco-Intel X710T2LG 2x10 GbE RJ45 PCIe NIC	Riser 1, 2, or 3	HHHL, SS
UCSC-P-IQ10GC	Cisco-Intel X710T4LG 4x10 GbE RJ45 PCIe NIC	Riser 1, 2, or 3	HHHL, SS
25 Gb NICs			
UCSC-P-I8D25GF ⁴	Cisco-Intel E810XXVDA2 2x25/10 GbE SFP28 PCIe NIC	Riser 1, 2, or 3	HHHL, SS
UCSC-P-M5D25GF ⁴	Mellanox MCX512A-ACAT dual port 10/25G SFP28 NIC	Riser 1, 2, or 3	HHHL, SS
UCSC-P-I8Q25GF ⁴	Cisco-Intel E810XXVDA4L 4x25/10 GbE SFP28 PCIe NIC	Riser 1, 2, or 3	FHHL, SS
UCSC-P-N6D25GF	Cisco-NVDA MCX631102AS-ADAT CX6Lx 2x25GbE SFP28 x8 PCIe NIC	Riser 1, 2, or 3	HHHL, SS
40 Gb NICs			
UCSC-PCIE-ID40GF	Intel XL710 dual-port 40G QSFP+ NIC	Riser 1, 2, or 3	HHHL, SS
100 Gb NICs			
UCSC-P-M5D100GF ⁴	Mellanox CX-5 MCX516A-CDAT 2x100GbE QSFP PCIe NIC	Riser 1, 2, or 3	HHHL, SS
UCSC-P-M6CD100GF ⁴	Cisco-MLNX MCX623106AC-CDAT 2x100GbE QSFP56 PCIe NIC (with Crypto)	Riser 1, 2, or 3	HHHL, SS
UCSC-P-M6DD100GF ⁴	Cisco-MLNX MCX623106AS-CDAT 2x100GbE QSFP56 PCIe NIC	Riser 1, 2, or 3	HHHL, SS
UCSC-P-I8D100GF ⁴	Cisco-Intel E810CQDA2 2x100 GbE QSFP28 PCIe NIC	Riser 1, 2, or 3	HHHL, SS
Nexus Smart NIC			
NXN-K3P-2X	Nexus X25 2-port SFP28 SmartNIC (2-channel), KU3P FPGA	Riser 1, 2, or 3	HHLP
NXN-K3P-2X-4GB	Nexus X25 2-port SFP28 SmartNIC (2-channel), KU3P FPGA, 4GB	Riser 1, 2, or 3	HHLP
NXN-K3P-8X	Nexus X100 2-port QSFP28 SmartNIC (8-channel), KU3P FPGA	Riser 1, 2, or 3	HHLP
NXN-K3P-8X-9GB	Nexus X100 2p QSFP28 SmartNIC (8-channel), KU3P FPGA, 9GB	Riser 1, 2, or 3	HHLP
NXN-V9P-16X-9GB	Nexus 2-port QDD SmartNIC+ (16-channel), VU9P FPGA, 9GB DDR	Riser 1, 2, or 3	HHLP
Host Bus Adapters (HBAs)			
UCSC-P-Q6D32GF	Cisco-QLogic QLE2772 2x32GFC Gen 6 Enhanced PCIe HBA	Riser 1, 2, or 3	HHHL, SS
UCSC-P-B7D32GF	Cisco-Emulex LPe35002-M2-2x32GFC Gen 7 PCIe HBA	Riser 1, 2, or 3	HHHL, SS
UCSC-PCIE-QD16GF	Qlogic QLE2692 dual-port 16G FC HBA	Riser 1, 2, or 3	HHHL, SS
UCSC-PCIE-BD16GF	Emulex LPe31002 dual port 16G FC HBA	Riser 1, 2, or 3	HHHL, SS
External Storage HBA			

Table 13 Available Option Cards (*continued*)

Product ID (PID)	PID Description	Location	Card Size ¹
UCSC-9500-8E	9500 Series PCIe Gen 4.0 Tri-Mode Storage HBA 12Gb/s SAS/SATA/PCIe (NVMe)	Riser 1, 2, or 3	HHHL, SS

Notes:

1. HHHL = half-height, half-length; FHHL = Full-height, half-length; SS = single-slot; DS = double-slot, HHL = half-height, low-profile;
2. Can not be mixed with 1400 series VICs
3. VIC in riser three slot 7 is not supported by Intersight
4. When present, the recommended Fan Speed Control policy setting is balanced.

Caveats

- For 1-CPU systems:
 - Only PCIe slots 1, 2, and 3 on PCIe riser 1A are available for a 1-CPU system.
 - The PCIe slots on riser 2 are not supported on 1-CPU systems. The riser 2 slots are full-height PCIe slots 4, 5, and 6 (see [Figure 6 on page 11](#)). These are the slots in the middle when looking at the rear of the server. Slot 4 is the bottom slot.
 - The PCIe slots on riser 3 are not supported on 1-CPU systems. The riser 3 slots are full-height PCIe slots 7 and 8 (see [Figure 6 on page 11](#)). These are the slots on the right when looking at the rear of the server. Slot 7 is the bottom slot.
 - Only a single plug-in PCIe VIC card may be installed on a 1-CPU system, and it must be installed in slots 1, 2, or 3 of riser 1A.
 - You can order an mLOM VIC card to be installed in the mLOM slot internal to the chassis. You can also have a PCIe VIC in slot 2 and thus have a PCIe VIC and one mLOM VIC in operation at the same time. If you order a double-width GPU, it must be installed in slot 2; then a PCIe VIC can be installed in slot 1. See [Table 18 on page 55](#). See [Table 13 on page 50](#) for the selection of plug-in and mLOM VIC cards. See also [Table 1 on page 20](#) and [SPARE PARTS, page 104](#) for the PCIe slot physical descriptions.
- For 2-CPU systems:
 - The following PCIe slots are available:
 - Three on PCIe riser 1A (PCIe slots 1, 2, and 3),
 - Three on PCIe riser 2A (PCIe slots 4, 5, and 6),
 - Two on PCIe riser 3A (PCIe slots 7 and 8).
 - You can order an mLOM VIC card to be installed in the mLOM slot internal to the chassis. You can also have PCIe VICs in slot 2 and slot 5 and thus have two PCIe VICs and one mLOM VIC in operation at the same time. If you order a double width GPU, it must be installed in slots 2, 5 or 7; then two PCIe VIC can be installed in slot 1 and slot 4. See [Table 13 on page 50](#) for the selection of plug-in and mLOM VIC cards. See also [Table 1 on page 20](#) and [SPARE PARTS, page 104](#) for the PCIe slot physical descriptions.

- If GPUs are installed in slot 2 of riser 1A or slot 5 of riser 2A, the NCSI capability automatically switches over to slot 1 of riser 1A or slot 4 of Riser 2A. Therefore, Cisco PCIe VICs can be installed in slots 1 and 4 if GPUs are installed in slots 2 and 5. If you order multiple GPUs, they must be installed as shown in [Table 18 on page 55](#).



NOTE: UCSM managed servers are discoverable only if a PCIe VIC is installed or a VIC is installed in the MLOM slot.

- The server supports up to two PCIe Cisco VICs plus an MLOM VIC

However, single wire management is supported on only one VIC at a time. If multiple VICs are installed on a server, only one slot has NCSI enabled at a time and for single wire management, priority goes to the MLOM slot, then slot 2, then slot 5 for NCSI management traffic. When multiple cards are installed, connect the single wire management cables in the priority order mentioned above.

- To help ensure that your operating system is compatible with the card you have selected, or to see additional cards that have been qualified to work with the UCS C240 M6 server, but are not sold on the Cisco price list, check the Hardware Compatibility List at this

URL: http://www.cisco.com/en/US/products/ps10477/prod_technical_reference_list.html

ORDER OPTIONAL PCIe OPTION CARD ACCESSORIES

- These optics and cables have been tested for compatibility and are approved for use with Ethernet Network Adapter (as of the time of this publication). For the latest update, check the and consult Cisco Compatibility Matrix at <https://tmgmatrix.cisco.com>.
- For list of supported optics and cables for VIC 1467, VIC 1495, VIC 1455and VIC 1477 refer to VIC 1400 series data sheet at the following links:
 - <https://www.cisco.com/c/en/us/products/servers-unified-computing/ucs-b-series-blade-servers/datasheet-listing.html>
 - <https://www.cisco.com/c/en/us/products/collateral/interfaces-modules/unified-computing-system-adapters/datasheet-c78-741130.html>

The latest compatibility with optical modules and DACs can be found at <https://tmgmatrix.cisco.com/>.

Refer to the these links for additional connectivity options.

Intel:	Marvell/Qlogic:	Mellanox:
Product Guide	41000 series Interoperability Matrix	Firmware Release Notes
Speed White Paper	45000 series Interoperability Matrix	

STEP 8 ORDER GPU CARDS (OPTIONAL)



NOTE: When a GPU is ordered, the server comes with low-profile heatsinks PID (UCSC-HSLP-M6=) and need to select special air duct PID (UCSC-ADGPU-240M6=) for GPUs.

Select GPU Options

The available GPU PCIe options and their riser slot compatibilities are listed in [Table 18](#)

Table 14 Available PCIe GPU Cards¹

GPU Product ID (PID)	PID Description	Card Size	Max GPU per Node	Riser Slot Compatibility					
				Riser 1A (Gen 4)	Riser 1B ²	Riser 2 (Gen 4)	Riser 3A ³ Gen 4)	Riser 3B ⁴	Riser 3C ⁵
UCSC-GPU-A10	TESLA A10, PASSIVE, 150W, 24GB	Single-wide	5	slot 2&3	N/A	slot 5&6	N/A	N/A	slot 7
UCSC-GPU-L4M6	NVIDIA L4, 70W, 24GB, 1-slot HHHH GPU	Single-wide	5	slot 2&3	N/A	slot 5&6	N/A	N/A	slot 7
UCSC-GPU-A30	TESLA A30, PASSIVE, 180W, 24GB	Double-wide	3	slot 2	N/A	slot 5	N/A	N/A	slot 7
UCSC-GPU-A40 ⁵	TESLA A40 RTX, PASSIVE, 300W, 48GB	Double-wide	3	slot 2	N/A	slot 5	N/A	N/A	slot 7
UCSC-GPU-A100-80 ⁵	TESLA A100, PASSIVE, 300W, 80GB	Double-wide	3	slot 2	N/A	slot 5	N/A	N/A	slot 7
UCSC-GPU-A16 ⁵	NVIDIA A16 PCIe 250W 4X16GB	Double-wide	3	slot 2	N/A	slot 5	N/A	N/A	slot 7

Notes:

1. Refer to https://www.cisco.com/content/en/us/td/docs/unified_computing/ucs/c/hw/c240m6/install/b-c240-m6-install-guide.html for more details.
2. Riser 1B does not accept GPUs
3. Riser 3A does not accept GPUs
4. Riser 3B does not accept GPUs
5. The server supports one full-height, full-length, double-wide GPU (PCIe slot 7 only) in Riser 3C. The UCSC-C240-M6S and UCSC-C240-M6SX servers supports one full-height, full-length, double-wide GPU (PCIe slot 7 only) in Riser 3C. The UCSC-C240-M6SN and UCSC-C240-M6N servers do not support any GPU in slot 7 of Riser 3C

**NOTE:**

- GPUs cannot be mixed
- UCSM managed servers are discoverable only if a PCIe VIC card is installed in slot 1 or slot 4 or an mLOM VIC card is installed in the mLOM slot. If you install double-width GPUs, they must be located in slots 2, 5, or 7. Therefore, if two GPUs are installed, UCSM managed servers are discoverable only if you install a VIC in slot 1, slot 4, or the MLOM slot. The server can support 2 PCIe VICs and 1 mLOM VIC along with 2 or 3 GPUs.
- All GPU cards must be procured from Cisco as there is a unique SBIOS ID required by CIMC and UCSM
- If you are adding GPUs later, please refer to [SPARE PARTS, page 104](#) section of the below spec sheet to find the accessories/cables needed along with the GPU spare.
- Please refer to [installation guide](#) for the GPU related information.

Table 15 NVIDIA GPU Licenses

Product ID (PID)	PID Description
NV-VCS-1YR	NVIDIA vCompute Server Subscription - 1 GPU - 1 Year
NV-VCS-3YR	NVIDIA vCompute Server Subscription - 1 GPU - 3 Year
NV-VCS-5YR	NVIDIA vCompute Server Subscription - 1 GPU - 5 Year
NV-GRDWK-1-5S	Quadro Perpetual Lic - NVIDIA vDWS 1CCU; 5Yr SUMS Req
NV-GRDVA-1-5S	GRID Perpetual Lic - NVIDIA VDI APPs 1CCU; 5Yr SUMS Reqd
NV-GRDPC-1-5S	GRID Perpetual Lic - NVIDIA VDI PC 1CCU; 5Yr SUMS Reqd
NV-GRD-EDP-5S	EDU - Quadro Perpetual Lic - NVIDIA vDWS 1CCU; 5Yr SUMS Reqd
NV-GRID-WKP-5YR	NVIDIA Quadro Production SUMS - vDWS 1CCU - 5 Year
NV-GRID-VAP-5YR	NVIDIA GRID Production SUMS - VDI Apps 1CCU - 5 Year
NV-GRID-PCP-5YR	NVIDIA GRID Production SUMS - VDI PC 1CCU - 5 Year
NV-GRID-EDP-5YR	EDU - NVIDIA Quadro vDWS Production SUMS - 1CCU - 5 Year
NV-GRID-WKS-1YR	NVIDIA Quadro SW Subscription - vDWS 1CCU - 1 Year
NV-GRID-WKS-3YR	NVIDIA Quadro SW Subscription - vDWS 1CCU - 3 Year
NV-GRID-WKS-4YR	NVIDIA Quadro SW Subscription - vDWS 1CCU - 4 Year
NV-GRID-WKS-5YR	NVIDIA Quadro SW Subscription - vDWS 1CCU - 5 Year
NV-GRID-PCS-1YR	NVIDIA GRID Software Subscription - VDI PC 1CCU - 1 Year
NV-GRID-PCS-3YR	NVIDIA GRID Software Subscription - VDI PC 1CCU - 3 Year
NV-GRID-PCS-4YR	NVIDIA GRID Software Subscription - VDI PC 1CCU - 4 Year
NV-GRID-PCS-5YR	NVIDIA GRID Software Subscription - VDI PC 1CCU - 5 Year

Table 15 NVIDIA GPU Licenses (continued)

Product ID (PID)	PID Description
NV-GRID-VAS-1YR	NVIDIA GRID Software Subscription - VDI Apps 1CCU - 1 Year
NV-GRID-VAS-3YR	NVIDIA GRID Software Subscription - VDI Apps 1CCU - 3 Year
NV-GRID-VAS-4YR	NVIDIA GRID Software Subscription - VDI Apps 1CCU - 4 Year
NV-GRID-VAS-5YR	NVIDIA GRID Software Subscription - VDI Apps 1CCU - 5 Year
NV-GRID-EDS-1YR	EDU - NVIDIA Quadro vDWS SW Subscription - 1CCU - 1 Year
NV-GRID-EDS-3YR	EDU - NVIDIA Quadro vDWS SW Subscription - 1CCU - 3 Year
NV-GRID-EDS-4YR	EDU - NVIDIA Quadro vDWS SW Subscription - 1CCU - 4 Year
NV-GRID-EDS-5YR	EDU - NVIDIA Quadro vDWS SW Subscription - 1CCU - 5 Year

GPU Ready Configuration

In the GPU ready configuration, the unit is configured to accept GPU's at a later stage, but GPU's are not installed at the time of ordering



CAUTION:

If any GPU A10 or A100 are installed, the operating temperature limit to 30° C (86° F). Maximum allowable operating temperature derated 1° C/300 m (1° F/547 ft) above 950 m (3117 ft)

STEP 9 ORDER POWER SUPPLY

Power supplies share a common electrical and physical design that allows for hot-plug and tool-less installation into M6 C-series servers. Each power supply is certified for high-efficiency operation and offer multiple power output options. This allows users to “right-size” based on server configuration, which improves power efficiency, lower overall energy costs and avoid stranded capacity in the data center. Use the power calculator at the following link to determine the needed power based on the options chosen (CPUs, drives, memory, and so on):

<http://ucspowercalc.cisco.com>



WARNING:

- Starting 1st January 2024, only Titanium rated PSUs are allowed to be shipped to European Union (EU), European Economic Area (EEA), United Kingdom (UK), Switzerland and other countries that adopted Lot 9 Regulation.
- DC PSUs are not impacted by Lot 9 Regulation and are EU/UK Lot 9 compliant

Table 16 Power Supply

Product ID (PID)	PID Description
PSU (Input High Line 210VAC)	
UCSC-PSU1-1050W	UCS 1050W AC PSU Platinum (Not EU/UK Lot 9 Compliant)
UCSC-PSUV2-1050DC	1050W DC power supply for C-Series servers Platinum
UCSC-PSUV21050D61 ¹	1050W -48V DC power supply for C-Series servers (India) Requires cable CAB-48DC-40A-8AWG
UCSC-PSU1-1200W	1200W Titanium power supply for C-Series Servers
UCSC-PSU1-1600W	UCS 1600W AC PSU Platinum (Not EU/UK Lot 9 Compliant)
UCSC-PSU1-2300W ²	2300W Power supply for C-series servers Titanium
PSU (Input Low Line 110VAC)	
UCSC-PSU1-1050W	UCS 1050W AC PSU Platinum (Not EU/UK Lot 9 Compliant)
UCSC-PSUV2-1050DC	1050W DC power supply for C-Series servers Platinum
UCSC-PSUV21050D61 ¹	1050W -48V DC power supply for C-Series servers (India) Requires cable CAB-48DC-40A-8AWG
UCSC-PSU1-1050ELV	1050W AC PSU Enhanced Low Line (Not EU/UK Lot 9 Compliant) Platinum
UCSC-PSU1-1200W	1200W Titanium power supply for C-Series Servers
UCSC-PSU1-1600W	UCS 1600W AC PSU Platinum (Not EU/UK Lot 9 Compliant)
UCSC-PSU1-2300W	2300W Power supply for C-series servers Titanium

Notes:

1. This power supply only supported with NO-POWER-CORD and CAB-48DC-40A-8AWG. Must be ordered for India shipments, limited to India only.
2. The 2300 W power supply uses a different power connector than the rest of the power supplies, so you must use different power cables to connect it. See [Table 17 on page 60](#) and [Table 18 on page 63](#).



NOTE:

- In a server with two power supplies, both power supplies must be identical.
 - DC PSUs are not impacted by Lot 9 Regulation and are EU/UK Lot 9 compliant
 - Must be ordered for shipments to India, limited to India only.
-

STEP 10 SELECT INPUT POWER CORD(S)

Using [Table 17](#) and [Table 18](#), select the appropriate AC power cords. You can select a minimum of no power cords and a maximum of two. If you select the option R2XX-DMYPWRCORD, no power cord is shipped with the server.



NOTE: [Table 17](#) lists the power cords for servers that use power supplies less than 2300 W. [Table 18](#) lists the power cords for servers that use 2300 W power supplies. Note that the power cords for 2300 W power supplies use a C19 connector so they only fit the 2300 W power supply connector.

Table 17 Available Power Cords (for server PSUs less than 2300 W)

Product ID (PID)	PID Description	Images
NO-POWER-CORD	ECO friendly green option, no power cable will be shipped	
R2XX-DMYPWRCORD	No power cord (dummy PID to allow for a no power cord option)	Not applicable
CAB-48DC-40A-8AWG	C-Series -48VDC PSU Power Cord, 3.5M, 3 Wire, 8AWG, 40A	<p>Figure 1-3 CAB-48DC-40A-8AWG, 00 Power Cord (3.5 m)</p>
CAB-N5K6A-NA	Power Cord, 200/240V 6A, North America	
CAB-AC-L620-C13	AC Power Cord, NEMA L6-20 - C13, 2M/6.5ft	
CAB-C13-CBN	CABASY,WIRE,JUMPER CORD, 27" L, C13/C14, 10A/250V	
CAB-C13-C14-2M	CABASY,WIRE,JUMPER CORD, PWR, 2 Meter, C13/C14,10A/250V	

Table 17 Available Power Cords (for server PSUs less than 2300 W)

Product ID (PID)	PID Description	Images
CAB-C13-C14-AC	CORD,PWR,JMP,IEC60320/C14,IEC60320/C13, 3.0M	
CAB-250V-10A-AR	Power Cord, 250V, 10A, Argentina	
CAB-9K10A-AU	Power Cord, 250VAC 10A 3112 Plug, Australia	
CAB-250V-10A-CN	AC Power Cord - 250V, 10A - PRC	
CAB-9K10A-EU	Power Cord, 250VAC 10A CEE 7/7 Plug, EU	
CAB-250V-10A-ID	Power Cord, 250V, 10A, India	
CAB-C13-C14-3M-IN	Power Cord Jumper, C13-C14 Connectors, 3 Meter Length, India	Image not available
CAB-C13-C14-IN	Power Cord Jumper,C13-C14 Connectors,1.4 Meter Length, India	Image not available
CAB-250V-10A-IS	Power Cord, SFS, 250V, 10A, Israel	

Table 17 Available Power Cords (for server PSUs less than 2300 W)

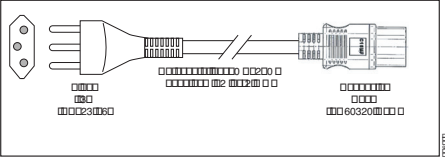
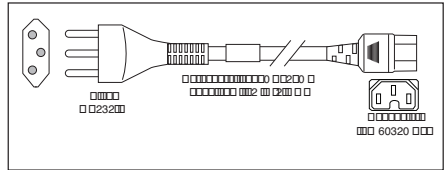
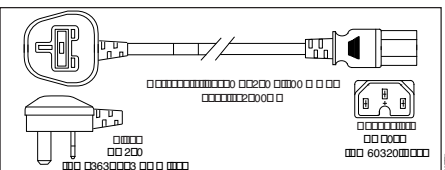
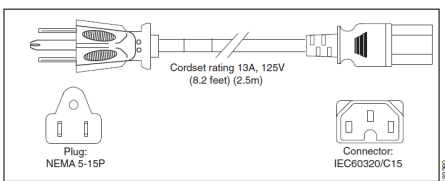
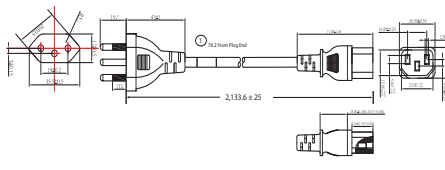
Product ID (PID)	PID Description	Images
CAB-9K10A-IT	Power Cord, 250VAC 10A CEI 23-16/VII Plug, Italy	
CAB-9K10A-SW	Power Cord, 250VAC 10A MP232 Plug, Switzerland	
CAB-9K10A-UK	Power Cord, 250VAC 10A BS1363 Plug (13 A fuse), UK	
CAB-9K12A-NA ¹	Power Cord, 125VAC 13A NEMA 5-15 Plug, North America	
CAB-250V-10A-BR	Power Cord - 250V, 10A - Brazil	
CAB-C13-C14-2M-JP	Power Cord C13-C14, 2M/6.5ft Japan PSE mark	Image not available
CAB-9K10A-KOR ¹	Power Cord, 125VAC 13A KSC8305 Plug, Korea	Image not available
CAB-ACTW	AC Power Cord (Taiwan), C13, EL 302, 2.3M	Image not available
CAB-JPN-3PIN	Japan, 90-125VAC 12A NEMA 5-15 Plug, 2.4m	Image not available
CAB-48DC-40A-INT	C-Series -48VDC PSU PWR Cord, 3.5M, 3 Wire, 8AWG, 40A (INT)	Image not available
CAB-48DC-40A-AS	C-Series -48VDC PSU PWR Cord, 3.5M, 3Wire, 8AWG, 40A (AS/NZ)	Image not available

Notes:

1. This power cord is rated to 125V and only supported for PSU rated at 1050W or less

Table 18 Available Power Cords (for servers with 2300 W PSUs)

Product ID (PID)	PID Description	Images
CAB-C19-CBN	Cabinet Jumper Power Cord, 250 VAC 16A, C20-C19 Connectors	Not applicable
CAB-S132-C19-ISRL	S132 to IEC-C19 14ft Israeli	Image not available
CAB-IR2073-C19-AR	IRSM 2073 to IEC-C19 14ft Argen	Image not available
CAB-BS1363-C19-UK	BS-1363 to IEC-C19 14ft UK	Image not available
CAB-SABS-C19-IND	SABS 164-1 to IEC-C19 India	Image not available
CAB-C2316-C19-IT	CEI 23-16 to IEC-C19 14ft Italy	Image not available
CAB-US515P-C19-US	NEMA 5-15 to IEC-C19 13ft US	Image not available
CAB-US520-C19-US	NEMA 5-20 to IEC-C19 14ft US	Image not available
CAB-US620P-C19-US	NEMA 6-20 to IEC-C19 13ft US	Image not available
CAB-9K16A-BRZ	Power Cord 250VAC 16A, Brazil, Src Plug EL224-C19	Image not available
CAB-9K16A-KOR	Power Cord 250VAC 16A, Korea, Src Plug	Image not available
CAB-AC-16A-AUS	Power Cord, 250VAC, 16A, Australia C19	Image not available
CAB-AC-2500W-EU	Power Cord, 250Vac 16A, Europe	Image not available
CAB-C14C19-10A-EU	Power Cord C14-C19 10A EU	Image not available
CAB-AC-2500W-INT	Power Cord, 250Vac 16A, INTL	Image not available
CAB-AC-2500W-ISRL	Power Cord, 250VAC, 16A, Israel	Image not available
CAB-AC-C19-TW	Power Cord, 250 V, 16A, C19, Taiwan	Image not available
CAB-AC-C6K-TWLK	Power Cord, 250Vac 16A, twist lock NEMA L6-20 plug, US	Image not available
CAB-AC16A-CH	16A AC Power Cord For China	Image not available
CAB-ACS-16	AC Power Cord (Swiss) 16A	Image not available
CAB-C19-C20-3M-JP	Power Cord C19-C20, 3M/ 10ft Japan PSE mark	Image not available
CAB-C19-C20-IND	Power Cord C19-C20 India	Image not available
UCSB-CABL-C19-BRZ	NBR 14136 to C19 AC 14FT POWER CORD, BRAZIL	Image not available
NO-POWER-CORD	ECO friendly green option, no power cable will be shipped	Image not available
R2XX-DMYPWRCORD	No power cord option Not valid for delivery destination in Argentina, Brazil, Japan	Image not available

STEP 11 ORDER TOOL-LESS RAIL KIT AND OPTIONAL REVERSIBLE CABLE MANAGEMENT ARM

Select a Tool-less Rail Kit

Select a tool-less rail kit (or no rail kit) from [Table 19](#).

Table 19 Tool-less Rail Kit Options

Product ID (PID)	PID Description
UCSC-RAIL-M6	Ball bearing rail kit
UCSC-RAIL-NONE	No rail kit option



NOTE: Cisco recommends a minimum quantity of 1 Rail Kit.

Select an Optional Reversible Cable Management Arm

The reversible cable management arm mounts on either the right or left slide rails at the rear of the server and is used for cable management. Use [Table 20](#) to order a cable management arm.

Table 20 Cable Management Arm

Product ID (PID)	PID Description
UCSC-CMA-C240M6	Reversible CMA for ball bearing rail kit

For more information about the tool-less rail kit and cable management arm, see the *Cisco UCS C240 M6 Installation and Service Guide* at this URL:

https://www.cisco.com/content/en/us/td/docs/unified_computing/ucs/c/hw/c240m6/install/b-c240-m6-install-guide.html



NOTE: If you plan to rackmount your UCS C240 M6 server, you must order a tool-less rail kit. The same rail kits and CMAs are used for M5 and M6 servers.

STEP 12 SELECT MANAGEMENT CONFIGURATION (OPTIONAL)

By default, the C240 M6 server NIC mode is configured to be Shared LOM Extended. This NIC mode allows any LOM port or adapter card port to be used to access the Cisco Integrated Management Controller (CIMC). The Cisco VIC card must be installed in a slot with NCSI support.

To change the default NIC mode to Dedicated, select the UCSC-DLOM-01 PID shown in [Table 21](#). In Dedicated NIC mode, the CIMC can be accessed only through the dedicated management port. See [Chassis Rear View \(Option 2 - UCSC-C240-M6SX\), page 11](#) for the location of the management port.

To change the default NIC mode to Cisco Card Mode, select the UCSC-CCARD-01 PID shown in [Table 21](#). In this mode, you can assign an IP address to the CIMC using DHCP and from there you can fully automate your deployment.

For more details on all the NIC mode settings, see

https://www.cisco.com/c/en/us/td/docs/unified_computing/ucs/c/hw/C480M5/install/C480M5/C480M5_chapter_010.html#concept_srj_vsr_fz

Table 21 Management Configuration Ordering Information

	PID Description
UCSC-DLOM-01	Dedicated Mode BIOS setting for C-Series Servers
UCSC-CCARD-01	Cisco Card Mode BIOS setting for C-Series Servers

In addition, the optional software PIDS listed in [Table 28 on page 72](#) can be ordered for setting the server to operate in various modes.

STEP 13 SELECT SERVER BOOT MODE (OPTIONAL)

By default, the C240 M6 SFF server ships with UEFI as the default boot mode. To have a server shipped with the Legacy BIOS mode (which was standard on M4 and previous generation servers), select the Legacy BIOS PID from [Table 22](#).

Table 22 Server Boot Mode Ordering Information

Product ID (PID)	PID Description
UCSC-LBIOS-01	Legacy Boot Mode BIOS setting for C-Series Servers

STEP 14 ORDER SECURITY DEVICES (OPTIONAL)

A Trusted Platform Module (TPM) is a computer chip (microcontroller) that can securely store artifacts used to authenticate the platform (server). These artifacts can include passwords, certificates, or encryption keys. A TPM can also be used to store platform measurements that help ensure that the platform remains trustworthy. Authentication (ensuring that the platform can prove that it is what it claims to be) and attestation (a process helping to prove that a platform is trustworthy and has not been breached) are necessary steps to ensure safer computing in all environments.

A chassis intrusion switch gives a notification of any unauthorized mechanical access into the server.

The security device ordering information is listed in [Table 23](#).

Table 23 Security Devices

Product ID (PID)	PID Description
UCSX-TPM-002C	TPM 2.0, TCG, FIPS140-2, CC EAL4+ Certified, for M6 servers
UCS-TPM-002D	TPM 2.0 TCG FIPS140-2 CC+ Cert M6 Intel MSW2022 Compliant
UCSX-TPM-OPT-OUT	OPT OUT, TPM 2.0, TCG, FIPS140-2, CC EAL4+ Certified ¹
UCSC-INT-SW02	C220 and C240 M6 Chassis Intrusion Switch

Notes:

1. Please note that Microsoft certification requires a TPM 2.0 for bare-metal or guest VM deployments. Opt-out of the TPM 2.0 voids the Microsoft certification



NOTE:

- The TPM module used in this system conforms to TPM 2.0, as defined by the Trusted Computing Group (TCG). It is also SPI-based.
- TPM installation is supported after-factory. However, a TPM installs with a one-way screw and cannot be replaced, upgraded, or moved to another server. If a server with a TPM is returned, the replacement server must be ordered with a new TPM.

STEP 15 SELECT LOCKING SECURITY BEZEL (OPTIONAL)

An optional locking bezel can be mounted to the front of the chassis to prevent unauthorized access to the drives.

Select the locking bezel from [Table 24](#).

Table 24 Locking Bezel Option

Product ID (PID)	Description
UCSC-BZL-C240M5	C240 M5/M6 Security Bezel

STEP 16 ORDER OPTICAL DRIVE (OPTIONAL)

Order an optical drive (DVD). See [Table 25](#).

Table 25 Optical (DVD) Drive

Product ID (PID)	PID Description
UCSC-DVD-C240M6	Media Drive (DVD) for C240 M6 Servers (12-HDD version only)

Caveats

You can order a DVD drive only for the UCSC-C240-M6S (12-HDD backplane version of the server).

STEP 17 ORDER M.2 SATA SSDs (OPTIONAL)

Order one or two matching M.2 SATA SSDs (see [Table 26](#)) along with a boot-optimized RAID controller (see [Table 27](#)). See [Figure 17 on page 93](#) for the location of the extender board connector on the motherboard. The motherboard extender board connector accepts the extender board and the extender board accepts the boot-optimized RAID controller.

Each boot-optimized RAID controller can accommodate up to two SATA M.2 SSDs shown in [Table 26](#). Order one or two M.2 SATA SSDs from [Table 26](#)



NOTE: It is recommended that M.2 SATA SSDs be used as boot-only devices.

Table 26 M.2 SATA SSDs

Product ID (PID)	PID Description
UCS-M2-I240GB	240GB SATA M.2 SSD
UCS-M2-I480GB	480GB SATA M.2 SSD
UCS-M2-192TB	1.9 TB SATA M.2
UCS-M2-240G	240GB SATA M.2
UCS-M2-480G	480GB M.2 SATA SSD
UCS-M2-960G	960GB SATA M.2

Order the Boot-Optimized RAID controller from [Table 27](#). The Boot-Optimized RAID controller plugs into the extender board and holds up to two M.2 SATA drives.



NOTE: The Boot-Optimized RAID controller supports VMWare, Windows and Linux Operating Systems

Table 27 Boot-Optimized RAID Controller

Product ID (PID)	PID Description
UCS-M2-HWRAID	Cisco Boot optimized M.2 RAID controller (holds up to two M.2 SATA SSDs)



NOTE:

- The UCS-M2-HWRAID boot-optimized RAID controller supports RAID 1 and JBOD mode
- (CIMC/UCSM) is supported for configuring of volumes and monitoring of the controller and installed SATA M.2 drives
- The minimum version of Cisco IMC and Cisco UCS Manager that support this controller is 4.2(1) and later. The name of the controller in the software is MSTOR-RAID
- The SATA M.2 drives can boot in UEFI mode only. Legacy boot mode is not supported
- Hot-plug replacement is not supported. The server must be powered off.

Caveats

- Order one or two identical M.2 SATA SSDs for the boot-optimized RAID controller. You cannot mix M.2 SATA SSD capacities.

STEP 18 SELECT OPERATING SYSTEM AND VALUE-ADDED SOFTWARE



NOTE:

- See this link for operating system guidance: <https://ucshcltool.cloudapps.cisco.com/public/>
- VMware is on Compliance Hold. Contact the Compute-Vmware-Hold@cisco.com mailer to see if you are allowed to receive VMware Licenses

Select

- OEM Software ([Table 28](#))
- Operating System ([Table 29](#))
- NVIDIA GPU Licenses ([Table 15 on page 56](#))

Table 28 OEM Software

Product ID (PID)	PID Description
VMware vCenter	
VMW-VCS-STD-1A	VMware vCenter 6 Server Standard, 1 yr support required
VMW-VCS-STD-3A	VMware vCenter 6 Server Standard, 3 yr support required
VMW-VCS-STD-5A	VMware vCenter 6 Server Standard, 5 yr support required
VMW-VCS-FND-1A	VMware vCenter 6 Server Foundation (4 Host), 1 yr supp reqd
VMW-VCS-FND-3A	VMware vCenter 6 Server Foundation (4 Host), 3 yr supp reqd
VMW-VCS-FND-5A	VMware vCenter 6 Server Foundation (4 Host), 5 yr supp reqd

Table 29 Operating System

Product ID (PID)	PID Description
Microsoft Windows Server	
MSWS-19-DC16C	Windows Server 2019 Data Center (16 Cores/Unlimited VMs)
MSWS-19-DC16C-NS	Windows Server 2019 DC (16 Cores/Unlim VMs) - No Cisco SVC
MSWS-19-ST16C	Windows Server 2019 Standard (16 Cores/2 VMs)
MSWS-19-ST16C-NS	Windows Server 2019 Standard (16 Cores/2 VMs) - No Cisco SVC

Table 29 Operating System (continued)

Product ID (PID)	PID Description
MSWS-22-DC16C	Windows Server 2022 Data Center (16 Cores/Unlimited VMs)
MSWS-22-DC16C-NS	Windows Server 2022 DC (16 Cores/Unlim VMs) - No Cisco SVC
MSWS-22-DCA2C	Windows Server 2022 Data Center - Additional 2 Cores
MSWS-22-DCA2C-NS	Windows Server 2022 DC - Additional 2 Cores - No Cisco SVC
MSWS-22-ST16C	Windows Server 2022 Standard (16 Cores/2 VMs)
MSWS-22-ST16C-NS	Windows Server 2022 Standard (16 Cores/2 VMs) - No Cisco SVC
MSWS-22-STA2C	Windows Server 2022 Standard - Additional 2 Cores
MSWS-22-STA2C-NS	Windows Server 2022 Stan - Additional 2 Cores - No Cisco SVC
Red Hat	
RHEL-2S2V-1A	Red Hat Enterprise Linux (1-2 CPU,1-2 VN); 1-Yr Support Req
RHEL-2S2V-3A	Red Hat Enterprise Linux (1-2 CPU,1-2 VN); 3-Yr Support Req
RHEL-2S2V-5A	Red Hat Enterprise Linux (1-2 CPU,1-2 VN); 5-Yr Support Req
RHEL-VDC-2SUV-1A	RHEL for Virt Datacenters (1-2 CPU, Unlim VN) 1 Yr Supp Req
RHEL-VDC-2SUV-3A	RHEL for Virt Datacenters (1-2 CPU, Unlim VN) 3 Yr Supp Req
RHEL-VDC-2SUV-5A	RHEL for Virt Datacenters (1-2 CPU, Unlim VN) 5 Yr Supp Req
Red Hat Ent Linux/ High Avail/ Res Strg/ Scal	
RHEL-2S2V-1S	Red Hat Enterprise Linux (1-2 CPU,1-2 VN); Prem 1-Yr SnS
RHEL-2S2V-3S	Red Hat Enterprise Linux (1-2 CPU,1-2 VN); Prem 3-Yr SnS
RHEL-2S-HA-1S	RHEL High Availability (1-2 CPU); Premium 1-yr SnS
RHEL-2S-HA-3S	RHEL High Availability (1-2 CPU); Premium 3-yr SnS
RHEL-2S-RS-1S	RHEL Resilient Storage (1-2 CPU); Premium 1-yr SnS
RHEL-2S-RS-3S	RHEL Resilient Storage (1-2 CPU); Premium 3-yr SnS
RHEL-VDC-2SUV-1S	RHEL for Virt Datacenters (1-2 CPU, Unlim VN) 1 Yr SnS Reqd
RHEL-VDC-2SUV-3S	RHEL for Virt Datacenters (1-2 CPU, Unlim VN) 3 Yr SnS Reqd
Red Hat SAP	
RHEL-SAP-2S2V-1S	RHEL for SAP Apps (1-2 CPU, 1-2 VN); Prem 1-Yr SnS
RHEL-SAP-2S2V-3S	RHEL for SAP Apps (1-2 CPU, 1-2 VN); Prem 3-Yr SnS
VMware	
VMW-VSP-STD-1A	VMware vSphere 6 Standard (1 CPU), 1-yr, Support Required

Table 29 Operating System (continued)

Product ID (PID)	PID Description
VMW-VSP-STD-3A	VMware vSphere 6 Standard (1 CPU), 3-yr, Support Required
VMW-VSP-STD-5A	VMware vSphere 6 Standard (1 CPU), 5-yr, Support Required
VMW-VSP-EPL-3A	VMware vSphere 6 Ent Plus (1 CPU), 3-yr, Support Required
VMW-VSP-EPL-1A	VMware vSphere 6 Ent Plus (1 CPU), 1-yr, Support Required
VMW-VSP-EPL-5A	VMware vSphere 6 Ent Plus (1 CPU), 5-yr, Support Required
SUSE	
SLES-2S2V-1A	SUSE Linux Enterprise Svr (1-2 CPU,1-2 VM); 1-Yr Support Req
SLES-2S2V-3A	SUSE Linux Enterprise Svr (1-2 CPU,1-2 VM); 3-Yr Support Req
SLES-2S2V-5A	SUSE Linux Enterprise Svr (1-2 CPU,1-2 VM); 5-Yr Support Req
SLES-2S2V-1S	SUSE Linux Enterprise Svr (1-2 CPU,1-2 VM); Prio 1-Yr SnS
SLES-2S2V-3S	SUSE Linux Enterprise Svr (1-2 CPU,1-2 VM); Prio 3-Yr SnS
SLES-2S2V-5S	SUSE Linux Enterprise Svr (1-2 CPU,1-2 VM); Prio 5-Yr SnS
SLES-2S-HA-1S	SUSE Linux High Availability Ext (1-2 CPU); 1yr SnS
SLES-2S-HA-3S	SUSE Linux High Availability Ext (1-2 CPU); 3yr SnS
SLES-2S-HA-5S	SUSE Linux High Availability Ext (1-2 CPU); 5yr SnS
SLES-2S-GC-1S	SUSE Linux GEO Clustering for HA (1-2 CPU); 1yr Sns
SLES-2S-GC-3S	SUSE Linux GEO Clustering for HA (1-2 CPU); 3yr SnS
SLES-2S-GC-5S	SUSE Linux GEO Clustering for HA (1-2 CPU); 5yr SnS
SLES-2S-LP-1S	SUSE Linux Live Patching Add-on (1-2 CPU); 1yr SnS Required
SLES-2S-LP-3S	SUSE Linux Live Patching Add-on (1-2 CPU); 3yr SnS Required
SLES-2S-LP-1A	SUSE Linux Live Patching Add-on (1-2 CPU); 1yr Support Req
SLES-2S-LP-3A	SUSE Linux Live Patching Add-on (1-2 CPU); 3yr Support Req
SLES-2SUVM-1A	SUSE Linux Enterprise Svr (1-2 CPU,Unl VM) LP; 1Y Supp Req
SLES-2SUVM-1S	SUSE Linux Enterprise Svr (1-2 CPU,Unl VM) LP; Prio 1Y SnS
SLES-2SUVM-1YR	SUSE Linux Entp Svr (1-2 CPU,Unl VM) LP; Prio SnS 24x7 - 1Y
SLES-2SUVM-3A	SUSE Linux Enterprise Svr (1-2 CPU,Unl VM) LP; 3Y Supp Req
SLES-2SUVM-3S	SUSE Linux Enterprise Svr (1-2 CPU,Unl VM) LP; Prio 3Y SnS
SLES-2SUVM-3YR	SUSE Linux Entp Svr (1-2 CPU,Unl VM) LP; Prio SnS 24x7 - 3Y
SLES-2SUVM-5A	SUSE Linux Enterprise Svr (1-2 CPU,Unl VM) LP; 5Y Supp Req

Table 29 Operating System (continued)

Product ID (PID)	PID Description
SLES-2SUVM-5S	SUSE Linux Enterprise Svr (1-2 CPU,Unl VM) LP; Prio 5Y SnS
SLES-2SUVM-5YR	SUSE Linux Entp Svr (1-2 CPU,Unl VM) LP; Prio SnS 24x7 - 5Y
SLES-SAP2SUVM-1A	SLES for SAP Apps w/ HA (1-2 CPU, Unl VM) LP; 1Y Supp Reqd
SLES-SAP2SUVM-1S	SLES for SAP Apps (1-2 CPU, Unl VM) LP; Priority 1Y SnS
SLES-SAP2SUVM-1YR	SUSE for SAP Apps; (1-2 CPU,Unl VM) LP; Prio SnS 24x7 - 1Y
SLES-SAP2SUVM-3A	SLES for SAP Apps w/ HA (1-2 CPU, Unl VM) LP; 3Y Supp Reqd
SLES-SAP2SUVM-3S	SLES for SAP Apps (1-2 CPU, Unl VM) LP; Priority 3Y SnS
SLES-SAP2SUVM-3YR	SUSE for SAP Apps; (1-2 CPU,Unl VM) LP; Prio SnS 24x7 - 3Y
SLES-SAP2SUVM-5A	SLES for SAP Apps w/ HA (1-2 CPU, Unl VM) LP; 5Y Supp Reqd
SLES-SAP2SUVM-5S	SLES for SAP Apps (1-2 CPU, Unl VM) LP; Priority 5Y SnS
SLES-SAP2SUVM-5YR	SUSE for SAP Apps; (1-2 CPU,Unl VM) LP; Prio SnS 24x7 - 5Y
SLES and SAP	
SLES-SAP-2S2V-1A	SLES for SAP Apps (1-2 CPU, 1-2 VM); 1-Yr Support Reqd
SLES-SAP-2S2V-3A	SLES for SAP Apps (1-2 CPU, 1-2 VM); 3-Yr Support Reqd
SLES-SAP-2S2V-5A	SLES for SAP Apps (1-2 CPU, 1-2 VM); 5-Yr Support Reqd
SLES-SAP-2S2V-1S	SLES for SAP Apps (1-2 CPU, 1-2 VM); Priority 1-Yr SnS
SLES-SAP-2S2V-3S	SLES for SAP Apps (1-2 CPU, 1-2 VM); Priority 3-Yr SnS
SLES-SAP-2S2V-5S	SLES for SAP Apps (1-2 CPU, 1-2 VM); Priority 5-Yr SnS

STEP 19 SELECT OPERATING SYSTEM MEDIA KIT

Select the optional operating system media listed in [Table 30](#).

Table 30 OS Media

Product ID (PID)	PID Description
MSWS-19-ST16C-RM	Windows Server 2019 Stan (16 Cores/2 VMs) Rec Media DVD Only
MSWS-19-DC16C-RM	Windows Server 2019 DC (16Cores/Unlim VM) Rec Media DVD Only
MSWS-22-ST16C-RM	Windows Server 2022 Stan (16 Cores/2 VMs) Rec Media DVD Only
MSWS-22-DC16C-RM	Windows Server 2022 DC (16Cores/Unlim VM) Rec Media DVD Only

STEP 20 SELECT SERVICE and SUPPORT LEVEL

A variety of service options are available, as described in this section.

Unified Computing Warranty, No Contract

If you have noncritical implementations and choose to have no service contract, the following coverage is supplied:

- Three-year parts coverage.
- Next business day (NBD) parts replacement eight hours a day, five days a week.
- 90-day software warranty on media.
- Ongoing downloads of BIOS, drivers, and firmware updates.
- UCSM updates for systems with Unified Computing System Manager. These updates include minor enhancements and bug fixes that are designed to maintain the compliance of UCSM with published specifications, release notes, and industry standards.

Smart Net Total Care (SNTC) for Cisco UCS

For support of the entire Unified Computing System, Cisco offers the Cisco Smart Net Total Care (SNTC) for UCS Service. This service provides expert software and hardware support to help sustain performance and high availability of the unified computing environment. Access to Cisco Technical Assistance Center (TAC) is provided around the clock, from anywhere in the world.

For systems that include Unified Computing System Manager (UCSM), the support service includes downloads of UCSM upgrades. The Cisco Smart Net Total Care for UCS Service includes flexible hardware replacement options, including replacement in as little as two hours. There is also access to Cisco's extensive online technical resources to help maintain optimal efficiency and uptime of the unified computing environment. For more information please refer to the following URL:

<http://www.cisco.com/c/en/us/services/technical/smart-net-total-care.html?stickynav=1>

You can choose a desired service listed in *Table 31*.

Table 31 Cisco SNTC for UCS Service (PID UCSC-C240-M6S)

Service SKU	Service Level GSP	On Site?	Description
CON-PREM-UCSCC20S	C2P	Yes	SNTC 24X7X20S
CON-UCSD8-UCSCC20S	UCSD8	Yes	UC SUPP DR 24X7X20S*
CON-C2PL-UCSCC20S	C2PL	Yes	LL 24X7X20S**
CON-OSP-UCSCC20S	C4P	Yes	SNTC 24X7X40S
CON-UCSD7-UCSCC20S	UCSD7	Yes	UCS DR 24X7X40S*

Table 31 Cisco SNTC for UCS Service (PID UCSC-C240-M6S) (continued)

Service SKU	Service Level GSP	On Site?	Description
CON-C4PL-UCSCC20S	C4PL	Yes	LL 24X7X40S**
CON-USD7L-UCSCC20S	USD7L	Yes	LLUCS HW DR 24X7X40S***
CON-OSE-UCSCC20S	C4S	Yes	SNTC 8X5X40S
CON-UCSD6-UCSCC20S	UCSD6	Yes	UC SUPP DR 8X5X40S*
CON-SNCO-UCSCC20S	SNCO	Yes	SNTC 8x7xNCDOS****
CON-OS-UCSCC20S	CS	Yes	SNTC 8X5XNBDOS
CON-UCSD5-UCSCC20S	UCSD5	Yes	UCS DR 8X5XNBDOS*
CON-S2P-UCSCC20S	S2P	No	SNTC 24X7X2
CON-S2PL-UCSCC20S	S2PL	No	LL 24X7X2**
CON-SNTP-UCSCC20S	SNTP	No	SNTC 24X7X4
CON-SNTPL-UCSCC20S	SNTPL	No	LL 24X7X4**
CON-SNTE-UCSCC20S	SNTE	No	SNTC 8X5X4
CON-SNC-UCSCC20S	SNC	No	SNTC 8x7xNCD
CON-SNT-UCSCC20S	SNT	No	SNTC 8X5XNBD
CON-SW-UCSCC20S	SW	No	SNTC NO RMA
Note : For PID UCSC-C240-M6S-CH, select Service SKU with UHCSCC24 suffix (Example: CON-OSP-UHCSCC24)			
For PID UCSC-C240-M6SX, select Service SKU with UCSCXC24 suffix (Example: CON-OSP-UCSCXC24)			
For PID UCSC-C240-M6SX-BR, select Service SKU with UCSCC24B suffix (Example: CON-OSP-UCSCC24B)			
For PID UCSC-C240-M6SX-CH, select Service SKU with UCSCC24C suffix (Example: CON-OSP-UCSCC24C)			
For PID UCSC-C240-M6N, select Service SKU with UCSC0C24 suffix (Example: CON-OSP-UCSC0C24)			
For PID UCSC-C240-M6N-CH, select Service SKU with UCSCNC24 suffix (Example: CON-OSP-UCSCNC24)			
For PID UCSC-C240-M6SN, select Service SKU with UC0CC2N4 suffix (Example: CON-OSP-UC0CC2N4)			
For PID UCSC-C240-M6SN-BR, select Service SKU with UCSCRC24 suffix (Example: CON-OSP-UCSCRC24)			
For PID UCSC-C240-M6SN-CH, select Service SKU with UCSCC24H suffix (Example: CON-OSP-UCSCC24H)			
*Includes Drive Retention (see below for full description)			
**Includes Local Language Support (see below for full description) – Only available in China and Japan			
***Includes Local Language Support and Drive Retention – Only available in China and Japan			

Smart Net Total Care for Cisco UCS Onsite Troubleshooting Service

An enhanced offer over traditional Smart Net Total Care which provides onsite troubleshooting expertise to aid in the diagnostics and isolation of hardware issue within our customers' Cisco Unified Computing System (UCS) environment. It is delivered by a Cisco Certified field engineer (FE) in collaboration with remote TAC engineer and Virtual Internetworking Support Engineer (VISE). You can choose a desired service listed in [Table 32](#).

Table 32 SNTC for Cisco UCS Onsite Troubleshooting Service (PID UCSC-C240-M6S)

Service SKU	Service Level GSP	On Site?	Description
CON-OSPT-UCSCC20S	OSPT	Yes	24X7X40S Trblshtg
CON-OSPTD-UCSCC20S	OSPTD	Yes	24X7X40S TrblshtgDR*
CON-OSPTL-UCSCC20S	OSPTL	Yes	24X7X40S TrblshtgLL**
CON-OPTLD-UCSCC20S	OPTLD	Yes	24X7X40S TrblshtgLLD***
For PID UCSC-C240-M6SX, select Service SKU with UCSCXC24 suffix (Example: CON-OSPT-UCSCXC24)			
For PID UCSC-C240-M6SX-BR, select Service SKU with UCSCC24B suffix (Example: CON-OSPT-UCSCC24B)			
For PID UCSC-C240-M6SX-CH, select Service SKU with UCSCC24C suffix (Example: CON-OSPT-UCSCC24C)			
For PID UCSC-C240-M6N, select Service SKU with UCSC0C24 suffix (Example: CON-OSPT-UCSC0C24)			
For PID UCSC-C240-M6N-CH, select Service SKU with UCSCNC24 suffix (Example: CON-OSPT-UCSCNC24)			
For PID UCSC-C240-M6SN, select Service SKU with UC0CC2N4 suffix (Example: CON-OSPT-UC0CC2N4)			
For PID UCSC-C240-M6SN-BR, select Service SKU with UCSCRC24 suffix (Example: CON-OSPT-UCSCRC24)			
For PID UCSC-C240-M6SN-CH, select Service SKU with UCSCC24H suffix (Example: CON-OSPT-UCSCC24H)			
*Includes Drive Retention (see below for full description)			
**Includes Local Language Support (see below for full description) – Only available in China and Japan			
***Includes Local Language Support and Drive Retention – Only available in China and Japan			

Solution Support (SSPT) for UCS

Solution Support includes both Cisco product support and solution-level support, resolving complex issues in multivendor environments, on average, 43% more quickly than product support alone. Solution Support is a critical element in data center administration, to help rapidly resolve any issue encountered, while maintaining performance, reliability, and return on investment.

This service centralizes support across your multivendor Cisco environment for both our products and solution partner products you've deployed in your ecosystem. Whether there is an issue with a Cisco or solution partner product, just call us. Our experts are the primary point of contact and own the case from first call to resolution. For more information please refer to the following URL:

<http://www.cisco.com/c/en/us/services/technical/solution-support.html?stickynav=1>

You can choose a desired service listed in [Table 33](#).

Table 33 Solution Support for UCS Service (PID UCSC-C240-M6S)

Service SKU	Service Level GSP	On Site?	Description
CON-SSC2P-UCSCC20S	SSC2P	Yes	SOLN SUPP 24X7X20S
CON-SSC4P-UCSCC20S	SSC4P	Yes	SOLN SUPP 24X7X40S
CON-SSC4S-UCSCC20S	SSC4S	Yes	SOLN SUPP 8X5X40S
CON-SSCS-UCSCC20S	SSCS	Yes	SOLN SUPP 8X5XNBDOS
CON-SSDR7-UCSCC20S	SSDR7	Yes	SSPT DR 24X7X40S*
CON-SSDR5-UCSCC20S	SSDR5	Yes	SSPT DR 8X5XNBDOS*
CON-SSS2P-UCSCC20S	SSS2P	No	SOLN SUPP 24X7X2
CON-SSSNP-UCSCC20S	SSSNP	No	SOLN SUPP 24X7X4
CON-SSSNE-UCSCC20S	SSSNE	No	SOLN SUPP 8X5X4
CON-SSSNC-UCSCC20S	SSSNC	No	SOLN SUPP NCD
CON-SSSNT-UCSCC20S	SSSNT	No	SOLN SUPP 8X5XNBD
Note: For PID UCSC-C240-M6S-CH, select Service SKU with UHCSCC24 suffix (Example: CON-SSCS-UHCSCC24)			
For PID UCSC-C240-M6SX, select Service SKU with UCSCXC24 suffix (Example: CON-SSCS-UCSCXC24)			
For PID UCSC-C240-M6SX-BR, select Service SKU with UCSCC24B suffix (Example: CON-SSCS-UCSCC24B)			
For PID UCSC-C240-M6SX-CH, select Service SKU with UCSCC24C suffix (Example: CON-SSCS-UCSCC24C)			
For PID UCSC-C240-M6N, select Service SKU with UCSC0C24 suffix (Example: CON-SSCS-UCSC0C24)			
For PID UCSC-C240-M6N-CH, select Service SKU with UCSCNC24 suffix (Example: CON-SSCS-UCSCNC24)			
For PID UCSC-C240-M6SN, select Service SKU with UC0CC2N4 suffix (Example: CON-SSCS-UC0CC2N4)			

Table 33 Solution Support for UCS Service (PID UCSC-C240-M6S) (continued)

Service SKU	Service Level GSP	On Site?	Description
For PID UCSC-C240-M6SN-BR, select Service SKU with UCSCRC24 suffix (Example: CON-SSCS-UCSCRC24)			
For PID UCSC-C240-M6SN-CH, select Service SKU with UCSCC24H suffix (Example: CON-SSCS-UCSCC24H)			
*Includes Drive Retention (see below for full description)			

Solution Support for Service Providers

You can choose a desired service listed in [Table 33](#).

Table 34 Solution Support for UCS Service (PID UCSC-C240-M6S)

Service SKU	Service Level GSP	On Site?	Description
SP-SSC2P-UCSCC20S	SPSSC2P	Yes	SP SOLN SUPP 24X7X20S
SP-SSC4P-UCSCC20S	SPSSC4P	Yes	SP SOLN SUPP 24X7X40S
SP-SSC4S-UCSCC20S	SPSSC4S	Yes	SP SOLN SUPP 8X5X40S
SP-SSCS-UCSCC20S	SPSSCS	Yes	SP SOLN SUPP 8X5XNBDOS
SP-SSS2P-UCSCC20S	SPSSS2P	Yes	SP SOLN SUPP 24X7X2
SP-SSS4P-UCSCC20S	SPSSS4P	Yes	SP SOLN SUPP 24X7X4
SP-SSSNE-UCSCC20S	SPSSSNE	No	SP SOLN SUPP 8X5X4
SP-SSSNT-UCSCC20S	SPSSSNT	No	SP SOLN SUPP 8X5XNBD
SP-SSSPB-UCSCC20S	SPSSSPB	No	SP SOLN SUPP NO HW RPL
Note: For PID UCSC-C240-M6S-CH, select Service SKU with UHCSCC24 suffix (Example: CON-SSC4P-UHCSCC24)			
For PID UCSC-C240-M6SX, select Service SKU with UCSCXC24 suffix (Example: CON-SSC4P-UCSCXC24)			
For PID UCSC-C240-M6SX-BR, select Service SKU with UCSCC24B suffix (Example: CON-SSC4P-UCSCC24B)			
For PID UCSC-C240-M6SX-CH, select Service SKU with UCSCC24C suffix (Example: CON-SSC4P-UCSCC24C)			
For PID UCSC-C240-M6N, select Service SKU with UCSC0C24 suffix (Example: CON-SSC4P-UCSC0C24)			
For PID UCSC-C240-M6N-CH, select Service SKU with UCSCNC24 suffix (Example: CON-SSC4P-UCSCNC24)			
For PID UCSC-C240-M6SN, select Service SKU with UC0CC2N4 suffix (Example: CON-SSC4P-UC0CC2N4)			
For PID UCSC-C240-M6SN-BR, select Service SKU with UCSCRC24 suffix (Example: CON-SSC4P-UCSCRC24)			
For PID UCSC-C240-M6SN-CH, select Service SKU with UCSCC24H suffix (Example: CON-SSC4P-UCSCC24H)			
*Includes Drive Retention (see below for full description)			

Smart Net Total Care for UCS Hardware Only Service

For faster parts replacement than is provided with the standard Cisco Unified Computing System warranty, Cisco offers the Cisco Smart Net Total Care for UCS Hardware Only Service. You can choose from two levels of advanced onsite parts replacement coverage in as little as four hours. Smart Net Total Care for UCS Hardware Only Service provides remote access any time to Cisco support professionals who can determine if a return materials authorization (RMA) is required. You can choose a desired service listed in [Table 35](#).

Table 35 SNTC for UCS Hardware Only Service (PID UCSC-C240-M6S)

Service SKU	Service Level GSP	On Site?	Description
CON-UCW7-UCSCC20S	UCW7	Yes	UCS HW 24X7X40S
CON-UCWD7-UCSCC20S	UCWD7	Yes	UCS HW+DR 24X7X40S*
CON-UCW7L-UCSCC20S	UCW7L	Yes	LL UCS 24X7X40S**
CON-UWD7L-UCSCC20S	UWD7L	Yes	LL UCS DR 24X7X40S***
CON-UCW5-UCSCC20S	UCW5	Yes	UCS HW 8X5XNBDOS
CON-UCWD5-UCSCC20S	UCWD5	Yes	UCS HW+DR 8X5XNBDOS*
Note: For PID UCSC-C240-M6S-CH, select Service SKU with UHCSCC24 suffix (Example: CON-UCW7-UHCSCC24)			
For PID UCSC-C240-M6SX, select Service SKU with UCSCXC24 suffix (Example: CON-UCW7-UCSCXC24)			
For PID UCSC-C240-M6SX-BR, select Service SKU with UCSCC24B suffix (Example: CON-UCW7-UCSCC24B)			
For PID UCSC-C240-M6SX-CH, select Service SKU with UCSCC24C suffix (Example: CON-UCW7-UCSCC24C)			
For PID UCSC-C240-M6N, select Service SKU with UCSC0C24 suffix (Example: CON-UCW7-UCSC0C24)			
For PID UCSC-C240-M6N-CH, select Service SKU with UCSCNC24 suffix (Example: CON-UCW7-UCSCNC24)			
For PID UCSC-C240-M6SN, select Service SKU with UC0CC2N4 suffix (Example: CON-UCW7-UC0CC2N4)			
For PID UCSC-C240-M6SN-BR, select Service SKU with UCSCRC24 suffix (Example: CON-UCW7-UCSCRC24)			
For PID UCSC-C240-M6SN-CH, select Service SKU with UCSCC24H suffix (Example: CON-UCW7-UCSCC24H)			
*Includes Drive Retention (see below for full description)			
**Includes Local Language Support (see below for full description) – Only available in China and Japan			
***Includes Local Language Support and Drive Retention – Only available in China and Japan			

Partner Support Service for UCS

Cisco Partner Support Service (PSS) is a Cisco Collaborative Services service offering that is designed for partners to deliver their own branded support and managed services to enterprise customers. Cisco PSS provides partners with access to Cisco's support infrastructure and assets to help them:

- Expand their service portfolios to support the most complex network environments
- Lower delivery costs
- Deliver services that increase customer loyalty

PSS options enable eligible Cisco partners to develop and consistently deliver high-value technical support that capitalizes on Cisco intellectual assets. This helps partners to realize higher margins and expand their practice. PSS is available to all Cisco PSS partners. The two Partner Unified Computing Support Options include:

- Partner Support Service for UCS
- Partner Support Service for UCS Hardware Only

PSS for UCS provides hardware and software support, including triage support for third party software, backed by Cisco technical resources and level three support. You can choose a desired service listed in [Table 36](#).

Table 36 PSS for UCS (PID UCSC-C240-M6S)

Service SKU	Service Level GSP	On Site?	Description
CON-PSJ8-UCSCC20S	PSJ8	Yes	UCS PSS 24X7X2 OS
CON-PSJ7-UCSCC20S	PSJ7	Yes	UCS PSS 24X7X4 OS
CON-PSJD7-UCSCC20S	PSJD7	Yes	UCS PSS 24X7X4 DR*
CON-PSJ6-UCSCC20S	PSJ6	Yes	UCS PSS 8X5X4 OS
CON-PSJD6-UCSCC20S	PSJD6	Yes	UCS PSS 8X5X4 DR*
CON-PSJ4-UCSCC20S	PSJ4	No	UCS SUPP PSS 24X7X2
CON-PSJ3-UCSCC20S	PSJ3	No	UCS SUPP PSS 24X7X4
CON-PSJ2-UCSCC20S	PSJ2	No	UCS SUPP PSS 8X5X4
CON-PSJ1-UCSCC20S	PSJ1	No	UCS SUPP PSS 8X5XNBD
Note: For PID UCSC-C240-M6S-CH, select Service SKU with UHCSCC24 suffix (Example: CON-PSJ7-UHCSCC24)			
For PID UCSC-C240-M6SX, select Service SKU with UCSCXC24 suffix (Example: CON-PSJ7-UCSCXC24)			
For PID UCSC-C240-M6SX-BR, select Service SKU with UCSCC24B suffix (Example: CON-PSJ7-UCSCC24B)			
For PID UCSC-C240-M6SX-CH, select Service SKU with UCSCC24C suffix (Example: CON-PSJ7-UCSCC24C)			
For PID UCSC-C240-M6N, select Service SKU with UCSC0C24 suffix (Example: CON-PSJ7-UCSC0C24)			
For PID UCSC-C240-M6N-CH, select Service SKU with UCSCNC24 suffix (Example: CON-PSJ7-UCSCNC24)			

Table 36 PSS for UCS (PID UCSC-C240-M6S) (continued)

For PID UCSC-C240-M6SN, select Service SKU with UC0CC2N4 suffix (Example: CON-PSJ7-UC0CC2N4)
For PID UCSC-C240-M6SN-BR, select Service SKU with UCSCRC24 suffix (Example: CON-PSJ7-UCSCRC24)
For PID UCSC-C240-M6SN-CH, select Service SKU with UCSCC24H suffix (Example: CON-PSJ7-UCSCC24H)
*Includes Drive Retention (see below for full description)

PSS for UCS Hardware Only

PSS for UCS Hardware Only provides customers with replacement parts in as little as two hours and provides remote access any time to Partner Support professionals who can determine if a return materials authorization (RMA) is required. You can choose a desired service listed in [Table 37](#).

Table 37 PSS for UCS Hardware Only (PID UCSC-C240-M6S)

Service SKU	Service Level GSP	On Site?	Description
CON-PSW7-UCSCC20S	PSW7	Yes	UCS W PSS 24X7X4 OS
CON-PSWD7-UCSCC20S	PSWD7	Yes	UCS W PSS 24X7X4 DR*
CON-PSW6-UCSCC20S	PSW6	Yes	UCS W PSS 8X5X4 OS
CON-PSWD6-UCSCC20S	PSWD6	Yes	UCS W PSS 8X5X4 DR*
CON-PSW4-UCSCC20S	PSW4	No	UCS W PL PSS 24X7X2
CON-PSW3-UCSCC20S	PSW3	No	UCS W PL PSS 24X7X4
CON-PSW2-UCSCC20S	PSW2	No	UCS W PL PSS 8X5X4
Note: For PID UCSC-C240-M6S-CH, select Service SKU with UHCSCC24 suffix (Example: CON-PSW7-UHCSCC24)			
For PID UCSC-C240-M6SX, select Service SKU with UCSCXC24 suffix (Example: CON-PSW7-UCSCXC24)			
For PID UCSC-C240-M6SX-BR, select Service SKU with UCSCC24B suffix (Example: CON-PSW7-UCSCC24B)			
For PID UCSC-C240-M6SX-CH, select Service SKU with UCSCC24C suffix (Example: CON-PSW7-UCSCC24C)			
For PID UCSC-C240-M6N, select Service SKU with UCSC0C24 suffix (Example: CON-PSW7-UCSC0C24)			
For PID UCSC-C240-M6N-CH, select Service SKU with UCSCNC24 suffix (Example: CON-PSW7-UCSCNC24)			
For PID UCSC-C240-M6SN, select Service SKU with UC0CC2N4 suffix (Example: CON-PSW7-UC0CC2N4)			
For PID UCSC-C240-M6SN-BR, select Service SKU with UCSCRC24 suffix (Example: CON-PSW7-UCSCRC24)			
For PID UCSC-C240-M6SN-CH, select Service SKU with UCSCC24H suffix (Example: CON-PSW7-UCSCC24H)			
*Includes Drive Retention (see below for full description)			

Distributor Support Service

You can choose a desired service listed in [Table 38](#)

Table 38 DSS for UCS Support Service for UCS (PID UCSC-C240-M6S)

Service SKU	Service Level GSP	On Site?	Description
CON-DSCO-UCSCC20S	DSCO	Yes	DSS CORE 24X7X20S
CON-DSO-UCSCC20S	DSO	Yes	DSS CORE 24X7X4
CON-DSNO-UCSCC20S	DSNO	Yes	DSS CORE 8X5XNBDOS
CON-DSCC-UCSCC20S	DSCC	No	DSS CORE 24X7X2
CON-DCP-UCSCC20S	DCP	No	DSS CORE 24X7X4
CON-DSE-UCSCC20S	DSE	No	DSS CORE 8X5X4
CON-DSN-UCSCC20S	DSN	No	DSS CORE 8X5XNBD
Note: For PID UCSC-C240-M6S-CH, select Service SKU with UHCSCC24 suffix (Example: CON-DSO-UHCSCC24)			
For PID UCSC-C240-M6SX, select Service SKU with UCSCXC24 suffix (Example: CON-DSO-UCSCXC24)			
For PID UCSC-C240-M6SX-BR, select Service SKU with UCSCC24B suffix (Example: CON-DSO-UCSCC24B)			
For PID UCSC-C240-M6SX-CH, select Service SKU with UCSCC24C suffix (Example: CON-DSO-UCSCC24C)			
For PID UCSC-C240-M6N, select Service SKU with UCSC0C24 suffix (Example: CON-DSO-UCSC0C24)			
For PID UCSC-C240-M6N-CH, select Service SKU with UCSCNC24 suffix (Example: CON-DSO-UCSCNC24)			
For PID UCSC-C240-M6SN, select Service SKU with UC0CC2N4 suffix (Example: CON-DSO-UC0CC2N4)			
For PID UCSC-C240-M6SN-BR, select Service SKU with UCSCRC24 suffix (Example: CON-DSO-UCSCRC24)			
For PID UCSC-C240-M6SN-CH, select Service SKU with UCSCC24H suffix (Example: CON-DSO-UCSCC24H)			

Unified Computing Combined Support Service

Combined Services makes it easier to purchase and manage required services under one contract. SNTC services for UCS help increase the availability of your vital data center infrastructure and realize the most value from your unified computing investment. The more benefits you realize from the Cisco Unified Computing System (Cisco UCS), the more important the technology becomes to your business. These services allow you to:

- Optimize the uptime, performance, and efficiency of your UCS
- Protect your vital business applications by rapidly identifying and addressing issues
- Strengthen in-house expertise through knowledge transfer and mentoring
- Improve operational efficiency by allowing UCS experts to augment your internal staff resources
- Enhance business agility by diagnosing potential issues before they affect your operations

You can choose a desired service listed in [Table 39](#)

Table 39 DSS for UCS Support Service for UCS (PID UCSC-C240-M6S)

Service SKU	Service Level GSP	On Site?	Description
CON-NCF2P-UCSCC20S	NCF2P	Yes	CMB SVC 24X7X20S
CON-NCF4P-UCSCC20S	NCF4P	Yes	CMB SVC 24X7X40S
CON-NCF4S-UCSCC20S	NCF4S	Yes	CMB SVC 8X5X40S
CON-NCFCS-UCSCC20S	NCFCS	Yes	CMB SVC 8X5XNBDOS
CON-NCF2-UCSCC20S	NCF2	No	CMB SVC 24X7X2
CON-NCFP-UCSCC20S	NCFP	No	CMB SVC 24X7X4
CON-NCFE-UCSCC20S	NCFE	No	CMB SVC 8X5X4
CON-NCFT-UCSCC20S	NCFT	No	CMB SVC 8X5XNBD
CON-NCFW-UCSCC20S	NCFW	No	CMB SVC SW
Note: For PID UCSC-C240-M6S-CH, select Service SKU with UHCSCC24 suffix (Example: CON-NCF4P-UHCSCC24)			
For PID UCSC-C240-M6SX, select Service SKU with UCSCXC24 suffix (Example: CON-NCF4P-UCSCXC24)			
For PID UCSC-C240-M6SX-BR, select Service SKU with UCSCC24B suffix (Example: CON-NCF4P-UCSCC24B)			
For PID UCSC-C240-M6SX-CH, select Service SKU with UCSCC24C suffix (Example: CON-NCF4P-UCSCC24C)			
For PID UCSC-C240-M6N, select Service SKU with UCSC0C24 suffix (Example: CON-NCF4P-UCSC0C24)			
For PID UCSC-C240-M6N-CH, select Service SKU with UCSCNC24 suffix (Example: CON-NCF4P-UCSCNC24)			
For PID UCSC-C240-M6SN, select Service SKU with UC0CC2N4 suffix (Example: CON-NCF4P-UC0CC2N4)			
For PID UCSC-C240-M6SN-BR, select Service SKU with UCSCRC24 suffix (Example: CON-NCF4P-UCSCRC24)			
For PID UCSC-C240-M6SN-CH, select Service SKU with UCSCC24H suffix (Example: CON-NCF4P-UCSCC24H)			

UCS Drive Retention Service

With the Cisco Unified Computing Drive Retention Service, you can obtain a new disk drive in exchange for a faulty drive without returning the faulty drive.

Sophisticated data recovery techniques have made classified, proprietary, and confidential information vulnerable, even on malfunctioning disk drives. The Drive Retention service enables you to retain your drives and ensures that the sensitive data on those drives is not compromised, which reduces the risk of any potential liabilities. This service also enables you to comply with regulatory, local, and federal requirements.

If your company has a need to control confidential, classified, sensitive, or proprietary data, you might want to consider one of the Drive Retention Services listed in the above tables (where available).



NOTE: Cisco does not offer a certified drive destruction service as part of this service.

Local Language Technical Support for UCS

Where available, and subject to an additional fee, local language support for calls on all assigned severity levels may be available for specific product(s) - see tables above.

For a complete listing of available services for Cisco Unified Computing System, see the following URL:

http://www.cisco.com/en/US/products/ps10312/serv_group_home.html

SUPPLEMENTAL MATERIAL

Block Diagrams

Block diagrams of the C240 M6 SFF are shown in the following pages

Figure 12 UCSC-C240-M6S Block Diagram

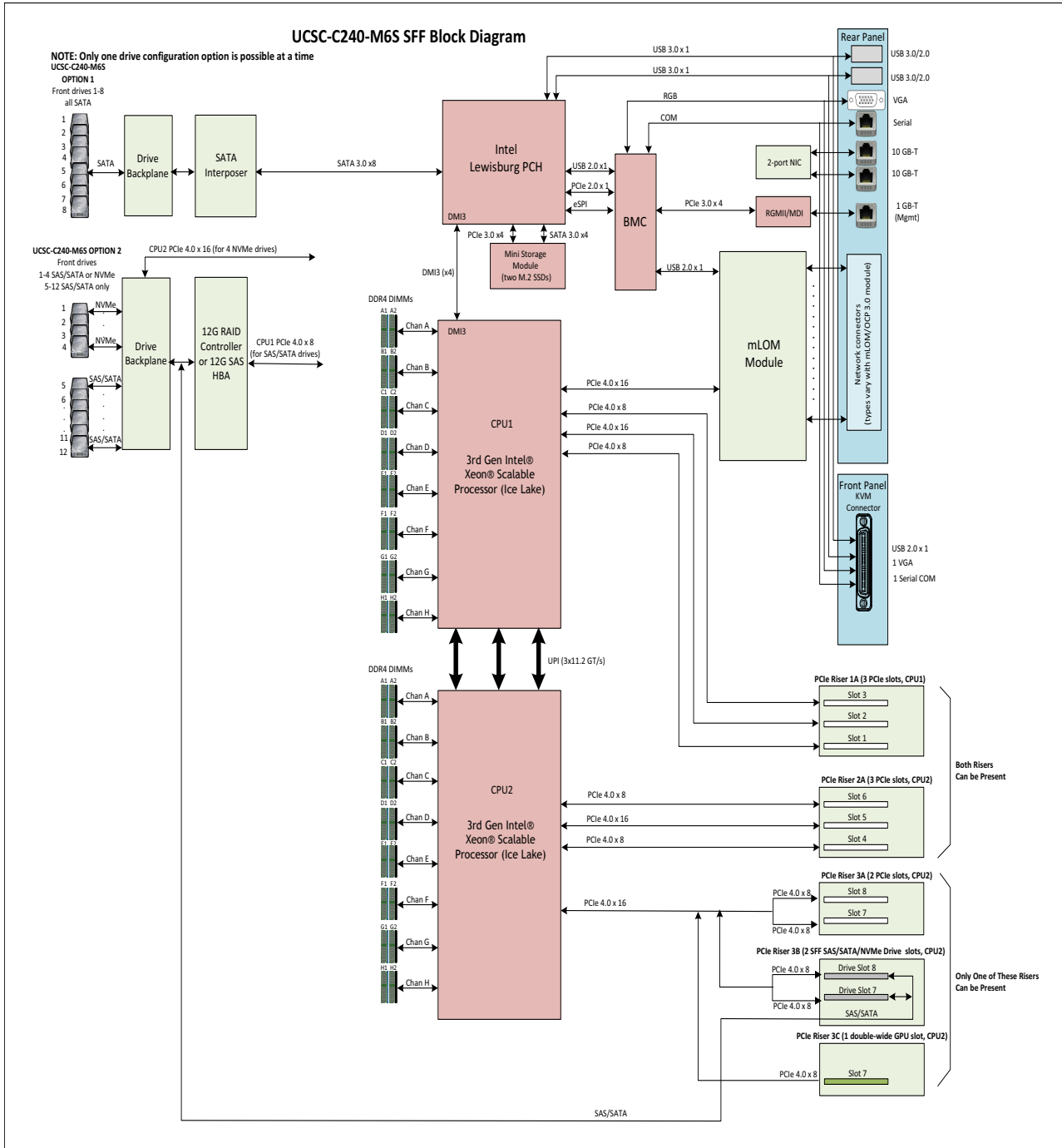

Figure 13 UCSC-C240-M6SX Block Diagram

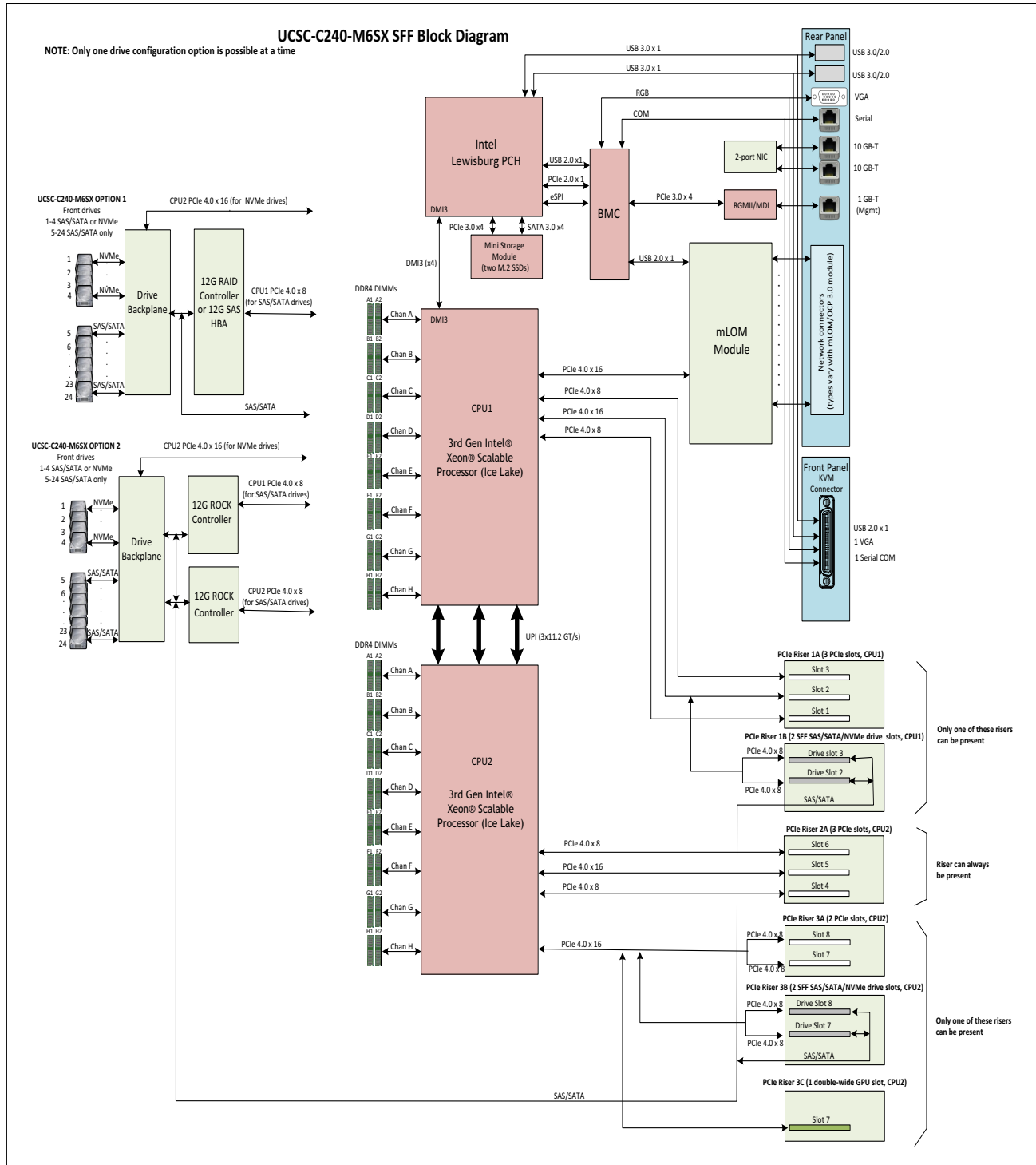
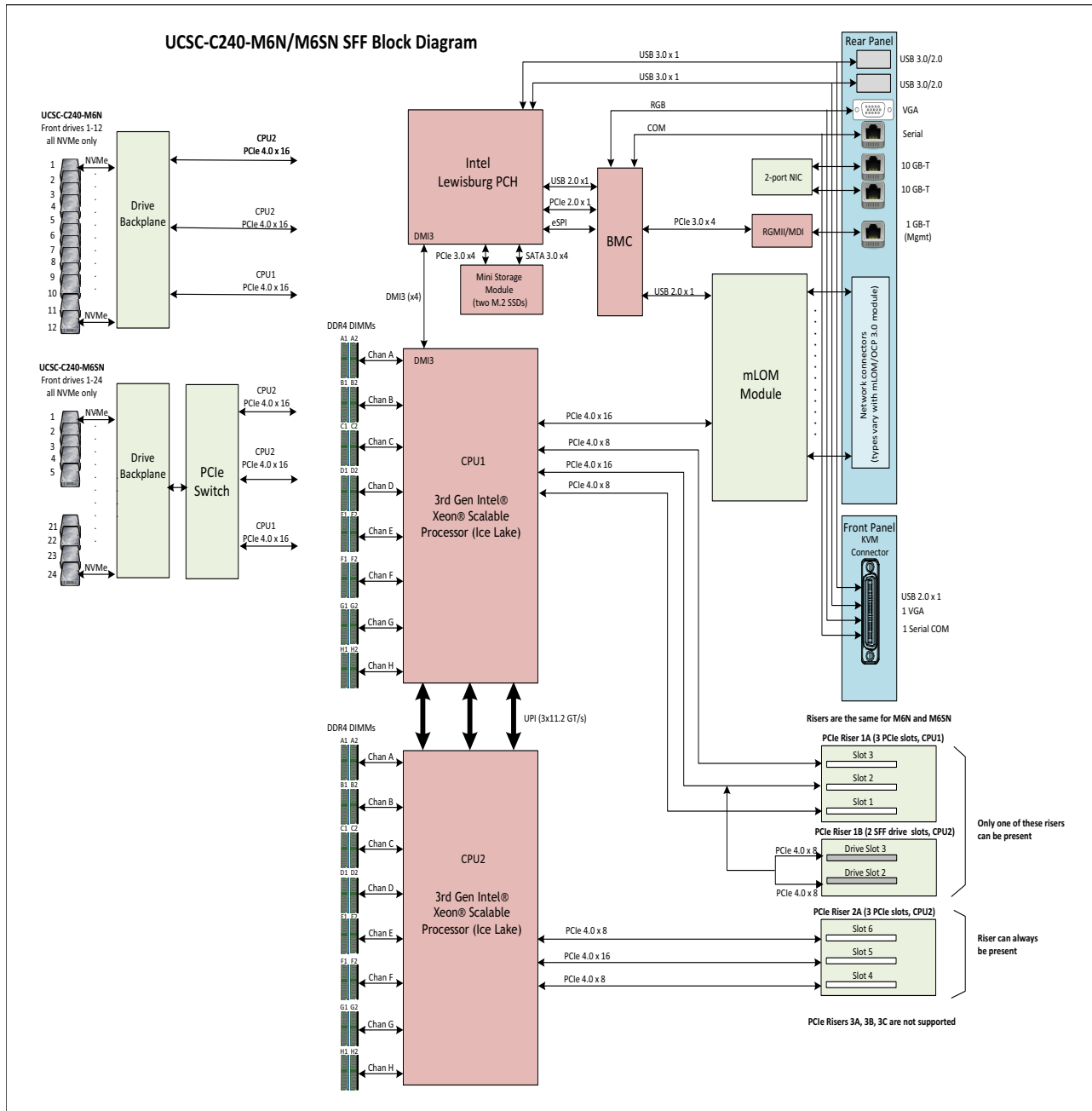

Figure 14 UCSC-C240-M6N/M6SN Block Diagram



Serial Port Details

The pinout details of the rear RJ-45 serial port connector are shown in [Figure 15](#).

Figure 15 Serial Port (Female RJ-45 Connector) Pinout
Serial Port (RJ-45 Female Connector)

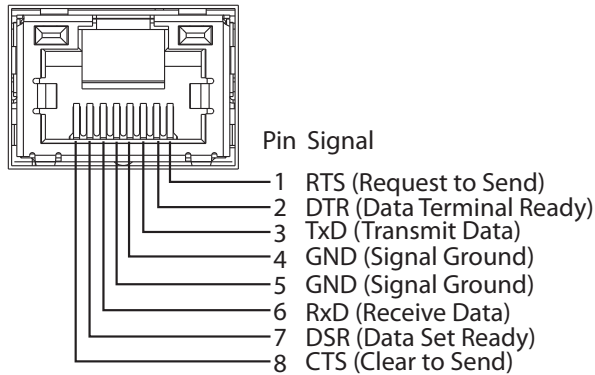

KVM Cable

The KVM cable provides a connection into the server, providing a DB9 serial connector, a VGA connector for a monitor, and dual USB 2.0 ports for a keyboard and mouse. With this cable, you can create a direct connection to the operating system and the BIOS running on the server.

The KVM cable ordering information is listed in [Table 40](#).

Table 40 KVM Cable

Product ID (PID)	PID Description
N20-BKVM	KVM cable for server console port

Figure 16 KVM Cable

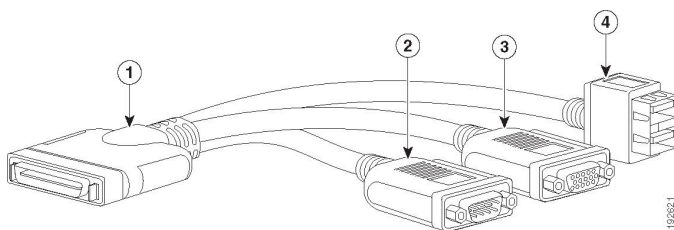

1	Connector (to server front panel)	3	VGA connector (for a monitor)
2	DB-9 serial connector	4	Two-port USB 2.0 connector (for a mouse and keyboard)

Chassis

An internal view of the C240 M6 chassis with the top cover removed is shown in [Figure 17](#).

Figure 17 C240 M6 Server With Top Cover Off

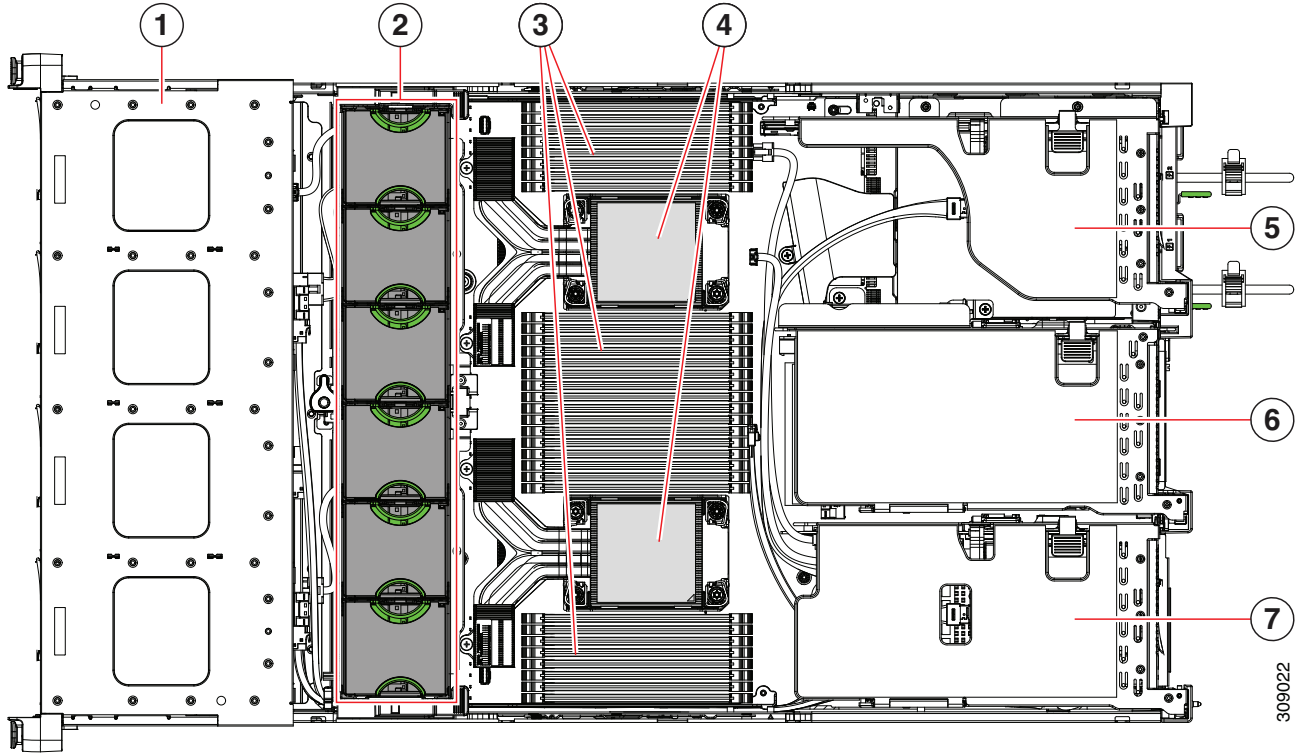

309022

1	Front-loading drive bays.	2	Cooling fan modules (six, hot-swappable)
3	DIMM sockets on motherboard (16 per CPU) An air baffle rests on top of the DIMMs and CPUs when the server is operating. The air baffle is not displayed in this illustration.	4	CPU sockets CPU 2 is at the top and CPU 1 is at the bottom.

<p>5</p>	<p>PCIe riser 3 (PCIe slots 7 and 8 numbered from bottom to top), with the following options:</p> <ul style="list-style-type: none"> ■ 3A (Default Option)—Slots 7 (x24 mechanical, x8 electrical), and 8 (x24 mechanical, x8 electrical). Both slots can accept a full height, full length GPU card. ■ 3B (Storage Option)—Slots 7 (x24 mechanical, x4 electrical) and 8 (x24 mechanical, x4 electrical). Both slots can accept 2.5-inch SFF universal HDDs. ■ 3C (GPU Option)—Slots 7 (x24 mechanical, x16 electrical) and 8 empty (NCSI support limited to one slot at a time). Slot 7 can support a full height, full length, double-wide GPU card. 	<p>6</p>	<p>PCIe riser 2 (PCIe slots 4, 5, 6 numbered from bottom to top), with the following options:</p> <ul style="list-style-type: none"> ■ 2A (Default Option)—Slot 4 (x24 mechanical, x8 electrical) supports full height, ¾ length card; Slot 5 (x24 mechanical, x16 electrical) supports full height, full length GPU card; Slot 6 (x24 mechanical, x8 electrical) supports full height, full length card.
<p>7</p>	<p>PCIe riser 1 (PCIe slot 1, 2, 3 numbered bottom to top), with the following options:</p> <ul style="list-style-type: none"> ■ 1A (Default Option)—Slot 1 (x24 mechanical, x8 electrical) supports full height, ¾ length card; Slot 2 (x24 mechanical, x16 electrical) supports full height, full length GPU card; Slot 3 (x24 mechanical, x8 electrical) supports full height, full length card. ■ 1B (Storage Option)—Slot 1 is reserved; Slot 2 (x4 electrical), supports 2.5-inch SFF universal HDD; Slot 3 (x4 electrical), supports 2.5-inch SFF universal HDD 	<p>-</p>	

Risers

Figure 18 shows the locations of the PCIe riser connectors on the C240 M6 SFF motherboard.

Figure 18 C240 M6 SFF Riser Connector Locations

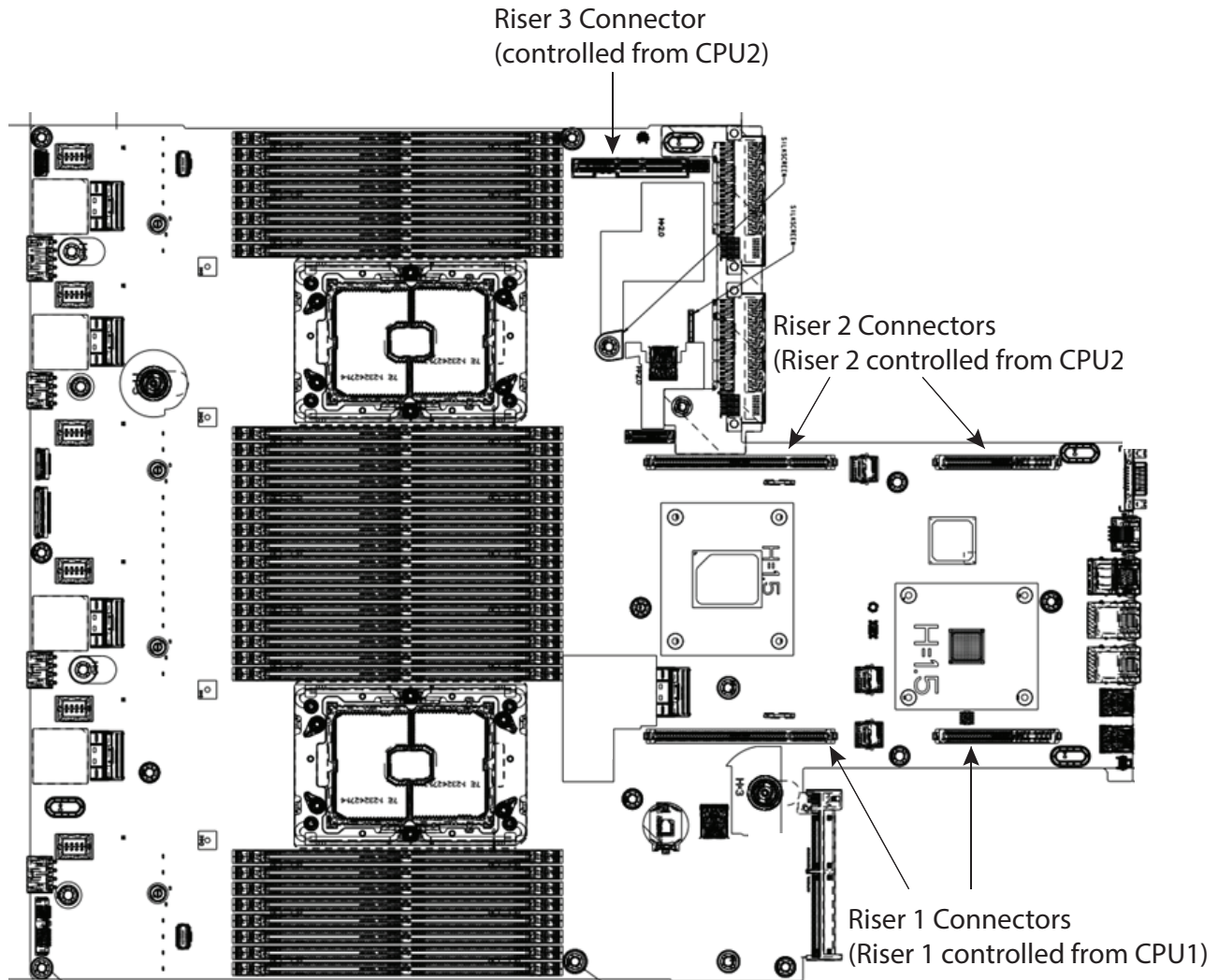
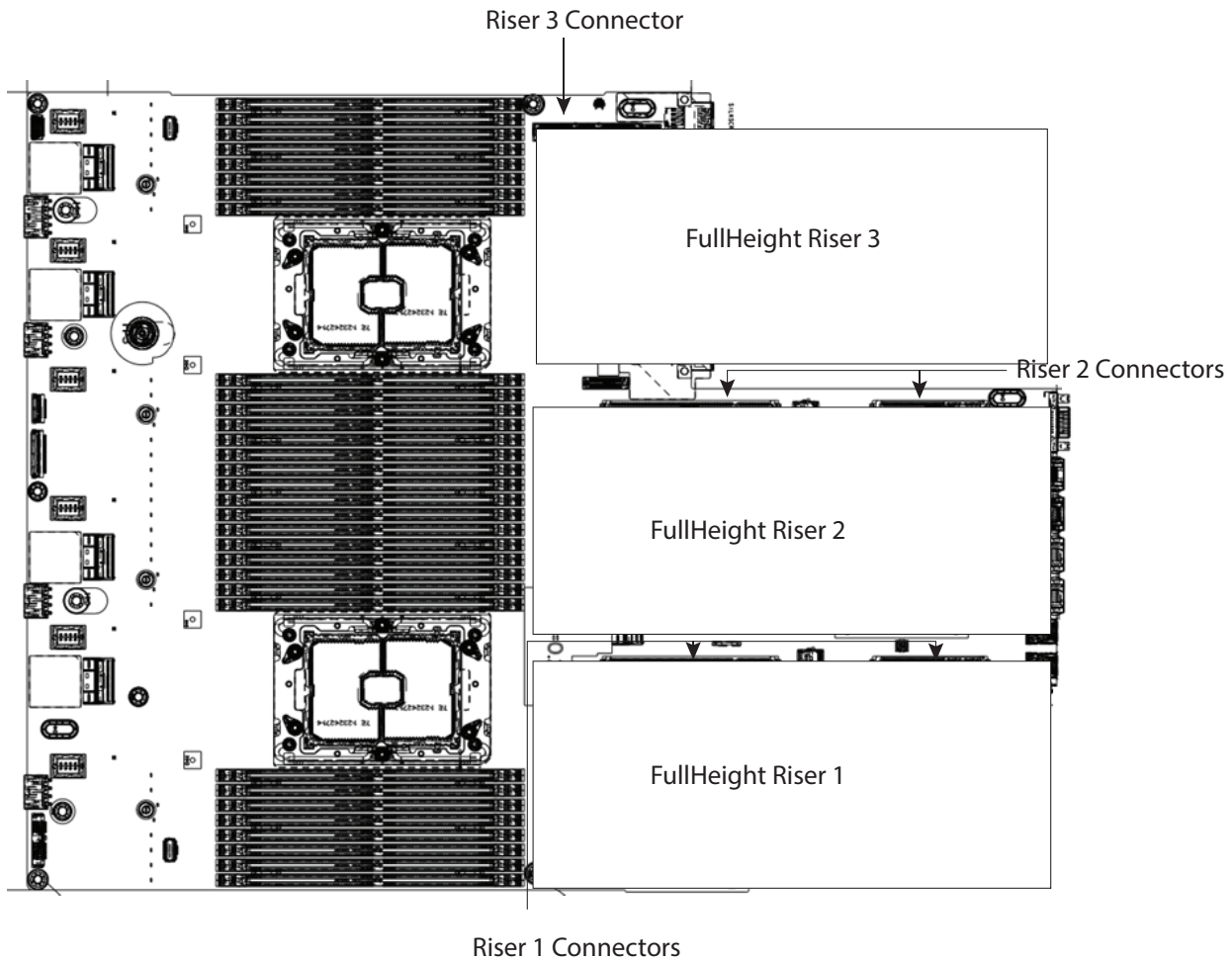

Figure 19 shows the locations of the PCIe riser connectors on the C240 M6 SFF motherboard.

Figure 19 C240 M6 SFF Riser Connector Locations



Riser Card Configuration and Options

The riser card locations are shown in [Figure 20](#).

Figure 20 Riser Card Locations

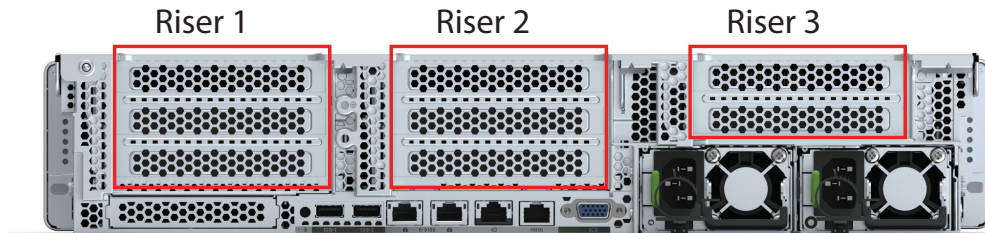

Riser 1A

Riser 1A mechanical information is shown in [Figure 21](#).

Figure 21 Riser Card 1A

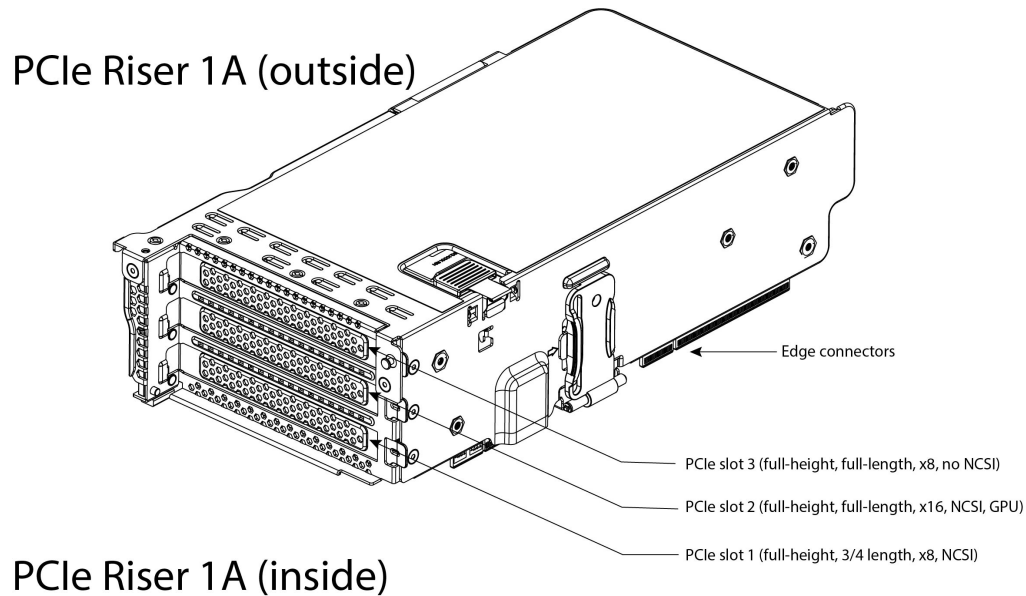

Riser 1B

Riser 1B mechanical information is shown in [Figure 22](#).

Figure 22 Riser Card 1B

PCIe Riser 1B (outside)

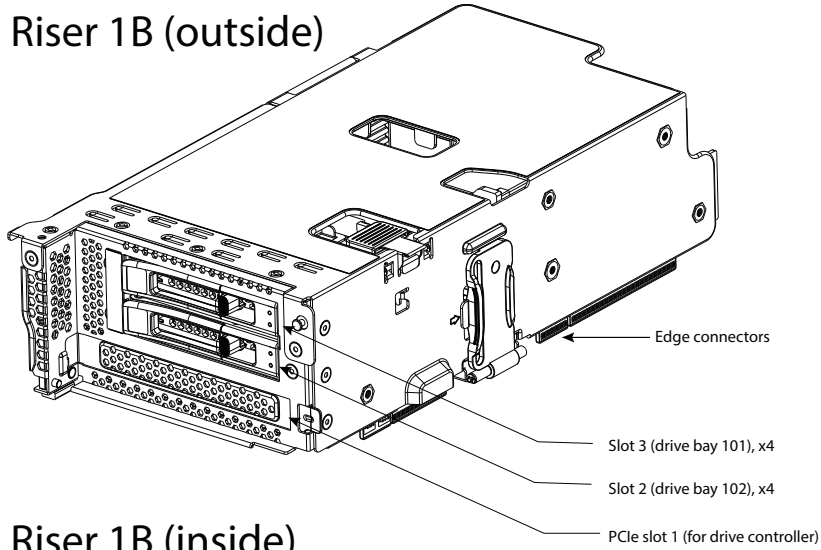

PCIe Riser 1B (inside)

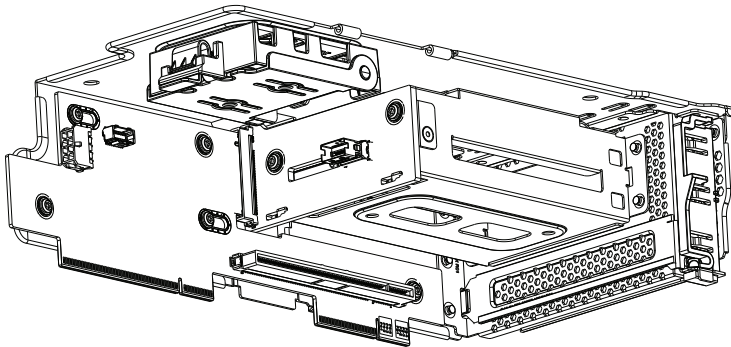

Riser 2A

Riser 2A mechanical information is shown in [Figure 23](#).

Figure 23 Riser Card 2A

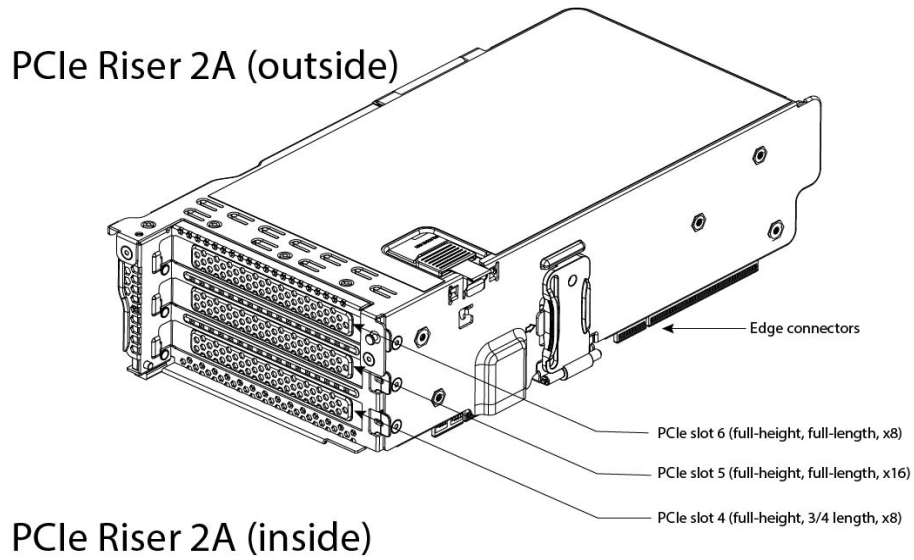

PCIe Riser 2A (inside)

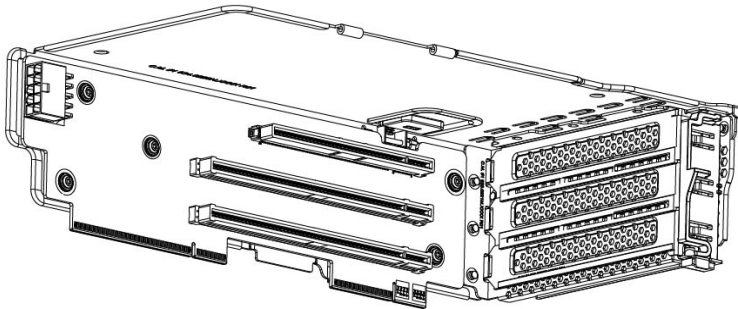

Riser 3A

Riser 3A mechanical information is shown in [Figure 24](#).

Figure 24 Riser Card 3A

PCIe Riser 3A (outside)

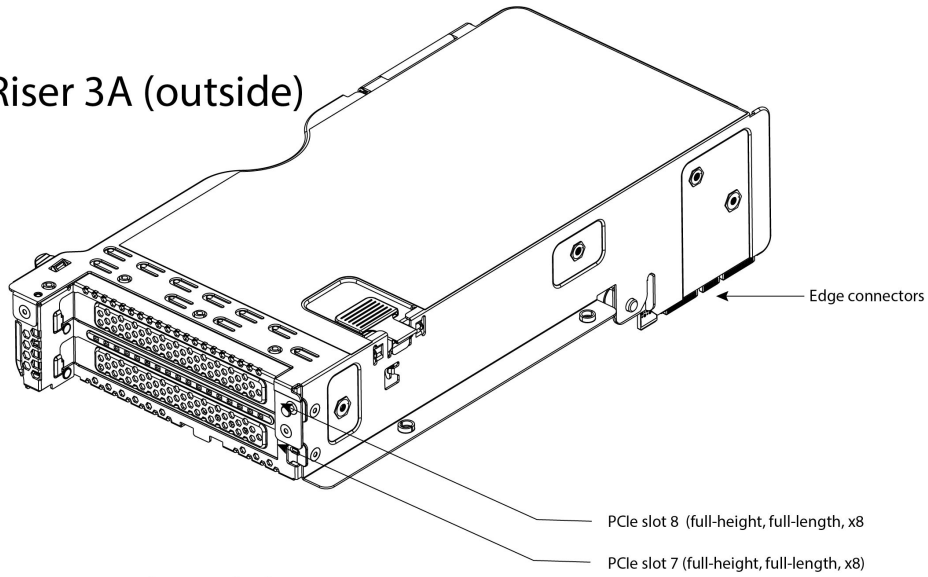

PCIe Riser 3A (inside)

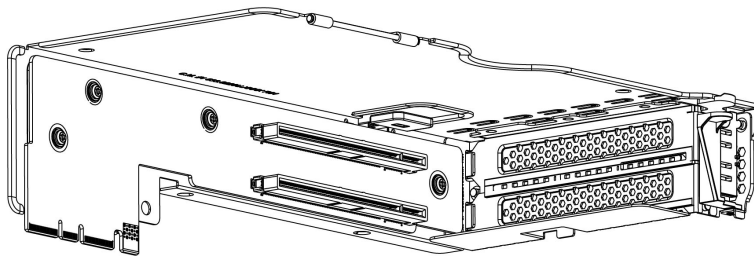

Riser 3B

Riser 3B mechanical information is shown in [Figure 25](#).

Figure 25 Riser Card 3B

PCIe Riser 3B (outside)

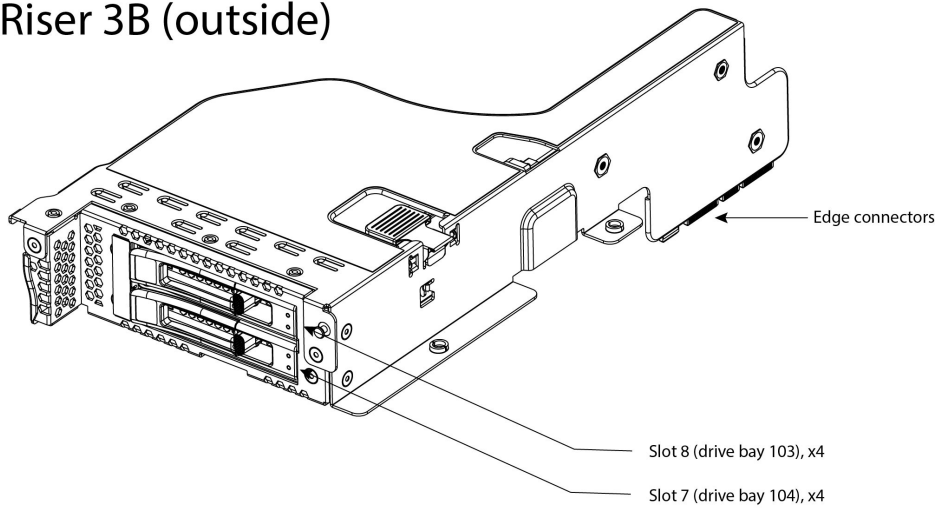

PCIe Riser 3B (inside)

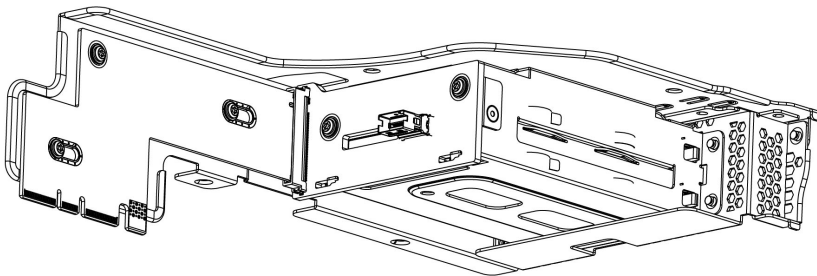

Riser 3C

Riser 3C mechanical information is shown in [Figure 26](#).

Figure 26 Riser Card 3C

PCIe Riser 3C (outside)

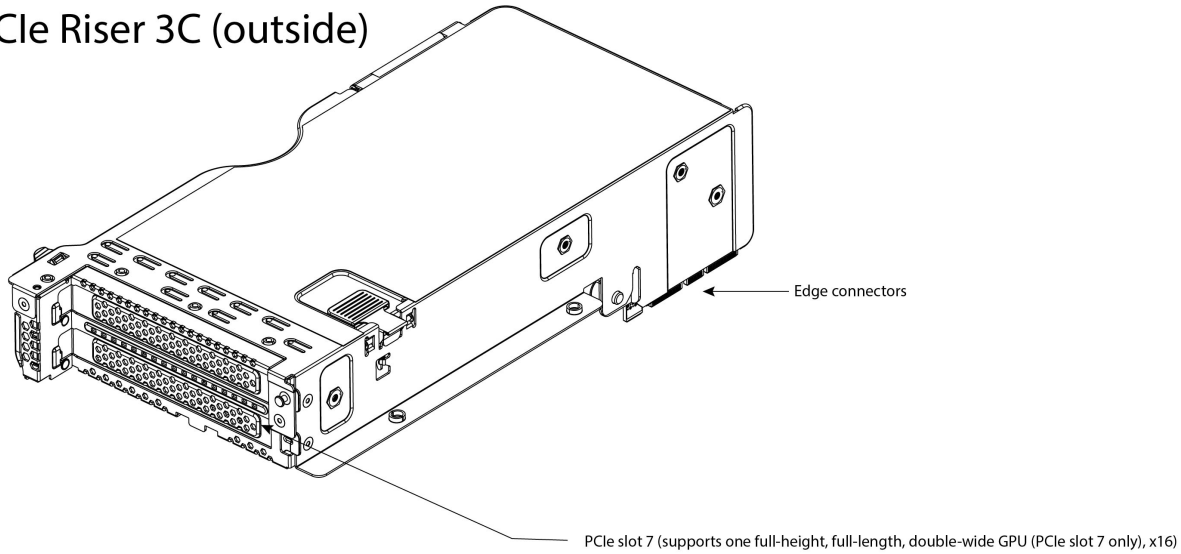

PCIe Riser 3C (inside)

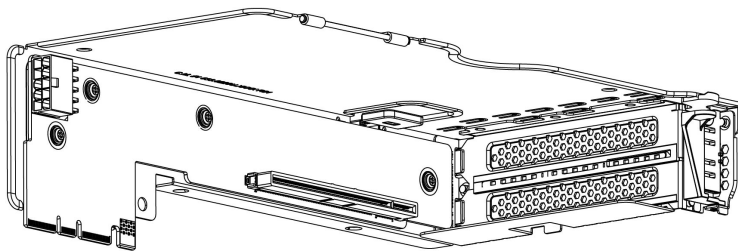

Memory Support for 3rd Generation Intel® Xeon® Scalable Processors (Ice Lake)

PMem Support

The Ice Lake CPUs support two memory modes:

- App Direct Mode
- Memory Mode

App Direct Mode

PMem operates as a solid-state disk storage device. Data is saved and is non-volatile. Both DCPMM and DIMM capacities count towards the CPU capacity limit.

For example, if App Direct mode is configured and the DIMM sockets for a CPU are populated with 8 x 256 GB DRAMs (2 TB total DRAM) and 8 x 512 GB PMem (4 TB total PMem), then 6 TB counts towards the CPU capacity limit. Follow the Intel recommended DRAM:PMem ratio for App Direct Mode.

Memory Mode

PMem operates as a 100% memory module. Data is volatile and DRAM acts as a cache for PMem. Only the PMem capacity counts towards the CPU capacity limit). This is the factory default mode.

For example, if Memory mode is configured and the DIMM sockets for a CPU are populated with 8 x 256 GB DRAMs (2 TB total DRAM) and 8 x 512 GB PMem (4 TB total PMem), then only 4 TB total (the PMem memory) counts towards the CPU capacity limit. All of the DRAM capacity (2 TB) is used as cache and does not factor into CPU capacity. The recommended Intel DRAM:PMem ratio for Memory Mode is 1:4, 1:8, or 1:16.

For 3rd Generation Intel® Xeon® Ice Lake® Processors:

- DRAMs and PMem are supported
- Each CPU has 16 DIMM sockets and supports the following maximum memory capacities:
 - 4 TB using 16 x 256 GB DRAMs, or
 - 6 TB using 8 x 256 GB DRAMs and 8 x 512 GB Intel® Optane™ Persistent Memory Modules (PMem)

Only the following mixed DRAM/PMem memory configurations are supported per CPU socket:

- 4 DRAMs and 4 PMem, or 8 DRAMs and 4 PMem, or 8 DRAMs and 1 PMem, or 8 DRAMs and 8 PMem

The available DRAM capacities are 32 GB, 64 GB, 128 GB, or 256 GB.

The available PMem capacities are 128 GB, 256 GB, or 512 GB

For further details see the following link:

<https://www.cisco.com/c/dam/en/us/products/collateral/servers-unified-computing/ucs-c-series-rack-servers/c220-c240-b200-m6-memory-guide.pdf>

SPARE PARTS

This section lists the upgrade and service-related parts for the UCS C240 M6 server. Some of these parts are configured with every server.



NOTE: Some spare parts you order may also require accessories for full functionality. For example, drives or RAID controllers may need accompanying cables. CPUs may need heatsinks, thermal paste, and installation tools. The spares and their accessory parts are listed in [Table 41](#).

Table 41 Spare Parts

Product ID (PID)	PID Description
KVM Cable	
N20-BKVM=	KVM local IO cable for UCS servers console port
Risers	
<p>Note: If you are ordering a Riser, see the Riser Cable and Accessories section in this table for additional parts you may need to order for the Risers</p>	
UCSC-RIS1A-240M6=	C240 M6 Riser1A; (x8;x16x, x8); StBkt; (CPU1)
UCSC-RIS1B-240M6=	C240 M6 Riser1B; 2xHDD; x16; StBkt; (CPU1)
UCSC-RIS2A-240M6=	C240 M6 Riser2A; (x8;x16;x8);StBkt; (CPU2)
UCSC-RIS3A-240M6=	C240 M6 Riser3A (x8;x8); StBkt; (CPU2)
UCSC-RIS3B-240M6=	C240 M6 Riser 3B; 2xHDD; StBkt; (CPU2)
UCSC-RIS3C-240M6=	C240 M6 Riser 3C
Riser Cable and Accessories	
CBL-RSASR1B-240M6=	C240M6 2U x2 Rear SAS/SATA cable; (Riser1B)
<p>Note: This cable may required, if you order riser PID UCSC-RIS1B-240M6 and UCSC-RAID-M6SD or UCSC-SAS-240M6 for UCSC-C240-M6SX</p>	

Table 41 Spare Parts (continued)



Product ID (PID)	PID Description
CBL-RSASR3B-240M6=  Note: This cable may required, if you order riser PID UCSC-RIS3B-240M6 and SAS/SATA rear drive and UCSC-SAS-240M6 or UCSC-RAID-C240M6	C240M6 2U x2 Rear SAS/SATA cable; (Riser3B)
CBL-R1B-SD-240M6=  Note: This cable set may required, if you are adding UCSC-RIS1B-240M6 and UCSC-RAID-M6SD to UCSC-C240-M6SX	CBL C240 M6SX (2U24) to Riser 1B
UCSC-FBRS2-C240M6=	C240M6 2U Riser2 Filler Blank
UCSC-FBRS3-C240M6=	C240M6 2U Riser3 Filler Blank
CPUs  Note: If you are ordering a second CPU, see the CPU Accessories section in this table for additional parts you may need to order for the second CPU.	
8000 Series Processors	
UCS-CPU-I8380=	
UCS-CPU-I8368=	
UCS-CPU-I8362=	
UCS-CPU-I8360Y=	
UCS-CPU-I8358P=	
UCS-CPU-I8358=	
UCS-CPU-I8352M=	
UCS-CPU-I8352Y=	
UCS-CPU-I8352V=	
UCS-CPU-I8352S=	
UCS-CPU-I8351N ¹ =	
6000 Series Processors	

Table 41 Spare Parts (continued)

Product ID (PID)	PID Description
UCS-CPU-I6354=	
UCS-CPU-I6348=	
UCS-CPU-I6346=	
UCS-CPU-I6342=	
UCS-CPU-I6338N=	
UCS-CPU-I6338T=	
UCS-CPU-I6338=	
UCS-CPU-I6336Y=	
UCS-CPU-I6334=	
UCS-CPU-I6330N=	
UCS-CPU-I6330=	
UCS-CPU-I6326=	
UCS-CPU-I6314U ²	
UCS-CPU-I6312U ³ =	
5000 Series Processors	
UCS-CPU-I5320T=	
UCS-CPU-I5320=	
UCS-CPU-I5318N=	
UCS-CPU-I5318S=	
UCS-CPU-I5318Y=	
UCS-CPU-I5317=	
UCS-CPU-I5315Y=	
4000 Series Processors	
UCS-CPU-I4316=	
UCS-CPU-I4314=	
UCS-CPU-I4310T=	
UCS-CPU-I4310=	
UCS-CPU-I4309Y=	

Table 41 Spare Parts (continued)





Product ID (PID)	PID Description
CPU Accessories	
UCS-CPU-TIM=  Note: This part is included with the purchase of spare CPU.Can be ordered separately.	Single CPU thermal interface material syringe for M5 server HS seal ⁴
UCS-M6-CPU-CAR=  Note: This part is included with the purchase of spare CPU.Can be ordered separately.	Spare CPU Carrier for M6
UCSX-HSCK=  Note: This part is included with the purchase of spare CPU.Can be ordered separately.	UCS CPU/Heatsink Cleaning Kit, for up to 4 CPU/heatsink sets
UCS-CPUAT=  Note: This part is included with the purchase of spare CPU.Can be ordered separately.	CPU Assembly Tool for Servers
UCSC-HSHP-240M6=  Note: Order this Heatsink, if you are adding additional CPU/spare CPU	Heatsink for 2U SFF M6 PCIe SKU
UCSC-FAN-C240M6=	C240M6 2U Fan
Memory	
3200-MHz DIMMs	
UCS-MR-X16G1RW=	16 GB RDIMM SRx4 3200 (8Gb)
UCS-MR-X32G2RW=	32 GB RDIMM DRx4 3200 (8Gb)
UCS-MR-X32G1RW=	32 GB RDIMM SRx4 3200 (16Gb)
UCS-MR-X64G2RW=	64 GB RDIMM DRx4 3200 (16Gb)
UCS-ML-128G4RW=	128 GB LRDIMM QRx4 3200 (16Gb)

Table 41 Spare Parts (continued)



Product ID (PID)	PID Description
UCS-ML-256G8RW=	256 GB LRDIMM 8Rx4 3200 (16Gb)
Intel® Optane™ Persistent Memory (PMem)	
UCS-MP-128GS-B0=	Intel® Optane™ Persistent Memory, 128GB, 3200 MHz
UCS-MP-256GS-B0=	Intel® Optane™ Persistent Memory, 256 GB, 3200 MHz
UCS-MP-512GS-B0=	Intel® Optane™ Persistent Memory, 512 GB, 3200 MHz
DIMM Blank	
UCS-DIMM-BLK=	UCS DIMM Blank
 <p>Note: Order this DIMM Blank, if you are not using DIMM slots. Any empty DIMM slot must be populated with a DIMM blank to maintain proper cooling airflow.</p>	
Drives	
 <p>Note: When ordering additional SAS/SATA or NVMe front or rear drives, you may need to order a cable to connect from the drive to the motherboard. See the Drive Cables section in this table.</p>	
HDDs	
HDDs (15K RPM)	
UCS-HD900G15K12N=	900 GB 12G SAS 15K RPM SFF HDD
UCS-HD300G15K12N=	300 GB 12G SAS 15K RPM SFF HDD
UCS-HD600G15K12N=	600 GB 12G SAS 15K RPM SFF HDD
HDDs (10K RPM)	
UCS-HD300G10K12N=	300 GB 12G SAS 10K RPM SFF HDD
UCS-HD600G10K12N=	600 GB 12G SAS 10K RPM SFF HDD
UCS-HD12TB10K12N=	1.2 TB 12G SAS 10K RPM SFF HDD
UCS-HD18TB10K4KN=	1.8 TB 12G SAS 10K RPM SFF HDD (4K)
UCS-HD24TB10K4KN=	2.4 TB 12G SAS 10K RPM SFF HDD (4K)
Enterprise Performance SAS/SATA SSDs (High endurance, supports up to 10X or 3X DWPD (drive writes per day))	
UCS-SD19T63X-EP=	1.9 TB 2.5in Enterprise performance 6GSATA SSD(3X endurance)

Table 41 Spare Parts (continued)

Product ID (PID)	PID Description
UCS-SD960G63X-EP=	960 GB 2.5in Enterprise performance 6GSATA SSD(3X endurance)
UCS-SD480G63X-EP=	480 GB 2.5in Enterprise Performance 6GSATA SSD(3X endurance)
UCS-SD19TBM3X-EP=	1.9TB 2.5in Enterprise performance 6GSATA SSD(3X endurance)
UCS-SD960GBM3X-EP=	960GB 2.5in Enterprise performance 6GSATA SSD(3X endurance)
UCS-SD480GBM3X-EP=	480GB 2.5in Enterprise Performance 6GSATA SSD(3X endurance)
UCS-SD800GK3X-EP=	800 GB 2.5in Enterprise Performance 12G SAS SSD(3X endurance)
UCS-SD38T63X-EP=	3.8TB 2.5in Enter Perf 6G SATA Intel SSD (3X)
UCS-SD32TKA3X-EP=	3.2TB 2.5in Enter Perf 12G SAS Kioxia G2 SSD (3X)
UCS-SD16TKA3X-EP=	1.6TB 2.5in Enterprise Performance 12G SAS SSD(3X endurance)
UCS-SD800GS3X-EP=	800GB 2.5in Enter Perf 12G SAS Seagate SSD (3X)
UCS-SD16TS3X-EP=	1.6TB 2.5in Enter Perf 12G SAS Seagate SSD (3X)
UCS-SD32TS3X-EP=	3.2TB 2.5in Enter Perf 12G SAS Seagate SSD (3X)
Enterprise Value SAS/SATA SSDs (Low endurance, supports up to 1X DDPD (drive writes per day))	
UCS-SD38T6I1X-EV=	3.8 TB 2.5 inch Enterprise Value 6G SATA SSD
UCS-SD960G6I1X-EV=	960 GB 2.5 inch Enterprise Value 6G SATA SSD
UCS-SD480G6I1X-EV=	480 GB 2.5 inch Enterprise Value 6G SATA SSD
UCS-SD19T6I1X-EV=	1.9 TB 2.5 inch Enterprise Value 6G SATA SSD
UCS-SD38T6I1X-EV=	3.8 TB 2.5 inch Enterprise Value 6G SATA SSD
UCS-SD120GM1X-EV=	120 GB 2.5 inch Enterprise Value 6G SATA SSD
UCS-SD960GK1X-EV=	960 GB 2.5 inch Enterprise Value 12G SAS SSD
UCS-SD19TM1X-EV=	1.9TB 2.5in Enter Value 6G SATA Micron G1 SSD
UCS-SD15TKA1X-EV=	15.3TB 2.5in Enter Value 12G SAS Kioxia G2 SSD
UCS-SD76TKA1X-EV=	7.6TB 2.5 inch Enterprise Value 12G SAS SSD
UCS-SD38TKA1X-EV=	3.8TB 2.5 inch Enterprise Value 12G SAS SSD
UCS-SD19TKA1X-EV=	1.9TB 2.5 inch Enterprise Value 12G SAS SSD
UCS-SD960G6S1X-EV=	960GB 2.5 inch Enterprise Value 6G SATA SSD
UCS-SD19T6S1X-EV=	1.9TB 2.5 inch Enterprise Value 6G SATA SSD
UCS-SD38T6S1X-EV=	3.8TB 2.5 inch Enterprise Value 6G SATA SSD

Table 41 Spare Parts (continued)

Product ID (PID)	PID Description
UCS-SD76T6S1X-EV=	7.6TB 2.5 inch Enterprise Value 6G SATA SSD
UCS-SD76TBM1X-EV=	7.6TB 2.5 inch Enterprise Value 6G SATA SSD
UCS-SD38TBM1X-EV=	3.8TB 2.5 inch Enterprise Value 6G SATA SSD
UCS-SD19TBM1X-EV=	1.9TB 2.5 inch Enterprise Value 6G SATA SSD
UCS-SD16TBM1X-EV=	1.6TB 2.5 inch Enterprise Value 6G SATA SSD
UCS-SD960GBM1X-EV=	960GB 2.5 inch Enterprise Value 6G SATA SSD
UCS-SD480GBM1X-EV=	480GB 2.5 inch Enterprise Value 6G SATA SSD
UCS-SD240GBM1X-EV=	240GB 2.5 inch Enterprise Value 6G SATA SSD
Self-Encrypted Drives (SED)	
UCS-HD18T10NK9=	1.8 TB 12G SAS 10K RPM SFF HDD (4K format, SED)
UCS-HD24T10NK9=	2.4TB 10k rpm 4k SED HDD
UCS-HD12T10NK9=	1.2TB 12G SAS 10K RPM SFF HDD (SED-FIPS)
UCS-HD600G15NK9=	600 GB 12G SAS 15K RPM SFF HDD (SED)
UCS-SD800GBKNK9=	800 GB Enterprise Performance SAS SSD (3X DWPD, SED)
UCS-SD960GBKNK9=	960 GB Enterprise Value SAS SSD (1X DWPD, SED)
UCS-SD76TBKNK9=	7.6TB Enterprise value SAS SSD (1 DWPD, SED-FIPS)
UCS-SD38TBKNK9=	3.8 TB Enterprise Value SAS SSD (1X DWPD, SED)
UCS-SD76TEM2NK9=	7.6TB Enterprise value SATA SSD (1X, SED)
UCS-SD960GM2NK9=	960GB Enterprise value SATA SSD (1X , SED)
UCS-SD76TBKANK9=	7.6TB Enterprise value SAS SSD (1 DWPD, SED-FIPS)
UCS-SD38TBKANK9=	3.8TB 2.5in Enterprise value 12G SAS SSD (1DWPD, SED-FIPS)
UCS-SD16TBKANK9=	1.6TB 2.5in Enter Perf 12G SAS Kioxia G2 SSD (3X SED-FIPS)
PCIe / NVMe (2.5-inch) SFF Drives	
UCSC-NVMEXPB-I375=	375 GB 2.5in Intel® Optane™ NVMe Extreme Performance SSD
UCSC-NVMEXP-I750=	750 GB 2.5in Intel® Optane™ NVMe Extreme Perf.
UCS-NVMEI4-I1600=	1.6 TB 2.5in U.2 Intel P5600 NVMe High Perf Medium Endurance
UCS-NVMEI4-I3200=	3.2 TB 2.5in U.2 Intel P5600 NVMe High Perf Medium Endurance
UCS-NVMEXP-I400=	400GB 2.5in U.2 Intel P5800X Optane NVMe Extreme Perform SSD

Table 41 Spare Parts (continued)

Product ID (PID)	PID Description
UCS-NVMEXP-I800=	800GB 2.5in U.2 Intel P5800X Optane NVMe Extreme Perform SSD
UCS-NVME4-1920=	1.9TB 2.5in U.2 15mm P5520 Hg Perf Med End NVMe
UCS-NVME4-3840=	3.8TB 2.5in U.2 15mm P5520 Hg Perf Med End NVMe
UCS-NVME4-7680=	7.6TB 2.5in U.2 15mm P5520 Hg Perf Med End NVMe
UCS-NVME4-1536=	15.3TB 2.5in U.2 15mm P5520 Hg Perf Med End NVMe
UCS-NVME4-1600=	1.6TB 2.5in U.2 15mm P5620 Hg Perf Hg End NVMe (3X)
UCS-NVME4-3200=	3.2TB 2.5in U.2 15mm P5620 Hg Perf Hg End NVMe (3X)
UCS-NVME4-6400=	6.4TB 2.5in U.2 15mm P5620 Hg Perf Hg End NVMe (3X)
UCS-NVMEQ-1536=	15.3TB 2.5in U.2 15mm P5316 Hg Perf Low End NVMe
UCS-NVMEM6-W3200=	3.2 TB 2.5in U.2 WD SN840 NVMe Extreme Perf. High Endurance
UCS-NVMEM6-W7680 =	7.6 TB 2.5in U.2 WD SN840 NVMe Extreme Perf. Value Endurance
UCS-NVMEM6-W15300=	15.3 TB 2.5in U.2 WD SN840 NVMe Extreme Perf. Value Endurance
UCS-NVMEG4-M960=	960GB 2.5in U.3 Micron P7450 NVMe High Perf Medium Endurance
UCS-NVMEG4-M1920=	1.9TB 2.5in U.3 Micron P7450 NVMe High Perf Medium Endurance
UCS-NVMEG4-M3840=	3.8TB 2.5in U.3 Micron P7450 NVMe High Perf Medium Endurance
UCS-NVMEG4-M7680=	7.6TB 2.5in U.3 Micron P7450 NVMe High Perf Medium Endurance
UCS-NVMEG4-M1536=	15.3TB 2.5in U.3 Micron P7450 NVMe High Perf Medium Endurance
UCS-NVMEG4-M1600=	1.6TB 2.5in U.3 Micron P7450 NVMe High Perf High Endurance
UCS-NVMEG4-M3200=	3.2TB 2.5in U.3 Micron P7450 NVMe High Perf High Endurance
UCS-NVMEG4-M6400=	6.4TB 2.5in U.3 Micron P7450 NVMe High Perf High Endurance
Drive Cables	
CBL-SATA-C240M6=	SATA cable C240M6 (2U)
 <p>Note: This cable may required, if you are adding a front SAS/SATA drive to UCSC-C240-M6S</p>	

Table 41 Spare Parts (continued)





Product ID (PID)	PID Description
CBL-FNVME-240M6=  Note: This cable set may required, if you are adding a front NVMe drive. This cable supported only with the SAS HBA controller.	C240M6 2U x4 Front NVMe cable (two cables)
Drive Blanking Panel	
UCSC-BBLKD-S2=	C-Series M5 SFF drive blanking panel
RAID Controllers	
UCSC-SAS-240M6=	Cisco 12G SAS HBA (for UCSC-C240-M6S and UCSC-C240-M6SX servers)
UCSC-RAID-240M6=  Note: Supercap (UCSC-SCAP-M6=), Cable (CBL-SCAP-C240M6=) included when RAID card is ordered as a spare	Cisco 12G SAS RAID controller SuperCap and 4GB FBWC (for UCSC-C240-M6S)
UCSC-RAID-M6SD=  Note: Supercap (UCSC-SCAP-M6=), Cable (CBL-SCAPSD-C240M6=) included when RAID card is ordered as a spare	Cisco M6 12G SAS RAID controller with SuperCap and 4GB FBWC (for UCSC-C240-M6S and UCSC-C240-M6SX servers)
RAID Controller Accessories	
UCS-SCAP-M6=	M6 Supercap for write cache backup
CBL-SCAPSD-C240M6=	CBL Super Cap for PB+ C240 M6
CBL-SCAP-C240M6=	C240M6 2U Super Cap cable
CBL-SDSAS-240M6=  Note: This cable set may required, if you are adding UCSC-RAID-M6SD to UCSC-C240-M6SX	CBL C240 M6SX (2U24) MB CPU1(NVMe-Drive)

Table 41 Spare Parts (continued)





Product ID (PID)	PID Description
CBL-SAS24-240M6=  Note: This cable set may required, if you are adding SAS Drive and UCSC-SAS-240M6 (quantity 2)	C240M6 SAS cable 24 (2U); Pismo Rock
CBL-SAS12-240M6=  Note: This cable set may required, if you are adding SAS Drive and UCSC-SAS-240M6 (quantity 1)	C240M6 SAS cable 12 (2U); (Pismo Rock/Beach)
M.2 SATA SSDs  Note: When ordering additional RAID controllers, you may need some the accessories to install it. See the M.2 SATA SSDs Accessories section in this table.	
UCS-M2-I240GB=	240GB SATA M.2 SSD
UCS-M2-I480GB=	480GB SATA M.2 SSD
UCS-M2-192TB=	1.9 TB SATA M.2
UCS-M2-240G=	240GB SATA M.2
UCS-M2-480G=	480GB M.2 SATA SSD
UCS-M2-960G=	960GB SATA M.2
UCS-M2-HWRAID=	Cisco Boot optimized M.2 RAID controller (holds up to two M.2 SATA SSDs)
M.2 SATA SSDs Accessories	
UCSC-M2EXT-240M6=  Note: When ordering UCS-M2-HWRAID spare, you may need to order M.2 Extender board.	C240M6 2U M.2 Extender board
PCIe Cards	
Modular LAN on Motherboard (mLOM)	
UCSC-M-V25-04=	Cisco UCS VIC 1467 quad port 10/25G SFP28 mLOM
UCSC-M-V100-04=	Cisco UCS VIC 1477 dual port 40/100G QSFP28 mLOM

Table 41 Spare Parts (continued)

Product ID (PID)	PID Description
UCSC-M-V5Q50G=	Cisco UCS VIC 15428 quad port 10/25/50G MLOM
UCSC-M-V5D200G=	Cisco UCS VIC 15238 dual port 40/100/200G MLOM
UCSC-M-V5Q50GV2=	Cisco UCS VIC 15427 Quad Port CNA MLOM with Secure Boot
UCSC-M-V5D200GV2=	VIC 15237, MLOM, 2x40/100/200G for Rack
Open Compute Project (OCP)	
UCSC-O-N6CD100GF=	Cisco-NVDA MCX623436AC-CDAB CX6Dx 2x100G QSFP56 x16 OCP NIC
UCSC-O-N6CD25GF=	Cisco-NVDA MCX631432AC-ADAB CX6Lx 2x25G SFP28 x8 OCP NIC
Virtual Interface Card (VICs)	
UCSC-PCIE-C100-04=	Cisco UCS VIC 1495 Dual Port 40/100G QSFP28 CNA PCIe
UCSC-PCIE-C25Q-04=	Cisco UCS VIC 1455 quad port 10/25G SFP28 PCIe
UCSC-P-V5Q50G=	Cisco UCS VIC 15425 Quad Port 10/25/50G CNA PCIe
UCSC-P-V5D200G=	Cisco UCS VIC 15235 Dual Port 40/100/200G CNA PCIe
Network Interface Cards (NICs)	
1 Gb NICs	
UCSC-PCIE-IRJ45=	Intel i350 quad-port 1G copper PCIe
10 Gb NICs	
UCSC-PCIE-ID10GF=	Intel X710-DA2 Dual Port 10Gb SFP+ NIC
UCSC-PCIE-IQ10GF=	Intel X710 quad-port 10G SFP+ NIC
UCSC-P-ID10GC=	Cisco-Intel X710T2LG 2x10 GbE RJ45 PCIe NIC
25 Gb NICs	
UCSC-P-I8D25GF=	Cisco-Intel E810XXVDA2 2x25/10 GbE SFP28 PCIe NIC
UCSC-P-M5D25GF=	Mellanox MCX512A-ACAT dual port 10/25G SFP28 NIC
UCSC-P-I8Q25GF=	Cisco-Intel E810XXVDA4L 4x25/10 GbE SFP28 PCIe NIC
UCSC-P-N6D25GF=	Cisco-NVDA MCX631102AS-ADAT CX6Lx 2x25GbE SFP28 x8 PCIe NIC
40 Gb NICs	
UCSC-PCIE-ID40GF =	Intel XL710 dual-port 40G QSFP+ NIC
100 Gb NICs	
UCSC-P-M5D100GF=	Mellanox CX-5 MCX516A-CDAT 2x100GbE QSFP PCIe NIC

Table 41 Spare Parts (continued)

Product ID (PID)	PID Description
UCSC-P-M6DD100GF=	Cisco-MLNX MCX623106AS-CDAT 2x100GbE QSFP56 PCIe NIC
UCSC-P-M6CD100GF=	Cisco-MLNX MCX623106AC-CDAT 2x100GbE QSFP56 PCIe NIC
UCSC-P-I8D100GF=	Cisco-Intel E810CQDA2 2x100 GbE QSFP28 PCIe NIC
UCSC-P-I8S100GF=	Cisco-Intel E810CQDA1 1x100 GbE QSFP28 PCIe NIC
Nexus Smart NIC	
NXN-K3P-2X=	Nexus X25 2-port SFP28 SmartNIC (2-channel), KU3P FPGA
NXN-K3P-2X-4GB=	Nexus X25 2-port SFP28 SmartNIC (2-channel), KU3P FPGA, 4GB
NXN-K3P-8X=	Nexus X100 2-port QSFP28 SmartNIC (8-channel), KU3P FPGA
NXN-K3P-8X-9GB=	Nexus X100 2p QSFP28 SmartNIC (8-channel), KU3P FPGA, 9GB
NXN-V9P-16X-9GB=	Nexus 2-port QDD SmartNIC+ (16-channel), VU9P FPGA, 9GB DDR
Host Bus Adapters (HBAs)	
UCSC-P-IQAT8970=	Cisco-Intel 8970 QAT Offload PCIe Adapter
UCSC-P-Q6D32GF=	Cisco-QLogic QLE2772 2x32GFC Gen 6 Enhanced PCIe HBA
UCSC-P-B7D32GF=	Cisco-Emulex LPe35002-M2-2x32GFC Gen 7 PCIe HBA
UCSC-PCIE-QD16GF=	Qlogic QLE2692 dual-port 16G FC HBA
UCSC-PCIE-BD16GF=	Emulex LPe31002 dual port 16G FC HBA
External Storage HBA	
UCSC-9500-8E=	9500 Series PCIe Gen 4.0 Tri-Mode Storage HBA 12Gb/s SAS/SATA/PCIe (NVMe)
SATA Interposer	
UCSC-SATAIN-240M6=	SATA Interposer (for control of up to 8 SATA-only drives using AHCI)
GPU PCIe Cards	
 <p>Note: If you are adding a GPU, you may need to add cables and other accessories for the GPU. See the GPU accessories and NVIDIA GPU Licenses section of this table.</p>	
UCSC-GPU-A10=	TESLA A10, PASSIVE, 150W, 24GB
UCSC-GPU-A30=	Tesla A30
UCSC-GPU-A40=	TESLA A40 RTX, PASSIVE, 300W, 48GB
UCSC-GPU-A100-80 ⁵ =	TESLA A100, PASSIVE, 300W, 80GB

Table 41 Spare Parts (continued)







Product ID (PID)	PID Description
UCSC-GPU-A16=	NVIDIA A16 PCIE 250W 4X16GB
GPU accessories	
UCS-M10CBL-C240M5  Note: You may need to order this cable if you are adding an A10/M10 GPU	C240M5 NVIDIA M10/A10 Cable
UCS-P100CBL-240M5  Note: You may need to order this cable if you are adding an A100 /A40/ A16/A30 GPU	C240M5 NVIDIA P100 /RTX /A100 /A40/ A16 /A30 Cable
CBL-GPU-C240M6  Note: You may need to order this power cable if you are adding an A10 GPU	Y TYPE GPU POWER Cable for A10 GPU, C240M6 and C245M6
UCSC-HSLP-M6=  Note: You may need to order this Heatsink if you are adding an GPUs	Heatsink for 1U/2U LFF/SFF GPU SKU
UCSC-ADGPU-240M6=  Note: You may need to order this Air Duct if you are adding an GPUs	C240M6 GPU Air Duct 2U (for DW only)
NVIDIA GPU Licenses  Note: Order the GPU licenses if are adding the NVIDIA GPUs	
<ul style="list-style-type: none"> • If you already have a NVIDIA GPU and adding another one, or if you are replacing NVIDIA GPUs, then existing license should be fine. • if you don't have a GPU already installed, and you are adding the first one or two, you may need to order the license. 	
NV-VCS-1YR=	NVIDIA vCompute Server Subscription - 1 GPU - 1 Year

Table 41 Spare Parts (continued)

Product ID (PID)	PID Description
NV-VCS-3YR=	NVIDIA vCompute Server Subscription - 1 GPU - 3 Year
NV-VCS-5YR=	NVIDIA vCompute Server Subscription - 1 GPU - 5 Year
NV-VCS-R-1Y=	Renew NVIDIA vCompute Server Subscription - 1 GPU - 1 Year
NV-VCS-R-3Y=	Renew NVIDIA vCompute Server Subscription - 1 GPU - 3 Year
NV-VCS-R-5Y=	Renew NVIDIA vCompute Server Subscription - 1 GPU - 5 Year
NV-GRDWK-1-5S=	Quadro Perpetual Lic - NVIDIA vDWS 1CCU; 5Yr SUMS Req
NV-GRDVA-1-5S=	GRID Perpetual Lic - NVIDIA VDI APPs 1CCU; 5Yr SUMS Req
NV-GRDPC-1-5S=	GRID Perpetual Lic - NVIDIA VDI PC 1CCU; 5Yr SUMS Req
NV-GRD-EDP-5S=	EDU - Quadro Perpetual Lic - NVIDIA vDWS 1CCU; 5Yr SUMS Req
NV-GRID-WKP-5YR=	NVIDIA Quadro Production SUMS - vDWS 1CCU - 5 Year
NV-GRID-VAP-5YR=	NVIDIA GRID Production SUMS - VDI Apps 1CCU - 5 Year
NV-GRID-PCP-5YR=	NVIDIA GRID Production SUMS - VDI PC 1CCU - 5 Year
NV-GRID-EDP-5YR=	EDU - NVIDIA Quadro vDWS Production SUMS - 1CCU - 5 Year
NV-GRID-WKS-1YR=	NVIDIA Quadro SW Subscription - vDWS 1CCU - 1 Year
NV-GRID-WKS-3YR=	NVIDIA Quadro SW Subscription - vDWS 1CCU - 3 Year
NV-GRID-WKS-4YR=	NVIDIA Quadro SW Subscription - vDWS 1CCU - 4 Year
NV-GRID-WKS-5YR=	NVIDIA Quadro SW Subscription - vDWS 1CCU - 5 Year
NV-GRID-PCS-1YR=	NVIDIA GRID Software Subscription - VDI PC 1CCU - 1 Year
NV-GRID-PCS-3YR=	NVIDIA GRID Software Subscription - VDI PC 1CCU - 3 Year
NV-GRID-PCS-4YR=	NVIDIA GRID Software Subscription - VDI PC 1CCU - 4 Year
NV-GRID-PCS-5YR=	NVIDIA GRID Software Subscription - VDI PC 1CCU - 5 Year
NV-GRID-VAS-1YR=	NVIDIA GRID Software Subscription - VDI Apps 1CCU - 1 Year
NV-GRID-VAS-3YR=	NVIDIA GRID Software Subscription - VDI Apps 1CCU - 3 Year
NV-GRID-VAS-4YR=	NVIDIA GRID Software Subscription - VDI Apps 1CCU - 4 Year
NV-GRID-VAS-5YR=	NVIDIA GRID Software Subscription - VDI Apps 1CCU - 5 Year
NV-GRID-EDS-1YR=	EDU - NVIDIA Quadro vDWS SW Subscription - 1CCU - 1 Year
NV-GRID-EDS-3YR=	EDU - NVIDIA Quadro vDWS SW Subscription - 1CCU - 3 Year
NV-GRID-EDS-4YR=	EDU - NVIDIA Quadro vDWS SW Subscription - 1CCU - 4 Year
NV-GRID-EDS-5YR=	EDU - NVIDIA Quadro vDWS SW Subscription - 1CCU - 5 Year

Table 41 Spare Parts (continued)

Product ID (PID)	PID Description
NV-GRID-VAP-R-4Y=	Renew NVIDIA GRID vApps SUMS 1CCU 4 Year
NV-GRID-PCP-R-4Y=	Renew NVIDIA GRID vPC SUMS 1CCU 4 Year
NV-QUAD-WKP-R-4Y=	Renew NVIDIA Quadro vDWS SUMS 1CCU 4 Year
NV-QUAD-WKPE-R-4Y=	Renew NVIDIA Quadro vDWS SUMS 1CCU EDU 4 Year
NV-QUAD-WKS-R-1Y=	Renew NVIDIA Quadro vDWS Subscr 1CCU 1 Year
NV-QUAD-WKS-R-3Y=	Renew NVIDIA Quadro vDWS Subscr 1CCU 3 Year
NV-QUAD-WKS-R-4Y=	Renew NVIDIA Quadro vDWS Subscr 1CCU 4 Year
NV-QUAD-WKS-R-5Y=	Renew NVIDIA Quadro vDWS Subscr 1CCU 5 Year
NV-QUAD-WKSE-R-1Y=	Renew NVIDIA Quadro vDWS Subscr 1CCU EDU 1 Year
NV-QUAD-WKSE-R-3Y=	Renew NVIDIA Quadro vDWS Subscr 1CCU EDU 3 Year
NV-QUAD-WKSE-R-4Y=	Renew NVIDIA Quadro vDWS Subscr 1CCU EDU 4 Year
NV-GRID-VAS-R-1Y=	Renew NVIDIA GRID vApps Subscr 1CCU 1 Year
NV-GRID-VAS-R-3Y=	Renew NVIDIA GRID vApps Subscr 1CCU 3 Year
NV-GRID-VAS-R-4Y=	Renew NVIDIA GRID vApps Subscr 1CCU 4 Year
NV-GRID-VAS-R-5Y=	Renew NVIDIA GRID vApps Subscr 1CCU 5 Year
NV-GRID-PCS-R-1Y=	Renew NVIDIA GRID vPC Subscr 1CCU 1 Year
NV-GRID-PCS-R-3Y=	Renew NVIDIA GRID vPC Subscr 1CCU 3 Year
NV-GRID-PCS-R-4Y=	Renew NVIDIA GRID vPC Subscr 1CCU 4 Year
NV-GRID-PCS-R-5Y=	Renew NVIDIA GRID vPC Subscr 1CCU 5 Year
NV-QUAD-WKP-R-1Y=	Renew NVIDIA Quadro vDWS SUMS 1CCU 1 Year
NV-QUAD-WKP-R-3Y=	Renew NVIDIA Quadro vDWS SUMS 1CCU 3 Year
NV-QUAD-WKP-R-5Y=	Renew NVIDIA Quadro vDWS SUMS 1CCU 5 Year
NV-QUAD-WKPE-R-1Y=	Renew NVIDIA Quadro vDWS SUMS 1CCU EDU 1 Year
NV-QUAD-WKPE-R-3Y=	Renew NVIDIA Quadro vDWS SUMS 1CCU EDU 3 Year
NV-QUAD-WKPE-R-5Y=	Renew NVIDIA Quadro vDWS SUMS 1CCU EDU 5 Year
NV-GRID-VAP-R-1Y=	Renew NVIDIA GRID vApps SUMS 1CCU 1 Year
NV-GRID-VAP-R-3Y=	Renew NVIDIA GRID vApps SUMS 1CCU 3 Year
NV-GRID-VAP-R-5Y=	Renew NVIDIA GRID vApps SUMS 1CCU 5 Year
NV-GRID-PCP-R-1Y=	Renew NVIDIA GRID vPC SUMS 1CCU 1 Year

Table 41 Spare Parts (continued)

Product ID (PID)	PID Description
NV-GRID-PCP-R-3Y=	Renew NVIDIA GRID vPC SUMS 1CCU 3 Year
NV-GRID-PCP-R-5Y=	Renew NVIDIA GRID vPC SUMS 1CCU 5 Year
NV-GRD-VA2WKP-5S=	Upgrade NVIDIA VDI APPs to Quadro vDWS 1CCU; 5Yr SUMS Reqd
NV-GRD-VA2PCP-5S=	Upgrade NVIDIA VDI APPs to vPC 1CCU; 5Yr SUMS Reqd
NV-GRD-VA2WKPE-5S=	Upgrade NVIDIA VDI to Quadro vDWS 1CCU; 5Yr SUMS Reqd
NV-GRD-PC2WKP-5S=	Upgrade NVIDIA vPC to Quadro vDWS 1CCU; 5Yr SUMS Reqd
NV-GRD-PC2WKPE-5S=	Upgrade NVIDIA vPC to Quadro vDWS 1CCU; 5Yr SUMS Reqd
Power Supply	
UCSC-PSU1-1050W=	UCS 1050W AC PSU Platinum (Not EU/UK Lot 9 Compliant)
UCSC-PSUV2-1050DC=	1050W DC power supply for C-Series servers Platinum
UCSC-PSUV21050D6I=	1050W -48V DC power supply for C-Series servers (India) Requires cable CAB-48DC-40A-8AWG
UCSC-PSU1-1200W=	1200W Titanium power supply for C-Series Servers
UCSC-PSU1-1600W=	UCS 1600W AC PSU Platinum (Not EU/UK Lot 9 Compliant)
UCSC-PSU1-2300W ⁵ =	2300W Power supply for C-series servers Titanium
PSU (Input Low Line 110VAC)	
UCSC-PSU1-1050W=	UCS 1050W AC PSU Platinum (Not EU/UK Lot 9 Compliant)
UCSC-PSUV2-1050DC=	1050W DC power supply for C-Series servers Platinum
UCSC-PSUV21050D6I=	1050W -48V DC power supply for C-Series servers (India) Requires cable CAB-48DC-40A-8AWG
UCSC-PSU1-1050ELV=	1050W AC PSU Enhanced Low Line (Not EU/UK Lot 9 Compliant)
UCSC-PSU1-1200W=	1200W Titanium power supply for C-Series Servers
UCSC-PSU1-2300W=	2300W Power supply for C-series servers Titanium
UCSC-PSU-M5BLK=	Power Supply Blanking Panel for M5 servers
Power Cables	
NO-POWER-CORD=	ECO friendly green option, no power cable will be shipped
CAB-48DC-40A-8AWG=	C-Series -48VDC PSU Power Cord, 3.5M, 3 Wire, 8AWG, 40A
CAB-48DC-40A-AS=	C-Series -48VDC PSU PWR Cord, 3.5M, 3Wire, 8AWG, 40A (AS/NZ)
CAB-C13-CBN =	Cabinet Jumper Power Cord, 250 VAC 10A, C14-C13 Connectors
CAB-C13-C14-AC=	Power cord, C13 to C14 (recessed receptacle), 10A

Table 41 Spare Parts (continued)

Product ID (PID)	PID Description
CAB-C19-CBN=	Cabinet Jumper Power Cord, 250 VAC 16A, C20-C19 Connectors AC
CAB-C13-C14-2M=	CABASY,WIRE,JUMPER CORD,PWR,2 Meter,C13/C14,10A/250V AC
CAB-250V-10A-AR=	AC Power Cord - 250V, 10A - Argentina
CAB-IR2073-C19-AR=	IRSM 2073 to IEC-C19 14ft Argen AC
CAB-9K10A-AU=	N5000 AC Power Cable, 10A, 250V, Australia, 2.5m
CAB-AC-16A-AUS=	Power Cord, 250VAC, 16A, Australia C19
CAB-250V-10A-BR=	Power Cord - 250V, 10A - Brazil
UCSB-CABL-C19-BRZ=	NBR 14136 to C19 AC 14FT POWER CORD, BRAZIL
CAB-9K16A-BRZ =	Power Cord 250VAC 16A, Brazil, Src Plug EL224-C19
CAB-AC16A-CH =	16A AC Power Cord For China
CAB-250V-10A-CN=	AC Power Cord - 250V, 10A - PRC
CAB-C14C19-10A-EU=	Power Cord C14-C19 10A EU
CAB-9K10A-EU=	N5000 AC Power Cable, 10A, 250V, Europe, 2.5m
CAB-AC-2500W-EU=	Power Cord, 250Vac 16A, Europe
CAB-250V-10A-ID=	AC Power Cord - 250V, 10A , India
CAB-C13-C14-3M-IN=	Power Cord Jumper, C13-C14 Connectors, 3 Meter Length, India
CAB-C13-C14-IN=	Power Cord Jumper,C13-C14 Connectors,1.4 Meter Length, India
CAB-SABS-C19-IND=	SABS 164-1 to IEC-C19 India
CAB-C19-C20-IND=	Power Cord C19-C20 India
CAB-250V-10A-ID=	AC Power Cord - 250V, 10A , India
CAB-48DC-40A-INT=	C-Series -48VDC PSU PWR Cord, 3.5M, 3 Wire, 8AWG, 40A (INT)
CAB-AC-2500W-INT =	Power Cord, 250Vac 16A, INTL
CAB-250V-10A-IS=	AC Power Cord - 250V, 10A - Israel
CAB-S132-C19-ISRL=	S132 to IEC-C19 14ft Israeli
CAB-AC-2500W-ISRL=	Power Cord,250VAC,16A,Israel
CAB-9K10A-IT=	N5000 AC Power Cable, 10A, 250V, Italy, 2.5m
CAB-C2316-C19-IT=	CEI 23-16 to IEC-C19 14ft Italy
CAB-C13-C14-2M-JP=	Power Cord C13-C14, 2M/6.5ft Japan PSE mark
CAB-JPN-3PIN=	Japan, 90-125VAC 12A NEMA 5-15 Plug, 2.4m

Table 41 Spare Parts (continued)

Product ID (PID)	PID Description
CAB-C19-C20-3M-JP=	Power Cord C19-C20, 3M/10ft Japan PSE mark
CAB-9K10A-KOR=	Power Cord, 125VAC 13A KSC8305 Plug, Korea
CAB-9K16A-KOR =	Power Cord 250VAC 16A, Korea, Src Plug
CAB-9K12A-NA=	N5000 Power Cord, 125VAC 15A NEMA 5-15 Plug, North America, 2.5m
CAB-N5K6A-NA=	N5000 AC Power Cable, 6A, 250V, North America, 2.5m
CAB-AC-L620-C13=	AC Power Cord, NEMA L6-20 - C13, 2M/6.5ft
CAB-AC-C6K-TWLK=	Power Cord, 250Vac 16A, twist lock NEMA L6-20 plug, US
CAB-9K10A-SW=	N5000 AC Power Cable, 10A, 250V, Switzerland, 2.5m
CAB-ACS-16 =	AC Power Cord (Swiss) 16A
CAB-AC-C19-TW=	Power Cord, 250 V, 16A, C19, Taiwan
CAB-9K10A-UK=	N5000 AC Power Cable, 10A, 250V, United Kingdom, 2.5m
CAB-BS1363-C19-UK=	BS-1363 to IEC-C19 14ft UK
CAB-US515P-C19-US=	NEMA 5-15 to IEC-C19 13ft US
CAB-US520-C19-US=	NEMA 5-20 to IEC-C19 14ft US
CAB-US620P-C19-US=	NEMA 6-20 to IEC-C19 13ft US
Rail Kit	
UCSC-RAIL-M6=	Ball Bearing Rail Kit for C220 and C240 M6 rack servers
UCSC-RAIL-NONE=	No rail kit option
CMA	
UCSC-CMA-240M6=	Reversible CMA for C240 M6 ball bearing rail kit
Security	
UCSX-TPM-002C=	TPM 2.0, TCG, FIPS140-2, CC EAL4+ Certified, for M6 servers
UCS-TPM-002D	TPM 2.0 TCG FIPS140-2 CC+ Cert M6 Intel MSW2022 Compliant
UCSC-INT-SW02=	C220 and C240 M6 Chassis Intrusion Switch
Bezel	
UCSC-BZL-C240M5=	C240 M5 Security Bezel
Software/Firmware	
Windows Server Recovery Media	

Table 41 Spare Parts (continued)

Product ID (PID)	PID Description
MSWS-19-ST16C-RM=	Windows Server 2019 Stan (16 Cores/2 VMs) Rec Media DVD Only
MSWS-19-DC16C-RM=	Windows Server 2019 DC (16Cores/Unlim VM) Rec Media DVD Only
MSWS-22-ST16C-RM=	Windows Server 2022 Stan (16 Cores/2 VMs) Rec Media DVD Only
MSWS-22-DC16C-RM=	Windows Server 2022 DC (16Cores/Unlim VM) Rec Media DVD Only
RHEL SAP	
RHEL-SAPSP-3S=	RHEL SAP Solutions Premium - 3 Years
RHEL-SAPSS-3S=	RHEL SAP Solutions Standard - 3 Years
RHEL-SAPSP-R-1S=	Renew RHEL SAP Solutions Premium - 1 Year
RHEL-SAPSS-R-1S=	Renew RHEL SAP Solutions Standard - 1 Year
RHEL-SAPSP-R-3S=	Renew RHEL SAP Solutions Premium - 3 Years
RHEL-SAPSS-R-3S=	Renew RHEL SAP Solutions Standard -3 Years
VMware vSphere	
VMW-VSP-STD-1A=	VMware vSphere 7 Std (1 CPU, 32 Core) 1-yr, Support Required
VMW-VSP-STD-3A=	VMware vSphere 7 Std (1 CPU, 32 Core) 3-yr, Support Required
VMW-VSP-STD-5A=	VMware vSphere 7 Std (1 CPU, 32 Core) 5-yr, Support Required
VMW-VSP-EPL-1A=	VMware vSphere 7 Ent Plus (1 CPU, 32 Core) 1Yr, Support Reqd
VMW-VSP-EPL-3A=	VMware vSphere 7 Ent Plus (1 CPU, 32 Core) 3Yr, Support Reqd
VMW-VSP-EPL-5A=	VMware vSphere 7 Ent Plus (1 CPU, 32 Core) 5Yr, Support Reqd
VMW-VSP-STD-1S=	VMware vSphere 7 Std (1 CPU, 32 Core), 1-yr VMware SnS Reqd
VMW-VSP-STD-3S=	VMware vSphere 7 Std (1 CPU, 32 Core), 3-yr VMware SnS Reqd
VMW-VSP-STD-1YR	VMware vSphere 7 Std SnS - 1 Year (reports to PID VMW-VSP-STD-1S=)
VMW-VSP-STD-3YR	VMware vSphere 7 Std SnS - 3 Year (reports to PID VMW-VSP-STD-3S=)
VMW-VSP-EPL-1S=	VMware vSphere 7 EntPlus (1 CPU 32 Core) 1Yr VMware SnS Reqd
VMW-VSP-EPL-3S=	VMware vSphere 7 EntPlus (1 CPU 32 Core) 3Yr VMware SnS Reqd
VMW-VSP-EPL-1YR	VMware vSphere 7 Enterprise Plus SnS - 1 Year (reports to PID VMW-VSP-EPL-1S=)
VMW-VSP-EPL-3YR	VMware vSphere 7 Enterprise Plus SnS - 3 Year (reports to PID VMW-VSP-EPL-3S=)
VMware vCenter	

Table 41 Spare Parts (continued)

Product ID (PID)	PID Description
VMW-VCS-STD-1A=	VMware vCenter 7 Server Standard, 1 yr support required
VMW-VCS-STD-3A=	VMware vCenter 7 Server Standard, 3 yr support required
VMW-VCS-STD-5A=	VMware vCenter 7 Server Standard, 5 yr support required
VMW-VCS-STD-1S=	VMware vCenter 7 Server Standard, 1-yr VMware SnS Reqd
VMW-VCS-STD-3S=	VMware vCenter 7 Server Standard, 3-yr VMware SnS Reqd
VMW-VCS-STD-1YR	VMware vCenter 6 Server Standard SnS - 1 Year (reports to PID VMW-VCS-STD-1S=)
VMW-VCS-STD-3YR	VMware vCenter 6 Server Standard SnS - 3 Year (reports to PID VMW-VCS-STD-3S=)
VMW-VCS-FND-1A=	VMware vCenter Server 7 Foundation (4 Host), 1 yr supp reqd
VMW-VCS-FND-3A=	VMware vCenter Server 7 Foundation (4 Host), 3 yr supp reqd
VMW-VCS-FND-5A=	VMware vCenter Server 7 Foundation (4 Host), 5 yr supp reqd
VMW-VCS-FND-1S=	VMware vCenter Server 7 Foundation (4 Host), 1yr VM SnS Reqd
VMW-VCS-FND-3S=	VMware vCenter Server 7 Foundation (4 Host), 3yr VM SnS Reqd
VMW-VCS-FND-1YR	VMware vCenter Server 6 Foundation (4 Host) SnS - 1 Year (reports to PID VMW-VCS-FND-1S=)
VMW-VCS-FND-3YR	VMware vCenter Server 6 Foundation (4 Host) SnS - 3 Year (reports to PID VMW-VCS-FND-3S=)
VMware vSphere Upgrades	
VMW-VSS2VSP-1A=	Upgrade: vSphere 7 Std to vSphere 7 Ent Plus (1 yr Supp Req)
VMW-VSS2VSP-3A=	Upgrade: vSphere 7 Std to vSphere 7 Ent Plus (1 yr Supp Req)

Notes:

1. The maximum number of UCS-CPU-I8351N CPUs is one
2. The maximum number of UCS-CPU-I6314U CPUs is one
3. The maximum number of UCS-CPU-I6312U CPUs is one
4. This part is included with the purchase of option or spare CPU or CPU processor kits.
5. The 2300 W power supply uses a different power connector than the rest of the power supplies, so you must use different power cables to connect it. See [Table 17 on page 60](#) and [Table 18 on page 63](#).

UPGRADING or REPLACING CPUs



NOTE: Before servicing any CPU, do the following:

- Decommission and power off the server.
- Slide the C240 M6 SFF server out from the rack.
- Remove the top cover.

To replace an existing CPU, follow these steps:

(1) Have the following tools and materials available for the procedure:

- T-30 Torx driver—Supplied with replacement CPU.
- #1 flat-head screwdriver—Supplied with replacement CPU.
- CPU assembly tool—Supplied with replacement CPU. Can be ordered separately as Cisco PID UCS-CPUAT=.
- Heatsink cleaning kit—Supplied with replacement CPU. Can be ordered separately as Cisco PID UCSX-HSCK=.
- Thermal interface material (TIM)—Syringe supplied with replacement CPU. Can be ordered separately as Cisco PID UCS-CPU-TIM=.

(2) Order the appropriate replacement CPU from [Table 5 on page 28](#)

(3) Carefully remove and replace the CPU and heatsink in accordance with the instructions found in “Cisco UCS C240 M6 Server Installation and Service Guide,” found at:

https://www.cisco.com/content/en/us/td/docs/unified_computing/ucs/c/hw/c240m6/install/b-c240-m6-install-guide.html

To add a new CPU, follow these steps:

(1) Have the following tools and materials available for the procedure:

- T-30 Torx driver—Supplied with new CPU.
- #1 flat-head screwdriver—Supplied with new CPU
- CPU assembly tool—Supplied with new CPU. Can be ordered separately as Cisco PID UCS-CPUAT=
- Thermal interface material (TIM)—Syringe supplied with replacement CPU. Can be ordered separately as Cisco PID UCS-CPU-TIM=

(2) Order the appropriate new CPU from [Table 5 on page 28](#)

(3) Order one heat sink for each new CPU. Order PID UCSC-HSHP-240M6= for servers with no GPU. Order PID UCSC-HSLP-M6= for servers with GPUs.

(4) Carefully install the CPU and heatsink in accordance with the instructions found in “Cisco UCS C240 M6 Server Installation and Service Guide,” found at:

https://www.cisco.com/content/en/us/td/docs/unified_computing/ucs/c/hw/c240m6/install/b-c240-m6-install-guide.html

UPGRADING or REPLACING MEMORY



NOTE: Before servicing any DIMM or PMem, do the following:

- Decommission and power off the server.
- Remove the top cover from the server
- Slide the server out the front of the chassis.

To add or replace DIMMs or PMem, follow these steps:

Step 1 Open both DIMM connector latches.

Step 2 Press evenly on both ends of the DIMM until it clicks into place in its slot

Note: Ensure that the notch in the DIMM aligns with the slot. If the notch is misaligned, it is possible to damage the DIMM, the slot, or both.

Step 3 Press the DIMM connector latches inward slightly to seat them fully.

Step 4 Populate all slots with a DIMM or DIMM blank. A slot cannot be empty.

Figure 27 Replacing Memory

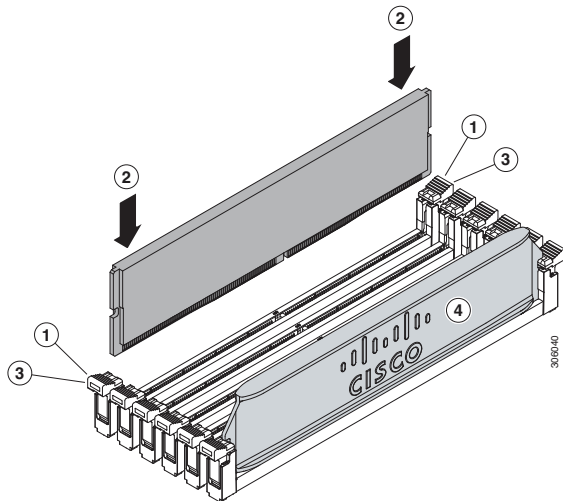

For additional details on replacing or upgrading DIMMs and PMem, see “Cisco UCS C240 M6 Server Installation and Service Guide,” found at this link:

https://www.cisco.com/content/en/us/td/docs/unified_computing/ucs/c/hw/c240m6/install/b-c240-m6-install-guide.html

DISCONTINUED EOL PRODUCTS

Below is the list of parts were previously available for this product and are no longer sold. Please refer to the EOL Bulletin Links via the Table 36 below to determine if still supported.

Table 42 EOS/EOL

Product ID	Description	EOL/EOS link
Software		
NV-GRDVA-1-4S	GRID Perpetual Lic - NVIDIA VDI APPs 1CCU; 4Yr SUMS Reqd	https://www.cisco.com/c/en/us/products/collateral/servers-unified-computing/ucs-b-series-blade-servers/select-commvault-veeam-vmware-nvidia-mapr-software-resell-eol.html
NV-GRDPC-1-4	GRID Perpetual Lic - NVIDIA VDI PC 1CCU; 4Yr SUMS Reqd	https://www.cisco.com/c/en/us/products/collateral/servers-unified-computing/ucs-b-series-blade-servers/select-commvault-veeam-vmware-nvidia-mapr-software-resell-eol.html
NV-GRDVK-1-4S	Quadro Perpetual Lic - NVIDIA vDWS 1CCU; 4Yr SUMS Req	https://www.cisco.com/c/en/us/products/collateral/servers-unified-computing/ucs-b-series-blade-servers/select-commvault-veeam-vmware-nvidia-mapr-software-resell-eol.html
NV-GRD-EDP-4S	EDU - Quadro Perpetual Lic - NVIDIA vDWS 1CCU; 4Yr SUMS Reqd	https://www.cisco.com/c/en/us/products/collateral/servers-unified-computing/ucs-b-series-blade-servers/select-commvault-veeam-vmware-nvidia-mapr-software-resell-eol.html
NV-GRID-VAP-4YR	NVIDIA GRID Production SUMS - VDI Apps 1CCU - 4 Year	https://www.cisco.com/c/en/us/products/collateral/servers-unified-computing/ucs-b-series-blade-servers/select-commvault-veeam-vmware-nvidia-mapr-software-resell-eol.html
NV-GRID-PCP-4YR	NVIDIA GRID Production SUMS - VDI PC 1CCU - 4 Year	https://www.cisco.com/c/en/us/products/collateral/servers-unified-computing/ucs-b-series-blade-servers/select-commvault-veeam-vmware-nvidia-mapr-software-resell-eol.html
NV-GRID-WKP-4YR	NVIDIA Quadro Production SUMS - vDWS 1CCU - 4 Year	https://www.cisco.com/c/en/us/products/collateral/servers-unified-computing/ucs-b-series-blade-servers/select-commvault-veeam-vmware-nvidia-mapr-software-resell-eol.html
NV-GRID-EDP-4YR	EDU - NVIDIA Quadro vDWS Production SUMS - 1CCU - 4 Year	https://www.cisco.com/c/en/us/products/collateral/servers-unified-computing/ucs-b-series-blade-servers/select-commvault-veeam-vmware-nvidia-mapr-software-resell-eol.html
Operating system		
SLES-2SUV-1A	SUSE Linux Enterprise Svr (1-2 CPU,Unl VM); 1-Yr Support Req	
SLES-2SUV-1S	SUSE Linux Enterprise Svr (1-2 CPU,Unl VM); Prio 1-Yr SnS	
SLES-2SUV-3A	SUSE Linux Enterprise Svr (1-2 CPU,Unl VM); 3-Yr Support Req	
SLES-2SUV-3S	SUSE Linux Enterprise Svr (1-2 CPU,Unl VM); Prio 3-Yr SnS	
SLES-2SUV-5A	SUSE Linux Enterprise Svr (1-2 CPU,Unl VM); 5-Yr Support Req	
SLES-2SUV-5S	SUSE Linux Enterprise Svr (1-2 CPU,Unl VM); Prio 5-Yr SnS	

Table 42 EOS/EOL

SLES-SAP-2SUV-1A	SLES for SAP Apps w/ HA (1-2 CPU, Unl VM); 1-Yr Support Reqd	
SLES-SAP-2SUV-1S	SLES for SAP Apps (1-2 CPU, Unl VM); Priority 1-Yr SnS	
SLES-SAP-2SUV-3A	SLES for SAP Apps w/ HA (1-2 CPU, Unl VM); 3-Yr Support Reqd	
SLES-SAP-2SUV-3S	SLES for SAP Apps (1-2 CPU, Unl VM); Priority 3-Yr SnS	
SLES-SAP-2SUV-5A	SLES for SAP Apps w/ HA (1-2 CPU, Unl VM); 5-Yr Support Reqd	
SLES-SAP-2SUV-5S	SLES for SAP Apps (1-2 CPU, Unl VM); Priority 5-Yr SnS	
GPU		
UCSC-GPU-A100	TESLA A100, PASSIVE, 250W, 40GB	https://www.cisco.com/c/en/us/products/collateral/servers-unified-computing/ucs-c-series-rack-servers/select-ucs-and-hyperflex-accessories.html
Drives		
UCS-M2-240GB	240GB M.2 SATA Micron G1 SSD	https://www.cisco.com/c/en/us/products/collateral/servers-unified-computing/ucs-c-series-rack-servers/unified-computing-accessories-eol.html
UCS-M2-960GB	960GB M.2 SATA Micron G1 SSD	https://www.cisco.com/c/en/us/products/collateral/servers-unified-computing/ucs-c-series-rack-servers/unified-computing-accessories-eol.html
UCS-NVMEI4-I3840	3.8TB 2.5in U.2 Intel P5500 NVMe High Perf Medium Endurance	https://www.cisco.com/c/en/us/products/collateral/servers-unified-computing/ucs-c-series-rack-servers/select-ucs-access-eol-15074.html
UCS-NVMEI4-I7680	7.6TB 2.5in U.2 Intel P5500 NVMe High Perf Medium Endurance	https://www.cisco.com/c/en/us/products/collateral/servers-unified-computing/ucs-c-series-rack-servers/select-ucs-access-eol-15074.html
UCS-NVMEM6-W6400	6.4TB 2.5in U.2 WD SN840 NVMe Extreme Perf. High Endurance	https://www.cisco.com/c/en/us/products/collateral/servers-unified-computing/ucs-c-series-rack-servers/unified-computing-accessories-eol.html
UCS-SD76T61X-EV	7.6TB 2.5 inch Enterprise Value 6G SATA SSD	https://www.cisco.com/c/en/us/products/collateral/servers-unified-computing/ucs-c-series-rack-servers/select-ucs-hyperflex-accessories-eol2.html
UCS-SD76TBEM2NK9	7.6TB 2.5in Enter Value 6G SATA Micron G1 SSD (SED)	https://www.cisco.com/c/en/us/products/collateral/servers-unified-computing/ucs-c-series-rack-servers/unified-computing-accessories-eol.html
UCS-SD960GBM2NK9	960GB 2.5in Enter Value 6G SATA Micron G1 SSD (SED)	https://www.cisco.com/c/en/us/products/collateral/servers-unified-computing/ucs-c-series-rack-servers/unified-computing-accessories-eol.html
UCS-SD240GM1X-EV	240GB 2.5in Enter Value 6G SATA Micron G1 SSD	https://www.cisco.com/c/en/us/products/collateral/servers-unified-computing/ucs-c-series-rack-servers/unified-computing-accessories-eol.html
UCS-SD480GM1X-EV	480 GB 2.5in Enter Value 6G SATA Micron G1 SSD	https://www.cisco.com/c/en/us/products/collateral/servers-unified-computing/ucs-c-series-rack-servers/unified-computing-accessories-eol.html

Table 42 EOS/EOL

UCS-SD76TM1X-EV	7.6TB 2.5in Enter Value 6G SATA Micron G1 SSD	https://www.cisco.com/c/en/us/products/collateral/servers-unified-computing/ucs-c-series-rack-servers/unified-computing-accessories-eol.html
UCS-SD16TM1X-EV	1.6TB 2.5in Enter Value 6G SATA Micron G1 SSD	https://www.cisco.com/c/en/us/products/collateral/servers-unified-computing/ucs-c-series-rack-servers/unified-computing-accessories-eol.html
UCS-SD38TM1X-EV	3.8TB 2.5in Enter Value 6G SATA Micron G1 SSD	https://www.cisco.com/c/en/us/products/collateral/servers-unified-computing/ucs-c-series-rack-servers/unified-computing-accessories-eol.html
UCS-SD960G61X-EV	960GB 2.5 inch Enterprise Value 6G SATA SSD	https://www.cisco.com/c/en/us/products/collateral/servers-unified-computing/ucs-c-series-rack-servers/select-ucs-hyperflex-accessories-eol2.html
UCS-NVMEI4-I6400	6.4TB 2.5in U.2 Intel P5600 NVMe High Perf Medium Endurance	https://www.cisco.com/c/en/us/products/collateral/servers-unified-computing/ucs-b-series-blade-servers/select-ucs-accessories-eol.html
UCS-SD32TK3X-EP	3.2TB 2.5in Enter Perf 12G SAS Kioxia G1 SSD (3X)	https://www.cisco.com/c/en/us/products/collateral/servers-unified-computing/ucs-b-series-blade-servers/select-ucs-accessories-eol.html
UCS-SD38TK1X-EV	3.8TB 2.5in Enter Value 12G SAS Kioxia G1 SSD	https://www.cisco.com/c/en/us/products/collateral/servers-unified-computing/ucs-b-series-blade-servers/select-ucs-accessories-eol.html
UCS-SD76TBKNK9	7.6TB 2.5in Enter Value 12G SAS Kioxia G1 SSD (SED-FIPS)	https://www.cisco.com/c/en/us/products/collateral/servers-unified-computing/ucs-b-series-blade-servers/select-ucs-accessories-eol.html
UCS-SD76TK1X-EV	7.6TB 2.5in Enter Value 12G SAS Kioxia G1 SSD	https://www.cisco.com/c/en/us/products/collateral/servers-unified-computing/ucs-b-series-blade-servers/select-ucs-accessories-eol.html
UCS-SD15TK1X-EV	15.3TB 2.5in Enter Value 12G SAS Kioxia G1 SSD	https://www.cisco.com/c/en/us/products/collateral/servers-unified-computing/ucs-b-series-blade-servers/select-ucs-accessories-eol.html
UCS-SD16TBKNK9	1.6TB 2.5in Enter Perf 12G SAS Kioxia G1 SSD (3X SED-FIPS)	https://www.cisco.com/c/en/us/products/collateral/servers-unified-computing/ucs-b-series-blade-servers/select-ucs-accessories-eol.html
UCS-SD16TK3X-EP	1.6TB 2.5in Enter Perf 12G SAS Kioxia G1 SSD (3X)	https://www.cisco.com/c/en/us/products/collateral/servers-unified-computing/ucs-b-series-blade-servers/select-ucs-accessories-eol.html
UCS-SD19TK1X-EV	1.9TB 2.5in Enter Value 12G SAS Kioxia G1 SSD	https://www.cisco.com/c/en/us/products/collateral/servers-unified-computing/ucs-b-series-blade-servers/select-ucs-accessories-eol.html
UCS-NVMEI4-I1920	1.9TB 2.5in U.2 Intel P5500 NVMe High Perf Medium Endurance	https://www.cisco.com/c/en/us/products/collateral/servers-unified-computing/ucs-c-series-rack-servers/select-ucs-access-eol-15074.html
PCIe Cards		
UCSC-M-V5Q50G	Cisco VIC 15428 4x 10/25/50G mLOM C-Series	https://www.cisco.com/c/en/us/products/collateral/servers-unified-computing/ucs-c-series-rack-servers/select-ucs-ucsx-accessories-eol.html

TECHNICAL SPECIFICATIONS

Dimensions and Weight

Table 43 UCS C240 M6 Dimensions and Weight

Parameter	Value
Height	3.42 in. (8.7 cm)
Width (Not including slam latches)	16.9 in. (42.9 cm)
Width (including slam latches)	18.9 in. (48.0 cm)
Depth	30 in. (76.2 cm)
Front Clearance	3 in. (76 mm)
Side Clearance	1 in. (25 mm)
Rear Clearance	6 in. (152 mm)
Weight	
Weight with following options and no rail kit: 0 HDD, 0 CPU, 0 DIMM, and 1 2300 W power supply	35.7 lbs (16.2 kg)
Weight with following options and including rail kit: 0 HDD, 0 CPU, 0 DIMM, and 1 2300 W power supply	44 lbs (20 kg)
Weight with following options and no rail kit: 1 HDD, 1 CPU, 1 DIMM, and 1 2300 W power supply	37.6 lbs (17 kg)
Weight with following options and including rail kit: 1 HDD, 1 CPU, 1 DIMM, and 1 2300 W power supply	45.9 lbs (20.8 kg)
Weight with following options and no rail kit: 8 HDDs, 2 CPUs, 32 DIMMs, and 2 2300 W power supplies	44.71 lbs (20.28 kg)
Weight with following options and including rail kit: 8 HDDs, 2 CPUs, 32 DIMMs, and 2 2300 W power supplies	49.2 lbs (22.32 kg)
Weight with following options and no rail kit: 0 HDD, 0 CPU, 0 DIMM, and 1 2300 W power supply	33.14 lbs (15 kg)
Weight with following options and including rail kit: 0 HDD, 0 CPU, 0 DIMM, and 1 2300 W power supply	41.45 lbs (18.8 kg)
Weight with following options and no rail kit: 1 HDD, 1 CPU, 1 DIMM, and 1 2300 W power supply	40.55 lbs (18.4kg)
Weight with following options and including rail kit: 1 HDD, 1 CPU, 1 DIMM, and 1 2300 W power supply	48.86 lbs (22.2 kg)
Weight with following options and no rail kit: 24 HDDs, 2 CPUs, 32 DIMMs, and 2 2300 W power supplies	58.8 lbs (26.7 kg)

Table 43 UCS C240 M6 Dimensions and Weight

Parameter	Value
Weight with following options and including rail kit: 24 HDDs, 2 CPUs, 32 DIMMs, and 2 2300 W power supplies	61.7 lbs (28 kg)

Power Specifications

The server is available with the following types of power supplies:

- 1050 W (AC) power supply (see [Table 44](#)).
- 1050 W V2 (DC) power supply (see [Table 45](#))
- 1600 W (AC) power supply (see [Table 46](#))
- 2300 W (AC) power supply (see [Table 47](#))

Table 44 UCS C240 M6 SFF Power Specifications (1050 W AC power supply)

Parameter	Specification			
Input Connector	IEC320 C14			
Input Voltage Range (V rms)	100 to 240			
Maximum Allowable Input Voltage Range (V rms)	90 to 264			
Frequency Range (Hz)	50 to 60			
Maximum Allowable Frequency Range (Hz)	47 to 63			
Maximum Rated Output (W) ¹	800		1050	
Maximum Rated Standby Output (W)	36			
Nominal Input Voltage (V rms)	100	120	208	230
Nominal Input Current (A rms)	9.2	7.6	5.8	5.2
Maximum Input at Nominal Input Voltage (W)	889	889	1167	1154
Maximum Input at Nominal Input Voltage (VA)	916	916	1203	1190
Minimum Rated Efficiency (%) ²	90	90	90	91
Minimum Rated Power Factor ²	0.97	0.97	0.97	0.97
Maximum Inrush Current (A peak)	15			
Maximum Inrush Current (ms)	0.2			
Minimum Ride-Through Time (ms) ³	12			

Notes:

1. Maximum rated output is limited to 800W when operating at low-line input voltage (100-127V)
2. This is the minimum rating required to achieve 80 PLUS Platinum certification, see test reports published at <http://www.80plus.org/> for certified values
3. Time output voltage remains within regulation limits at 100% load, during input voltage dropout

Table 45 UCS C240 M6 SFF Power Specifications (1050 W V2 DC power supply)

Parameter	Specification
Input Connector	Molex 42820
Input Voltage Range (V rms)	-48
Maximum Allowable Input Voltage Range (V rms)	-40 to -72
Frequency Range (Hz)	NA
Maximum Allowable Frequency Range (Hz)	NA
Maximum Rated Output (W)	1050
Maximum Rated Standby Output (W)	36
Nominal Input Voltage (V rms)	-48
Nominal Input Current (A rms)	24
Maximum Input at Nominal Input Voltage (W)	1154
Maximum Input at Nominal Input Voltage (VA)	1154
Minimum Rated Efficiency (%) ¹	91
Minimum Rated Power Factor ¹	NA
Maximum Inrush Current (A peak)	15
Maximum Inrush Current (ms)	0.2
Minimum Ride-Through Time (ms) ²	5

Notes:

1. This is the minimum rating required to achieve 80 PLUS Platinum certification, see test reports published at <http://www.80plus.org/> for certified values
2. Time output voltage remains within regulation limits at 100% load, during input voltage dropout

Table 46 UCS C240 M6 1600 W (AC) Power Supply Specifications

Parameter	Specification			
Input Connector	IEC320 C14			
Input Voltage Range (V rms)	200 to 240			
Maximum Allowable Input Voltage Range (V rms)	180 to 264			
Frequency Range (Hz)	50 to 60			
Maximum Allowable Frequency Range (Hz)	47 to 63			
Maximum Rated Output (W)	1600			
Maximum Rated Standby Output (W)	36			
Nominal Input Voltage (V rms)	100	120	208	230
Nominal Input Current (A rms)	NA	NA	8.8	7.9
Maximum Input at Nominal Input Voltage (W)	NA	NA	1778	1758
Maximum Input at Nominal Input Voltage (VA)	NA	NA	1833	1813
Minimum Rated Efficiency (%) ¹	NA	NA	90	91
Minimum Rated Power Factor ²	NA	NA	0.97	0.97
Maximum Inrush Current (A peak)	30			
Maximum Inrush Current (ms)	0.2			
Minimum Ride-Through Time (ms) ²	12			

Notes:

1. This is the minimum rating required to achieve 80 PLUS Platinum certification, see test reports published at <http://www.80plus.org/> for certified values
2. Time output voltage remains within regulation limits at 100% load, during input voltage dropout

Table 47 UCS C240 M6 2300 W (AC) Power Supply Specifications

Parameter	Specification			
Input Connector	IEC320 C20			
Input Voltage Range (Vrms)	100 to 240			
Maximum Allowable Input Voltage Range (Vrms)	90 to 264			
Frequency Range (Hz)	50 to 60			
Maximum Allowable Frequency Range (Hz)	47 to 63			
Maximum Rated Output (W) ¹	2300			
Maximum Rated Standby Output (W)	36			
Nominal Input Voltage (Vrms)	100	120	208	230
Nominal Input Current (Arms)	13	11	12	10.8
Maximum Input at Nominal Input Voltage (W)	1338	1330	2490	2480
Maximum Input at Nominal Input Voltage (VA)	1351	1343	2515	2505
Minimum Rated Efficiency (%) ²	92	92	93	93
Minimum Rated Power Factor ²	0.99	0.99	0.97	0.97
Maximum Inrush Current (A peak)	30			
Maximum Inrush Current (ms)	0.2			
Minimum Ride-Through Time (ms) ³	12			

Notes:

1. Maximum rated output is limited to 1200W when operating at low-line input voltage (100-127V)
2. This is the minimum rating required to achieve 80 PLUS Titanium certification, see test reports published at <http://www.80plus.org/> for certified values
3. Time output voltage remains within regulation limits at 100% load, during input voltage dropout

For configuration-specific power specifications, use the Cisco UCS Power Calculator at this URL:

<http://ucspowercalc.cisco.com>

Environmental Specifications

The environmental specifications for the C240 M6 SFF server are listed in [Table 48](#).

Table 48 UCS C240 M6 Environmental Specifications

Parameter	Minimum
Operating Temperature	<p>Dry bulb temperature of 10°C to 35°C (50°F to 95°F)</p> <p>Maximum temperature change of 20°C (36°F) per hour (a temperature change within a specified period of time and not a rate of change)</p> <p>Humidity condition: Uncontrolled, not to exceed 50% RH starting condition</p> <p>Derate the maximum temperature by 1°C (33.8°F) per every 305 meters of altitude above 900m</p>
Extended Operating Temperature	<p>5°C to 40°C (41°F to 104°F) with no direct sunlight</p> <p>Humidity condition: Uncontrolled, not to exceed 50% RH starting condition</p> <p>Derate the maximum temperature by 1°C (33.8°F) per every 305 meters of altitude above 900m</p>
Non-Operating Temperature	Dry bulb temperature of -40°C to 65°C (-40°F to 149°F)
Operating Relative Humidity	<p>10% to 90% and 28°C (82.4°F) maximum dew-point temperature, non-condensing environment</p> <p>Minimum to be higher (more moisture) of -12°C (10.4°F) dew point or 8% relative humidity</p> <p>Maximum to be 24°C (75.2°F) dew point or 90% relative humidity</p>
Non-Operating Relative Humidity	5% to 93% relative humidity, non-condensing, with a maximum wet bulb temperature of 28°C across the 20°C to 40°C dry bulb range.
Maximum Operating Duration	Unlimited
Operating Altitude	A maximum elevation of 3050 meters (10,006 ft)
Non-Operating Altitude	An elevation of 0 to 12,000 meters (39,370 ft)
Sound Power level, Measure A-weighted per ISO7779 LWAd (Bels) Operation at 23°C (73°F)	5.5
Sound Pressure level, Measure A-weighted per ISO7779 LpAm (dBA) Operation at 23°C (73°F)	40

Extended Operating Temperature Hardware Configuration Limits

Table 49 Cisco UCS C240 M6 Extended Operating Temperature Hardware Configuration Limits

Platform ¹	ASHRAE A3 (5°C to 40°C) ²	ASHRAE A4 (5°C to 45°C) ³
Processors:	155W+	155W+ and 105W+ (4 or 6 Cores)
Memory:	LRDIMMs	LRDIMMs
Storage:	M.2 SATA SSDs NVMe SSDs	M.2 SATA SSDs NVMe SSDs HDDs or SSDs (Rear Bays)
Peripherals:	PCIe NVMe SSDs GPUs	PCIe NVMe SSDs GPUs VICs (Slots 1 and 4) NICs (Slots 1 and 4) HBAs (Slots 1 and 4)

Notes:

1. Two PSUs are required and PSU failure is not supported
2. Non-Cisco UCS qualified peripherals and/or peripherals that consume more than 25W are not supported
3. High power or maximum power fan control policy must be applied

Compliance Requirements

The regulatory compliance requirements for C-Series servers are listed in [Table 50](#)

Table 50 UCS C-Series Regulatory Compliance Requirements

Parameter	Description
Regulatory Compliance	Products should comply with CE Markings per directives 2014/30/EU and 2014/35/EU
Safety	UL 60950-1 Second Edition CAN/CSA-C22.2 No. 60950-1 Second Edition EN 60950-1 Second Edition IEC 60950-1 Second Edition AS/NZS 60950-1 GB4943 2001
EMC - Emissions	47CFR Part 15 (CFR 47) Class A AS/NZS CISPR32 Class A CISPR32 Class A EN55032 Class A ICES003 Class A VCCI Class A EN61000-3-2 EN61000-3-3 KN32 Class A CNS13438 Class A
EMC - Immunity	EN55024 CISPR24 EN300386 KN35



Americas Headquarters
Cisco Systems, Inc.
San Jose, CA

Asia Pacific Headquarters
Cisco Systems (USA) Pte. Ltd.
Singapore

Europe Headquarters
Cisco Systems International BV Amsterdam,
The Netherlands

Cisco has more than 200 offices worldwide. Addresses, phone numbers, and fax numbers are listed on the Cisco Website at www.cisco.com/go/offices.

Cisco and the Cisco Logo are trademarks of Cisco Systems, Inc. and/or its affiliates in the U.S. and other countries. A listing of Cisco's trademarks can be found at www.cisco.com/go/trademarks. Third party trademarks mentioned are the property of their respective owners. The use of the word partner does not imply a partnership relationship between Cisco and any other company. (1005R)

