

This product has been discontinued



Spec Sheet

# Cisco HyperFlex HX240c M4 Node

CISCO SYSTEMS  
170 WEST TASMAN DR.  
SAN JOSE, CA, 95134  
[WWW.CISCO.COM](http://WWW.CISCO.COM)

#### PUBLICATION HISTORY

REV A.25    FEBRUARY 18, 2020

---

# CONTENTS

<b>OVERVIEW</b>	<b>5</b>
<b>DETAILED VIEWS</b>	<b>6</b>
Chassis Front View	6
Chassis Rear View	8
<b>BASE HX240c NODE STANDARD CAPABILITIES and FEATURES</b>	<b>9</b>
<b>CONFIGURING the HX240c M4 Node</b>	<b>12</b>
STEP 1 VERIFY SKU	13
STEP 2 SELECT RISER CARD (OPTIONAL)	14
STEP 3 SELECT CPU(s)	15
STEP 4 SELECT MEMORY	17
STEP 5 SELECT DRIVE CONTROLLER	20
SAS HBA (internal HDD/SSD/non-RAID support)	20
STEP 6 SELECT HARD DISK DRIVES (HDDs) or SOLID STATE DRIVES (SSDs)	21
STEP 7 SELECT PCIe OPTION CARD(s)	24
STEP 8 ORDER GPU CARDS AND GPU POWER CABLES (OPTIONAL)	25
STEP 9 ORDER POWER SUPPLY	26
STEP 10 SELECT AC POWER CORD(s)	27
STEP 11 ORDER TOOL-LESS RAIL KIT AND OPTIONAL REVERSIBLE CABLE MANAGEMENT ARM	30
STEP 12 ORDER A TRUSTED PLATFORM MODULE (OPTIONAL)	31
STEP 13 ORDER CISCO FLEXIBLE FLASH SD CARD MODULE	32
STEP 14 SELECT OPERATING SYSTEM AND VALUE-ADDED SOFTWARE	33
STEP 15 SELECT SERVICE and SUPPORT LEVEL	34
<b>OPTIONAL STEP - ORDER RACK(s)</b>	<b>40</b>
<b>OPTIONAL STEP - ORDER PDU</b>	<b>41</b>
<b>SUPPLEMENTAL MATERIAL</b>	<b>42</b>
Hyperconverged Systems	42
Chassis	44
Block Diagram	45
CPUs and DIMMs	46
Physical Layout	46
Memory Population Rules	47
DIMM Population Order	48
Serial Port Details	49
Upgrade and Servicing-Related Parts	50
Adding an Additional CPU (with CPU heat sink) or Replacing CPUs	51
Motherboard Lithium Battery	51
Thermal Grease (with syringe applicator) for CPU to Heatsink Seal	51
Air Baffle Replacement Kit	52
CPU Heat Sink Cleaning Kit	52
Riser Card Configuration and Options	53
RACKS	55
PDUs	57
KVM CABLE	58
<b>TECHNICAL SPECIFICATIONS</b>	<b>59</b>
Dimensions and Weight	59
Power Specifications	60
Environmental Specifications	63
Compliance Requirements	64

---

Discontinued EOL Products .....	65
---------------------------------	----

---

# CONTENTS

## OVERVIEW

Cisco HyperFlex™ Systems unlock the full potential of hyperconvergence. The systems are based on an end-to-end software-defined infrastructure, combining software-defined computing in the form of Cisco Unified Computing System (Cisco UCS) servers; software-defined storage with the powerful Cisco HX Data Platform and software-defined networking with the Cisco UCS fabric that will integrate smoothly with Cisco Application Centric Infrastructure (Cisco ACI™). Together with a single point of connectivity and hardware management, these technologies deliver a preintegrated and adaptable cluster that is ready to provide a unified pool of resources to power applications as your business needs dictate.

Figure 1 Cisco HX240c M4 Node (24-drive)

### Front View



### Rear View



# DETAILED VIEWS

## Chassis Front View

Figure 2 shows the 24-drive Cisco HX240c M4 Node (with front bezel removed).

Figure 2 Chassis Front View (24-drive version)

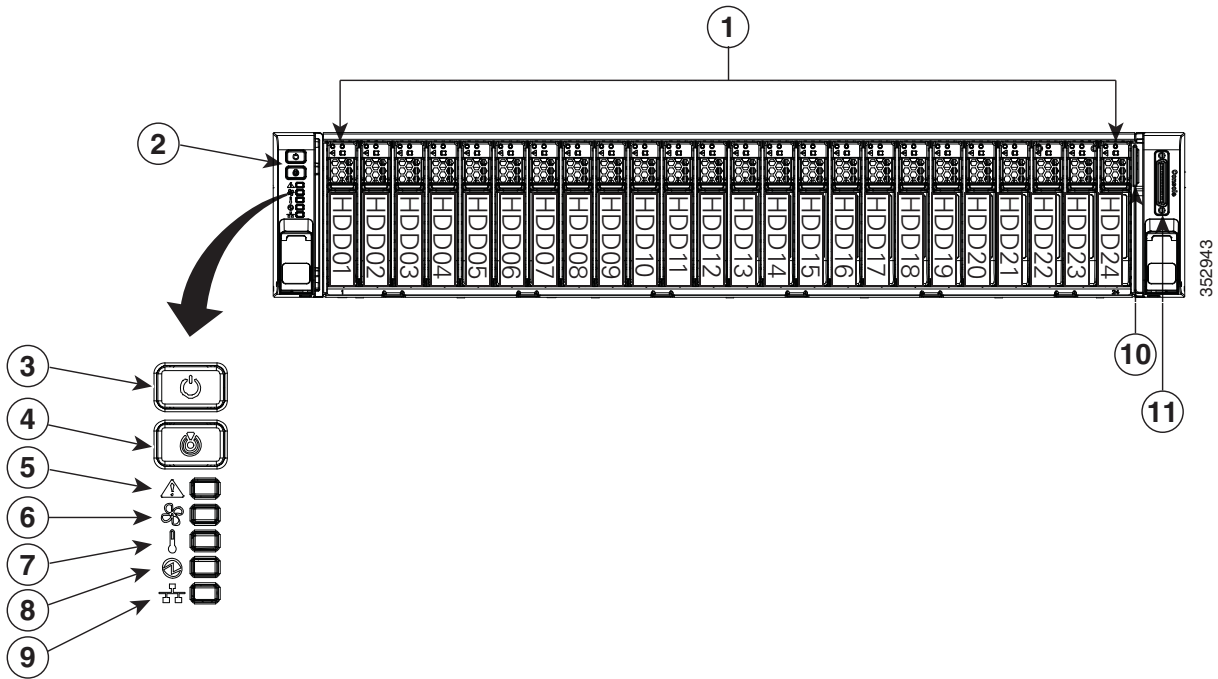

1	Front Mount Drives <sup>1</sup> <ul style="list-style-type: none"> <li>Up to 23 x 1.2 TB SAS HDDs or up to 23 x 1.8 TB SAS HDDs or up to 22 x 1.8 TB SAS SED HDDs (for data)</li> <li>1 x 1.6 TB SATA SSD, 1 x 1.6 TB SAS SED SSD, or 1 x 1.6 TB SAS SSD (for caching)</li> </ul>	7	Temperature status LED
2	Operations panel buttons and LEDs	8	Power supply status LED
3	Power button/LED	9	Network link activity LED
4	Unit Identification button/LED	10	Pull-out asset tag
5	System status LED	11	KVM connector (used with KVM cable that provides two USB 2.0, one VGA, and one serial connector)
6	Fan status LED	—	—

**Notes . . .**

1. 1 x 120 GB or 240 GB SATA SSD internal drive (on PCIe riser) is used for booting. Alternatively, a 120 GB or 240 GB front-mounting SATA SSD can be used for booting. If so, it displaces one of the front mounting data drives and all other drives must be SED drives..

For more information about the KVM cable connection, see [KVM CABLE, page 58](#).

## Chassis Rear View

Figure 3 shows the external features of the rear panel.

Figure 3 Chassis Rear View

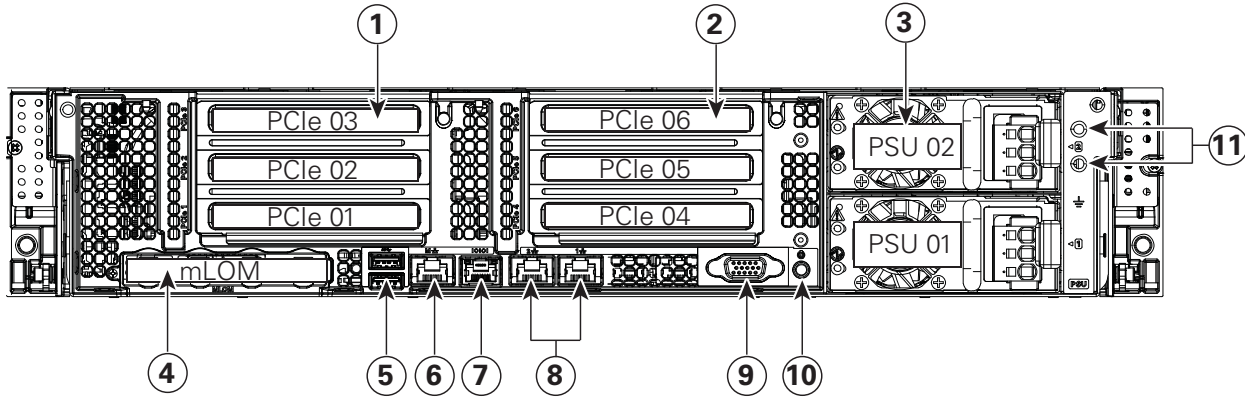

352947

1	PCIe riser 1 (slots 1, 2, 3)	7	Serial connector (RJ-45) <sup>1</sup>
2	PCIe riser 2 (slots 4, 5, 6)	8	Two embedded (on the motherboard) Intel i350 GbE Ethernet controller ports (LAN1, LAN2)
3	Power supplies (DC power supplies shown)	9	VGA video port (DB-15 connector)
4	Modular LAN-on-motherboard (mLOM) card slot	10	Rear Unit Identification button/LED
5	USB 3.0 ports (two)	11	Grounding-lug holes (for DC power supplies)
6	1-Gbps dedicated management port	—	—

Notes . . .

1. For serial port pinout details, see [Serial Port Details, page 49](#)



## BASE HX240c NODE STANDARD CAPABILITIES and FEATURES

*Table 1* lists the capabilities and features of the base node. Details about how to configure the node for a particular feature or capability (for example, number of processors, disk drives, or amount of memory) are provided in [CONFIGURING the HX240c M4 Node, page 12](#).

Table 1 Capabilities and Features

Capability/Feature	Description
Chassis	Two rack unit (2RU) chassis
CPU	Two Intel Xeon E5-2600 v3 or v4 series processor family CPUs
Chipset	Intel® C610 series chipset
Memory	24 slots for registered ECC DIMMs (RDIMMs)
Multi-bit Error Protection	Supports multi-bit error protection.
Embedded NIC	Two embedded (on the motherboard) Intel i350 GbE ports, supporting the following: <ul style="list-style-type: none"> <li>■ Pre-Execution Boot (PXE boot)</li> <li>■ iSCSI boot</li> <li>■ Checksum and segmentation offload</li> <li>■ NIC teaming</li> </ul>
Expansion slots	Up to six PCIe slots (on two riser cards) <ul style="list-style-type: none"> <li>■ Riser 1 (PCIe slots 1, 2, and 3), controlled by CPU 1</li> <li>■ Riser 2 (PCIe slots 4, 5, and 6), controlled by CPU 2. If GPU is ordered, it goes into slot 5.</li> <li>■ Dedicated disk controller slot (see <a href="#">Figure 7 on page 44</a>) <ul style="list-style-type: none"> <li>• An internal slot is reserved for use by the Cisco 12 Gbps Modular SAS HBA.</li> </ul> </li> </ul>
Video	The Cisco Integrated Management Controller (CIMC) provides video using the Matrox G200e video/graphics controller: <ul style="list-style-type: none"> <li>■ Integrated 2D graphics core with hardware acceleration</li> <li>■ DDR2/3 memory interface supports up to 512 MB of addressable memory (8 MB is allocated by default to video memory)</li> <li>■ Supports display resolutions up to 1920 x 1200 16bpp @ 60Hz</li> <li>■ High-speed integrated 24-bit RAMDAC</li> <li>■ Single lane PCI-Express host interface running at Gen 1 speed</li> </ul>

Capability/Feature	Description
Internal storage devices	<p>Drives are installed into front-panel drive bays that provide hot-pluggable access.</p> <ul style="list-style-type: none"> <li>■ Small Form Factor (SFF) drives.                             <ul style="list-style-type: none"> <li>• Up to 23 1.2 TB front-mounting SAS HDDs or up to 23 x 1.8 TB SAS HDDs or up to 22 x 1.2 TB SAS SED HDDs (for data)</li> <li>• One 1.6 TB front-mounting SATA or SAS SSD or one 1.6 TB SAS SED SSD (for caching)</li> <li>• One 120 GB or 240 internal SATA SSD or front-mounting SATA SSD (for booting). All other drives must be SED drives for configurations with front-mounting SATA SSDs.</li> </ul> </li> </ul>
Cisco Flexible Flash drives	<p>The system supports two internal 64 GB Cisco Flexible Flash drives (SD cards). The SD cards are mirrored to each other and are used for booting.</p>
Interfaces	<ul style="list-style-type: none"> <li>■ Rear panel                             <ul style="list-style-type: none"> <li>• One DB15 VGA connector</li> <li>• One RJ45 serial port connector</li> <li>• Two USB 3.0 port connectors</li> <li>• One RJ-45 10/100/1000 Ethernet management port, using Cisco Integrated Management Controller (CIMC) firmware</li> <li>• Two Intel i350 embedded (on the motherboard) GbE LOM ports</li> <li>• One flexible modular LAN on motherboard (mLOM) slot that accommodates the Cisco UCS VIC1227 VIC MLOM - Dual Port 10Gb SFP+ interface card.</li> <li>• Two PCIe 3.0 slots</li> </ul> </li> <li>■ Front panel                             <ul style="list-style-type: none"> <li>• One KVM console connector (supplies two USB 2.0 connectors, one VGA DB15 video connector, and one serial port (RS232) RJ45 connector)</li> </ul> </li> </ul>
Power subsystem	<p>Up to two of the following hot-swappable power supplies:</p> <ul style="list-style-type: none"> <li>■ 650 W (AC)</li> <li>■ 930 W (DC)</li> <li>■ 1200 W (AC)</li> <li>■ 1400 W (AC)</li> </ul> <p>One power supply is mandatory; one more can be added for 1 + 1 redundancy.</p>
Modular LAN on Motherboard (mLOM) slot	<p>The mLOM slot accommodates the following card:</p> <ul style="list-style-type: none"> <li>■ Cisco VIC 1227 Virtual Interface Cards</li> </ul>
WoL	<p>The 1-Gb Base-T Ethernet LAN ports support the wake-on-LAN (WoL) standard.</p>
Front Panel	<p>A front panel controller provides status indications and control buttons</p>
ACPI	<p>This system supports the advanced configuration and power interface (ACPI) 4.0 standard.</p>
Fans	<p>Chassis:</p> <ul style="list-style-type: none"> <li>■ Six hot-swappable fans for front-to-rear cooling</li> </ul>

---

Capability/Feature	Description
Storage controller	<ul style="list-style-type: none"><li>■ Cisco 12 Gbps Modular SAS HBA with internal SAS connectivity<ul style="list-style-type: none"><li>• Supports up to 23 front-mount HDDS (for data), one front-mount SSD (for caching) and one internal SSD drive (for SDS logs)</li><li>• Plugs into a dedicated internal disk controller slot</li><li>• No RAID support</li></ul></li></ul>
Integrated management processor	<p>Baseboard Management Controller (BMC) running Cisco Integrated Management Controller (CIMC) firmware.</p> <p>Depending on your CIMC settings, the CIMC can be accessed through the 1-GbE dedicated management port, the 1-GbE LOM ports, or a Cisco virtual interface card (VIC).</p>

---

## CONFIGURING the HX240c M4 Node

For the most part, this system comes with a fixed configuration. Follow these steps to see or change the configuration of the HX240c M4 Node:

- [STEP 1 VERIFY SKU, page 13](#)
- [STEP 2 SELECT RISER CARD \(OPTIONAL\), page 14](#)
- [STEP 3 SELECT CPU\(s\), page 15](#)
- [STEP 4 SELECT MEMORY, page 17](#)
- [STEP 5 SELECT DRIVE CONTROLLER, page 20](#)
- [STEP 6 SELECT HARD DISK DRIVES \(HDDs\) or SOLID STATE DRIVES \(SSDs\), page 21](#)
- [STEP 7 SELECT PCIe OPTION CARD\(s\), page 24](#)
- [STEP 8 ORDER GPU CARDS AND GPU POWER CABLES \(OPTIONAL\), page 25](#)
- [STEP 9 ORDER POWER SUPPLY, page 26](#)
- [STEP 10 SELECT AC POWER CORD\(s\), page 27](#)
- [STEP 11 ORDER TOOL-LESS RAIL KIT AND OPTIONAL REVERSIBLE CABLE MANAGEMENT ARM, page 30](#)
- [STEP 12 ORDER A TRUSTED PLATFORM MODULE \(OPTIONAL\), page 31](#)
- [STEP 13 ORDER CISCO FLEXIBLE FLASH SD CARD MODULE, page 32](#)
- [STEP 14 SELECT OPERATING SYSTEM AND VALUE-ADDED SOFTWARE, page 33](#)
- [STEP 15 SELECT SERVICE and SUPPORT LEVEL, page 34](#)
- [OPTIONAL STEP - ORDER RACK\(s\), page 40](#)
- [OPTIONAL STEP - ORDER PDU, page 41](#)

## STEP 1 VERIFY SKU

Verify the product ID (PID) from [Table 2](#).

Table 2 PID of the HX240c M4 Node

Product ID (PID)	Description
HX240C-M4SX <sup>1</sup>	HX240c M4 Node, with two CPUs, memory, 23 HDDs, two SSDs, two power supplies, two SD cards, one VIC 1227 mLOM card, no PCIe cards, and no rail kit
HX-M4S-HXDP	This major line bundle (MLB) consists of the Server Nodes (HX220C-M4S and HX240C-M4SX) with HXDP software spare PIDs
HX2X0C-M4S	This major line bundle (MLB) consists of the Server Nodes (HX220C-M4S and HX240C-M4SX), Fabric Interconnects (HX-FI-6248UP and HX-FI-6296UP), and HXDP software spare PIDs.

### Notes . . .

1. This product may not be purchased outside of the approved bundles (must be ordered under the MLB).

The HX240c M4 Node:

- Includes two power supplies, two CPUs, memory, hard disk drives (HDDs), solid-state drives (SSDs), VIC 1227 mLOM card, and SD cards
- Does not include rail kit or plug-in PCIe cards.



**NOTE:** Use the steps on the following pages to see or change the configuration of the system.

## STEP 2 SELECT RISER CARD (OPTIONAL)

There are two optional riser cards, riser card 1 and 2. There are three options for riser card 1. Order one riser card 1 from [Table 3](#) and one riser 2 card from [Table 4](#). Riser card 1 is the one on the left when viewed from the back of the server and riser card 2 is on the right.

Table 3 Riser 1 Options

Product ID (PID)	Description
UCSC-PCI-1A-240M4	C240 M4 PCIe Riser 1 Assy (option A) (2 PCIe slots: 1x8 and 1x16 GPU capable)
UCSC-PCI-1C-240M4	C240 M4 PCIe Riser 1 Assy (option C) (2 PCIe slots: 1x8 and 1x16 plus connectors for 2 SATA boot drives)

The selection of riser card 1 determines the number and type of PCIe cards and SATA boot drives supported in the riser.

Table 4 Riser 2 Options

Product ID (PID)	Description
UCSC-PCI-2-C240M4	PCIe Riser Board (Riser 2) for C240 M4 (3 slots: 2x8 and 1x16)

### Approved Configurations

#### (1) Internal boot

- If internal boot is selected, PCIe riser 1C (UCSC-PCI-1C-240M4) is required and one internal boot drives (HX-SD120GBKS4-EB or HX-SD240GBKS4-EB) must be selected.
- If the front boot option is selected, PCIe riser 1 (UCSC-PCI-1C-240M4) is not required.

#### (2) Front boot

- If front boot is selected, either the HX-SD120GBKS4-EV 120 GB or HX-SD240GBKS4-EV 240 GB front boot drive is selected and Riser 1C is not selected for internal boot (no SATA boot drives mounted on riser 1C).



**NOTE:** If no riser is selected, a riser blanking panel will be installed. You will not be able to install any PCIe cards without a riser selected

For additional details, see [Riser Card Configuration and Options, page 53](#).

### STEP 3 SELECT CPU(s)

The standard CPU features are:

- Intel Xeon E5-2600 v3 or v4 series processor family CPUs
- Intel C610 series chipset
- Cache size of up to 55 MB

#### Select CPUs

The available CPUs are listed in [Table 5](#).

Table 5 Available Intel CPUs

Product ID (PID)	Intel Number	Clock Freq (GHz)	Power (W)	Cache Size (MB)	Cores	QPI	Highest DDR4 DIMM Clock Support (MHz) <sup>1</sup>
<b>E5-2600 v4 Series Processor Family CPUs</b>							
HX-CPU-E52699E	E5-2699 v4	2.20	145	55	22	9.6 GT/s	2400
HX-CPU-E52699AE	E5-2699A v4	2.40	145	55	22	9.6 GT/s	2400
HX-CPU-E52698E	E5-2698 v4	2.20	135	50	20	9.6 GT/s	2400
HX-CPU-E52697AE	E5-2697A v4	2.60	145	40	16	9.6 GT/s	2400
HX-CPU-E52697E	E5-2697 v4	2.30	145	45	18	9.6 GT/s	2400
HX-CPU-E52695E	E5-2695 v4	2.10	120	45	18	9.6 GT/s	2400
HX-CPU-E52690E	E5-2690 v4	2.60	135	35	14	9.6 GT/s	2400
HX-CPU-E52683E	E5-2683 v4	2.10	120	40	16	9.6 GT/s	2400
HX-CPU-E52680E	E5-2680 v4	2.40	120	35	14	9.6 GT/s	2400
HX-CPU-E52667E	E5-2667 v4	3.20	135	25	8	9.6 GT/s	2400
HX-CPU-E52660E	E5-2660 v4	2.00	105	35	14	9.6 GT/s	2400
HX-CPU-E52658E	E5-2658 v4	2.30	105	35	14	9.6 GT/s	2400
HX-CPU-E52650E	E5-2650 v4	2.20	105	30	12	9.6 GT/s	2400
HX-CPU-E52650LE	E5-2650L v4	1.70	65	35	14	9.6 GT/s	2400
HX-CPU-E52640E	E5-2640 v4	2.40	90	25	10	8.0 GT/s	2133
HX-CPU-E52630E	E5-2630 v4	2.20	85	25	10	8.0 GT/s	2133
HX-CPU-E52630LE	E5-2630L v4	1.80	55	25	8	8.0 GT/s	2133
HX-CPU-E52620E	E5-2620 v4	2.10	85	20	8	8.0 GT/s	2133
HX-CPU-E52609E	E5-2609 v4	1.70	85	20	8	6.4 GT/s	1866

#### Notes . . .

1. If higher or lower speed DIMMs are selected than what is shown in the table for a given CPU, the DIMMs will be clocked at the lowest common denominator of CPU clock and DIMM clock.

## Approved Configurations

---

### (3) 2-CPU Configurations:

- Select two identical CPUs from any one of the rows of [Table 5 on page 15](#).

### Caveats

---

- You must select two identical processors.
- For optimal performance, select DIMMs with the highest clock speed for a given processor (see [Table 5 on page 15](#)). If you select DIMMs whose speeds are lower or higher than that shown in the tables, suboptimal performance will result.



## STEP 4 SELECT MEMORY

The standard memory features are:

- DIMMs
  - Clock speed: 2400 and 2133 MHz
  - Ranks per DIMM: 1, 2, 4, or 8
  - Operational voltage: 1.2 V
  - Registered ECC DDR4 DIMMs (RDIMMs), load-reduced DIMMs (LR-DIMMs), or thru-silicon-via DIMMs (TSV-DIMMs).
- Memory is organized with four memory channels per CPU, with up to three DIMMs per channel, as shown in [Figure 4](#).

Figure 4 HX240c M4 Mode Memory Organization

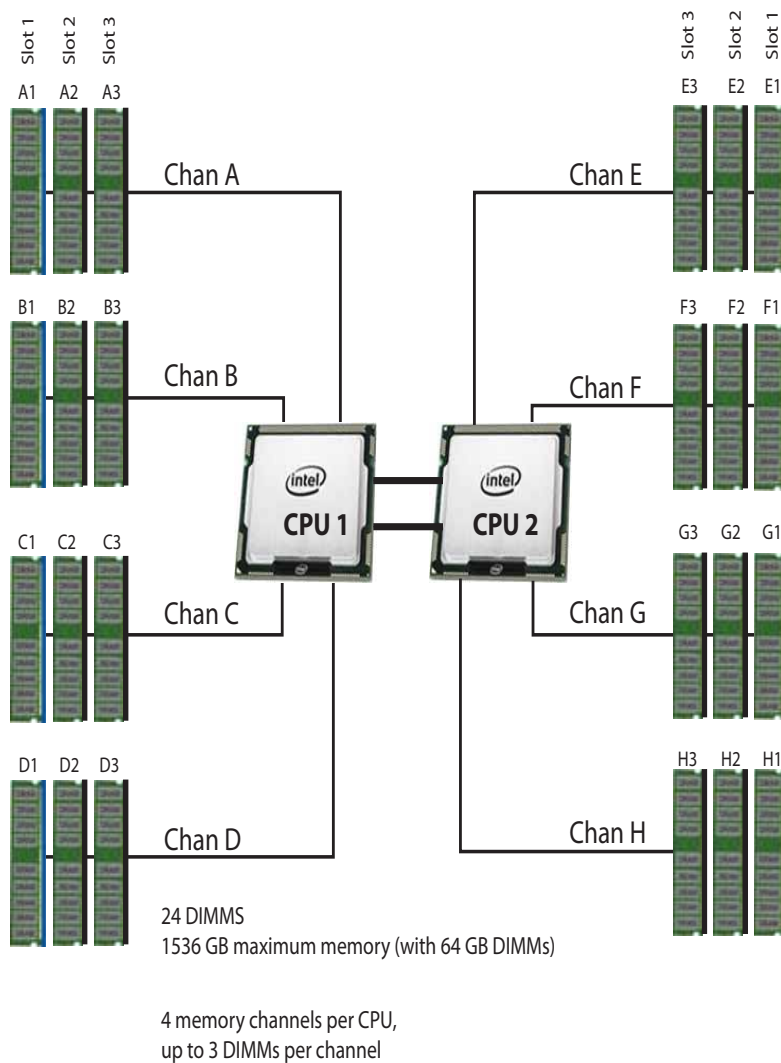

Select DIMMs

Select the desired DIMMs from [Table 6](#).

Table 6 Available DDR4 DIMMs

Product ID (PID)	PID Description	Voltage	Ranks/ DIMM
<b>DIMM Options</b>			
<b>2400-MHz DIMM Options</b>			
HX-ML-1X644RV-A	64 GB DDR4-2400-MHz LRDIMM/PC4-19200/quad rank/x4	1.2 V	4
HX-MR-1X322RV-A	32GB DDR4-2400-MHz RDIMM/PC4-19200/dual rank/x4	1.2 V	2
HX-MR-1X161RV-A	16GB DDR4-2400-MHz RDIMM/PC4-19200/single rank/x4	1.2 V	1

Approved Configurations

(1) 2-CPU configuration:

- Select either 8 or 12 identical DIMMs per CPU (16 or 24 total identical DIMMs). Refer to [Memory Population Rules, page 47](#), for more detailed information.



**NOTE:** System performance is optimized when the DIMM type and quantity are equal for both CPUs, and when all channels are filled equally across the CPUs in the system.

Caveats

- System speed is dependent on how many DIMMs are populated per channel and the CPU DIMM speed support. See [Table 7](#) for details.

Table 7 DIMM Memory Speeds with Different CPUs

DIMM Speed	DPC	1866-MHz Capable CPU	2133-MHz Capable CPU
		RDIMM (DR)	RDIMM (DR)
2133 DIMM <sup>1</sup>	3 DPC	1600	1866 (32 GB RDIMMs and 16 GB DIMMs)
	2 DPC	1866	2133
	1 DPC	1866	2133

Notes . . .

1. 2133-MHz DIMMs are the only offered and supported DIMMs for the HX220c M4 Node.

Table 8 2400-MHz DIMM Memory Speeds with Different v4 CPUs

DIMM and CPU Frequencies	DPC	LRDIMM (QRx4) - 64 GB	RDIMM (2Rx4) - 32 GB	RDIMM (SRx4) - 16 GB
		1.2 V	1.2 V	1.2 V
DIMM = 2400 MHz CPU = 2400 MHz	1DPC	2400 MHz	2400 MHz	2400 MHz
	2DPC	2400 MHz	2400 MHz	2400 MHz
	3DPC	2133 MHz	1866 MHz	2133 MHz
DIMM = 2400 MHz CPU = 2133 MHz	1DPC	2133 MHz	2133 MHz	2133 MHz
	2DPC	2133 MHz	2133 MHz	2133 MHz
	3DPC	1866 MHz	1866 MHz	1866 MHz
DIMM = 2400 MHz CPU = 1866 MHz	1DPC	1866 MHz	1866 MHz	1866 MHz
	2DPC	1866 MHz	1866 MHz	1866 MHz
	3DPC	1866 MHz	1600 MHz	1600 MHz

- The HX240c M4 Node supports the following memory reliability, availability, and serviceability (RAS) modes:
  - Independent Channel Mode
  - Lockstep Channel Mode
- Below are the system level RAS Mode combination limitations:
  - Mixing of Independent and Lockstep channel mode is not allowed per platform.
- DIMMs for CPU 1 and CPU 2 must always be configured identically.
- Non-ECC DIMMs are not supported.
- Pairs of DIMMs (A1/B1, A2/B2, etc) MUST be the exact same (same PID, rev, DIMM loading order)
- Cisco memory from previous generation systems (DDR3) is not compatible with this system

For more information regarding memory, see [CPUs and DIMMs, page 46](#).

## STEP 5 SELECT DRIVE CONTROLLER

### SAS HBA (internal HDD/SSD/non-RAID support)

Choose the following SAS HBA for internal drive connectivity (non-RAID):

- Cisco 12 Gbps Modular SAS HBA, which plugs into a dedicated RAID controller slot.

#### Select Controller Options

---

Select the following:

- Cisco 12 Gbps Modular SAS HBA (see [Table 9](#))

Table 9 Hardware Controller Options

Product ID (PID)	PID Description
<b>Controllers for Internal Drives</b>	
Note that the following Cisco 12Gbps Modular SAS HBA controller is factory-installed in the dedicated internal slot.	
HX-SAS12GHBA	Cisco 12 Gbps Modular SAS HBA <ul style="list-style-type: none"> <li>■ Supports up to 24 internal SAS HDDs and SAS/SATA SSDs</li> <li>■ No RAID functionality. Ideal for SDS (Software Defined Storage) applications. It is also ideal for environments demanding the highest IOPs (for external SSD attach), where a RAID controller can be an I/O bottleneck.</li> </ul>

#### Approved Configurations

---

- The Cisco 12 Gbps Modular SAS HBA supports up to 24 internal drives with non-RAID support.

## STEP 6 SELECT HARD DISK DRIVES (HDDs) or SOLID STATE DRIVES (SSDs)

The standard disk drive features are:

- 2.5-inch small form factor
- Hot-pluggable
- Drives come mounted in sleds



### NOTE:

All SED HDDs are FIPs 140-2 compliant  
 SED SSDs (10X endurance) are FIPS 140-2 compliant  
 SED SSDs (3X and 1X endurance) are not FIPS 140-2 compliant

### Select Drives

The available drives are listed in [Table 10](#).

**Table 10 Available Hot-Pluggable Sled-Mounted HDDs and SSDs**

Product ID (PID)	PID Description	Drive Type	Capacity
<b>HDD Data Drives</b>			
HX-HD12TB10K12G	1.2 TB 12G SAS 10K RPM SFF HDD	SAS	1.2 TB
HX-HD18TB10KS4K	1.8 TB 12G SAS 10K RPM SFF HDD	SAS	1.8 TB
<b>SSD Caching Drives</b>			
HX-SD16TB12S3-EP	1.6 TB 2.5 inch Enterprise Performance 6G SATA SSD (3X endurance)	SATA	1.6 TB
HX-SD16TSASS3-EP	1.6TB 2.5 inch Enterprise performance 12G SAS SSD(3X DWPD)	SAS	1.6 TB
<b>Internal SATA SSD Boot Drives</b>			
HX-SD120GBKS4-EB	120 GB 2.5 inch Enterprise Value 6G SATA SSD (boot)	SATA	120 GB
HX-SD240GBKS4-EB	240 GB 2.5 inch Enterprise Value 6G SATA SSD (boot)	SATA	240 GB
<b>Front SATA SSD Boot Drives</b>			
HX-SD120GBKS4-EV	120 GB 2.5 inch Enterprise Value 6G SATA SSD	SATA	120 GB
HX-SD240GBKS4-EV	240 GB 2.5 inch Enterprise Value 6G SATA SSD	SATA	240 GB
<b>SED Persistent Drives</b>			
HX-HD12G10K9	1.2 TB 12G SAS 10K RPM SFF HDD (SED)	SAS	1.2 TB
<b>SED Cache/WL Drives</b>			
HX-SD16TBEK9	1.6 TB Enterprise performance SAS SSD (10XFWPD, SED)	SAS	1.6 TB

**NOTE:** Cisco uses solid state drives (SSDs) from a number of vendors. All solid state drives (SSDs) are subject to physical write limits and have varying maximum usage limitation specifications set by the manufacturer. Cisco will not replace any solid state drives (SSDs) that have exceeded any maximum usage specifications set by Cisco or the manufacturer, as determined solely by Cisco

---

## Approved Configurations

---

### (1) Cisco 12 Gbps Modular SAS HBA

■ Select the following drives:

- From 6 to 23 front-mount 1.2 TB 12G SAS 10K RPM SFF HDD or 1.8 TB 12G SAS 10K RPM SFF HDD data drives (HX-HD12TB10K12G). If HX-HD12TB10K12G drives are selected, you cannot select any of the following:
  - HX-HD12G10K9
  - HX-SD16TBEK9
  - HX-SD120GBKS4-EV
  - HX-SD240GBKS4-EV
- From 6 to 22 SED persistent drives (HX-HD12G10K9). If selected, all drives must be SED drives and the front boot option must be selected (HX-SD120GBKS4-EV or HX-SD240GBKS4-EV). You cannot select any of the following drives:
  - HX-HD12TB10K12G or HX-HD18TB10KS4K
  - HX-SD16TB12S3-EP or HX-SD16TSASS3-EP
  - HX-SD120GBKS4-EB
  - HX-SD240GBKS4-EB
- One front-mount 1.6 TB 2.5 inch Enterprise Performance 6G SATA SSD caching drive (HX-SD16TB12S3-EP) or 1.6 TB 2.5 inch Enterprise performance 12G SAS SSD caching drive (HX-SD16TSASS3-EP). If this drive is selected, you cannot select any of the following:
  - HX-HD12G10K9
  - HX-SD16TBEK9
  - HX-SD120GBKS4-EV
  - HX-SD240GBKS4-EV
- One front-mount 1.6 TB SED cache/WL drive (HX-SD16TBEK9). If this drive is selected, all drives must be SED drives and the front boot option must be selected. You cannot select any of the following:
  - HX-HD12TB10K12G
  - HX-SD16TB12S3-EP or HX-SD16TSASS3-EP
  - HX-SD120GBKS4-EB
  - HX-SD240GBKS4-EB
- One internal 120 GB 2.5 inch Enterprise Value 6 G SATA SSD boot drive (HX-SD120GBKS4-EB) or one internal 240 GB 2.5 inch Enterprise Value 6 G SATA SSD boot drive (HX-SD240GBKS4-EB). If you select either of these drives, riser PID

UCSC-PCI-1C-240M4 is required and you cannot select front mounting boot drives (HX-SD120GBKS4-EV or HX-SD240GBKS4-EV).

- One front-mounting 120 GB 2.5 inch Enterprise Value 6G SATA SSD boot drive (HX-SD120GBKS4-EV) or one front-mounting 240 GB 2.5 inch Enterprise Value 6G SATA SSD boot drive (HX-SD240GBKS4-EV). Riser PID UCSC-PCI-1C-240M4 is not required and you cannot select internal boot drives (HX-SD120GBKS4-EB or HX-SD240GBKS4-EB)

See [SELECT DRIVE CONTROLLER](#), page 20 for more details.

## STEP 7 SELECT PCIe OPTION CARD(s)

The standard PCIe card offerings is:

- Modular LAN on Motherboard (mLOM)

### Select PCIe Option Card

---

The available PCIe option card is listed in [Table 11](#).

Table 11 Available PCIe Option Cards

Product ID (PID)	PID Description	Card Height
<b>Modular LAN on Motherboard (mLOM)<sup>1</sup></b>		
HX-MLOM-CSC-02	Cisco UCS VIC1227 VIC MLOM - Dual Port 10Gb SFP+	N/A
HX-MLOM-C40Q-03	Cisco VIC 1387 Dual Port 40Gb QSFP CNA MLOM	N/A

#### Notes . . .

1. The mLOM card does not plug into any of the riser 1 or riser 2 card slots; instead, it plugs into a connector inside the chassis.

### Caveats

---

- Other considerations for the Cisco VIC 1227 card:
  - VIC 1227 supports 10G SFP+ optical and copper twinax connections
  - The VIC 1227 is supported with the following software releases: 2.0.8h (CIMC) and above, and 2.2.6f (UCSM).



## STEP 8 ORDER GPU CARDS AND GPU POWER CABLES (OPTIONAL)

### Select GPU Options

The available GPU PCIe options are listed in [Table 12](#).

Table 12 Available PCIe Option Cards

Product ID (PID)	PID Description	Card Size	Maximum cards Per node
GPU PCIe Cards			
HX-GPU-M60 <sup>1</sup>	M60 GPU GRID 2.0	Full-height, double wide	-
HX-GPU-M10 <sup>2</sup>	NVIDIA M10	Full-height, double wide	1

#### Notes . . .

1. Requires 300 W cable kit (UCS-300WKIT-240M4)
2. Requires an additional power cable that is not included with the M10. When ordering an M10, you must to purchase a power cable (UCSC-GPUCBL-240M4=) for the GPU separately.



**CAUTION:** When using GPU cards, the operating temperature range is 32° to 95°F (0° to 35°C).



**NOTE:** All GPU cards require two CPUs and a minimum of two power supplies in the server. 1400 W power supplies are recommended. Use the power calculator at the following link to determine the needed power based on the options chosen (CPUs, drives, memory, and so on):

<http://ucspowercalc.cisco.com>

### Caveats

- NVIDIA GPUs can support only less than 1 TB of total memory in the server. Do not install more than fourteen 64-GB DIMMs when using an NVIDIA GPU card in this server.
- Slot 5 on optional riser card 2 (UCSC-PCI-2-C240M4) is the required slot for the GPU.
- For configurations with SED drives, up to 2 GPUs can be installed. Otherwise a maximum of one GPU can be installed. GPU mixing mode is allowed.
- If a GPU is installed, the chassis must be equipped with either a 1200 W or 1400 W power supply.

## STEP 9 ORDER POWER SUPPLY

The HX240c M4 node requires at least one power supply. A lightly loaded system may require one or two 650 W power supplies. A fully loaded system might need to be powered with two larger capacity power supplies. Use the power calculator at the following link to determine the needed power based on the options chosen (CPUs, drives, memory, and so on):

<http://ucspowercalc.cisco.com>

Table 13 Power Supply<sup>1</sup>

Product ID (PID)	PID Description
UCSC-PSU2-1400W	1400W AC Power Supply (200 - 240V) 2U & 4U C Series System
UCSC-PSU2V2-1200W <sup>2</sup>	1200W / 800W V2 AC Power Supply for 2U C-Series Systems
UCSC-PSU-930WDC	930 W -48V DC Common Slot Power Supply for C-series Systems
UCSC-PSU2V2-650W	650W V2 AC Power Supply for C-Series Systems

Notes . . .

1. If a GPU is installed, the chassis must be equipped with a 1200 W or 1400 W power supply.
2. The power output is 1200W with a 200-240V input and 800W with a 100-120V input.



**NOTE:** In a two power supply system, both power supplies must be identical.

---

## STEP 10 SELECT AC POWER CORD(S)

Using [Table 14](#), select the appropriate AC power cords. You can select a minimum of no power cords and a maximum of two. If you select the option R2XX-DMYMPWRCORD, no power cord is shipped with the system.

Table 14 Available Power Cords

Product ID (PID)	PID Description	Images
R2XX-DMYMPWRCORD	No power cord (dummy PID to allow for a no power cord option)	Not applicable
CAB-N5K6A-NA	Power Cord, 200/240V 6A, North America	
CAB-AC-L620-C13	AC Power Cord, NEMA L6-20 - C13, 2M/6.5ft	
CAB-C13-CBN	CABASY,WIRE,JUMPER CORD, 27" L, C13/C14, 10A/250V	
CAB-C13-C14-2M	CABASY,WIRE,JUMPER CORD, PWR, 2 Meter, C13/C14,10A/250V	
CAB-C13-C14-AC	CORD,PWR,JMP,IEC60320/C14,IEC60320/C13, 3.0M	

Table 14 Available Power Cords

Product ID (PID)	PID Description	Images
CAB-250V-10A-AR	Power Cord, 250V, 10A, Argentina	
CAB-9K10A-AU	Power Cord, 250VAC 10A 3112 Plug, Australia	
CAB-250V-10A-CN	AC Power Cord - 250V, 10A - PRC	
CAB-9K10A-EU	Power Cord, 250VAC 10A CEE 7/7 Plug, EU	
SFS-250V-10A-ID	Power Cord, SFS, 250V, 10A, India	
SFS-250V-10A-IS	Power Cord, SFS, 250V, 10A, Israel	
CAB-9K10A-IT	Power Cord, 250VAC 10A CEI 23-16/VII Plug, Italy	

Table 14 Available Power Cords

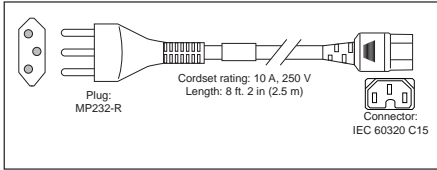
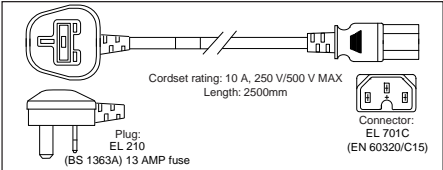
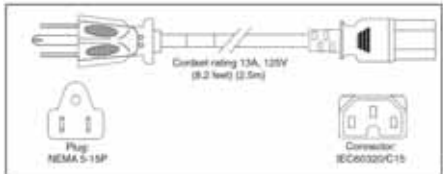
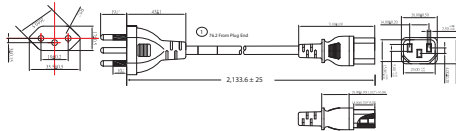
Product ID (PID)	PID Description	Images
CAB-9K10A-SW	Power Cord, 250VAC 10A MP232 Plug, Switzerland	 <p>Cordset rating: 10 A, 250 V Length: 8 ft. 2 in (2.5 m) Plug: MP232-R Connector: IEC 60320 C15</p>
CAB-9K10A-UK	Power Cord, 250VAC 10A BS1363 Plug (13 A fuse), UK	 <p>Cordset rating: 10 A, 250 V/500 V MAX Length: 2500mm Plug: EL 210 (BS 1363A) 13 AMP fuse Connector: EL 701C (EN 60320/C15)</p>
CAB-9K12A-NA	Power Cord, 125VAC 13A NEMA 5-15 Plug, North America	 <p>Cordset rating: 13A, 125V (8.3 feet) (2.5m) Plug: NEMA 5-15P Connector: IEC60320/C15</p>
CAB-250V-10A-BR	Power Cord - 250V, 10A - Brazil	 <p>2,133.6 ± 25</p>
CAB-JPN-3PIN	Power Cord 3PIN, Japan	Image not available

## STEP 11 ORDER TOOL-LESS RAIL KIT AND OPTIONAL REVERSIBLE CABLE MANAGEMENT ARM

### Select a Tool-Less Rail Kit

---

Select a tool-less rail kit from [Table 15](#).

Table 15 Tool-Less Rail Kit Options

Product ID (PID)	PID Description
UCSC-RAILB-M4	Ball Bearing Rail Kit

### Select an Optional Reversible Cable Management Arm

---

The reversible cable management arm mounts on either the right or left slide rails at the rear of the system and is used for cable management. Use [Table 16](#) to order a cable management arm.

Table 16 Cable Management Arm

Product ID (PID)	PID Description
UCSC-CMA-M4	Reversible CMA for tool-less ball bearing rail kit

For more information about the tool-less rail kit and cable management arm, see the *Cisco UCS C240 M4 Installation and Service Guide* at this URL:

[http://www.cisco.com/c/en/us/td/docs/unified\\_computing/ucs/c/hw/C240M4/install/C240M4.html](http://www.cisco.com/c/en/us/td/docs/unified_computing/ucs/c/hw/C240M4/install/C240M4.html)



**NOTE:** If you plan to rackmount your HX240c M4 node, you must order a tool-less tool-less rail kit.

---

## STEP 12 ORDER A TRUSTED PLATFORM MODULE (OPTIONAL)

Trusted Platform Module (TPM) is a computer chip (microcontroller) that can securely store artifacts used to authenticate the platform (system). These artifacts can include passwords, certificates, or encryption keys. A TPM can also be used to store platform measurements that help ensure that the platform remains trustworthy. Authentication (ensuring that the platform can prove that it is what it claims to be) and attestation (a process helping to prove that a platform is trustworthy and has not been breached) are necessary steps to ensure safer computing in all environments.

The TPM ordering information is listed in [Table 17](#).

Table 17 Trusted Platform Module

Product ID (PID)	PID Description
UCSX-TPM2-001	Trusted Platform Module 1.2 SPI-based



**NOTE:** The TPM module used in this system conforms to TPM v1.2 and 2.0, as defined by the Trusted Computing Group (TCG). It is also SPI-based.

## STEP 13 ORDER CISCO FLEXIBLE FLASH SD CARD MODULE

You must order two 64 GB or two 32 GB SD cards. The SD cards are mirrored to each other and are used for booting. See [Figure 7 on page 44](#) for the location of the SD cards. There are two locations, SD1 and SD2.

Table 18 Secure Digital (SD) Card

Product ID (PID)	PID Description
HX-SD-64G-S	64 GB SD Card

### Caveats

---

- You must select two 64 GB or two 32 GB SD cards. No mixing is allowed.



## STEP 14 SELECT OPERATING SYSTEM AND VALUE-ADDED SOFTWARE

Several operating systems and value-added software programs are available. Select as desired from [Table 19](#).

Table 19 OSs and Value-Added Software

PID Description	Product ID (PID)
<b>VMware<sup>1</sup></b>	
HX-VSP-STD-D	Factory Installed - VMware vSphere6 Std SW and Lic (2 CPU)
HX-VSP-STD-DL	Factory Installed - VMware vSphere6 Standard SW Download
HX-VSP-EPL-D	Factory Installed - VMware vSphere6 Ent Plus SW+Lic (2 CPU)
HX-VSP-EPL-DL	Factory Installed - VMware vSphere6 Enterprise Plus SW Dnld
HX-VSP-FND-D	Factory Installed - vSphere SW (End user to provide License)
HX-VSP-FND-DL	Factory Installed - VMware vSphere6 Foundation SW Download
HX-VSP-STD-D	Factory Installed - VMware vSphere6 Std SW and Lic (2 CPU)
HX-VSP-STD-DL	Factory Installed - VMware vSphere6 Standard SW Download
<b>Microsoft Windows Server</b>	
HX-MSWS-19-DC-RM	Windows Server 2019 DC (16Cores/Unlim VM) Rec Media DVD Only
HX-MSWS-19-DC16C	Windows Server 2019 Data Center (16 Cores/Unlimited VMs)
HX-MSWS-19-DCA2C	Windows Server 2019 Data Center - Additional 2 Cores
HX-MSWS-19-ST-RM	Windows Server 2019 Stan (16 Cores/2 VMs) Rec Media DVD Only
HX-MSWS-19-ST16C	Windows Server 2019 Standard (16 Cores/2 VMs)
HX-MSWS-19-STA2C	Windows Server 2019 Standard - Additional 2 Cores
<b>Software Subscription</b>	
HXDP-001-2YR	Cisco HyperFlex HX Data Platform SW 1 Yr Subscription
HXDP-001-4YR	Cisco HyperFlex HX Data Platform SW 3 Yr Subscription
HXDP-S001-1YR=	Cisco HyperFlex HX Data Platform SW 1 yr Subscription v2.0
HXDP-S001-2YR=	Cisco HyperFlex HX Data Platform SW 2 yr Subscription v2.0
HXDP-S001-3YR=	Cisco HyperFlex HX Data Platform SW 3 yr Subscription v2.0
HXDP-S001-4YR=	Cisco HyperFlex HX Data Platform SW 4 yr Subscription v2.0
HXDP-S001-5YR=	Cisco HyperFlex HX Data Platform SW 5 yr Subscription v2.0

### Notes . . .

1. Although VMware 6.0 is installed at the factory, both VMware 5.5 and VMware 6.0 are supported.

## STEP 15 SELECT SERVICE and SUPPORT LEVEL

A variety of service options are available, as described in this section.

### Smart Net Total Care (SNTC)

For support of the entire HyperFlex System, Cisco offers the Cisco Smart Net Total Care Service. This service provides expert software and hardware support to help sustain performance and high availability of the Hyper-Converged environment. Access to Cisco Technical Assistance Center (TAC) is provided around the clock, from anywhere in the world.

For systems that include Unified Computing System Manager, the support service includes downloads of UCSM upgrades. The Cisco Smart Net Total Care Service includes flexible hardware replacement options, including replacement in as little as two hours. There is also access to Cisco's extensive online technical resources to help maintain optimal efficiency and uptime of the unified computing environment. For more information please refer to the following url: <http://www.cisco.com/c/en/us/services/technical/smart-net-total-care.html?stickynav=1>

You can choose a desired service listed in [Table 20](#).

Table 20 Cisco Smart Net Total Care Service (SNTC) (PID HX240C-M4SX)

Service SKU	Service Level GSP	On Site?	Description
CON-3OSP-HX240M4S	3C4P	Yes	3YR SNTC 24X7X4OS
CON-3SNT-HX240M4S	3SNT	No	3YR SNTC 8X5XNBD
CON-3SNTP-HX240M4S	3SNTP	No	3YR SNTC 24X7X4
CON-PREM-HX240M4S	C2P	Yes	SNTC 24X7X2OS
CON-UCSD8-HX240M4S	UCSD8	Yes	UC SUPP DR 24X7X2OS*
CON-C2PL-HX240M4S	C2PL	Yes	LL 24X7X2OS**
CON-OSP-HX240M4S	C4P	Yes	SNTC 24X7X4OS
CON-UCSD7-HX240M4S	UCSD7	Yes	UCS DR 24X7X4OS*
CON-C4PL-HX240M4S	C4PL	Yes	LL 24X7X4OS**
CON-USD7L-HX240M4S	USD7L	Yes	LLUCS HW DR 24X7X4OS***
CON-OSE-HX240M4S	C4S	Yes	SNTC 8X5X4OS
CON-UCSD6-HX240M4S	UCSD6	Yes	UC SUPP DR 8X5X4OS*
CON-SNCO-HX240M4S	SNCO	Yes	SNTC 8x7xNCDOS****
CON-OS-HX240M4S	CS	Yes	SNTC 8X5XNBDOS
CON-UCSD5-HX240M4S	UCSD5	Yes	UCS DR 8X5XNBDOS*
CON-S2P-HX240M4S	S2P	No	SNTC 24X7X2
CON-S2PL-HX240M4S	S2PL	No	LL 24X7X2**

Table 20 Cisco Smart Net Total Care Service (SNTC) (continued)(PID HX240C-M4SX)

Service SKU	Service Level GSP	On Site?	Description
CON-SNTP-HX240M4S	SNTP	No	SNTC 24X7X4
CON-SNTPL-HX240M4S	SNTPL	No	LL 24X7X4**
CON-SNTE-HX240M4S	SNTE	No	SNTC 8X5X4
CON-SNC-HX240M4S	SNC	No	SNTC 8x7xNCD****
CON-SNT-HX240M4S	SNT	No	SNTC 8X5XNBD
CON-SW-HX240M4S	SW	No	SNTC NO RMA

\*Includes Drive Retention (see below for full description)

\*\*Includes Local Language Support (see below for full description) - Only available in China and Japan

\*\*\*Includes Local Language Support and Drive Retention - Only available in China and Japan

\*\*\*\*Available in China only

#### Smart Net Total Care with Onsite Troubleshooting Service

An enhanced offer over traditional Smart Net Total Care which provides onsite troubleshooting expertise to aid in the diagnostics and isolation of hardware issue within our customers' Cisco Hyper-Converged environment. It is delivered by a Cisco Certified field engineer (FE) in collaboration with remote TAC engineer and Virtual Internet working Support Engineer (VISE). You can choose a desired service listed in [Table 21](#)

Table 21 SNTC with UCS Onsite Troubleshooting Service (PID HX240C-M4SX)

Service SKU	Service Level GSP	On Site?	Description
CON-OSPT-HX240M4S	OSPT	Yes	24X7X4OS Trblshtg
CON-OSPTD-HX240M4S	OSPTD	Yes	24X7X4OS TrblshtgDR*
CON-OSPTL-HX240M4S	OSPTL	Yes	24X7X4OS TrblshtgLL**
CON-OPTLD-HX240M4S	OPTLD	Yes	24X7X4OS TrblshtgLLD***

\*Includes Drive Retention (see below for full description)

\*\*Includes Local Language Support (see below for full description) - Only available in China and Japan

\*\*\*Includes Local Language Support and Drive Retention - Only available in China and Japan

### Solution Support

Solution Support includes both Cisco product support and solution-level support, resolving complex issues in multivendor environments, on average, 43% more quickly than product support alone. Solution Support is a critical element in data center administration, to help rapidly resolve any issue encountered, while maintaining performance, reliability, and return on investment.

This service centralizes support across your multivendor Cisco environment for both our products and solution partner products you've deployed in your ecosystem. Whether there is an issue with a Cisco or solution partner product, just call us. Our experts are the primary point of contact and own the case from first call to resolution. For more information please refer to the following url:

<http://www.cisco.com/c/en/us/services/technical/solution-support.html?stickynav=1>

You can choose a desired service listed in [Table 22](#).

**Table 22 Solution Support Service (PID HX240C-M4SX)**

Service SKU	Service Level GSP	On Site?	Description
CON-SSC2P-HX240M4S	SSC2P	Yes	SOLN SUPP 24X7X2OS
CON-SSC4P-HX240M4S	SSC4P	Yes	SOLN SUPP 24X7X4OS
CON-SSC4S-HX240M4S	SSC4S	Yes	SOLN SUPP 8X5X4OS
CON-SSCS-HX240M4S	SSCS	Yes	SOLN SUPP 8X5XNBDOS
CON-SSDR7-HX240M4S	SSDR7	Yes	SSPT DR 24X7X4OS*
CON-SSDR5-HX240M4S	SSDR5	Yes	SSPT DR 8X5XNBDOS*
CON-SSS2P-HX240M4S	SSS2P	No	SOLN SUPP 24X7X2
CON-SSSNP-HX240M4S	SSSNP	No	SOLN SUPP 24X7X4
CON-SSSNE-HX240M4S	SSSNE	No	SOLN SUPP 8X5X4
CON-SSSNC-HX240M4S	SSSNC	No	SOLN SUPP NCD**
CON-SSSNT-HX240M4S	SSSNT	No	SOLN SUPP 8X5XNBD

\*Includes Drive Retention (see below for full description)

\*\*\*\*Available in China only

**Table 23 Solution Support Service (PID HX240C-M4SX)**

Service SKU	Service Level GSP	On Site?	Description
SP-SSC2P-HX240M4S	SSC2P	Yes	SOLN SUPP 24X7X2OS

Table 23 Solution Support Service (PID HX240C-M4SX) (continued)

Service SKU	Service Level GSP	On Site?	Description
SP-SSC4P-HX240M4S	SSC4P	Yes	SOLN SUPP 24X7X4OS
SP-SSC4S-HX240M4S	SSC4S	Yes	SOLN SUPP 8X5X4OS
SP-SSCS-HX240M4S	SSCS	Yes	SOLN SUPP 8X5XNBDOS
SP-SSS2P-HX240M4S	SSS2P	No	SOLN SUPP 24X7X2
SP-SSS4P-HX240M4S	SSS4P	No	SOLN SUPP 24X7X4
SP-SSSNE-HX240M4S	SSSNE	No	SOLN SUPP 8X5X4
SP-SSSNT-HX240M4S	SSSNT	No	SOLN SUPP 8X5XNBD

### Partner Support Service for UCS

Cisco Partner Support Service (PSS) is a Cisco Collaborative Services service offering that is designed for partners to deliver their own branded support and managed services to enterprise customers. Cisco PSS provides partners with access to Cisco's support infrastructure and assets to help them:

- Expand their service portfolios to support the most complex network environments
- Lower delivery costs
- Deliver services that increase customer loyalty

PSS options enable eligible Cisco partners to develop and consistently deliver high-value technical support that capitalizes on Cisco intellectual assets. This helps partners to realize higher margins and expand their practice.

PSS is available to all Cisco PSS partners.

PSS provides hardware and software support, including triage support for third party software, backed by Cisco technical resources and level three support. You can choose a desired service listed in [Table 24](#).

Table 24 PSS (PID HX240C-M4SX)

Product ID (PID)	Service Level GSP	On Site?	Description
CON-PSJ8- HX240M4S	PSJ8	Yes	UCS PSS 24X7X2 OS
CON-PSJ7- HX240M4S	PSJ7	Yes	UCS PSS 24X7X4 OS
CON-PSJD7-HX240M4S	PSJD7	Yes	UCS PSS 24X7X4 DR*
CON-PSJ6- HX240M4S	PSJ6	Yes	UCS PSS 8X5X4 OS
CON-PSJD6-HX240M4S	PSJD6	Yes	UCS PSS 8X5X4 DR*
CON-PSJ4- HX240M4S	PSJ4	No	UCS SUPP PSS 24X7X2
CON-PSJ3- HX240M4S	PSJ3	No	UCS SUPP PSS 24X7X4

Table 24 PSS (PID HX240C-M4SX)

Product ID (PID)	Service Level GSP	On Site?	Description
CON-PSJ2- HX240M4S	PSJ2	No	UCS SUPP PSS 8X5X4
CON-PSJ1- HX240M4S	PSJ1	No	UCS SUPP PSS 8X5XNBD
*Includes Drive Retention (see below for full description)			

**Combined Support Service**

Combined Services makes it easier to purchase and manage required services under one contract. Smart Net Total Care services for UCS help increase the availability of your vital data center infrastructure and realize the most value from your unified computing investment. The more benefits you realize from the Cisco Unified Computing System (Cisco UCS), the more important the technology becomes to your business. These services allow you to:

- Optimize the uptime, performance, and efficiency of your UCS
- Protect your vital business applications by rapidly identifying and addressing issues
- Strengthen in-house expertise through knowledge transfer and mentoring
- Improve operational efficiency by allowing UCS experts to augment your internal staff resources
- Enhance business agility by diagnosing potential issues before they affect your operations

You can choose a service listed in [Table 25](#).

Table 25 Combined Support Service (PID HX240C-M4SX)

Product ID (PID)	Service Level GSP	On Site?	Description
CON-NCF2P-HX240M4	NCF2P	Yes	CMB SVC 24X7X2OS
CON-NCF4P-HX240M4	NCF4P	Yes	CMB SVC 24X7X4OS
CON-NCF4S-HX240M4S	NCF4S	Yes	CMB SVC 8X5X4OS
CON-NCFCS-HX240M4	NCFCS	Yes	CMB SVC 8X5XNBDOS
CON-NCF2-HX240M4S	NCF2	No	CMB SVC 24X7X2
CON-NCFP-HX240M4S	NCFP	No	CMB SVC 24X7X4
CON-NCFE-HX240M4S	NCFE	No	CMB SVC 8X5X4
CON-NCFT-HX240M4S	NCFT	No	CMB SVC 8X5XNBD
CON-NCFW-HX240M4S	NCFW	No	CMB SVC SW

**SP Base Service**

Cisco SP Base is Cisco’s core foundational product support offer for service provider customers. This device-level service helps reduce downtime with fast, expert technical support and flexible hardware coverage provided by the Cisco Technical Assistance Center (TAC). It also offers

integrated smart capabilities, providing current information about installed base, contracts, and security alerts to enhance the efficiency of support workflows. You can choose a service listed in [Table 26](#).

Table 26 SP Base Service (PID HX240C-M4SX)

Product ID (PID)	Service Level GSP	On Site?	Description
SP-OS4-HX240M4S	SPC2P	Yes	SP Base 24X7X2OS
SP-OS3-HX240M4S	SPC4P	Yes	SP Base 24X7X4OS
SP-OS2-HX240M4S	SPC4S	Yes	SP Base 8X5X4OS
SP-OS1-HX240M4S	SPCS	Yes	SP Base 8X5XNBDOS
SP-AR4-HX240M4S	SPAR4	No	SP Base 24X7X2
SP-AR3-HX240M4S	SPAR3	No	SP Base 24X7X4
SP-AR2-HX240M4S	SPAR2	No	SP Base 8X5X4
SP-AR1-HX240M4S	SPAR1	No	SP Base 8X5XNBD

#### UCS Drive Retention Service

With the Cisco Drive Retention Service, you can obtain a new disk drive in exchange for a faulty drive without returning the faulty drive.

Sophisticated data recovery techniques have made classified, proprietary, and confidential information vulnerable, even on malfunctioning disk drives. The Drive Retention service enables you to retain your drives and ensures that the sensitive data on those drives is not compromised, which reduces the risk of any potential liabilities. This service also enables you to comply with regulatory, local, and federal requirements.

If your company has a need to control confidential, classified, sensitive, or proprietary data, you might want to consider one of the Drive Retention Services listed in the above tables (where available)



**NOTE:** Cisco does not offer a certified drive destruction service as part of this service.

#### Local Language Technical Support for UCS

Where available, and subject to an additional fee, local language support for calls on all assigned severity levels may be available for specific product(s) - see tables above.

For a complete listing of available services for Cisco HyperFlex System, see the following URL: <https://www.cisco.com/c/en/us/services/technical.html?stickynav=1>

## OPTIONAL STEP - ORDER RACK(S)

The optional R42610 rack is available from Cisco for the C-Series systems, including the HX240c M4 Node. This rack is a standard 19-inch rack and can be ordered with a variety of options, as listed in [Table 27](#). Racks are shipped separately from the HX240c M4 Node.

**Table 27** Racks and Rack Options

Product ID (PID)	PID Description
RACK-UCS <sup>1</sup>	Cisco R42610 expansion rack, no side panels
RACK-UCS2 <sup>1</sup>	Cisco R42610 standard rack, w/side panels
RACK-BLANK-001	Filler panels (qty 12), 1U, plastic, toolless
RACK-CBLMGT-001	Cable mgt D rings (qty 10), metal
RACK-CBLMGT-011	Cable mgt straps (qty 10), Velcro
RACK-FASTEN-001	Mounting screws (qty 100), M6
RACK-FASTEN-002	Cage nuts (qty 50), M6
RACK-JOIN-001	Rack joining kit

**Notes . . .**

1. Use these same base PIDs to order spare racks (available only as next-day replacements).

For more information about the R42610 rack, see [RACKS, page 55](#).



## OPTIONAL STEP - ORDER PDU

An optional power distribution unit (PDU) is available from Cisco for the C-Series rack systems, including the HX240c M4 Node. This PDU is available in a zero rack unit (RU) style (see [Table 28](#)).

Table 28 PDU Options

Product ID (PID)	PID Description
RP208-30-2P-U-2	Zero RU PDU

For more information about the PDU, see [PDUs, page 57](#).

# SUPPLEMENTAL MATERIAL

## Hyperconverged Systems

Cisco HyperFlex Systems let you unlock the full potential of hyperconvergence and adapt IT to the needs of your workloads. The systems use an end-to-end software-defined infrastructure approach, combining software-defined computing in the form of Cisco HyperFlex HX-Series nodes; software-defined storage with the powerful Cisco HX Data Platform; and software-defined networking with the Cisco UCS fabric that will integrate smoothly with Cisco Application Centric Infrastructure (Cisco ACI). Together with a single point of connectivity and management, these technologies deliver a preintegrated and adaptable cluster with a unified pool of resources that you can quickly deploy, adapt, scale, and manage to efficiently power your applications and your business.

Figure 5 shows a small footprint cluster and Figure 6 shows a compute-intensive hybrid cluster.

Figure 5 Small Footprint Cluster Using HX240c M4 Nodes

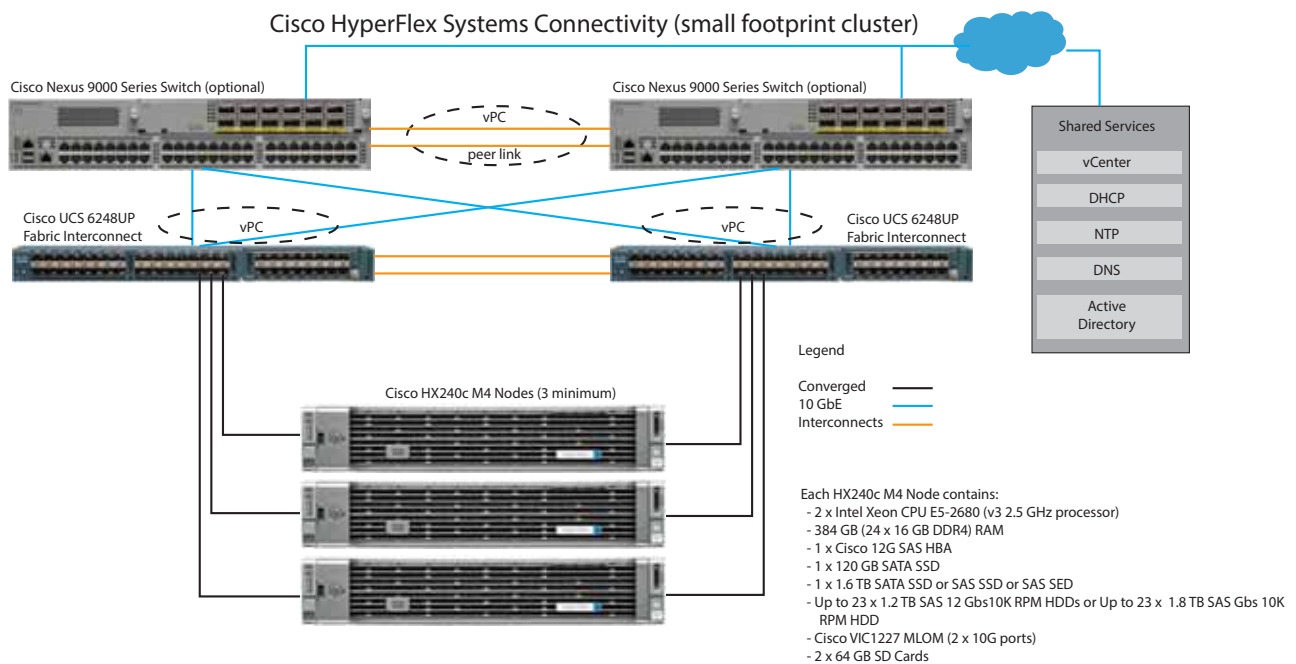
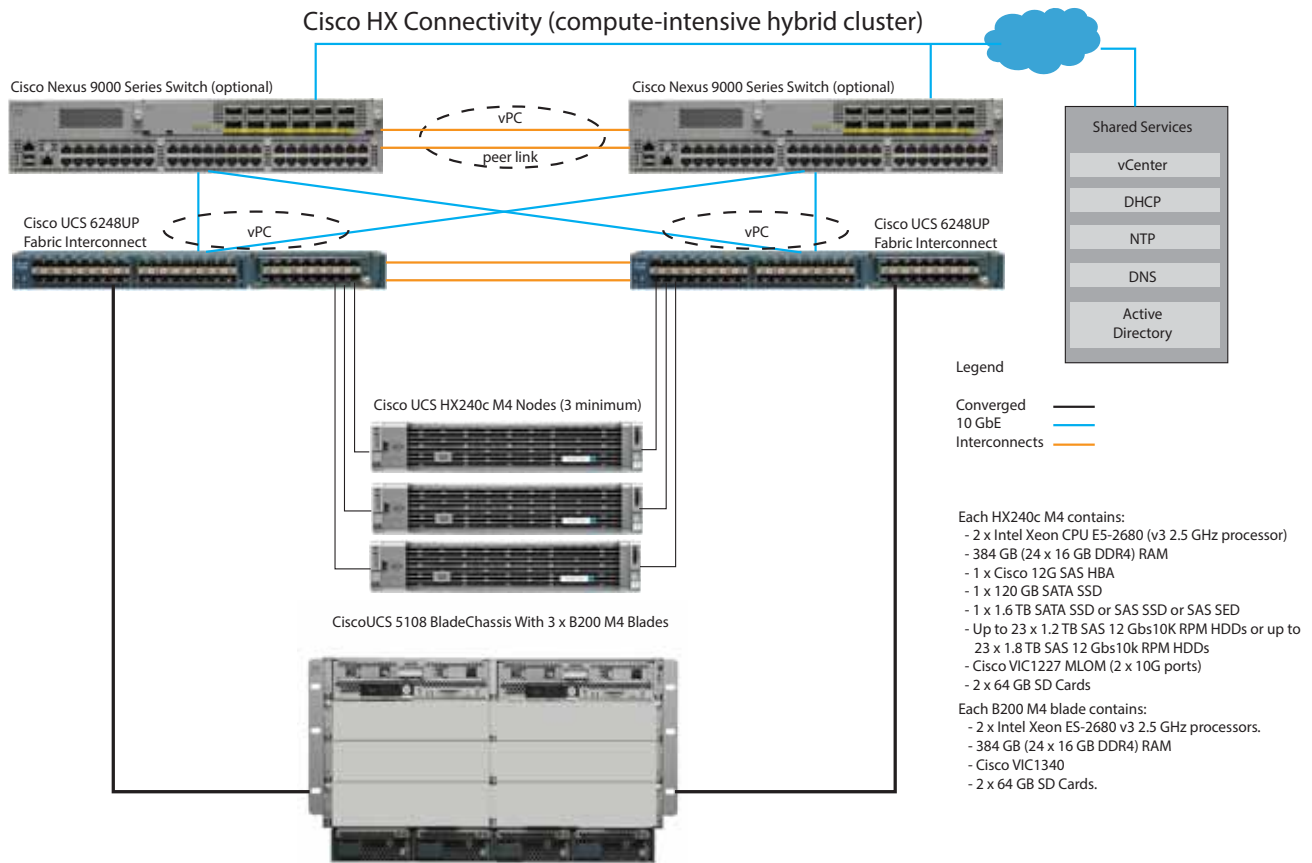

Figure 6 Compute-Intensive Hybrid Cluster Using HX240c M4 Nodes and B200 M4 Blades



## Chassis

An internal view of the HX240c M4 Node chassis with the top cover removed is shown in [Figure 7](#). The location of the two SD cards is marked with callout #5 and the location of the SATA SSD SDS logs drives is marked with callout #11.

Figure 7 HX240c M4 Node Chassis With Top Cover Off

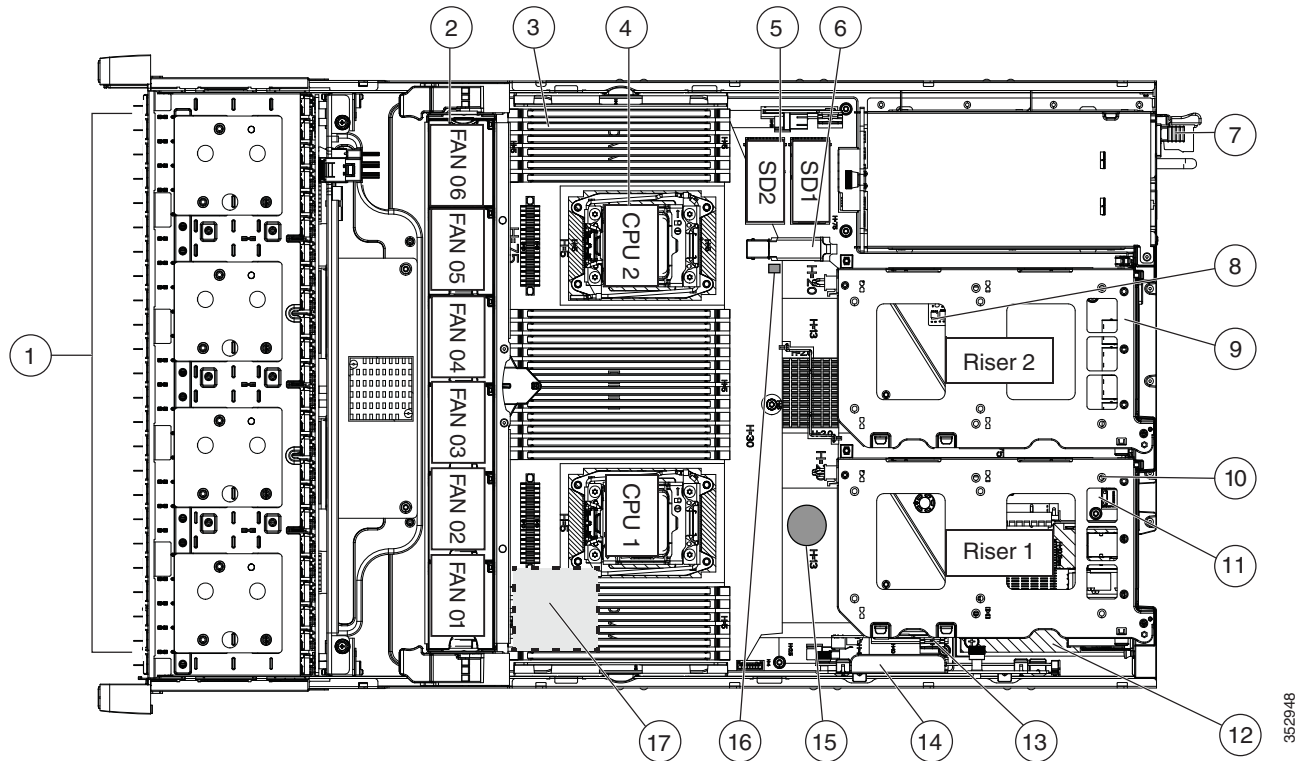

352948

1	Drives (SAS/SATA drives are hot-swappable)	10	PCIe riser 1 (PCIe slots 1, 2, 3*)
2	Fan modules (six, hot-swappable)	11	SATA SSD SDS logs drives (two sockets available only on PCIe riser 1)
3	DIMM sockets on motherboard (either 16 or 24 DIMMs populated)	12	mLOM card socket on motherboard under PCIe riser 1
4	CPUs and heatsinks (two)	13	Socket for embedded RAID interposer board (not used)
5	Cisco SD card slots on motherboard (two)	14	Cisco modular drive controller PCIe slot (dedicated slot and bracket)
6	USB 3.0 slot on motherboard (not used)	15	RTC battery on motherboard
7	Power supplies (hot-swappable, accessed through rear panel)	16	Embedded RAID header for RAID key (not used)
8	Trusted platform module (TPM) socket on motherboard, under PCIe riser 2	17	SuperCap power module (RAID backup) mounting location on air baffle (not shown) (not used)
9	PCIe riser 2 (PCIe slots 4, 5, 6)	—	—



## CPU and DIMMs

### Physical Layout

Each CPU has four DIMM channels:

- CPU1 has channels A, B, C, and D
- CPU2 has channels E, F, G, and H

Each DIMM channel has three slots: slot 1, slot 2, and slot 3. The blue-colored DIMM slots are for slot 1, the black-colored slots for slot 2, and the white slots for slot 3.

As an example, DIMM slots A1, B1, C1, and D1 belong to slot 1, while A2, B2, C2, and D2 belong to slot 2.

*Figure 9* shows how slots and channels are physically laid out on the motherboard. The DIMM slots on the right half of the motherboard (channels A, B, C, and D) are associated with CPU 1, while the DIMM slots on the left half of the motherboard (channels E, F, G, and H) are associated with CPU 2. The slot 1 (blue) DIMM slots are always located farther away from a CPU than the corresponding slot 2 (black) and slot 3 (white) slots. Slot 1 slots (blue) are populated before slot 2 slots (black) and slot 3 (white) slots.

Figure 9 Physical Layout of CPU DIMM Channels and Slots

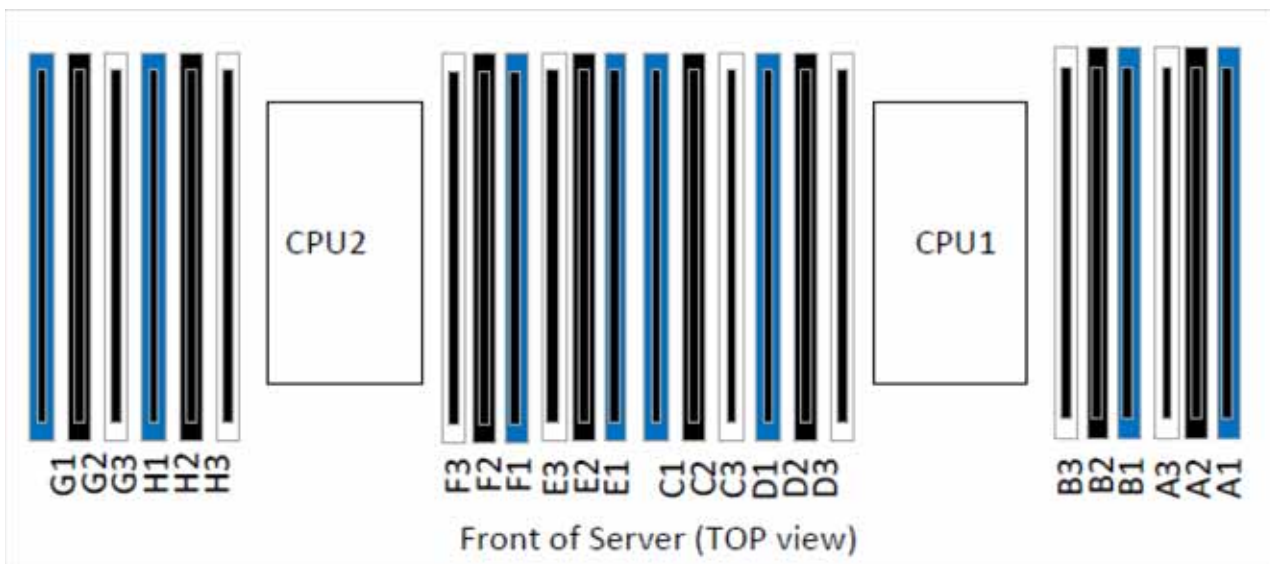

## Memory Population Rules

When considering the memory configuration of your HX240c Node, consider the following items:

- Each channel has three DIMM slots (for example, channel A = slots A1, A2, and A3).
  - A channel can operate with one, two, or three DIMMs installed.
  - If a channel has only one DIMM, populate slot 1 first (the blue slot).
- When both CPUs are installed, populate the DIMM slots of each CPU identically.
  - Fill blue slots in the channels first: A1, E1, B1, F1, C1, G1, D1, H1
  - Fill black slots in the channels second: A2, E2, B2, F2, C2, G2, D2, H2
  - Fill black slots in the channels third: A3, E3, B3, F3, C3, G3, D3, H3
- Any DIMM installed in a DIMM socket for which the CPU is absent is not recognized.
- Observe the DIMM mixing rules shown in [Table 29](#)

Table 29 DIMM Rules for HX240c Nodes

DIMM Parameter	DIMMs in the Same Channel	DIMM in the Same Slot <sup>1</sup>
<u>DIMM Capacity</u>		
RDIMM = 16, 32, or 64 GB	DIMMs in the same channel (for example, A1, A2, and A3) can have different capacities.	For best performance, DIMMs in the same slot (for example, A1, B1, C1, D1) should have the same capacity.
<u>DIMM Speed</u>		
2400-MHz 2133-MHz	DIMMs will run at the lowest speed of the DIMMs/CPUs installed	DIMMs will run at the lowest speed of the DIMMs/CPUs installed
<u>DIMM Type</u>		
RDIMMs	Do not mix DIMM types in a channel	Do not mix DIMM types in a slot
<b>1 DPC, 2 DPC, or 3 DPC</b>		
DIMMs per Channel (DPC)	See <a href="#">Table 7 on page 18</a> for valid RDIMM 1 DPC, 2 DPC, and 3 DPC memory configurations	

Notes . . .

1. Although different DIMM capacities can exist in the same slot, this will result in less than optimal performance. For optimal performance, all DIMMs in the same slot should be identical.

## DIMM Population Order

Populate the DIMMs for a CPU according to [Table 30](#).

**Table 30** DIMM Population Order per CPU

	Populate CPU 1 Slots	Populate CPU 2 Slots
8	A1, B1, C1, D1, A2, B2, C2, D2	E1, F1, G1, H1, E2, F2, G2, H2
12	A1, B1, C1, D1, A2, B2, C2, D2 A3, B3, C3, D3	E1, F1, G1, H1, E2, F2, G2, H2 E3, F3, G3, H3



## Serial Port Details

The pinout details of the rear RJ-45 serial port connector are shown in [Figure 10](#).

Figure 10 Serial Port (Female RJ-45 Connector) Pinout

### Serial Port (RJ-45 Female Connector)

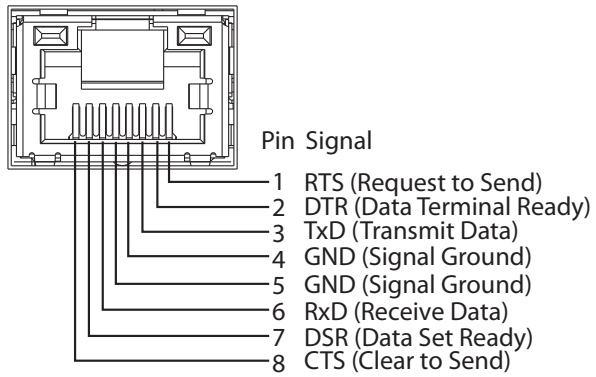

## Upgrade and Servicing-Related Parts

This section lists the upgrade and servicing-related parts you may need during the life of your HX240c Node. Some of these parts are configured with every system, and some may be ordered when needed or may be ordered and kept on hand as spares for future use. See [Table 31](#).

**Table 31 Upgrade and Servicing-related Parts for HX240c M4 Node**

Spare Product ID (PID)	Description
UCSC-PCIF-01F=	PCIe Full Height blanking panel <sup>1</sup>
UCSC-PCIF-C240M4=	PCIe Riser Blanking Panel <sup>1</sup>
UCSC-PCI-2-C240M4=	PCIe Riser 2 Assembly <sup>1</sup>
UCSC-PCI-1A-240M4=	PCIe Riser 1 Assembly
UCSC-PCI-1B-240M4=	PCIe Riser 1 Assembly (3 x8 slots) <sup>1</sup>
UCSC-PCI-1C-240M4=	M4 PCIe Riser 1 Assembly
UCSC-MLOM-BLK=	MLOM Blanking Panel
UCSC-HS-C240M3=	Heat Sink <sup>1</sup>
UCS-CPU-LPCVR=	CPU load plate dust cover (for unpopulated CPU sockets)
N20-MBLIBATT=	Replacement Lithium Battery for motherboard (CR2032) <sup>1</sup>
UCSC-FAN-C240M4=	Fan Module (one)
UCSC-BAFF-C240M4=	Air Baffle Replacement Kit
UCSC-PSU-BLKP240=	Power Supply Blanking Panel <sup>1</sup>
UCSC-RAILB-M4=	Tool-Less Ball Bearing Rail Kit
UCSC-CMAB-M4=	Reversible CMA for ball bearing rail kit
UCS-SD-64G-S=	64 GB SD Card
N20-BKVM=	KVM local IO cable for console port
UCS-CPU-GREASE3=	CPU thermal grease syringe - needed for heatsink seal <sup>2</sup>
UCSX-HSCK=	UCS Processor Heat Sink Cleaning Kit (when replacing a CPU) <sup>3</sup>
HX240C-BZL-M4SX	HX240C M4 Security Bezel
UCSC-GPUCBL-240M4	C240 M4 GPU Power Cable(1 cable per card)

### Notes . . .

1. This part is included/configured with your HX240c M4 Node (in some cases, as determined by the configuration of your node).
2. This part should be ordered with the purchase of each optional or spare Intel Xeon E5-2600 v3 or v4 CPU processor kit

## Adding an Additional CPU (with CPU heat sink) or Replacing CPUs

All Cisco UCS two CPU socket-capable systems can be upgraded from having one to having two CPUs configured or can also support replacement of the CPUs. You will need to order and install a heat sink when adding any additional CPU to a system. Instructions for installing the new CPU or replacing CPUs and heat sink can be found at the following link:

[http://www.cisco.com/c/en/us/td/docs/unified\\_computing/ucs/c/hw/C240M4/install/C240M4.html](http://www.cisco.com/c/en/us/td/docs/unified_computing/ucs/c/hw/C240M4/install/C240M4.html)



**NOTE:** Unlike previous generation systems, the HX240c M4 Node has tool-less CPU sockets, so no separate tools (such as “pick n place” tools) are required to add or replace CPUs.

---

See the section titled “Replacing CPUs and Heatsinks.”

## Motherboard Lithium Battery

You can order a replacement motherboard battery. Installation instructions are found at this link:

[http://www.cisco.com/c/en/us/td/docs/unified\\_computing/ucs/c/hw/C240M4/install/C240M4.html](http://www.cisco.com/c/en/us/td/docs/unified_computing/ucs/c/hw/C240M4/install/C240M4.html)

See the section titled “Replacing the Motherboard RTC Battery.”

## Thermal Grease (with syringe applicator) for CPU to Heatsink Seal

Thermal grease must be applied to the top of the CPU where it comes in contact with the heat sink (a grease syringe also ships with each CPU spare option kit). Instructions for applying thermal grease are found at:

[http://www.cisco.com/c/en/us/td/docs/unified\\_computing/ucs/c/hw/C240M4/install/C240M4.html](http://www.cisco.com/c/en/us/td/docs/unified_computing/ucs/c/hw/C240M4/install/C240M4.html)

See the section titled “Replacing CPUs and Heatsinks.”



**CAUTION:** Use only the thermal grease specified for this system (UCS-CPU-GREASE3=). This thermal grease comes in a white-tipped syringe and is to be used only in the HX220c M4 and HX240c M4 Nodes. Other systems use thermal grease in a blue-tipped syringe (UCS-CPU-GREASE=).

Thermal grease for other systems may have different thermal conductivity properties and may cause overheating if used in the HX220c M4 or HX240c M4 Nodes.

**DO NOT** use thermal grease available for purchase at any commercial electronics store. If these instructions are not followed, the CPU may overheat and be destroyed.

---



**NOTE:** When you purchase a spare CPU, the thermal grease with syringe applicator is included.

---

### Air Baffle Replacement Kit

Air baffles are designed to direct airflow through the system to maintain the temperature at a safe operating level. These baffles must always remain installed during operation. The Air Baffle Replacement Kit includes the air baffles needed for one HX240c M4 node.

### CPU Heat Sink Cleaning Kit

The cleaning kit is used to remove the existing thermal compound from the bottom of the heat sink during a CPU replacement process. Instructions for cleaning are found at the following link:

[http://www.cisco.com/c/en/us/td/docs/unified\\_computing/ucs/c/hw/C240M4/install/C240M4.html](http://www.cisco.com/c/en/us/td/docs/unified_computing/ucs/c/hw/C240M4/install/C240M4.html)

See the section titled “Replacing CPUs and Heatsinks.”



**NOTE:** When you purchase a spare CPU, the CPU cleaning kit is included.

---

## Riser Card Configuration and Options

The three riser card 1 options are shown in [Table 32](#). The number of PCIe card slots and connectors for SATA boot drives depends on which option is selected for riser 1. The riser card 2 slot assignments are fixed and are shown in [Table 33 on page 54](#).

Table 32 Riser Card 1 Slot Options

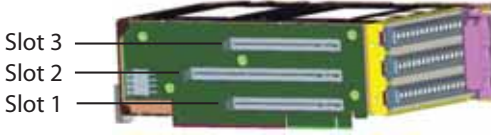
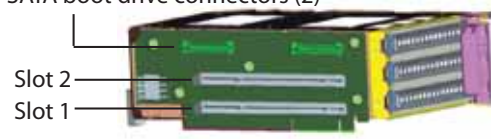
Slot #	Height	Length	Electrical	Mechanical	NCSI	Physical
<b>Riser Card 1 (option A, PID UCSC-PCI-1A-240M4)</b>						
						
3	No slot available					
2	Full	Full <sup>1</sup>	x16	x24	Yes <sup>2</sup>	
1	Full	3/4	x8	x24	Yes <sup>2</sup>	
<b>Riser Card 1 (option B, PID UCSC-PCI-1B-240M4)<sup>3</sup></b>						
						
3	Full	Full	x8	x16	No	
2	Full	Full	x8	x24	Yes	
1	Full	3/4	x8	x16	No	
<b>Riser Card 1 (option C, PID UCSC-PCI-1C-240M4)</b>						
						
3	No slot available <sup>4</sup>					
2	Full	Full	x16	x24	Yes <sup>2</sup>	
1	Full	3/4	x8	x24	Yes	

Notes . . .

1. GPU capable slot
2. NCSI supported in only one slot at a time (default slot 2). If a GPU card is present in slot 2, NCSI support automatically moves to slot 1.
3. No GPUs are supported on this riser. There is no GPU power connector in this version. Use riser version 1A for GPU cards.
4. There is no PCIe connector in slot 3; instead, there are two connectors available for connecting SATA boot drives.

Table 33 Riser Card 2 Slots

Slot #	Height	Length	Electrical	Mechanical	NCSI	Physical
Riser Card 2						
						
6	Full	Full	x8	x16	No	
5	Full	Full <sup>1</sup>	x16	x24	Yes <sup>2</sup>	
4	Full	3/4	x8	x24	Yes <sup>2</sup>	

Notes . . .

1. GPU capable slot
2. NCSI supported in only one slot at a time (default slot 5). If a GPU card is present in slot 5, NCSI support automatically moves to slot 4.

## RACKS

The Cisco R42610 rack (see [Figure 11 on page 56](#)) is certified for Cisco UCS installation at customer sites and is suitable for the following equipment:

- Cisco UCS B-Series servers and fabric interconnects
- Cisco UCS C-Series and select Nexus switches

The rack is compatible with hardware designed for EIA-standard 19-inch racks. Rack specifications are listed in [Table 34](#).

**Table 34 Cisco R42610 Rack Specifications**

Parameter	Standard Rack	Expansion Rack
Dimensions (H x W x D)	78.74 x 24 x 43.38 in. (2000 x 610 x 1102 mm)	78.74 x 23.58 x 43.38 in. (2000 x 599 x 1102 mm)
Dimensions (H x W x D) with packaging	89 x 33 x 47 in. (2261 x 838 x 1194 mm)	89 x 33 x 47 in. (2261 x 838 x 1194 mm)
Distance from front mounting rail to rear mounting rail	29.2 in (741 mm)	29.2 in (741 mm)
Weight	299.83 lb (136 kg)	231.49 lb (105 kg)
Weight with packaging	354 lb (161 kg)	284 lb (129 kg)
Side panels included	Yes	No
Equipment mounting capacity	42RU	42RU
Static load capacity	2100 lb (954 kg)	2100 lb (954 kg)
Dynamic load capacity	Not applicable	Not applicable



**NOTE:** The AC input connector is an IEC 320 C-14 15 A/250 VAC power inlet.

Figure 11 Cisco R42610 Rack



Front view - door closed



Front view - door open



Front view - door removed



## PDU

Cisco RP Series Power Distribution Units (PDUs) offer power distribution with branch circuit protection.

Cisco RP Series PDU models distribute power to up to 24 outlets. The architecture organizes power distribution, simplifies cable management, and enables you to move, add, and change rack equipment without an electrician.

With a Cisco RP Series PDU in the rack, you can replace up to two dozen input power cords with just one. The fixed input cord connects to the power source from overhead or under-floor distribution. Your IT equipment is then powered by PDU outlets in the rack using short, easy-to-manage power cords.

The C-series severs accept the zero-rack-unit (ORU) PDU. See [Figure 12](#).

Figure 12 Zero Rack Unit PDU (PID = RP208-30-2P-U-2)

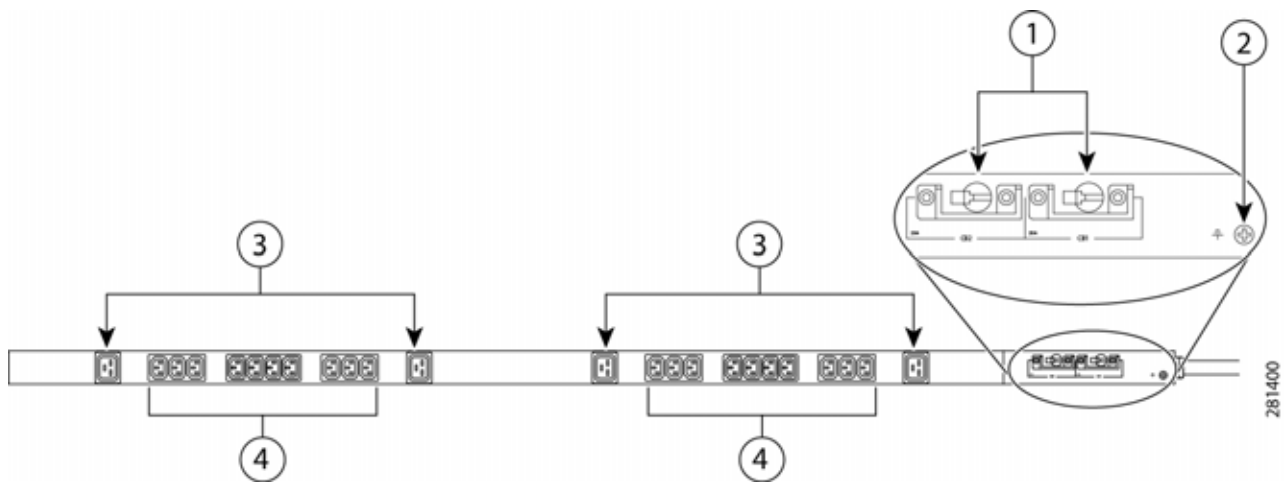

1	Breakers	3	C19 plugs
2	Ground connection	4	C13 plugs

Cisco RP Series PDU models provide two 20-ampere (A) circuit breakers for groups of receptacles. The effects of a tripped circuit are limited to a receptacle group. Simply press a button to reset that circuit.

## KVM CABLE

The KVM cable provides a connection into the system, providing a DB9 serial connector, a VGA connector for a monitor, and dual USB 2.0 ports for a keyboard and mouse. With this cable, you can create a direct connection to the operating system and the BIOS running on the system.

The KVM cable ordering information is listed in [Table 35](#).

Table 35 KVM Cable

Product ID (PID)	PID Description
N20-BKVM=	KVM cable for console port

Figure 13 KVM Cable

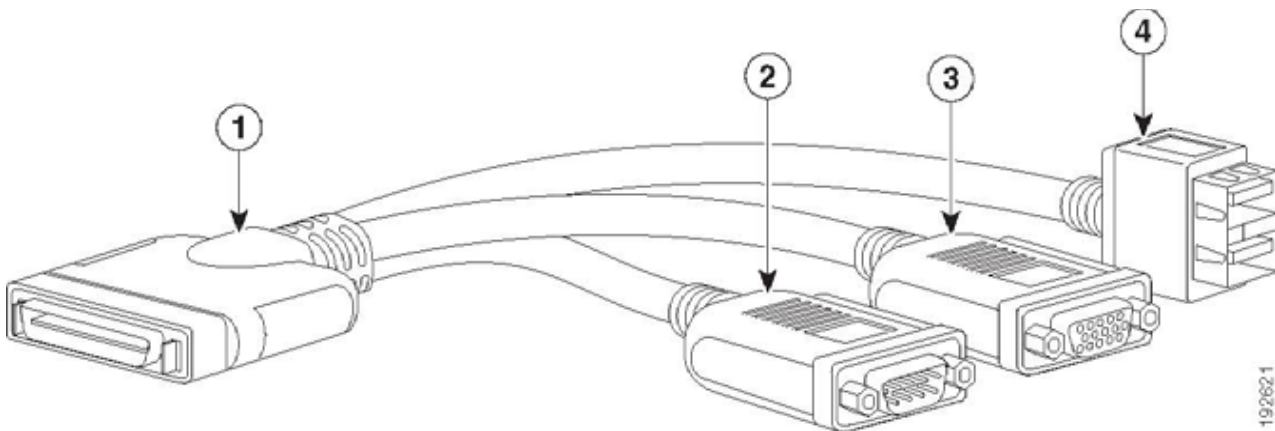

1	Connector (to front panel)	3	VGA connector (for a monitor)
2	DB-9 serial connector	4	Two-port USB 2.0 connector (for a mouse and keyboard)

# TECHNICAL SPECIFICATIONS

## Dimensions and Weight

Table 36 HX240c M4 Node Dimensions and Weight

Parameter	Value
Height	3.43 in. (8.70 cm)
Width (including slam latches)	17.65 in. (44.8 cm) Including handles: 18.96 in (48.2 cm)
Depth	29.0 in. (73.8 cm) Including handles: 30.18 in (76.6 cm)
Front Clearance	3 in. (76 mm)
Side Clearance	1 in. (25 mm)
Rear Clearance	6 in. (152 mm)
Weight <sup>1</sup>	
Maximum (24 drives, two CPUs, 24 DIMMs, two 1400 W power supplies)	62.7 lbs (28.4 kg)

Notes . . .

1. Weight includes inner rail, which is attached to the system. Weight does not include outer rail, which is attached to the rack.

## Power Specifications

The system is available with the following types of power supplies:

- 650 W (AC)
- 930 W (DC)
- 1200 W (AC)
- 1400 W (AC)

The general power specifications for the HX240c M4 Node are listed as follows:

- 650 W (AC) power supply (see [Table 37](#)).
- 930 W (DC) power supply (see [Table 38 on page 61](#)).
- 1200 W V2 (AC) power supply (see [Table 39 on page 61](#))
- 1400 W V2 (AC) power supply (see [Table 40 on page 62](#))

**Table 37 HX240c M4 Node Power Specifications (650 W AC power supply)**

Description	Specification
AC input voltage range	Voltage Range 100-127 VAC, 200-240 VAC nominal (range: 90-140 VAC, 180-264 VAC)
AC input frequency	50 to 60 Hz nominal (range: 47 to 63 Hz)
Maximum AC input current	7.6 Amps maximum at 100 VAC 3.65 Amps maximum at 208 VAC
Maximum Input VA	760 VA at 100 VAC
Maximum output power for each power supply	650 W
Maximum AC inrush current	35 A (sub cycle duration)
Maximum hold up time	12 ms @ 650 W
Power supply output voltage	12 VDC
Power supply standby voltage	12 VDC
Power supply efficiency	Climate Savers Platinum Efficiency (80Plus Platinum Certified)
Form factor	RSP1
Input connector	IEC320 C14

Table 38 HX240c M4 Node Power Specifications (930 W DC power supply)

Description	Specification
AC input voltage	Voltage Range: -48 to -60 VDC nominal (range: -40 to -60 VDC)
Max DC Input current	23A at -48 VDC
Maximum Input Power	1104 W at -48VDC
Maximum output power per power supply	930W
Maximum inrush current	35 A (sub cycle duration)
Maximum hold up time	4ms @ 930 W
Power supply output voltage	12 VDC
Power supply standby voltage	12 VDC
Efficiency rating	> 92% at 50% Load
Form Factor	RSP1
Input connector	3-post euro terminal block spring cage connection connector. Plug PID UCSC-CONN-930WDC=

Table 39 HX240c M4 Node Power Specifications (1200 W V2 AC power supply)

Description	Specification
AC input voltage	Voltage Range 100-127 VAC, 200-240 VAC nominal (range: 90-140 VAC, 180-264 VAC)
AC input frequency	50 to 60 Hz nominal (range: 47 to 63 Hz)
Max AC Input current	11 A at 100 VAC 7 A at 200 VAC
Maximum Input VA	1400 V\A @230VAC
Maximum output power per power supply	800 W at 100 - 120 VAC 1200 W at 200 - 240 VAC 36 W on 12V DC Standby
Maximum inrush current	30 A (sub cycle duration)

Table 39 HX240c M4 Node Power Specifications (1200 W V2 AC power supply)

Description	Specification
Maximum hold up time	12 ms @ 1200 W
Power supply output voltage	12 VDC
Power supply standby voltage	12 VDC
Efficiency rating	Climate Savers Platinum Efficiency (80Plus Platinum Certified)
Form Factor	RSP1 (C-Series 2U and 4U systems)
Input connector	IEC320 C14

Table 40 HX240c M4 Node Power Specifications (1400 W V2 AC power supply)

Description	Specification
AC input voltage	Voltage Range 200-240 VAC nominal (range:180-264 VAC)
AC input frequency	50 to 60 Hz nominal (range: 47 to 63 Hz)
Max AC Input current	8.5 A at 200 VAC
Maximum Input VA	1630 VA @230 VAC
Maximum output power per power supply	1400 W at 200-240 VAC 36 W on 12V DC Standby
Maximum inrush current	30 A (sub cycle duration)
Maximum hold up time	12 ms @ 1400 W
Power supply output voltage	12 VDC
Power supply standby voltage	12 VDC
Efficiency rating	Climate Savers Platinum Efficiency (80Plus Platinum Certified)
Form Factor	RSP1 (C-Series 2U and 4U systems)
Input connector	IEC320 C14

For configuration-specific power specifications, use the Cisco UCS Power Calculator at this URL:

<http://ucspowercalc.cisco.com>

## Environmental Specifications

The power specifications for the HX240c M4 Node are listed in [Table 41](#).

Table 41 HX240c M4 Node Environmental Specifications

Parameter	Minimum
Temperature operating	41 to 95° F (5 to 35° C) derate the maximum temperature by 1° C per every 1000 ft. (305 m) of altitude above sea level
Temperature nonoperating	-40 to 149° F (-40 to 65° C)
Humidity (RH) operating	10 to 90%, non-condensing at 82° F (28° C)
Humidity (RH) nonoperating	5 to 93% at 82° F (28° C)
Altitude operating	0 to 3,000 m (0 to 10,000 ft.)
Altitude nonoperating	0 to 12,192 m (0 to 40,000 ft.)
Sound Power level, Measure A-weighted per ISO7779 LWAd (Bels) Operation at 73° F (23° C)	5.8
Sound Pressure level, Measure A-weighted per ISO7779 LpAm (dBA) Operation at 73° F (23° C)	43

## Compliance Requirements

The regulatory compliance requirements for C-Series systems are listed in [Table 42](#).

Table 42 UCS C-Series Regulatory Compliance Requirements

Parameter	Description
Regulatory Compliance	Products should comply with CE Markings per directives 2004/108/EC and 2006/95/EC
Safety	UL 60950-1 Second Edition CAN/CSA-C22.2 No. 60950-1 Second Edition EN 60950-1 Second Edition IEC 60950-1 Second Edition AS/NZS 60950-1 GB4943 2001
EMC - Emissions	47CFR Part 15 (CFR 47) Class A AS/NZS CISPR22 Class A CISPR22 Class A EN55022 Class A ICES003 Class A VCCI Class A EN61000-3-2 EN61000-3-3 KN22 Class A CNS13438 Class A
EMC - Immunity	EN55024 CISPR24 EN300386 KN24



## Discontinued EOL Products

Below is the list of parts were previously available for this product and are no longer sold. Please refer to the EOL Bulletin Links via the [Table 43](#) below to determine if still supported.

Table 43 EOL Products

EOS option PID	Description	EOL bulletin link
<b>MEMORY</b>		
UCS-ML-1X644RV-A	64GB DDR4-2400-MHz LRDIMM/PC4-19200/quad rank/x4/1.2v	<a href="https://www.cisco.com/c/en/us/products/collateral/servers-unified-computing/ucs-c-series-rack-servers/eos-eol-notice-c51-741234.html">https://www.cisco.com/c/en/us/products/collateral/servers-unified-computing/ucs-c-series-rack-servers/eos-eol-notice-c51-741234.html</a>
UCS-MR-1X081RU-A	8GB DDR4-2133-MHz RDIMM/PC4-17000/single rank/x4/1.2v	<a href="http://www.cisco.com/c/en/us/products/collateral/servers-unified-computing/ucs-b-series-blade-servers/eos-eol-notice-c51-739140.html">http://www.cisco.com/c/en/us/products/collateral/servers-unified-computing/ucs-b-series-blade-servers/eos-eol-notice-c51-739140.html</a>
UCS-MR-1X081RU-A	8GB DDR4-2133-MHz RDIMM/PC4-17000/single rank/x4/1.2v	<a href="http://www.cisco.com/c/en/us/products/collateral/servers-unified-computing/ucs-b-series-blade-servers/eos-eol-notice-c51-739140.html">http://www.cisco.com/c/en/us/products/collateral/servers-unified-computing/ucs-b-series-blade-servers/eos-eol-notice-c51-739140.html</a>
UCS-MR-1X161RV-A	16GB DDR4-2400-MHz RDIMM/PC4-19200/single rank/x4/1.2v	<a href="https://www.cisco.com/c/en/us/products/collateral/servers-unified-computing/ucs-c-series-rack-servers/eos-eol-notice-c51-741234.html">https://www.cisco.com/c/en/us/products/collateral/servers-unified-computing/ucs-c-series-rack-servers/eos-eol-notice-c51-741234.html</a>
UCS-MR-1X162RU-A	16GB DDR4-2133-MHz RDIMM/PC4-17000/dual rank/x4/1.2v	<a href="http://www.cisco.com/c/en/us/products/collateral/servers-unified-computing/ucs-b-series-blade-servers/eos-eol-notice-c51-739140.html">http://www.cisco.com/c/en/us/products/collateral/servers-unified-computing/ucs-b-series-blade-servers/eos-eol-notice-c51-739140.html</a>
UCS-MR-1X162RU-A	16GB DDR4-2133-MHz RDIMM/PC4-17000/dual rank/x4/1.2v	<a href="http://www.cisco.com/c/en/us/products/collateral/servers-unified-computing/ucs-b-series-blade-servers/eos-eol-notice-c51-739140.html">http://www.cisco.com/c/en/us/products/collateral/servers-unified-computing/ucs-b-series-blade-servers/eos-eol-notice-c51-739140.html</a>
UCS-MR-1X322RU-A	32GB DDR4-2133-MHz RDIMM/PC4-17000/dual rank/x4/1.2v	<a href="http://www.cisco.com/c/en/us/products/collateral/servers-unified-computing/ucs-b-series-blade-servers/eos-eol-notice-c51-739140.html">http://www.cisco.com/c/en/us/products/collateral/servers-unified-computing/ucs-b-series-blade-servers/eos-eol-notice-c51-739140.html</a>
UCS-MR-1X648RU-A	64GB DDR4-2133-MHz TSV-RDIMM/PC4-17000/octal rank/x4/1.2v	<a href="https://www.cisco.com/c/en/us/products/collateral/servers-unified-computing/ucs-c-series-rack-servers/eos-eol-notice-c51-741234.html">https://www.cisco.com/c/en/us/products/collateral/servers-unified-computing/ucs-c-series-rack-servers/eos-eol-notice-c51-741234.html</a>
<b>DRIVES</b>		
<b>HDD</b>		
A03-D300GA2	^300GB 6Gb SAS 10K RPM SFF HDD/hot plug/drive sled mounted	<a href="http://www.cisco.com/c/en/us/products/collateral/servers-unified-computing/ucs-c-series-rack-servers/eos-eol-notice-c51-737249.html">http://www.cisco.com/c/en/us/products/collateral/servers-unified-computing/ucs-c-series-rack-servers/eos-eol-notice-c51-737249.html</a>
A03-D600GA2	^600GB 6Gb SAS 10K RPM SFF HDD/hot plug/drive sled mounted	<a href="http://www.cisco.com/c/en/us/products/collateral/servers-unified-computing/ucs-c-series-rack-servers/eos-eol-notice-c51-737249.html">http://www.cisco.com/c/en/us/products/collateral/servers-unified-computing/ucs-c-series-rack-servers/eos-eol-notice-c51-737249.html</a>
UCS-HD12T10KS2-E	1.2 TB 6G SAS 10K rpm SFF HDD	<a href="https://www.cisco.com/c/en/us/products/collateral/servers-unified-computing/ucs-c-series-rack-servers/eos-eol-notice-c51-735827.html">https://www.cisco.com/c/en/us/products/collateral/servers-unified-computing/ucs-c-series-rack-servers/eos-eol-notice-c51-735827.html</a>
A03-D1TBSATA	^1TB 6Gb SATA 7.2K RPM SFF HDD/hot plug/drive sled mounted	<a href="http://www.cisco.com/c/en/us/products/collateral/servers-unified-computing/ucs-c-series-rack-servers/eos-eol-notice-c51-737249.html">http://www.cisco.com/c/en/us/products/collateral/servers-unified-computing/ucs-c-series-rack-servers/eos-eol-notice-c51-737249.html</a>

Table 43 EOL Products

EOS option PID	Description	EOL bulletin link
UCS-HD1T7K12G	1 TB 12G SAS 7.2K RPM SFF HDD	<a href="https://www.cisco.com/c/en/us/products/collateral/servers-unified-computing/ucs-c-series-rack-servers/eos-eol-notice-c51-741234.html">https://www.cisco.com/c/en/us/products/collateral/servers-unified-computing/ucs-c-series-rack-servers/eos-eol-notice-c51-741234.html</a>
UCS-HD1T7K6GA	1 TB 6G SATA 7.2K RPM SFF HDD	<a href="https://www.cisco.com/c/en/us/products/collateral/servers-unified-computing/ucs-c-series-rack-servers/eos-eol-notice-c51-741234.html">https://www.cisco.com/c/en/us/products/collateral/servers-unified-computing/ucs-c-series-rack-servers/eos-eol-notice-c51-741234.html</a>
UCS-HD1T7KS2-E	^1TB SAS 7.2K RPM 2.5 inch HDD/hot plug/drive sled mounted	<a href="http://www.cisco.com/c/en/us/products/collateral/servers-unified-computing/ucs-c-series-rack-servers/eos-eol-notice-c51-737249.html">http://www.cisco.com/c/en/us/products/collateral/servers-unified-computing/ucs-c-series-rack-servers/eos-eol-notice-c51-737249.html</a>
UCS-HD2T7K12G	2 TB 12G SAS 7.2K RPM SFF HDD	<a href="https://www.cisco.com/c/en/us/products/collateral/servers-unified-computing/ucs-c-series-rack-servers/eos-eol-notice-c51-741234.html">https://www.cisco.com/c/en/us/products/collateral/servers-unified-computing/ucs-c-series-rack-servers/eos-eol-notice-c51-741234.html</a>
UCS-HD300G10K9	300GB 12G SAS 10K RPM SFF HDD (SED)	<a href="https://www.cisco.com/c/en/us/products/collateral/servers-unified-computing/ucs-c-series-rack-servers/eos-eol-notice-c51-740779.html">https://www.cisco.com/c/en/us/products/collateral/servers-unified-computing/ucs-c-series-rack-servers/eos-eol-notice-c51-740779.html</a>
UCS-HD450G15K12G	450GB 12G SAS 15K RPM SFF HDD	<a href="https://www.cisco.com/c/en/us/products/collateral/servers-unified-computing/ucs-c-series-rack-servers/eos-eol-notice-c51-740779.html">https://www.cisco.com/c/en/us/products/collateral/servers-unified-computing/ucs-c-series-rack-servers/eos-eol-notice-c51-740779.html</a>
UCS-HD450G15KS2-E	450GB SAS 15K RPM SFF HDD	<a href="http://www.cisco.com/c/en/us/products/collateral/servers-unified-computing/ucs-c-series-rack-servers/eos-eol-notice-c51-736502.html">http://www.cisco.com/c/en/us/products/collateral/servers-unified-computing/ucs-c-series-rack-servers/eos-eol-notice-c51-736502.html</a>
UCS-HD600G10KS4K	600GB 12G SAS 10K RPM SFF HDD (4K)	<a href="https://www.cisco.com/c/en/us/products/collateral/servers-unified-computing/ucs-c-series-rack-servers/eos-eol-notice-c51-740779.html">https://www.cisco.com/c/en/us/products/collateral/servers-unified-computing/ucs-c-series-rack-servers/eos-eol-notice-c51-740779.html</a>
UCS-HD600G15KS2-E	600GB SAS 15K RPM SFF HDD	<a href="http://www.cisco.com/c/en/us/products/collateral/servers-unified-computing/ucs-c-series-rack-servers/eos-eol-notice-c51-736502.html">http://www.cisco.com/c/en/us/products/collateral/servers-unified-computing/ucs-c-series-rack-servers/eos-eol-notice-c51-736502.html</a>
UCS-HD900G10K12G	900GB 12G SAS 10K RPM SFF HDD	<a href="https://www.cisco.com/c/en/us/products/collateral/servers-unified-computing/ucs-c-series-rack-servers/eos-eol-notice-c51-740779.html">https://www.cisco.com/c/en/us/products/collateral/servers-unified-computing/ucs-c-series-rack-servers/eos-eol-notice-c51-740779.html</a>
UCS-HDD300G12F105	300GB 6Gb SAS 15K RPM SFF HDD/hot plug/drive sled mounted	<a href="http://www.cisco.com/c/en/us/products/collateral/servers-unified-computing/ucs-c-series-rack-servers/eos-eol-notice-c51-736502.html">http://www.cisco.com/c/en/us/products/collateral/servers-unified-computing/ucs-c-series-rack-servers/eos-eol-notice-c51-736502.html</a>
UCS-HDD900G12F106	^900GB 6Gb SAS 10K RPM SFF HDD/hot plug/drive sled mounted	<a href="http://www.cisco.com/c/en/us/products/collateral/servers-unified-computing/ucs-c-series-rack-servers/eos-eol-notice-c51-737249.html">http://www.cisco.com/c/en/us/products/collateral/servers-unified-computing/ucs-c-series-rack-servers/eos-eol-notice-c51-737249.html</a>
<b>Enterprise Performance</b>		
UCS-SD16TB12S3-EP	1.6TB 2.5 inch Ent. Performance 6GSATA SSD(3X endurance)	<a href="https://www.cisco.com/c/en/us/products/collateral/servers-unified-computing/ucs-c-series-rack-servers/eos-eol-notice-c51-739513.html">https://www.cisco.com/c/en/us/products/collateral/servers-unified-computing/ucs-c-series-rack-servers/eos-eol-notice-c51-739513.html</a>
UCS-SD16TBK9	1.6TB Enterprise performance SAS SSD (10XFWPD, SED)	<a href="https://www.cisco.com/c/en/us/products/collateral/servers-unified-computing/ucs-c-series-rack-servers/eos-eol-notice-c51-740779.html">https://www.cisco.com/c/en/us/products/collateral/servers-unified-computing/ucs-c-series-rack-servers/eos-eol-notice-c51-740779.html</a>
<b>Enterprise Value</b>		
UCS-SD120GBE1K9	120GB Enterprise Value SATA SSD (1X DWPD)	<a href="https://www.cisco.com/c/en/us/products/collateral/servers-unified-computing/ucs-c-series-rack-servers/eos-eol-notice-c51-741234.html">https://www.cisco.com/c/en/us/products/collateral/servers-unified-computing/ucs-c-series-rack-servers/eos-eol-notice-c51-741234.html</a>

Table 43 EOL Products

EOS option PID	Description	EOL bulletin link
UCS-SD120GBKS4-EV	120 GB 2.5 inch Enterprise Value 6G SATA SSD	<a href="https://www.cisco.com/c/en/us/products/collateral/servers-unified-computing/ucs-c-series-rack-servers/eos-eol-notice-c51-740779.html">https://www.cisco.com/c/en/us/products/collateral/servers-unified-computing/ucs-c-series-rack-servers/eos-eol-notice-c51-740779.html</a>
UCS-SD240GBKS4-EV	240GB 2.5 inch Enterprise Value 6G SATA SSD	<a href="https://www.cisco.com/c/en/us/products/collateral/servers-unified-computing/ucs-b-series-blade-servers/eos-eol-notice-c51-742066.html">https://www.cisco.com/c/en/us/products/collateral/servers-unified-computing/ucs-b-series-blade-servers/eos-eol-notice-c51-742066.html</a>
<b>GPU</b>		
UCSC-GPU-VGXX2	^NVIDIA GRID K12	<a href="https://www.cisco.com/c/en/us/products/collateral/servers-unified-computing/ucs-c-series-rack-servers/eos-eol-notice-c51-737351.html">https://www.cisco.com/c/en/us/products/collateral/servers-unified-computing/ucs-c-series-rack-servers/eos-eol-notice-c51-737351.html</a>
UCSC-GPU-VGXX1	^NVIDIA GRID K1	



**Americas Headquarters**  
Cisco Systems, Inc.  
San Jose, CA

**Asia Pacific Headquarters**  
Cisco Systems (USA) Pte. Ltd.  
Singapore

**Europe Headquarters**  
Cisco Systems International BV Amsterdam,  
The Netherlands

Cisco has more than 200 offices worldwide. Addresses, phone numbers, and fax numbers are listed on the Cisco Website at [www.cisco.com/go/offices](http://www.cisco.com/go/offices).

Cisco and the Cisco Logo are trademarks of Cisco Systems, Inc. and/or its affiliates in the U.S. and other countries. A listing of Cisco's trademarks can be found at [www.cisco.com/go/trademarks](http://www.cisco.com/go/trademarks). Third party trademarks mentioned are the property of their respective owners. The use of the word partner does not imply a partnership relationship between Cisco and any other company. (1005R)

